



Technical evaluation of push-pull

September 21 - November 6, 2006

Draft

to be presented by A.Seryi at Valencia workshop
on November 8, 2006
on behalf of the extended task force



Push-pull evaluation

- Initiated by GDE & WWS at the end of September
- Detailed list of questions to be studied developed:

<http://www-project.slac.stanford.edu/ilc/acceldev/beamdelivery/rdr/docs/push-pull/>

- Large group of accelerator and detector colleagues, from ILC and other projects, is participating in design and discussion of these question
- The task force of detector experts was formed to contribute to detailed evaluation of the whole set of technical issues
- Tentative conclusions are shown below
- This document is in flux



This summary is a product of brainstorming of many colleagues...

Detector task-force: T.Tauchi (KEK), H.Yamaoka (KEK), R.Settles (Max-Plank Inst.), P.LeDu (Saclay), N.Meyners (DESY), K.Buesser (DESY), H.Videau (IN2P3), M.Demarteau (FNAL), G.Haller (SLAC), M.Breidenbach (SLAC), P.Burrows (Oxford), J.Hauptmann (Iowa State Univ.), A.Mikhailichenko (Cornell)

WWS & BDS Area: F.Richard (LAL), J.Brau (Oregon Univ.), H.Yamamoto (Tohoku Univ.), D.Angal-Kalinin (Daresbury), Andrei Seryi (SLAC)

Accelerator and detector colleagues: Y.Suetsugu, Y.Sugimoto, S.Ban, T.Sanami (KEK), B.Parker, A.Marone, M.Anerella, M.Harrison, P.Wanderer, W.Morse, A.Jain, J.Escallier, P.Kovach (BNL), J.Amann, F.Asiri, M.Woodley, Y.Nosochkov, A.Fasso, L. Keller, S.Rokni, K.Bane, T.Himel, J.Kim, T.Markiewicz, S.Smith (SLAC), J.-L.Baldy, M.Gastal (CERN), W.Lohmann (DESY), T.Peterson, E.Huedem, B.Wands (FNAL), A.Weerts (ANL)

Colleagues not directly involved in BDS of ILC: G.Bowden, B.Richter, M.Zurawel, M.Munro, L.Eriksson, R.Kirby, (SLAC), V.Bezzubov (FNAL), A.Herve, P.Jenni, P.Collier, M.Nessi, A.Gaddi, G.Faber, A.Cattai, D.Forkel-Wirth, F.Hahn, J-P.Quesnel, (CERN)

and those not mentioned...



Process

- Detector task force phone meetings
 - **Oct 24:** <http://ilcagenda.cern.ch/conferenceDisplay.py?confId=1214>
 - **Nov 2 :** <http://ilcagenda.cern.ch/conferenceDisplay.py?confId=1226>
- Accelerator design meetings
 - **Several, see:** <http://ilcagenda.cern.ch/categoryDisplay.py?categId=9>
- Emails
- Phone connections
- Personal meetings
- Etc.



Push-pull study.

September 21, 2006/October 23, 2006

Questions to be studied for evaluation of push-pull configuration of two detectors in single BDS. DRAFT.

Goal: technical evaluation of feasibility of push-pull configurations of two detectors in single BDS.

Process: evaluate each of the question individually, one-by-one, by the detector, accelerator and engineering experts in a transparent way allowing community to track the progress and be actively engaged.

Timescale: to present the preliminary conclusions, for each question, at Valencia meeting, where an overall conclusion could be discussed.

Reporting and deliverables: the taskforce is reporting to GDE & WWS and as a deliverable the task leader should submit a written report to GDE & WWS at Valencia.

Assumptions in the present baseline: the ILC baseline with two BDS and two detectors is designed to allow switch between detectors on the timescale of weeks-months. The estimated switch-over time, for realignment of BDS beamlines and their retuning, is 3-4 days. (The pulse-to-pulse switch-over, which is sometime mentioned, is not supported by hardware of present ILC baseline). . . .

<http://www-project.slac.stanford.edu/ilc/acceldev/beamdelivery/rdr/docs/push-pull/>



Categories of questions to be evaluated

- Organizational and historical questions
- Accelerator design questions
- Detector design questions
- Engineering integration questions

Tentative list of questions is below

Organizational questions

1. What is acceptable duration for switch over time?
2. What is desired frequency between switches?
3. What technical arrangements were made push-pull operation possible in UA2/UA5 experiments at CERN, and what are technical lessons?

Accelerator design questions

1. Is there, in the beamline, a natural breaking point?
 - a. Things to watch are the design and length of FD, location of crab-cavity, etc.
2. Do we need to redesign the beamline to optimize location of breaking point?
3. Is part of beamline (part of FD) remains in detector when it moves?
4. What vacuum connections are needed in breaking point?
5. Do we have to use the same L^* for either detector or it can be different?

Detector design questions

1. If detector carries part of FD, how it is supported?
2. What are the alignment requirements for detector central part and how the alignment monitored during the move and restored after the move?
3. What is the suitable way to move (rails, air-pads) the detector?
4. For quick change-over, do we need to make detector self shielding?
5. What are the design changes needed to make the detector self shielded?
6. Which systems of detector (cryo, etc.) may stay active during the move and which need to be deactivated?
7. Is there a need to open detector when it is on the beamline, or it would be only opened in the off-beamline position?

Engineering integration questions

1. What arrangements or reinforcements (such as imbedded steel) are needed for the floor of the collider hall?
2. What are possible deformations of the floor during detector move?
3. During the move, is there a need for active system to monitor deformation of the floor and adjust the height of supports to preserve position and internal alignment of the detector?
4. What is the suitable alignment network, to perform the task in the previous item?
5. If there is a need in shielding wall between detectors, what is the method of its removal and assembly?



Some of questions (1)

- *Is there, in the beamline, a natural breaking point?*
- *Do we need to redesign the beamline to optimize location of breaking point?*
- *Is part of beamline (part of FD) remains in detector when it moves?*
- *What vacuum connections are needed in breaking point?*
- *Do we have to use the same L^* for either detector or it can be different?*
- *How the connections of electrical, cryo, water, gas, etc, systems are arranged?*



Some of questions (1)

- *Is there, in the beamline, a natural breaking point?*
 - **yes, it can be arranged, between QD0 and QF1**
- *Do we need to redesign the beamline to optimize location of breaking point?*
 - **yes and a first version of optics already produced**
- *Is part of beamline (part of FD) remains in detector when it moves?*
 - **yes, this seems to be the most optimal way**
- *What vacuum connections are needed in breaking point?*
 - **two vacuum valves with RF-shield, details are being worked out**
- *Do we have to use the same L^* for either detector or it can be different?*
 - **Different L^* is possible, but same L^* gives benefits and may save time**
- *How the connections of electrical, cryo, water, gas, etc, systems are arranged?*
 - **Part of electronics and services can be placed on a platform which moves with detector. Flexible connections to stationary systems needed.**



Some of questions (2)

- *What is the suitable way to move (rails, air-pads) the detector?*
- *For quick change-over, do we need to make detector self shielding?*
- *What are the design changes needed to make the detector self shielded?*
- *If there is a need in shielding wall between detectors, what is the method of its removal and assembly?*
- *What arrangements or reinforcements (such as imbedded steel) are needed for the floor of the collider hall?*
- *Is there a need to open detector when it is on the beamline, or it would be only opened in the off-beamline position?*

<http://www-project.slac.stanford.edu/ilc/acceldev/beamdelivery/rdr/docs/push-pull/>



Some of questions (2)

- *What is the suitable way to move (rails, air-pads) the detector?*
 - **air-pads seems as a possibility**
- *For quick change-over, do we need to make detector self shielding?*
 - **It would help, but self-shielding is not absolutely required for quick change-over**
- *What are the design changes needed to make the detector self shielded?*
 - **For GLD/SiD/LDC, self-shielding has been shown in simulations. For the fourth detector concept (double solenoid with no iron), implementing self-shielding may be difficult**
- *If there is a need in shielding wall between detectors, what is the method of its removal and assembly?*
 - **The shielding wall, if needed, can consist of two parts and move on air-pads in hours**
- *What arrangements or reinforcements (such as imbedded steel) are needed for the floor of the collider hall?*
 - **Steel plates (~5cm thick, welded) to cover the collider hall floor**
- *Is there a need to open detector when it is on the beamline, or it would be only opened in the off-beamline position?*
 - **Opening one beamline desirable, certain design optimization needed**

<http://www-project.slac.stanford.edu/ilc/acceldev/beamdelivery/rdr/docs/push-pull/>



Illustrations and references

- Many of these questions have tentative answers
- They are illustrated below
- Note that a lot of what is shown is preliminary and is quite in flux
- A lot more of studies and detailed engineering will be needed to come with final optimized design



Break point in the FD

- One version is to carry the whole FD with detector, but the FD is long (end at $\sim 11\text{m}$ for $L^*=3.5\text{m}$) and it may be too much to carry
- Concentrating on the version when FD is rearranged so that a magnet free section is arranged between QD0-SD0 part and QF1-SF1 parts
- This redesign involved moving the extraction quads which were overlapping which this drift
- Location of this drift roughly correspond to the width of considered detectors and could be somewhat adjusted in further detailed study



Original Common Cryostat Layout

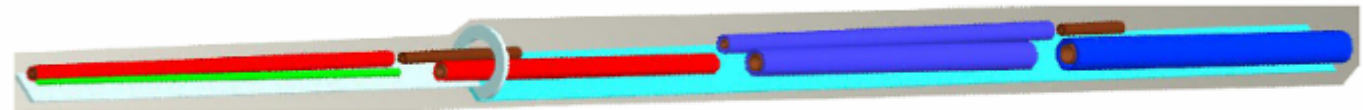

Eliminate Three Sections

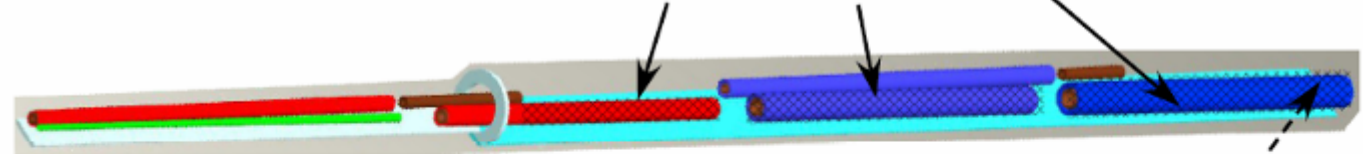

Still have to get magnet leads, He-II etc. across this gap!

A Short Unshielded Coil Moves Next To QF1

Extend Coil (smaller ID)



Break Cryostat Here To Create Warm Drift

Page 1/3

- B.Parker, Y.Nosochkov et al. (see ref for details)
- In further discussion realized that **this connection** should not be used, to allow quick move
- The QD0 part of cryostat will be connected to part of cryo system (2K) attached to detector

<http://ilcagenda.cern.ch/conferenceDisplay.py?confId=1187>



Different L^*

- Next slide shows how different L^* can be arranged
- Part of FD which stays with detector is different
- Fixed part of FD is the same
- Optics study show that such change of drift between QD0 and QF1 parts of final doublet is possible
- However, with different L^* there could be more time spent for retuning the optics, collimation, etc.
- It may be beneficial to consider a unified L^* for push pull design. (E.g. 4.2-4.5m?)
- For the moment, still consider $L^*=3.5\text{m}$, as moving to longer L^* may only simplify the FD design

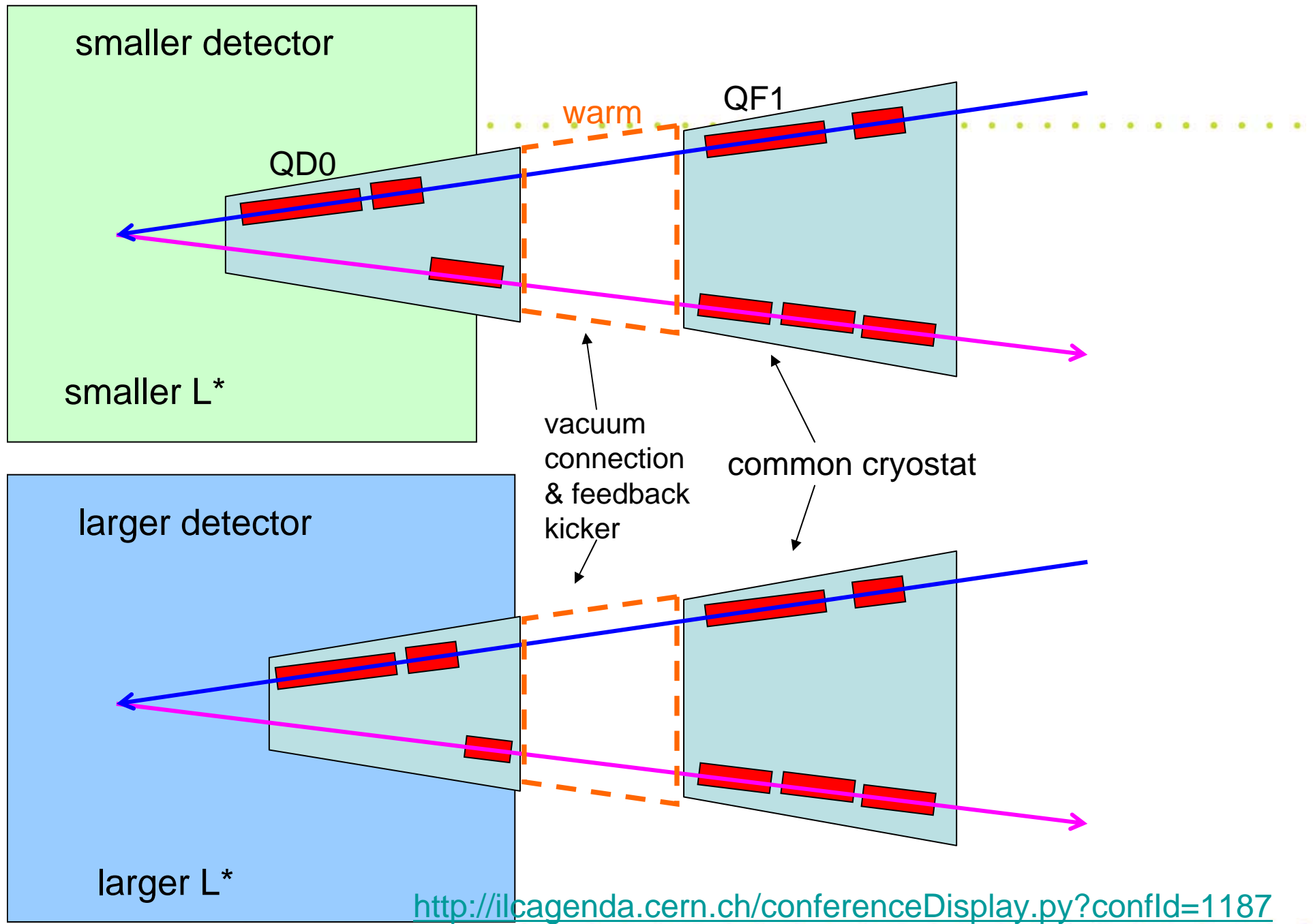



A service cryostat that need to be placed close to QD0 part of FD

Location is being discussed – attached to endcap (close to QD0) or on a moveable platform near detector (see further slides)

It does not have to be accessible during run

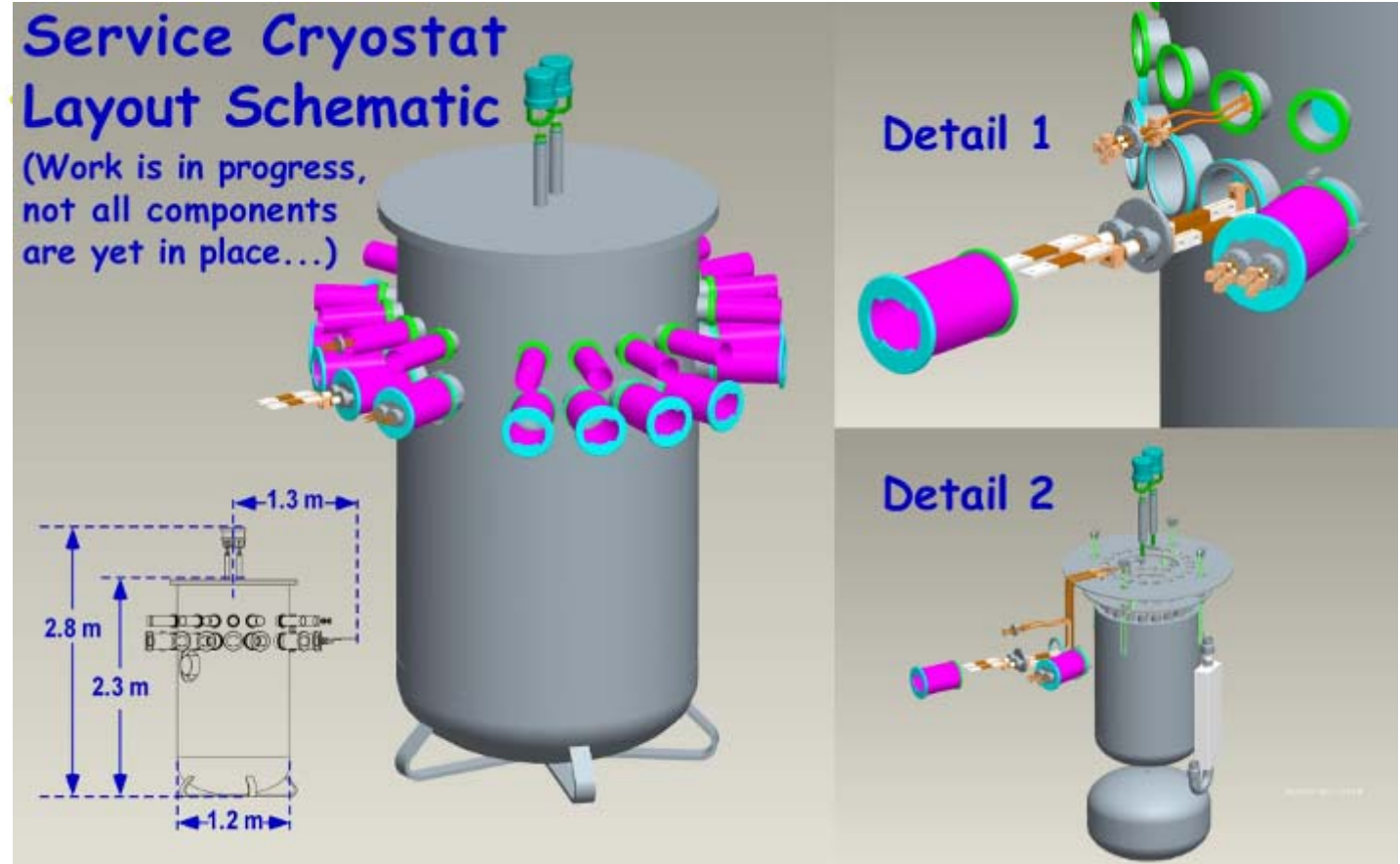

Brett Parker, Mike Anerella, et al. (BNL)



New optics for extraction FD

- B.Parker, Y.Nosochkov et al. (see ref for details)
- Rearranged extraction quads are shown. Optics performance is very similar.
- Both the incoming FD and extraction quads are optimized for 500GeV CM.
- In 1TeV upgrade would replace (as was always planned) the entire FD with in- and outgoing magnets. In this upgrade, the location of break-point may slightly move out. (The considered hall width is sufficient to accommodate this).

Extraction quadrupoles near IP

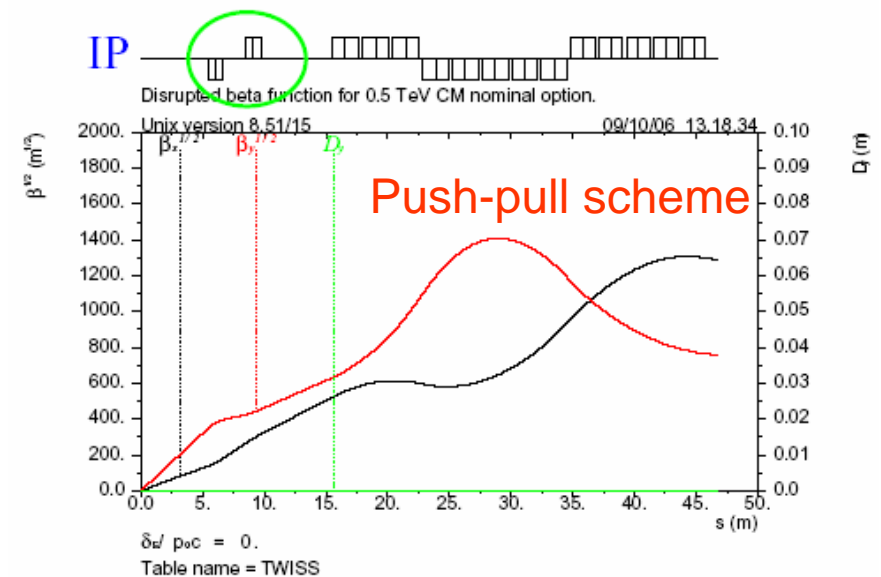
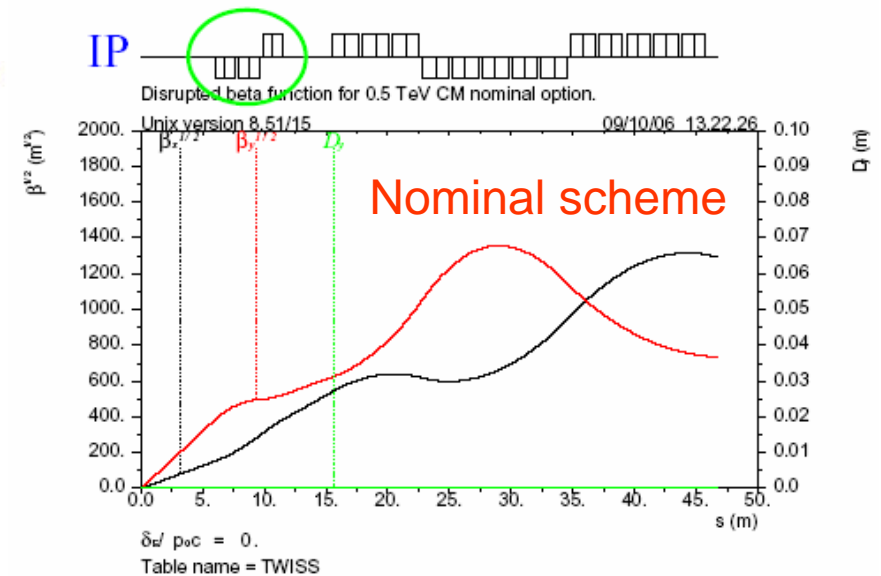

<http://ilcagenda.cern.ch/conferenceDisplay.py?confId=1187>



Vacuum connections

- In the warm part between two FD cryostats (QD0 and QF1 parts), a vacuum connection will be made with double valves
- Each valve would have dual apertures (at 7m from IP the beamlines are 10cm apart) or (Y.S.: preferred) would consist of two independent gates
- RF shield is needed
- Photos show gate valves considered for KEK Super-B [Y.Suetsugu, KEK]
- The technology is applicable for ILC (sizes to be scaled down) [Y.S.]

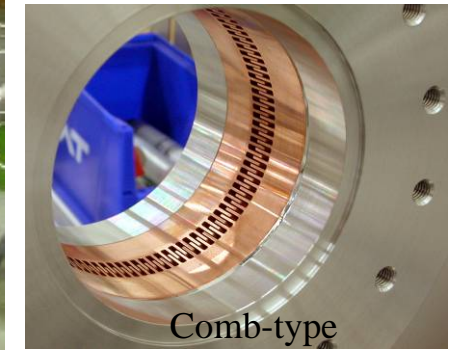
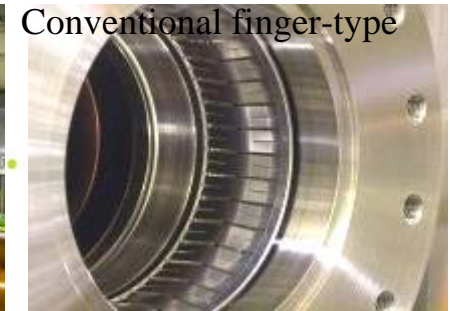
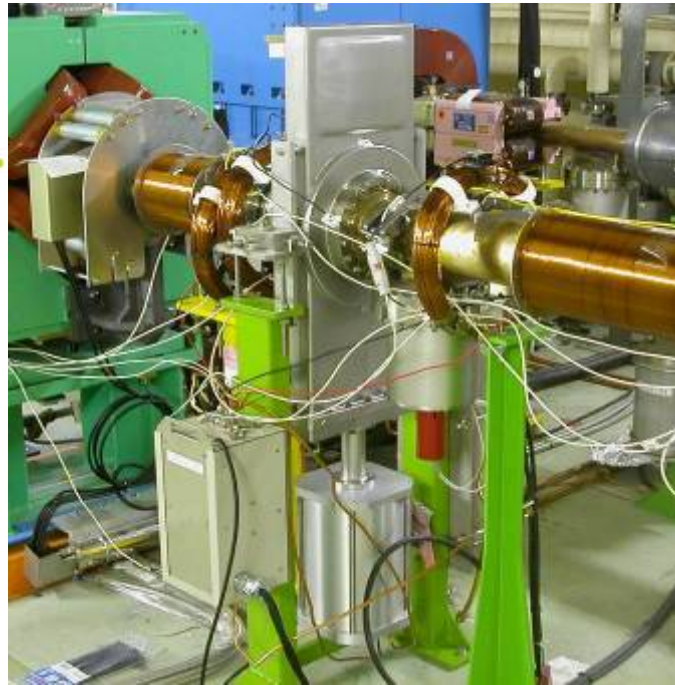

Gate valve with comb-type RF shield and its modifications (Ag plated SS => Cu teeth).

Y.Suetsugu, KEK, in collaboration with VAT Co.



FD alignment & support

- Each part of FD cryostats have movers to align cryostats as a whole
- Each magnet in the cryostat have correction coils to adjust individual positions of magnetic centers
- Supports of two parts of cryostats may have optical or mechanical lock-in – details to be engineered



Detector systems connections

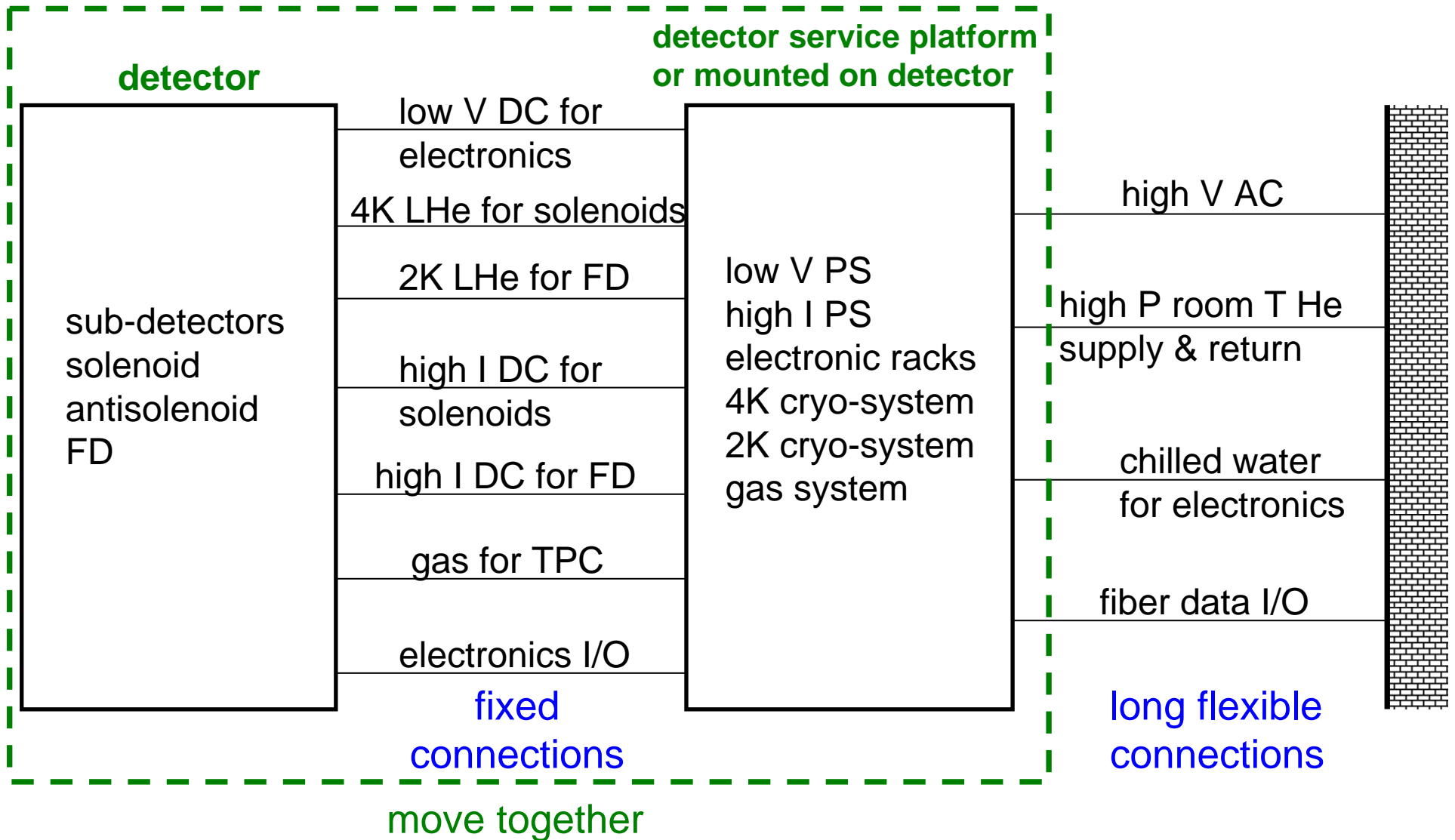



Vibrations at detector (Oct.2000)

Scheme of measurements:

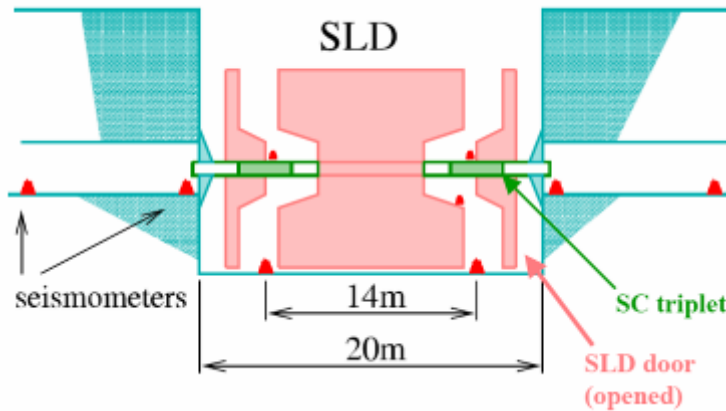

- Floor noise in SLD pit and FF tunnel mostly affected by building ventilation and water compressor station
- Vibration on detector mostly driven by on-SLD door mounted racks, pumps, etc.
- This shows that it may be needed to place noisy detector equipment on separate platform nearby

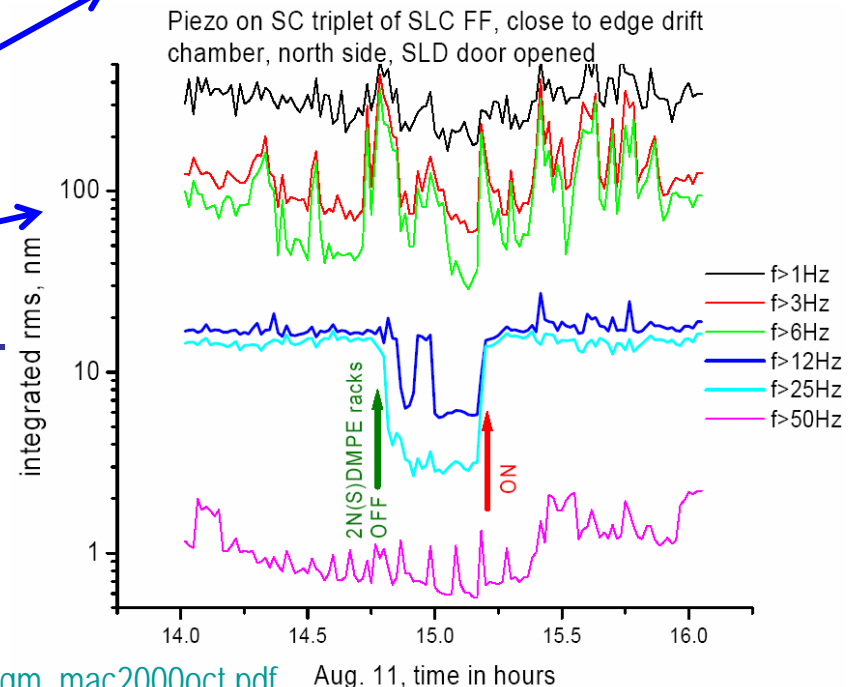
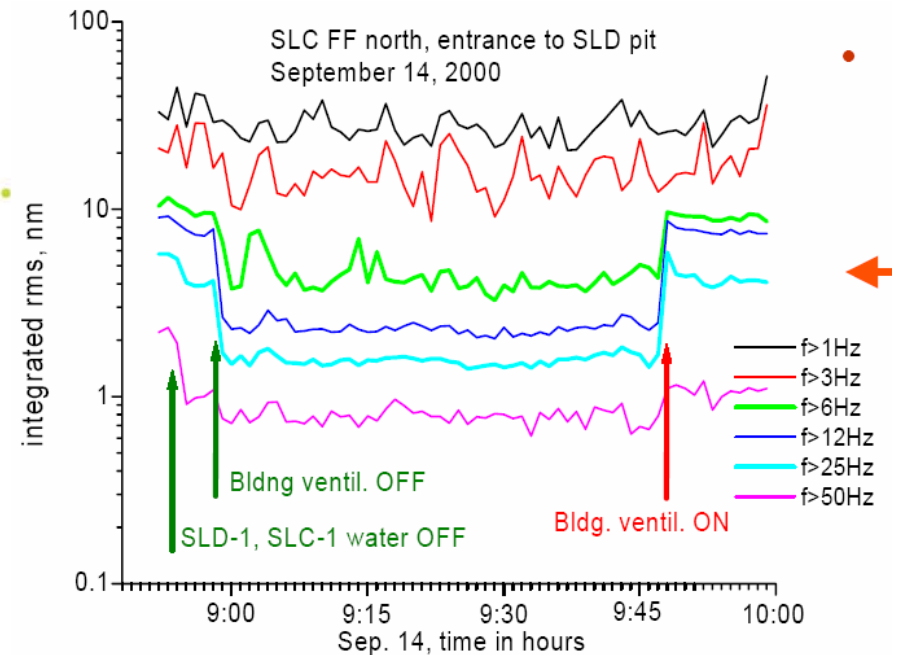

http://www-project.slac.stanford.edu/lc/local/MAC/OCT2000/Talks/Andrei_gm_mac2000oct.pdf



Detector design and radiation safety properties

- If the detector electronics or services, or the off-beamline detector need to be accessed during run, the detector need to be self-shielded, or a shielding wall should be used
- Preliminary study indicate that some of detectors considered for ILC can be made self-shielded even for pessimistic assumption of full beam loss (18MW)
- There is significant concern that safety rules may become tighter in time, and that larger gaps (for cables, etc.) would be needed in detector
- The 4th detector concept is more difficult to make self shielded
- Assume the design with shielding wall, while consider self-shielding as possible improvement



Concept which does not rely on self-shielding detector

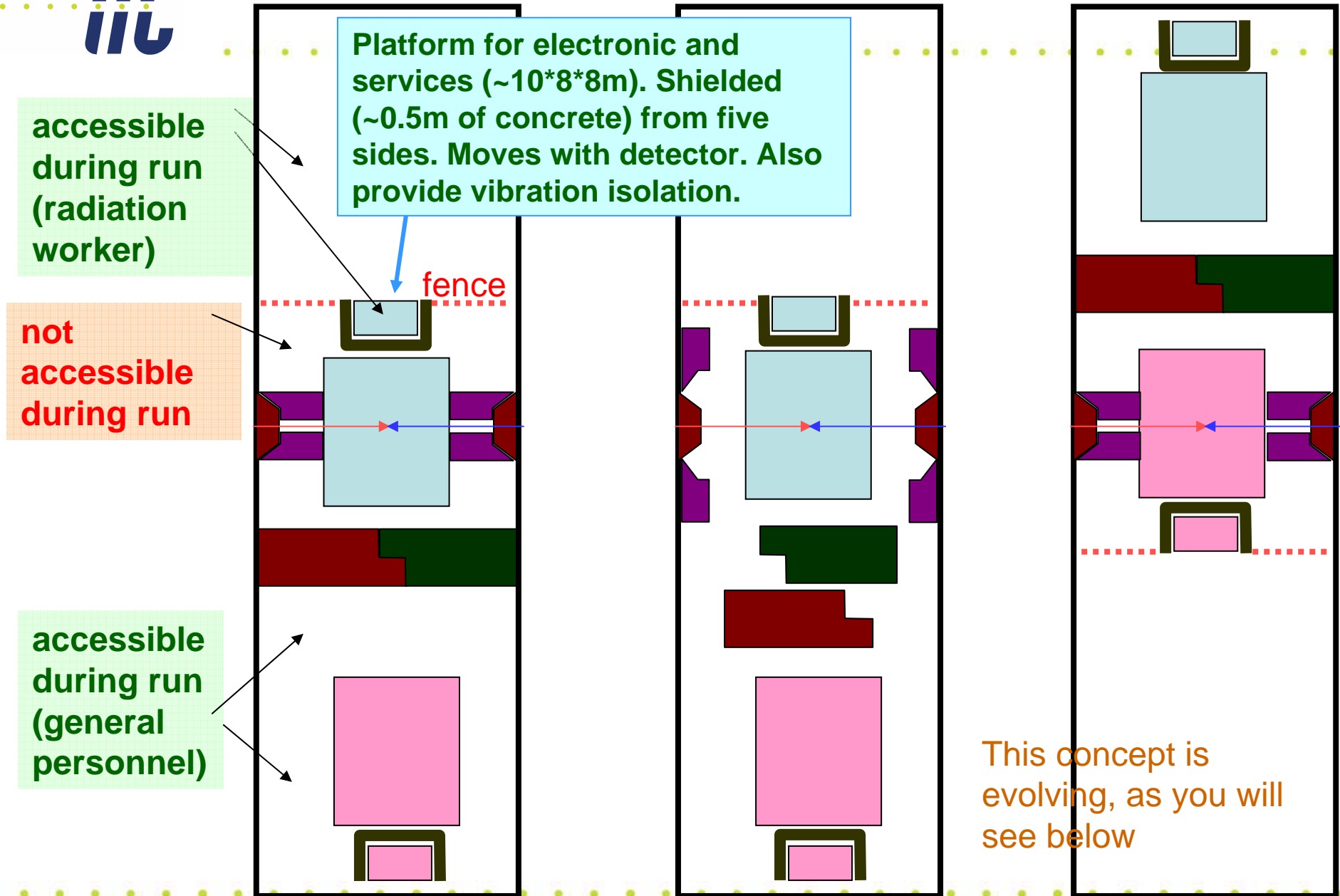



Self-shielding study of detectors

Results show that GLD or SiD (considered so far) can be self-shielded even if assume criteria of 25rem/h (250mSv/h) or integrated per incident <100mrem for the maximum credible incident [SLAC rule] at any place (=loss of 18MW beam at thick target)

Example show studies for GLD

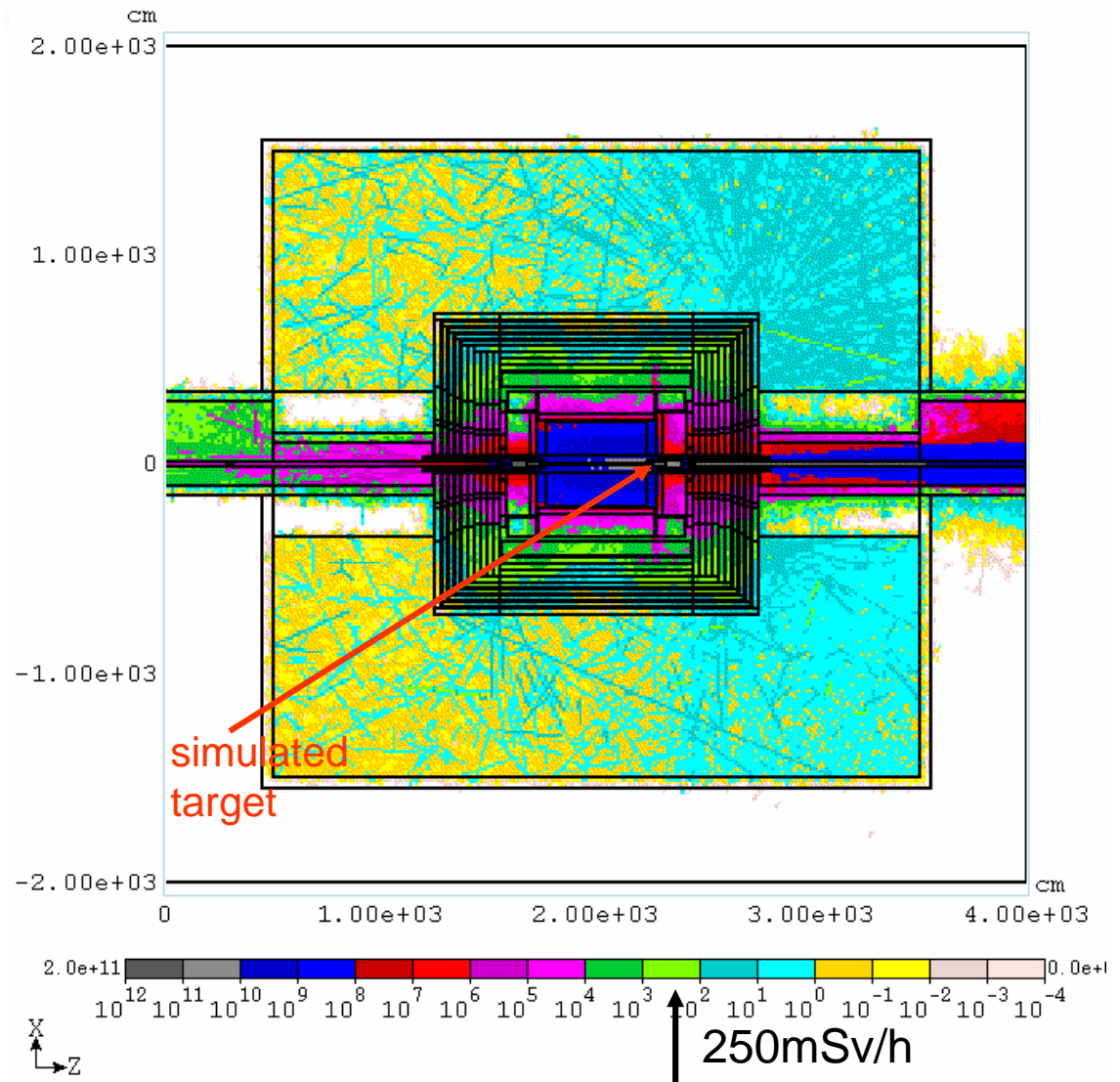

<http://ilcagenda.cern.ch/conferenceDisplay.py?confId=1204> Toshiya Sanami (SLAC/KEK), et al.



GLD modified to improve self-shielding

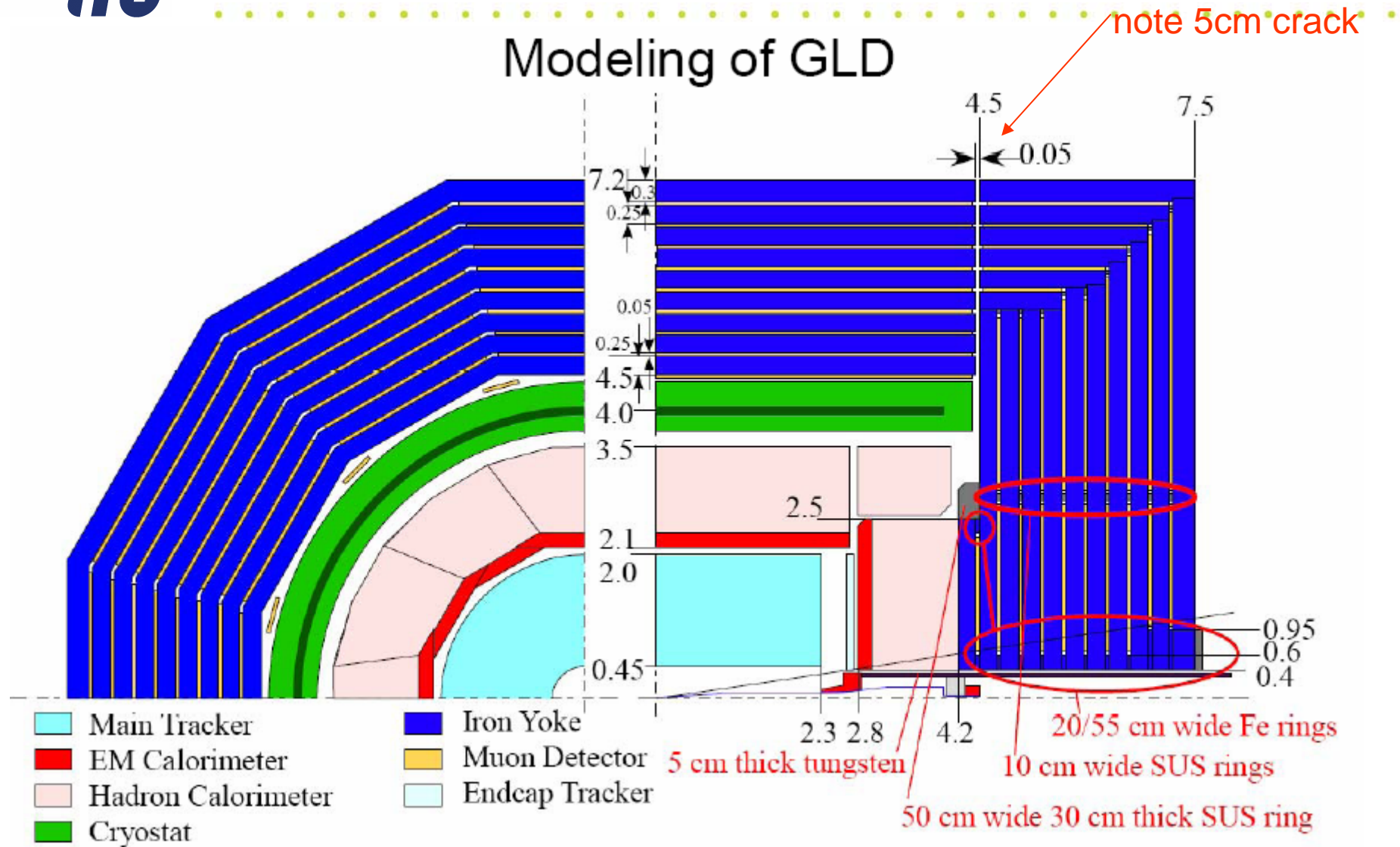

Yasuhiro Sugimoto



Self-shielding study, SiD-like detector

A proper beamline shielding can reduce the dose below 25rem/hr

Desired thickness is in between of these two cases

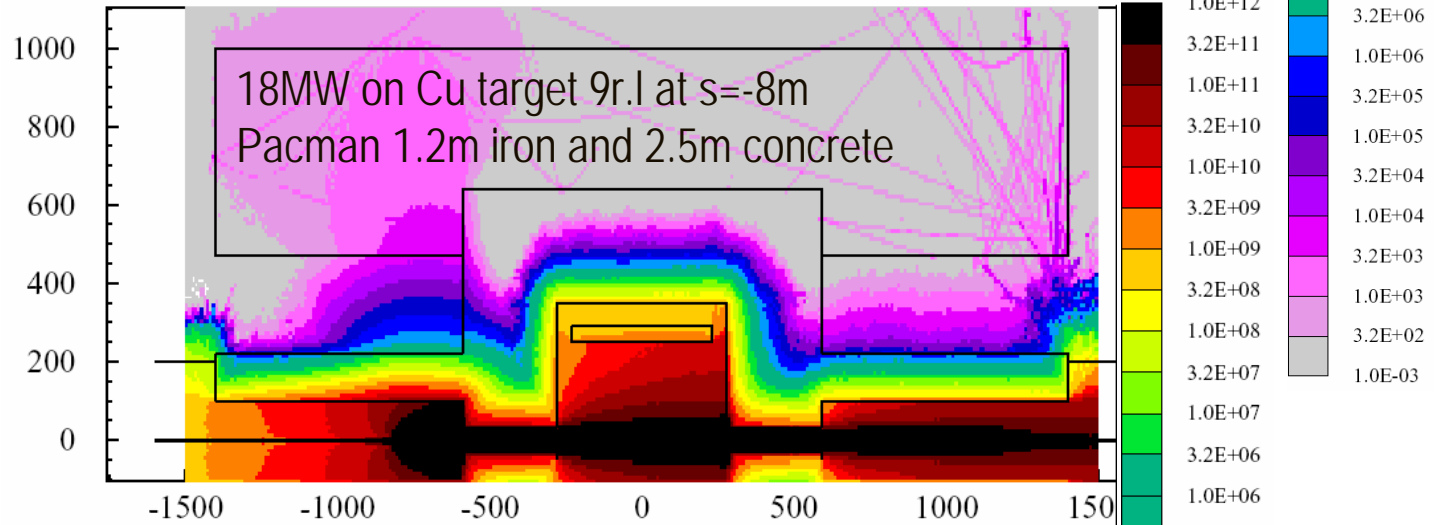
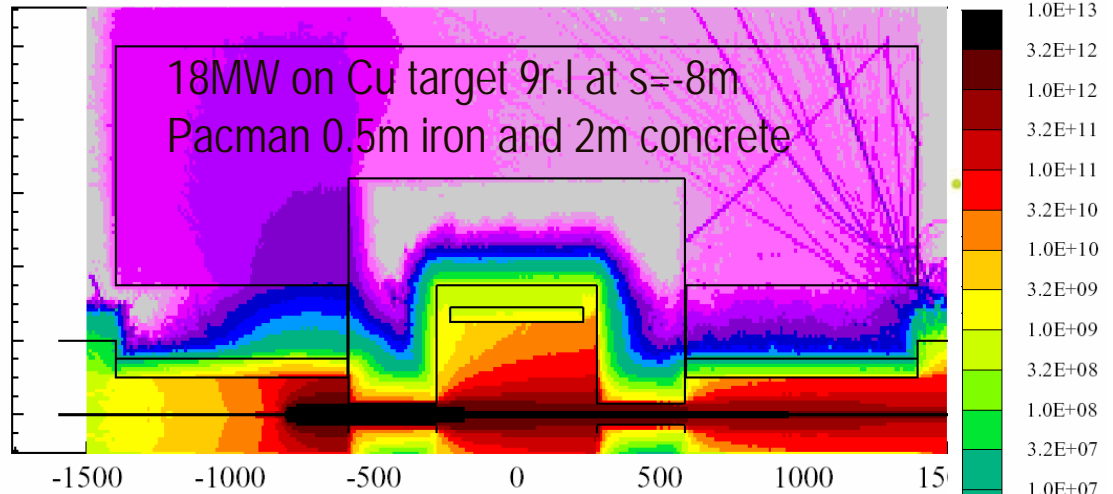

color scale is different in two cases

Alberto Fasso et al

18MW at s=-8m:

Packman

Fe: 0.5m, Concrete:2m

Fe: 1.2m, Concrete: 2.5m

dose at pacman external wall

120rem/hr (r=3.5m)

0.65rem/hr (r=4.7m)

dose at r=7m

23rem/hr

0.23rem/hr



The 4th detector concept

- Featuring the dual solenoids and no need for the iron return yoke
- The calorimeter, solenoids and supporting structures give some shielding but certainly not sufficient for full self-shielding
- If it were to be made self-shielding, ~2-3m of concrete would need to be added around the detector. Or has to rely on external shielding wall

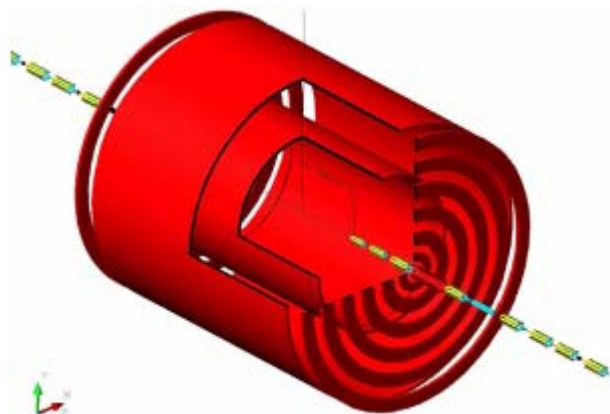
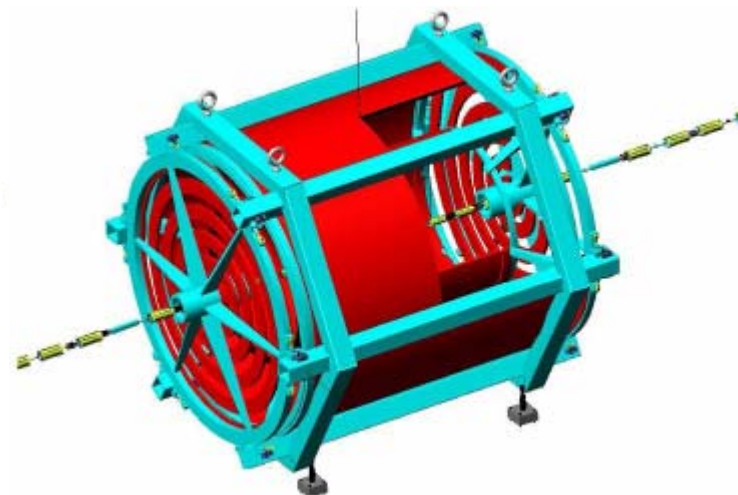

A cut-away view of the dual solenoids and the "wall of coils" that terminate the solenoid field in the 4th Concept.

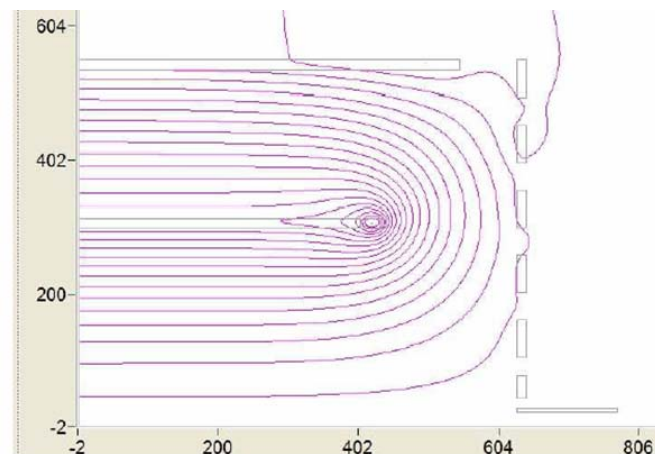

Magnetic field lines of the 4th Concept, showing the dual solenoids and the "wall of coils" on the ends.



Shielding wall

- The following slides show that if detector does not provide any shielding, a 3m concrete wall is needed
- If partial shielding is provided by detector, the wall may be thinner
- The wall does not have to be full height
- A curtain wall (movable on crane rails) may or may not be needed to block the gap above the wall

If detector does not provide any radiation protection:

- For 36MW maximum credible incident, the concrete wall at 10m from beamline should be ~3.1m

Alberto Fasso et al

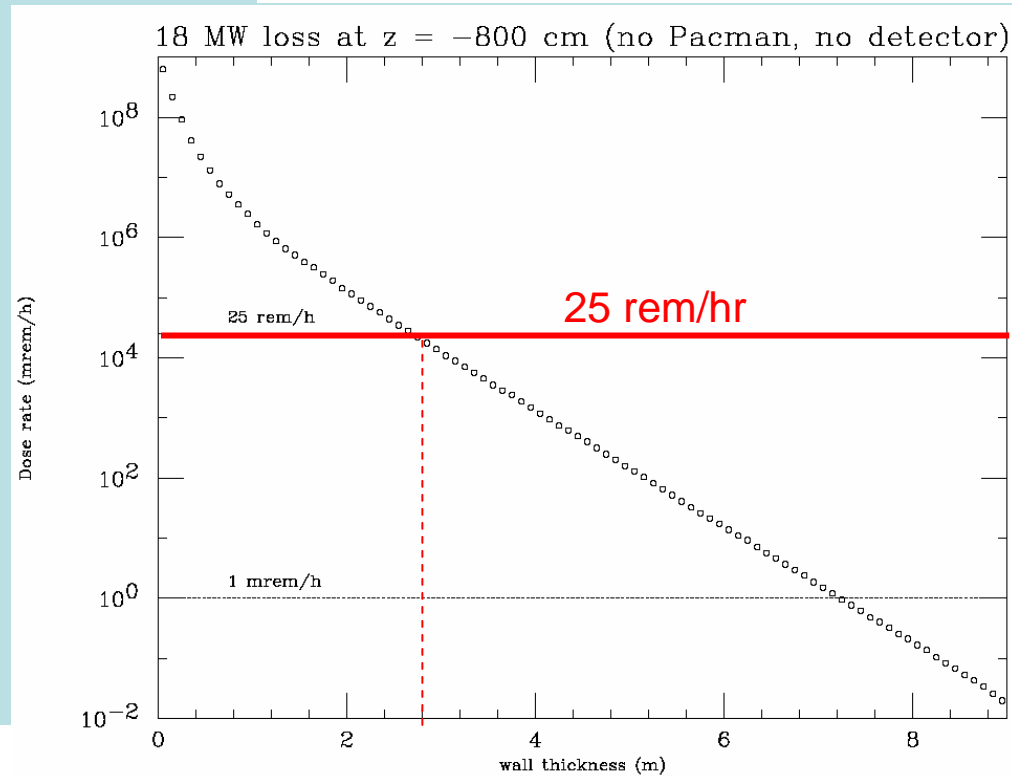
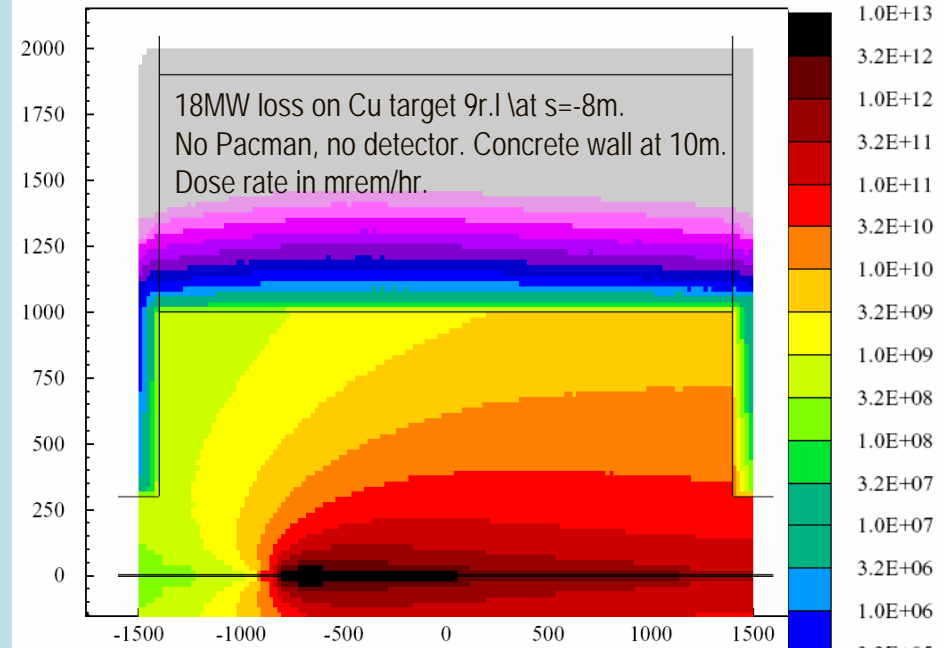
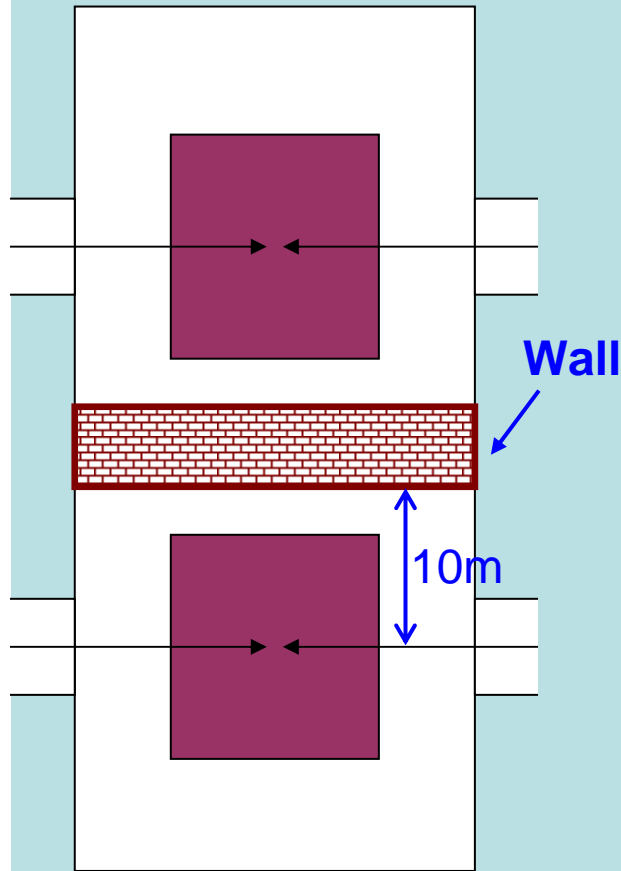



IR hall with shielding wall

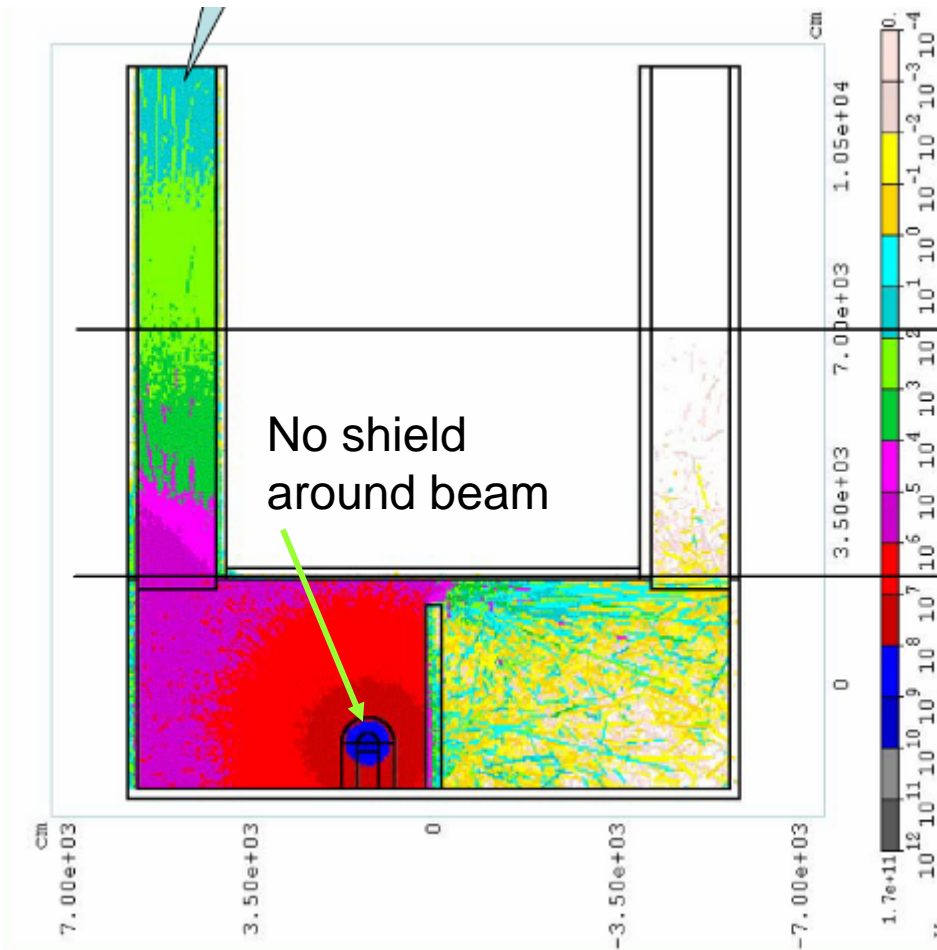

May need additional curtain wall on top of main wall. May need shaft cover.

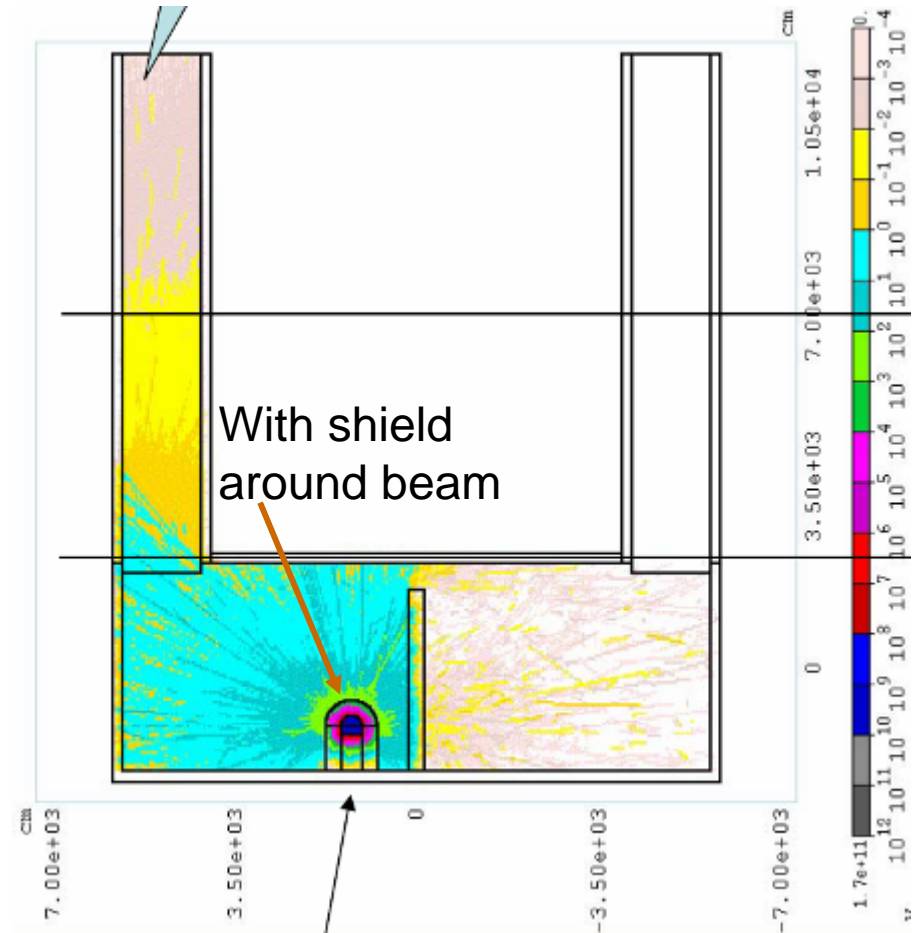

Do not need full height wall. The height could be decrease from what shown.

RP T.Sanami and A.Fasso

2006年9月19日

Sep 21-Nov 6

Global Design Effort

push-pull: 30



More radiation physics

Start from detector with no material, add 0.5m concrete around; pacman & partial wall.
=> Cannot access Area1

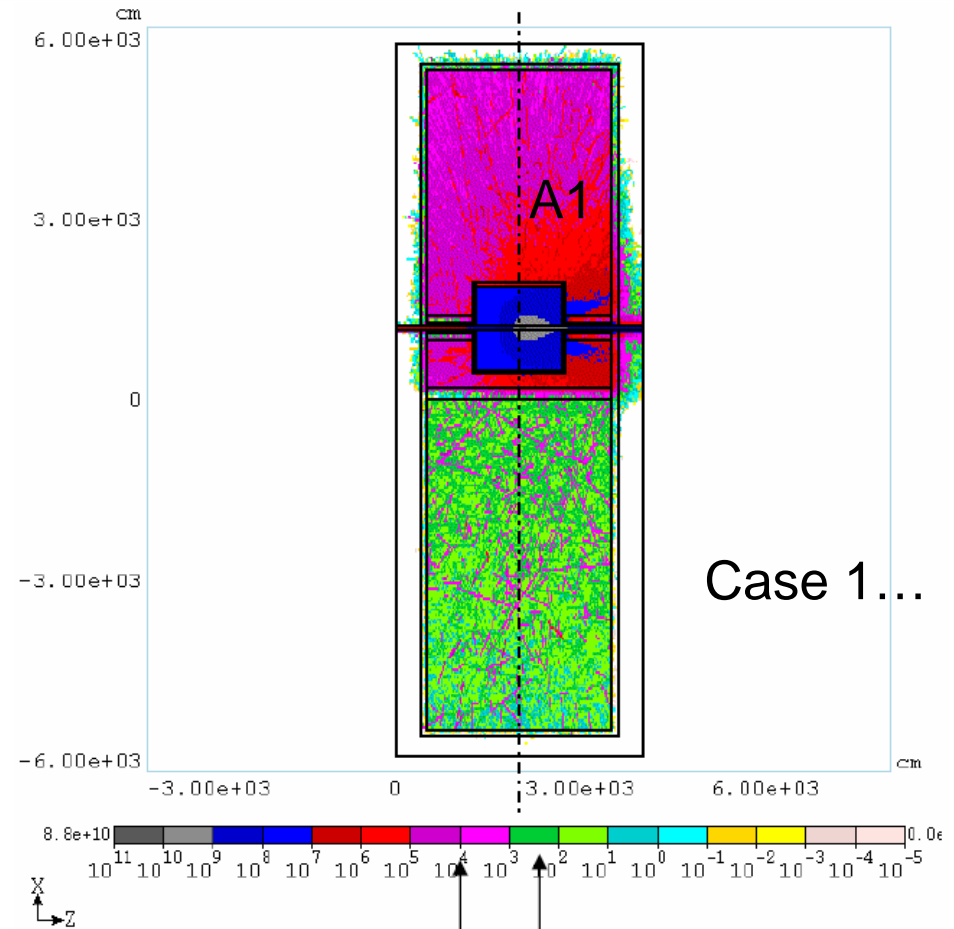
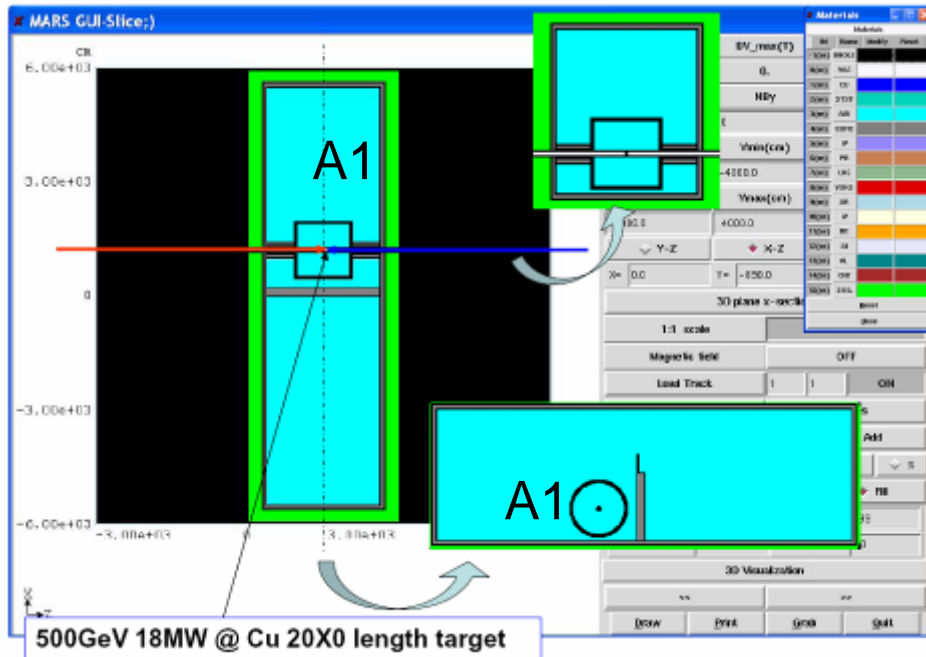
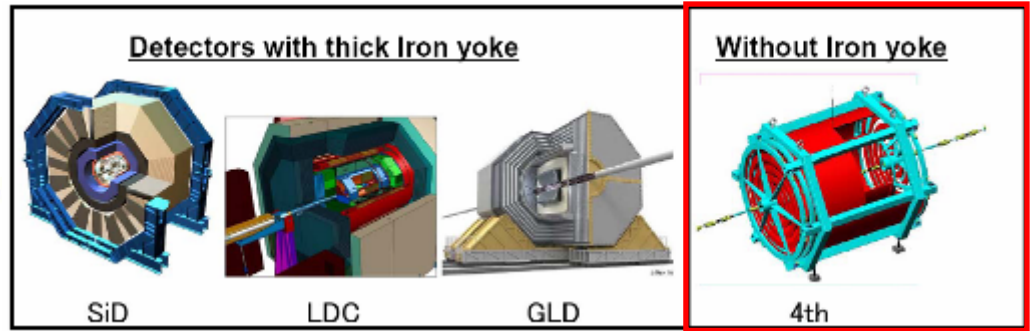

T.Sanami, <http://ilcagenda.cern.ch/conferenceDisplay.py?confId=1225>

25rem/h@18MW



More radiation physics

Either do not require access to Area1 during run, or...

...place more concrete shield on detector and improve the shielding walls...

(there is a choice where to put more shielding – on the detector or on the wall)

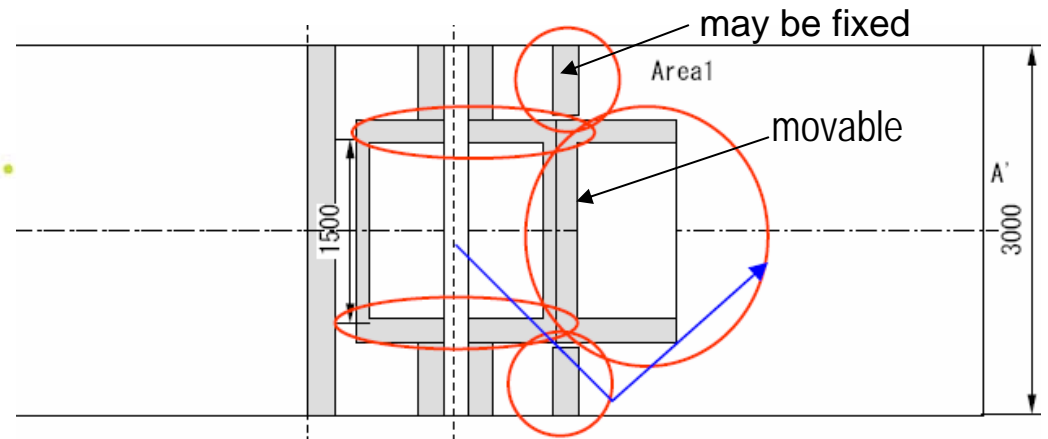

...Case 6...

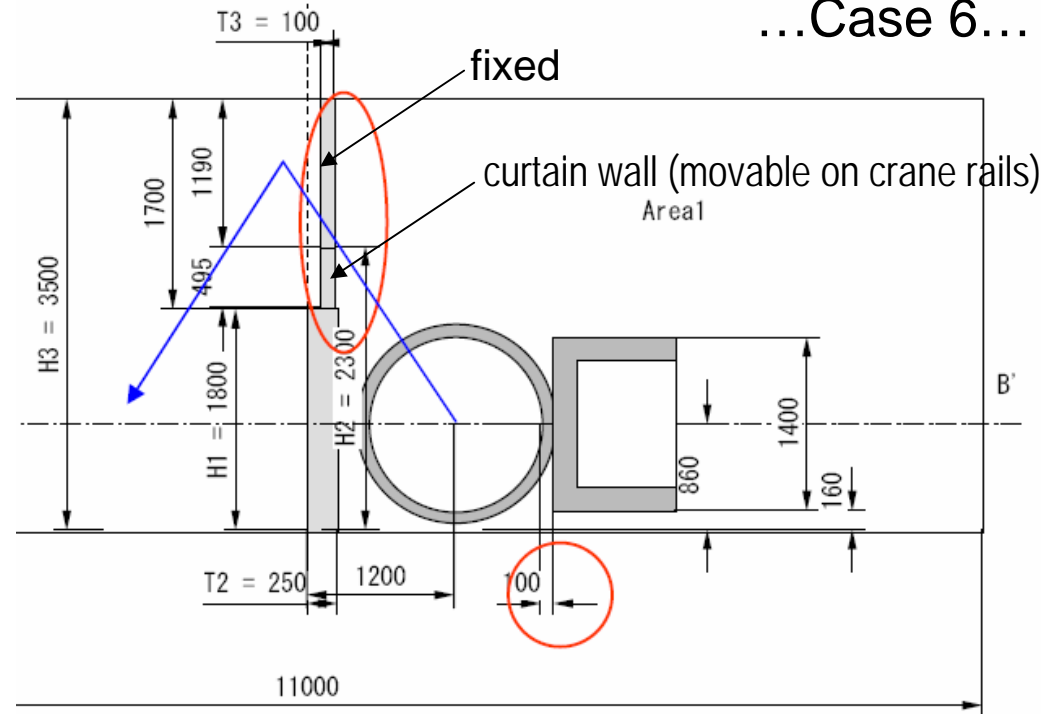

T.Sanami, <http://ilcagenda.cern.ch/conferenceDisplay.py?confId=1225>



More radiation physics

With more shielding, can improve levels such that it may be possible to allow access to the Area1 as well

...Case 6...

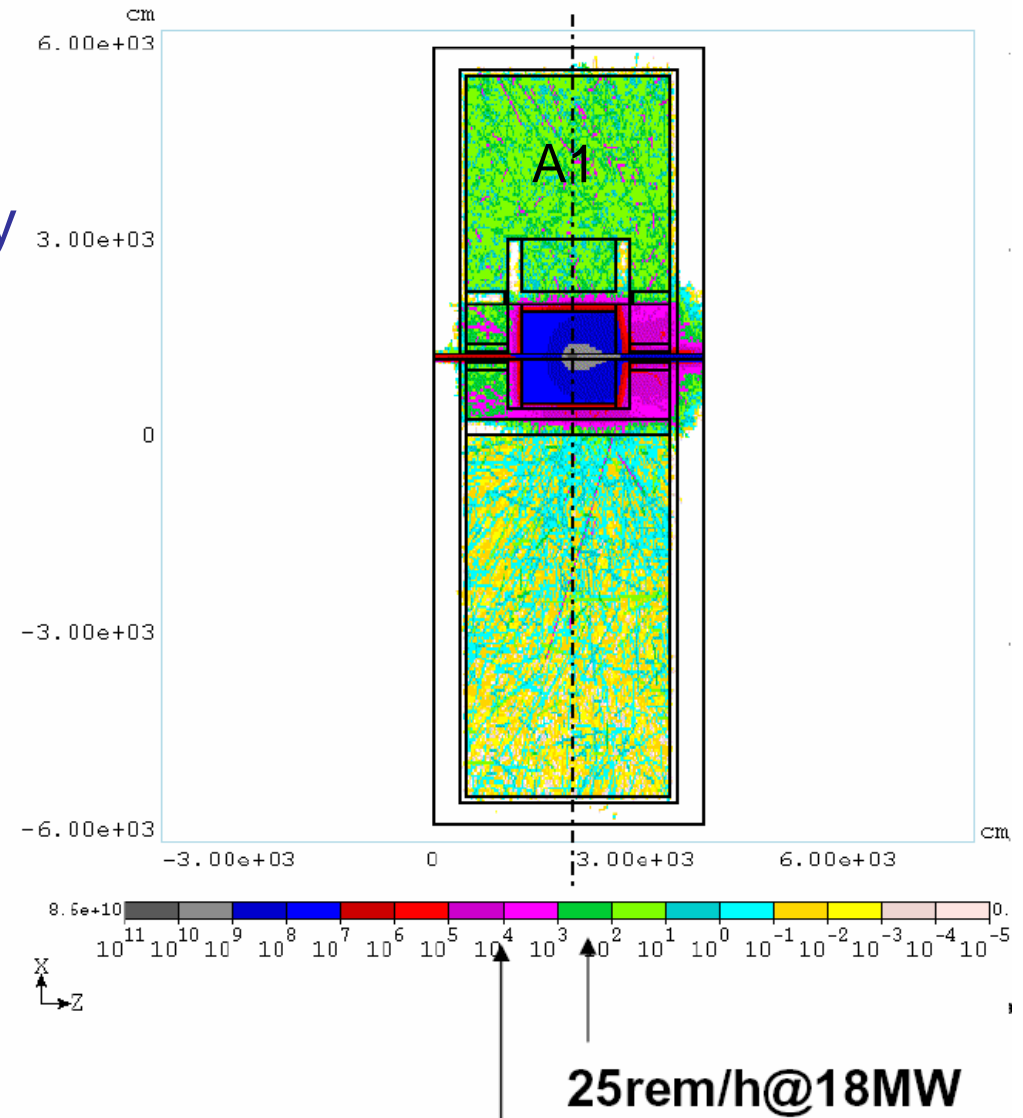
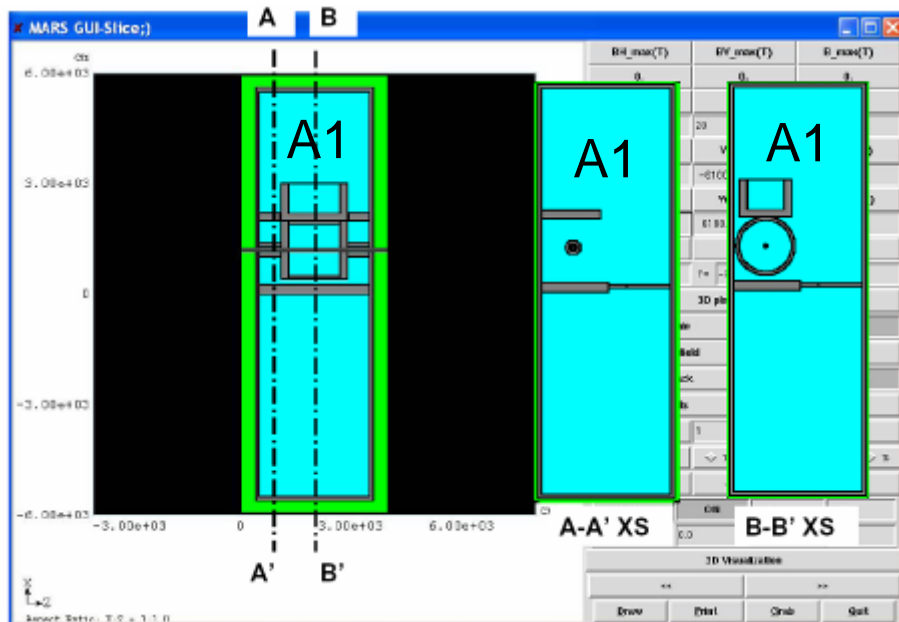

T.Sanami, <http://ilcagenda.cern.ch/conferenceDisplay.py?confId=1225>



Experience from UA2/UA5

- Peter Jenni (private communication):
- UA5 was a relatively small (light) experiment. It was a streamer chamber, and it was actually just lifted with the surface crane such that UA2 could slide in/out on air-pads.
- This experience may not be of any relevance for detectors of the size we are discussing for ILC

<http://cern-discoveries.web.cern.ch/CERN-Discoveries/Courier/experiments/Experiments.html>

<http://doc.cern.ch//archive/electronic/cern/others/PHO/photo-ex/8710495.jpeg>



UA2, CERN

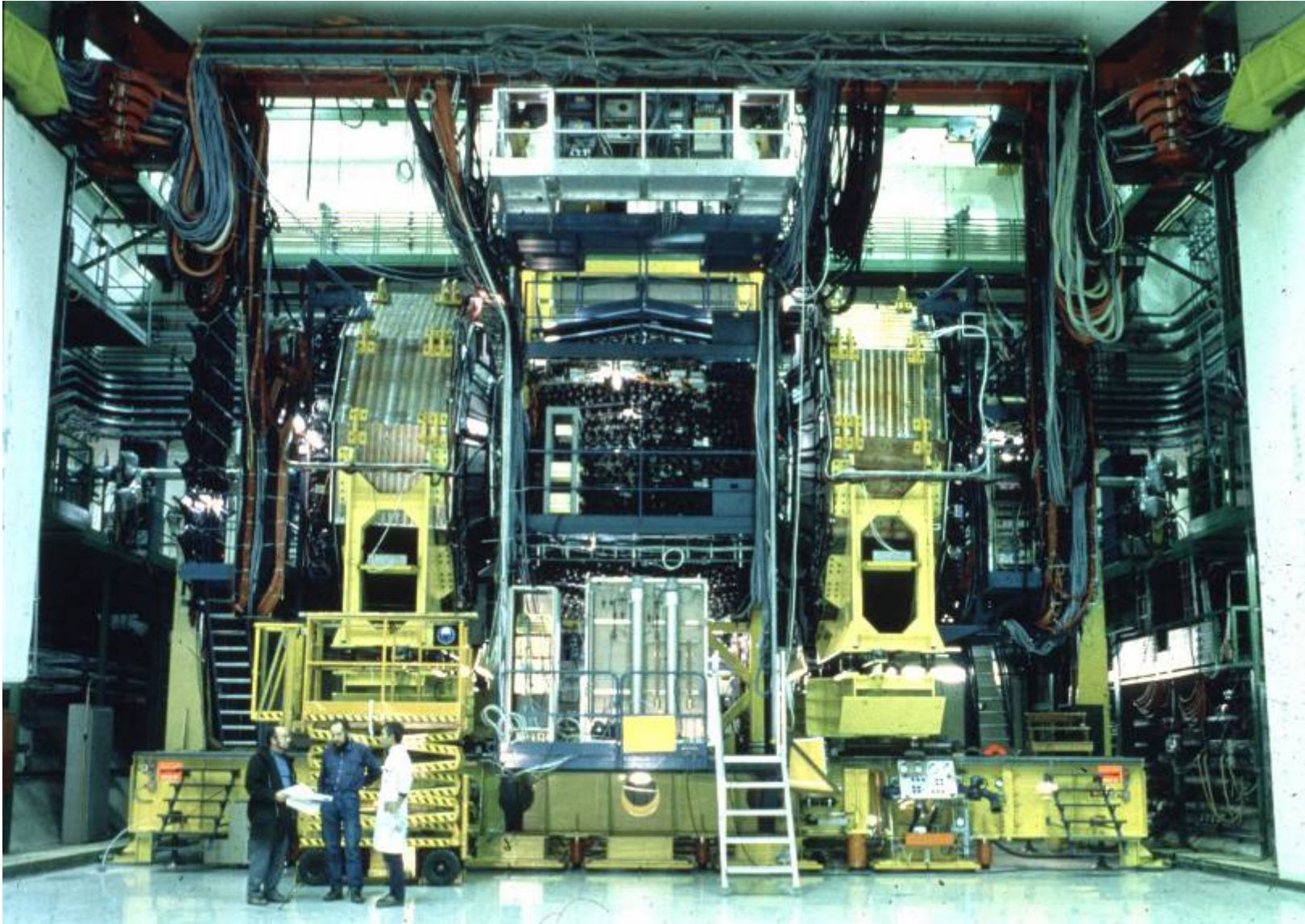

Sep 21-Nov 6, 06

Global Design Effort

push-pull: 35



Air-pads at CMS

Single air-pad capacity ~385tons (for the first end-cap disk which weighs 1400 tons). Each of air-pads equipped with hydraulic jack for fine adjustment in height, also allowing exchange of air pad if needed. Lift is ~8mm for 385t units. Cracks in the floor should be avoided, to prevent damage of the floor by compressed air (up to 50bars) – use steel plates (4cm thick). Inclination of ~1% of LHC hall floor is not a problem. Last 10cm of motion in CMS is performed on grease pads to avoid any vertical movements. [Alain Herve, et al.]



Photo from the talk by Y.Sugimoto,
<http://ilcphys.kek.jp/meeting/lcdds/archives/2006-10-03/>

14kton ILC detector would require
~36 such air-pads



Displacement, modeling

Starting from idealized case:

- elastic half-space (Matlab model)
- simplified ANSYS model (size of modeled slab limited by memory)

Short range deformation ($\sim 0.1\text{mm}$) is very similar in both models.

Long range ($1/r$) deformation ($\sim 0.3\text{mm}$) is not seen in ANSYS because too thin slab in the model

More details (3d shape of the hall, steel plates on the floor, etc.) to be included.

Long term settlement, inelastic motion, etc., are to be considered.

Parameters: $M=14000\text{ ton}$; $R=0.75\text{m}$ (radius of air-pad);
 $E=3e9\text{ kg/m}^2$, $n=0.15$ (as for concrete); Number of air-pads=36

J.Amann, <http://ilcagenda.cern.ch/conferenceDisplay.py?confId=1225>

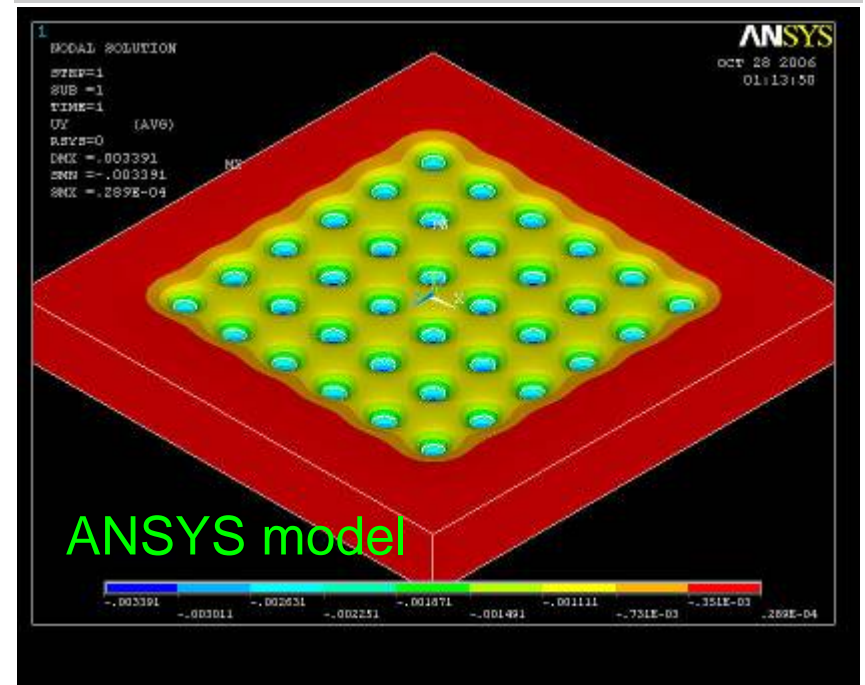
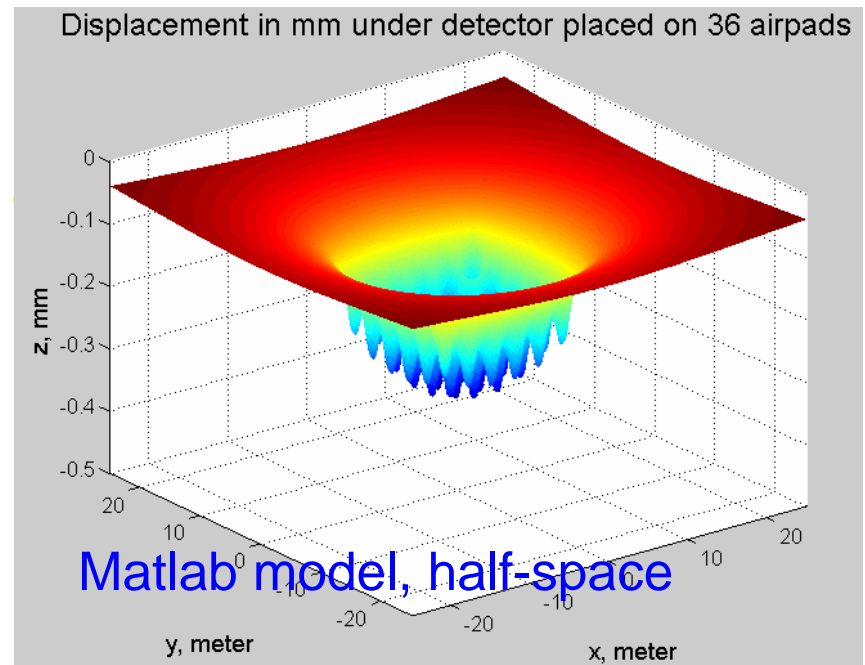

ilc IR hall design

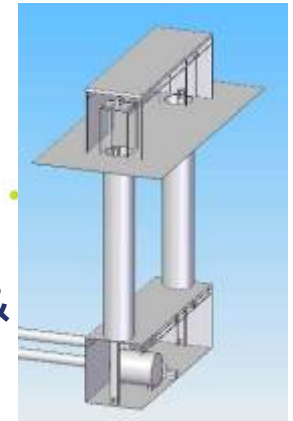

- Early investigations (drilling, etc) of the site in location of IR hall & careful engineering are crucial, independent of push-pull scheme
- Consider the IR hall 110*25*35m and note the comparisons
 - **volume ~100 000 m³ , removed rock ~250 kton , two detectors: <30 kton**
- Structural stability of the hall needs to be provided by careful design, and does not depend much on the need to move the detector
- At a site with water content, have to solve IR hall stability anyway.
- Strength of media, typical values of Young's modulus (in GPa)
 - **Granite, dolomite ~50-70, sandstone~20, concrete ~30, soil (varies a lot)~0.1**
 - **Assumed 30GPa – may be even conservative for deep sites. Sufficient amount of concrete is used for shallow sites to make its strength close to this value**
 - **Keep stresses in elastic regime, avoid cracking concrete (steel plates help).**



Detector design and moving

- Various options are open
 - Design and build detector so that deformations of ~1mm does not affect its functions and precision (solenoid cinematically decoupled from yoke)
 - Place whole detector on a (quite big) platform which minimizes detector deformation during move
 - Working on design of the platform and its ANSYS model

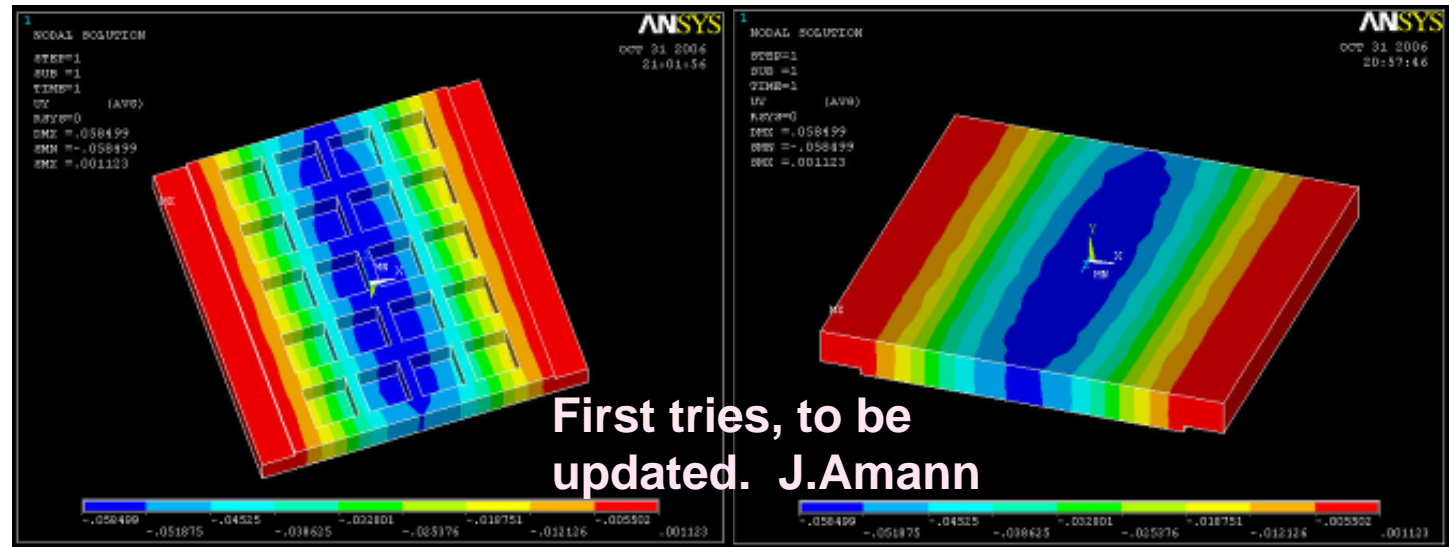



Study of a platform under detector

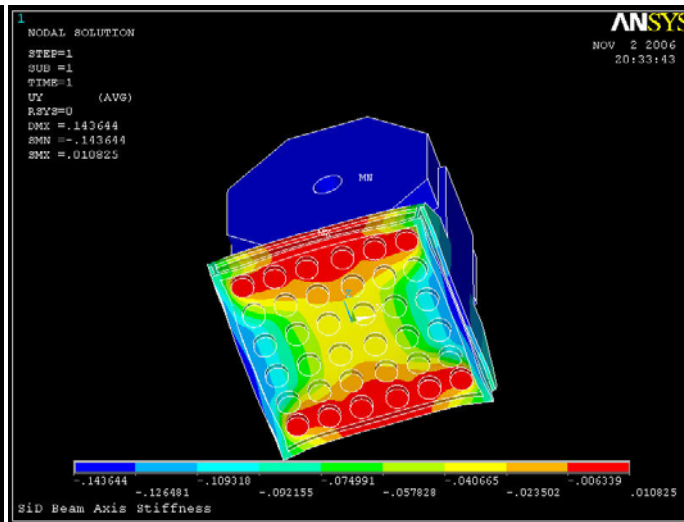
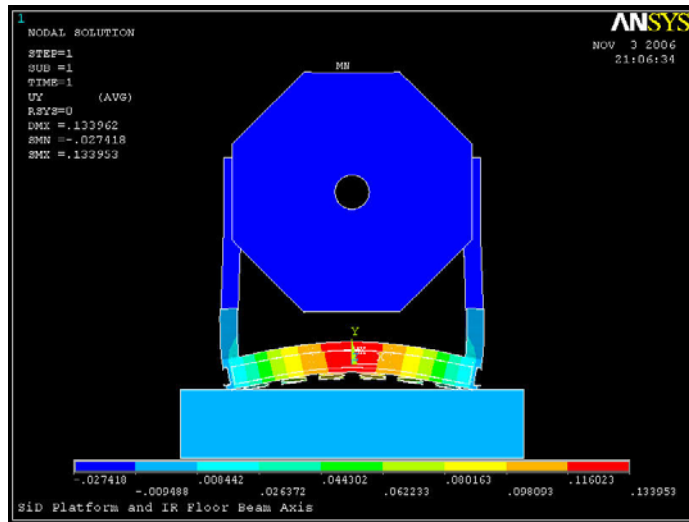
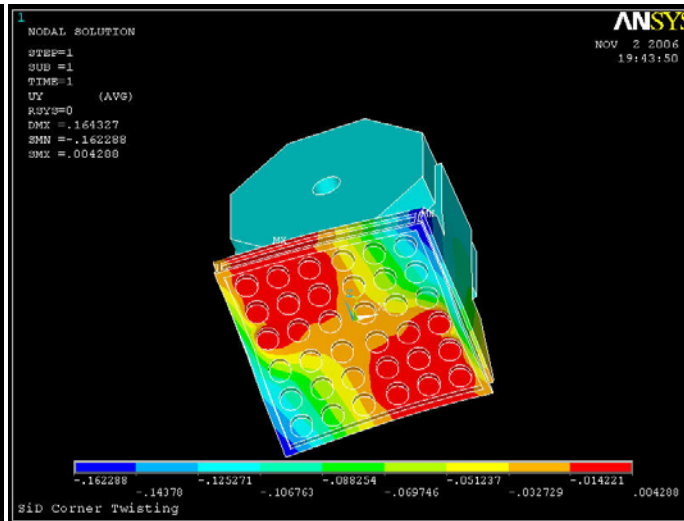
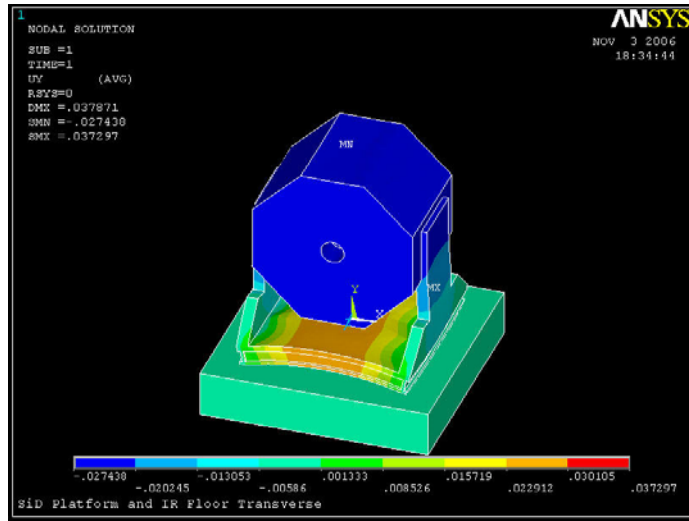

Working progress of platform modeling. Pictures show deformations of the platform in transverse or twisting modes when applied pressure is not-uniform. Deflections (may be exaggerated as did not assume a limit on the air-pad capacity) are in the range of 0.5-2mm. Some stiffening of the platform needed (presently use 1.5m tall I-beams).
J.Amann



Detector opening on the beamline

- Is there a need to open detector when it is on the beamline, or it would be only opened in the off-beamline position?
 - **Moving detector out rapidly, and opening it off-beamline, while letting other detector to take its place and integrate luminosity, may be more efficient**
 - **Desire of detector concepts to keep the option to open detector on the beamline is also understandable**
 - **Keeping the option to open (fast) on the beamline and designing for fast push-pull is feasible, but require solving design interference issues**



Push-pull cryo configuration A

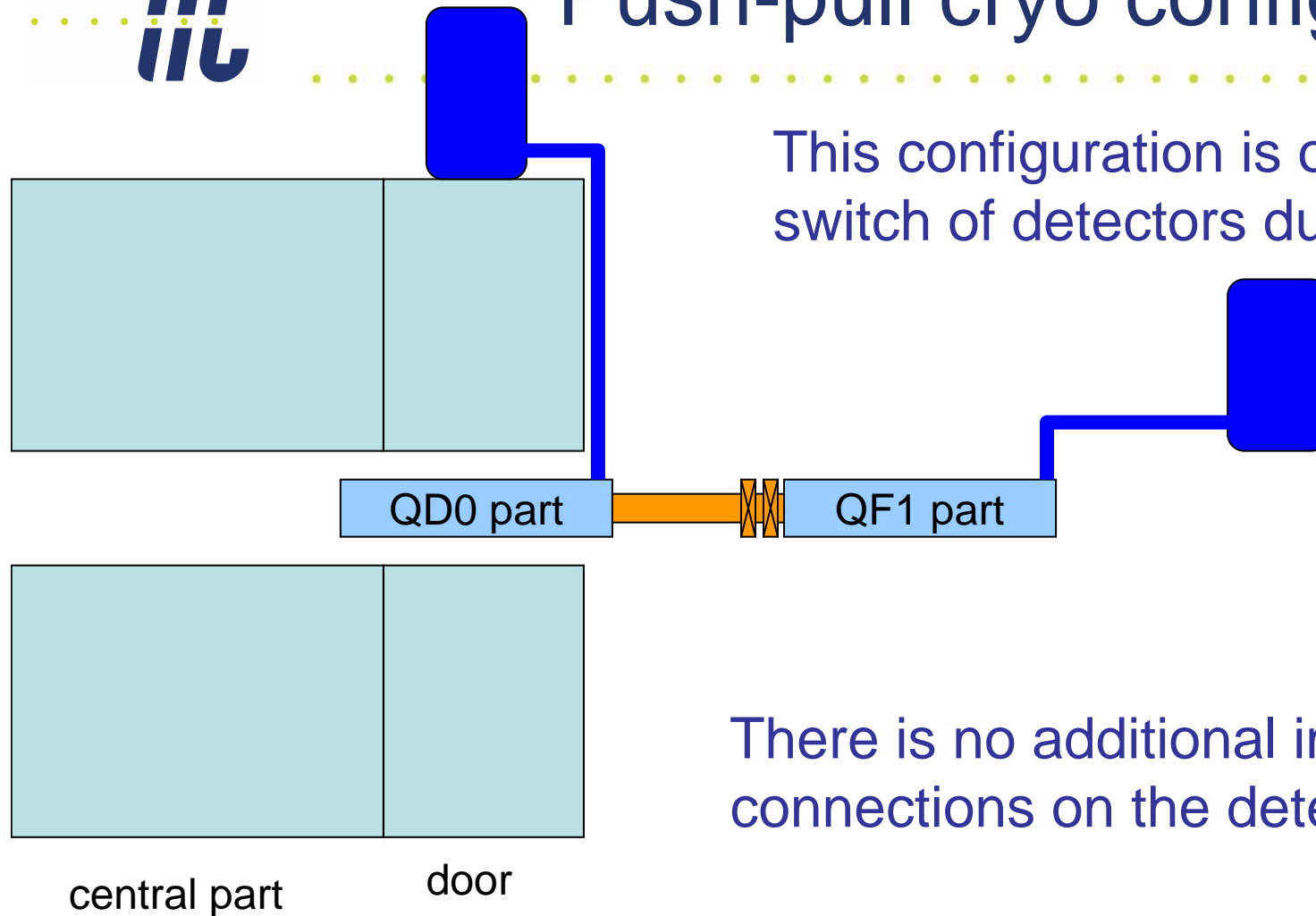

QD0 cryostat placed on end-cap door or nearby platform (to avoid vibration transmission) and moves with detector



... configuration A

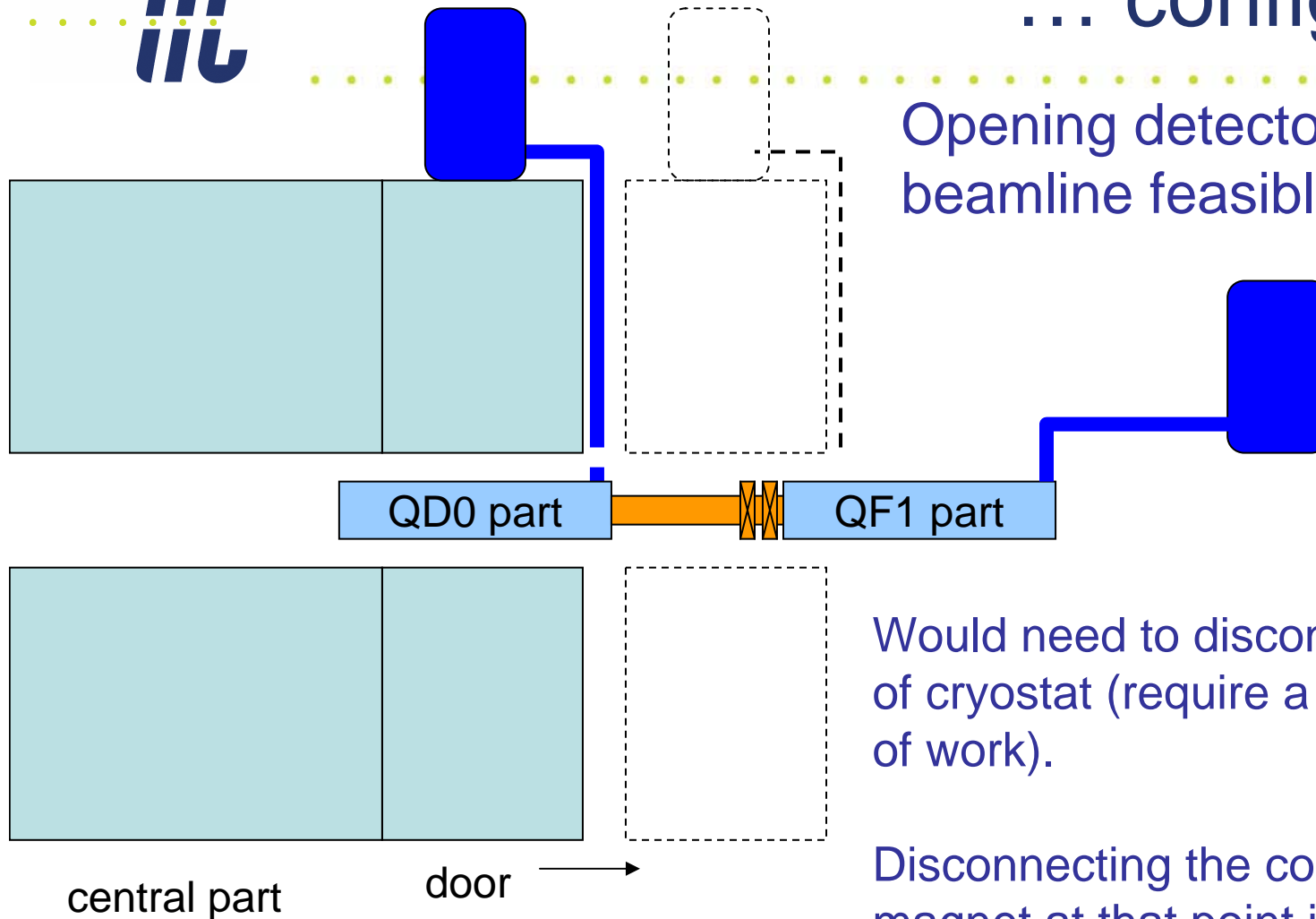

Opening detector along
beamline feasible, but not fast

Would need to disconnect the QD0 part
of cryostat (require a day (maybe days)
of work).

Disconnecting the connection to the
magnet at that point is fairly invasive
(reliability issues). This cannot be a
routine action.



Push-pull cryo configuration B

Configuration which allows fast switch of detectors and fast opening along beamline

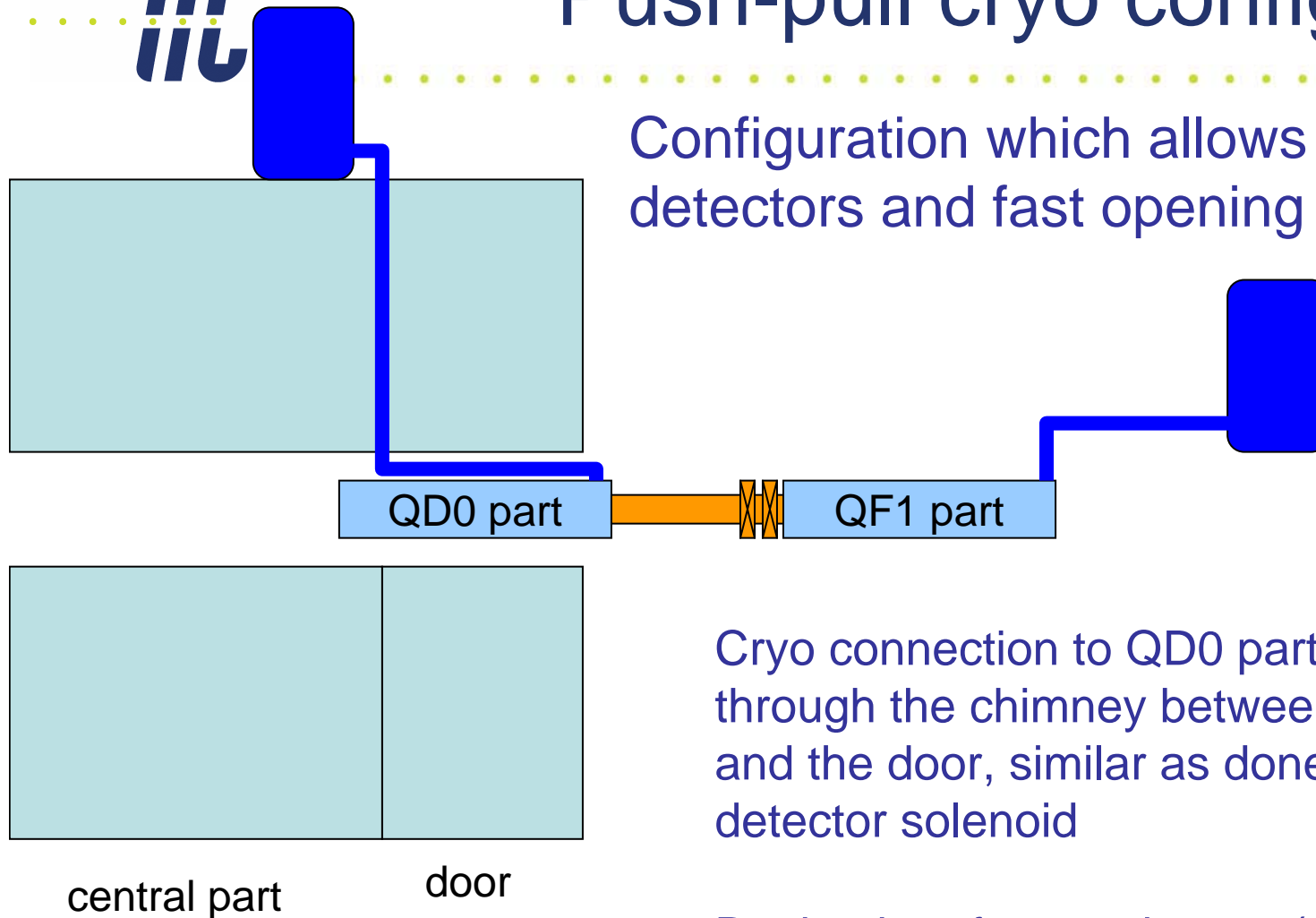

Cryo connection to QD0 part is done through the chimney between central part and the door, similar as done for the detector solenoid

Design interference issues (severe) to be solved

QD0 cryostat placed on the detector or on the nearby platform (to avoid vibration transmission) and moves with detector



... configuration B

Rather fast opening along the beamline should be possible

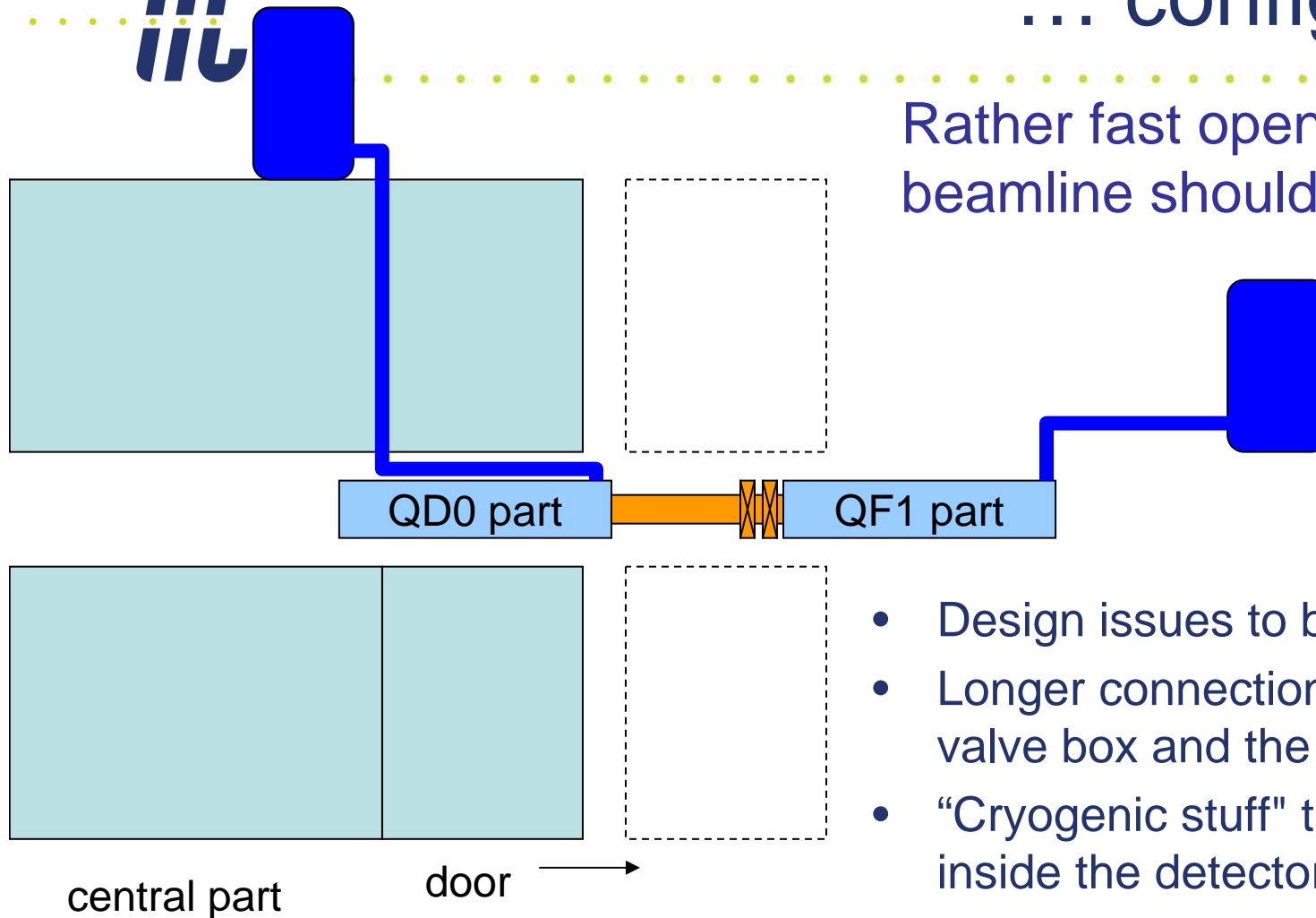

- Design issues to be solved:
- Longer connection between the valve box and the cryostat
- “Cryogenic stuff” takes up space inside the detector
 - cryo line is ~8 inches in diameter and can grow for longer path
- Installation of FD and cryo lines



... configuration B

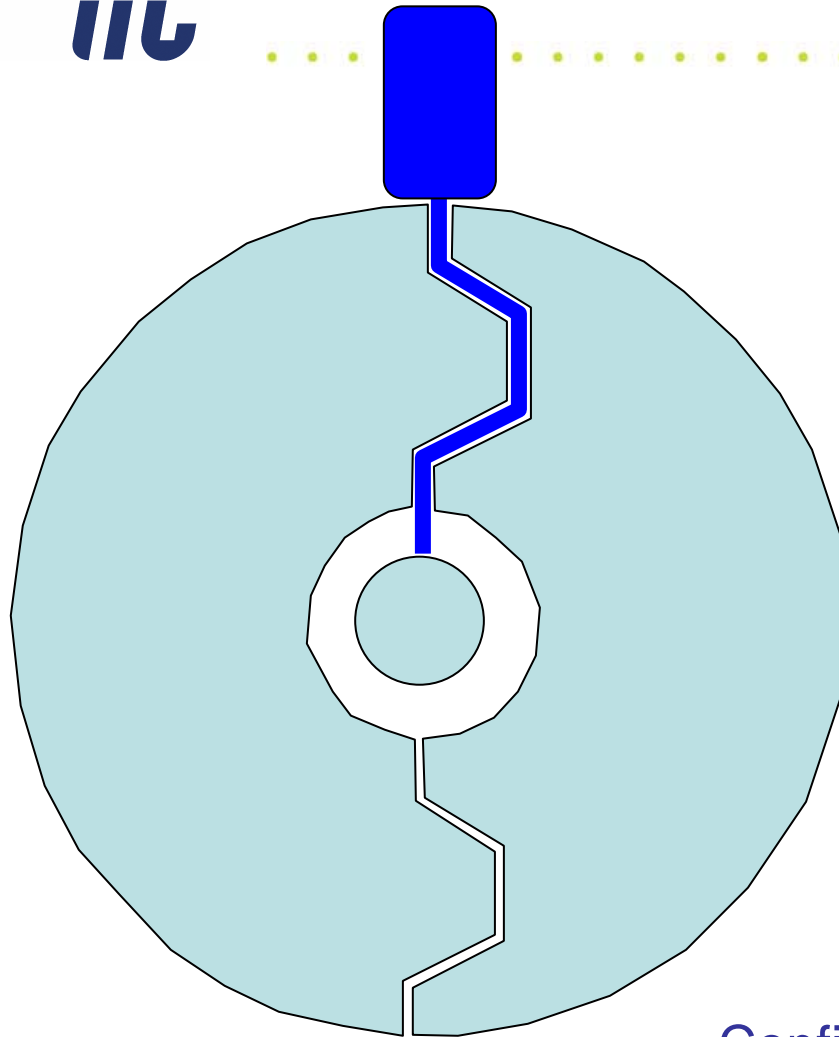

The cryo chimney in the door of detector may need elbows to avoid direct sight to the beamline, if required for radiation safety

Configuration B: interference with detector may be too severe for the scheme to be workable



Push-pull cryo configuration C

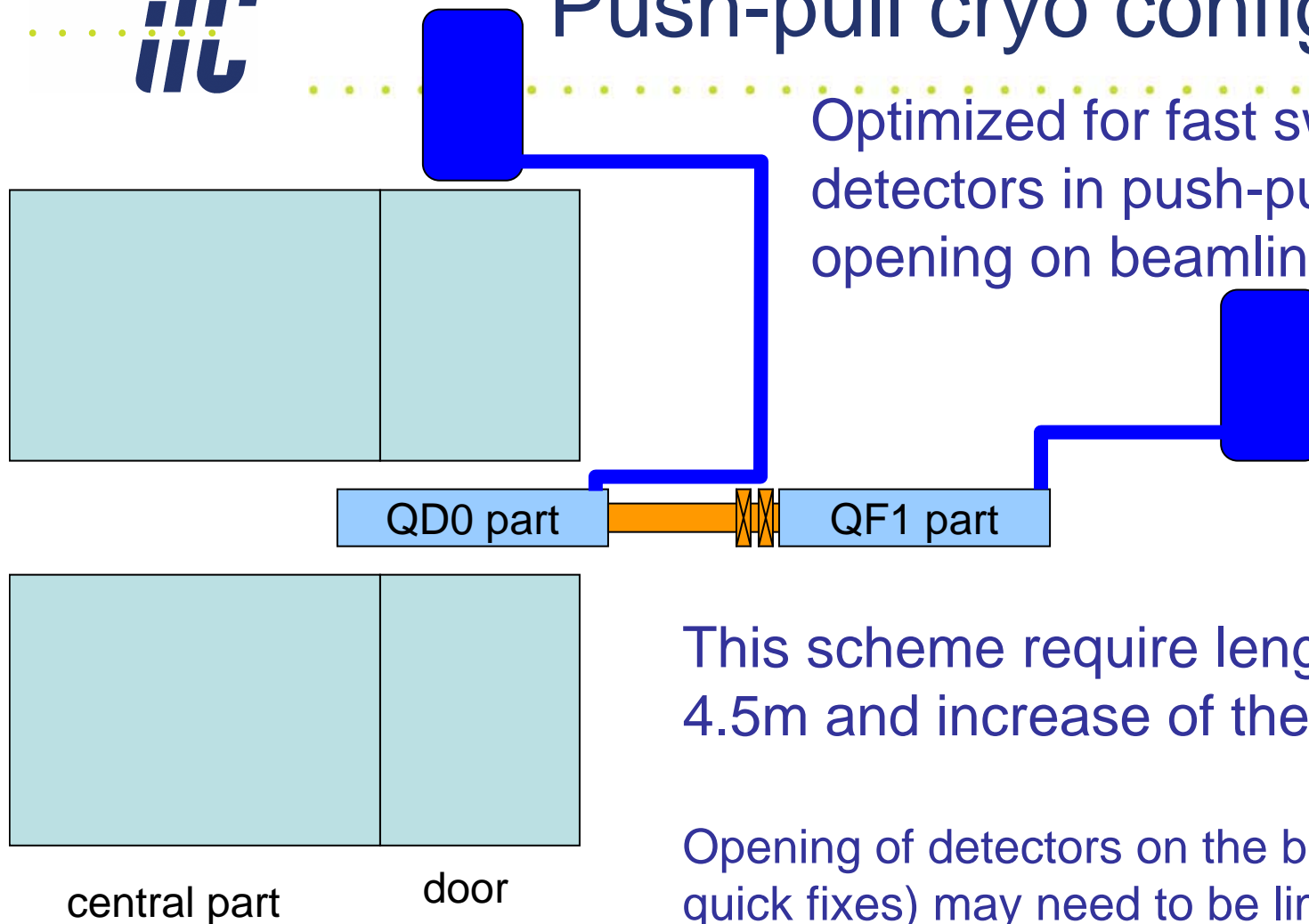

This scheme require lengthening L^* to 4.5m and increase of the inner FD drift

Opening of detectors on the beamline (for quick fixes) may need to be limited to a smaller opening than what could be done in off-beamline position



Detector sizes & opening on beamline

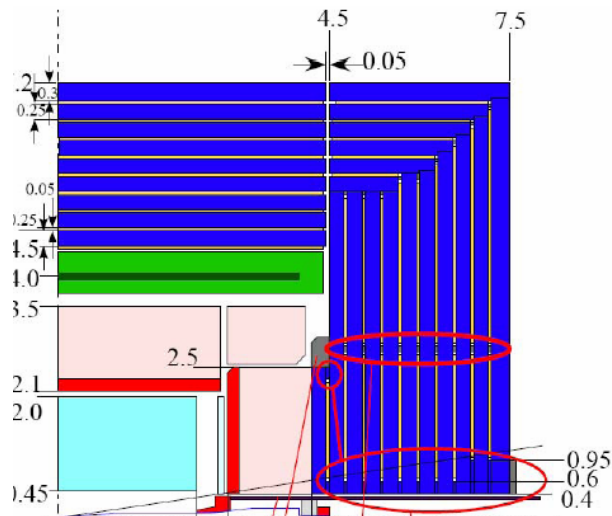

GLD

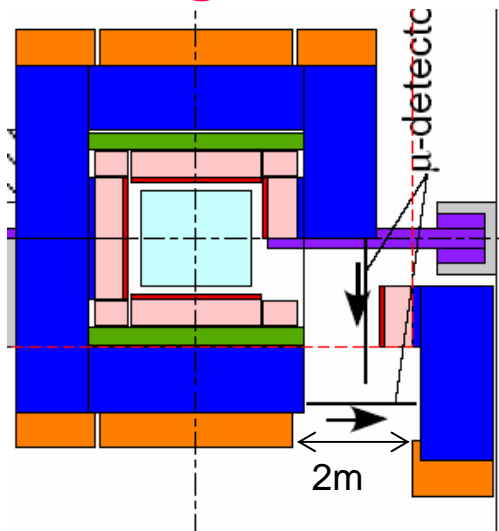

	SiD	GLD
IP	0	0
End of detector	5.9	7.5
Desired opening	2	2.5
Warm section need to end after z=	7.9	10
Reduced opening for fast fixes	2	1.5
Warm section need to end after z=	7.9	9

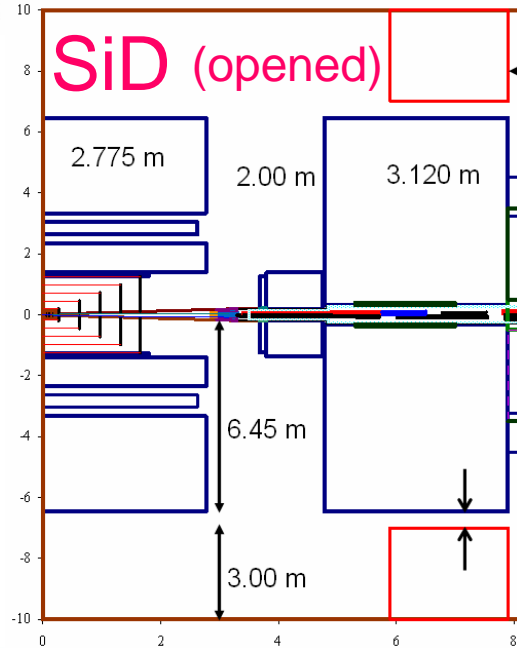

Since opening of detectors on the beamline is intended only for quick fixes, the required width for opening may be smaller than for opening off-beamline



Standard FD with $L^*=3.51\text{m}$

IP	0	0
D0	3.51	3.51
QD0	2.2	5.71
D1A	0.15	5.86
SD0	0.6	6.46
warm start	0	6.46
warm end	1.35	7.81
cold start	0	7.81
QF1	2	9.81
D1C	0.15	9.96
SF1	0.3	10.26

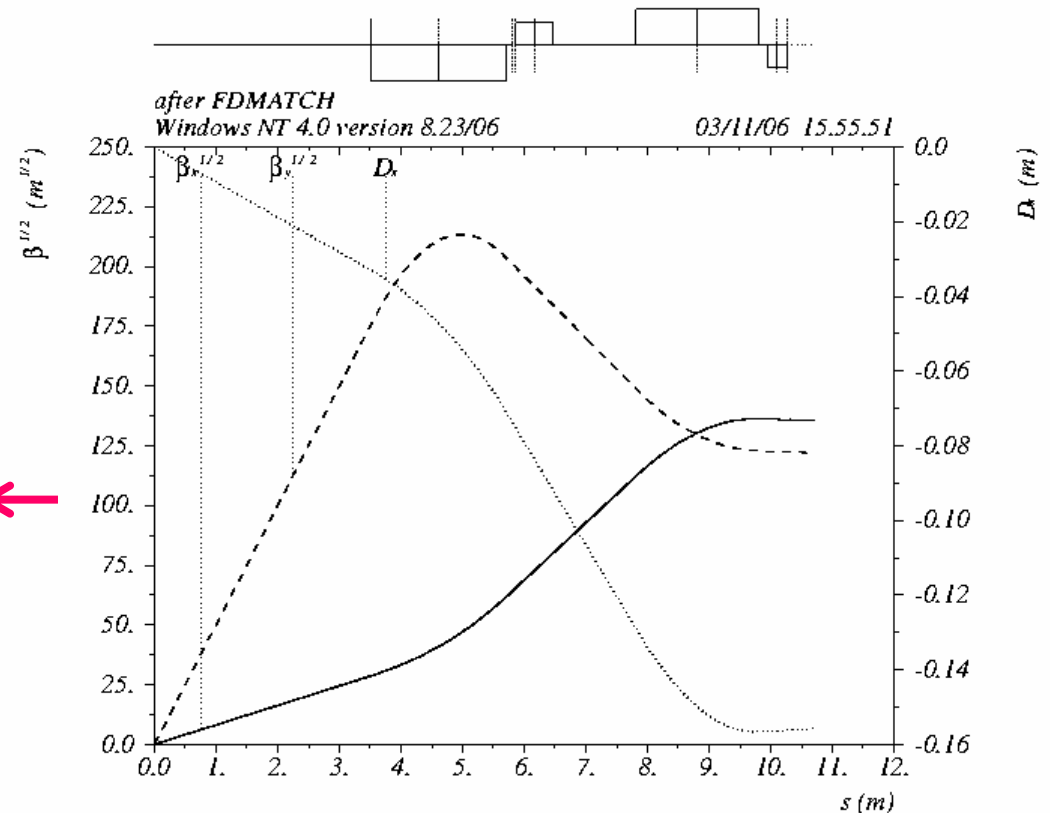

End of warm drift is extended only by 0.3m outside of largest detector in its closed position. Space may be not sufficient even without detector opening on the beamline. (Shown are ideal magnet positions, but due to warm-cold transitions, magnets take more space).

FD with $L^*=4.5\text{m}$

IP	0	0
D0	4.5	4.5
QD0	2.2	6.7
D1A	0.15	6.85
SD0	0.6	7.45
warm start	0	7.45
warm end	1.35	8.8
cold start	0	8.8
QF1	2	10.8
D1C	0.15	10.95
SF1	0.3	11.25

End of warm drift is extended by 1.3m outside of largest detector in its closed position.
Possible opening on beamline is less than 0.8m for GLD.

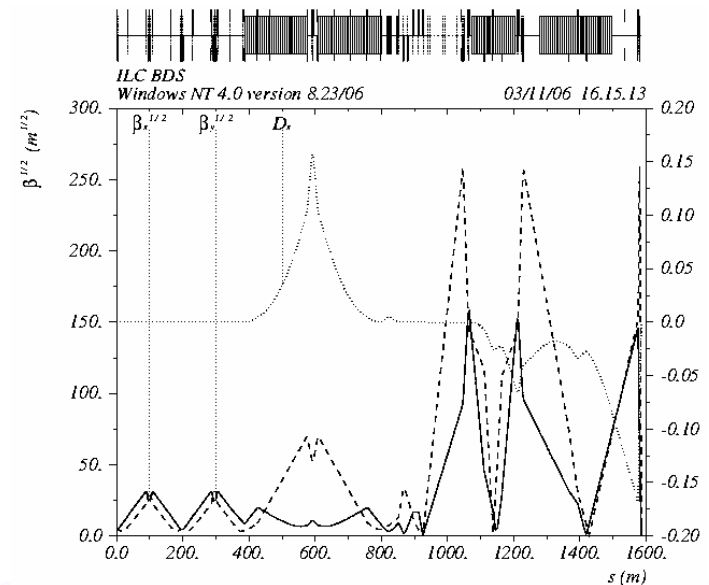
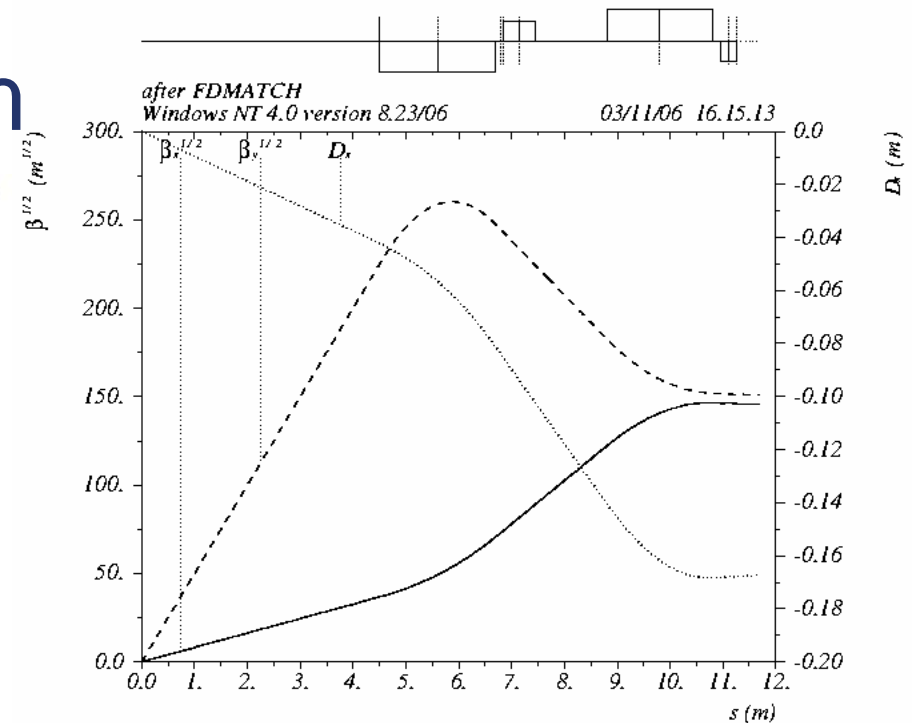



FD with $L^*=4.5\text{m}$ & lengthened warm drift section by $+0.7\text{m}$

IP	0	0
D0	4.5	4.5
QD0	2.2	6.7
D1A	0.15	6.85
SD0	0.6	7.45
warm start	0	7.45
warm end	2.05	9.5
cold start	0	9.5
QF1	2	11.5
D1C	0.15	11.65
SF1	0.3	11.95



Detector opened on beamline (GLD opening reduced to 1.5m) still leaves 0.5m of not-overlapped space for config.C

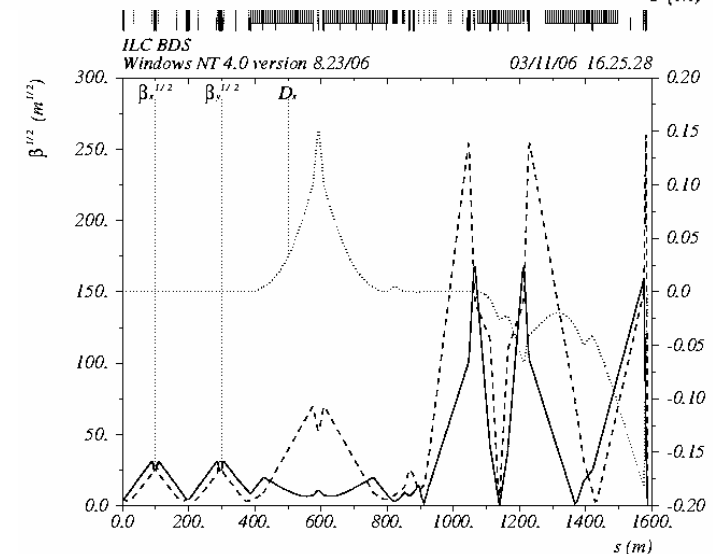
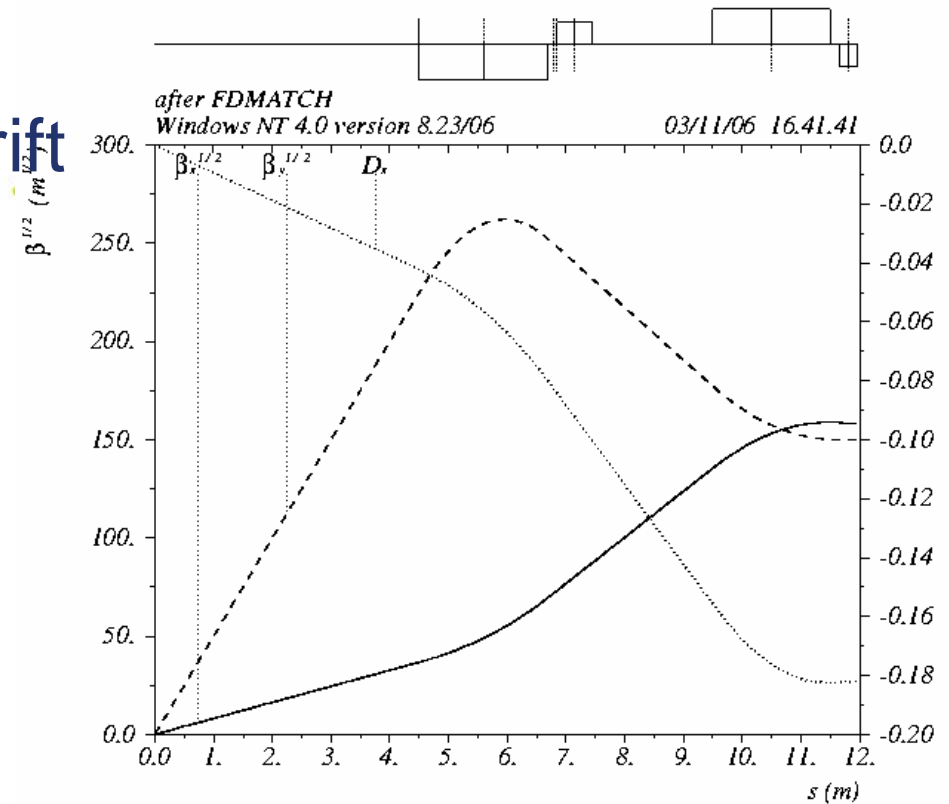

ilc Working progress on IR design...

Illustration of ongoing work...
Designs are tentative & evolving

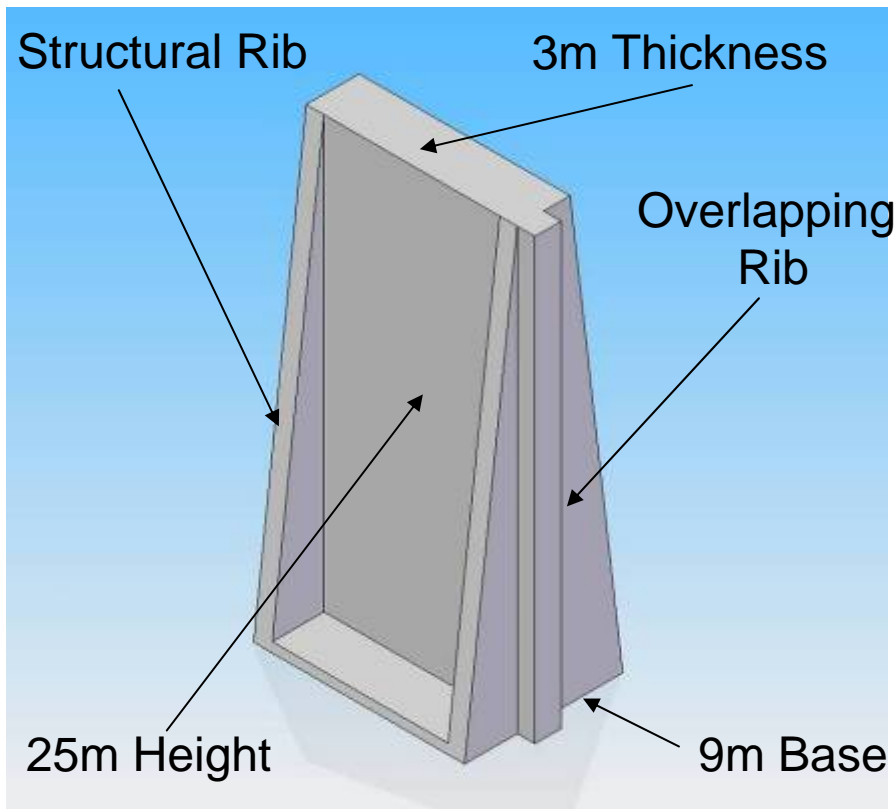

John Amann

<http://ilcagenda.cern.ch/conferenceDisplay.py?confId=1201>

<http://ilcagenda.cern.ch/conferenceDisplay.py?confId=1225>

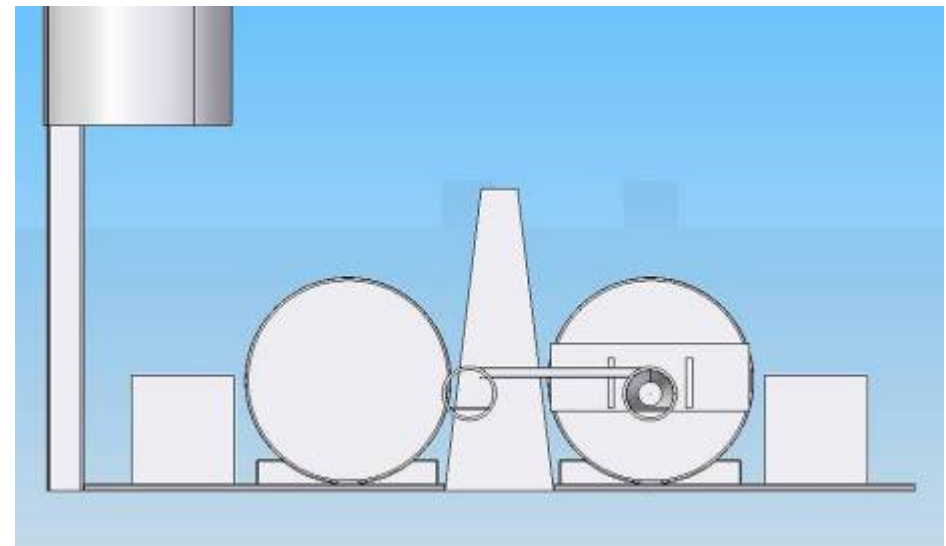
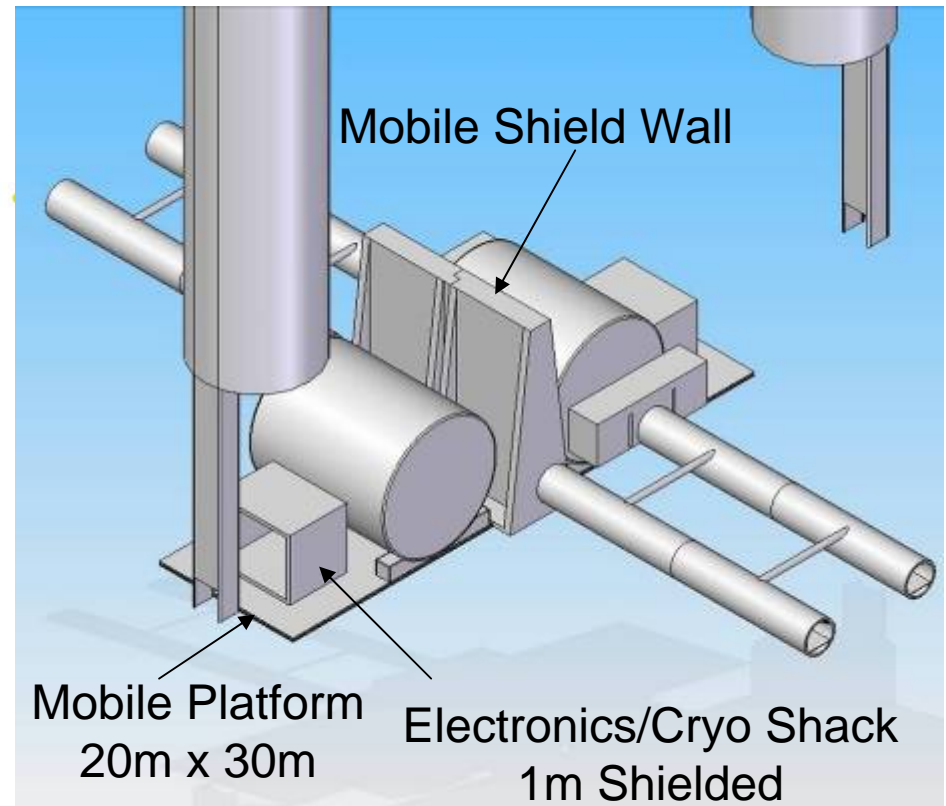

ilc Working progress on IR design...

Illustration of ongoing work...
Designs are tentative & evolving

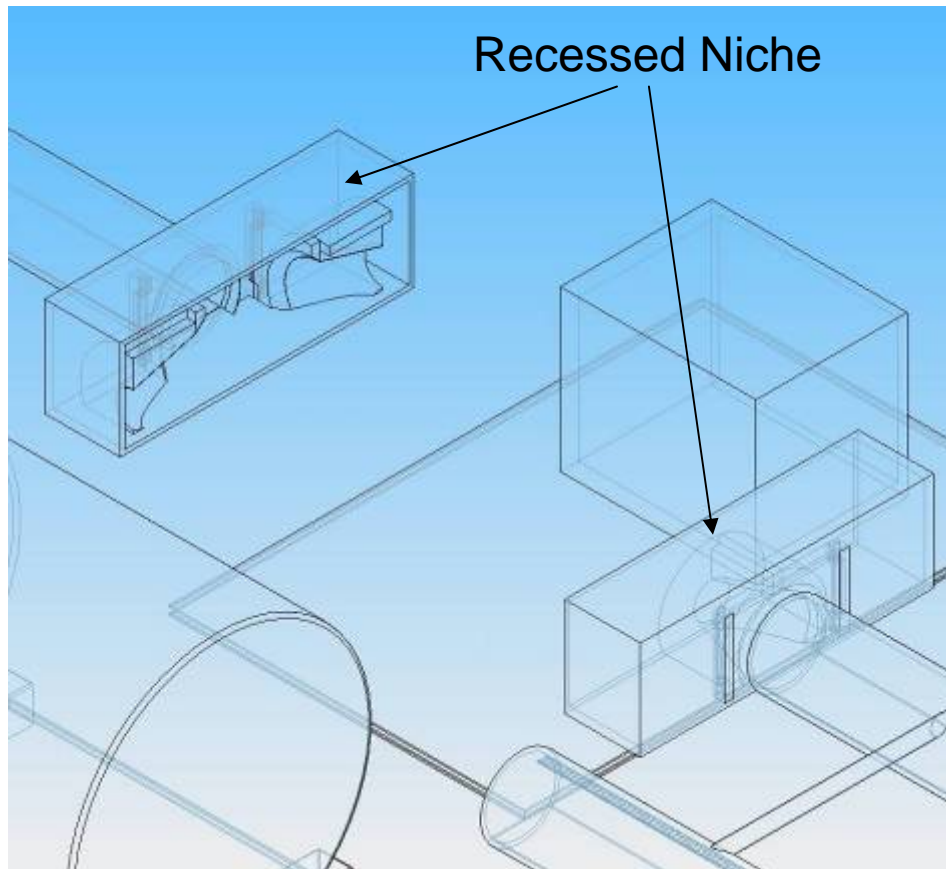

John Amann

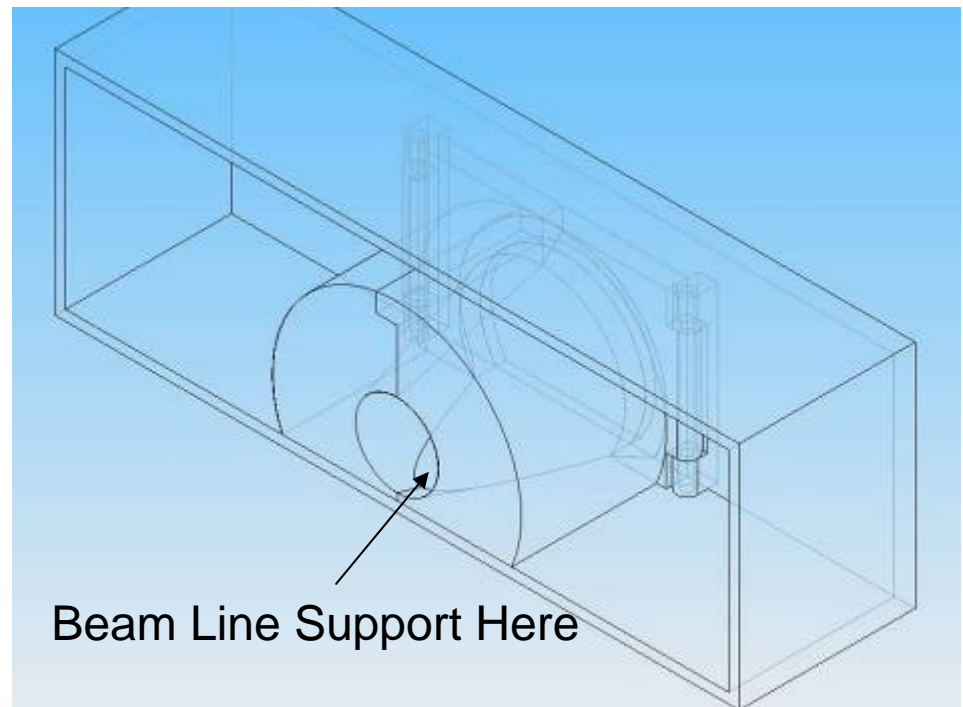
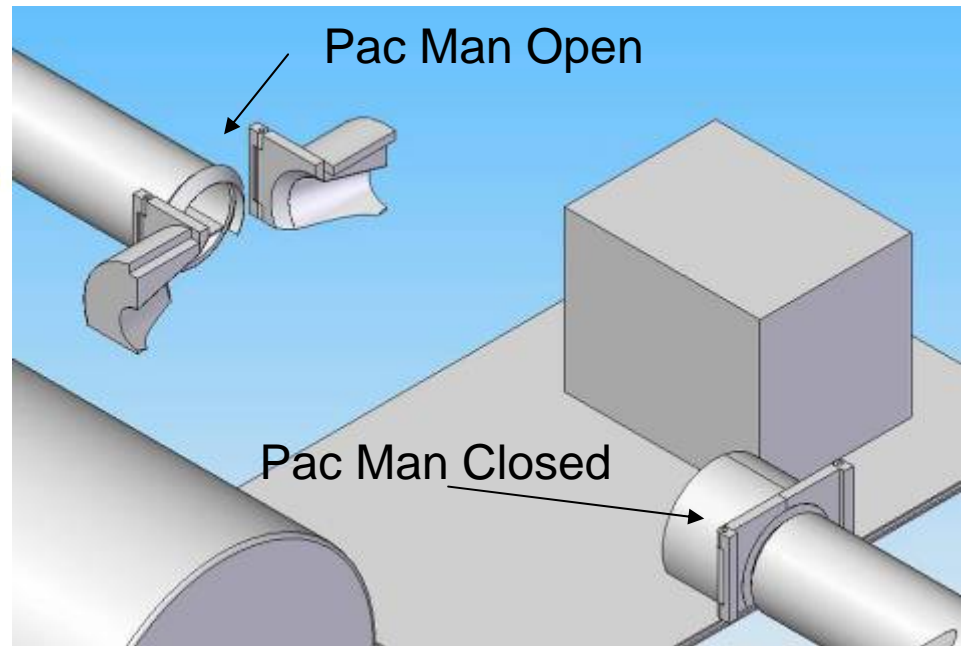



Working progress on IR design...

Illustration of ongoing work...
Designs are tentative & evolving

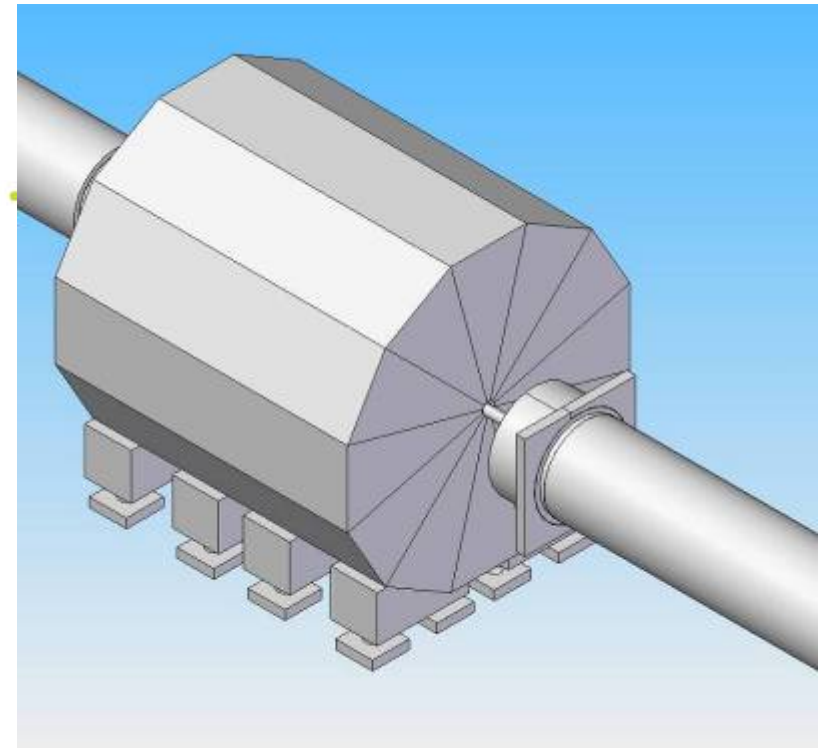

Line of Sight Gap Needs Overlap

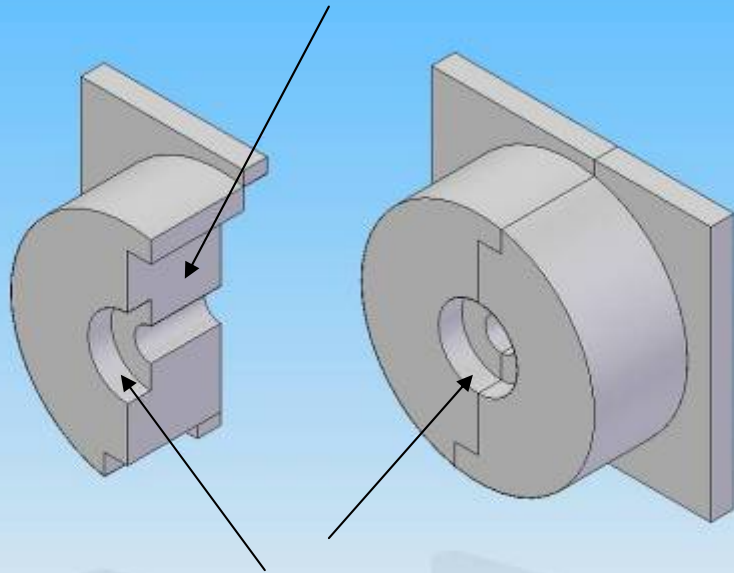

Gap Sealing Recess for Detector

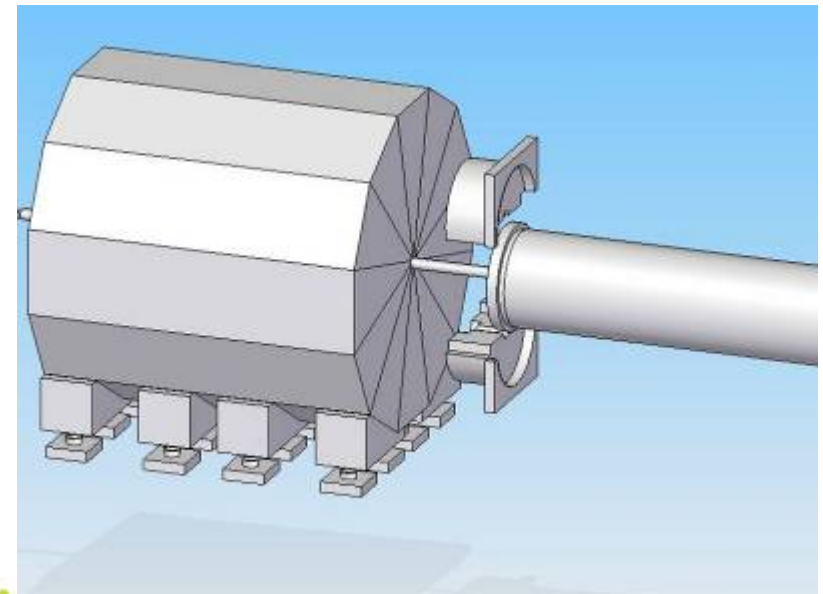

John Amann



Working progress on IR design...



CMS shield opened



SLD pacman closed



pacman open

Looking into experience of existing machines...



door tunnel



pacman opened



pacman closed

Sep 21-Nov 6, 06

Global Design Effort

push-pull: 55



Size of IR hall for push-pull

- Length of collider hall (presently 110m) may need to be somewhat longer (~10-15%?) to accommodate, for example, detector service platforms and wider shielding wall
- Height (depth) of collider hall may need to be larger (by ~1.5-2m?) to accommodate, e.g., the platform supporting the whole detector (if such platform would found desirable)
- This length and height adjustments may result in increase of IR hall volume by ~15-20%



Emphasis on alignment monitoring

- Foresee the infrastructure for alignment monitoring of the IR hall, detector and accelerator components during and after the move
- This may require
 - **survey galleries**
 - **stretched wire system**
 - **hydrostatic leveling systems**
 - **interferometer systems**



Schedule for the design goal

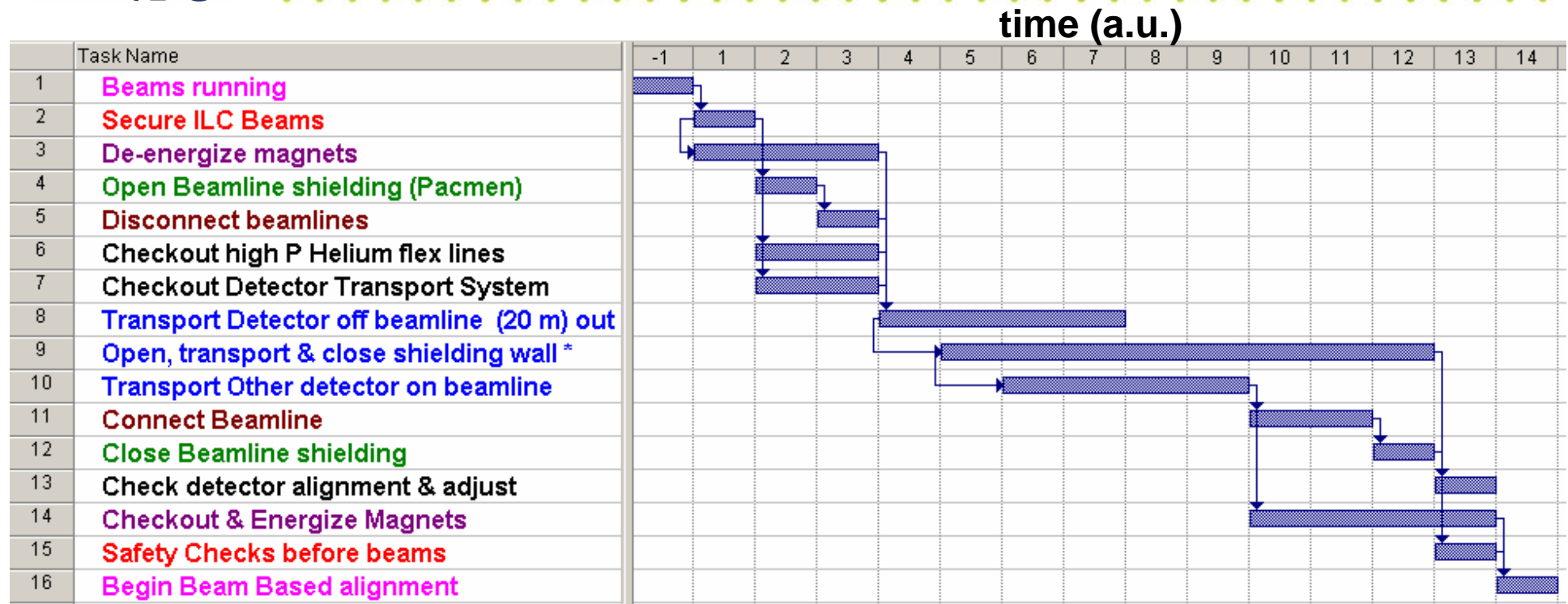

- Draft schedule showing sequence and overlap of tasks [modified after M. Breidenbach]
- Design goal for subsystems: make the unit of time to be about an hour
- Will allow switching detectors as often as every month

*) if shielding wall is needed and present



Luminosity sharing & efficiency

- Assumptions in the two IR baseline:
 - machine is designed to allow switch between detectors on the timescale of weeks-months
 - estimated switch-over time, for realignment of BDS beamlines and their retuning, is 3-4 days
 - the pulse-to-pulse switch-over, which is sometime mentioned, is not supported by hardware of present ILC baseline
- Considerations for single IR
 - it may be argued that recovery of full luminosity in a BDS that was OFF only for a day, should be rapid



Schedule considerations

- Consider design goal for subsystems 0.5-1 day for detector exchange operation
- Depending on the mode of operation, the desired frequency and duration of exchange may vary
 - **in precision scan, longer intervals and switch-over may be fine**
 - **in discovery mode, rapid exchanges are more essential**
- Switching over in ~3 days (to full luminosity) would also be sufficiently fast
- Further detailed study, including cost optimization, would clarify where in the range of ~0.5-3 days the design goal should be placed



CFS designs for two IRs

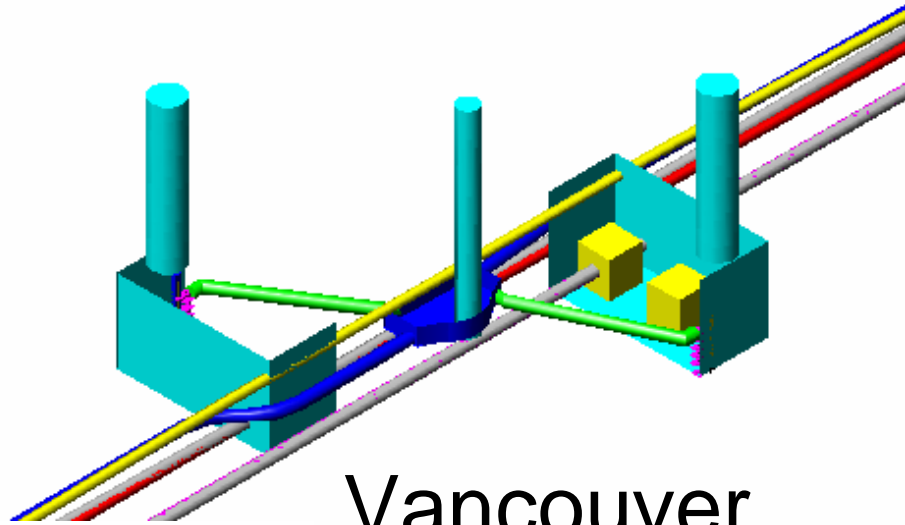

Vancouver

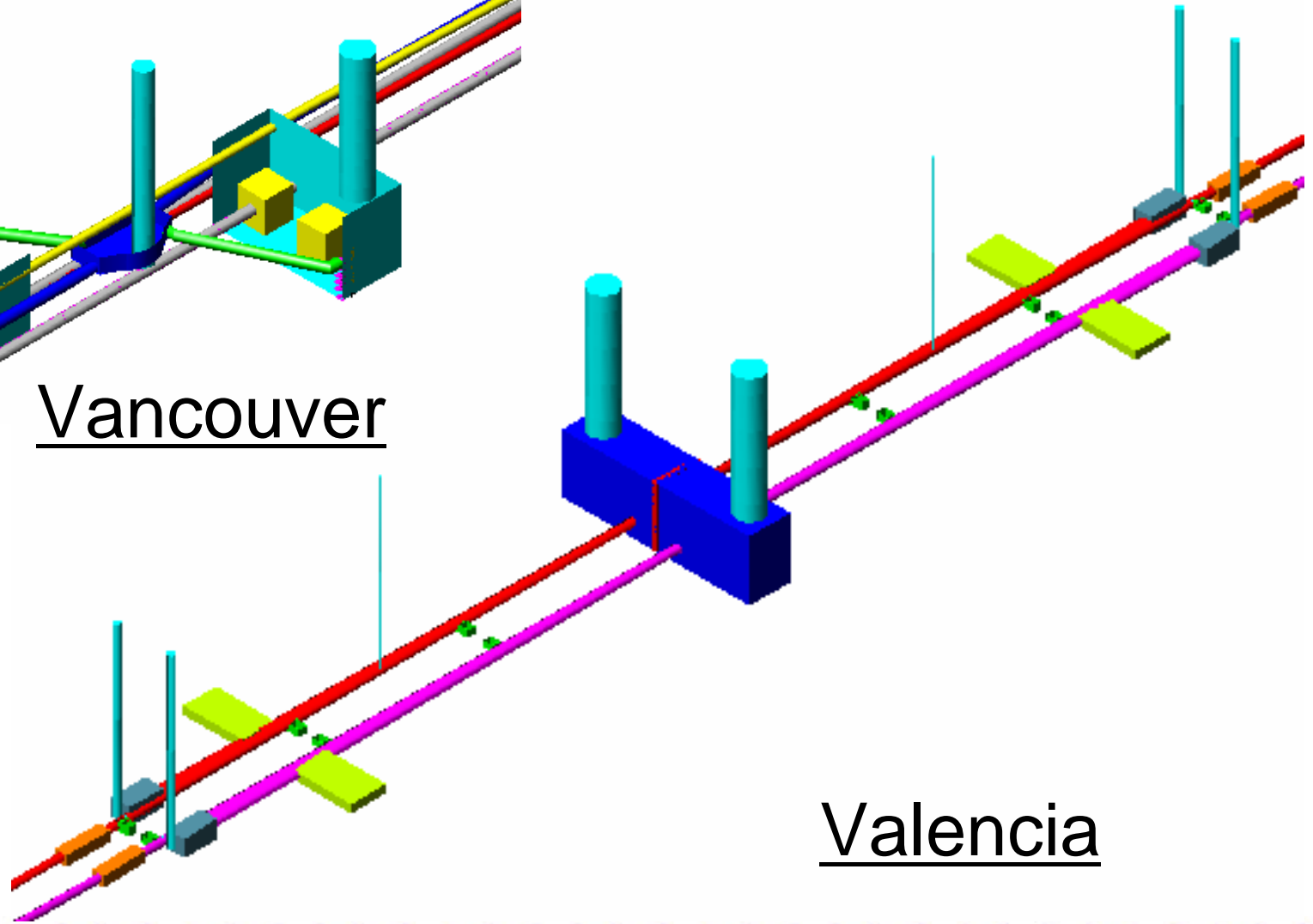

Valencia



Single BDS & central DR

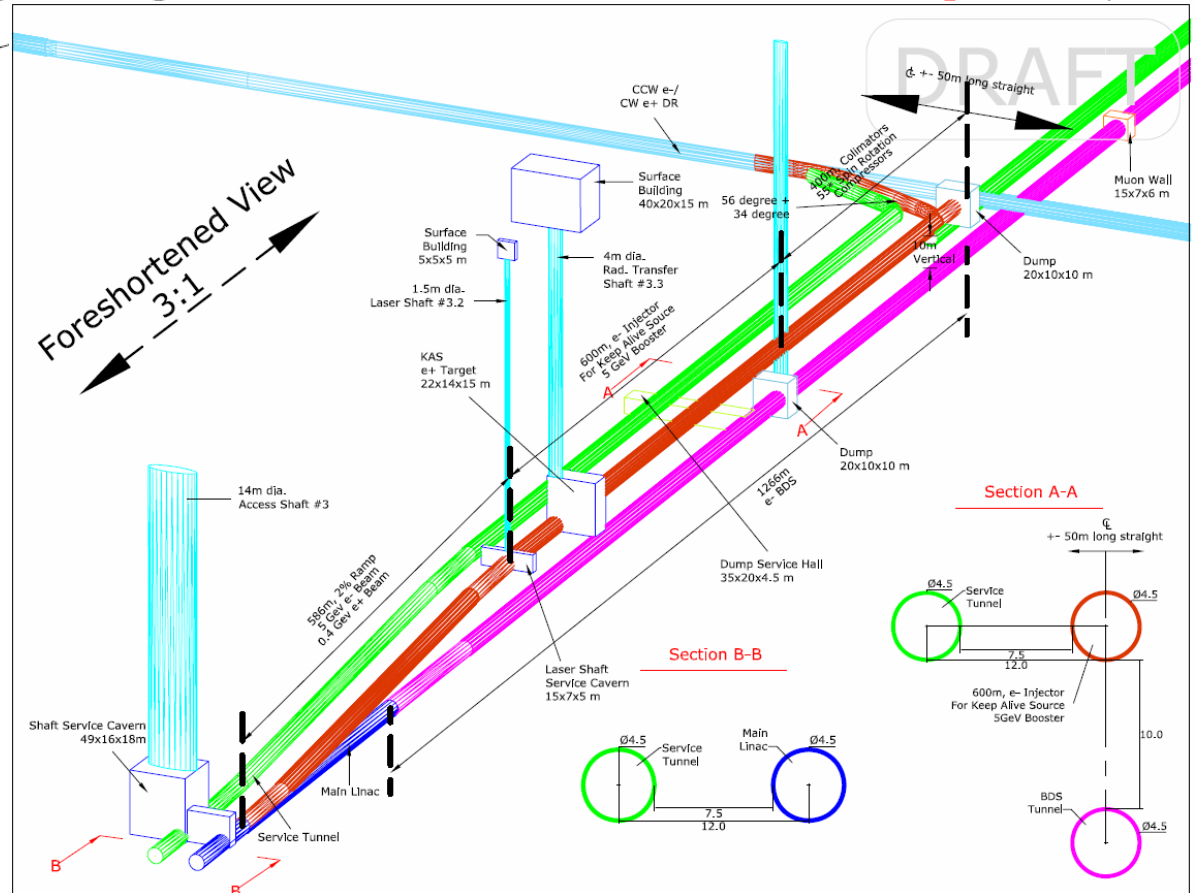
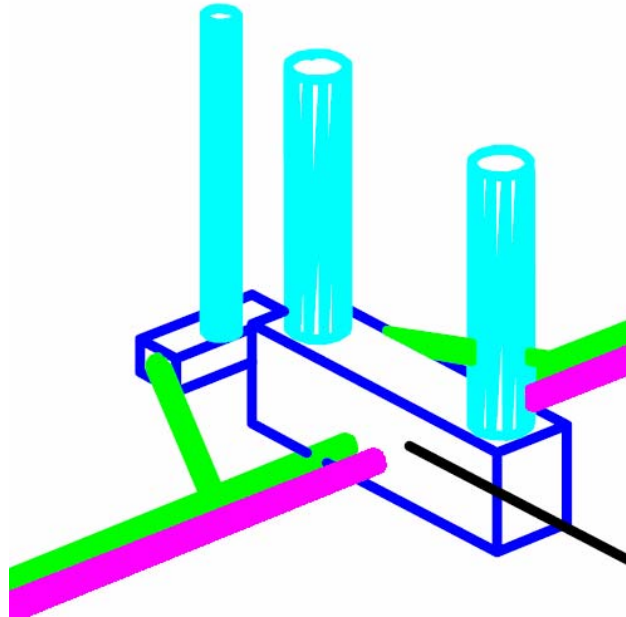
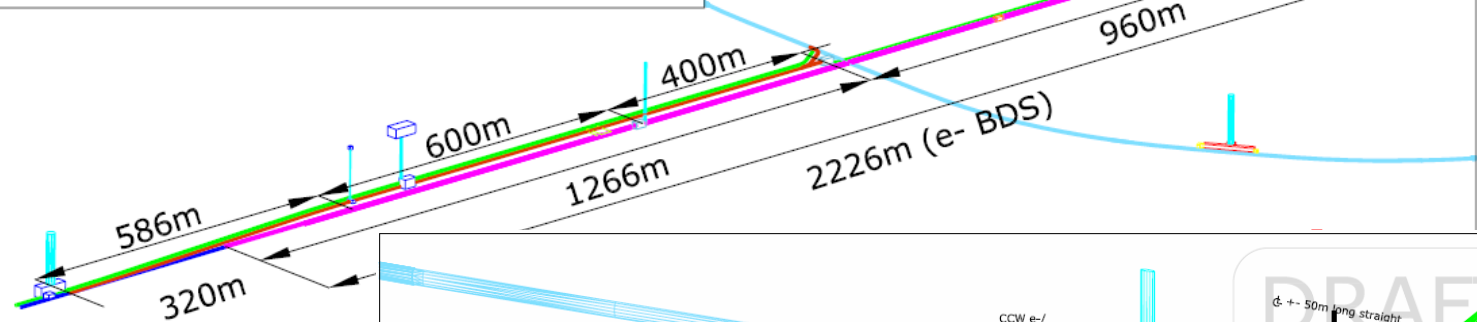
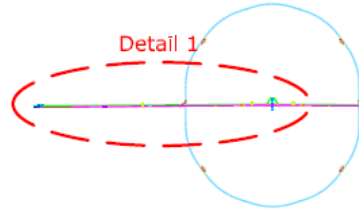

Sep 21-Nov 6, 06

Global Design Effort

push-pull: 62



Summary

- At the end of September 2006, technical evaluation of push-pull option started by an extended task force, which included detector and accelerator experts in ILC community and beyond. More than 60 people were involved.
- Many technical questions have tentative answers
- Detailed studies and engineering design are needed, which surely could not be done in such short time scale
- Fundamentally, the push-pull option should be feasible, provided careful design and sufficient R&D resources