

ILC Damping Rings R&D Workshop - ILCDR06
September 26-28, 2006 at Cornell University

FAST KICKERS R&D @ LNF-INFN

Fabio Marcellini

*for the LNF fast kickers study group**

** D. Alesini, F. Marcellini P. Raimondi, S. Guiducci.*

PRESENTATION OUTLINE

- 1) General considerations on kickers with circular and elliptical cross section of the stripline.
- 2) Correction of the deflecting field flatness by tapering the stripline;
Other advantages of tapers.
- 3) Design of the stripline kicker for the DAΦNE injection upgrade.
- 4) R&D and HV tests on kicker prototypes, feedthroughs and pulser (supplied by FID GmbH) @ LNF.
- 5) Future R&D plans (tomorrow).

1) General considerations: transverse field profile properties (1/2)

CIRCULAR CROSS SECTION (50 Ω)

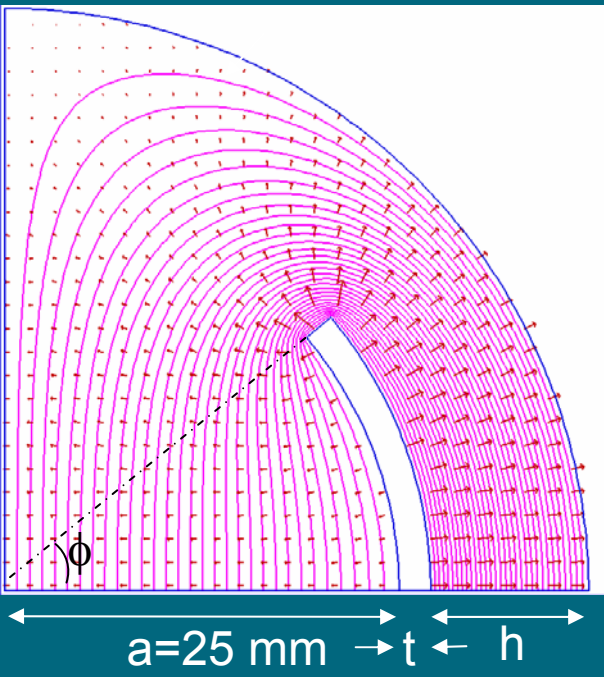

Horizontal component of the electric field (E_T) on the kicker axis as a function of the electrode coverage angle.

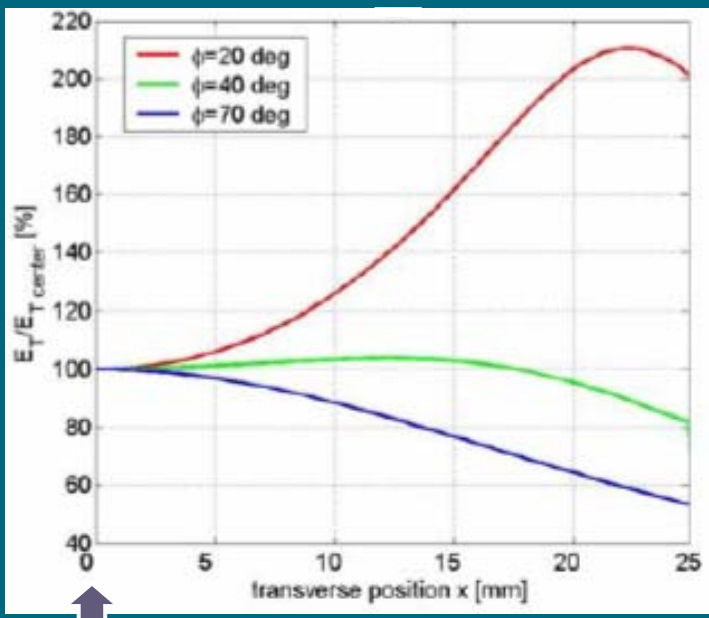
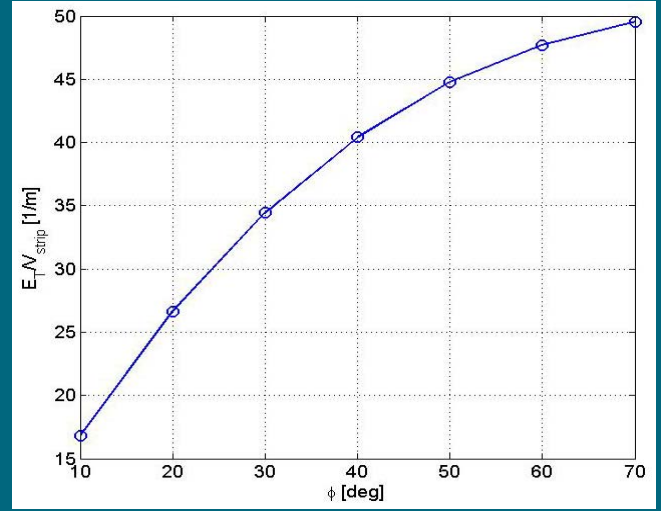

Horizontal component of the electric field (E_T) along the horizontal axis of the kicker cross section. The value is normalized to the value assumed by E_T on the center of the structure. Two different coverage angles for the electrode (20, 40 and 70 deg) are considered.

↑
kicker axis

1) General considerations: transverse field profile properties (2/2)

ELLIPTICAL CROSS SECTIONS (50 Ω)

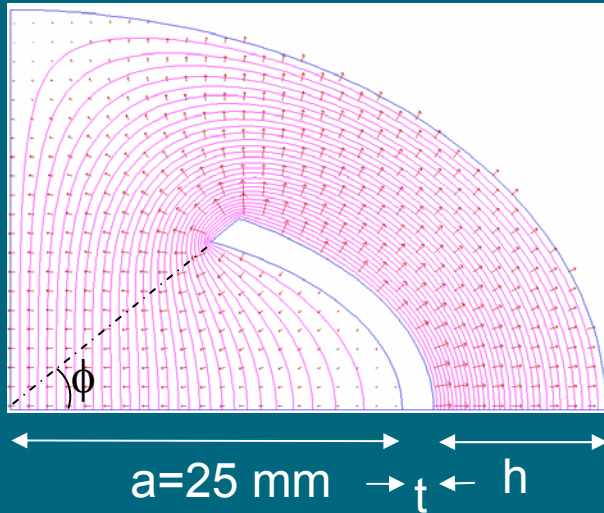

Horizontal component of the electric field (E_T) on the kicker axis as a function of the electrode coverage angle (Blue: elliptical section; red: circular section). The efficiency of elliptical geometries is higher.

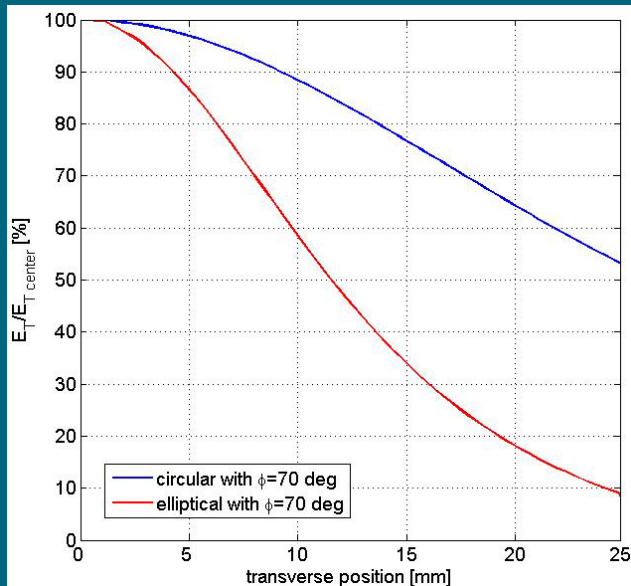
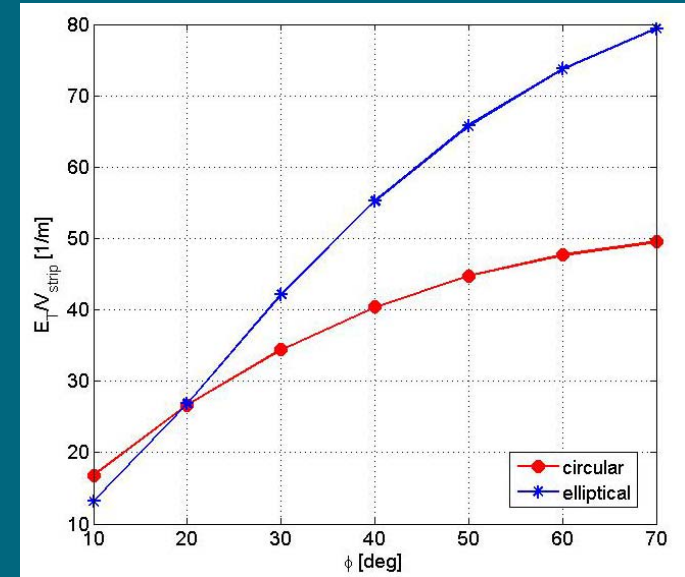

Normalized value of the horizontal component of the electric field (E_T) along the horizontal axis of the kicker cross section. The considered coverage angle is 70 deg both for the elliptical cross section (red) and for the circular section (blue).

1) General considerations: kicker length and pulse length

L =kicker length
 T_r =rise time length
 T_f =flat top length
 σ_B =bunch length
 T_B =bunch spacing

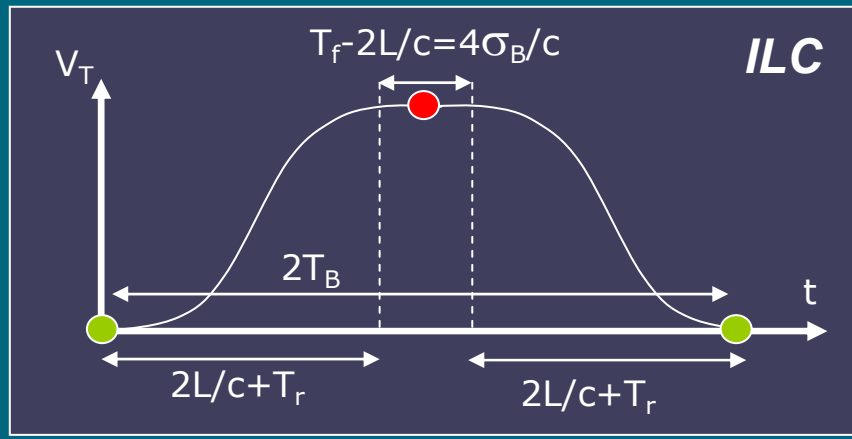
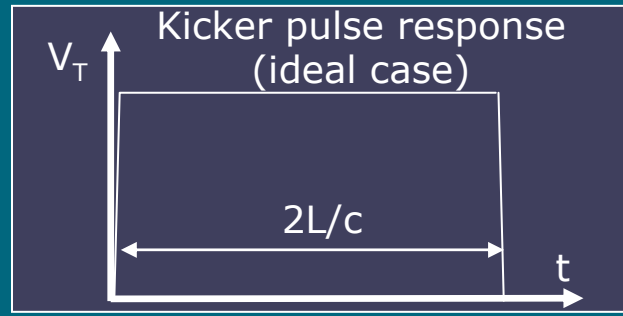
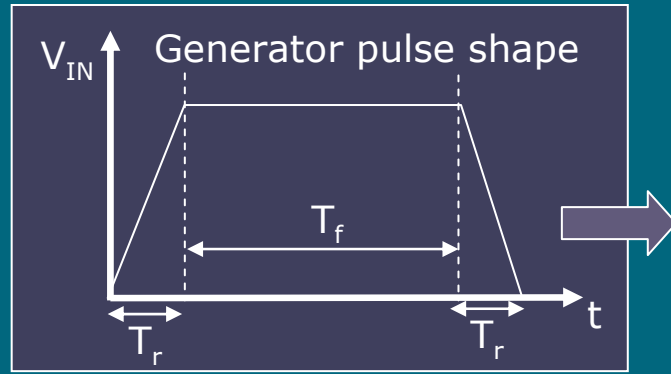

● Injected bunch
● Stored bunches

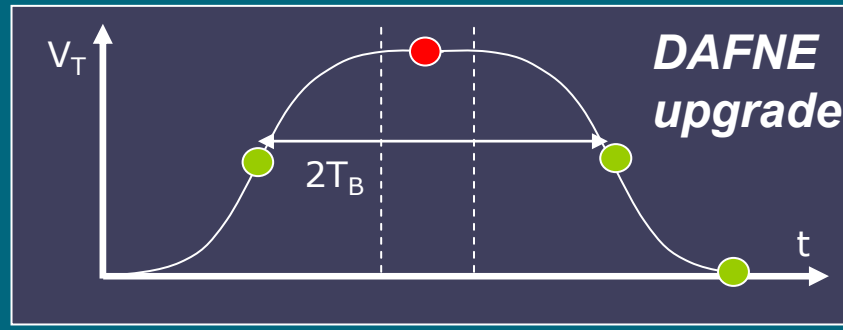

assuming $T_r=300\text{ps}$	DAFNE
E [GeV]	0.51
T_B [ns]	2.7
σ_B [mm]	35
Defl. [mrad]	5
L [cm]	73
T_f [ns]	5.3
σ_x [mm] @ septum and kicker	2
σ_y [mm] @ septum and kicker	1

2) Correction of the deflecting field flatness using tapers (1/2)

- a) **Tapers** are usually used to avoid abrupt steps in the section of the vacuum chamber in order to **reduce the intensity of wakefields** and HOM (impedance of the machine).



- b) The **uniformity of the deflection** depends on the coverage angle.

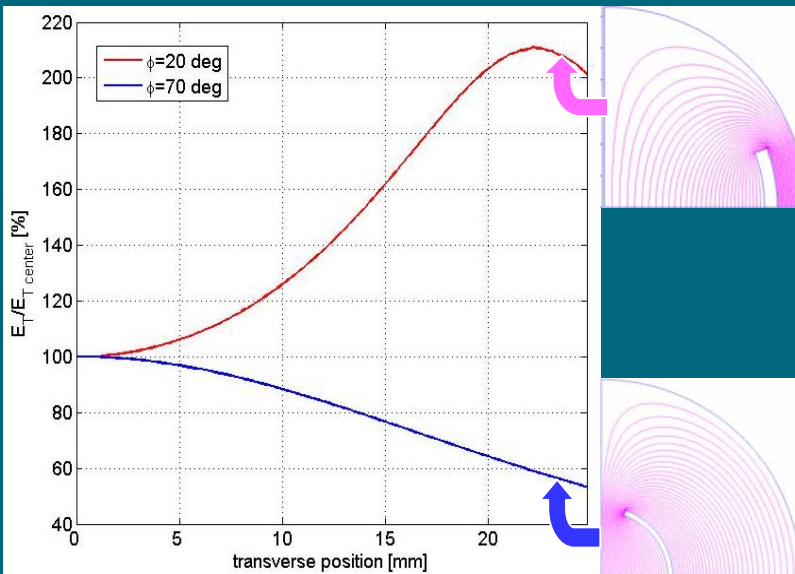

Tapering the transition between the kicker structure and the adjacent beam pipe it is possible to minimize:

- The non uniformity of transverse deflection as a function of the transverse position;
- The contribution of the kicker to the impedance of the machine.

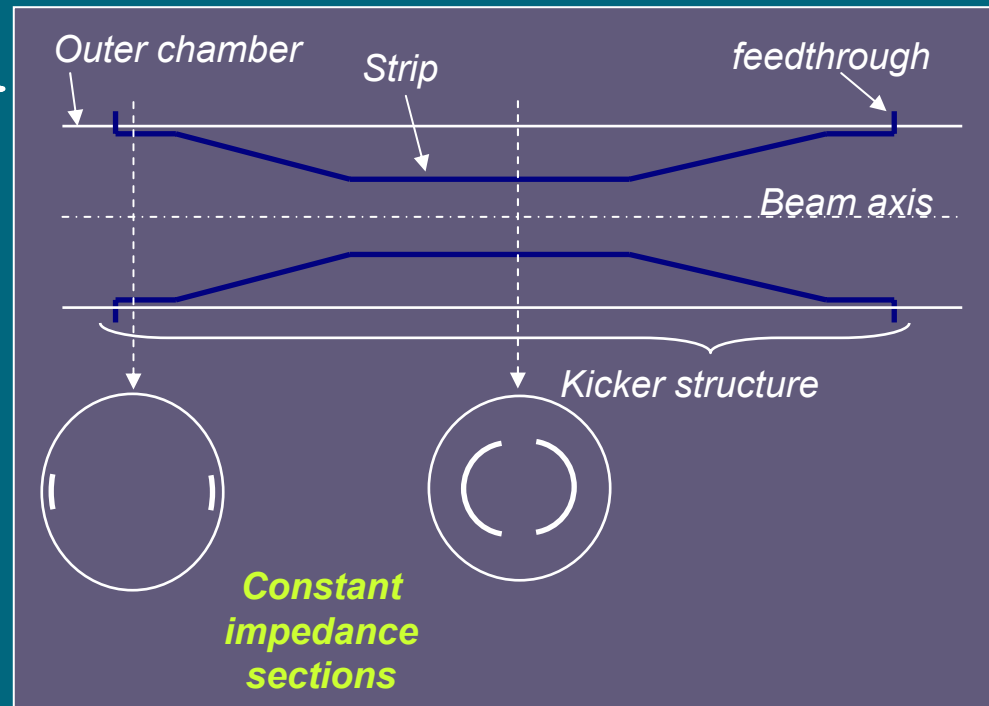

2) Correction of the deflecting field flatness using tapers (2/2)

A different possible scheme

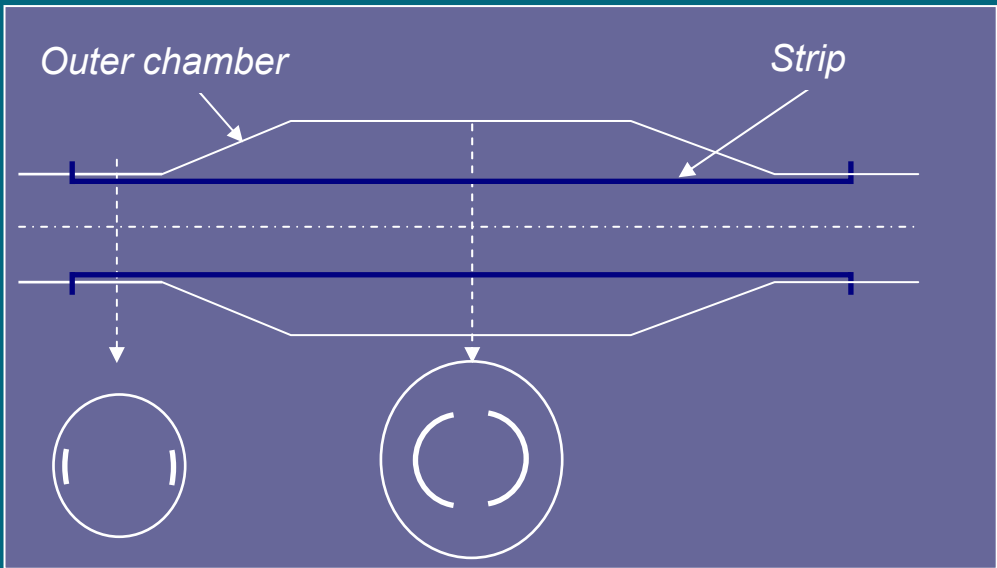

Furthermore:

smoother transition between feedthrough coax line and strip line



smaller reflection coefficient at high frequency (short pulses)

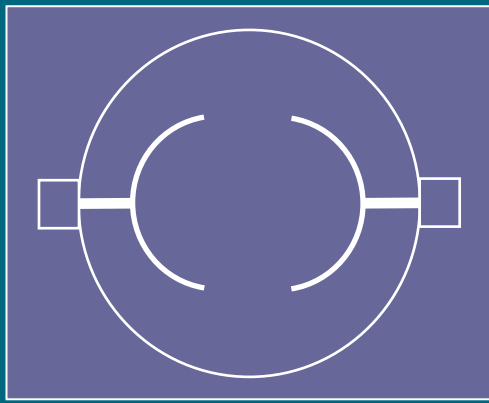
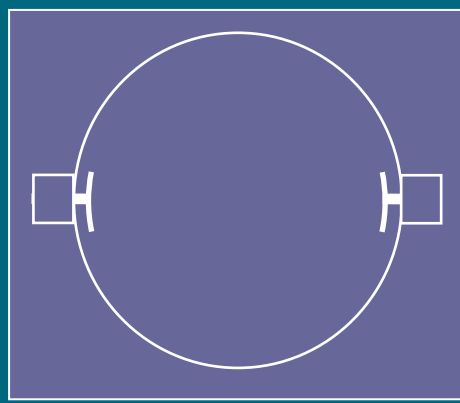

Tapering is applicable to both cylindrical and elliptical geometries

3) Design of the DAΦNE kicker: transverse and longitudinal geometry

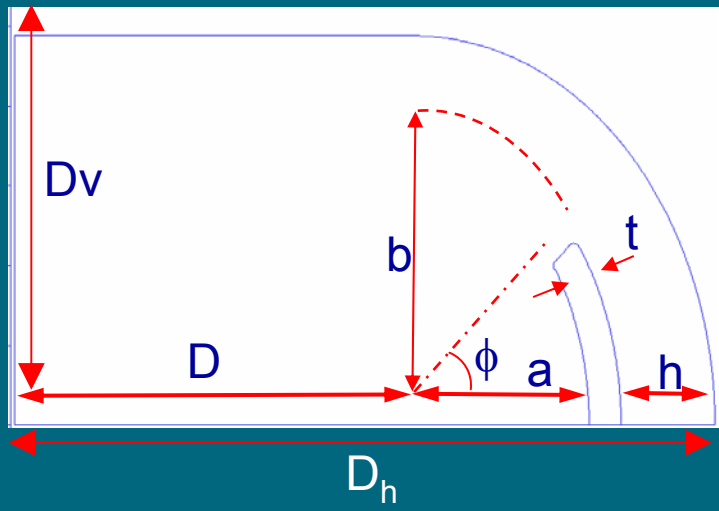

- a) The **elliptical geometry** has been chosen to minimize the variation of the vertical dimension of the beam pipe between the injection region and the adjacent dipole region;
- b) In each section along the structure D_h is a constant and D_v changes;
- c) In each section ϕ has been chosen to have **constant characteristic impedance** of the line (50Ω);
- d) The value of a and b are the same for each sections and have been optimized together with the length L_k and L_T in order to contemporary achieve:
 - 1) optimum deflecting field uniformity over the horizontal coordinate;
 - 2) total “effective length” of the kicker compatible with the bunch spacing.

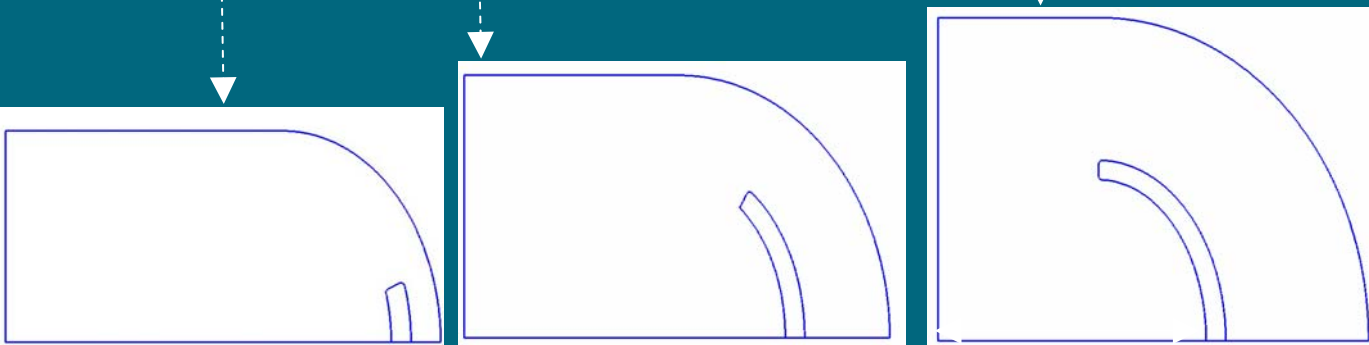
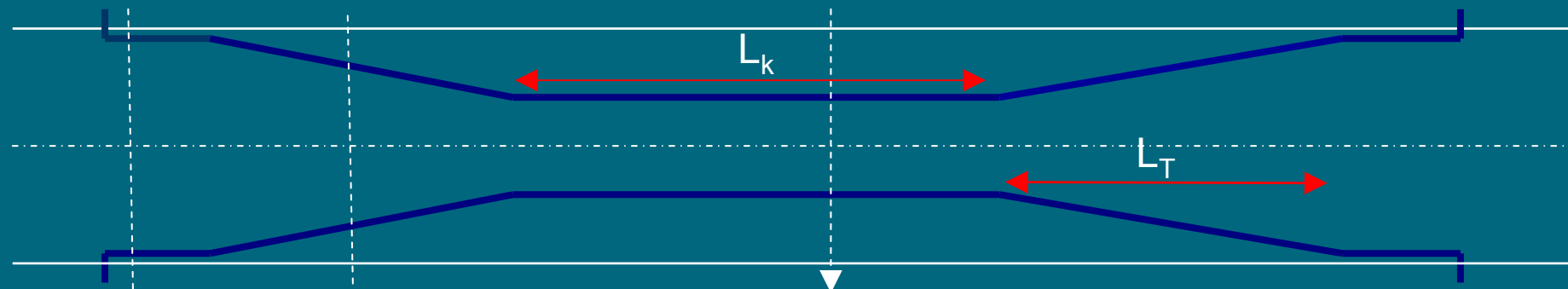

3) DAΦNE stripline kickers design: optimization procedure (1/2)

Choice of the optimum L_T/L_K for field flatness

2D simulations of different sections along the kicker longitudinal axis

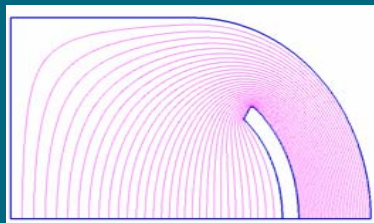

by interpolation

Construction of 3D map of the deflecting field

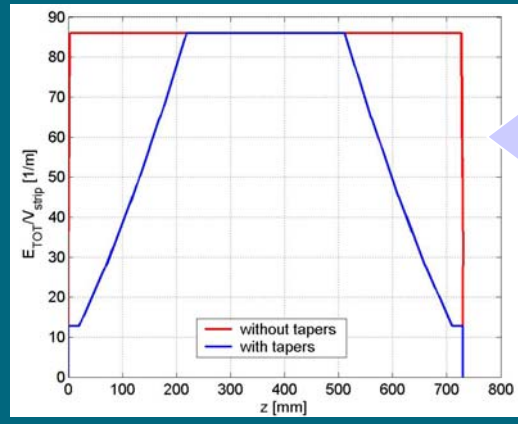
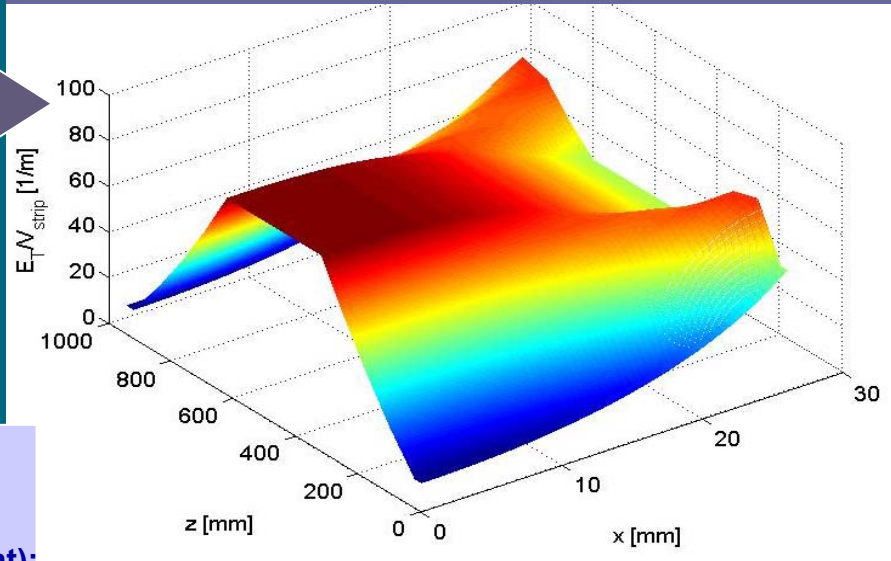

Straight, no tapers:
 $L_{TOT}=73 \text{ cm} \Rightarrow V=40 \text{ kV};$
With tapers (less efficient):
 $L_{TOT}=73 \text{ cm}, L_K=29 \text{ cm}, L_T=22 \text{ cm} \Rightarrow V=58 \text{ kV}$

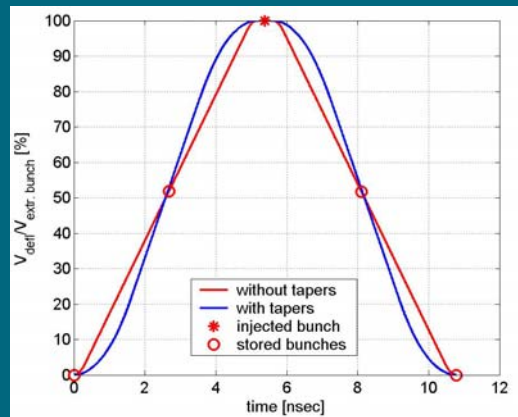

Field flatness by integration

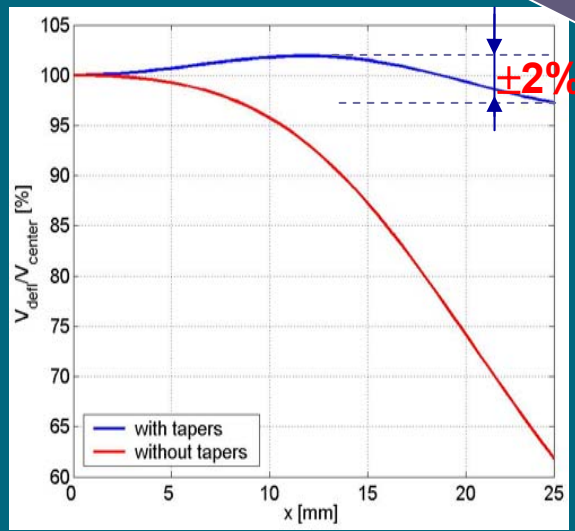

horizontal axis

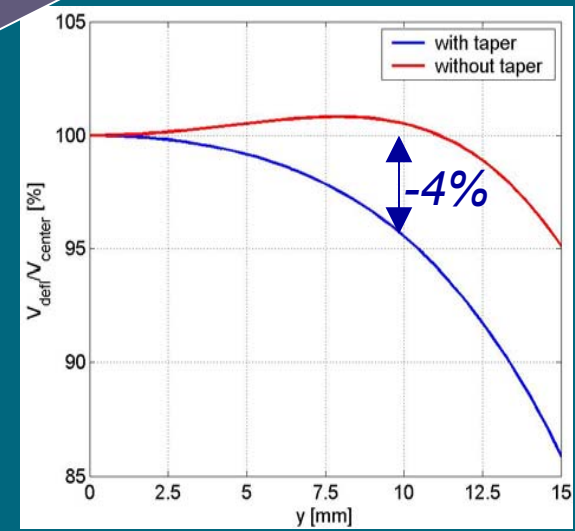

vertical axis

3) DAΦNE kicker design: optimization procedure (2/2)

L_T , L_k length tuning

Increasing the total length of tapered striplines to reduce the required voltage:

$$\begin{array}{ccc} L_{TOT}=73 \text{ cm} & \longrightarrow & L_{TOT}=94 \text{ cm} \\ V=58 \text{ kV} & & V=44 \text{ kV} \end{array}$$

As a consequence the kicker impulse response becomes a bit longer. The deflecting voltage as a function of time, which results from the convolution of a simplified model of the real input pulse with the kicker impulse response, spreads a bit over the two bunches that are two bucket away from the injected one.

Model of the real input pulse

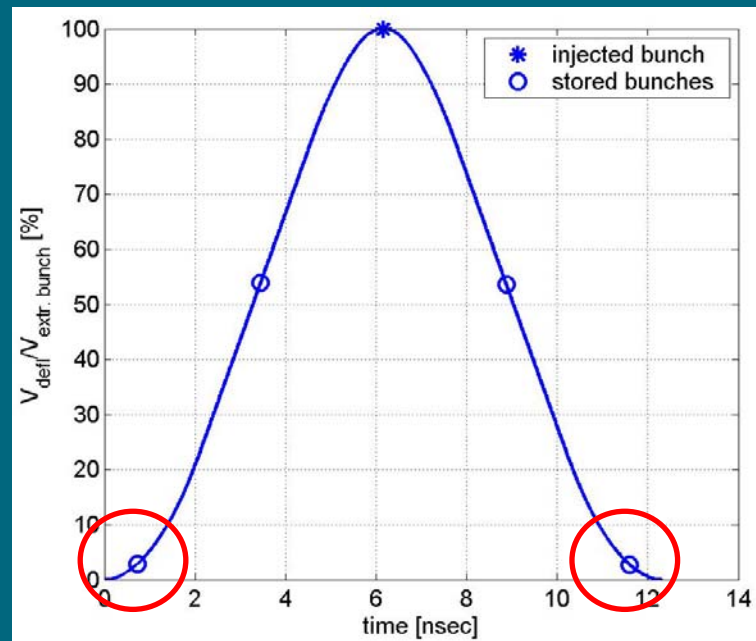
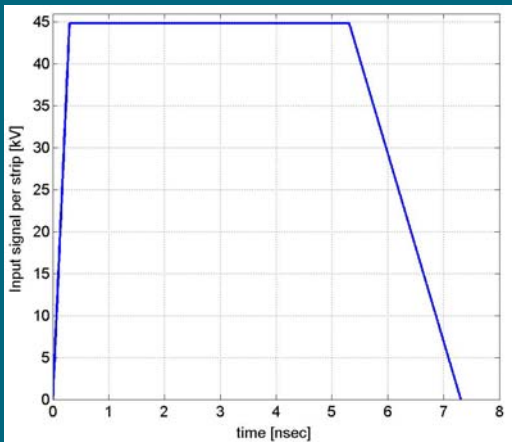

3) DAΦNE kicker design: 3D electromagnetic model (1/4)

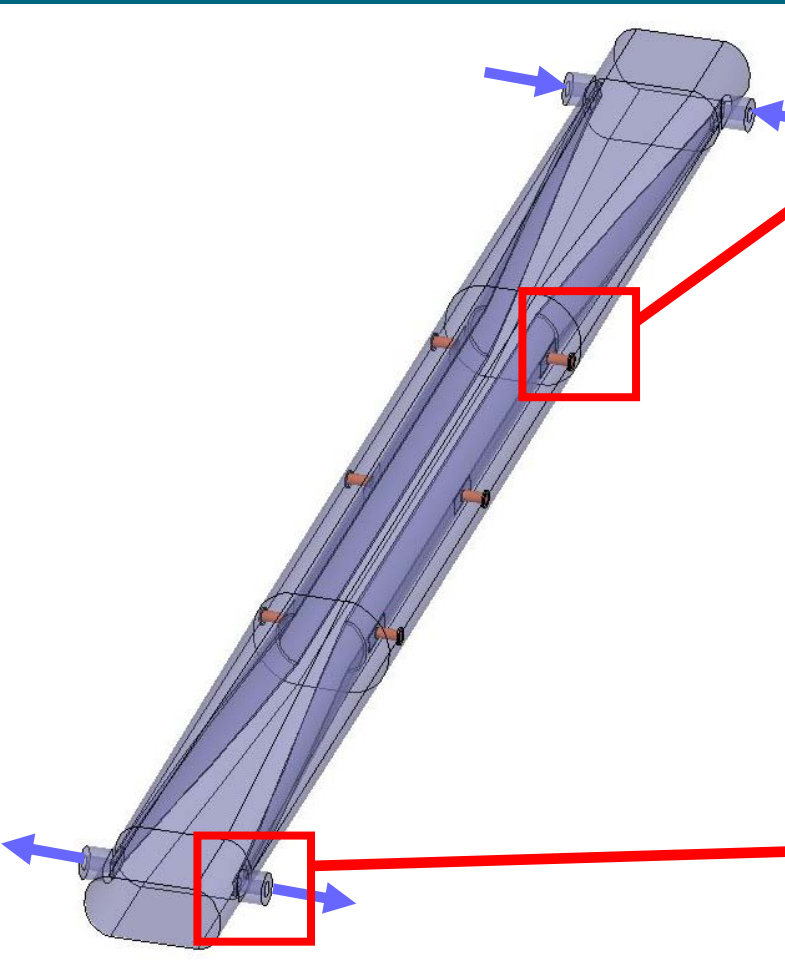

a) Effect of ceramic stand-off

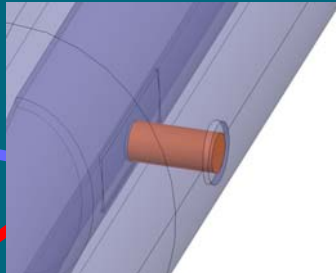

b) HOM studies



c) Real deflecting field calculation and frequency response

d) Coaxial-strip transition optimization and beam transfer impedance

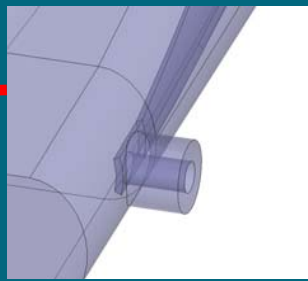

Optimization of the whole structure

3) DAΦNE kicker design: 3D electromagnetic model (2/4)

Deflecting field

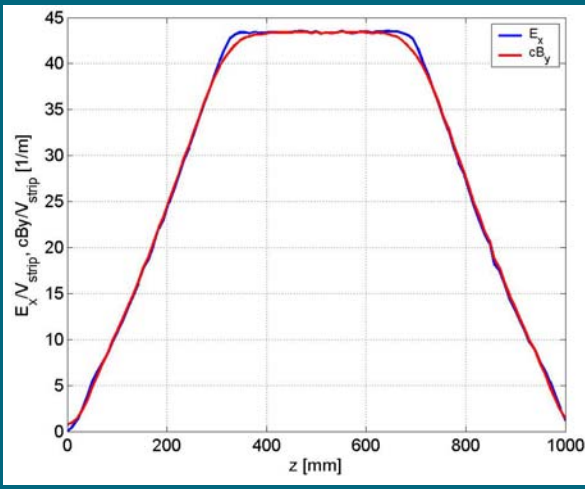

Reflection at the input coax port

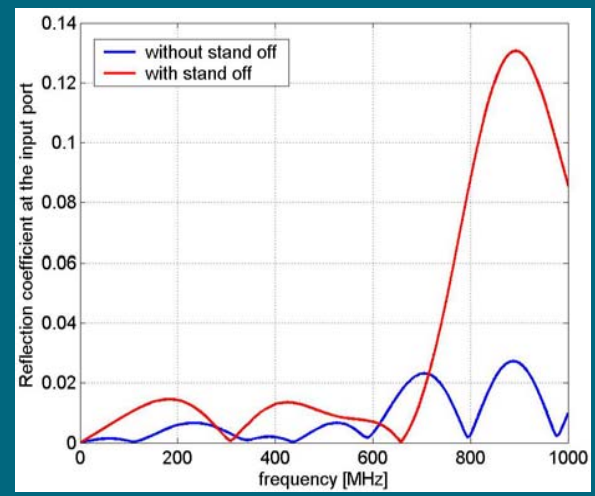

Pulse model vs. time

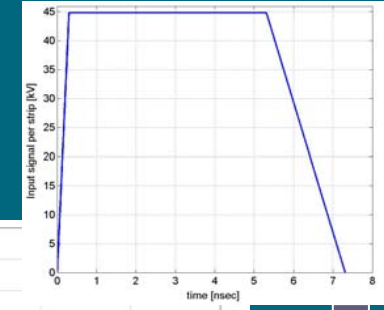

Pulse model vs. frequency

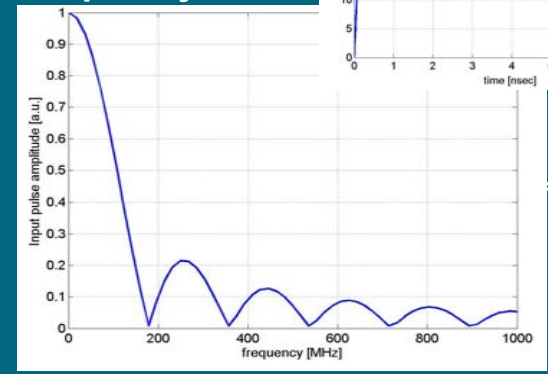

Deflecting field uniformity in the transverse plane (3D compared with 2D results)

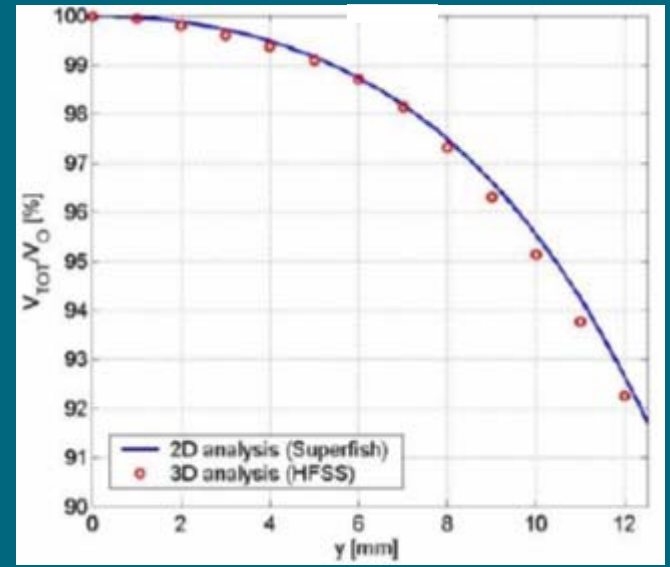
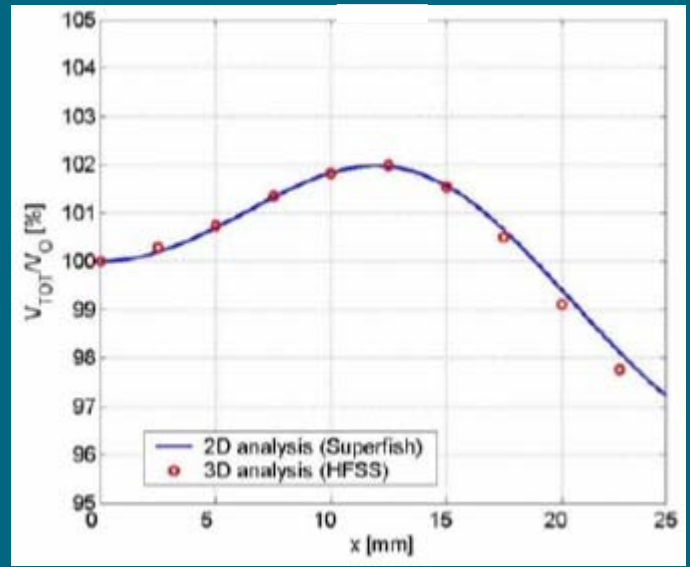

3) DAFNE kicker design: 3D electromagnetic model (3/4)

Evaluation of beam coupling impedance and transfer impedance using the wire method technique.

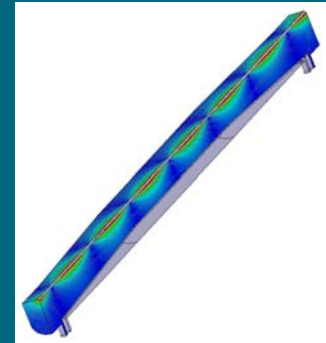

BEAM COUPLING IMPEDANCE

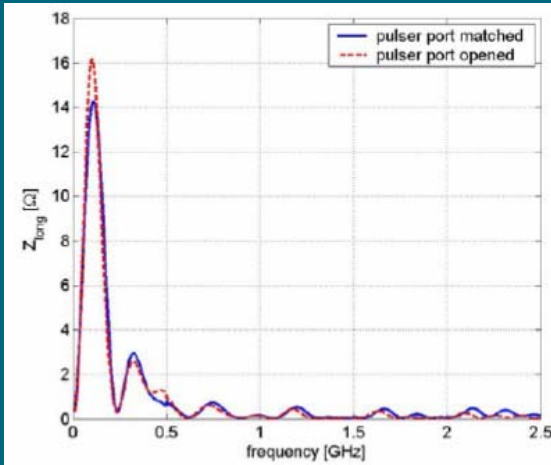

Longitudinal impedance

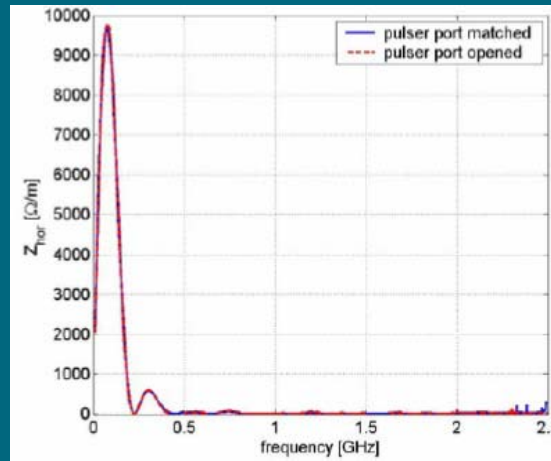

horizontal impedance

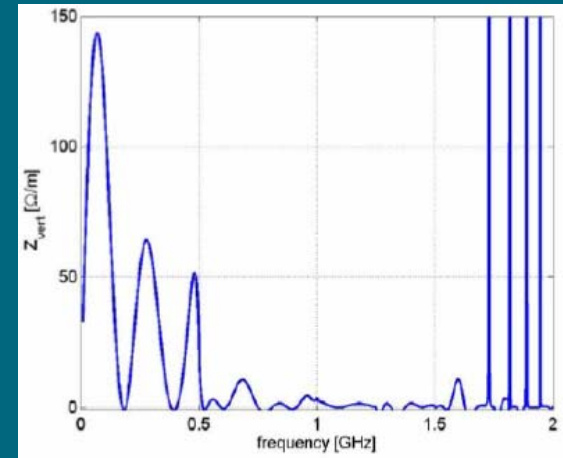

vertical impedance

4 vertical impedance HOMs found.
They belong to the TE_{11n} family.



low transverse impedance
not a problem for the vertical feedback system

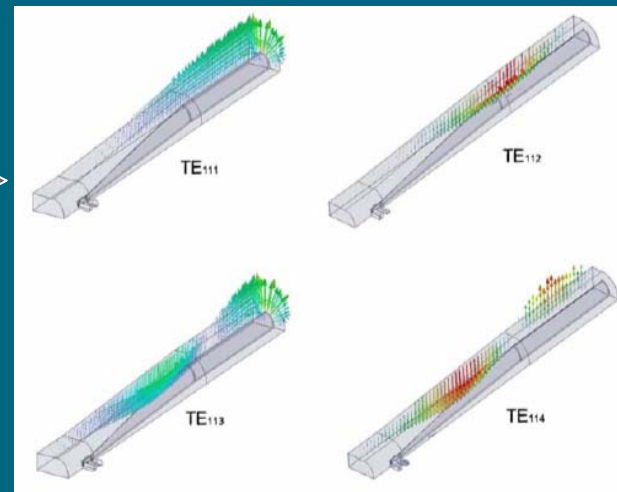

$f_1 = 1.60$ GHz
 $f_2 = 1.66$ GHz
 $f_3 = 1.74$ GHz
 $f_4 = 1.83$ GHz

3) DAFNE kicker design: 3D electromagnetic model (4/4)

BEAM TRANSFER IMPEDANCE

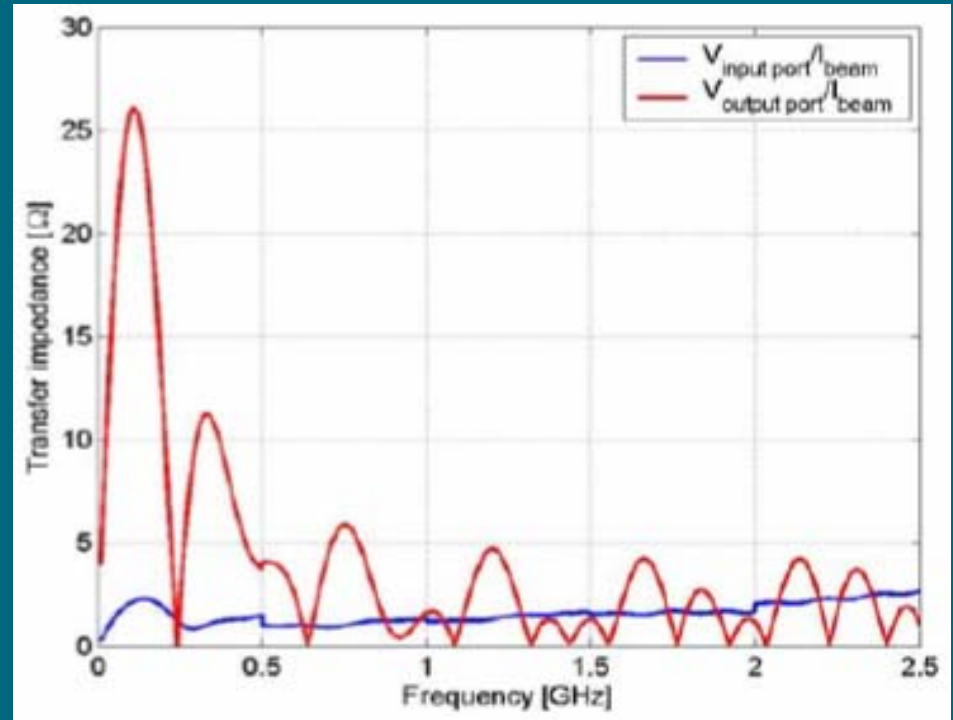

Bunch Charge [nC]	Peak voltage into the downstream port [V]	Peak voltage into the upstream port [V]
1	8	16
3	25	50
6	50	100

Beam induced peak voltage into the kicker coax ports

Beam current [A]	Average power into the downstream port [W]	Average power into the upstream port [W]
1	1	5
2	4	20

Beam induced average power into the kicker coax ports

3) DAFNE kicker design: mechanical drawings

The kicker for the injection upgrade of DAFNE has been almost completely designed. The mechanical drawings are ready as well, except for some last details not yet completely defined (the feedthrough housing).

To get the required deflection, very high voltage (about 45 kV) has to be applied to each electrode.

HV tests on the most critical parts and components of the kicker are necessary for the defining the final version of the drawings.

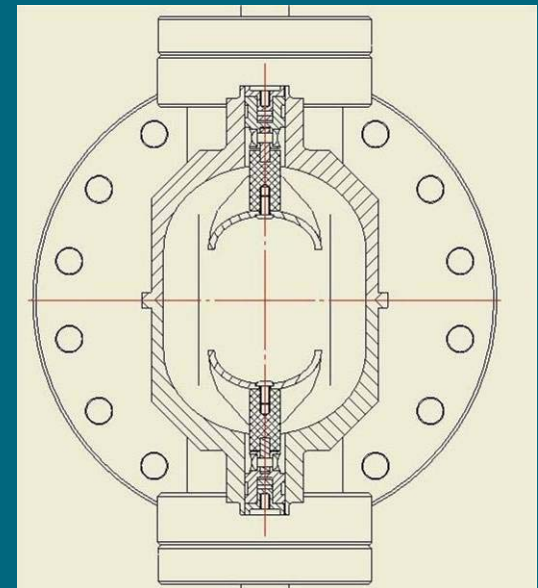
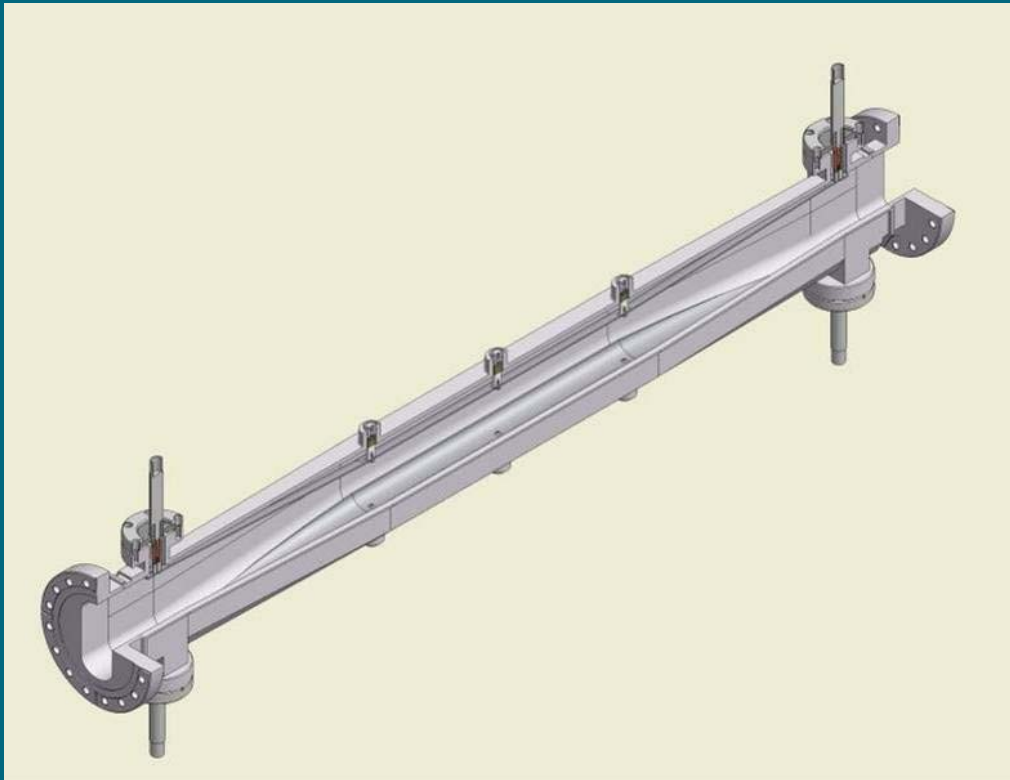

4) R&D and HV tests: the test stripline (1/6)

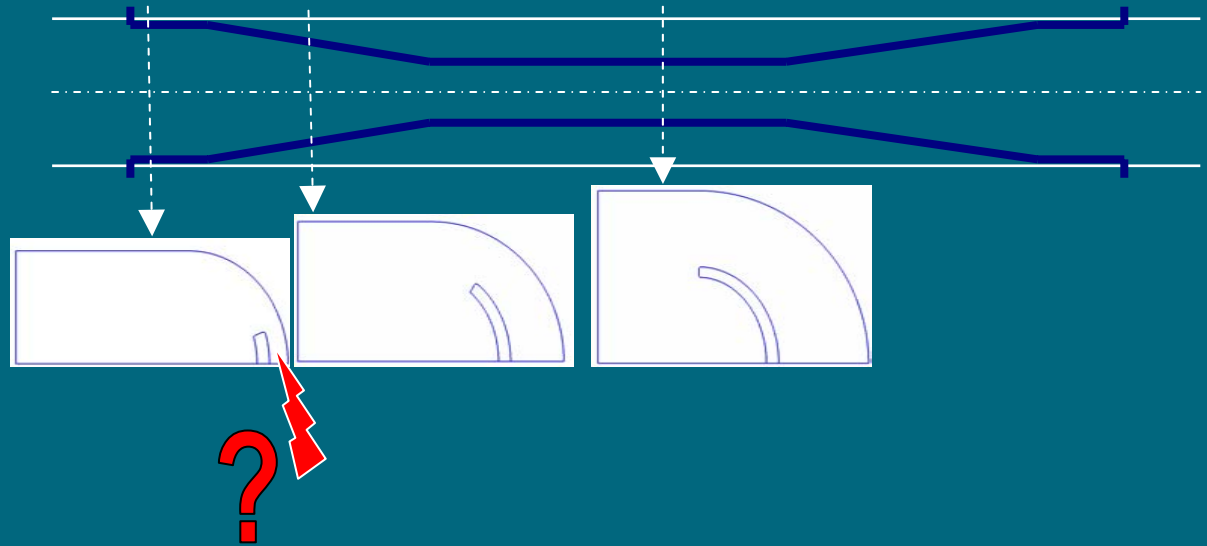

When HV is applied the possibility of discharges is higher in the end-section of the kicker electrodes, where the electrode itself is closer to the vacuum tube.

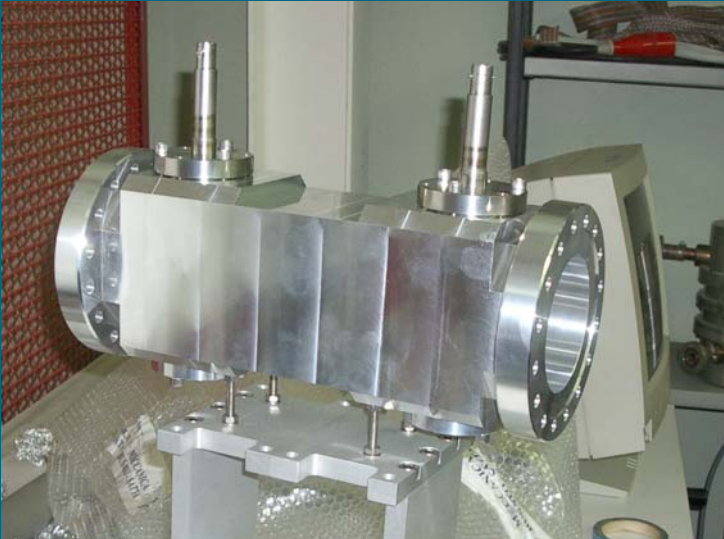

A stripline with the same dimension and the same distance from the chamber of the kicker stripline in the end section has been built. Coax ceramic feedthrough can be mounted on this test device to apply the HV to the stripline.

4) R&D and HV tests: the feedthrough (2/6)

The ideal feedthrough for our purpose has to:

- be able to tolerate the applied voltage (**45-50 kV**)
- have a constant **50 Ω** characteristic impedance.

Second statement is important to keep low the beam impedance of the kicker even well beyond the frequencies contained in the spectrum of the pulse.

It is not obvious to find a feedthrough fulfilling at the same time this 2 specifications.

The design of a dedicated feedthrough is in progress at LNF.

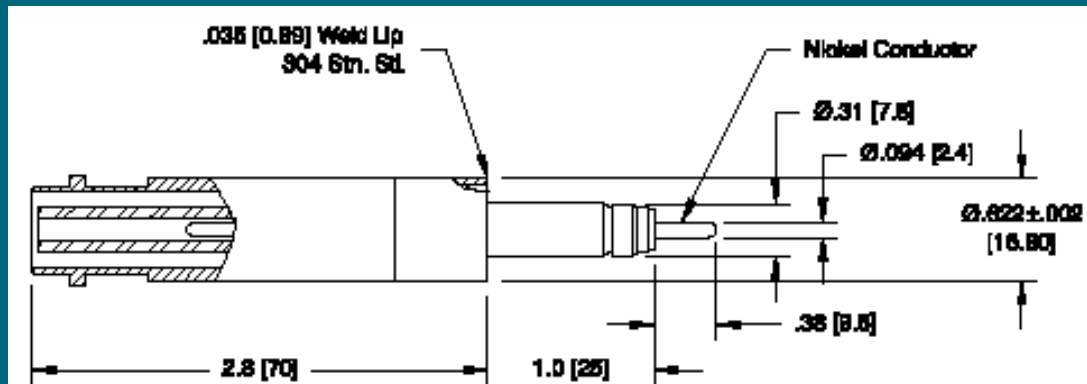

First tests have been done with a **commercial feedthrough (SHV20 standard)**.

It is specified for **20kV DC** (but our pulse length is 5ns).

The value of the **characteristic impedance is not specified**, but it is **not constant**.

4) R&D and HV tests: the feedthrough frequency response (3/6)

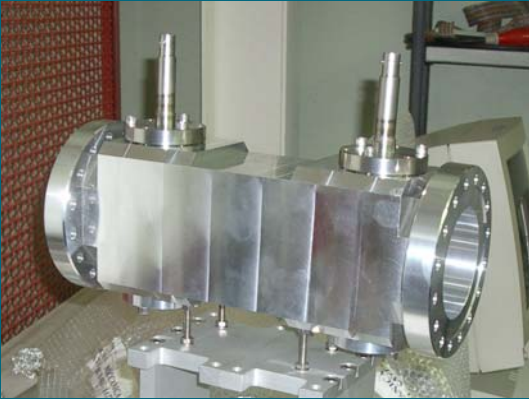

The test stripline has 2 flanges for housing 2 of such feedthroughs.

The frequency response of the feedthrough and the transition between foaxial and strip line can be measured with a N/A.

Measured transmission response

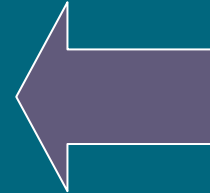
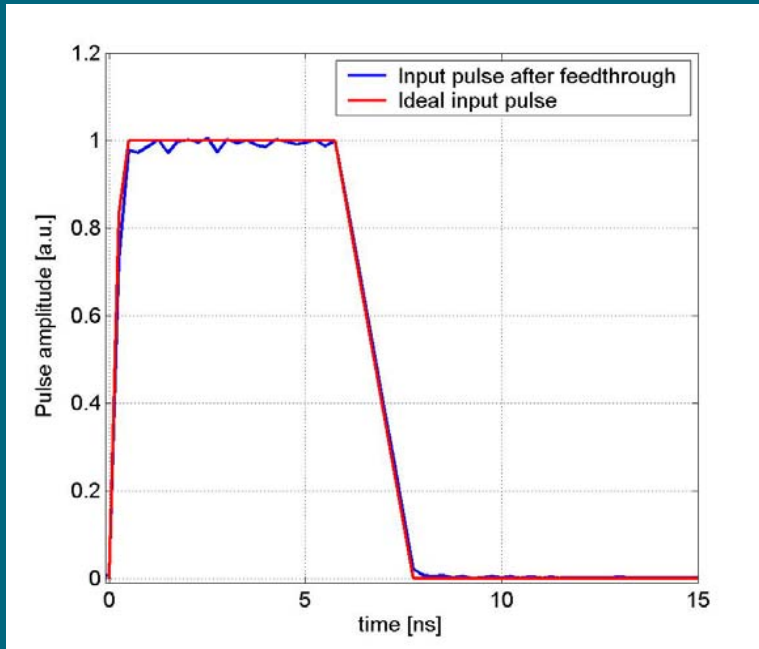
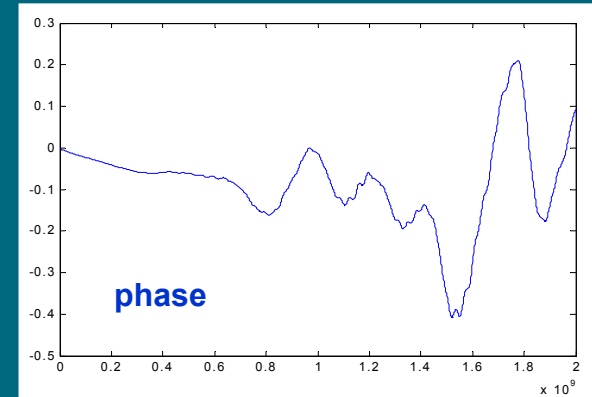
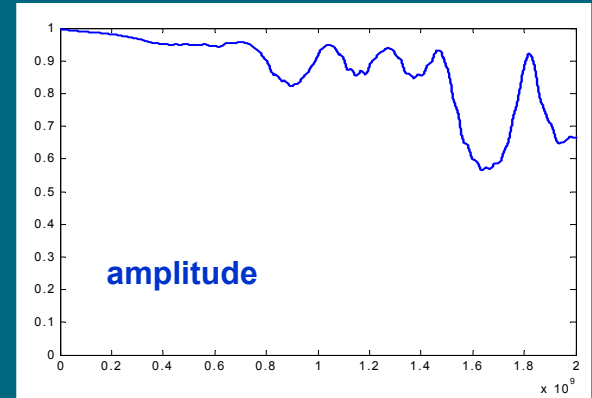

pulse shape distortion due to the real feedthrough

Input pulse fourier transform

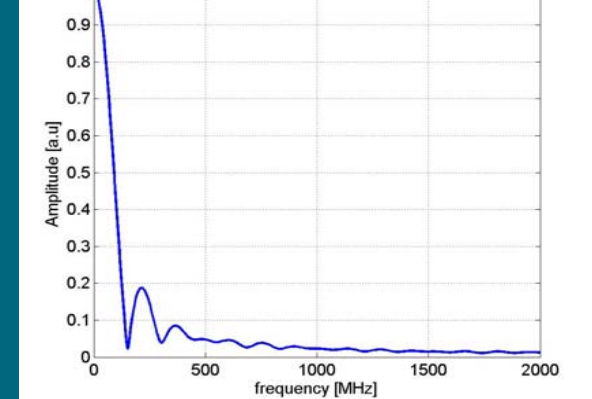

4) R&D and HV tests: the FID F10K10N207 pulser - V_{OUT} 16÷24kV (4/6).

First HV tests have been performed using a pulser borrowed from FID GmbH in the meanwhile that the 50kV final pulser (FPG 50-01SP) was fabricated.

This test pulser has pulse length and rise time similar to the FPG 50-01SP, while the pulse amplitude is only 20kV.



PULSE MEASURED AT THE GENERATOR OUTPUT CONNECTOR

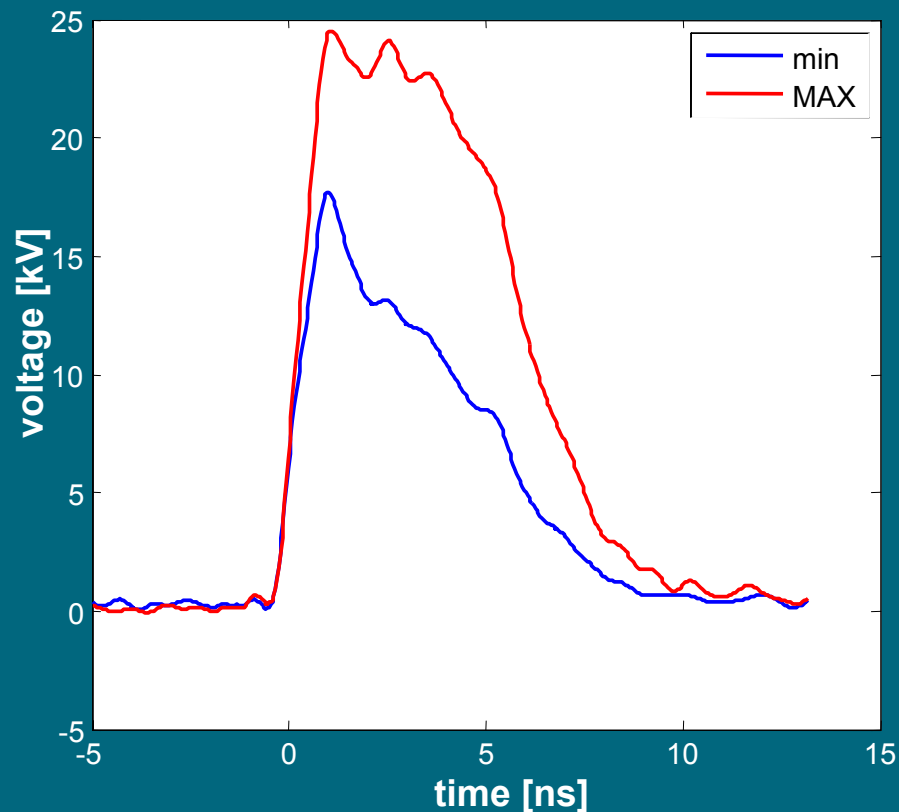

4) R&D and HV tests: results with F10K10N207 (5/6)

Using the pulser we have been able to test both the feedthrough and the stripline at HV operation.

To make the test **more probatory**:

- the load is disconnected from the stripline output which remain an **open circuit**
- **reflected pulse adds to the forward pulse**

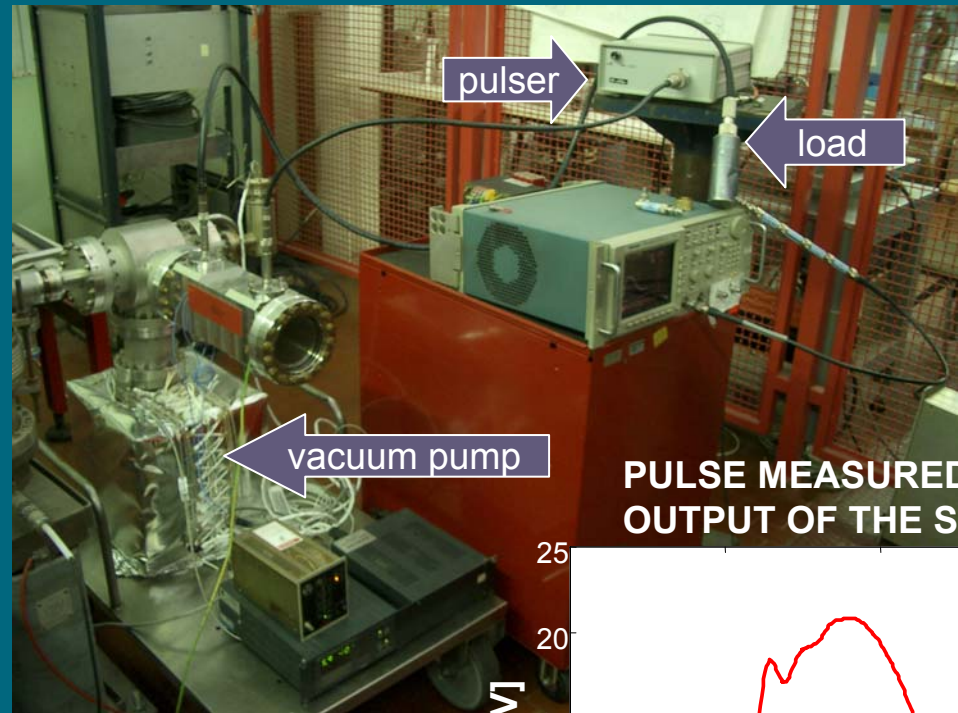

PULSE MEASURED AT THE OUTPUT OF THE STRIPLINE

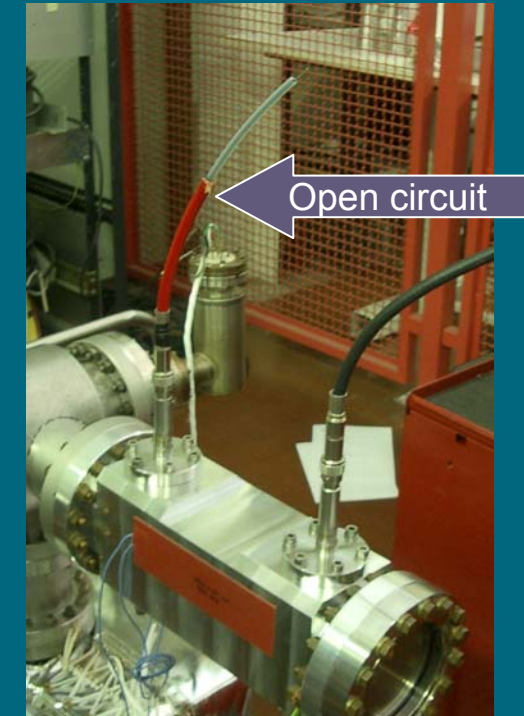
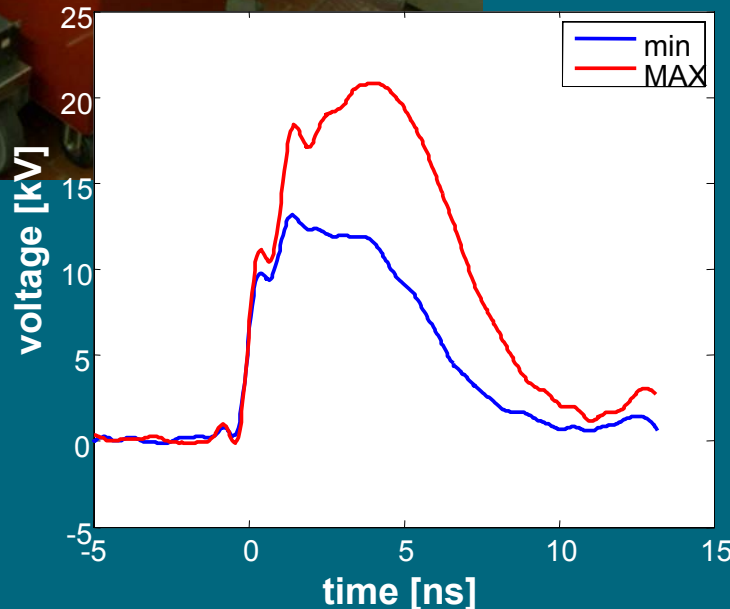

Results:

- **no monitors** of the pulse waveform available
- just vacuum read out and inspection through the glass window
- **no phenomena attributable to electric discharges** have been observed

4) R&D and HV tests: the FPG 50-01SP pulser (6/6)



HV tests have been repeated with the same set up when the 50kV pulser has been delivered at LNF.

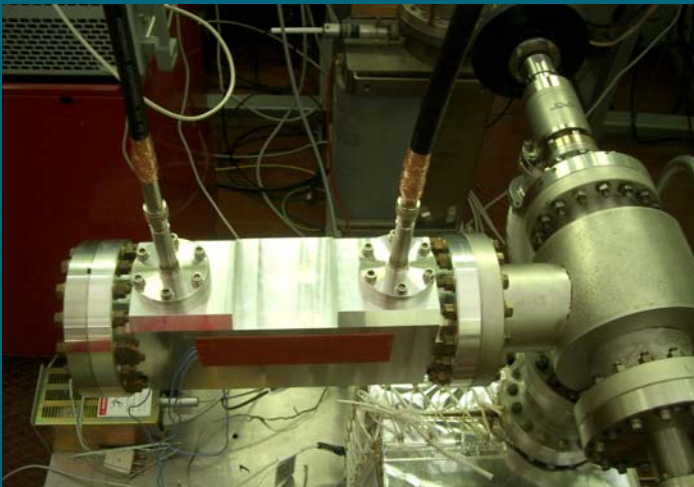

Test results:

- even at maximum output voltage (50 kV) there are **no discharges along the stripline**.
- after few pulses (some hundreds) there has been a **breakdown of the ceramic** of one feedthrough which lost its vacuum tight.
- a modification in the feedthrough housing was done; but, after some thousands of pulses with the voltage set at 48 kV, **discharges occurred in the air side of the feedthrough**. It has been irreversibly damaged.

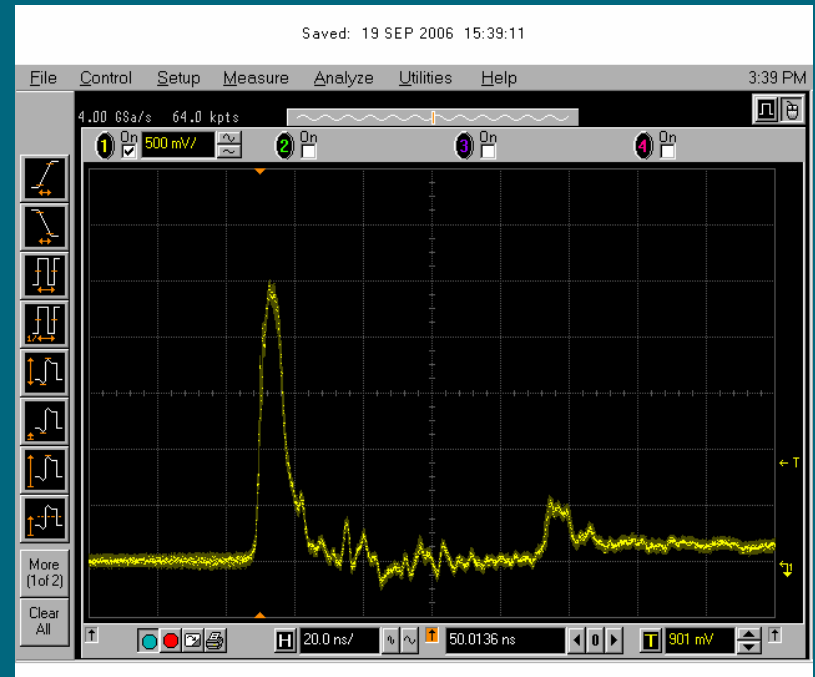

Grabbed waveform of the pulse ($V_{OUT}=48kV$) before the feedthrough damaging

CONCLUSIONS

- 1) Varying the coverage angle of the stripline it is possible to control the amplitude and the distribution of deflecting field over the kicker transverse plane.
- 2) The tapered stripline design allows:
 - Correction of the deflecting field flatness.
 - Substantial reduction of the beam impedance (coupling and transfer).
 - Improved matching of the transition between stripline and coaxial input and output lines.
- 3) The results of the HV tests performed till now have been:
 - Successful for the stripline geometry.
 - Negative for the used commercial feedthrough.
- 4) The design of a dedicated feedthrough is in progress.

5) Future R&D plans.

Owing to the failure of HV tests on the SHV20 feedthrough we decide to speed up the work on the special **LNF feedthrough**. Its design is almost finished and the construction of **two prototypes** is going to start **in the next days**.

We hope they could be **ready** and vacuum tested for the **end of October**.

Then they will be measured to characterize their RF response and tested with the 50kV pulser. Afterwards, if the upshot of it all will be positive, the **mechanical drawing of the kicker** can be finished with the details concerning the new feedthrough housing and the **fabrication of the first kicker can start**.

According to this schedule, the **end of this year** could be a reasonable date for having this **first kicker at LNF** and for starting to carry out further **RF and HV tests**.

Fundings have been already assigned for construction and installation of DAFNE kickers and in general **for the whole injection system upgrade**.

Concerning the **kicker for ILC**, a shorter stripline kicker is necessary, due to the reduced bunch spacing. The design of this kicker is in progress and is **based on the same criteria** (tapered stripline) developed in the case **of the DAFNE kicker**, finalized to minimize the coupling and transfer impedance of the device.

After the installation of the new kickers in DAFNE, tests of other pulsers than our 50kV FID pulser will be possible and dedicated time machine slots can be scheduled.