



**ATF2**

**Magnets**

Summary of “Magnet, Mover & Alignment”  
Session at 3<sup>rd</sup> ATF2 Project Meeting, 19<sup>th</sup>  
December 2006 at KEK

Cherrill Spencer, SLAC  
Member of ATF2 Magnet Team



**ATF2  
Magnets**

## Summary of “Magnet, Mover & Alignment” Session, 19 Dec 06

- Five speakers dealing with
  - new ATF2 magnet production;
  - measurements of new ATF2 quadrupoles;
  - design of ATF2 magnet supports;
  - compatibility of path of laser light from laser wire system with various ATF2 magnets
  - new adjustable permanent magnet that could be tested in the ATF2 beam line



## ATF2 Magnets

# Compatibility of path of laser light from laser wire system with ATF2 magnets

- Lawrence Deacon (Royal Holloway)

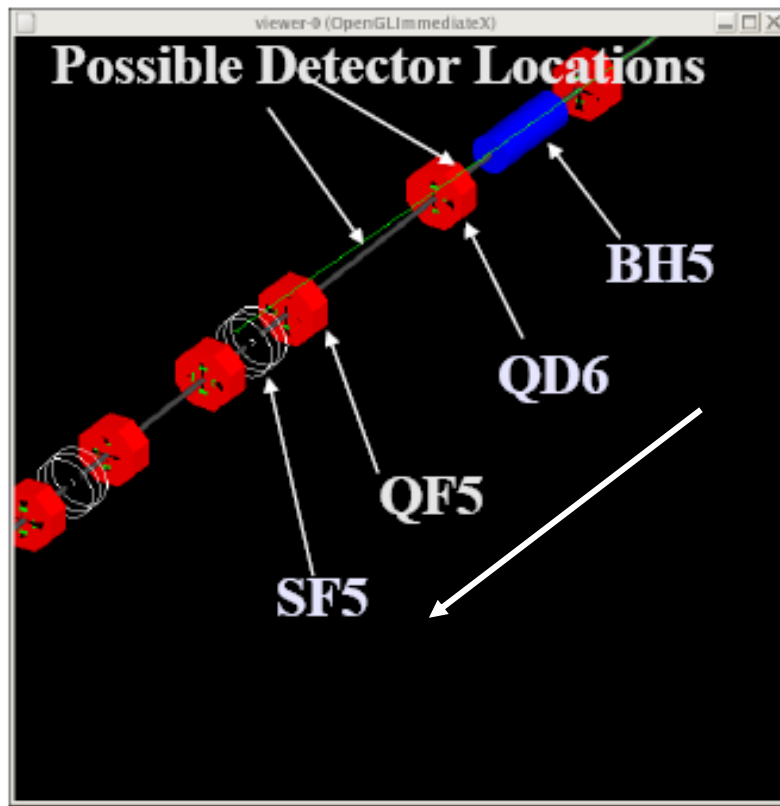

Question is: where is best to put the detector that detects the laser wire system laser photons?

Depends on which style of detector is chosen; size of detector; how much interference with nearby magnets-do they have to be modified?

Two “best” locations:

Before QD6 and after BH5

After QD6 and before QF5



## ATF2 Magnets

# Compatibility of path of laser light with ATF2 magnets, page 2/3

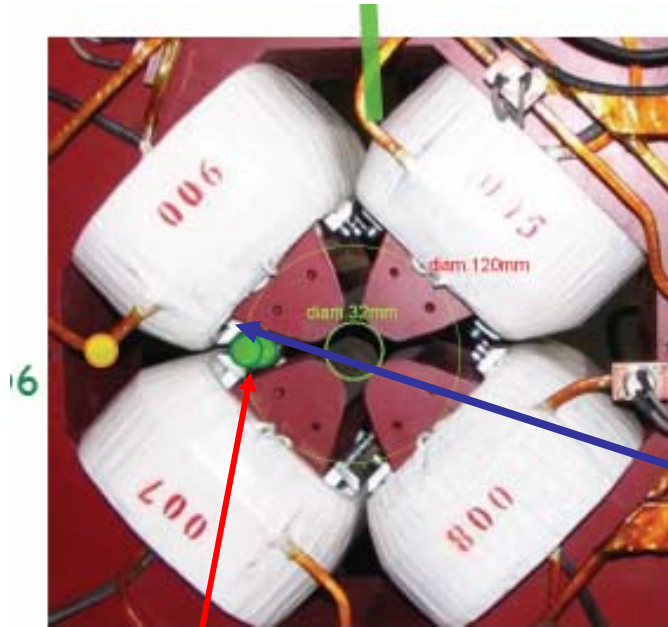

Green circles show laser beam positions as enters and leaves QD6, if detector placed after QD6.

Placing detector before QD6 has several disadvantages.

Placing detector after QD6 – have to put a beampipe for the laser photons in a gap between two QD6 poletips.

Depending on outer diameter (OD) of this pipe we might have to shorten the thickness of some bolts to left of pipe. What happens to signal if OD is restricted to 20mm ?



**ATF2  
Magnets**

## Compatibility of path of laser light with ATF2 magnets, page 3/3

- Using a simulated Compton scattered photon spectrum, Deacon modelled the laser wire signal at a detector in 2 different positions.
- Found that the difference in signal between the 2 locations is not great, after QD6 has some advantages
- New QEA quads being made- some could have smaller bolt heads used, so could better accommodate the laser beampipe
- Deacon will continue to work on this



**ATF2  
Magnets**

## Proposed Design of Supports that go under ATF2 magnets, pg 1/5

- Ryuhei Sugahara (KEK) designing magnet support system that sits on floor and has several components: concrete block, position adjuster; magnet movers or other supporting devices  
Have 27 quads, 3 dipoles and 3 sextupoles needing this support system.
- Quads and sextupoles have old FFTB movers under them, some modification needed to make movers work with ATF2 beam line parameters

Not scaled !

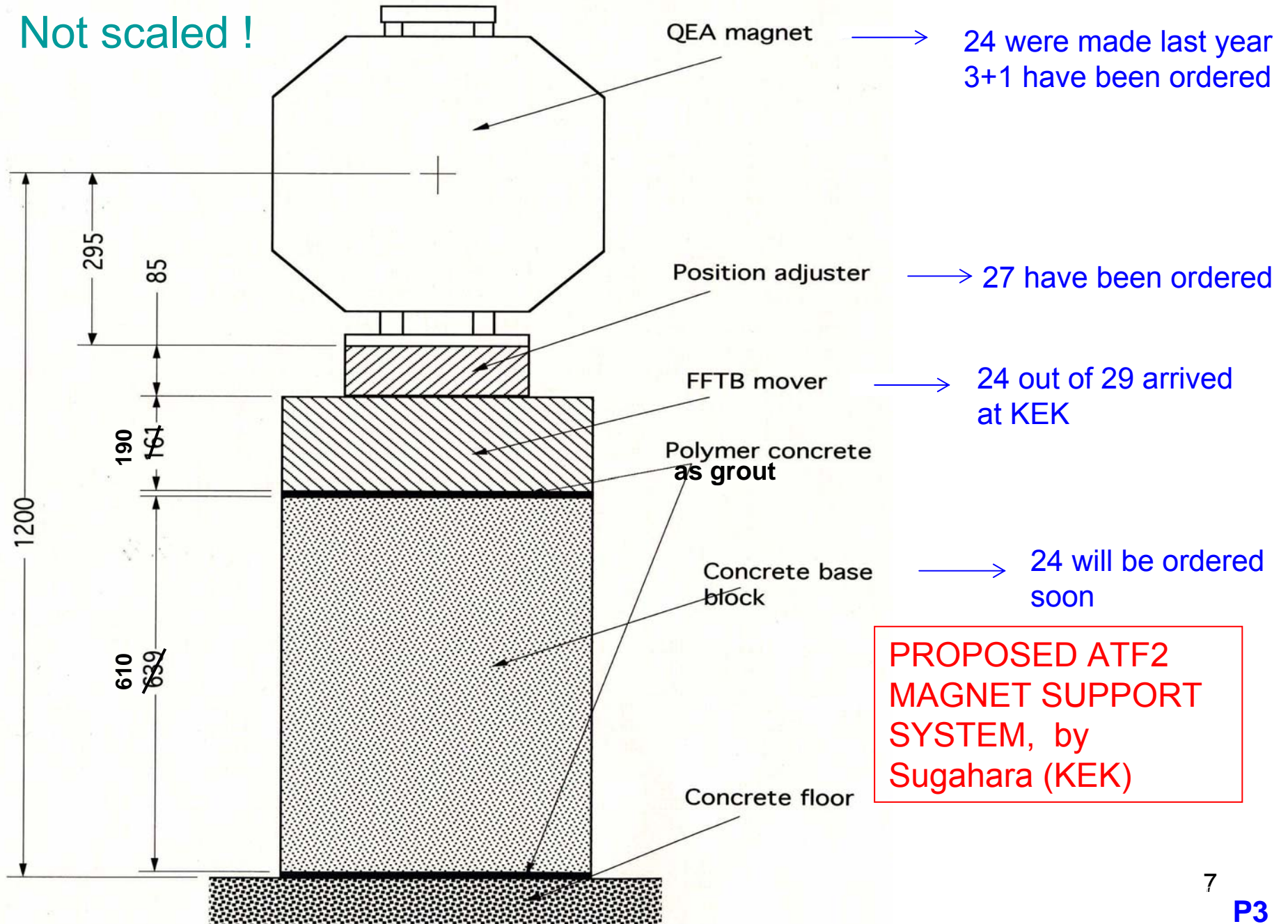

**PROPOSED ATF2  
MAGNET SUPPORT  
SYSTEM, by  
Sugahara (KEK)**



**ATF2  
Magnets**

30mm thick iron  
plate  
to fix magnets

Concrete block

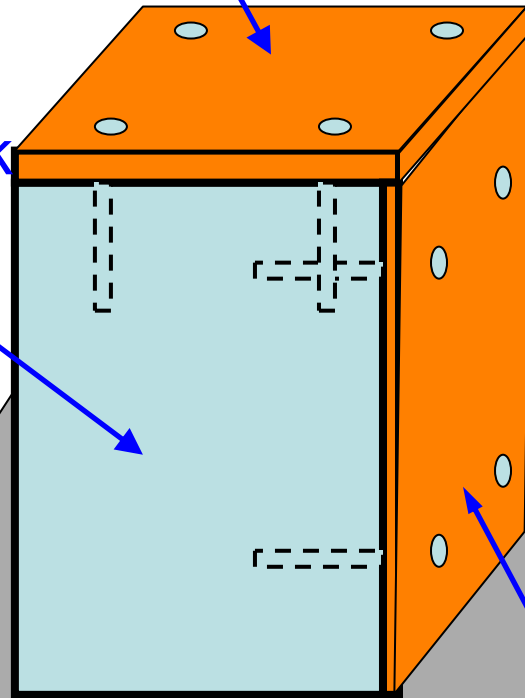

10mm thick iron plate  
to fix electronics boxes for BPM





**ATF2  
Magnets**

# FFTB Mover- modified for ATF2

Need permission of SLAC group to make 16mm dia. holes at the center of the T-plate

New system of plates that go between mover shafts and magnet

29mm thick

KEK, 20 Dec 2006

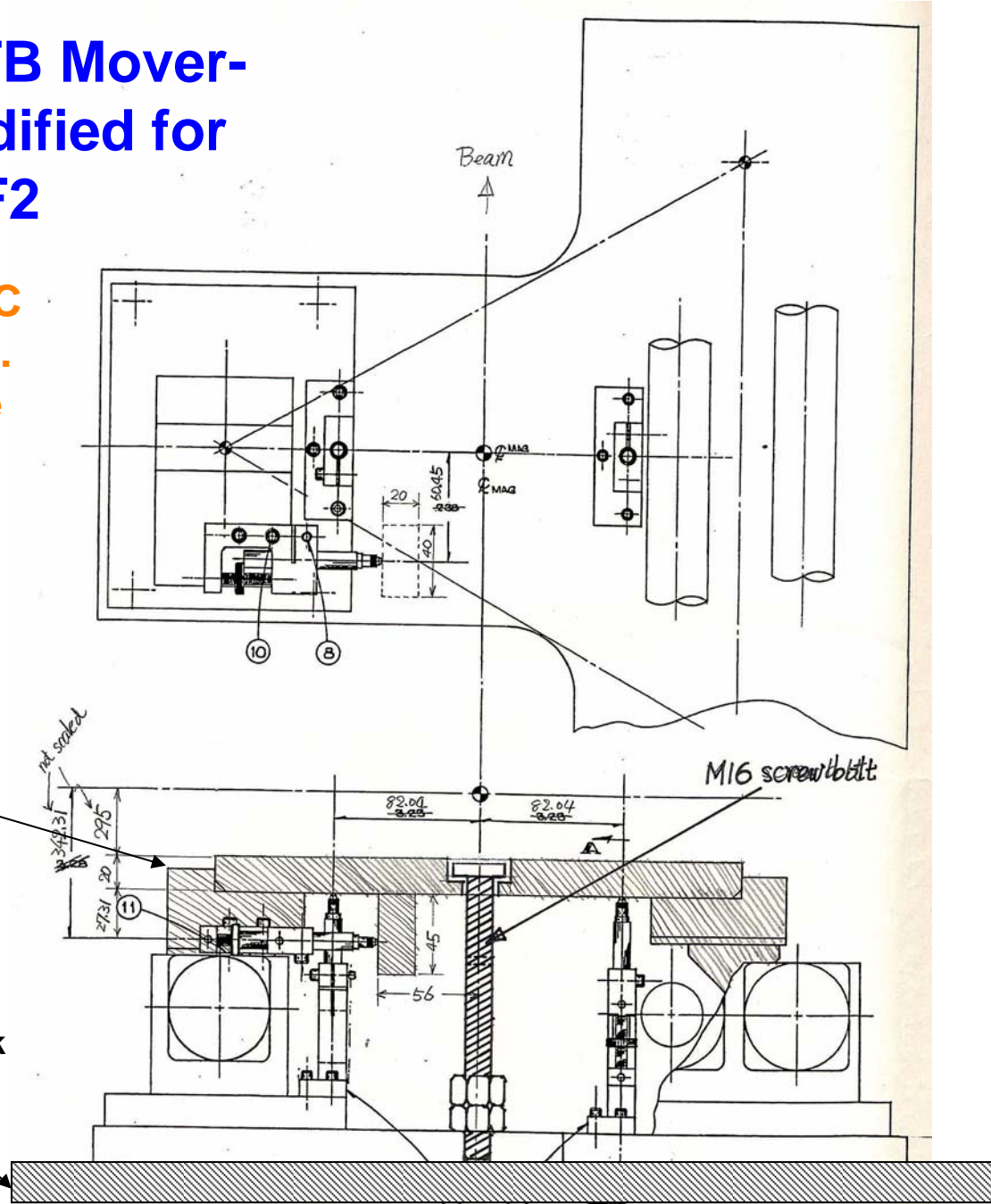



**ATF2  
Magnets**

**Type 3  
(3 blocks)**

Are 4 different types of magnet support blocks

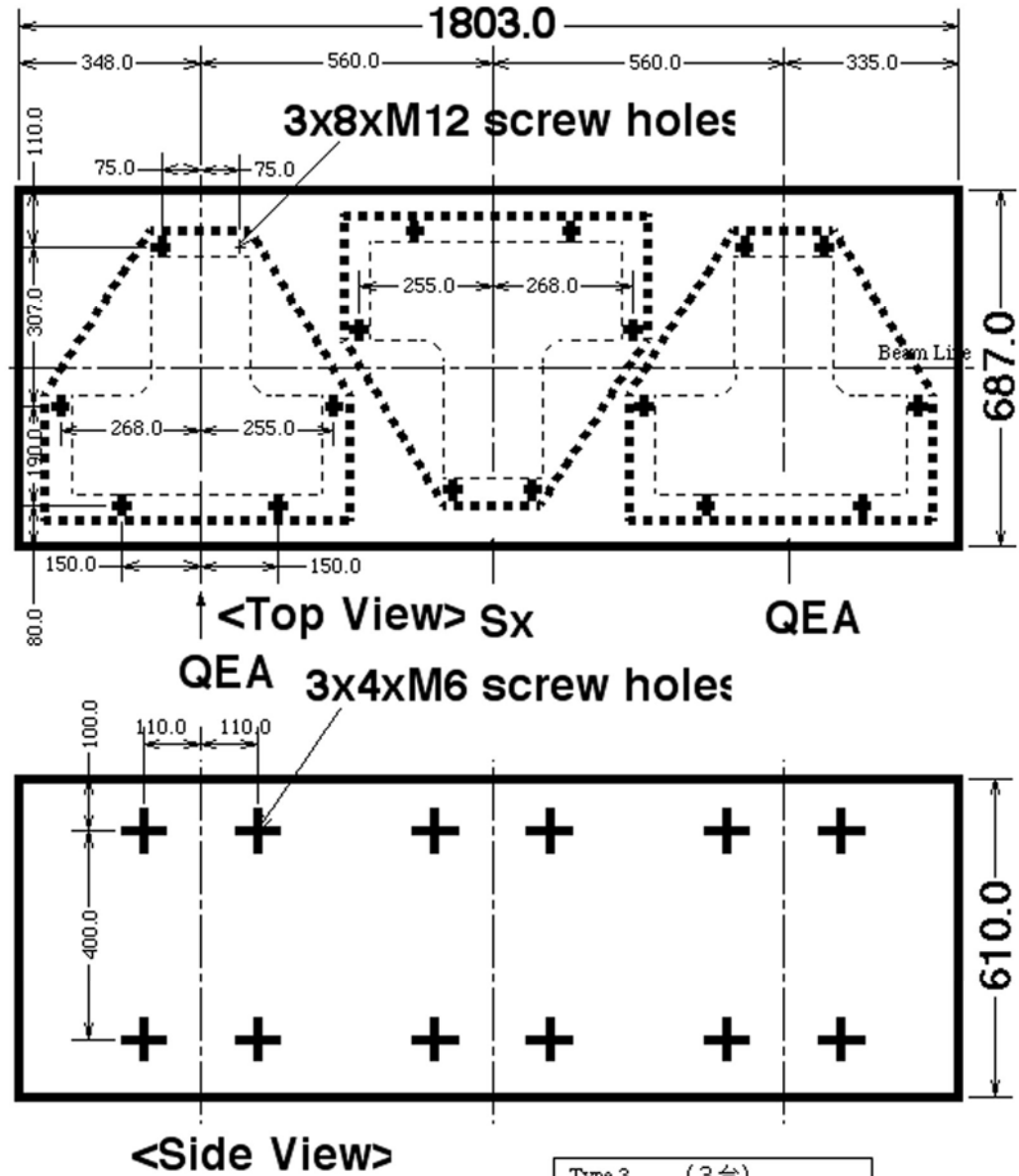

Type 3 (3台)  
高エネルギー加速器研究機構  
S = 1/10  
菅原 2006.11.01



**ATF2 Magnets** New adjustable permanent magnet that could be tested in the ATF2. pg 1/5

- Y. Iwashita, M. Ichikawa, Y. Tajima, M. Kumada, C.M. Spencer  
From Kyoto University, NIRS, SLAC, been working on adjustable permanent magnets for about 4 years.
- Two adjustable prototypes been designed, fabricated and extensively measured at SLAC and Kyoto University
- Various possibilities for use at the ILC



# ATF2 Adjustable Permanent Magnet Quadrupole Magnets

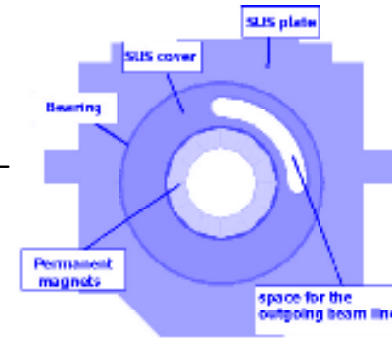
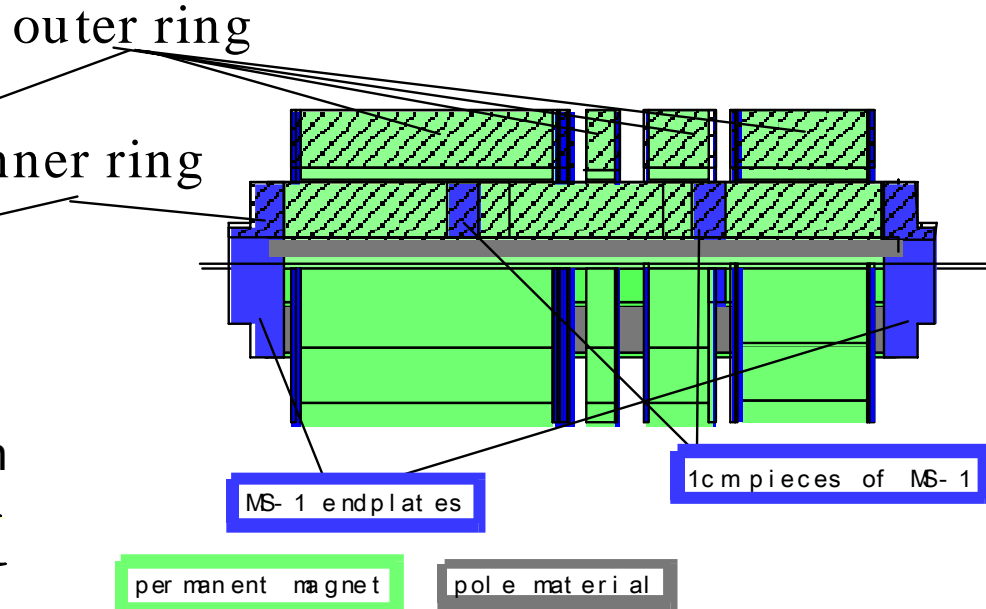
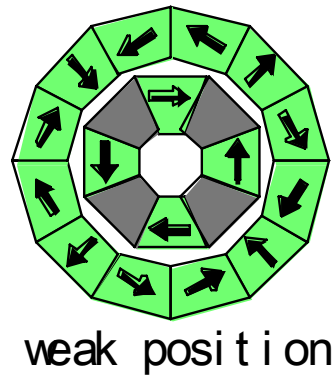
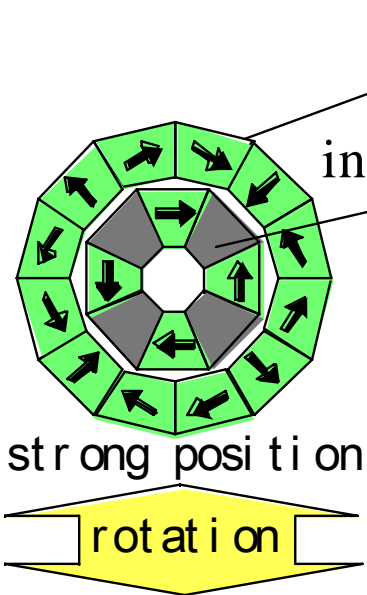

The PMQ is composed of an inner ring and four outer rings (Double Ring Structure). Only the outer rings are rotated in order to change the integrated gradient. The fixed inner ring suppresses any errors caused by rotation of outer rings.

Permanent Magnet (NEOMAX38AH)

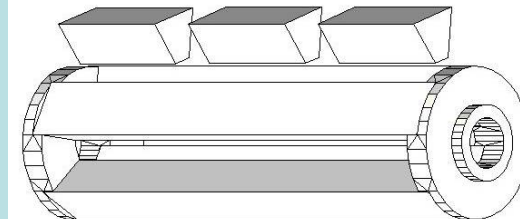



SWL = 4cm

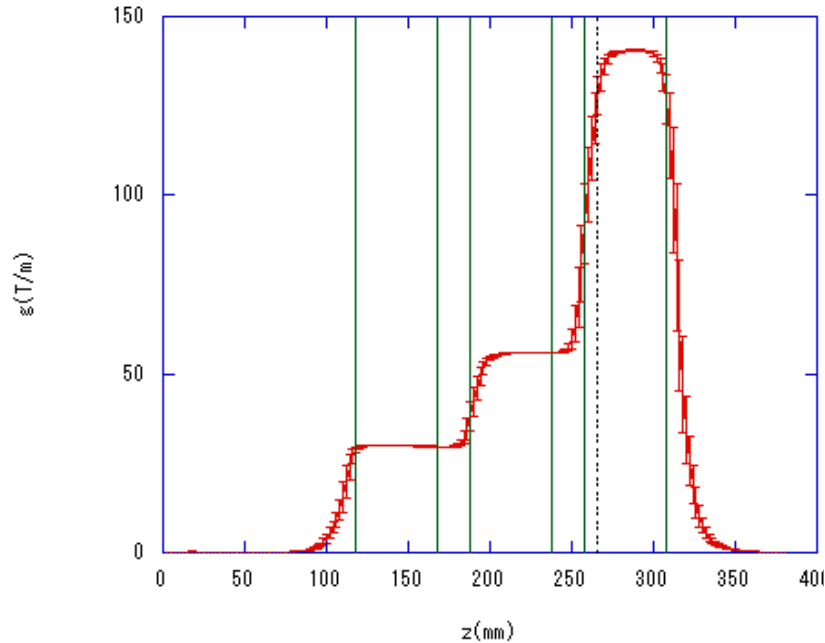
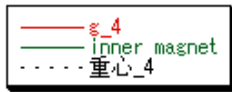

SWL = 8cm

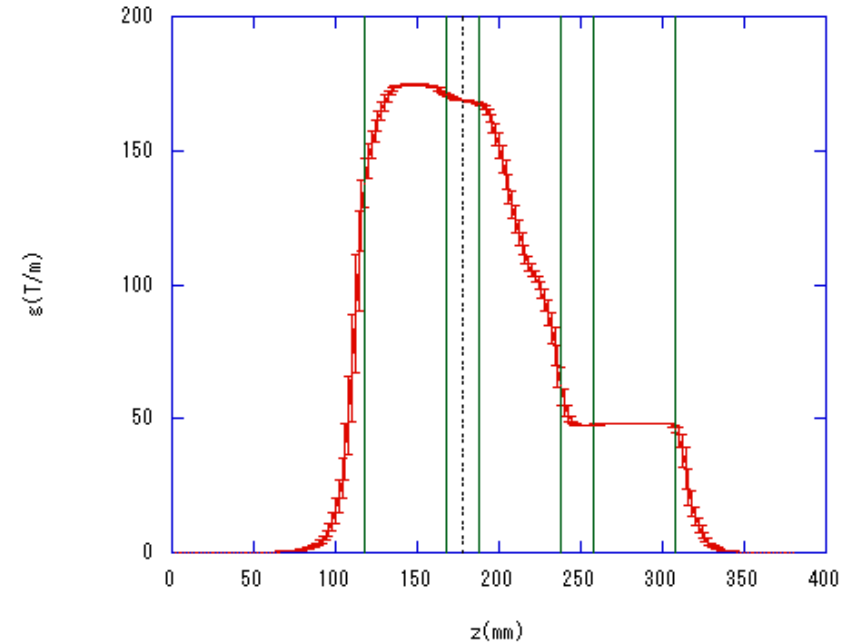

Gradient is high at ON region.  
Magnet gaps of the inner ring affects the distribution.

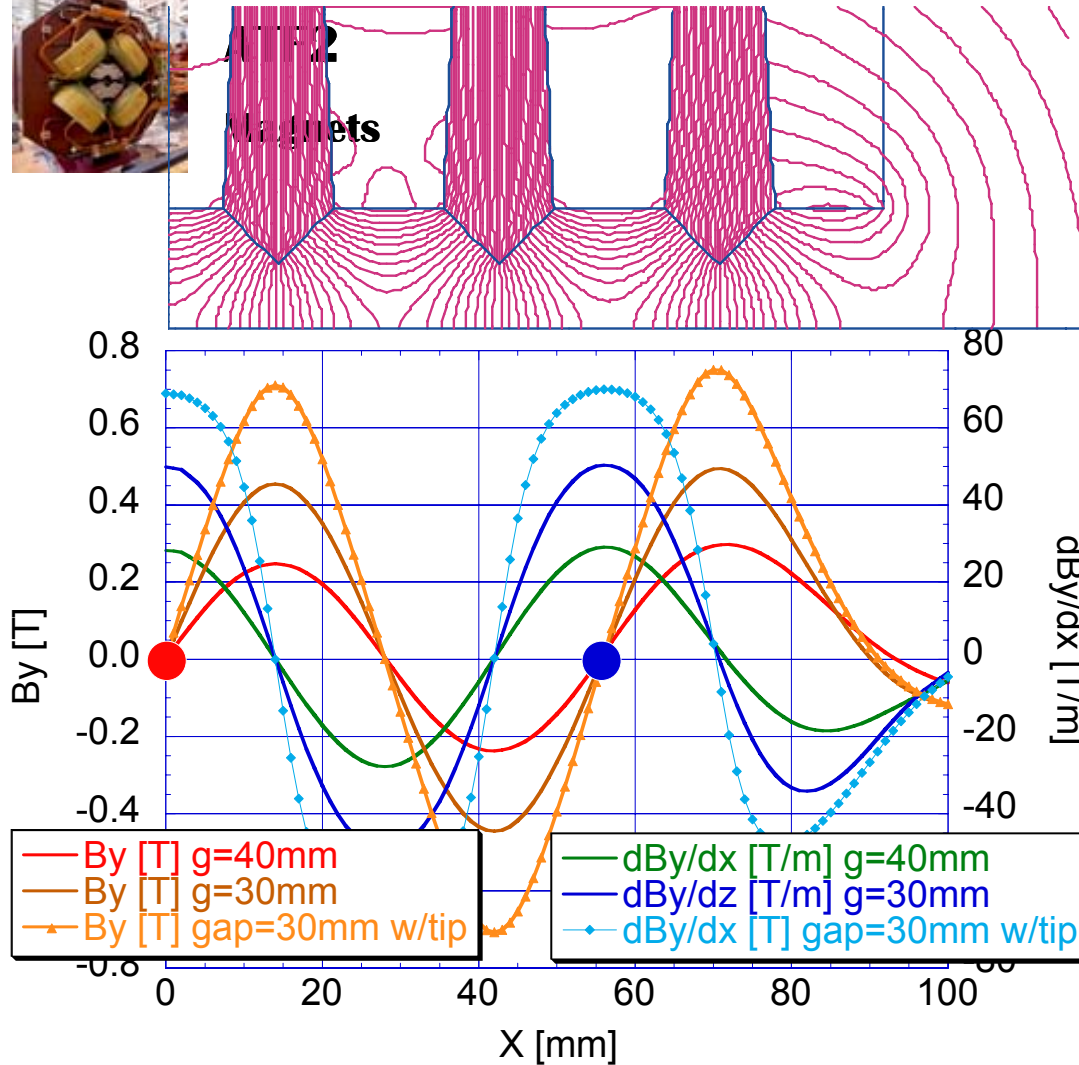

Side by Side Quad- for use in ILC where incoming and outgoing beams are very close. Beams into page at red and blue circles

Strength can be reduced by opening the gap.

**Both D**

70T/m @  $\varnothing 30\text{mm}$

Octupole components tolerable?



**ATF2**

**Magnets**

Possible octupole PM design. Is a two-piece configuration so can be installed in beamline.

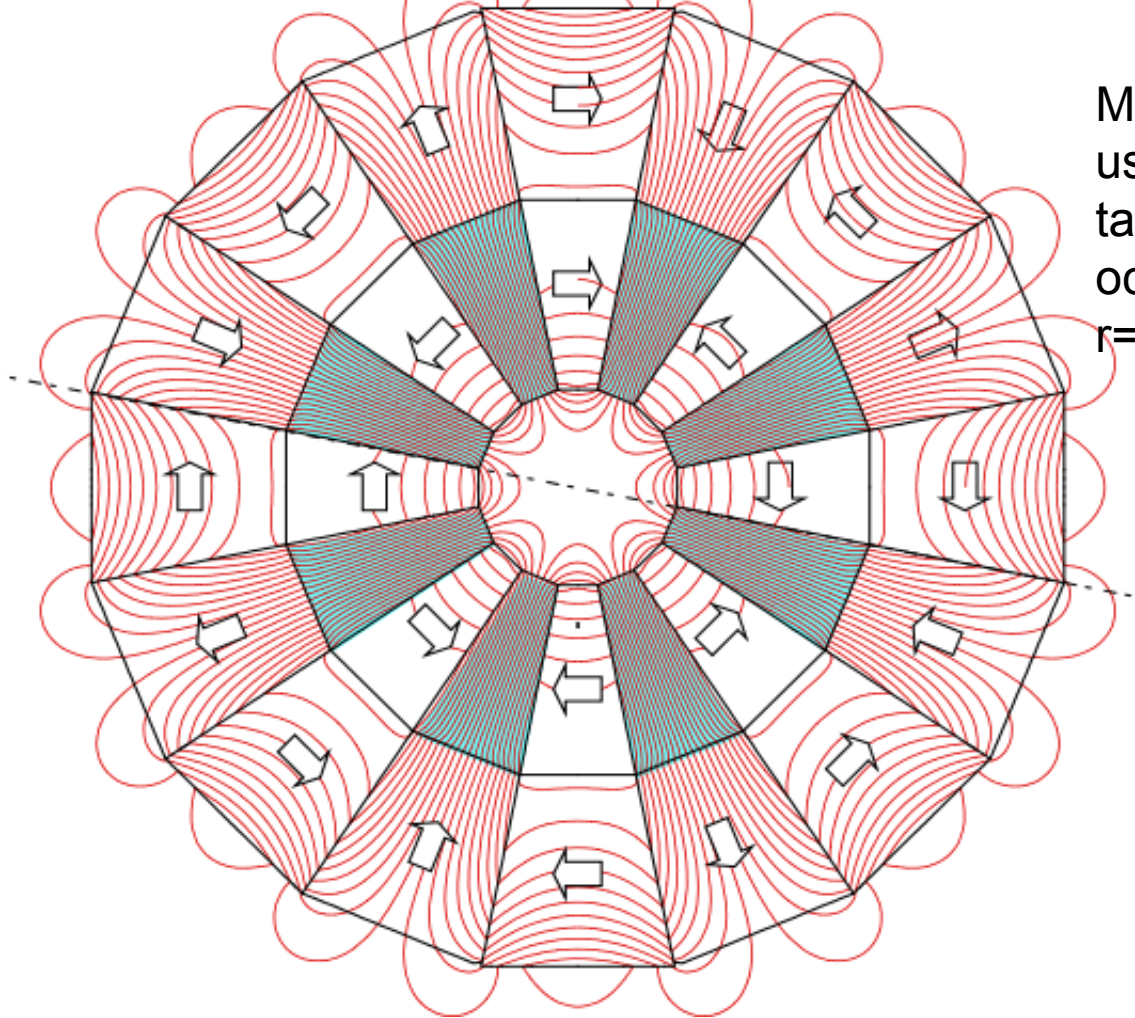

Maybe could be used for the ILC tail-folding octupoles-with  $r=0.7\text{cm}$



**ATF2**

**Magnets**

## Status report on magnetic field measurements of QEA-magnets, pg 1/8

- Mika Masuzawa (KEK) been measuring 24 QEA quads that are in FF of ATF2.
- Compared KEK results with IHEP measurements
- New data since last report: skew sextupole component





## **ATF2** # of magnets measured, pg 2/8

### **Magnets**

Magnets were divided into two groups, a high current group and a low current group.

“High current” magnets were measured with a 150 A maximum standardization current and “low current” magnets were measured with a 50 A maximum standardization current.

Magnets were delivered to KEK in two shipments:

- 1st batch (150 A max. current): 11 magnets
- 2nd batch (150 A max. current): 2 magnets
- 2nd batch (50 A max. current): 11 magnets

Total of 24 magnets have been measured at KEK.

- QEA04 (150A) stays at IHEP as a reference magnet.



**ATF2  
Magnets**

Compare Measurement Systems, pg 3/8

- IHEP
  - Rotating coil with mechanical bearing
  - Align the measurement coil using the magnet bore
- KEK
  - Rotating coil with air bearing
  - Align the measurement coil using the alignment plate, just the same way as we will do in the actual alignment.



# Comparison of magnet strength measurements ATF2 between IHEP and KEK (2nd batch), pg 4/8

## Magnets

Meas.comp (50A Max. magnets)

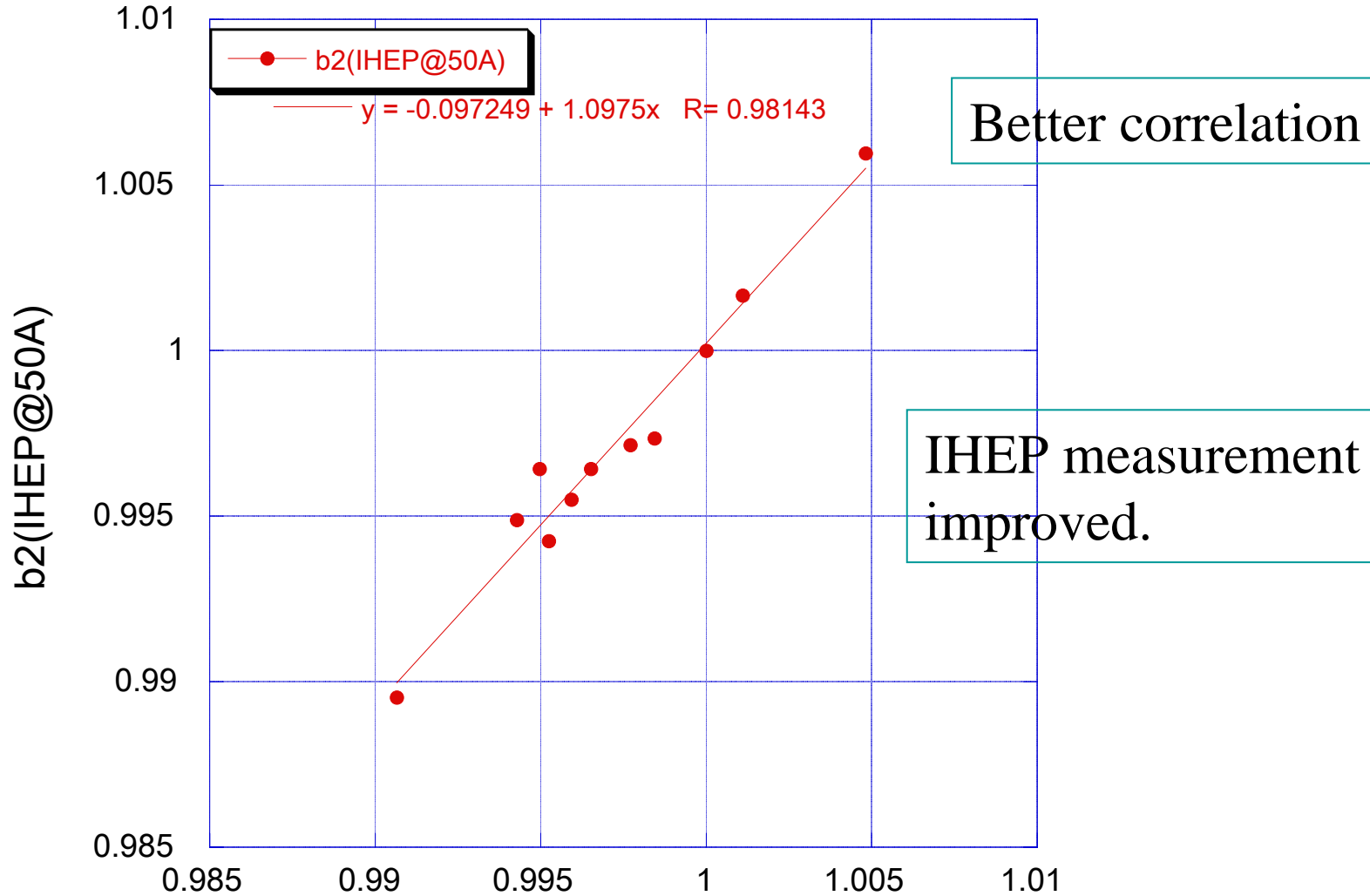



**ATF2**  
**Magnets**

Problems with magnet & alignment plate  
3 cases observed pg 5/8

Chen Wan, Sun Xianjing confirmed this with the alignment scope with us, with QEA08 magnet.

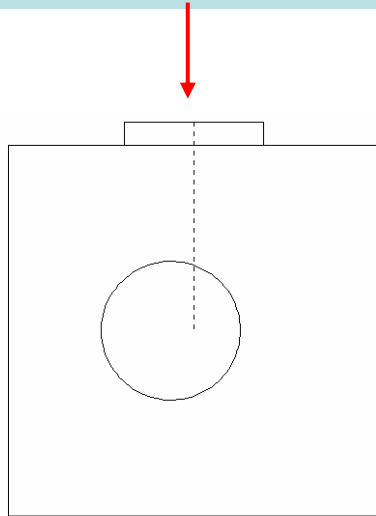
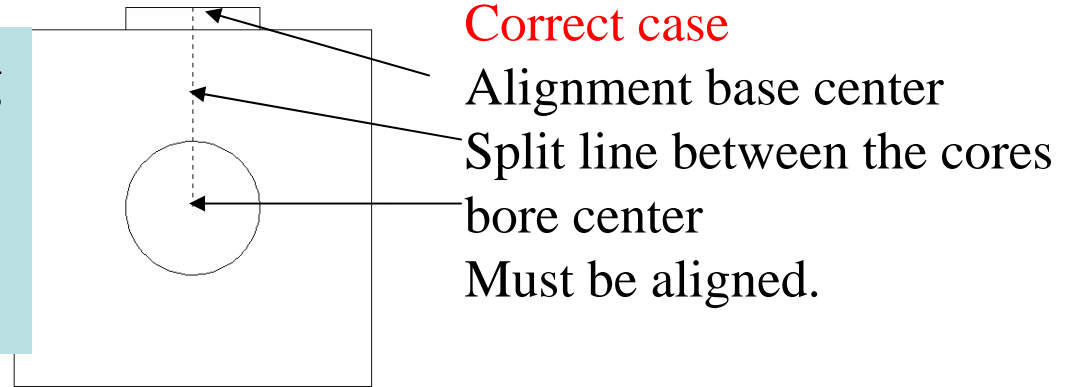

(1) Magnet bore is not aligned.  
How could this happen??

EDM process???

KEK, 20 Dec 2006

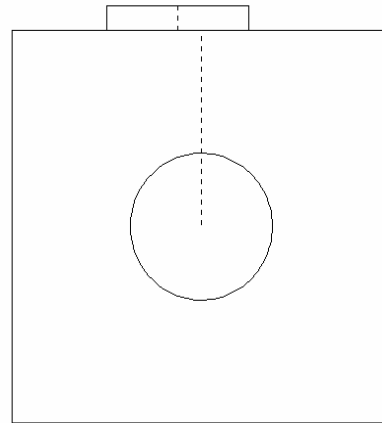

(2) Alignment base is not aligned.

(3) (1)&(2) mixed.



ATF  
Mag

# Measurement comparison between IHEP and KEK for sextupole skew component: good agreement

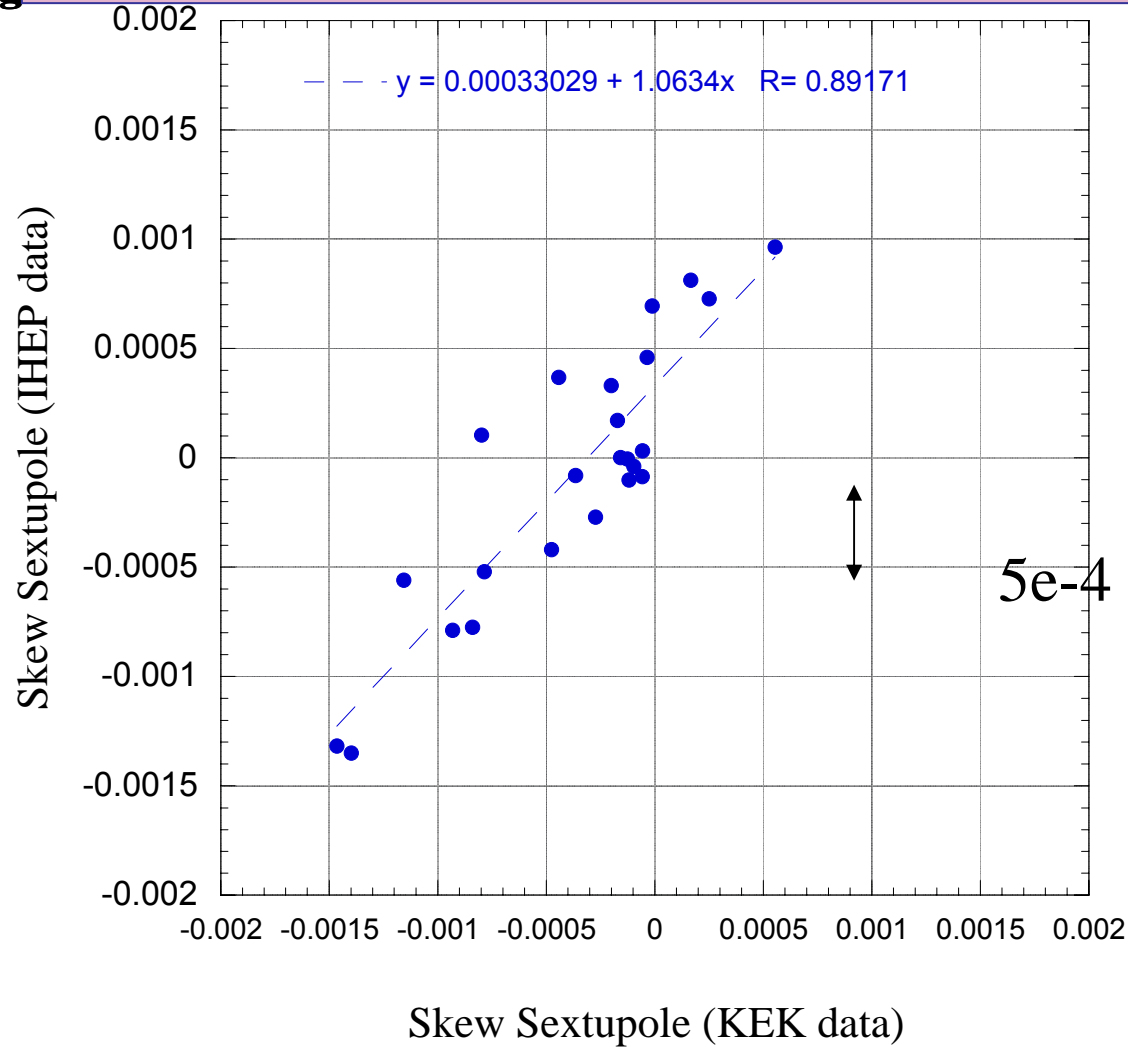

KEK, 20 Dec

Phase information needed for calculating the skew component. Sextupole phase with respect to the quadrupole phase was used.

# Sextupole components (normal and skew) plotted against magnet #



ATF2

Magnets

QEA magnets Sextupole component

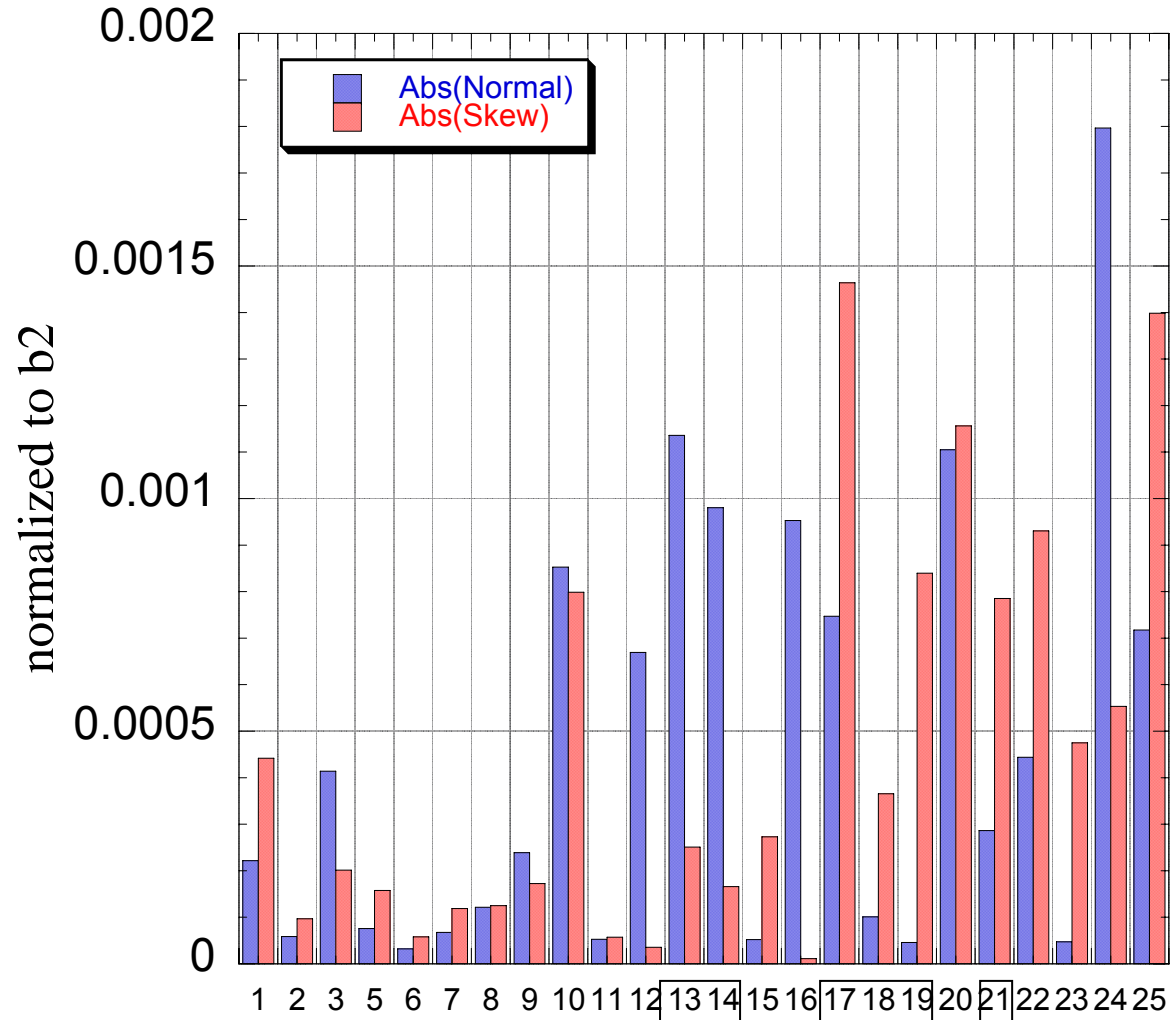



**ATF2**

**Magnets**

## Summary by Masuzawa, pg 8/8

- 24 magnets were measured at both IHEP and KEK.
- KEK data will be used for generating the excitation curves, though the IHEP measurement improved for magnets in the 2nd batch.
- Large offset in the magnetic field with respect to the mechanical center was measured. Alignment people should use the field measurements result when aligning the magnets in the beam line.
- Sextupole components seem to be small enough, or at least one can select good magnets for critical places in the beam line.
- Trim coil data were taken. Be careful when connecting the trim coils to the power supply.
- Bad news:
  - 6 magnets in the 2nd batch were taken away by the ATF group. We only have  $24 - 6 = 18$  magnets left.



**ATF2  
Magnets**

# New Magnets Being Made for the ATF2: STATUS by Cherrill Spencer (SLAC) pg 1/10

- **29 new FF and extraction line quads (“QEA”)** been made by IHEP, Beijing and measured at KEK. Mika Masuzawa will report on measurements in this session
- **3 new dipoles B1,B2,B5** to be made: all one style.
- **5 new sextupoles** are needed: 3 in the FF: SD4, SF5 and SF6 and 2 in the “final doublet” (FD) (interleaved with final 2 quads): SF1 and SD0
- **2 new FD quads** : QF1 and QD0
- **NEW skew quads** (heard about at dinner last night!)





**ATF2  
Magnets**

## New Magnets Being Made for the ATF2: Philosophy & Constraints

- In general we are taking steps to minimize the cost of the new magnets and to produce them in **timely way** (goal: all new magnets at KEK by end October 2007)
  - Using existing magnets
  - Using existing magnet movers
  - Modifying existing magnet designs
- Constraints on magnet sizes, apertures, coil ends, operating currents & voltages, from:
  - Fit in with existing movers
  - Beam height from floor of 1.2 m
  - Interface with 2 different styles of BPMs
  - Fit in with new power supply's current & voltage



**ATF2  
Magnets**

# Design of ATF2 dipole: 3D figure

Bases for alignment tools

Magnet can be split for installation in the beam line & precise re-assembly

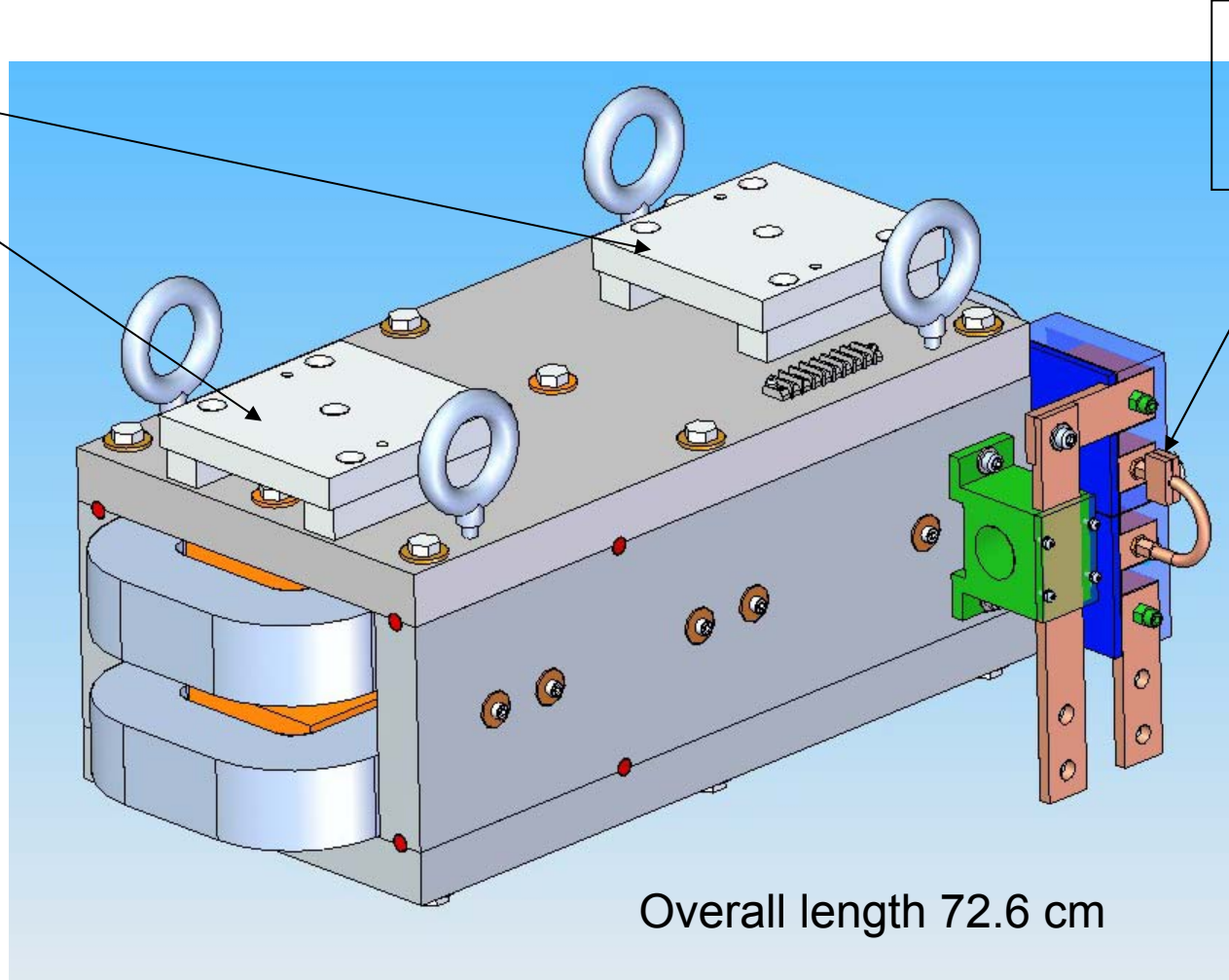

Thermal switch; one water circuit

Power terminals oriented to receive power cables from floor

Overall length 72.6 cm



**ATF2**  
**Magnets**

## Status of ATF2 B1, B2, B5 dipoles

- Since last project meeting (May 2006)
  - New design modelled in POISSON to achieve small enough sextupole content; reviewed
  - Detailed drawing package generated; reviewed
  - Manufacturing specifications for coils, core & magnet assembly written
  - 3 potential USA magnet vendors identified
  - Statement of work written; pre-purchase order paperwork done
  - Request for bids went out on 20<sup>th</sup> December 2006



## ATF2

### Magnets

Two old FFTB quads: 1.38Q17.72. are ready to have their poletips machined back to become QD0 & QF1

- After several discussions decided to make bore aperture 50mm:
  - quad bore diameter=  $40 + 2 \times 3.5 + 2 \times 2 = 50$  mm    3.5mm=Cu beampipe thickness; 1mm= free space
  - have modelled in POISSON, see next slide for multipoles
- Solid steel core
- Water cooled coils, 24 turns of 0.255" sq hollow Cu conductor; 2 water circuits per coil.
- Predicted currents and voltages:
  - QD0: 127.9 amps, 8.85 volts,  $\Delta T = 1.77$  degrees C
  - QF1: 69.8 amps, 4.88 volts,  $\Delta T = 0.53$  degrees C
- STATUS: Identified machine shop with Electric Discharge Machine (EDM) that can machine back the poles (at LBNL), will send quads there in January 2007



**ATF2  
Magnets**

## Issue of fitting the 2 “FD” quads and 2 “FD” sextupoles on the “CLIC” table

- Was worked on in detail at a special meeting at LAPP in Annecy, France in October. A session this afternoon will deal with the IP configuration further.
- We concluded that all 4 magnets and their movers would fit on the CLIC table and the “QC3” mover assembly would have to be modified so that the center of the magnets’ bores would sit at 1.2 m off floor. CLIC table is 0.874m tall (same, on or off)

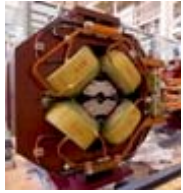

## ATF2

### Magnets

# Status of the 5 new ATF2 sextupoles

- **Five new sextupoles** are needed: 3 in the FF: SD4, SF5 and SF6 and 2 in the “final doublet” (interleaved with final 2 quads): SF1 and SD0.
- Considerations of available Z space and height of ATF2 beam lead us to make new and different designs for the FF and FD sextupoles.
- **SF1 & SD0 constraints:**
  - will have (large) S-band BPMs attached to their core
  - their bore should match the QD0/QF1 bore (= 50 mm)
  - Cores can be somewhat longer than 90mm [am concerned about shortness of core relative to bore: fringe field effects]
  - their cores need to fit in with an FFTB mover & must put center of bore at 1.2m from floor
  - Current to be less than 50 amps, voltage less than 30 volts



**ATF2  
Magnets**

## Status of the 5 new ATF2 sextupoles, continued

- **FF sextupoles:** another new design needs to be made with these features:
  - Bore to be same as adjacent QEA quads: 32 mm diameter
  - Coil end shape to be compatible with a C-band BPM
  - Core to be ~90mm long (OK with a 32 mm bore)
  - Bottom of core to be flat, to sit directly on a “QMAG” mover T plate. Distance between core bottom and bore center to be 295mm
  - Vertical distance between bottom of T plate (under a mover) and magnet bore center to be 541 mm.



## ATF2 Magnets

# Idea for the FF and FD sextupoles

Proposed core shape- with flat bottom. Size would differ for the 2 styles

Calculations indicate that coils can be designed to meet PS requirements and have desired integrated strengths.

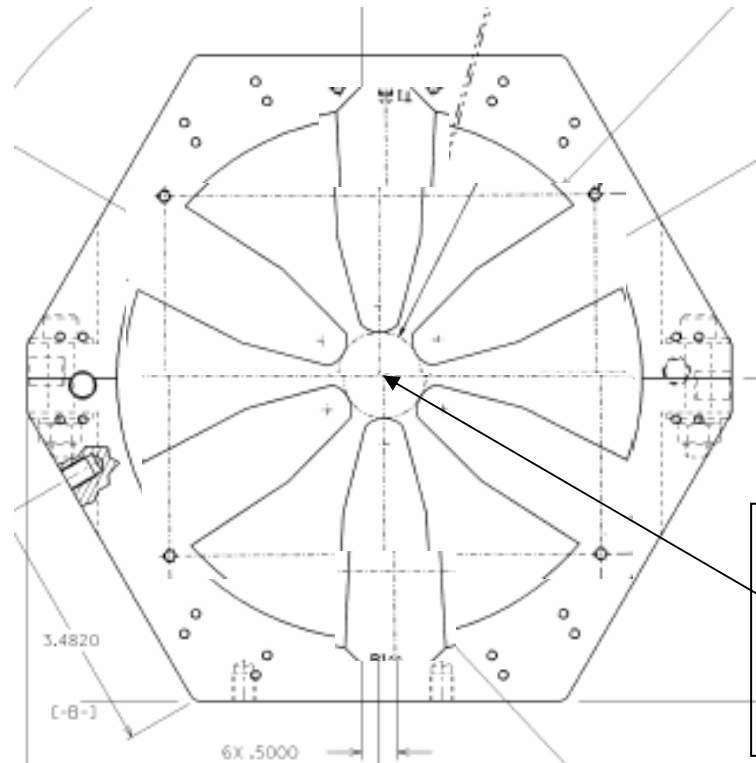

Actual models will be developed in January 2007 and run in POISSON.

Goal : all new magnets to be delivered to KEK by October 31<sup>st</sup> 2007.

Proposed Core shape.  
Bore apertures:  
50mm for SD0/SF1  
32 mm for SD4,SF5,SF6



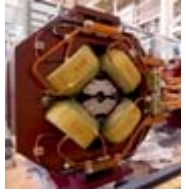

**ATF2  
Magnets**

## Movement of old FFTB movers & outstanding issue

- Sending 24 less wide movers & their electronics and cables to KEK already
- Sending one wide mover and 3 less wide movers & their electronics and cables to LAPP this week (I hope)- several month loan. Will eventually come to KEK.
- Need an adjustable stand under the dipoles- who to design and build?