

Next R&D steps for ILC TPC

Beijing Tracking Review

T. Matsuda

In Behalf of the ILC TPC Collaboration

5 Feb. 2007

Where We Are?

1 Demonstration Phase (- 2006): Previous three talks

Mapped out MPGD operation for ILC TPC
Measured spatial resolution with small TPC prototypes
Proving the potential of MPGD TPC as a tracker at ILC.

2 Consolidation Phase (2006 – 2011) : This talk

The LC TPC collaboration, together with EUDET, builds a Large TPC Prototype (LP) with EUDET infrastructure as basis
To prove the MPGD TPC as a precision tracker at ILC
Some remaining important issues such as the choice of the best gas and the gating scheme are also addressed.

3 Design Phase

Through the consolidation phase, we expect that a consensus as to which endplate technology to be the best for the LC TPC may be approached. The final decision of the design of LC TPC shall be made as the experimental collaboration is formed.

Demonstration Phase

(1) Studied the new gas amplification systems for the LC TPC: GEM and MicroMEGAS

Basic characteristics of MPGD, optimal configuration and operation condition for LC TPC were studied:

gas gain, electron transmission, ion feedback, signal time structure, signal spread (PRF), gas and stability.

New structures and fabrication methods of MPGD were developed:

Larger GEM, new fabrication methods of GEM, thicker GEM, MicroMEGAS with pillars, the bulk MicroMEGAS.

New readout methods of MPGD were developed:

Resistive anode readout for MicroMEGAS, and CMOS pixel readout .

Demonstration Phase

- (2) Performed **cosmic and beam tests of MPGD TPC using small TPC prototypes** measuring signal spread (pad response), diffusion, spatial resolution and else:

MPGD TPC has shown its potential to achieve the target spatial resolution of $\leq 100 \mu\text{m}$ over the full drift distance of 2-2.5m in high magnetic field (3-5T).

Some Proofs are: (Next slide)

Spatial Resolution of MPGD TPC:

(A) **MicroMEGAS with resistive anode readout:**

Spatial resolution measured at DESY 5T (cosmic rays):

**50 μm resolution
independent of the drift
distance.**

The small diffusion constant ($20 \mu\text{m}/\text{cm}^{1/2}$) of Ar-CF₄-Isobutane mixture at high magnetic field.

Need to understand why 50 μm but not less.

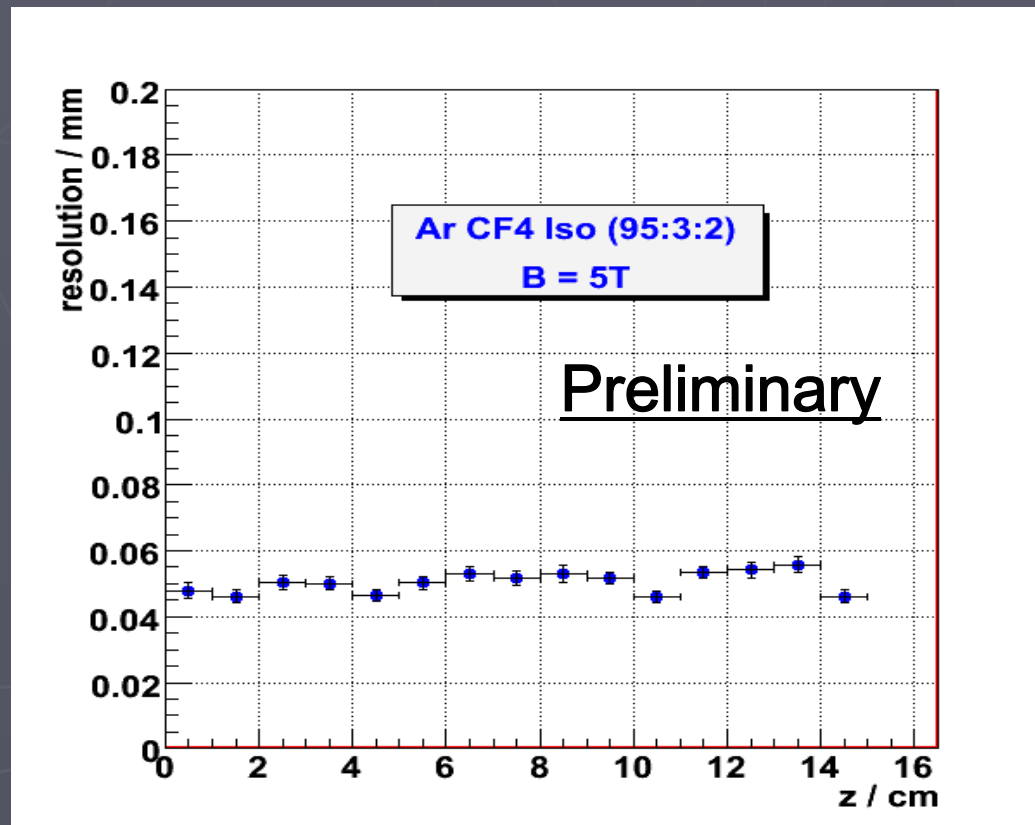

Spatial Resolution of MPGD TPC

(B) Expected spatial resolutions of **GEM TPC with narrow (1mm) pads** calculated by a new analytic formula for MPGD TPC:

Resolution: $\leq 100 \mu\text{m}$ with the low diffusion gases P5 and Ar/CF₄ (*) over the full drift length of 2- 2.5 m.

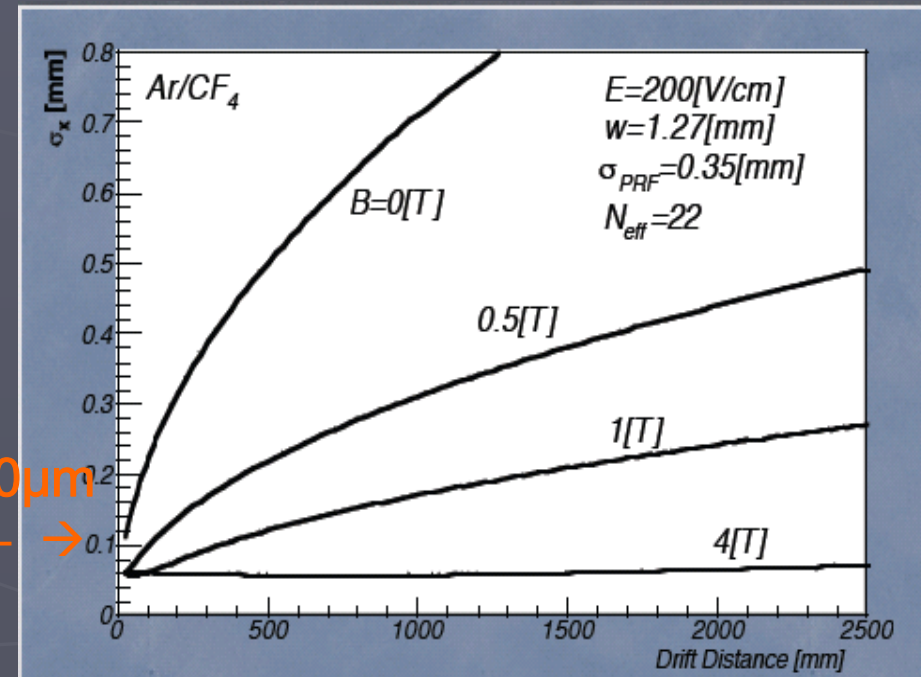
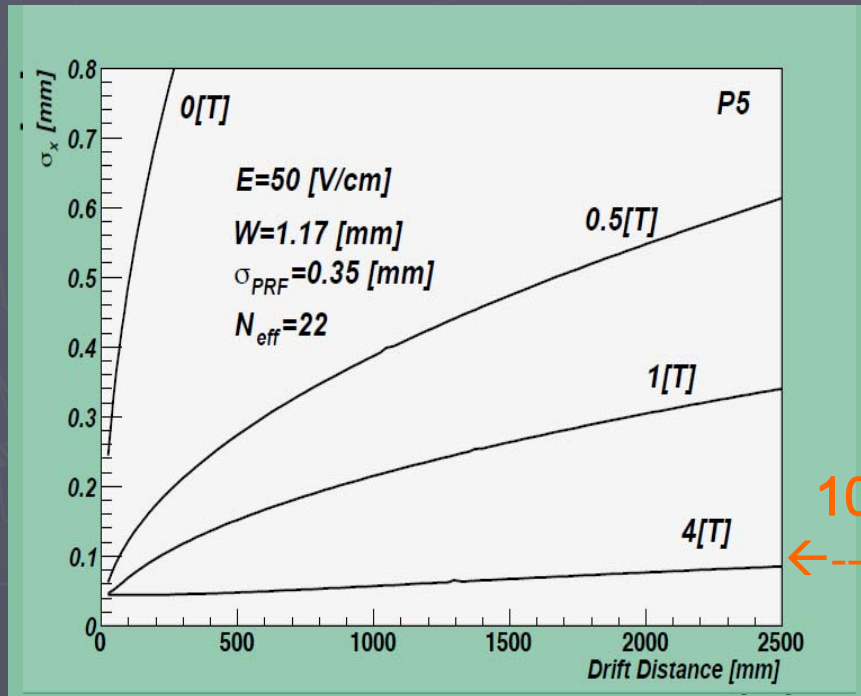

The diffusion constants calculated by the Magboltz simulation. N_{eff} for P5 assumed to be same to obtained for 0-1T.

(*)The operation of GEM with Ar/CF₄ gas has to be demonstrated.

Spatial Resolution of MPGD TPC

(C) CMOS pixel readout of MPGD TPC:

The new analytic formula predicts that:

The resolution of MPGD TPC readout by the CMOS pixel TPC, in particular, with MicroMEGAS, is possibly better than the analog readout. Since the position of individual electron is digitally measured by the pixel, the resolution is not degraded by the gas gain fluctuation.

The small avalanche size ($10\ \mu\text{m}$) of MicroMEGAS fits well for measuring each electron separately by the pixel of $50\ \mu\text{m}$.

New Analytic Formula of Spatial Resolution of MPGD TPC

Include the effect of the gas gain fluctuation.

Reproduce the beam test data and the simulation with a single parameter N_{eff} , which has a relation to the Polya distribution.

Enable us to calculate the resolution for a different gas and different magnetic field.

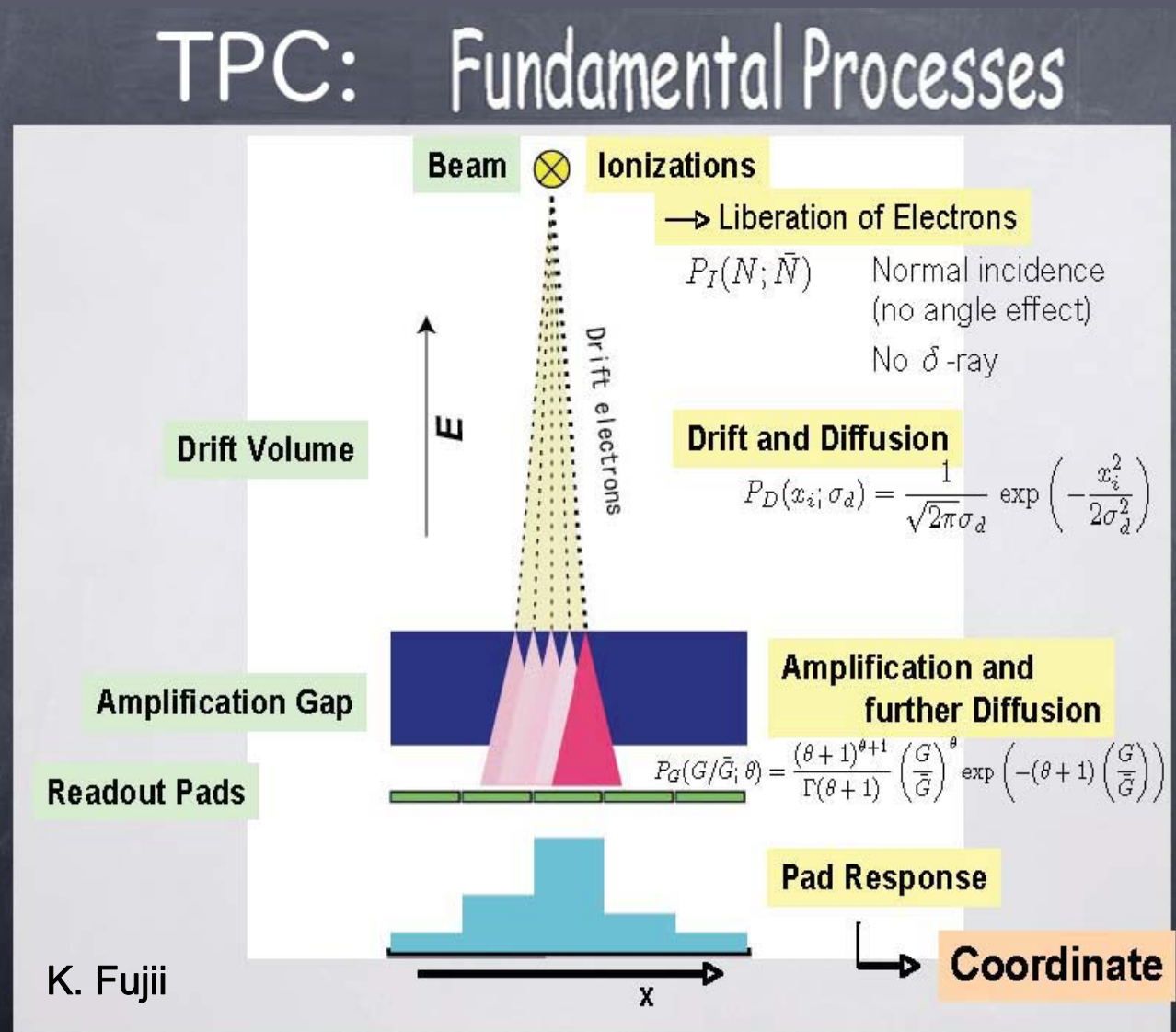

New Analytic Formula of Spatial Resolution

Reproduces the Monte Carlo

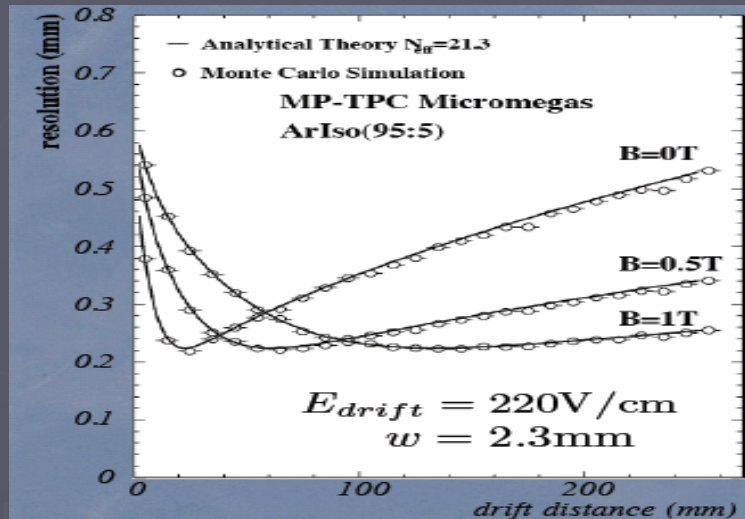

Reproduces the data

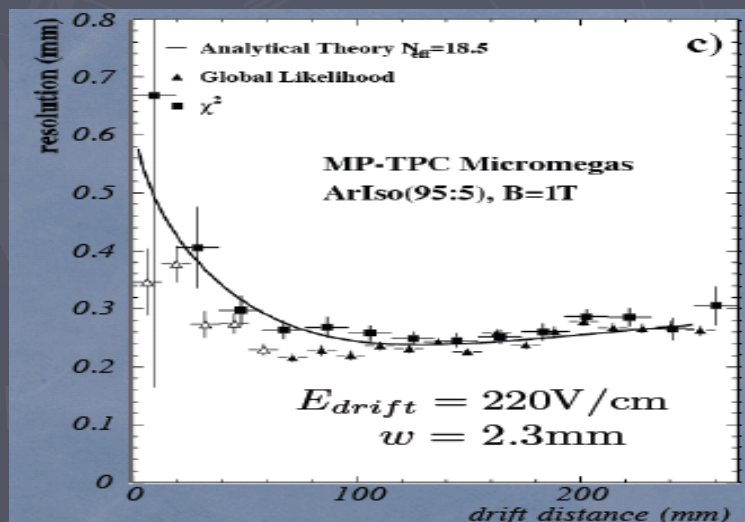

Enable us to estimate the resolution for different gases and at different magnetic field.

drift distance

$$\sigma_x = \sigma_x(z; w, C_d, N_{eff}, [f_j])$$

pad pitch

diffusion const.

pad response function

δ -fun. for MM: $\sigma_{PRF} \simeq 12\mu m$
 gauss. for GEM: $\sigma_{PRF} \simeq 350\mu m$

Demonstration Phase

Three candidates for the LC TPC:

1. Multilayer GEM TPC with the standard and narrow pads:

The wider signal spread (PRF $\sim 350\mu\text{m}$) matches with the standard, narrow pads of $\sim 1\text{mm}$ wide.

2. MicroMEGAS TPC readout by the resistive anode:

The narrow signal spread (PRF $\sim 10\mu\text{m}$) requires a signal broadening by the resistive anode for $O(1\text{mm})$ wide pads.

3. MPGD TPC readout by the CMPS pixel (TimePix)

With the narrow signal spread (PRF $\sim 10\mu\text{m}$) of MicroMEGAS, the CMOS pixel readout of the fine cells ($50\mu\text{m}$) can digitally measure the location of each drift electrons. Since the digital readout is free from the gas gain fluctuation, better spatial resolution can be expected.

What Next?

Consolidation Phase

- Spatial Resolution ($r\phi$): $\leq 100 \mu\text{m}$ over the drift distance of 2-2.5m
- Choice of chamber gas: Low diffusion at high magnetic field, neutron background, stable operation, aging, gating

- Momentum Resolution: $\leq 1.0 \times 10^{-4}$ PT (TPC alone)
- Correction of field non-uniformity and other distortions
- Calibration, alignment and correction.

- Ion feedback, the effects of ion build-up and gating scheme.
- Beam backgrounds: Impact to the selection of gas and ion feedback.

- Readout electronics and cooling for LC TPC
- Thermo-mechanical design of endplate
- Material/space of the TPC endplate:

- Technology choice and overall TPC design (may be by the experimental collaboration)

Consolidation Phase Study Plan

(1) Study with Large TPC Prototype (LP):

Demonstrate full volume trucking in non uniform magnetic field with the best-at-present MPGD TPC candidates, providing a proof of the target momentum resolution at LC TPC.

Demonstrate dE/dX capability of MPGD TPC.

Study the effect of boundary between detector modules.

Demonstrate basic designs and fabrication technologies of endplate, detector module, field cage and front-end electronics.

Develop methods and software's of calibration, corrections and alignment.

(2) Study remaining critical issues using small TPC prototypes:

Search for the best gas (also neutron background gating).

Study ion feedback and gating scheme.

Study the CMOS pixel readout in larger scale.

Consolidation Phase Study Plan (cont.)

(3) Development of readout electronics for ILC TPC (including cooling) :

(This topics is covered by Madhu)

(4) Studies by simulation and development of software tools:

(This topics is addressed by Dan)

Tracking method (also for the CMOS pixel readout)

Double track separation and tracking efficiency.

Tracking in non-uniform magnet field

Alignment

Effect of ion build up and gating

Distortion correction

Effect of backgrounds on tracking

.....

LC TPC Collaboration

To perform the Large TPC Prototype test, **the world-wide LC TPC collaboration** was formed in November, 2006. Most of TPC R&D groups in North America, Europe and Asia join the collaboration.

We have set up **the collaboration board** and **the technical board**. A **spokesperson** has been selected among **three regional coordinators**. The collaboration board and the technical board are having phone meetings regularly, once for two weeks.

The collaboration formed **4 work packages, with sub-packages under them**, to work on the large TPC prototype. Some of them are active already but some not yet. We will go back to work immediately after this review.

The collaboration closely cooperates with **EUDET** benefiting from the EUDET facility.

LP TPC Collaboration

Work packages

Work-package (1) Mechanics:

LP design (Dan Peterson)

Cornell, DESY, MPI, Orsay, EUDET

Field cage, Laser system and Gas system (Ties Behnke)

Aachen, DESY, St.Petersburg, EUDET

GEM modules for endplate (Akira Sugiyama)

Aachen, Carleton, Cornell, DESY/HH, KEK/CDC-group, Victoria

MicroMEGAS modules for endplate (Paul Colas)

Carleton, Cornell, KEK/CDC-group, Saclay/Orsay

CMOS pixel modules for endplate (Jan Timmermans)

Freiburg, Nikhef, Saclay, /Orsay, EUDET

Resistive foil for endplat: (Madhu Dixit)

Carleton, KEK/CDC-group, Scalya/Orsay

Work-package (2) Electronics:

Standard RO/DAQ system for LP (Leif Joenson)

Aachen, CERN, DESY/HH, Lund, Rostock, Montreal, Tsinghau, EUDET

CMOS RO electronics (Harry van der Graaf)

Freiburg, Nikhef, Saclay, EUDET

Electronics with power switching and cooling for LPTPC (Luciano Musa)

Aachen, CERN, DESY/HH, Lund, Rostock, Montreal, St. Petersburg, Tsinghau,
EUDET

LP TPC Collaboration Work Packages (cont.)

Work-package (3) Software:

LP software & framework (Peter Wienemann)

DESY/HH, Freiburg, Carleton, Victoria, EUDET

LCTPC simulation (Stefan Roth)

Aachen, Carleton, CERN, Cornell, DESY/HH, KEK/CDC-group, St.Petersburg, Victoria

Full detector simulation and performance study (Keisuke Fujii)

DESY/HH, KEK/CDC-group, LBL

Work-package (4) Calibration:

Field map for LP (Lucie Linsen)

CERN, EUDET

Alignment: (Takeshi Matsuda)

CERN, KEK/CDC-group

Distortion correction (Dean Karlen)

Victoria

Radiation of hardness of material (Anatoly Krivchitch)

St. Petersburg

Gas/HV/Infrastructure for LP (Peter Schade)

DESY, Victoria EUDET

LP TPC Collaboration

EUDET

EUDET		Detector R&D for the International Linear Collider	
Proposal full title	Detector R&D towards the International Linear Collider		
Proposal acronym	EUDET		



Schematical Overview.....	2
Fundamental Objectives	22
Networking Activities	27
I. Overall Information	27
II. Activity NA1 – Management of the I3	28
III. Activity NA2 – Detector R&D Network DETNET	37
Transnational Access Activities	45
I. Overall information.....	45
II. Activity TA1 – Access to DESY Test Beam Facility	46
III. Activity TA2 – Access to Detector R&D Infrastructure.....	51
Joint Research Activities	55
I. Overall information	55
II. Description of Joint Research Activities.....	66
Other Issues	88

EUDET project is for infrastructure for detector R&D, but not yet the R&D itself, to which all of the TPC R&D groups will have to contribute if the LP is going to be successful.

EUDET will provide a basis for the LC TPC groups to help get funding for the LP and other LC TPC work.

Large TPC Prototype: Two Stages

The LC TPC collaboration is still two month old and planning of the large TPC prototype is still evolving. Discussion here, in particular, of LP2, is preliminary.

Stage 1: LP1 (2006-2009)

Two endplates, detector module and field cage
of rather simple structure.

With the standard electronics mounted via connector/cable.

In 1T magnetic field.

Stage 2: LP2 (2010 -) Currently only ideas

With a prototype LC TPC electronics mounted directly on the detector module.

Built-in cooling capability of detector module.

Endplate and detector module with advanced light material.

With larger detector modules (if advantageous).

With a full laser calibration system inside the field cage.

With a full gating scheme with high intensity beam.

In multi-particle (jet) environment with high energy hadron beam.

In higher magnetic field.

.....

Large TPC Prototype Test Beam Options

LP1 → DESY 6.5GeV/c beam

LP2 → FNAL high momentum hadron beam (most probably)

Testbeam Options		
Lab	Beams	Availability
CERN SPS	10-400GeV e, h, μ	LHC absolute priority
DESY	1-6.5GeV e	> 3 months per year
Fermilab	1-120GeV e, h, μ	Continuous (5%), except shutdown
IHEP Protvino	1-45GeV e, h, μ	One month, twice per year
KEK Fuji	0.5-3.4GeV e	From fall 2007, 240 days per year
SLAC	28.5GeV e (primary) 1-20GeV e, h (secondary)	Parasitic to PepII, non-concurrent with LCLS

Large TPC Prototype: DESY Test Beam T24

Electron of 1-6.5 GeV/c
Beam available > 1/3 of year
Si-pixel beam telescope by EUDET
Si-strip detectors on PCMAG/Field cage

Rates	Target	
Energy	3mm Cu	1mm Cu
1 GeV	~330 Hz	~ 220Hz
2 GeV	~500 Hz	~330 Hz
3 GeV	~1000 Hz	~660 Hz
5 GeV	~500 Hz	~330 Hz
6 GeV	~250 Hz	~160 Hz

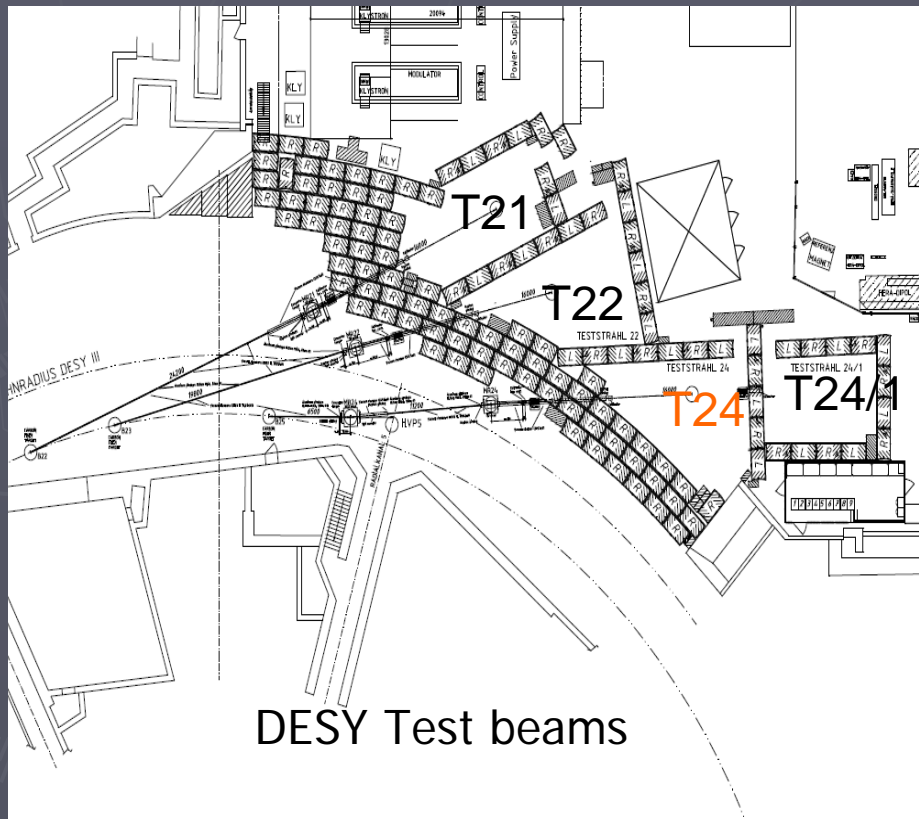

DESY Test beams

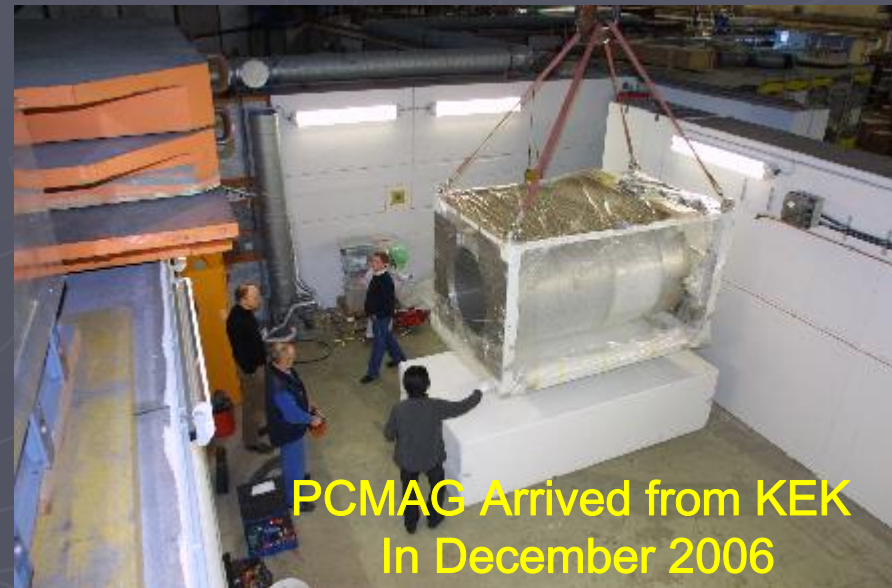

PCMAG Arrived from KEK
In December 2006

Large TPC Prototype (LP1): PCMAG

PCMAG: An Open Magnet with Thin coil and Cryostat:

Coil diameter	1.0 m
length	1.3 m
Cryostat outer diameter	1.18 m
Inner diameter	0.85 m
Length	2.15 m
Liq. He capacity	240L
Liq. He life time	10 days
Central magnetic field	1 - 1.2T
Operational current	430A
Field decay time	> 1 year
Transparency	0.2X
Total weight	460 kg



Used in the MP-TPC beam tests at KEK. Transferred to DESY and tested in December 2006. To be instrumented with a movable table, a field cage support and Si-trip detector system in 2007. Precision field map by the CERN magnet group scheduled in 2007.

Large TPC Prototype (LP1): Non-uniform Magnetic Field at ILC

At ILC, to guide out back-scattered photons/electrons from the pair background into the exit holes, an anti-DID (Detector-Integrated-Dipole) are to be integrated to the detector magnet. The max. radial field component is at the level of a few % similar to PCMAG.

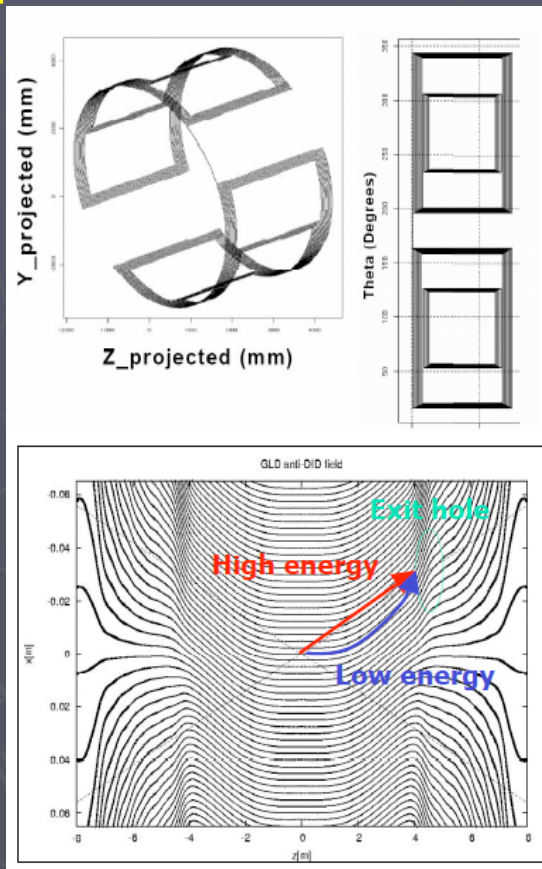

ILC magnetic field

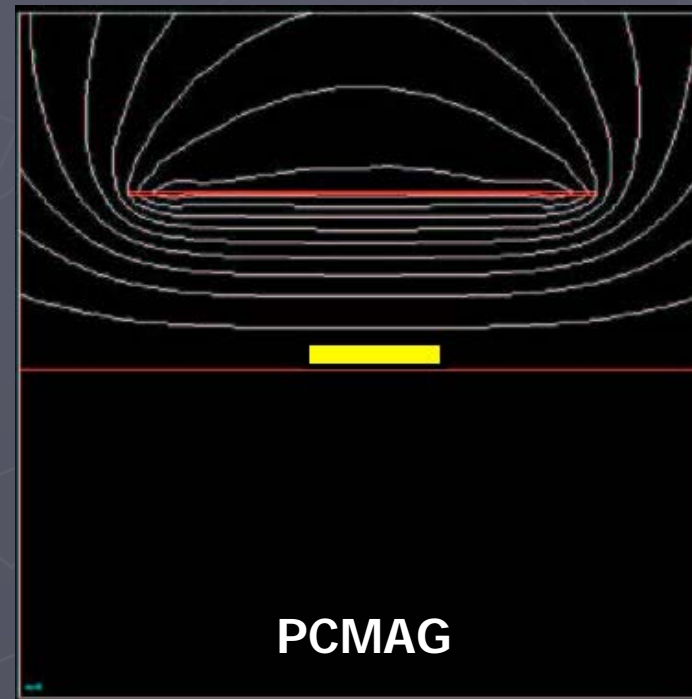

Large TPC Prototype (LP1): PCMAG and Field Cage

Superconducting Magnet PCMAG

- PCMAG will be installed in DESY test beam
- Diameter: 86 cm

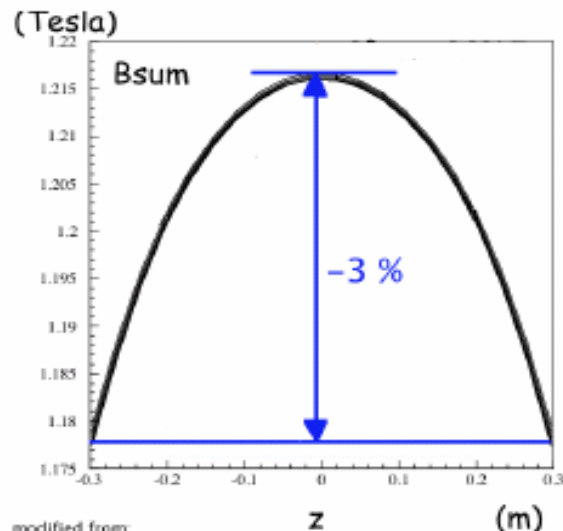

modified from:
B calculation of S_JACEE magnet, Sakamoto/Sugiyama saga univ.

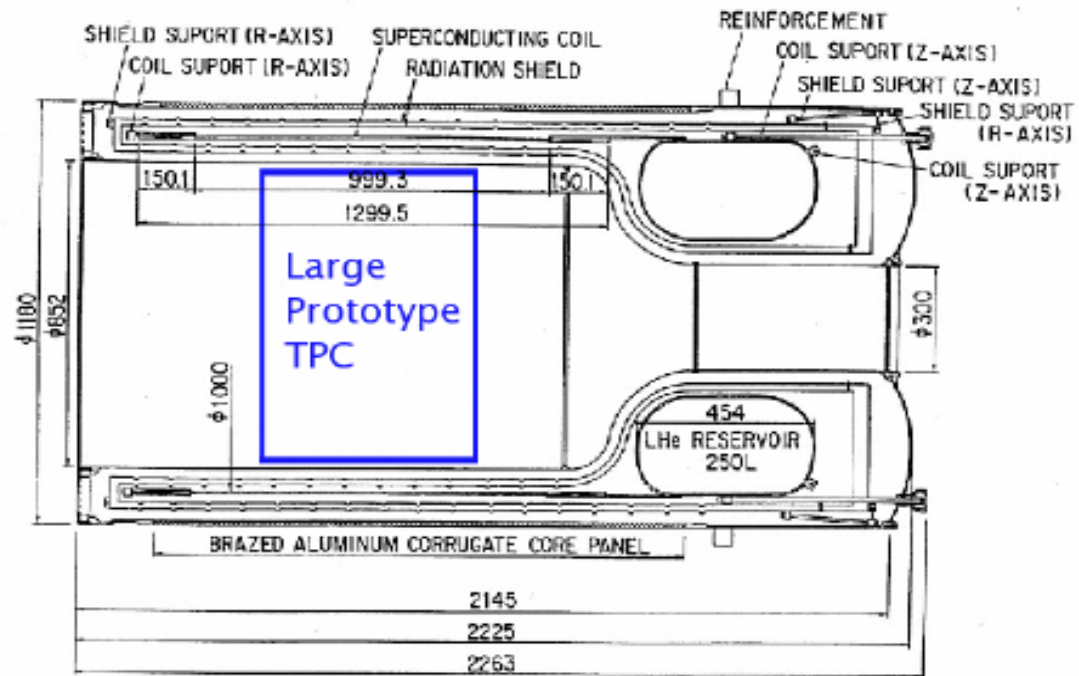

BALLOON-BORNE EXPERIMENT WITH A SUPERCONDUCTION
MAGNET SPECTROMETER, Akira Yamamoto, KEK, 01.12.94

Large TPC Prototype (LP1): Field Cage

The design of the field cage is now converging. The structure at the beginning will be simple. Implementation of a laser system, a Xenon lamp system have been discussed for next stage. The field cage is a part of the EUDET project.

Max. 300V drift field (21kV)

Aim at $\delta E/E \leq 10^{-4}$

The light weight composite structure of honeycomb and glass fiber layers. Filed shaping strips and its mirror strips inside for better E-field.

Two prototype field cages built and under test at DESY.

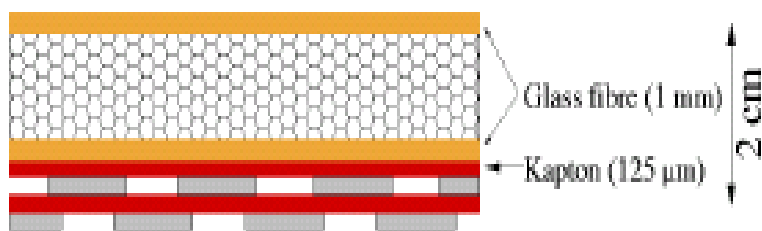

LP Wall

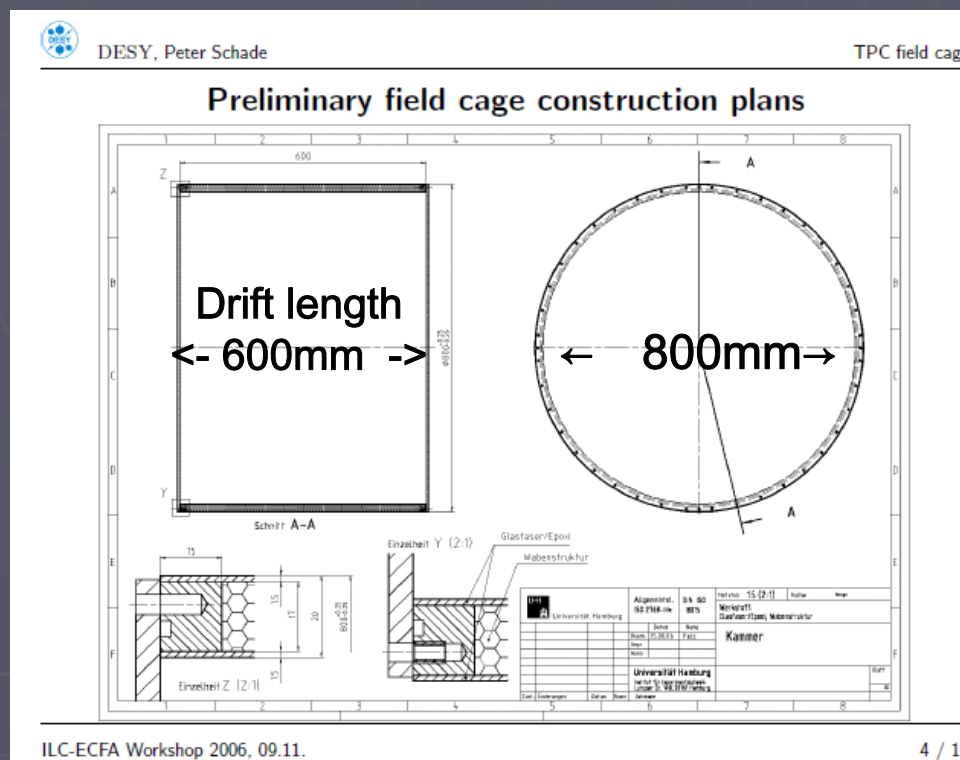

ILC-ECFA Workshop 2006, 09.11.

4 / 13

The diameter of 800mm leaves a few cm space for silicon strip detectors and a support inside PCMAG.

Optimized design with mirror strips

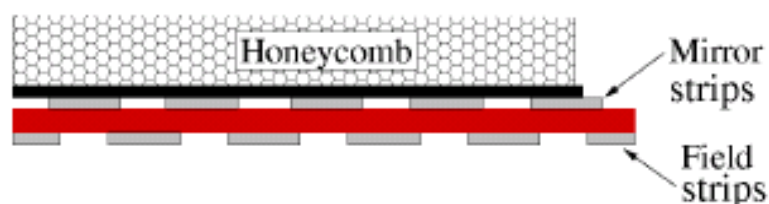

- Mirror strips are placed behind the field strips
- Each mirror strip has the intermediate potential of two strips in front
- Result: No \vec{E} -field deviations
- Foil will have a thickness of $75 - 100 \mu\text{m}$

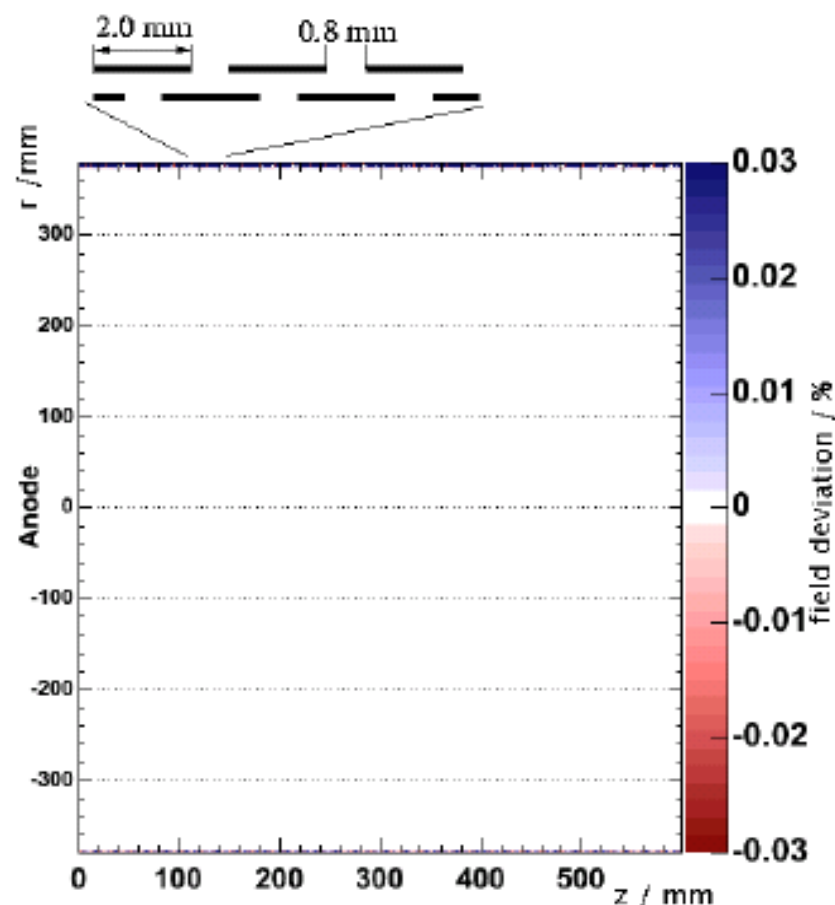

Large TPC Prototype (LP1) : Endplate

The same design is used for two endplates; GEM and MicroMEGAS. Detector modules are mounted on the endplate following the procedure of the ALEPH sector mounting, minimizing the gaps between the modules. Smaller COMOS pixel detector modules will be mounted on the both endplates.

- Aim at precision mechanical positioning of detector modules, though the final alignment by software.
- Gas seal: a flange structure on each detector module.
- Minimizing gaps between the detector modules.
- Do not aim at light structure using advanced material.
- No built-in cooling capability.

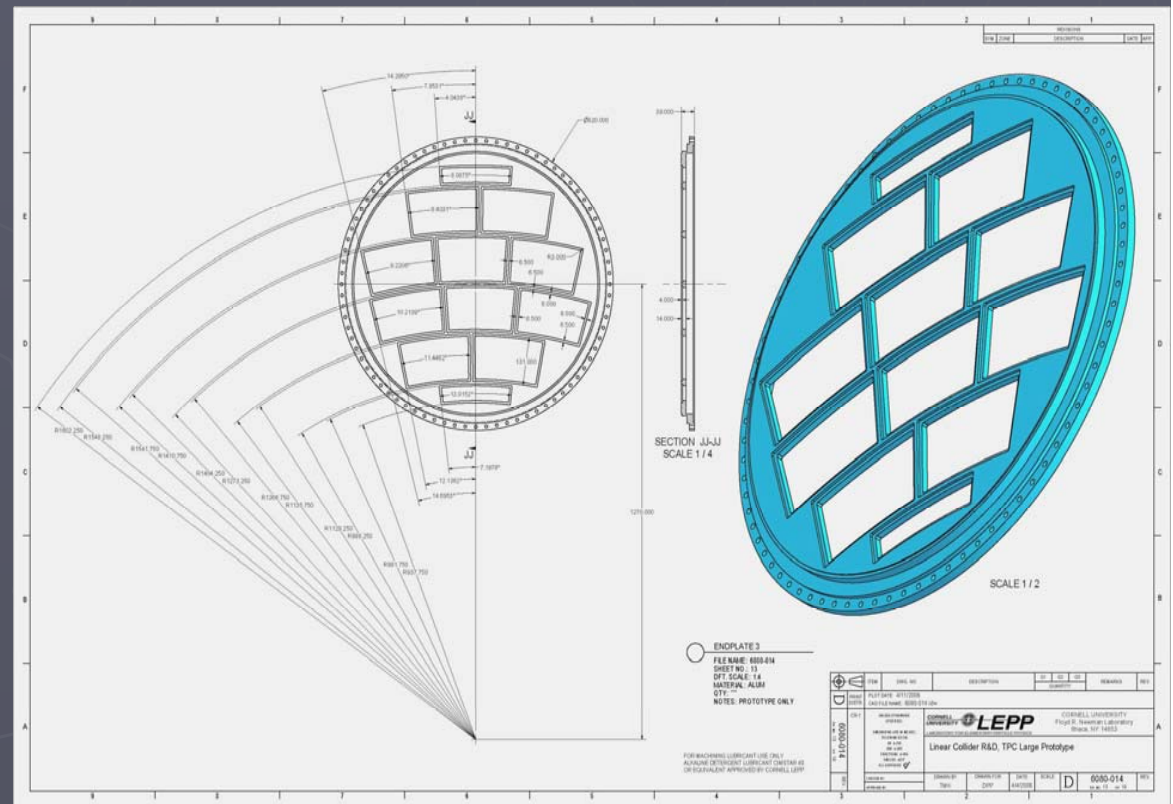

10 module design (old)

D. Peterson

Large TPC Prototype (LP1) 7 module design

The number of identical detector modules on the endplate will be 7 (left) instead of 10 (previous slide), making the size of the module a little bigger, but still within the size of the currently available GEM foil.

The design is still evolving.

The mechanical analysis is to be performed to check the stability.

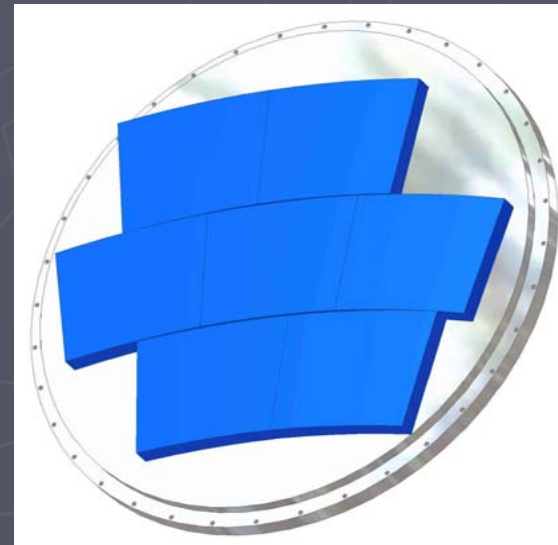
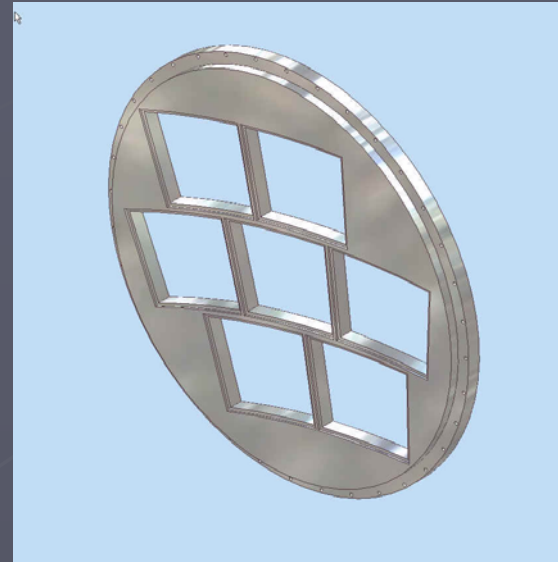

Large TPC Prototype (LP1)

Sketch of the detector module.

The detector module for the LP1 will have mini-connectors for readout electronics, while the LC TPC detector module will have the readout chips mounted directly on the back of the endplate.

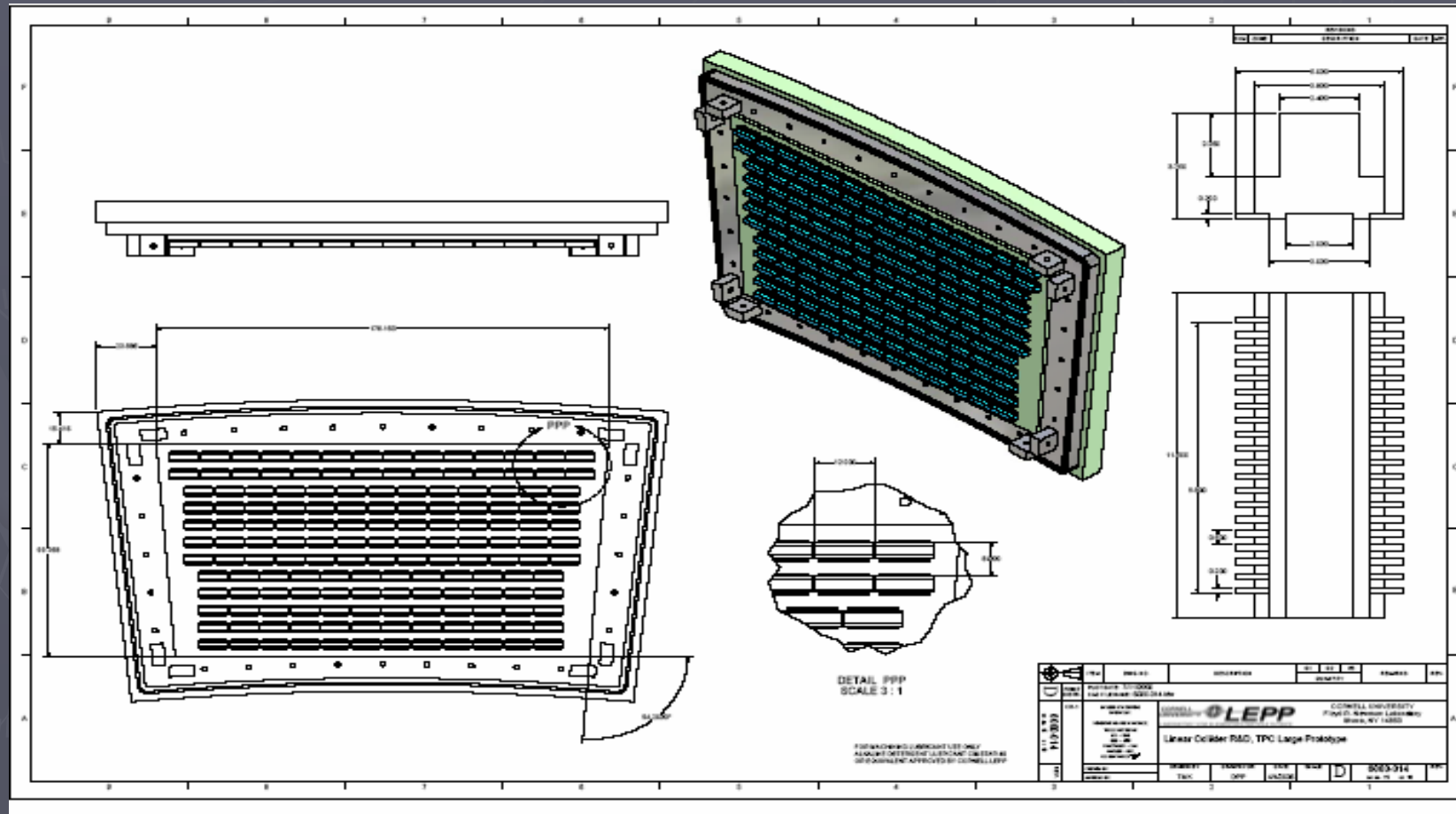

Large TPC Prototype (LP1): Pre-prototype module with GEM

A pre-prototype of the 10 module design.
Minimize dead regions in $r\phi$: no radial frame for GEM foils.
Stretch 2 layers of GEM foils (100 μ m thick) by pillars on the pad plane.

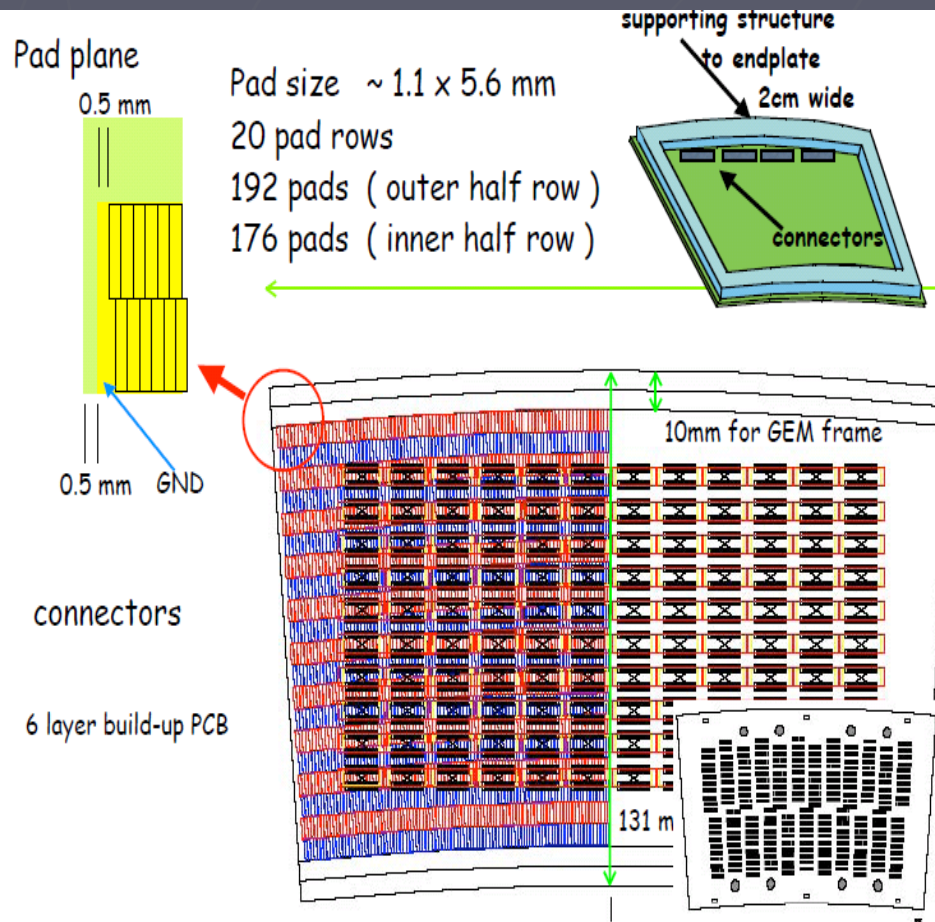

Conceptual design

frame : top & bottom frame.
no side frame

minimize dead space pointing to IP

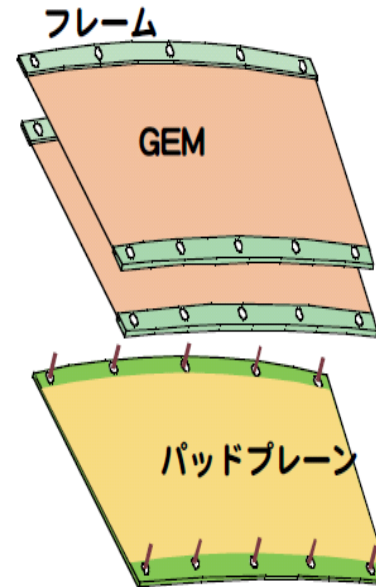

Can we stretch GEM ?

mounting(stretch) mechanism

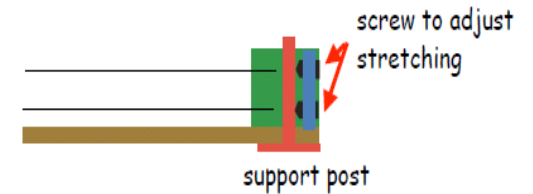

scheme test using dummy GEM



test was successful ! @Dec.14
this method seems to be OK

Large TPC prototype: Pre-prototype Module with GEM

Pre Prototype

engineering test of GEM panel

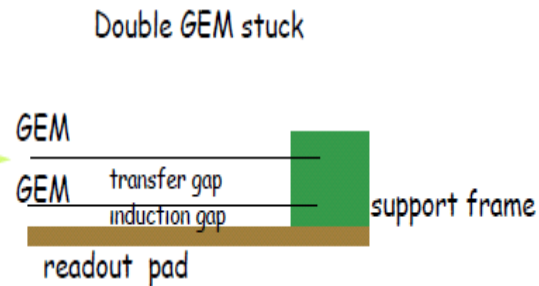
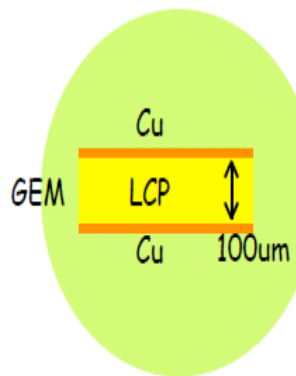

Transfer gap ~ 4mm : enlarge signal distribution
(+2mm) width > 0.3* pad pitch

Why we use 100um GEM

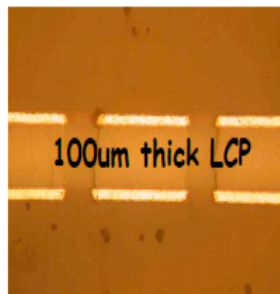

Enough gain for two GEM structure simple
stiff easy to mount ?

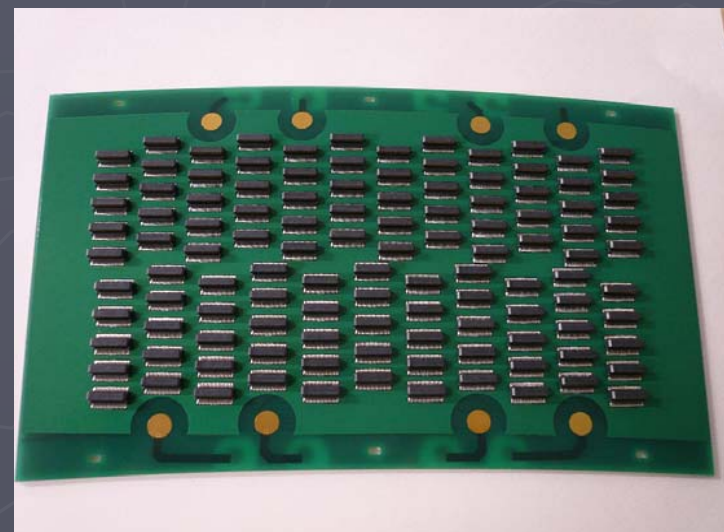
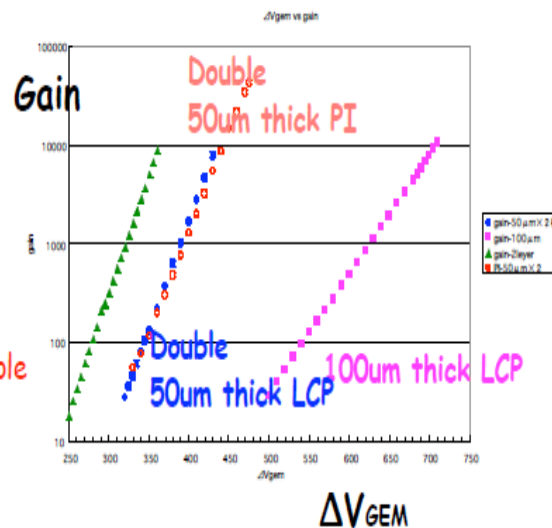

Large TPC Prototype (LP1) Pre-prototype Module with GEM

LC-TPC prototype study schedule

EUDET

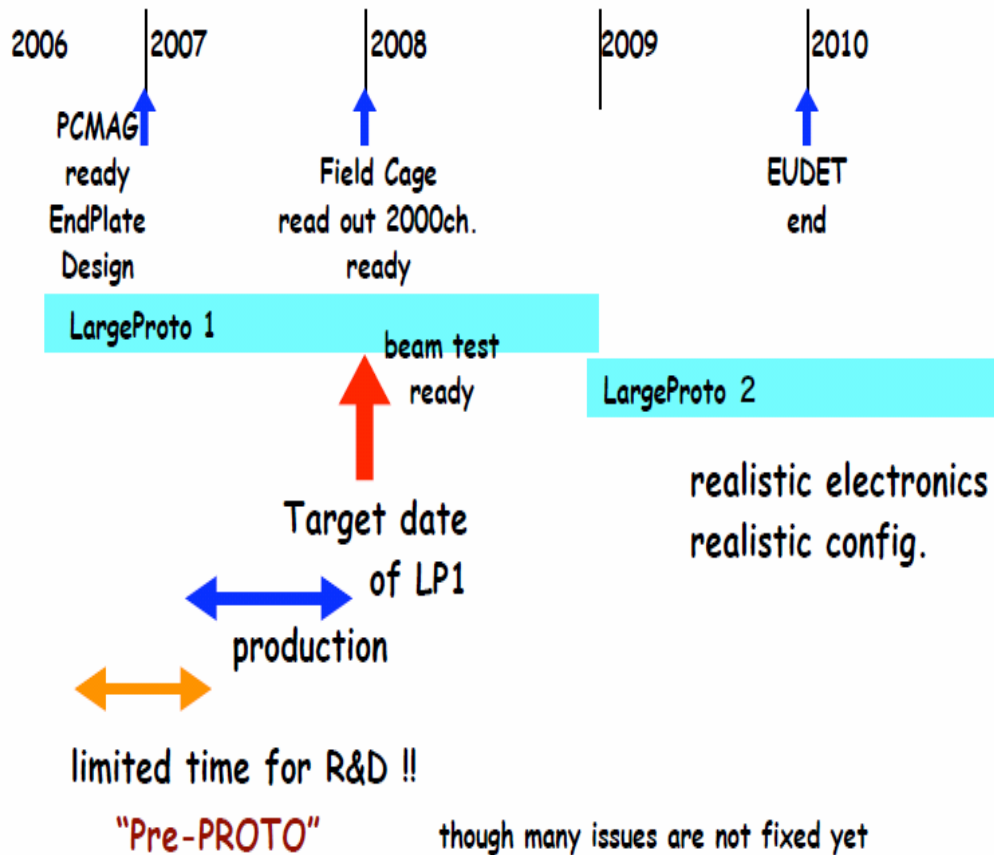

The small pad size of 1 x 5 - 6 mm for GEM requires readout electronics of 10,000ch for beam test, still covering only a part of the endplate.

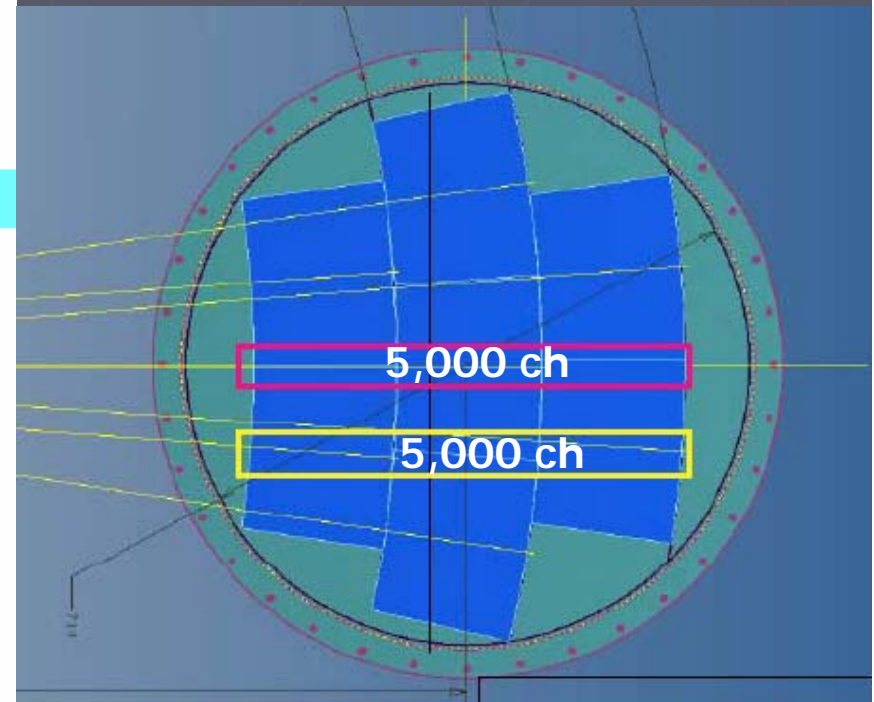

Large TPC Prototype (LP1): Detector Module with MicroMEGAS

The detector module with the MicroMEGAS will be fabricated with the bulk technology. Need to study the fabrication with the resistive foil. (RF). The module will have the same shape/size to that of GEM.

Pad sizes planed:

- 2 mm x 6 mm (standard)
- 3 mm x 7 mm (large)
- 1 mm x 6 mm (w/o resistive foil)
(only for a comparison)

Bulk technology
(T2kn3 prototype)

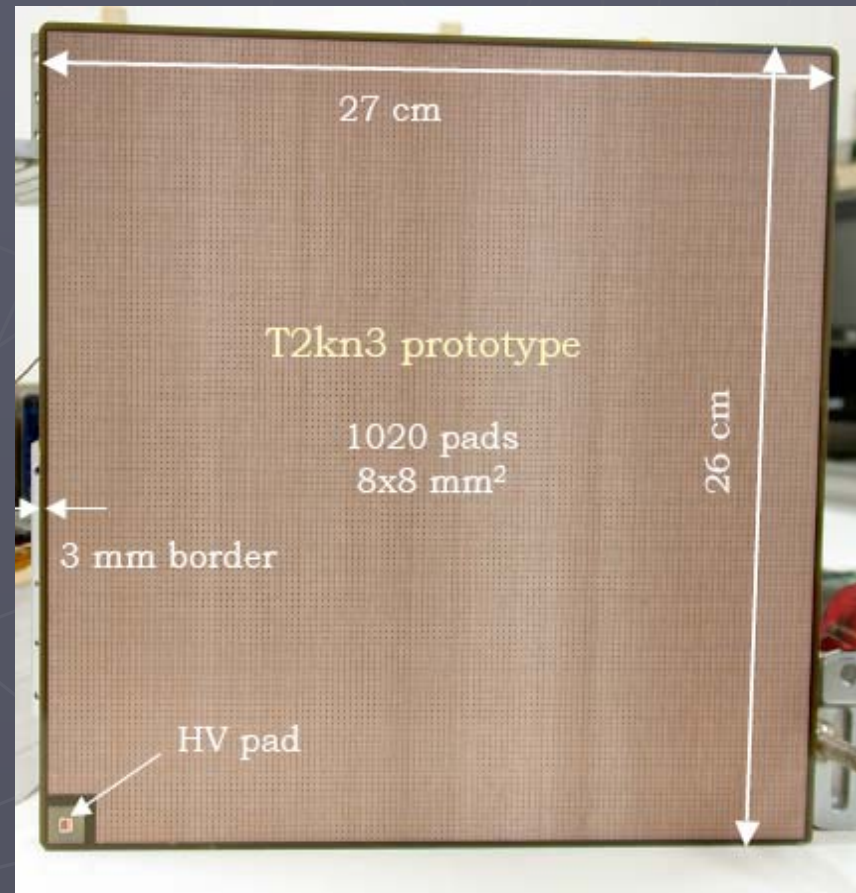

Large TPC Prototype (LP1): Readout Electronics (This topics has been covered by Madhu)

We need **a readout electronics of 10,000ch** by in an early day of 2008. The readout electronics is to be **shared between the two endplates**; GEM and MicroMEGAS. The current plan is to use **a newly designed programmable charge amplifier followed by the ALICE ALTRO chip**. EUDET builds 2,000 ch with 40MHz ALTRO chips, and the LC TPC collaboration is to provide the rest of 10,000 ch, possibly with 25MHz ALTRO chips. Alternative plans using commercial components for the additional channels are also being discussed. The DAQ system for 10,000ch is also under discussion.



ALICE ALTRO Card

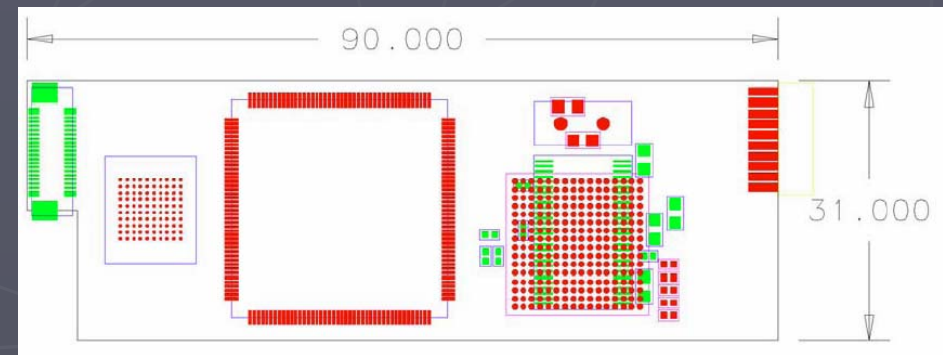

The mini-FEC new design
(based on the ALTRO chip)

Large TPC Prototype (LP1) Some Known Schedule

2006	January:	EUDET started.
	September:	The first endplate meeting (Paris). Engineering prototype of the charge amplifier tested.
	October:	EUDET annual meeting (Munich)
	November:	World-wide LC TPC collaboration formed. Regular phone meetings of the technical board started.
	December:	PCMAG transferred to DESY and tested.
2007	January:	Beijing review Field cage design converging.
	The first quarter:	Pre-prototype detector module with GEM
	Second quarter:	Submission of new programmable low noise amplifier chip
2008		Two end plates with GEM and MicroMEGAS module ready. Readout electronics of 10,000ch ready. Start beam test at DESY beam-line 24
2009		The second version of detector modules.
2010		LP1 -> LP2

Consolidation Phase Small TPC Tests

The small prototype studies in the demonstration phase

Successful operation of MPGD TPC.

Good understanding of the spatial resolution by simulations and the numerical calculation.

Simulation and analysis tools.

Studies of other features of MPGD TPC such as double track separation and ion feed back.

Still to do with the small TPC prototypes and in laboratories:

Ion Feed back and demonstration of gating.

Search for the best gas for LC TPC MPGD.

Effects of the backgrounds such as neutron.

Intensive test of the CMOS pixel TPC.

Consolidation Phase: Small Prototype Tests Ion Feed Back and Gating Scheme

ILC TPC takes data continuously for the whole ILC bunch train (~ 1 ms). The ions produced at the amplification region. Those manage to come out into the drift region through the GEM foils and the MicroMEGAS mesh slowly drift back toward the central cathode (**the ion feed back**). It takes around 500 ms to reach the central cathode.

The ion feed back rate is measured to be $O(0.1\%)$ for MicroMEGAS mesh and for the three-layer GEM when carefully biased. With the gas gain of around 1,000 -2,000, the density of ions in the drift region is a few times of those due to the primary ions.

However, when beam background is high and non uniform, we may need **the gating structure at around a few cm from the anode** (a and b). When the gating might fail in the high background condition, we have the situation like (c) where we might have significant distortion.

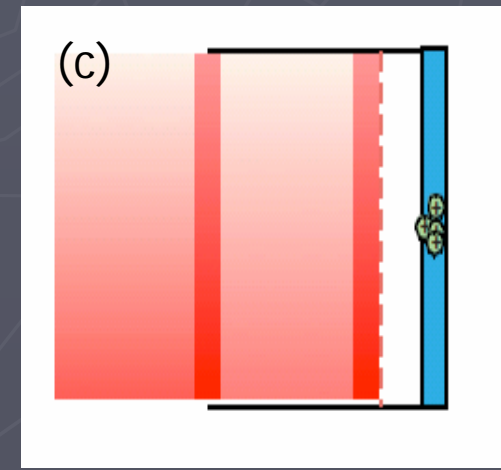
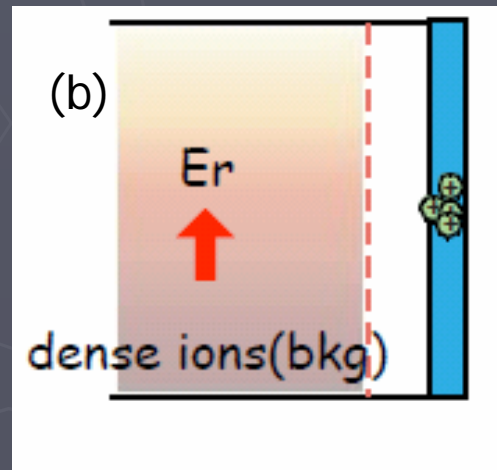
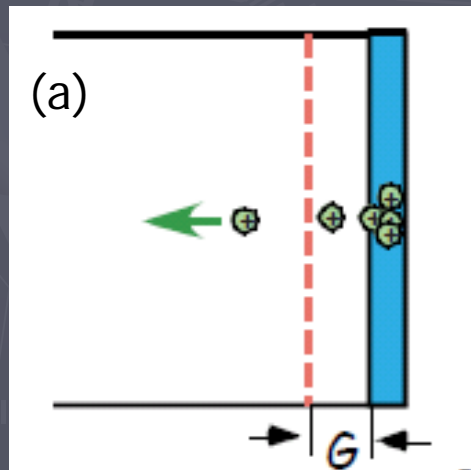

Consolidation Phase: Small Prototype Tests

Ion Feed Back and Gating Scheme

- (1) Need to continue the measurement of ion feed back rate for different gases with realistic configurations of MPGD possibly in high magnetic field.
- (2) Need full simulation of tracking in high backgrounds for realistic LC TPC configuration to evaluate the real impact of the ion feed back (without/with gating).
- (3) Study of gating schemes:
 - (a) Gating by wire: Used at LEP, PEP and Tristan. The ExB effect around wires distorts track image, and also significant impact to the mechanical structure of the detector structure to stretch wires.
 - (b) Gating by wire mesh: Need a very thin (25/500) mesh to keep high electron transmission.
 - (c) **Gating by GEM foil:** The electron transmission depends on the GEM hole size, E-fields, gas and magnetic field. The transmission measured for some gases at low bias voltages are still not high enough (at a few 10%) possibly degrading the spatial resolution significantly.

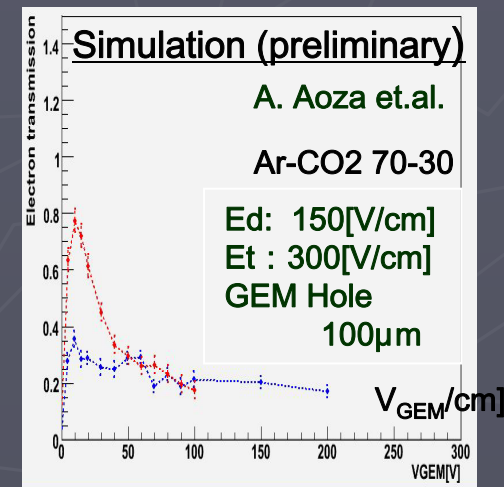
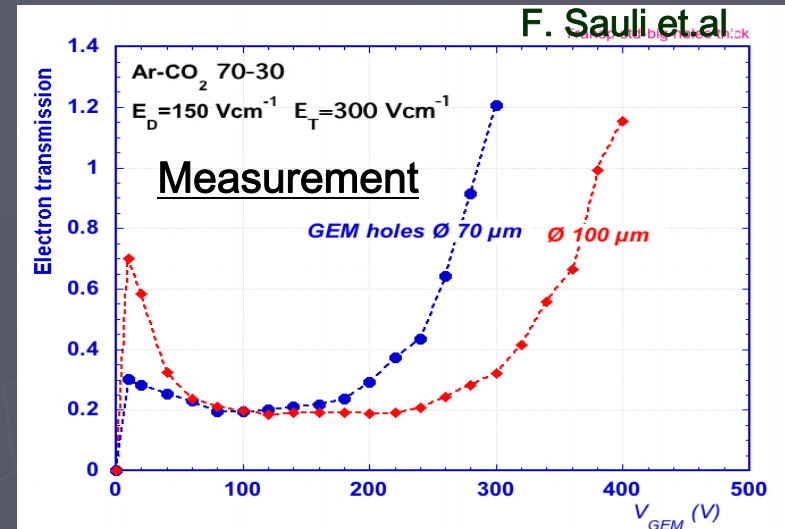

(Note that Ar/CO₂ is not a good gas at ILC.)

Consolidation Phase: Small Prototype Tests Ion Feed Back and Gating Scheme

Electron transmission for GEM gating:
Some more preliminary results (preliminary) of the simulation.
Need intensive study both by simulation and experiment.

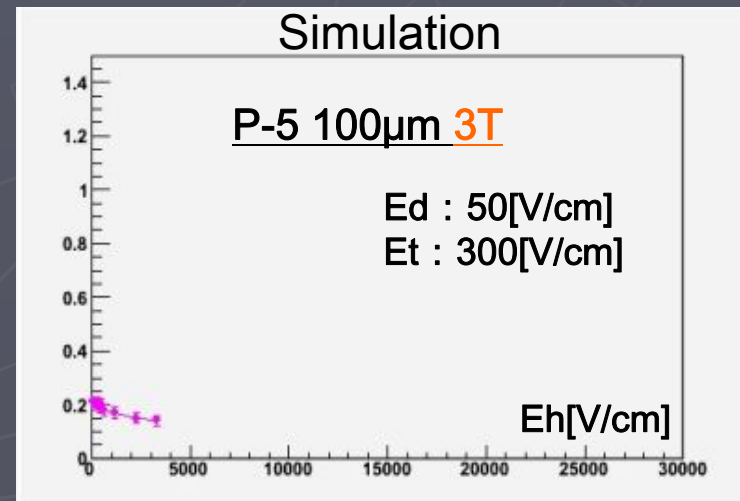
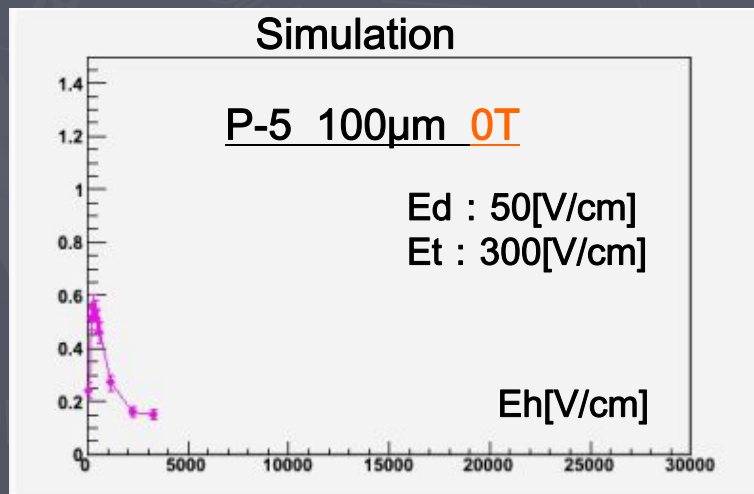
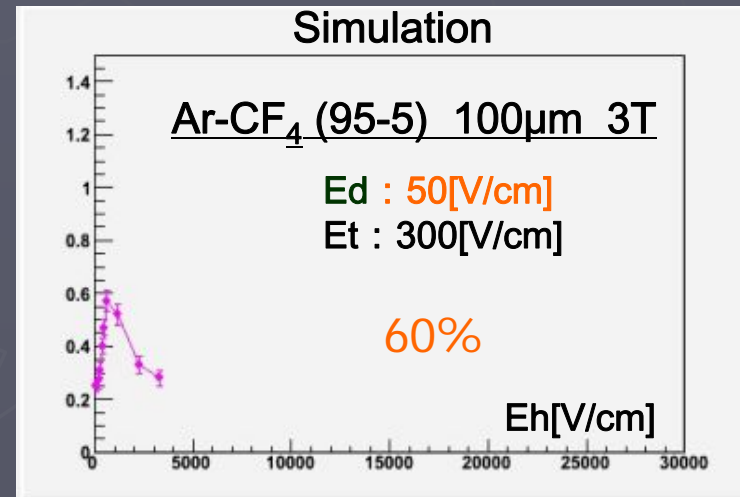
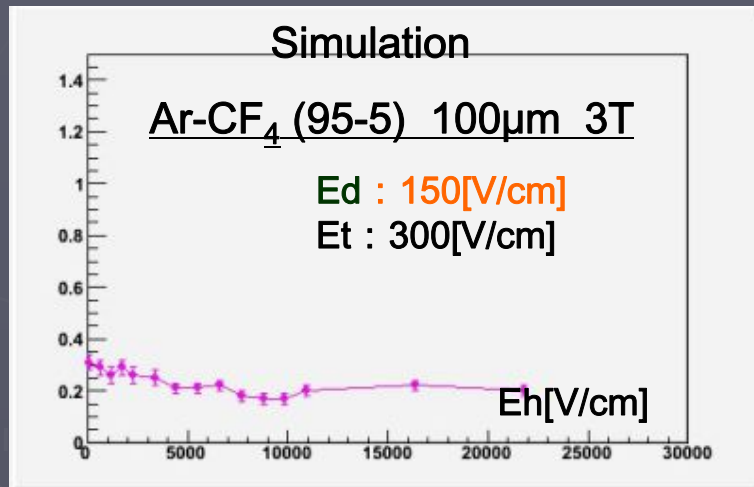

Note that the horizontal scales are Eh (v/cm) instead of V_{GEM}.

Consolidation Phase: Small Prototype Tests

Gas Study

Gas for LC TPC

It is non trivial to find the best gas to meet with all the following requirements. Need systematic study.

Low diffusion at high magnetic field (large $\omega\tau$)

- More primary electrons
- Small electron attachment
in the drift region and the amplification region.
- Drift velocity at acceptable drift field.
- Gating condition
- Neutron background: less or no hydrogen (quencher)
- Stable operation of MPGD in particular for CMOS pixel readout.
- Long term stability of TPC (aging, corrosion)

Some works to be continued/planned:

Intensive gas gain study for MicroMEGAS (Saclay)
Ar/CF₄ and other gas studies for GEM (CDC-group)

.....



Gain measurements : summary

Mesh : 50 μm gap of 10x10 size

Mixtures of gases containing argon

D Attié et. al.

- Iso : 1%
- Iso : 2%
- Iso : 3%
- Iso : 4%
- Iso : 5%
- CF4 : 3%, Iso : 1%
- CF4 : 3%, Iso : 2%
- CF4 : 3%, Iso : 3%
- x--- CH4 : 6.5%
- x--- CH4 : 8%
- x--- CH4 : 9%
- x--- CH4 : 10%
- CH4 : 8%, CF4 : 3%
- CH4 : 8%, CF4 : 5%
- CH4 : 8%, CF4 : 10%
- CH4 : 10%, CF4 : 3%
- +--- CH4 : 5%, CO2 : 3%
- +--- CH4 : 10%, CO2 : 10%
- CO2 : 10%
- CO2 : 20%
- CO2 : 30%
- ▲--- CO2 : 10%, Iso 2%
- ▲--- CO2 : 10%, Iso 5%
- ▲--- CO2 : 10%, Iso 10%
- ◇--- CF4 : 3%, CO2 : 1%
- ◇--- CF4 : 3%, CO2 : 3%
- ◇--- CF4 : 3%, CO2 : 5%
- ◇--- Iso : 2%, CH4 : 10%
- ◇--- Iso : 5%, CH4 : 10%
- ◇--- Iso : 10%, CH4 : 10%
- ◇--- Ethane 10%
- ◇--- Ethane 5%
- ◇--- Ethane 3.5%
- ◇--- Ethane 3.5% - CO2 10%
- ◇--- Ethane 3.5% - CF4 3%
- ◇--- Ethane 3.5% - CF4 10%
- ◇--- Ethane 3.5% - Iso 2%

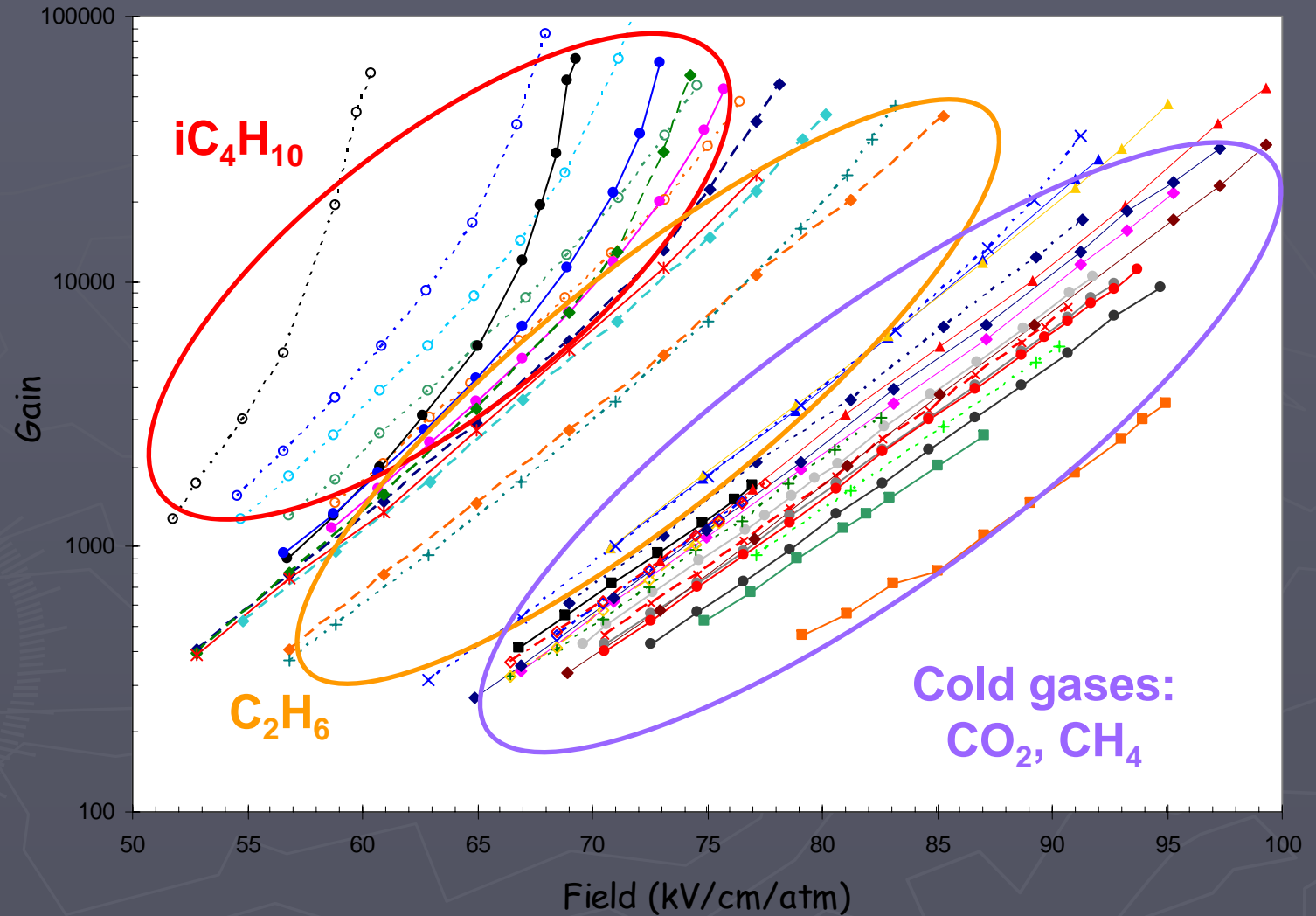

We need a similar detailed study also for GEM.

Conclusion

1 Demonstration Phase (- 2006):

Mapped out MPGD operation for ILC TPC
Measured spatial resolution with small TPC prototypes
Proving the basic potential of MPGD TPC as a tracker at ILC.

2 Consolidation Phase (2006 – 2011) :

The LC TPC collaboration, together with EUDET, builds a Large TPC Prototype (LP) with EUDET infrastructure as basis
To prove the MPGD TPC as a precision tracker at ILC
Some remaining important issues such as the choice of the best gas and the gating scheme are also to be addressed.

3 Design Phase

Through the consolidation phase, we expect that a consensus as to which endplate technology to be the best for the LC TPC may be approached. The final decision of the design of LC TPC shall be made as the experimental collaboration is formed.

End



Momentum Resolution: What We Need to Achieve?

Please remember Sugimoto san's talk yesterday
Also have listen/read the authorities: Fujii & Peskin

1. $e^+e^- \rightarrow ZH \rightarrow (Z \rightarrow \mu\mu/ee) + X:$

If $\delta M (\mu\mu/ee) \ll \Gamma_Z$,
then the beam energy spread dominates.
 \rightarrow Most probably $\delta(1/p_t) \sim 1.0 - 0.5 \times 10^{-4}$

2. Slepton and the LSP masses through the end point measurement:

σ_M (Momentum Resolution) $\sim \sigma_M$ (Parent Mass)
Only @ 1 ab^{-1} when $\delta(1/p_t) \sim 0.5 \times 10^{-4}$

3. Rare decay: $e^+e^- \rightarrow ZH \rightarrow Z + (H \rightarrow \mu\mu):$

$\rightarrow \delta(1/p_t) \sim 0.5 \times 10^{-4}$ sufficient?
 \rightarrow Still need study one more time?

Scaling of the Point Resolution

- For **delta-function like PRF**, σ_x/w depends only on σ_d/w and N_{eff}
- Full formula has a fixed point $(0, 1/\sqrt{12})$
- Full formula enters asymptotic region at $\sigma_d/w \simeq 0.4$
- Full formula has a minimum of $\sigma_x/w \simeq 0.1$ at $\sigma_d/w \simeq 0.3$

$(0, 1/\sqrt{12})$: hodoscope limit

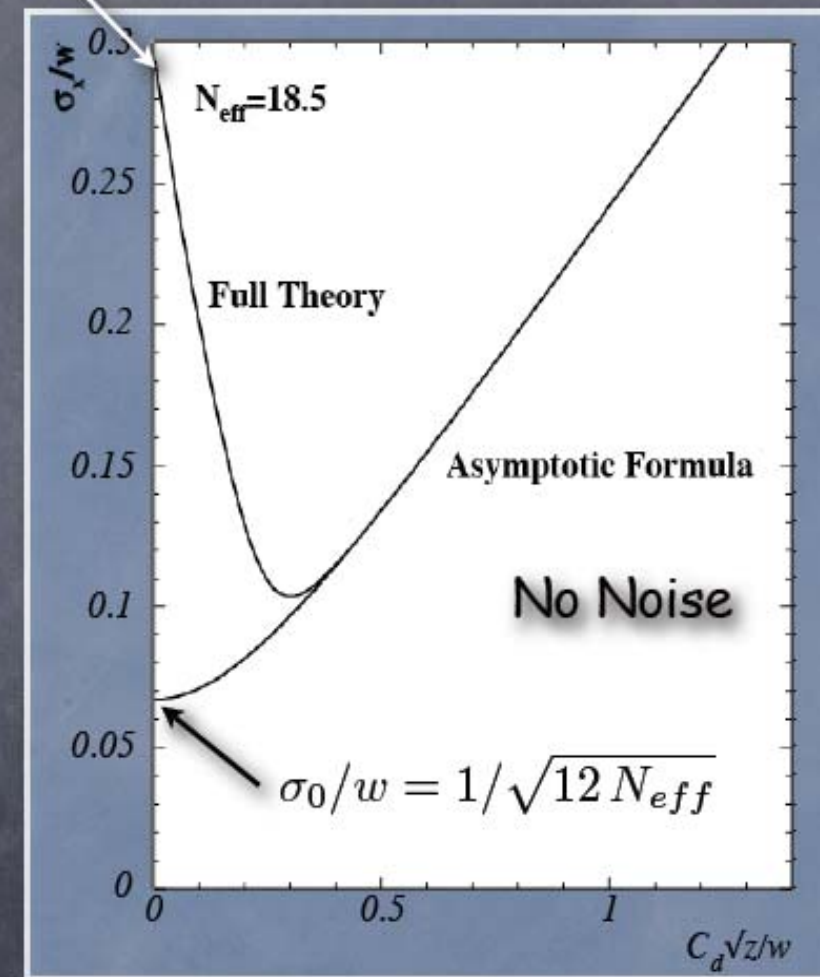

Extrapolation to LC TPC

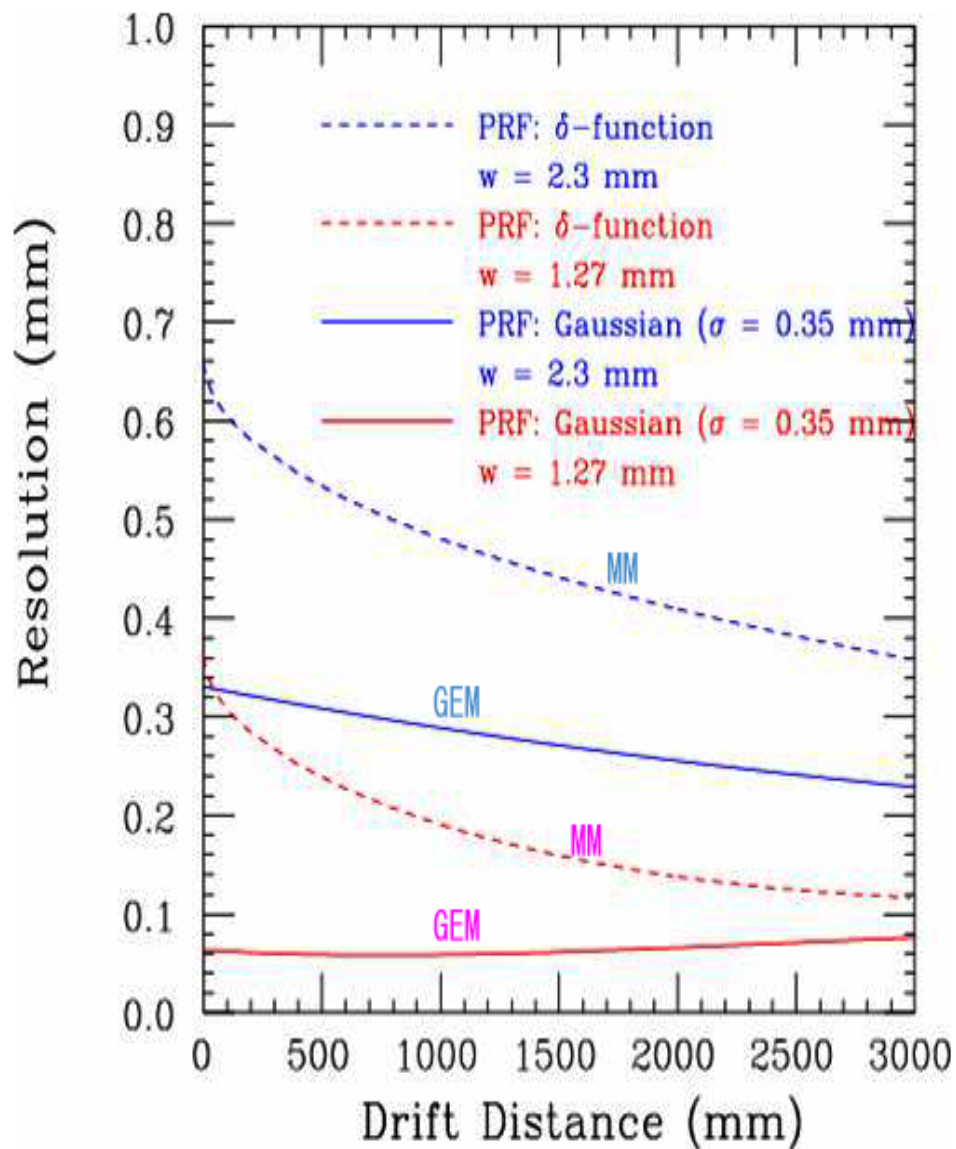

IF Use Ar-CF₄ (3%)

$B = 4$ T

$D = 20 \mu\text{m}/\sqrt{\text{cm}}$

$N_{\text{eff}} = 22$

$\phi = 0^\circ$

MicroMEGAS

PRF: $\approx \delta$ -function

GEM

PRF: *assumed* to be a Gaussian with $\sigma = 350 \mu\text{m}$

-> Future Study

Study with the large TPC prototype: The LC TPC collaboration and EUDET

Kobayashi

Momentum Resolution: What We Expect From TPC (B=3T)

By A. Yamaguchi & K. Fujii

Tracker parameters used in this study

TPC

- lever arm = 155 [cm] ($R_{\min} = 44\text{cm}$)
- half length = 255 [cm]
- $N_{\text{sample}} = 200$
- $\sigma_{r\phi}^2 = 55^2 + 55^2/28 \times Z_{\text{drift}}$ [μm^2] (measured for a GEM-TPC with P5 gas)
- $\sigma_{z} = 600$ [μm] --> K. Ikematsu's talk)

IT

- $N_{\text{layer}} = 4$ ($R_{\min} = 9\text{cm}$, $R_{\text{step}} = 7\text{cm}$)
- thick = 560 [μm] (silicon)
- $\sigma_{r\phi, z} = 10$ [μm]

VTX

- $N_{\text{layer}} = 4$ ($R_{\min} = 2.4\text{cm}$, $R_{\text{step}} = 1.2\text{cm}$)
- thickness = 330 [μm] (silicon)
- $\sigma_{r\phi, z} = 4$ [μm]

Momentum Resolution

What We Expect From TPC (B=3T)

(Assume GEM TPC with P5 gas)

Momentum resolution vs transverse momentum ($|\cos\theta| < 0.7$)

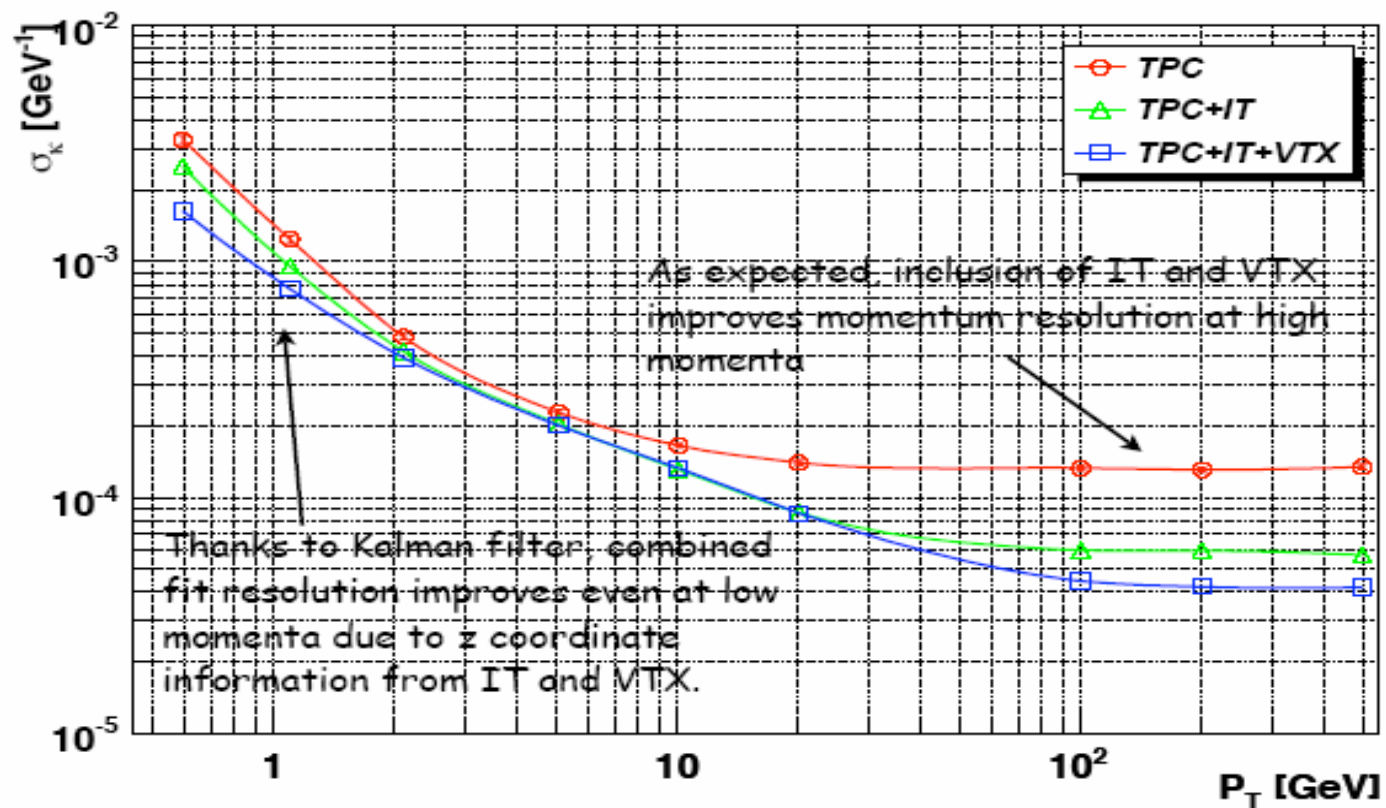

Momentum Resolution

What we expect from TPC (B=3T)

(Assume GEM TPC with P5 gas)

Momentum resolution vs transverse momentum **with IP constraint**

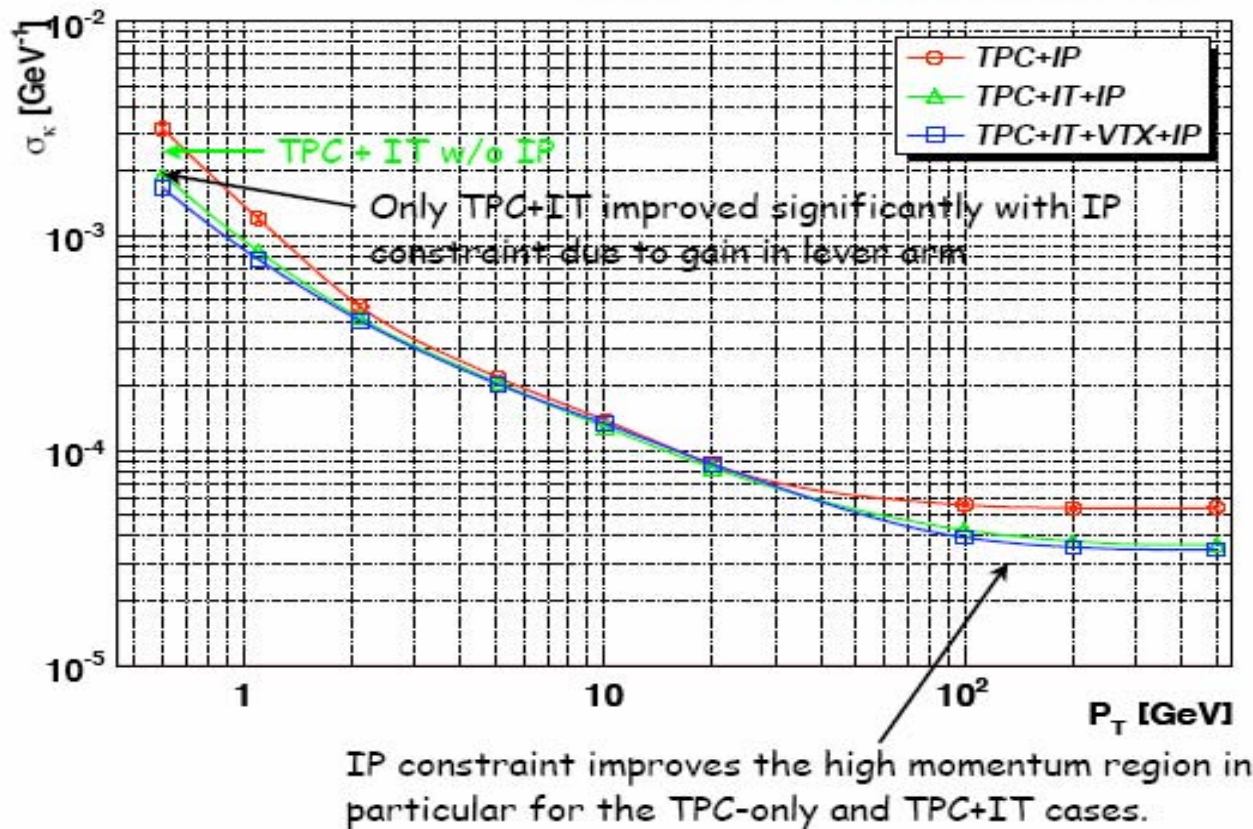

Momentum Resolution: Comparison (Borrowed from the SiD DOD)

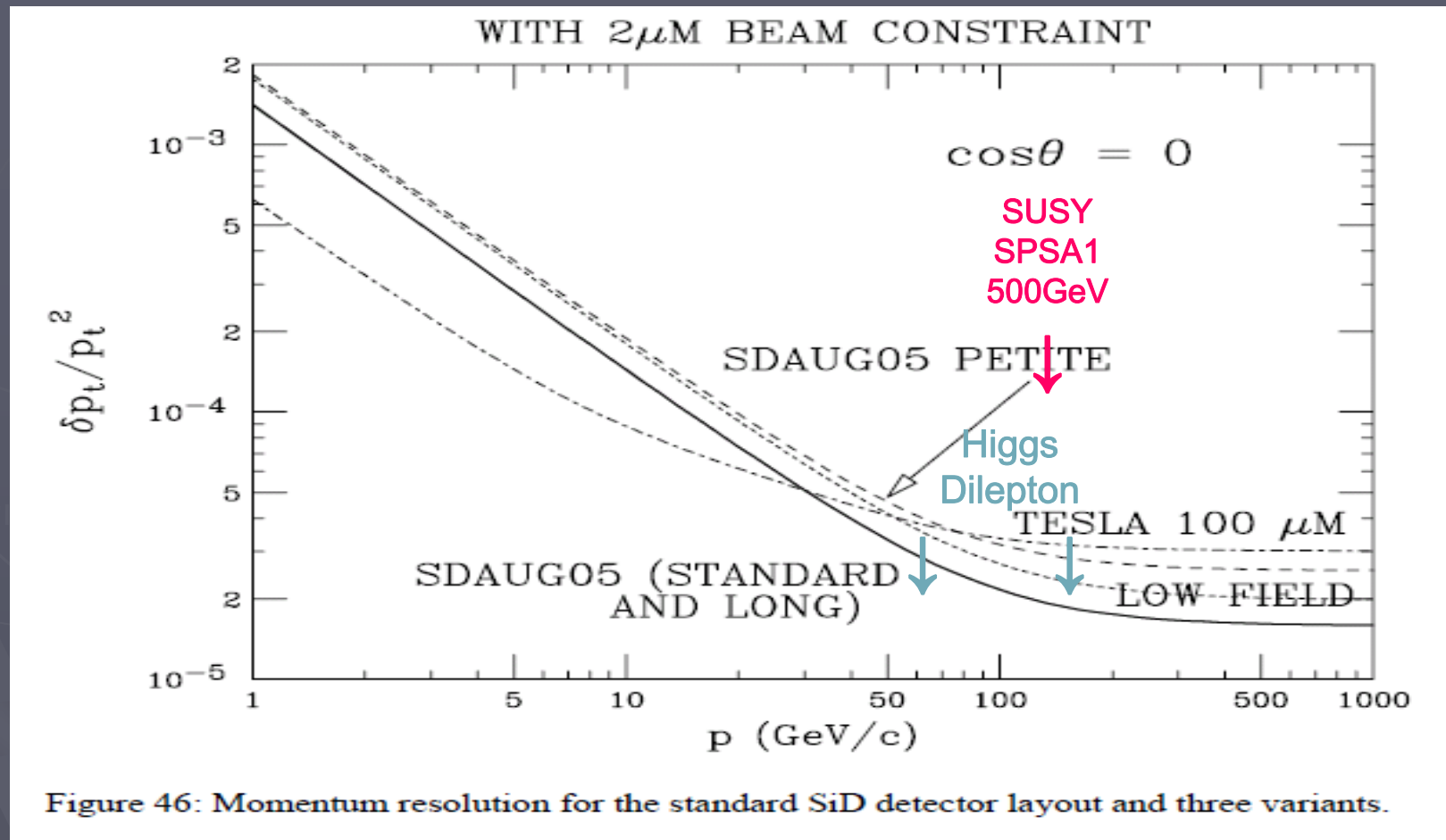

Three alternate SiD detector configurations:

- (1) Low Field: Lowering the magnetic field from 5T to 4T
- (2) Long: Extending the length of the barrel region from 150 cm to 180 cm, and
- (3) Petit: Decreasing the outer radius of the outer tracker from 125 cm to 100 cm.