

# ***Crab Cavity Design for the ILC BDS***

---

***Liling Xiao, Zenghai***

***ACD, SLAC***

ILC BDS meeting, Mar.6, 2007

***Collaboration with FNAL and UK lab on this project.***

1. Introduction;
2. FNAL 3.9GHz deflecting mode cavity  
(Workshop on 3.9 GHz Deflecting Mode Cavity Simulation”, 5/8-5/9/2006 FNAL);
3. New HOM/LOM couplers;
4. Mode mixing effect;
5. Wakefield study
6. Future plan.

# 1. Introduction

**BDS Report: Deepa Angal-Kalinin, Hitoshi Yamamoto, Andrei Seryi**

**ilc** Crab cavity

Right: earlier prototype of 3.9GHz deflecting (crab) cavity designed and build by Fermilab.

Left: Cavity modeled in Omega3P, to optimize design of the LOM, HOM and input couplers.

FNAL T. Khabibouline, L.Bellantoni, et al., SLAC K.Ko et al., Daresbury P. McIntosh, G.Burt, et al.

Collaboration of FNAL, SLAC and UK labs is working on the design.

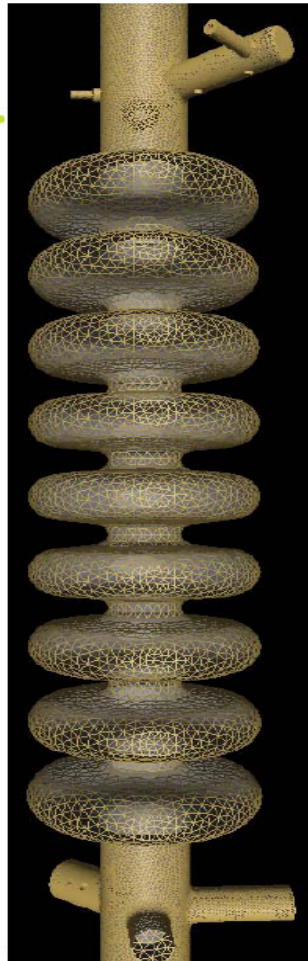

Submitted coordinated UK & US plans to design and build ILC compatible crab cavity & develop phase stabilization

July 20, 06, VLCW06

Global Design Effort

BDS: 7

## 2. FNAL 3.9 GHz Deflecting Cavity Model

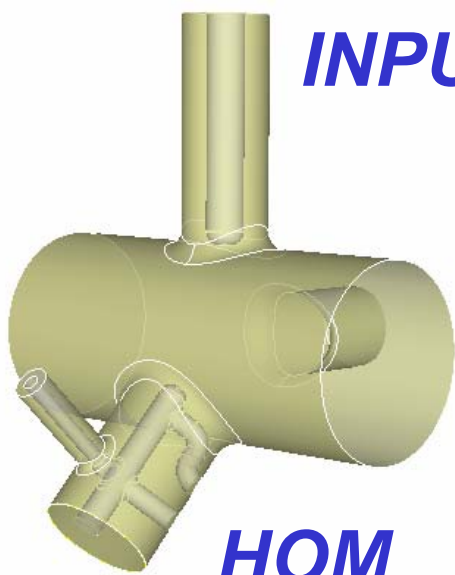
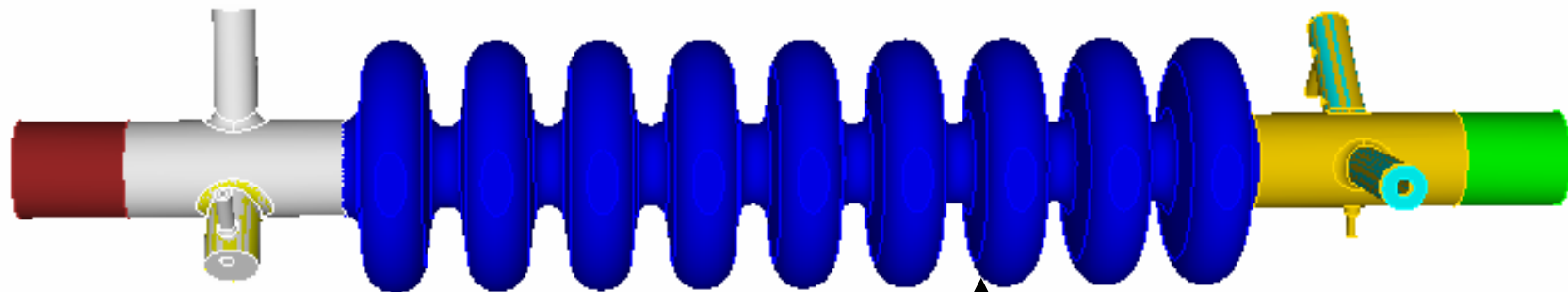

**INPUT**

**HOM**

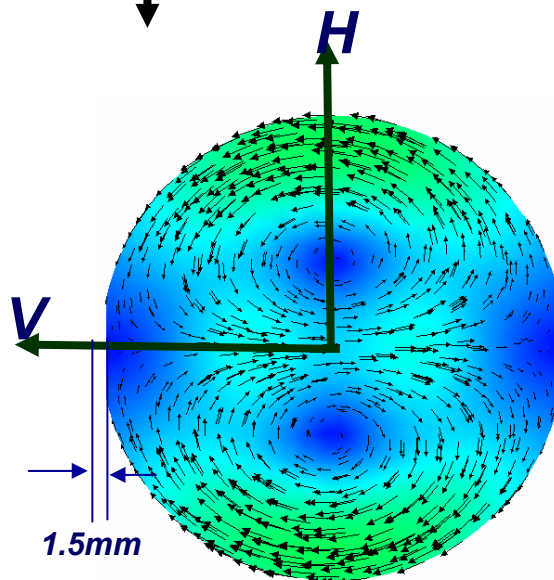

**Operating mode  
TM110  $\pi$  mode**

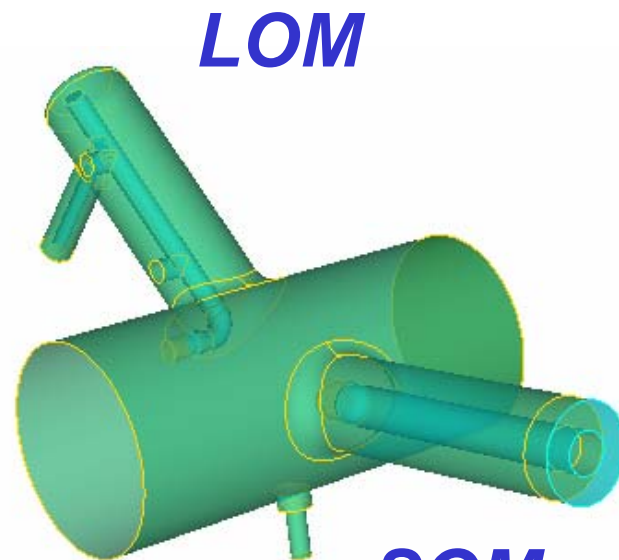

**LOM**

**SOM**

# dispersion curve

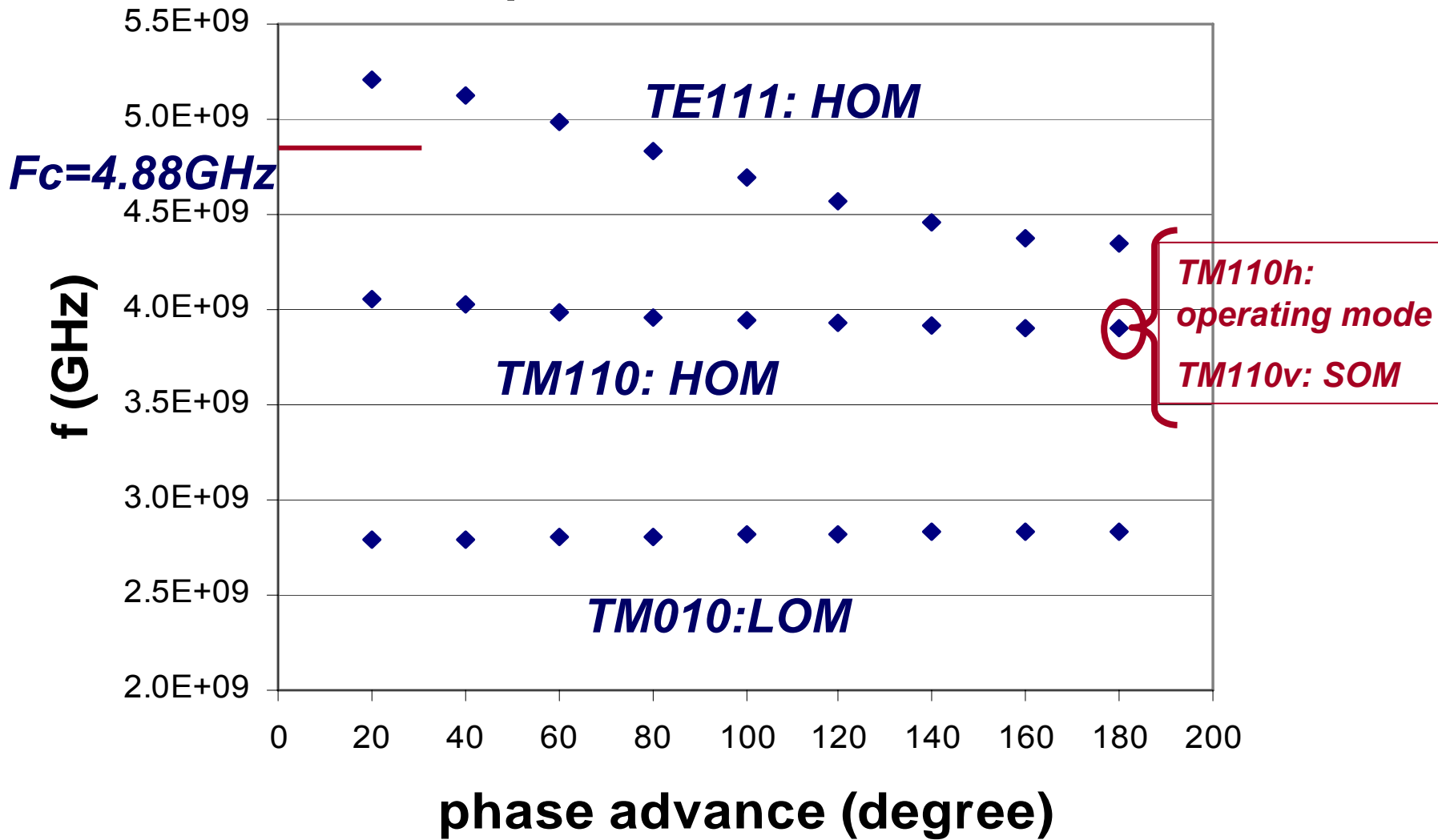

## 2.1. TM010 modes: Omega3P results with LOM tuning

1st Monopole band modes in FNAL deflecting cavity

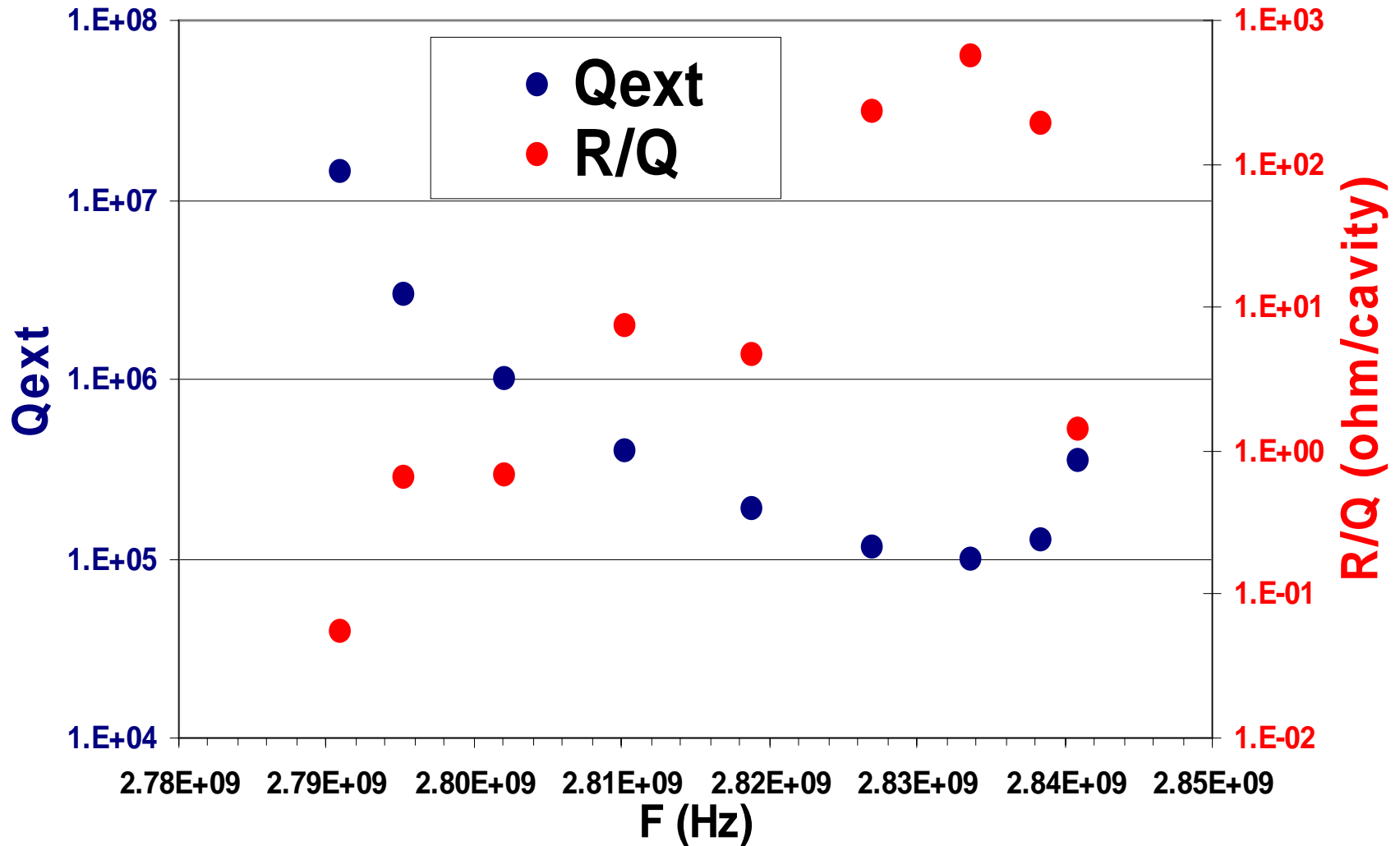

## 2.2. TM110 modes: Omega3P results with HOM tuning

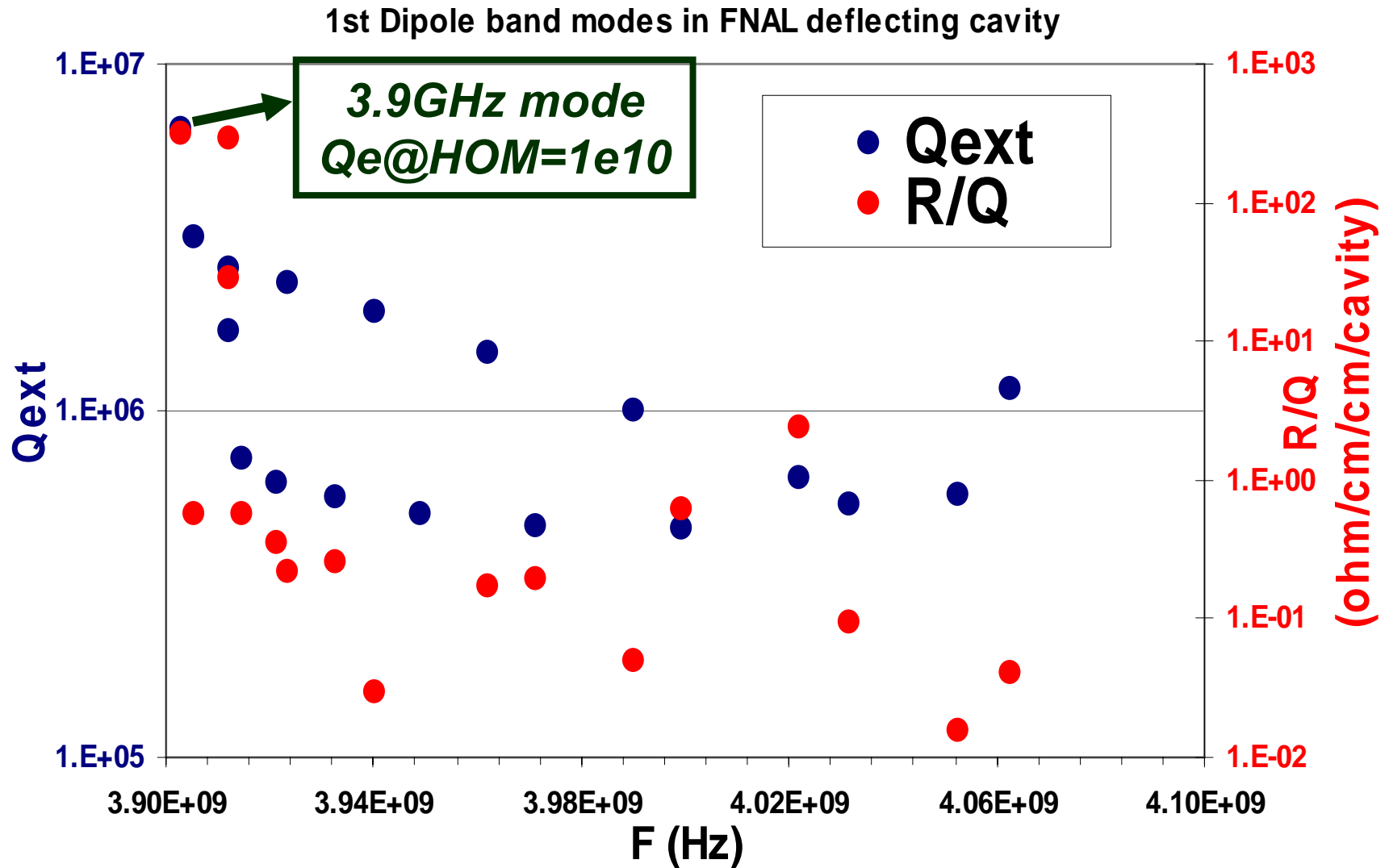

## 2.3. Two problems current FNAL 3.9GHz deflecting mode cavity.

### 1). The notch filter in HOM/LOM coupler is too sensitive.

**LOM:  $df/dgap=2.20\text{MHz/micro}$**

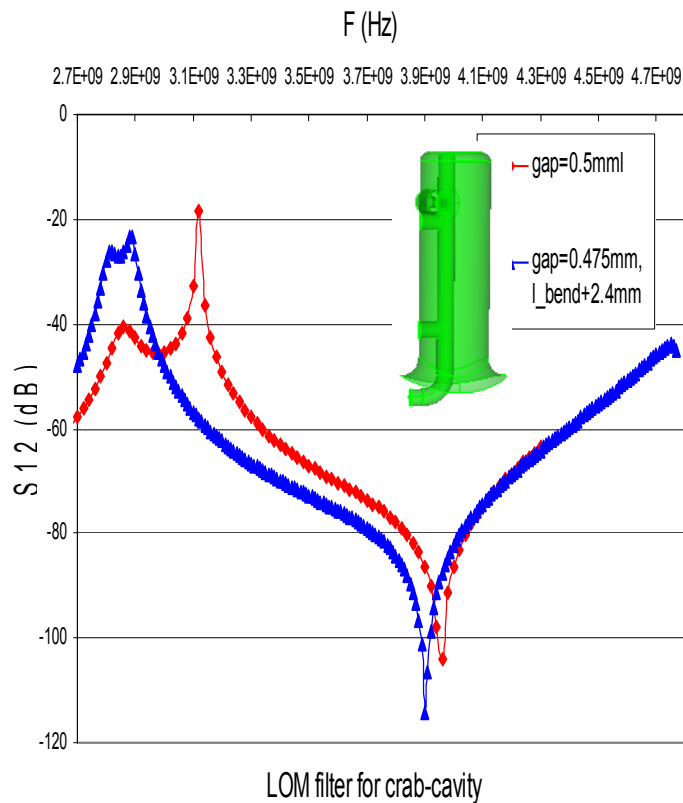

**HOM:  $df/dgap=1.60\text{MHz/micro}$**

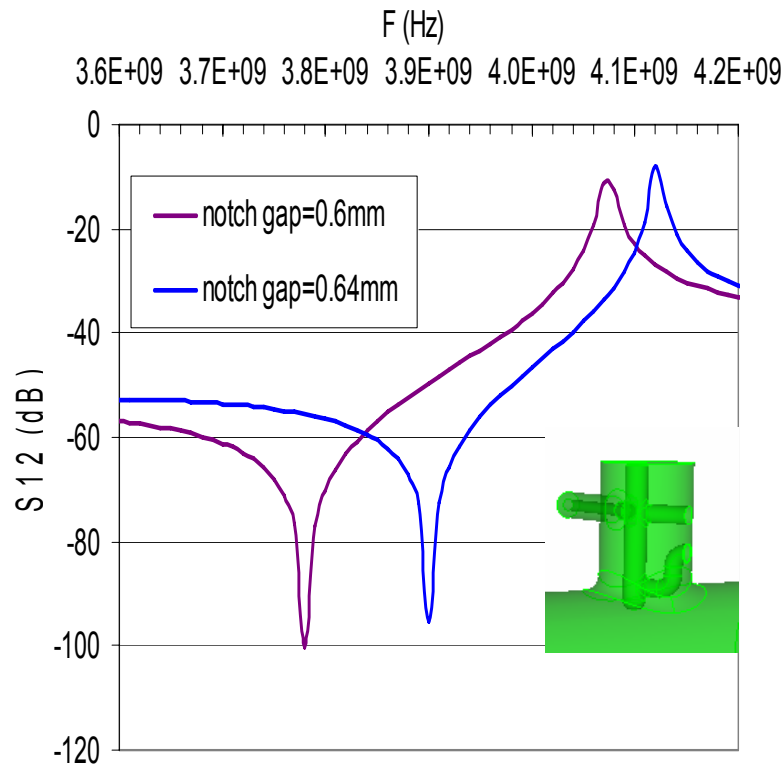



## 2). Mode mixing between $7\pi/9$ mode and the unwanted $\pi$ mode

$F = 3.9030\text{GHz}$ ,  $R/Q=318 \Omega/\text{cm}^2/\text{cavity}$ ,  $Q_{\text{ext}}=6.5\text{e}+6$

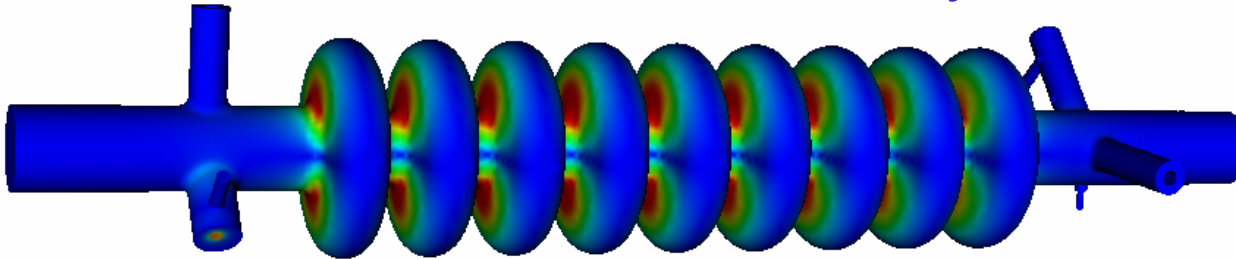

**3.9GHz  
mode**

**“Mode Overlap”**

$F = 3.91209 \text{ GHz}$ ,  $R/Q=28 \Omega/\text{cm}^2/\text{cavity}$ ,  $Q_{\text{ext}}=1.7\text{e}+6$

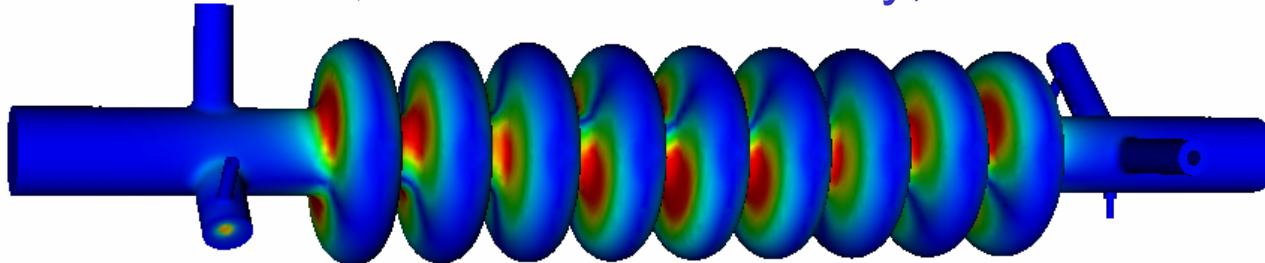

**$7\pi/9$  mode**

$F = 3.91212 \text{ GHz}$ ,  $R/Q=292 \Omega/\text{cm}^2/\text{cavity}$ ,  $Q_{\text{ext}}=2.6\text{e}+6$

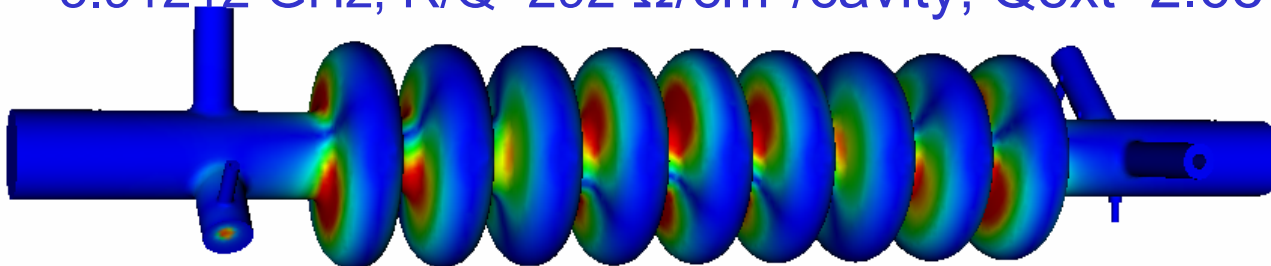

**SOM**

# 3. New LOM/HOM Coupler

## 3.1 Redesign LOM Coupler

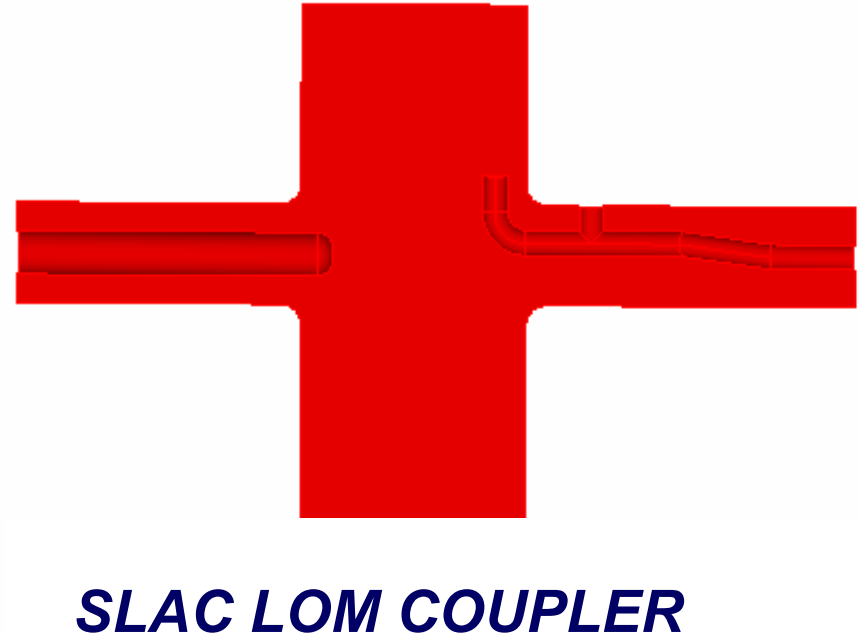
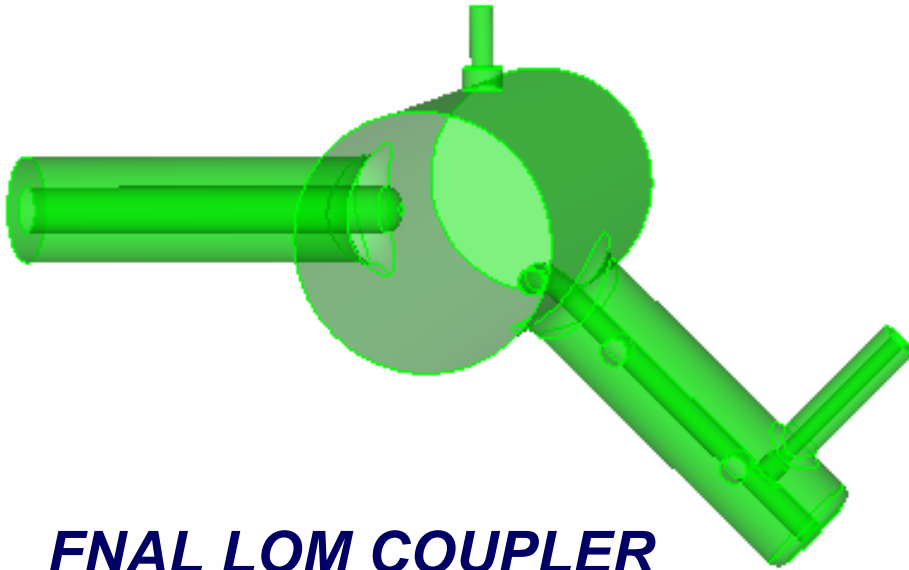

***Rotate to opposite side of SOM and eliminate notch filter through symmetry.***

***Simplify the structure and increase the power handling.***

# LOM coupler damping and heating

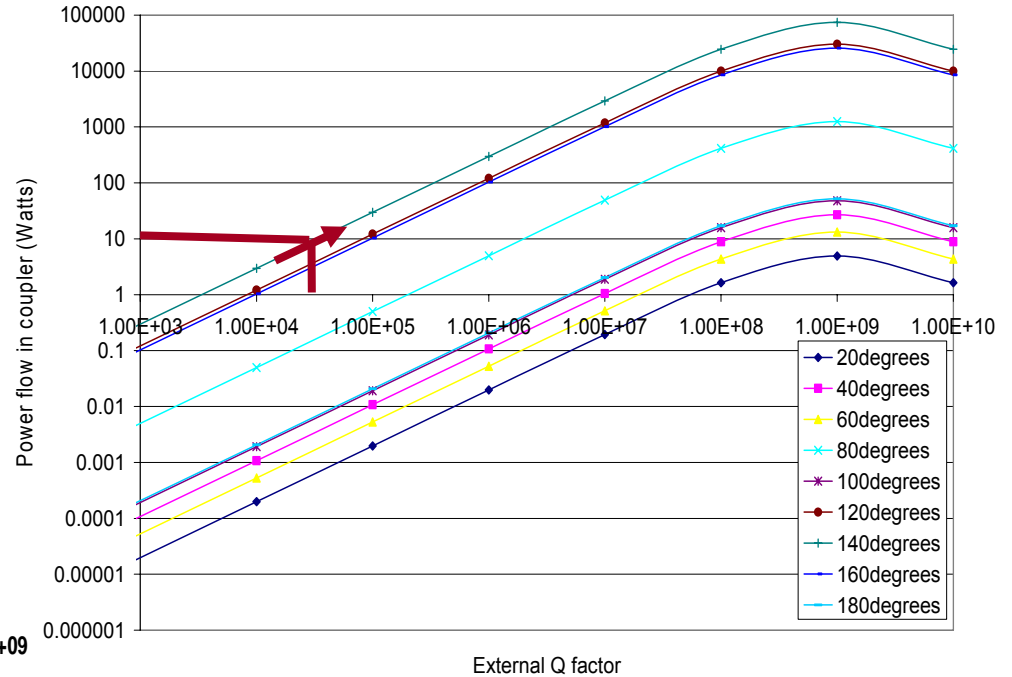
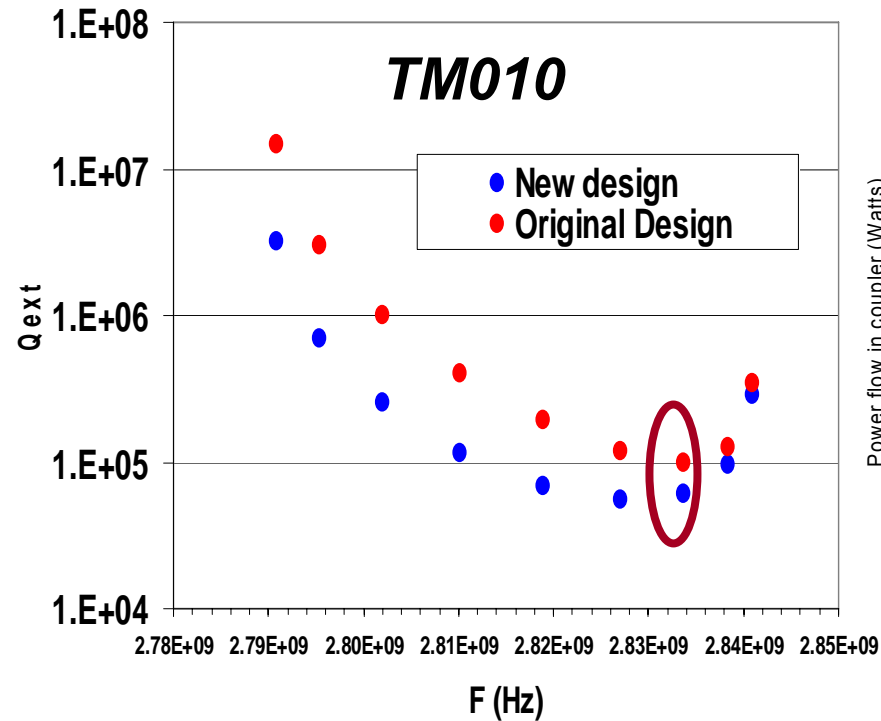

*Omega3p results*

**G Burt: Crab cavity Video meeting, 2/07/07**

# LOM central conductor misalignment test

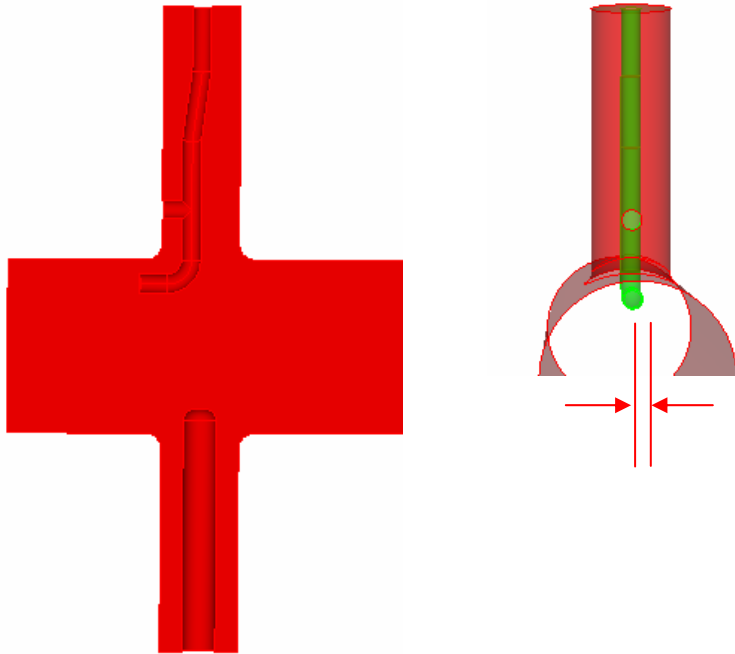

***For operating  $\pi$  mode:***

***LOM center rod is on the center***

***$Q_{ext} @ LOM > 1.0e+12$***

***LOM center rod shift 1mm***

***$Q_{ext} @ LOM = 1.3e+9$***

# 3.2. Redesign HOM Coupler

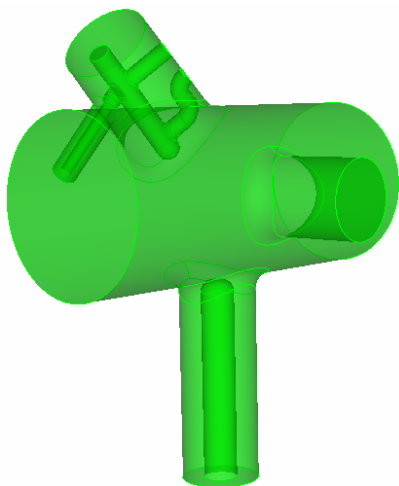

**FNAL DESIGN**  
*loop coupling:*

**Reduce  
Notch Gap  
Sensitivity**

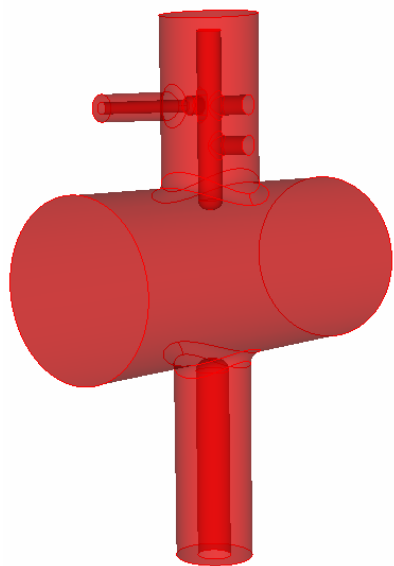

**SLAC DESIGN**  
*probe coupling*

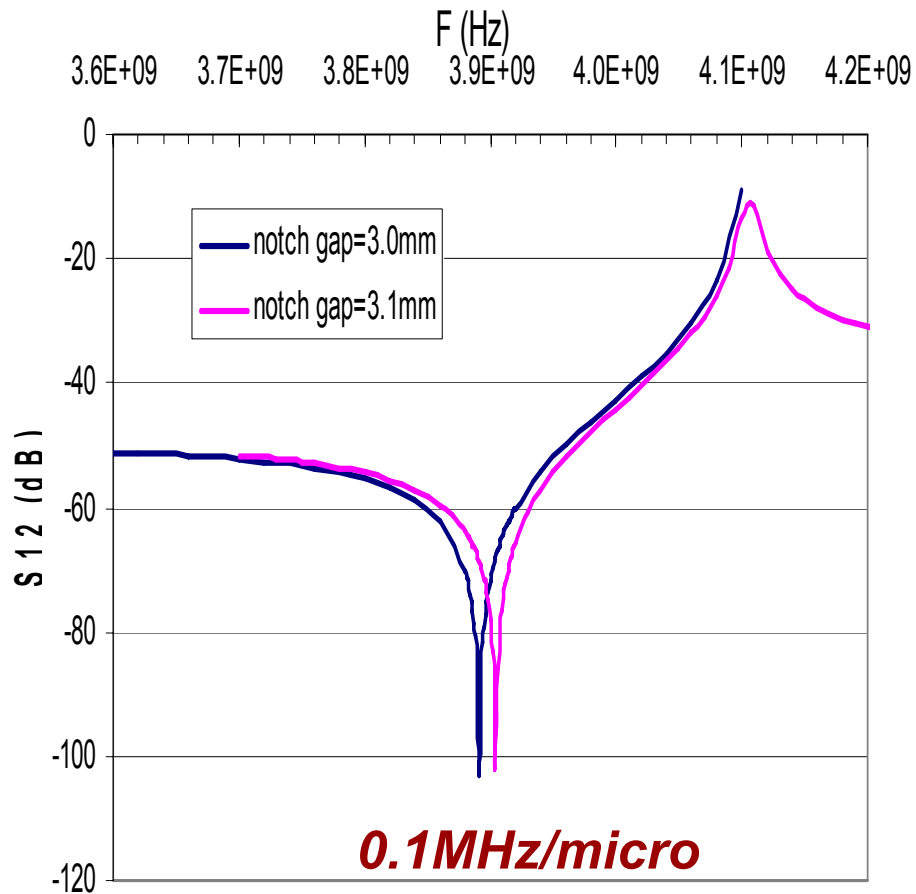

**~TESLA(0.13MHz/micro)**

# HOM/SOM coupler damping

## *Omega3p results*

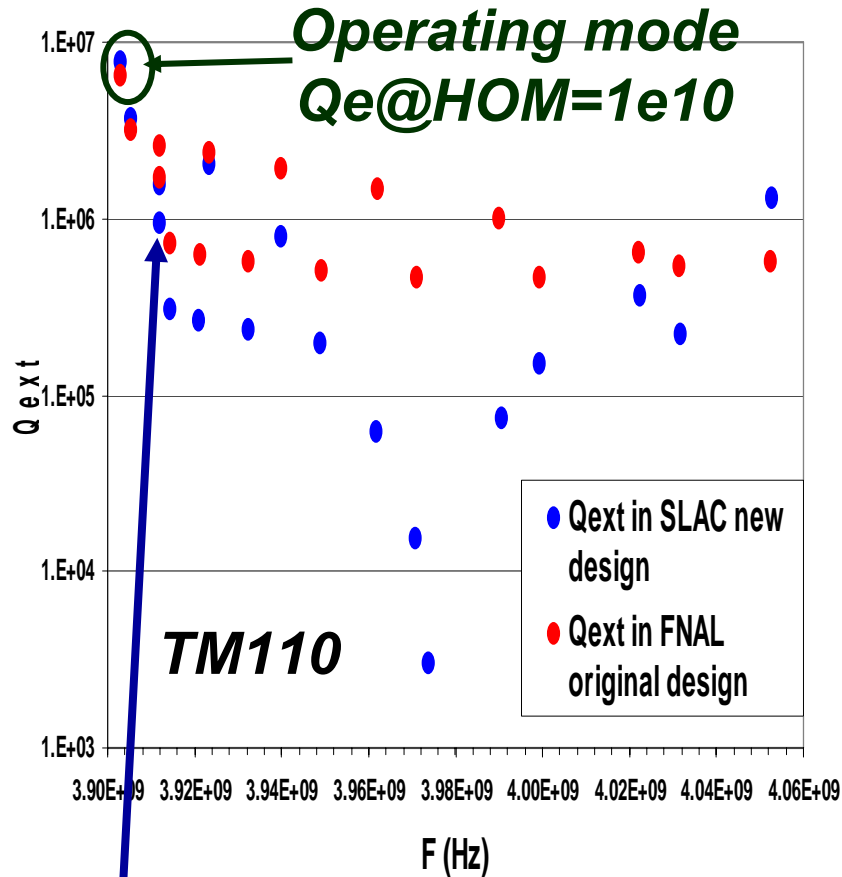

***SOM damping not effective due to mode mixing***

## Required Damping

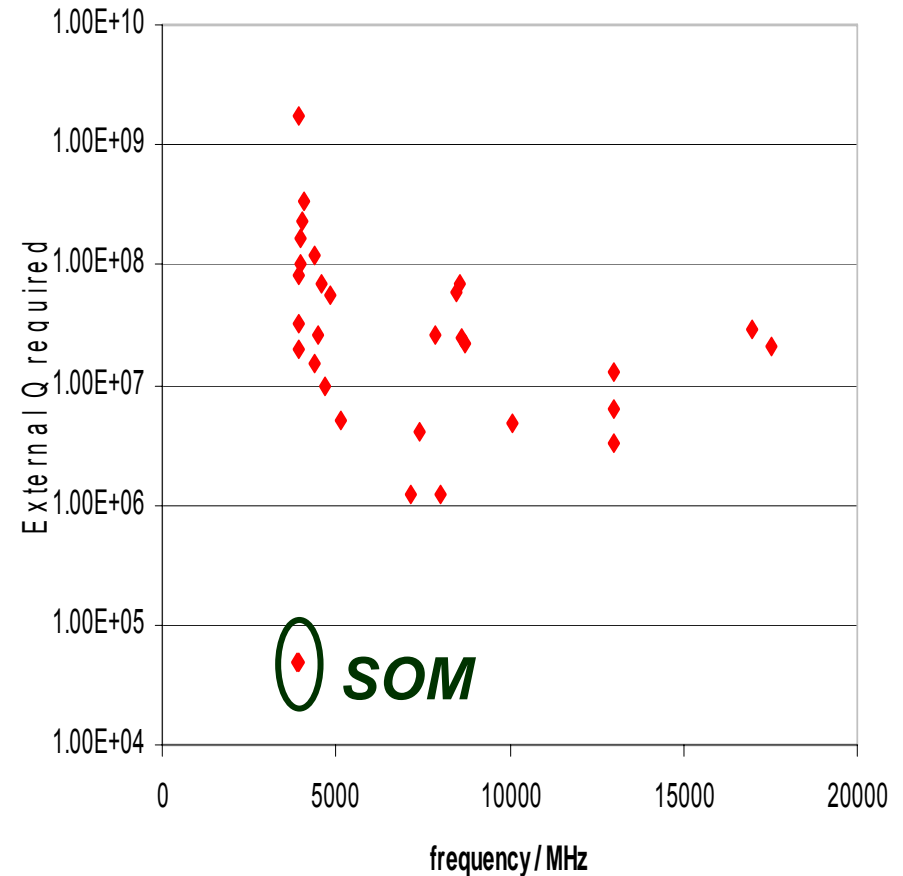

**G Burt: Crab cavity Video meeting, 2/07/07**

## 4. Mode mixing effect

*Original design: cell indent=1.5mm*

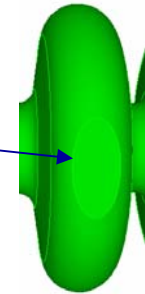
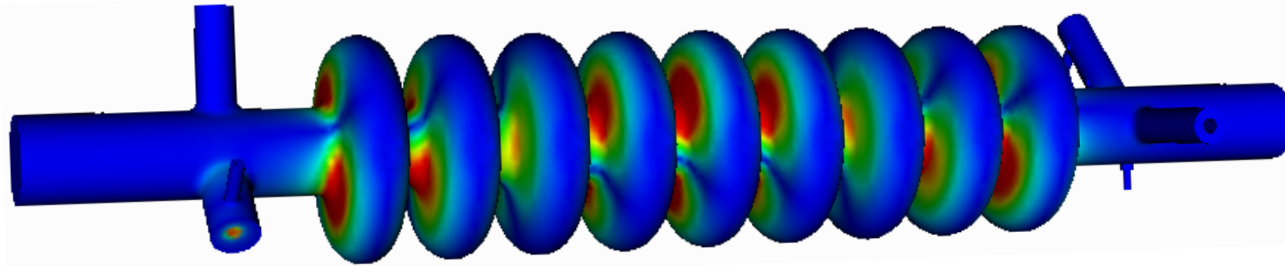

$F = 3.91212 \text{ GHz}$ ,  $R/Q=292 \text{ } \Omega/\text{cm}^2/\text{cavity}$ ,  $Q_{\text{ext}}=2.6\text{e}+6$

*cell indent=2.0mm*

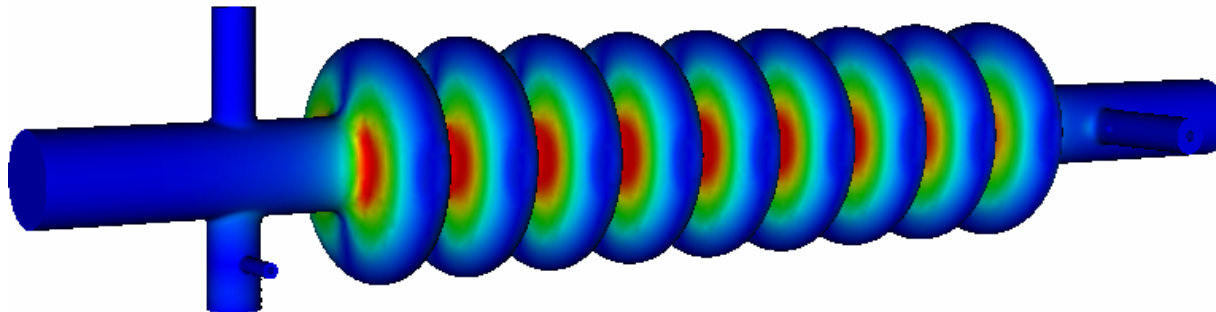

$F = 3.91917 \text{ GHz}$ ,  $R/Q=320 \text{ } \Omega/\text{cm}^2/\text{cavity}$ ,  $Q_{\text{ext}}=7.2\text{e}+5$

# 5. To do

## 5.1. Finish the HOM/LOM/SOM coupler design;

### Power Coupler

a) Check the SOM  $Q_{ext}$  requirement and optimal SOM coupler;

b) Check the operating mode coupling requirement and optimal input coupler;

c) Consider combining LOM and SOM together.

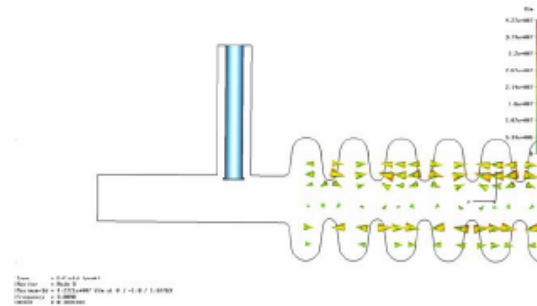

40 Ohm coaxial line, 27mm OD  
Shaped tip for maximum coupling.  
Centre line 40mm from cavity.  
3mm beampipe penetration  
 $Q_e=4.5 \times 10^5$

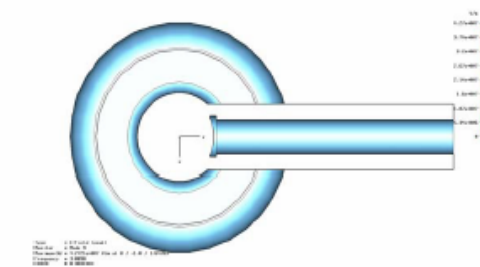

Need to check if this can be adapted for a SOM coupler as well.

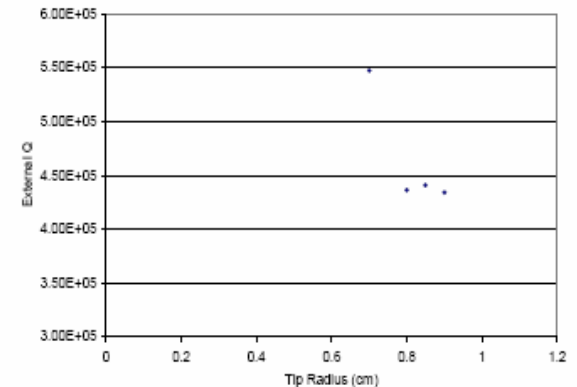

**Crab cavity video meeting, Sept.06,**

**G.Burt, P.Goudket, R.Jones**



## 5.2. Optimize the cell shape;



*Modify cavity indents or use elliptical cavity shape to avoid mode overlap;*

## 5.3. Study multipacting in cavity and couplers;

*Multipacting activities had been found in Ichiro cavity and 3<sup>rd</sup> harmonic cavity HOM coupler.*

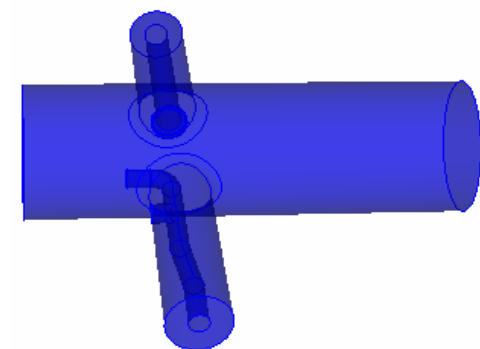
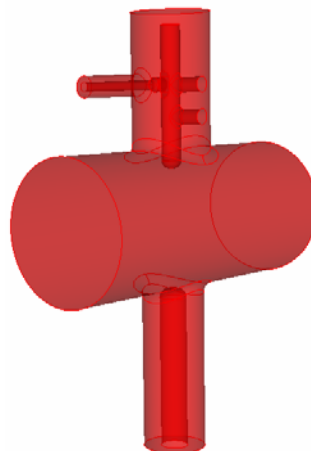

## ***Example of SNS cavity HOM MP simulation***

- *SNS Cavity HOM coupler MP barriers Were found*
- *The gradient levels match that of the measurement*

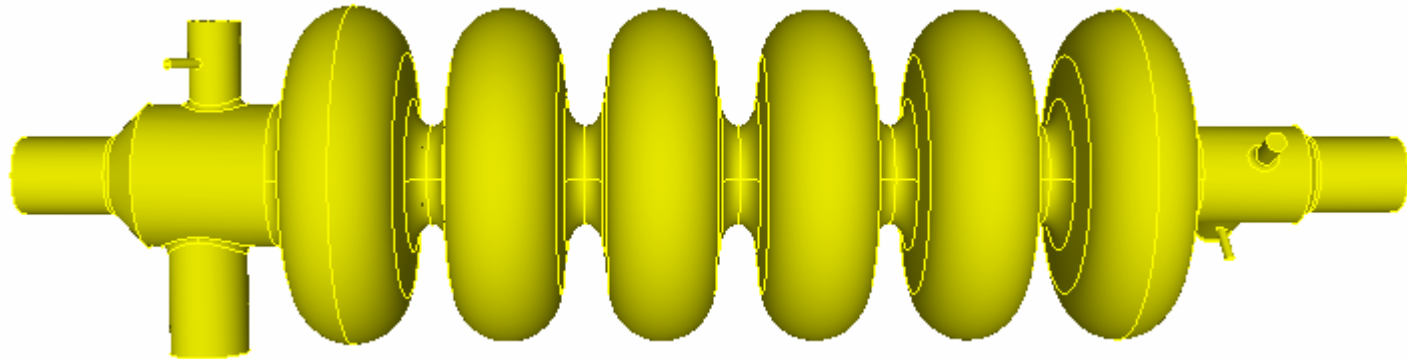
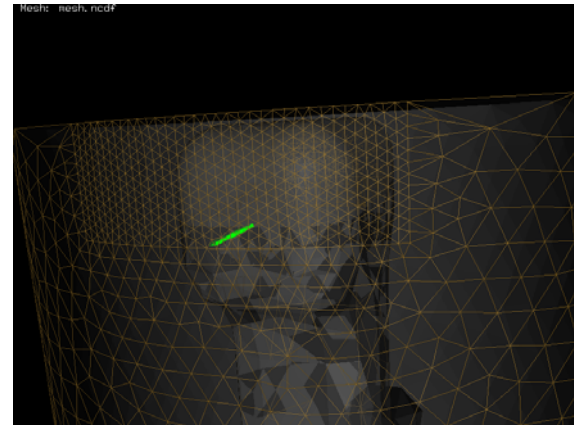
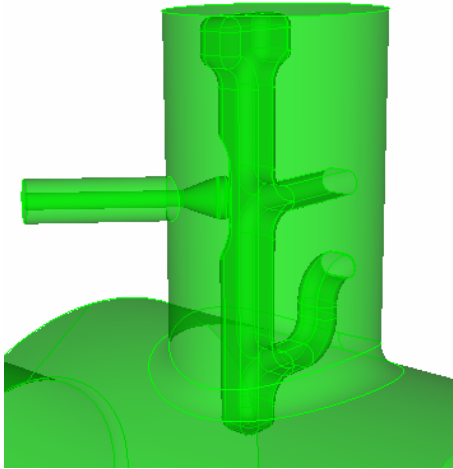

***SNS beta0.81 cavity***

## 5.4. Calculate effect of cavity imperfections on beam dynamic

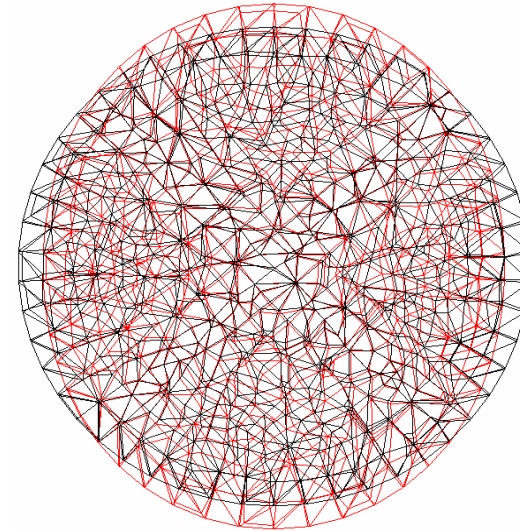
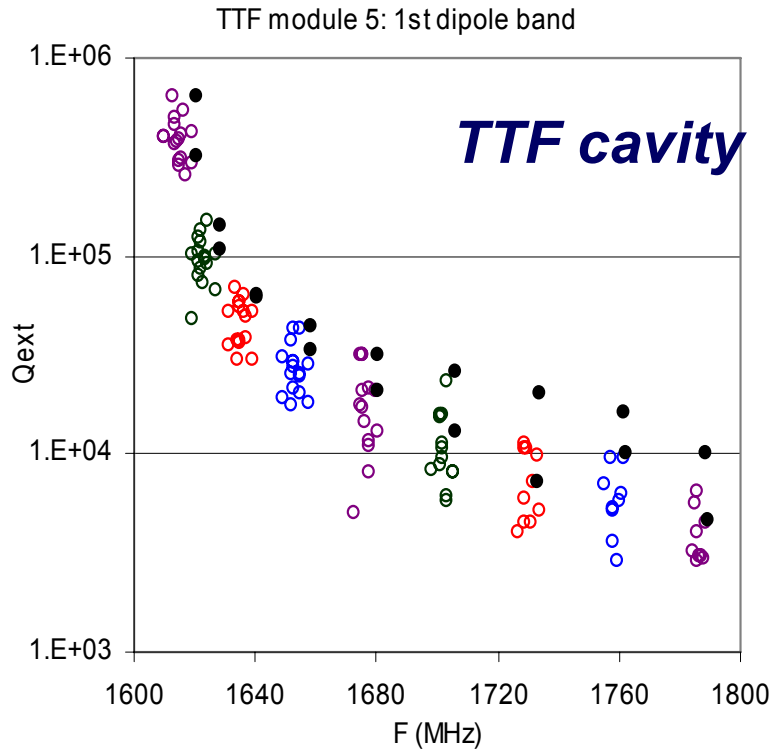

**Meshing moving method was used to study the ILC cavity imperfections**

## 5.5. Compute the trapped modes between cavities;

# Crab Cavity - Wakefields

- Cell indented in one plan to split the x-y degenerate dipole modes

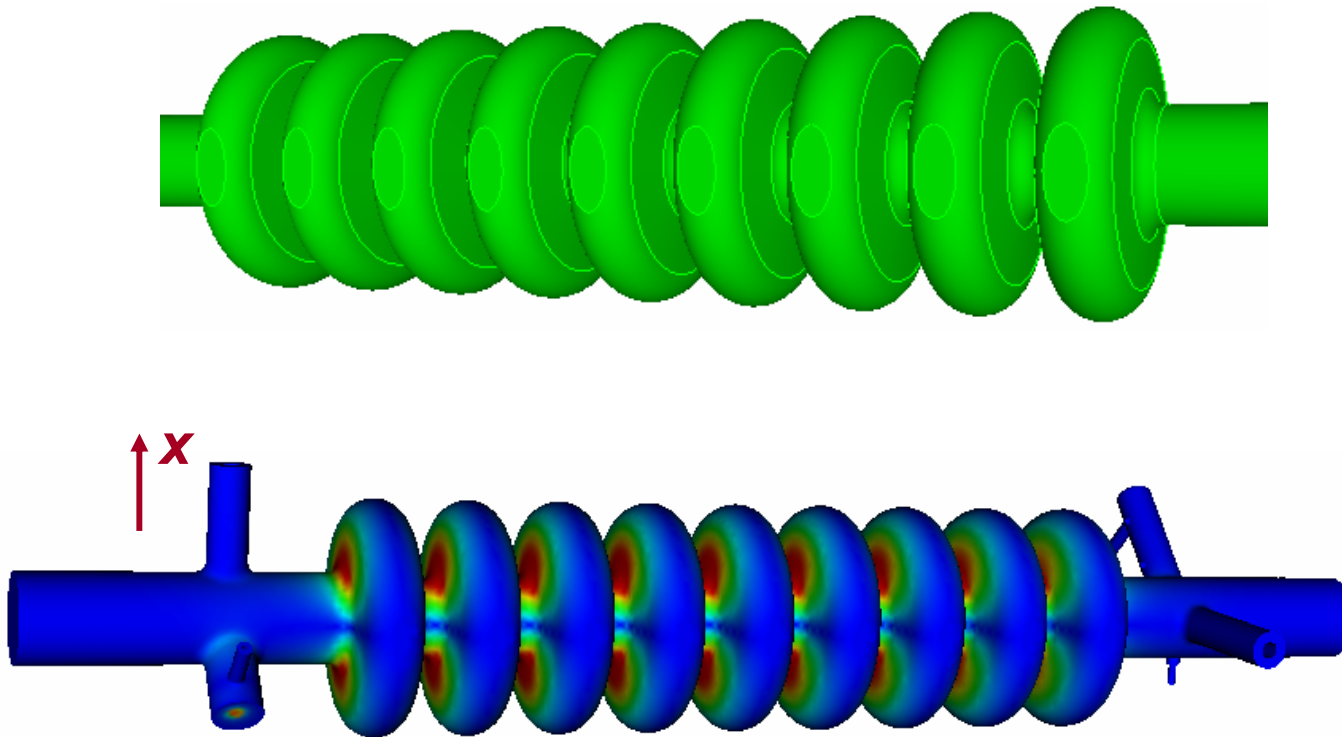

*Operating PI mode in X plane*

# Original Indent – X\_7pi/9 and Y\_pi overlap

## X-y uncoupled spectrum

x	y
3.9031E+09	3.9121E+09
3.9055E+09	3.9146E+09
3.9122E+09	3.9212E+09
3.9236E+09	3.9326E+09
3.9402E+09	3.9491E+09
3.9624E+09	3.9713E+09
3.9903E+09	3.9993E+09
4.0223E+09	4.0317E+09
4.0527E+09	4.0627E+09

3D coupled

uncoupled

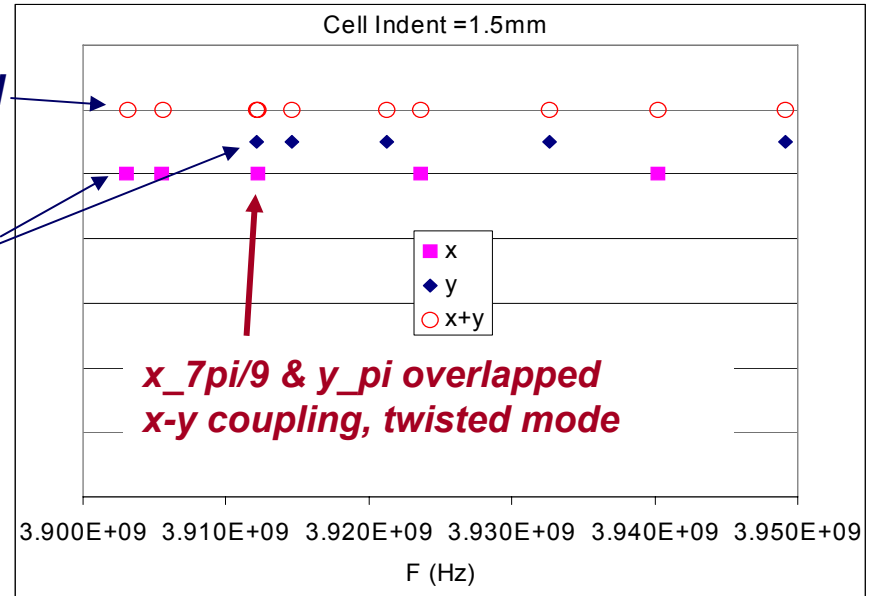

F = 3.91209 GHz

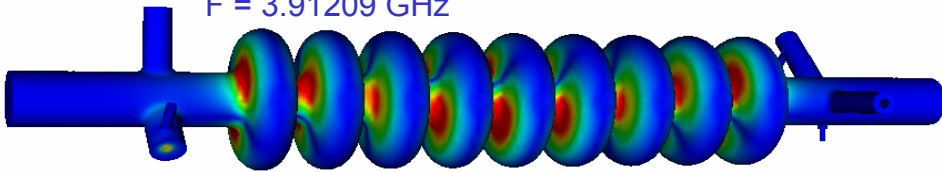

F = 3.91212 GHz

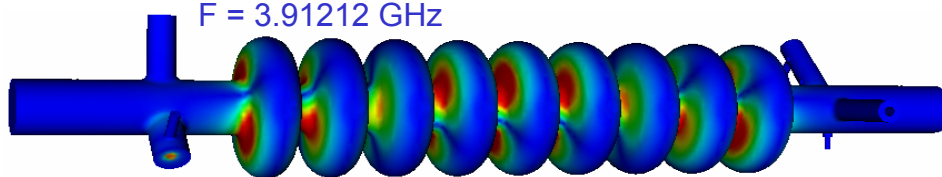

- *Mode coupling resulted in twisted mode*
- *Cause x-y wakefield coupling*
- *Modes are not aligned with x,y at the ends – mode damping issues*

# Wakefield Coupling of Twisted modes

Operating PI mode (X)

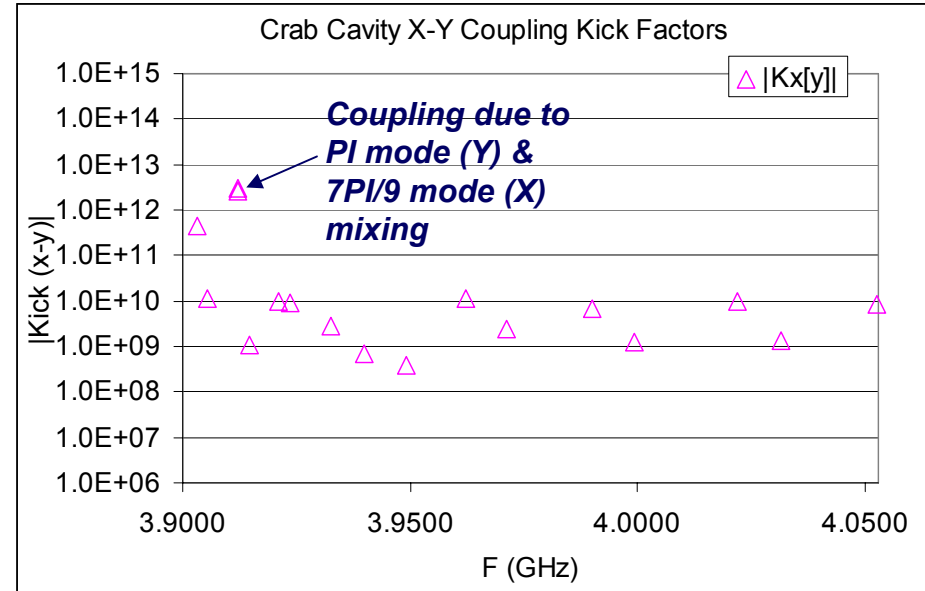
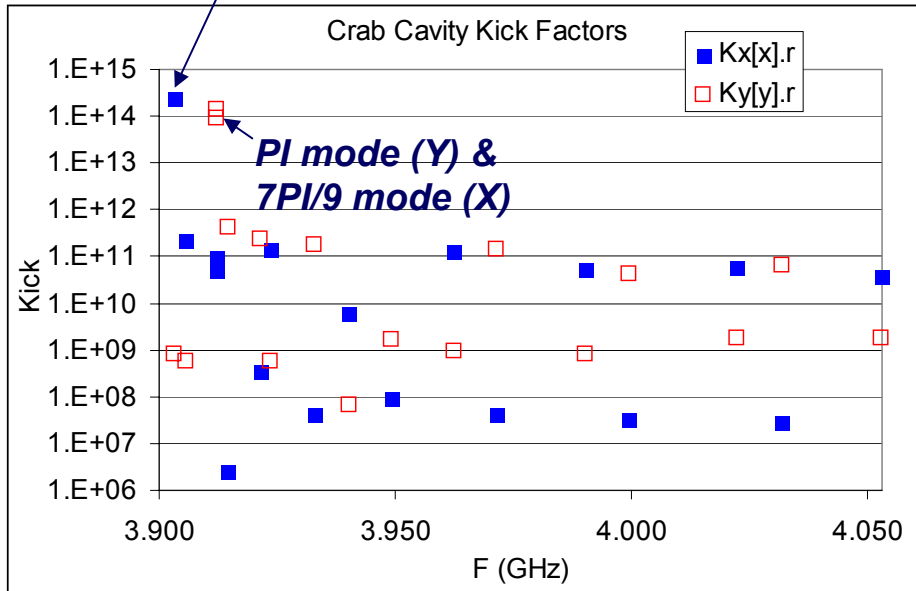

- The Y-PI mode is coupled to the X-7PI/9 mode
- Both modes have large kick factors in the Y plan
- Mode mixing cause X-Y coupling
  - coupling kick factor is about 1% of the PI mode
  - because of looser beam jitter tolerance in X and large beam aspect ratio, need to understand the effect

# Single Bunch Wakefield

- Qext for dominate modes  $\sim 10^5$

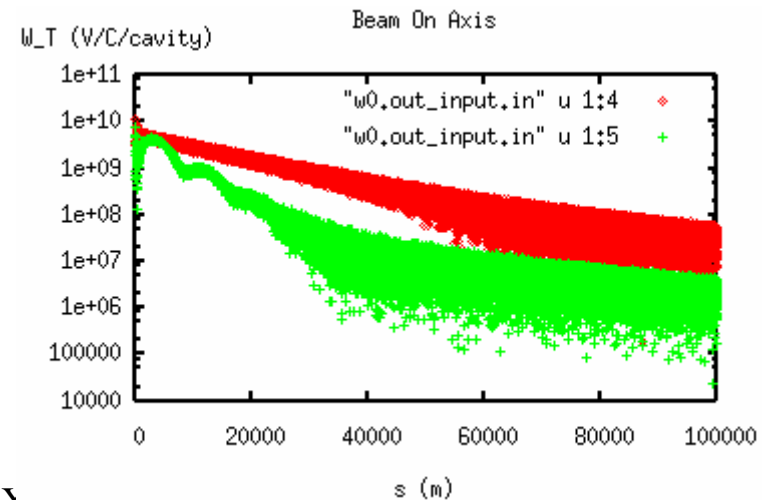
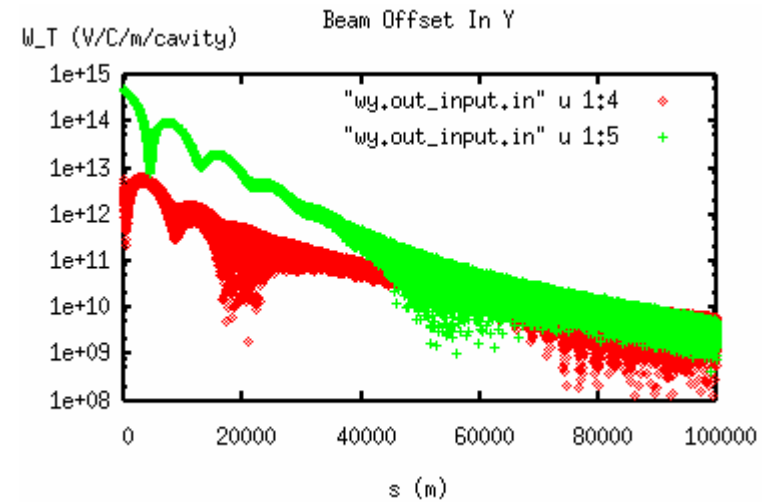
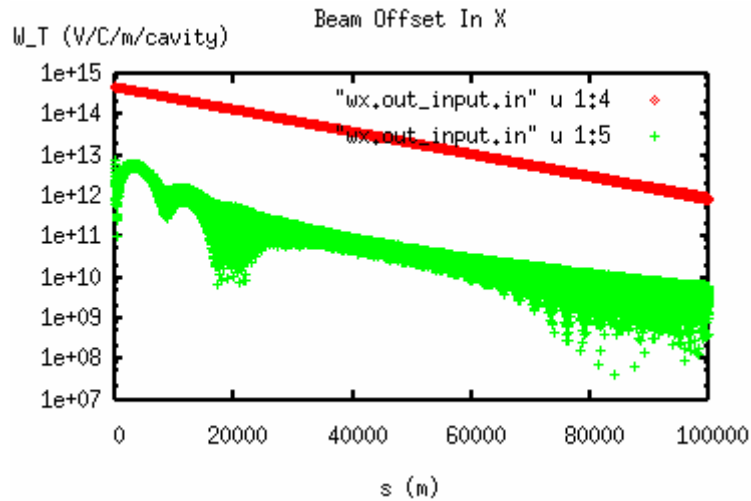

# Bunch Train Wakefield

- $Q_{ext} \sim 10^5$
- Beam offset in x (0.1 mm)

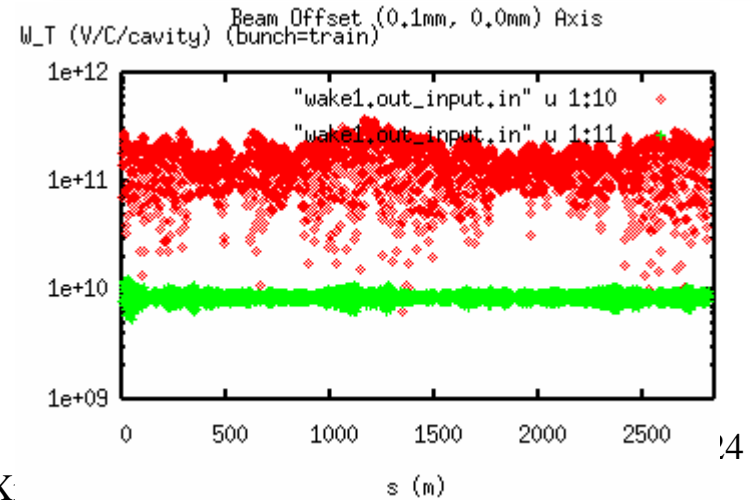
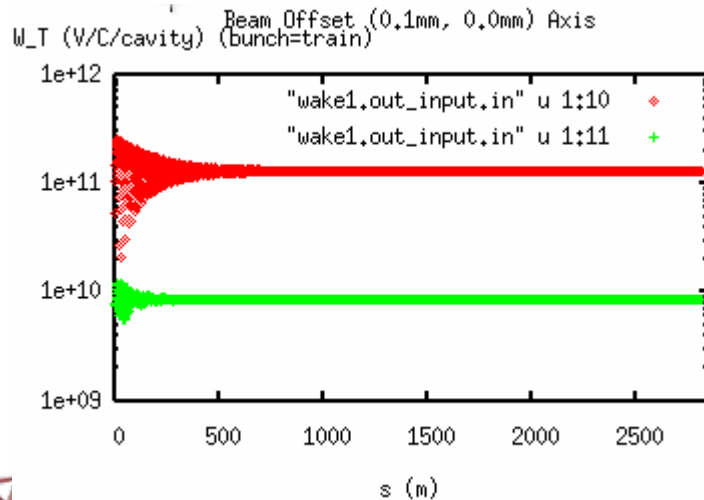
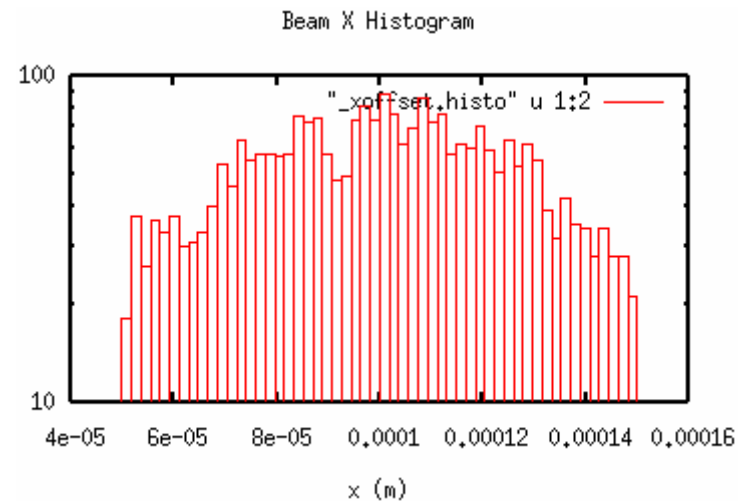
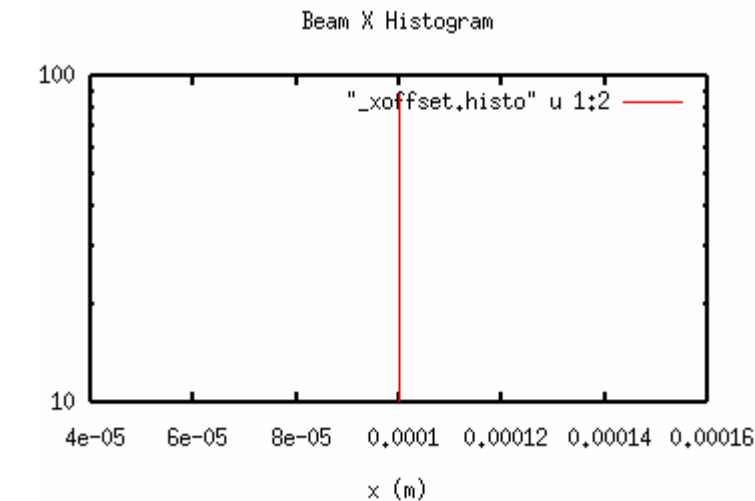



# Avoiding X-Y Mode Coupling

Use more cell indent to shift the Y-mode frequencies

12 MHz separation between  $7\pi/9$  and  $6\pi/9$  modes in the x plane

$\pi$  mode in the y plane can be shifted to the middle of these modes

Other side effects of indentation need to be studied

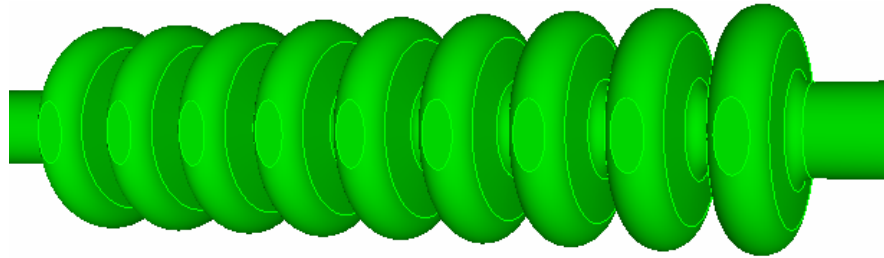

x	y
3.9032E+09	3.9192E+09
3.9057E+09	3.9217E+09
3.9124E+09	3.9283E+09
3.9238E+09	3.9396E+09
3.9404E+09	3.9561E+09
3.9626E+09	3.9783E+09
3.9904E+09	4.0063E+09
4.0225E+09	4.0390E+09
4.0529E+09	4.0705E+09

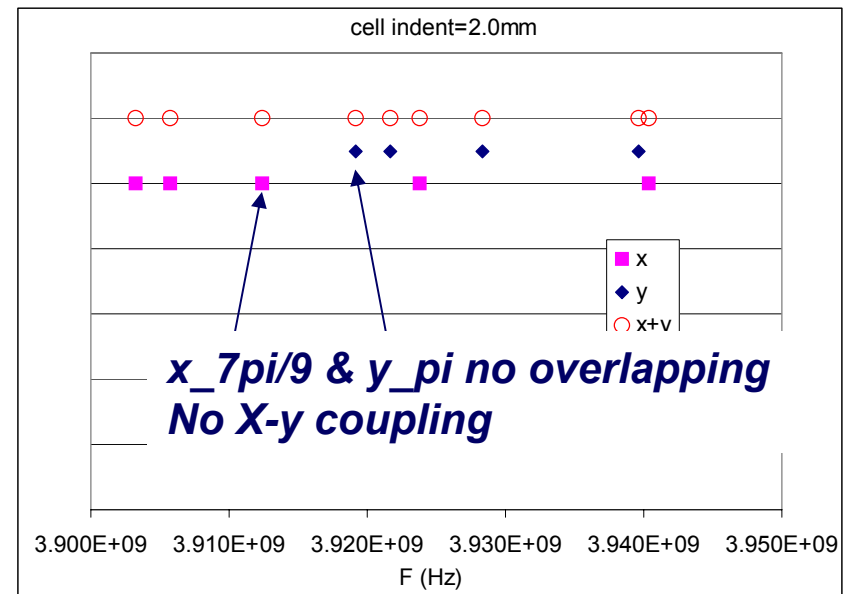

# Plan For Crab Cavity Design - Summary

---

- HOM coupler
  - notch filter re-design
  - Multipacting
- LOM coupler & SOM coupler
  - New filter-free LOM coupler and Qext Optimization
  - Single combined LOM and SOM coupler
  - Multipacting in the LOM/SOM coupler
  - Tolerance study
- Cavity cells
  - Minimize surface E and H fields
  - Modify cavity indents or use elliptical cavity shape to avoid mode overlap
  - Multipacting simulation of the indented cell
- Calculate effect of cavity imperfections
  - Mode overlapping
  - Twisted modes
  - Effects on Qext - trapped modes
- 3D coupler kicks
- Compute trapped modes between cavities
- Beam dynamics modeling to determine  $Q_e$  requirements on cavity modes considering beam jitter, kicks and heat loads