

The DHCAL Vertical Slice Test



José Repond



CALICE Meeting, Prague, September 10 – 12, 2007

Vertical Slice Test

Necessary step before beginning construction of prototype section

Where possible use identical hardware for what is needed for prototype section

Validate RPC/GEM approach to finely segmented calorimetry
Validate concept of electronic readout

Used some of the 104 front-end ASICs (DCAL)
from the 2nd prototype run

Equipped 9 chambers with 4 chips each

Chambers are 20 x 20 cm², rather than 30 x 100 cm²
→ better exposure to showers in test beam

256 channels/chamber → **2300 channels total**

System designed such, that extension to 1 m² 'natural' (but expensive)

Chambers interleaved with 20 mm steel-copper absorber plates
20 mm PVC plates with hole in middle (rate measurement)

Electronic readout system (almost) identical to the one of the prototype section

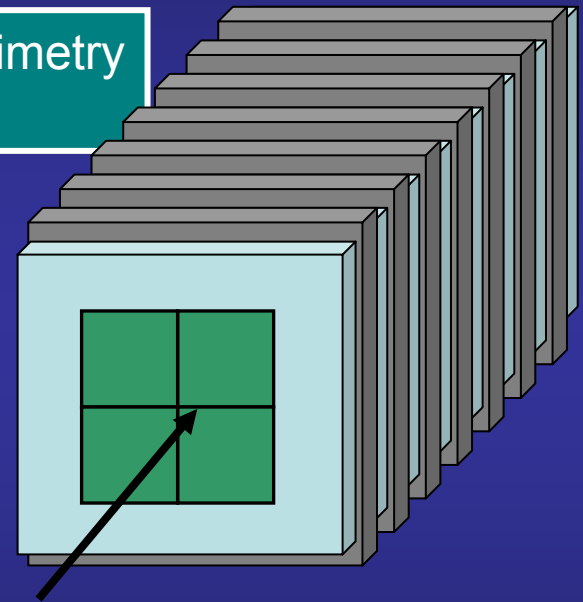

A short history

T970

MoU with FNAL – signed on July 16, 2007

Moved to FNAL – July 18th

Setup of experiment – July 19th (am)

Safety review – July 19th (pm)

Safety approval – July 20th (am)

First beam – July 20th (pm)

First events – July 21th (am)

Shutdown – starting August 4th (pm)

**Record
Time**

Setup - configurations

Movable table

x – y motion (in 1(?)mm steps)
With remote control (from counting house)

RPC layer

(Default) Absorber

16 mm Steel + 4 mm Copper

Absorber for rate measurement

PVC with hole cut out

(Default) RPC with 2 glass plates

One (exotic) RPC with 1 glass plate only

Each layer 16 x 16 cm² (256 channels)

Thickness of individual layer:

Absorber	16+4 mm = 20.0 mm
RPC	3.7 mm
Pad- and FE board + ASICs	4.6 mm
Air	5.1 mm

Total	33.4 mm
-------	---------

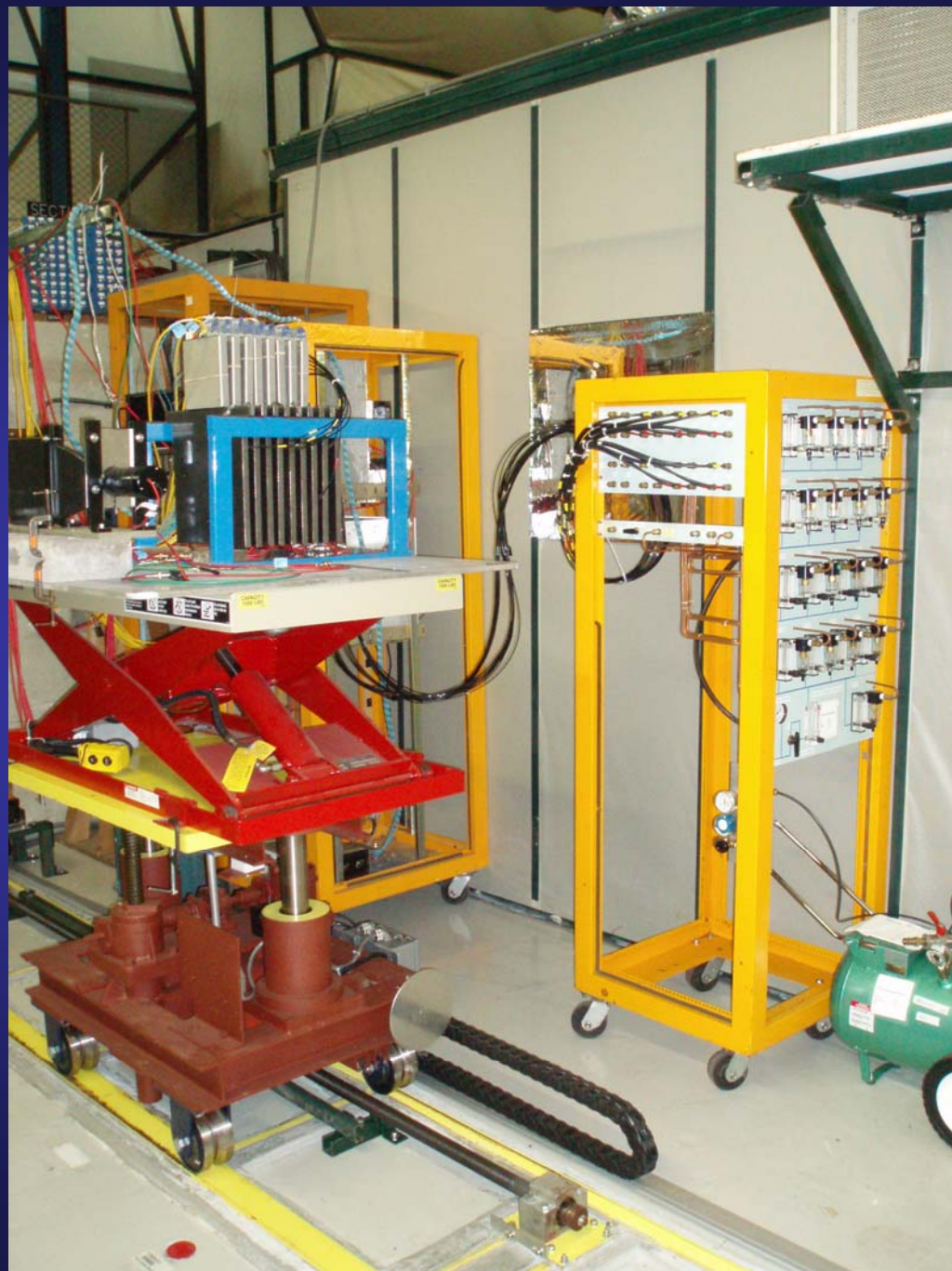

Stack with 6 – 9 layers

Maximum number of channels \rightarrow 2304

High Voltage

Using 1 Bertan unit for all default RPCs

HV = 6.2 – 6.5 kV

Using separate Bertan unit for exotic RPC

HV = 5.9 – 6.1 kV

Gas system

Individual lines to each chamber
Premixed gas brought from ANL



Electronic Readout System

Attempt to be as similar as possible to what's needed for the PS

Components

DCAL ASIC
Pad-boards
Front-end boards
Data concentrators
Data collectors
Timing and trigger module

ANL/FNAL
ANL
ANL
ANL
Boston
FNAL

Prototyping and commissioning

Used 2nd round of DCAL prototypes
All other components: 1st prototypes
→ all worked very well

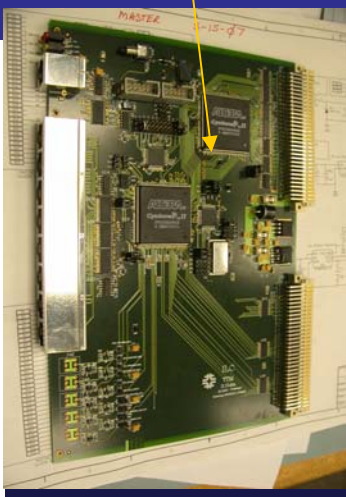
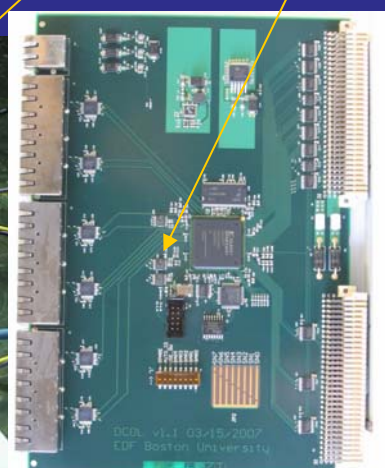
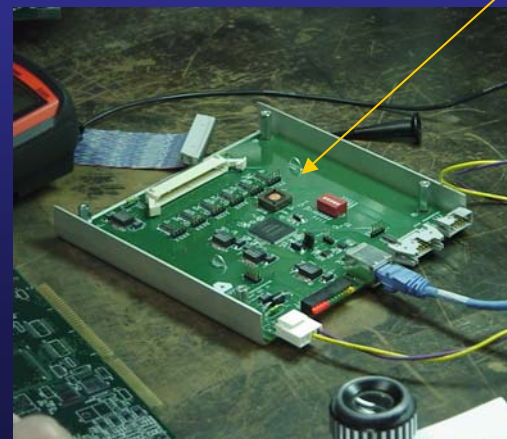
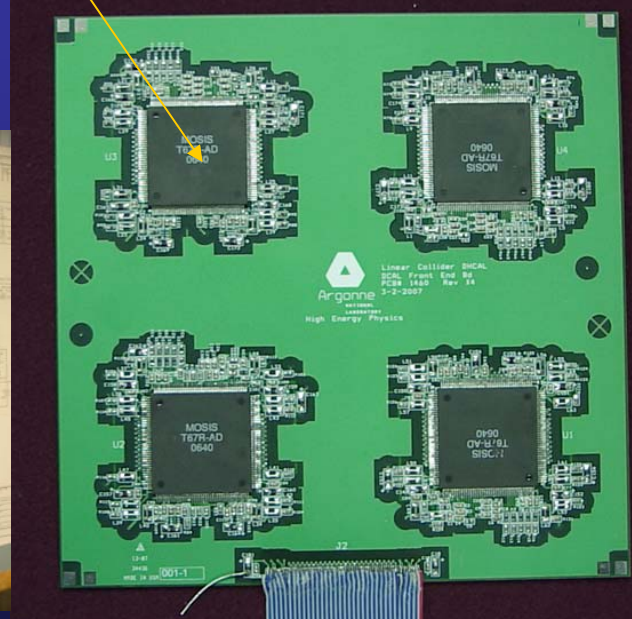
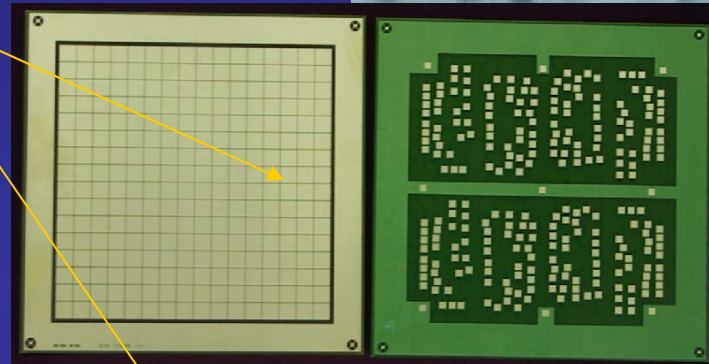
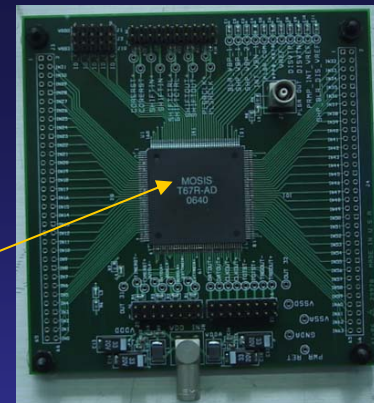
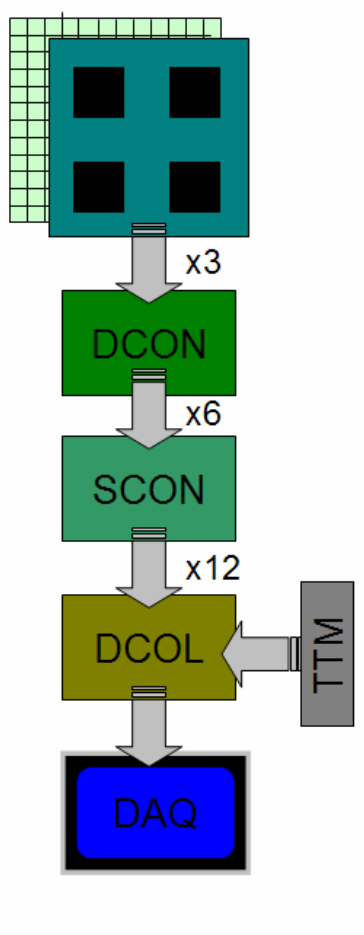

Trigger counters

Two 19 x 19 cm² scintillator panels
Initially used three 1 x 1 cm² finger counters
(imaging calorimeter makes these redundant)

Additional Fe Absorber

For muon runs at 2 GeV/c stacked additional
Fe blocks in front of RPCs

~ 50 cm deep corresponding to $3 \lambda_I$
→ 97% of π interact
→ $\Delta E_\mu \sim 600$ MeV



Running conditions

Beam between 6:00 – 18:00 daily
1 spill every minute with 4 sec flat top
Interruptions due to Tevatron shots/machine problems
(rare...)

Rate adjusted to RPC recovery time

MTBF

Very positive experience

Machine people very cooperative!

Beams reliable and only short interruptions

Roof still leaking, but fixed in the meantime

New laser alignment system (very useful)

Nicely labeled cable panels in test area and counting house

User area greatly improved

Pictures from the past...



(Some) people



Ed Norbeck (HV, ga)



Tim Cundiff
(Pad-, FE-baords)

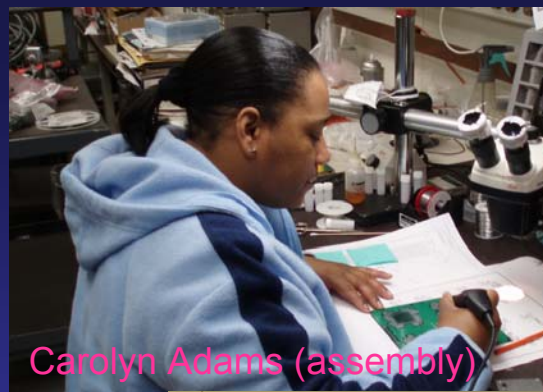

Carolyn Adams (assembly)



Dave Underwood
(trigger, data taking)



Shouxiang Wu
(DCOL)



José Repond
(coordination, offline)



Georg Mavromanolakis
(event display)



Bill Haberichter (DCOL)



Eric Hazen (DCOL)



Gary Drake
(electronic system)



Xia (RFC,
data taking, offline)



Andrew Kreps
(slow control)



Ed May (DAQ, data taking)

Problems

Scanning table

Sagging
→ solution

Humidity

Rain into the building (roof being repaired)
Very humid conditions
→ changes in the surface resistivity
→ a few HV break downs

Noise

Resetting slow control constants
→ running slow control every 30 seconds
→ new grounding scheme

No show stoppers

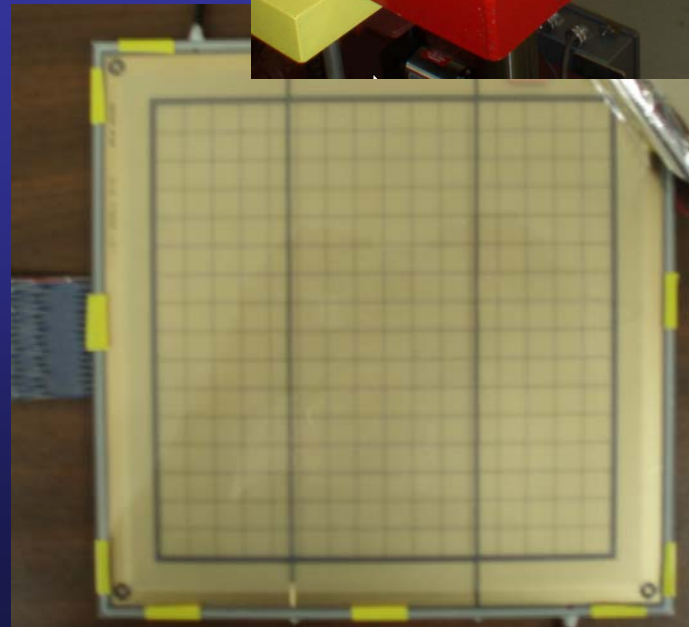

Beams and data taking

A) Muon runs

120 GeV protons
Beam blocker in (1 meter of Fe)
Steel+copper absorber plates

Chamber efficiency/pad multiplicity
as function of HV and threshold

B) Pion/positron/muon runs

1,2,4,8,16 GeV/c secondary beam
Included Čerenkov in trigger

EM and hadronic showers

Requiring Čerenkov signal (positrons)
Vetoing on Čerenkov signal (pions/muons)
Additional Fe-absorber (muons)

Steel+copper absorber plates

C) Proton runs

120 GeV protons
No beam blocker
Variable rates
PVC absorber plates

Rate capability measurement

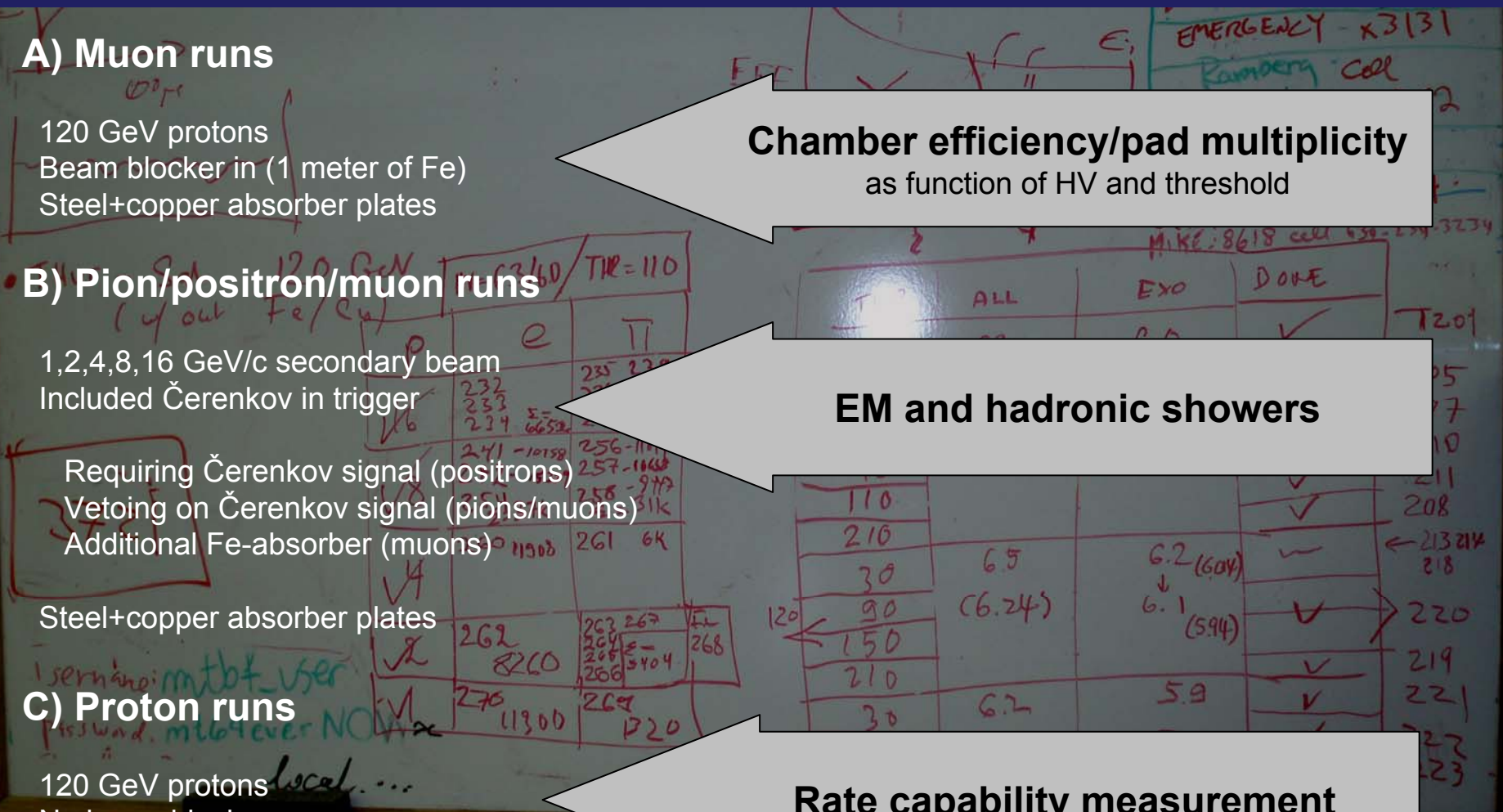

Data Quality Monitoring

A) Online event display and monitoring

Extremely useful for quick turn around
Made shorter test runs redundant

B) Offline event display

Useful to understand beam
detect noisy layers



Available <30 seconds after EOR

Binary → ASCII (x,y,z,t) ntuple

C) Offline data analysis

Useful to detect hardware problems
obtain quick preliminary results
decide on further runs



Plots available <60 seconds after EOR

A few events... μ Calibration Runs

120 GeV protons with 1 m Fe beam block
no μ momentum selection

One of many perfect μ event

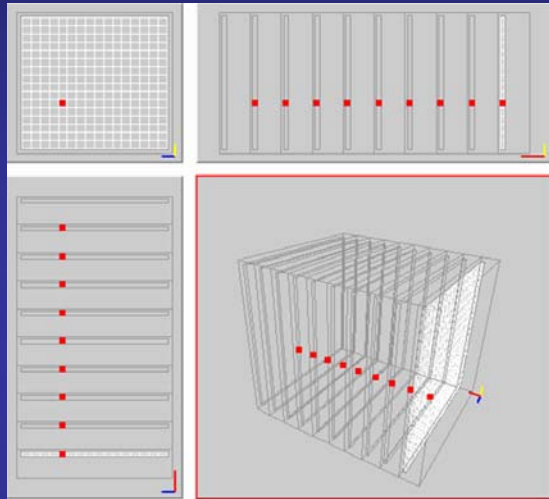

μ at an angle or multiple scattering

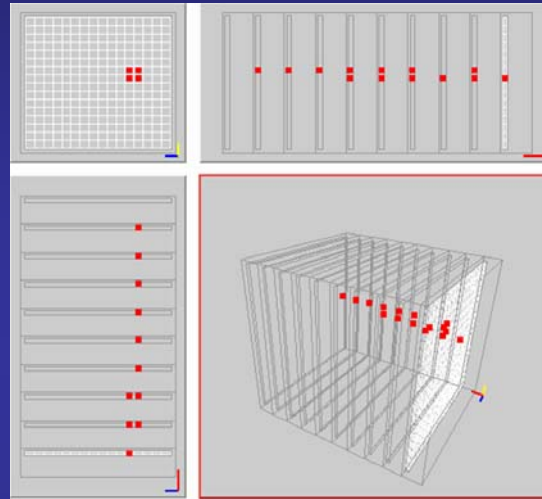

μ event with double hits in x

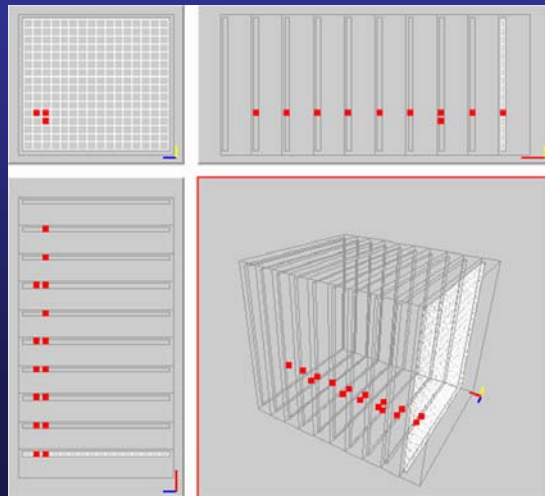

μ event with δ ray or π punch through

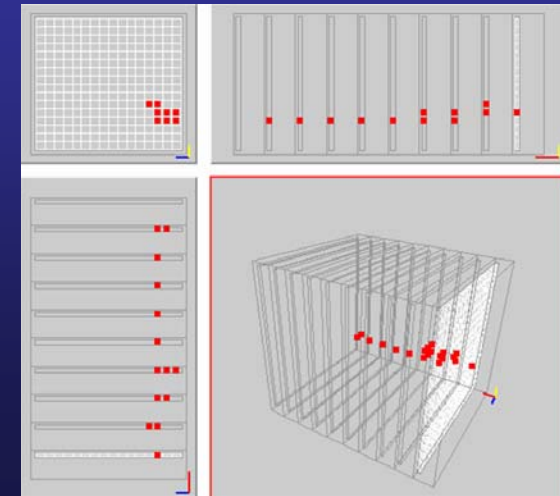

A few events...e⁺ Run

1 - 16 GeV secondary beam
Čerenkov signal required

8 GeV e⁺ event

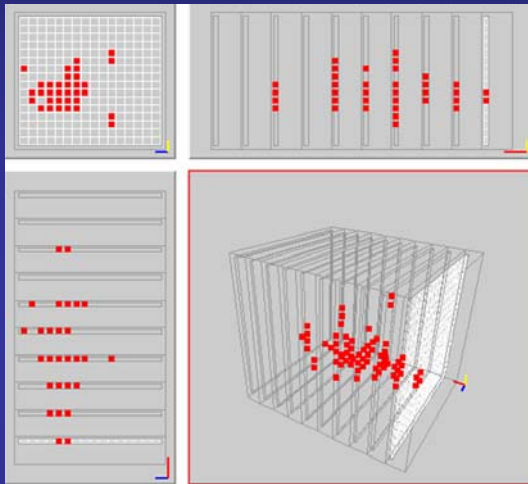

8 GeV e⁺ event

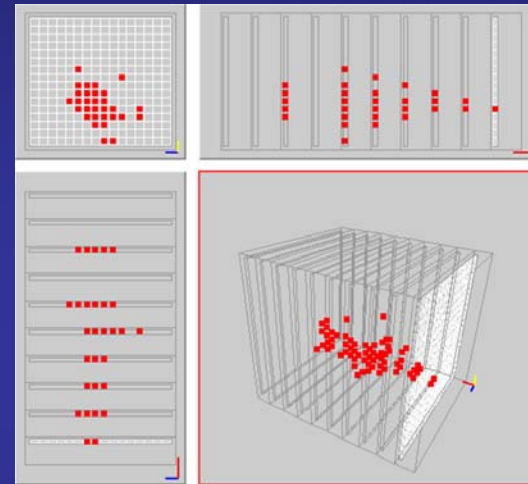

8 GeV e⁺ event with satellites

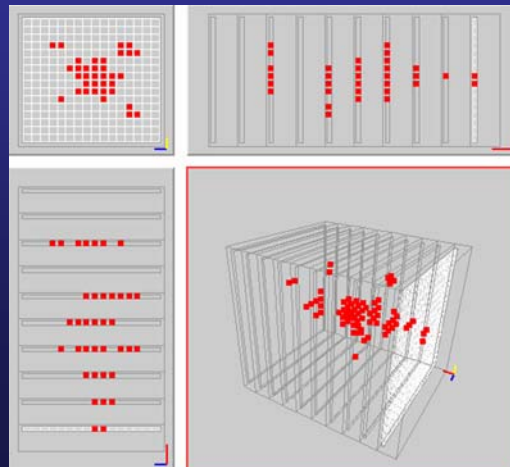

8 GeV e⁺ event

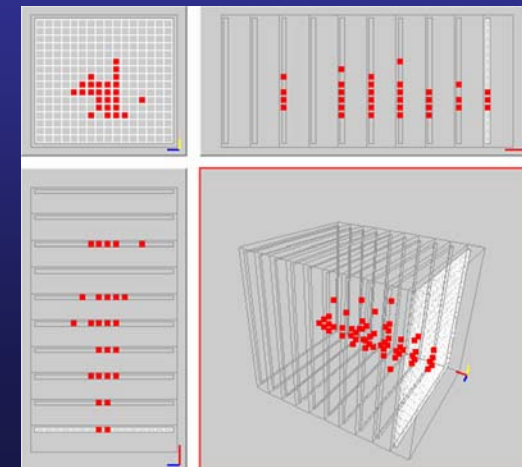

A few events... π^+ Run

1 – 16 GeV secondary beam
Veto on Čerenkov signal

8 GeV π^+ event (typical)

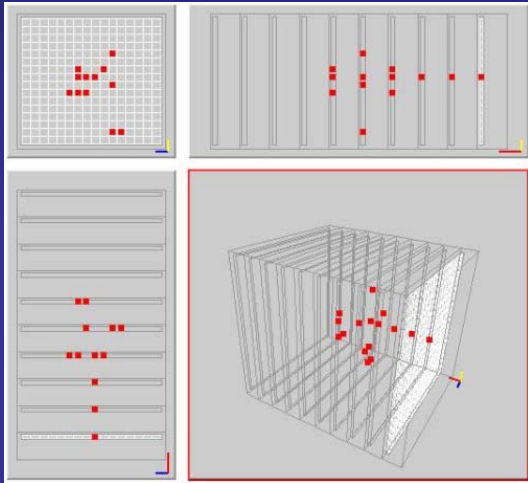

8 GeV π^+ event (early shower)

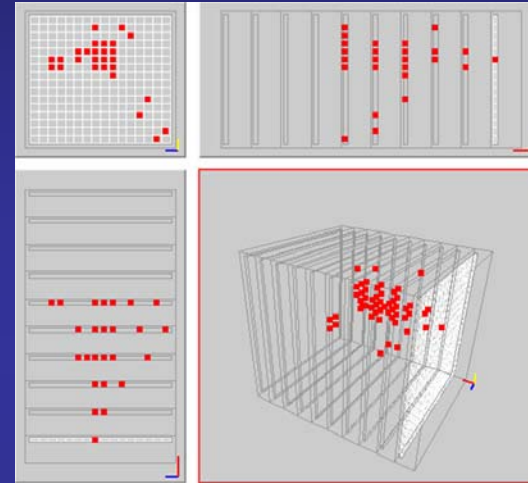

8 GeV π^+ event (early shower)

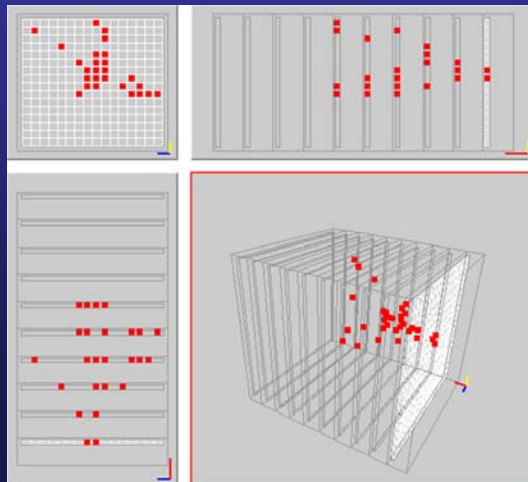

8 GeV π^+ event (early shower)

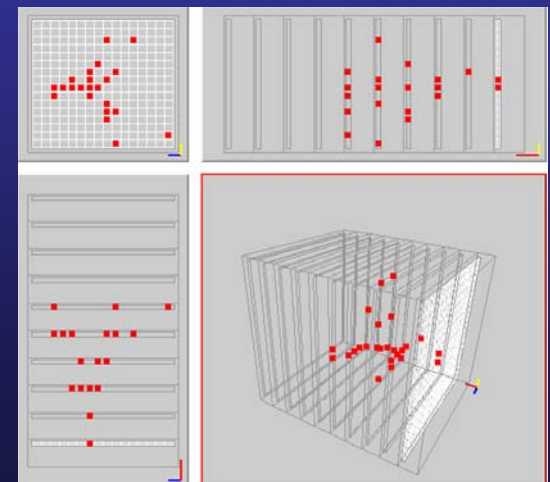

A few events...Multiple particles

120 GeV protons without beam block

2π event (upstream shower?)

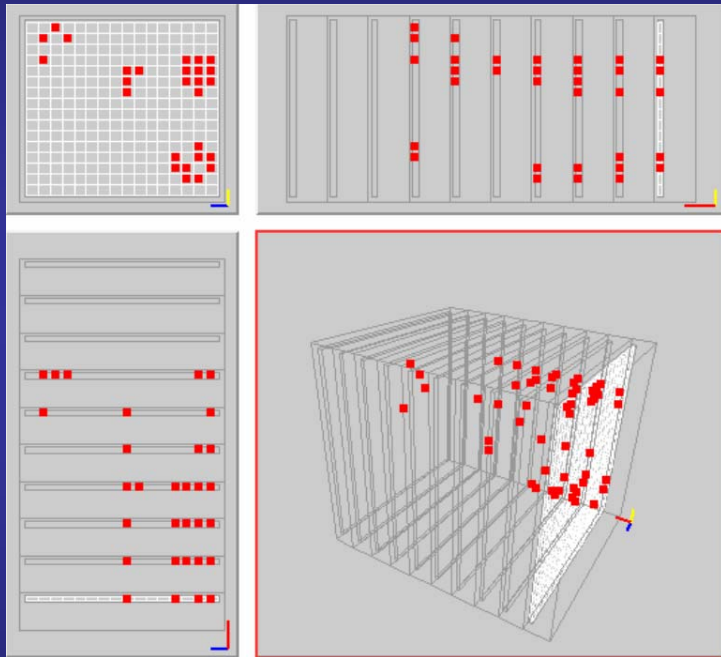

3π event (upstream shower?)

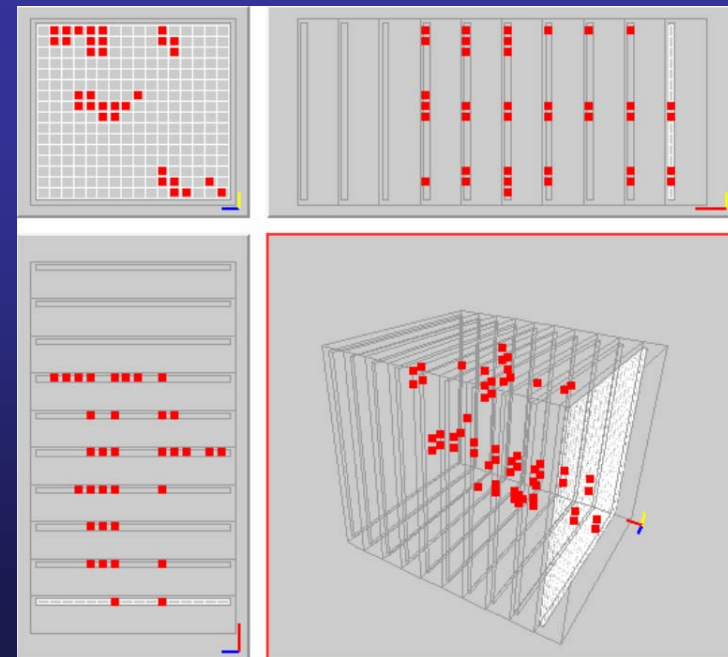

Conclusion

The Vertical Slice Test was a big success

The RPCs
Electronic readout system
Data acquisition
Beam

} worked very well

Expect 4 – 5 papers

**We validated the DHCAL concept and
our technical approach**

→ **We are ready for the next step**

i.e. prototype

To be completed in 2007?

Larger RPCs
Cheaper Pad- and Front-end boards
Final data (and super) concentrators

Identical to what's needed for the PS

Physics prototype

Gas and HV system ~ complete
DCAL ASIC design finalized (no more prototyping needed)

We have the will and the means to build the 1 m³ physics prototype