



ILC Beam Delivery System and ATF2 design

Andrei Seryi

SLAC

for BDS design team

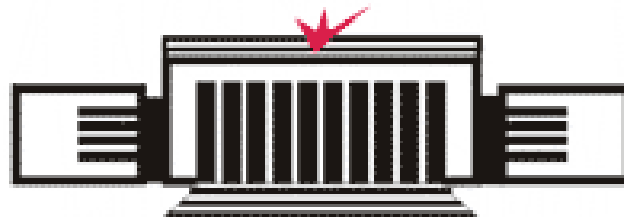

NANOBEBAM'08

May 25-30, 2008, Budker INP, Novosibirsk, Russia



BDS: from end of linac to IP, to dumps

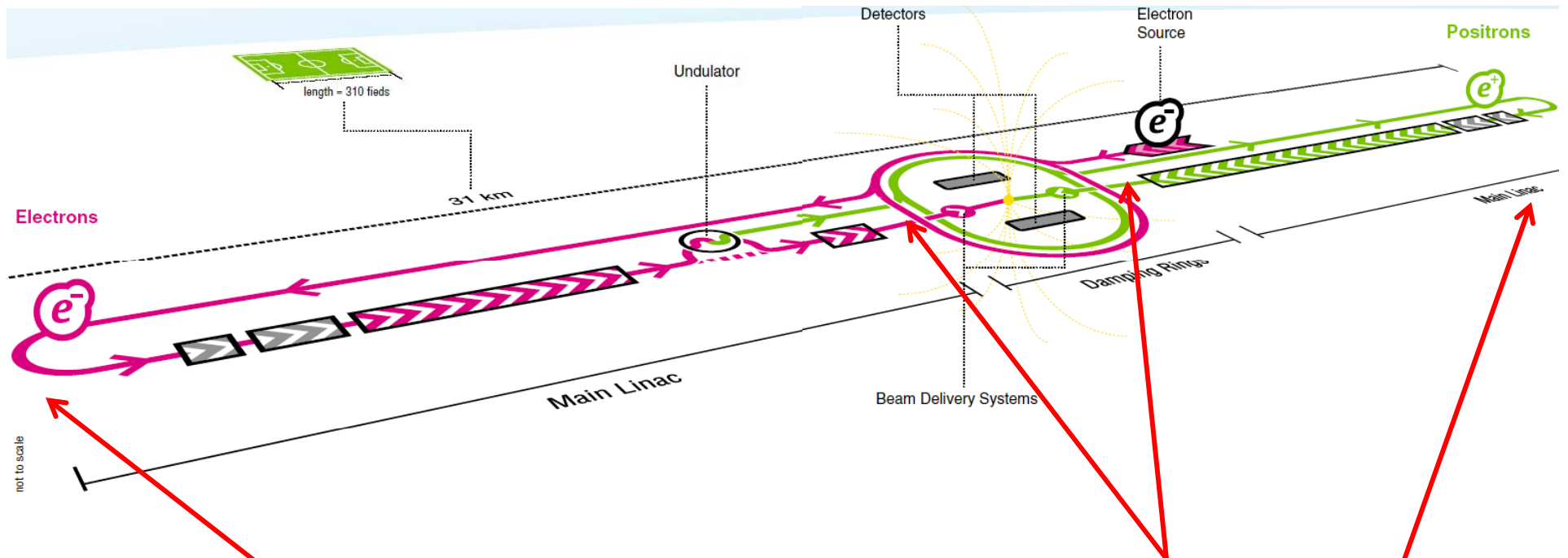

Beam Delivery System
(BDS)

International Linear Collider



Layout of Beam Delivery tunnels

- Single IR push-pull BDS, upgradeable to 1TeV CM in the same layout, with additional bends

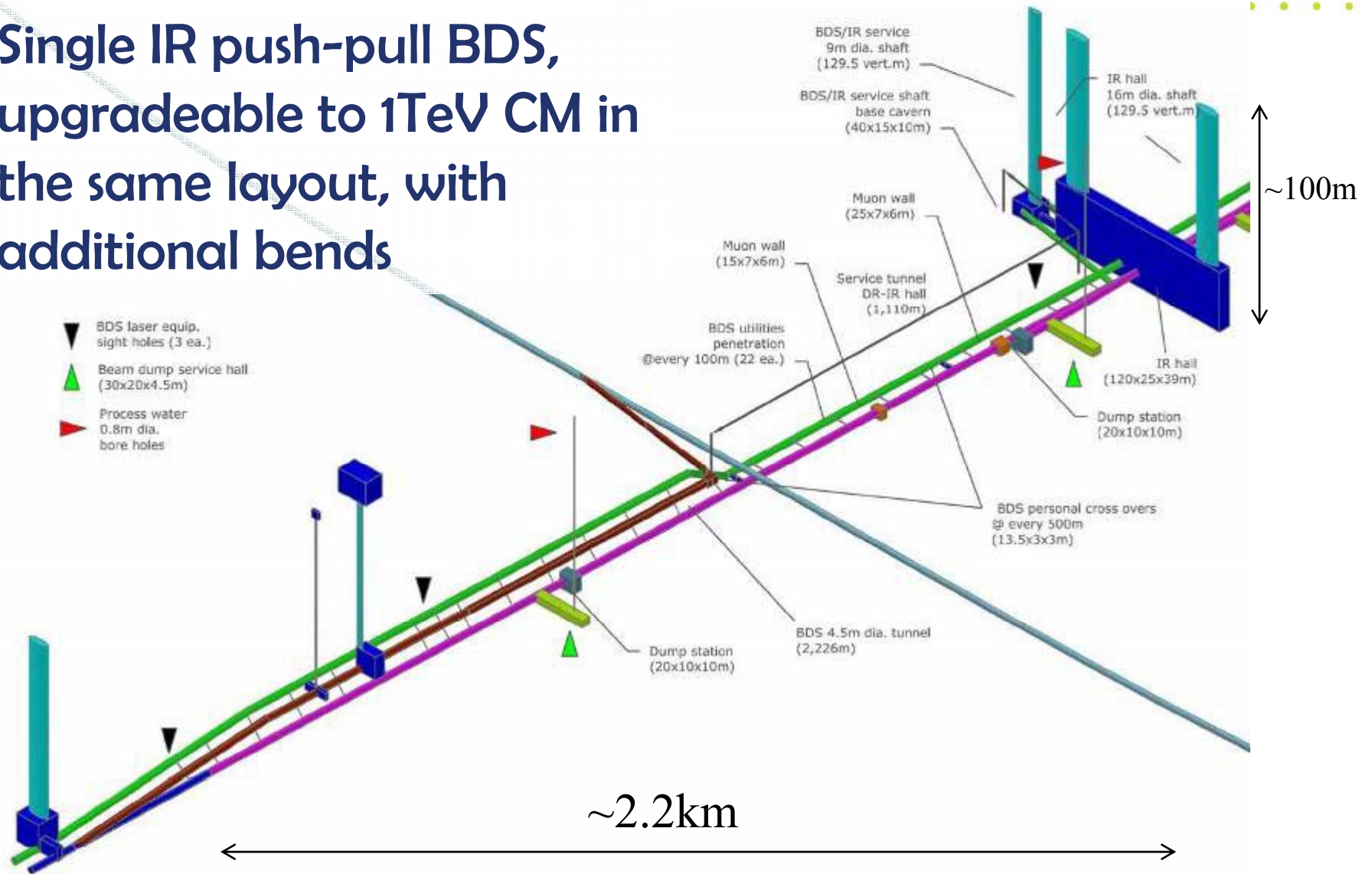



ILC Beam Delivery subsystems

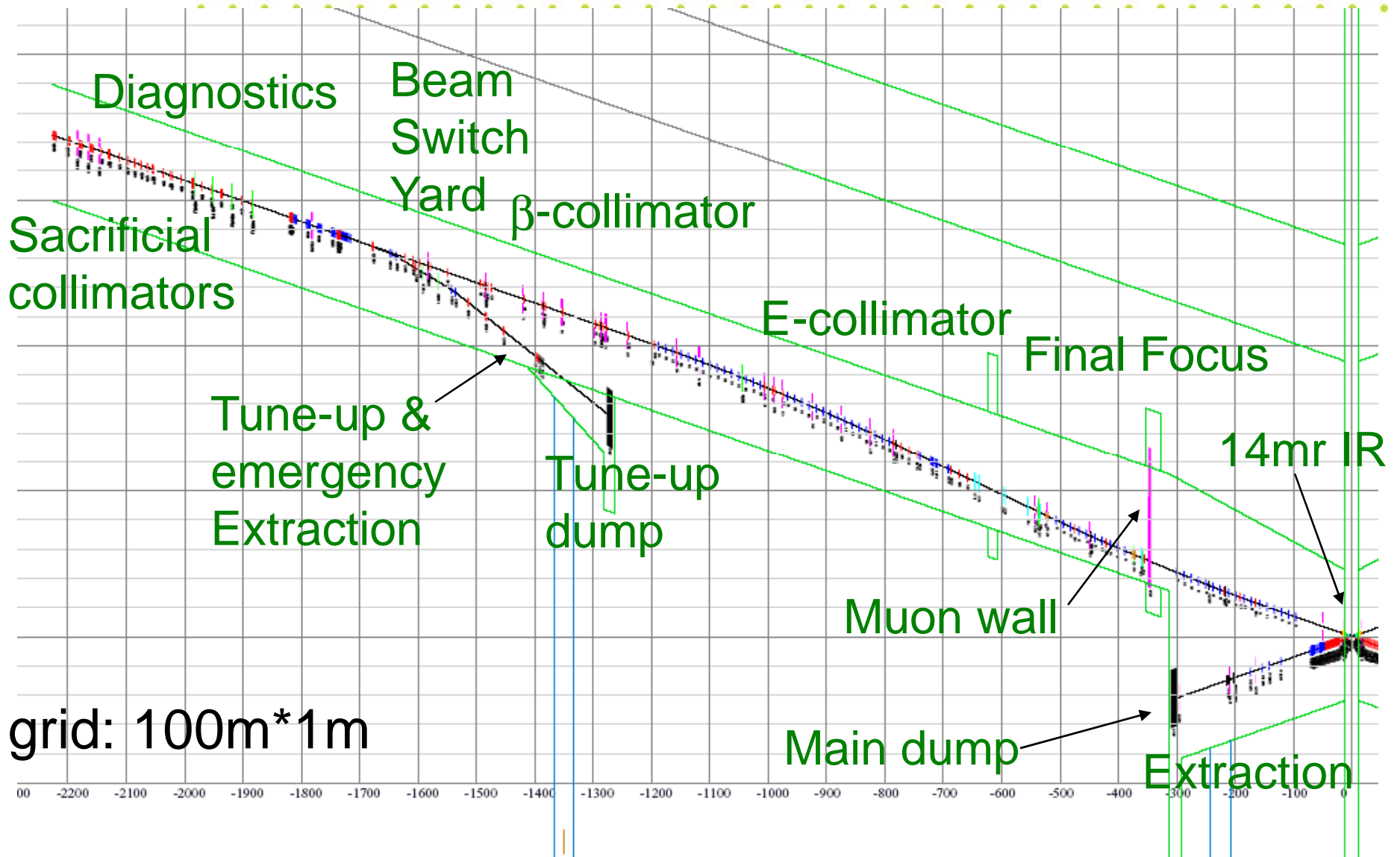



BDS functions and optics

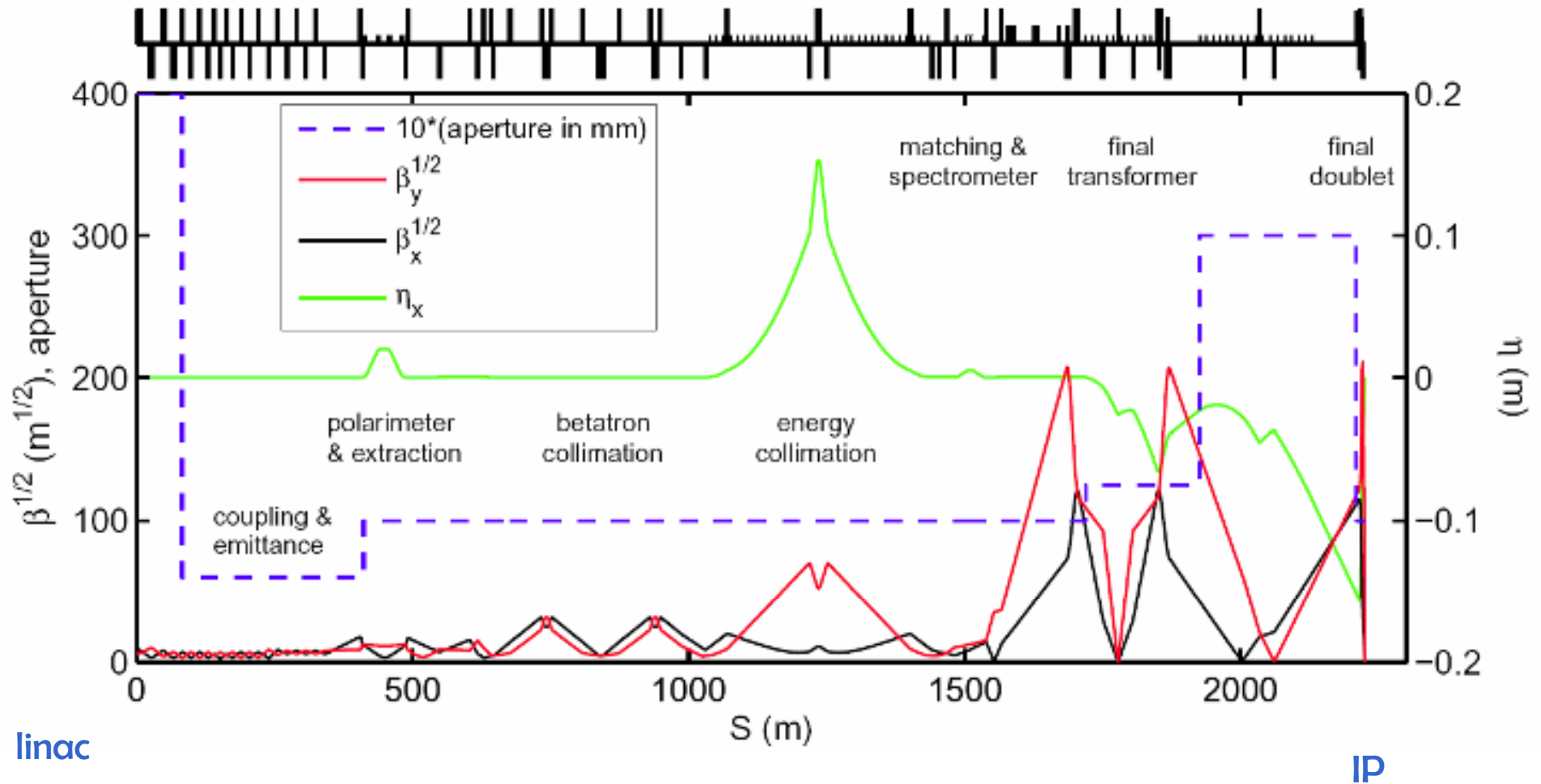

linac

IP



Beam Delivery System tasks

- measure the linac beam and match it into the final focus
- remove any large amplitude particles (beam-halo) from the linac to minimize background in the detectors
- measure and monitor the key physics parameters such as energy and polarization before and after the collisions
- ensure that the extremely small beams collide optimally at the IP
- protect the beamline and detector against mis-steered beams from the main linacs and safely extract them to beam dump
- provide possibility for two detectors to utilize single IP with efficient and rapid switch-over



Parameters of ILC BDS

Length (linac exit to IP distance)/side	m	2226
Length of main (tune-up) extraction line	m	300 (467)
Max Energy/beam (with more magnets)	GeV	250 (500)
Distance from IP to first quad, L^*	m	3.5-(4.5)
Crossing angle at the IP	mrad	14
Nominal beam size at IP, σ^* , x/y	nm	655/5.7
Nominal beam divergence at IP, θ^* , x/y	μrad	31/14
Nominal beta-function at IP, β^* , x/y	mm	21/0.4
Nominal bunch length, σ_z	μm	300
Nominal disruption parameters, x/y		0.162/18.5
Nominal bunch population, N		2×10^{10}
Max beam power at main and tune-up dumps	MW	18
Preferred entrance train to train jitter	σ	< 0.5
Preferred entrance bunch to bunch jitter	σ	< 0.1
Typical nominal collimation depth, x/y		8–10/60
Vacuum pressure level, near/far from IP	nTorr	1/50



Factors driving design of BDS

- Final Doublet chromaticity
 - local compensation of chromaticity
- Beam-beam effects
 - background, IR and extraction design
- SR emittance growth in BDS bends
 - weak and long
- Halo collimation
 - survivability of spoilers
- Beam diagnostics
 - measurable size at laser wires
- ...

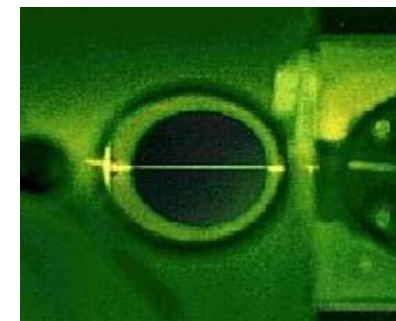
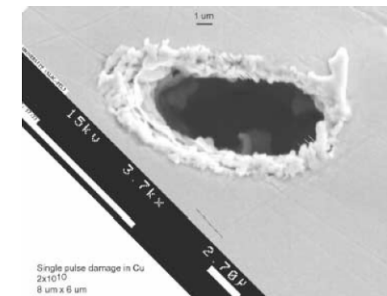
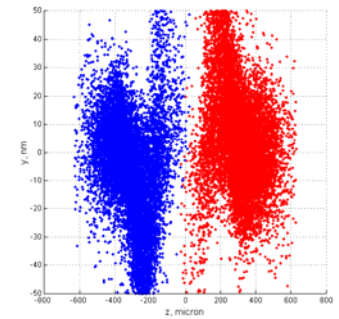
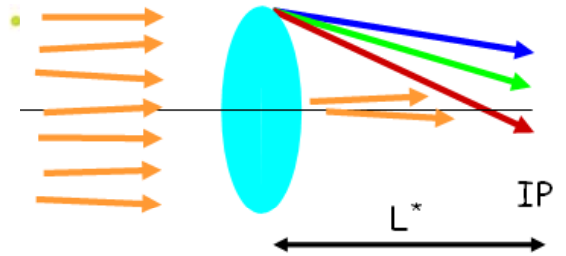



Final Focus Test Beam – optics with traditional non-local chromaticity compensation

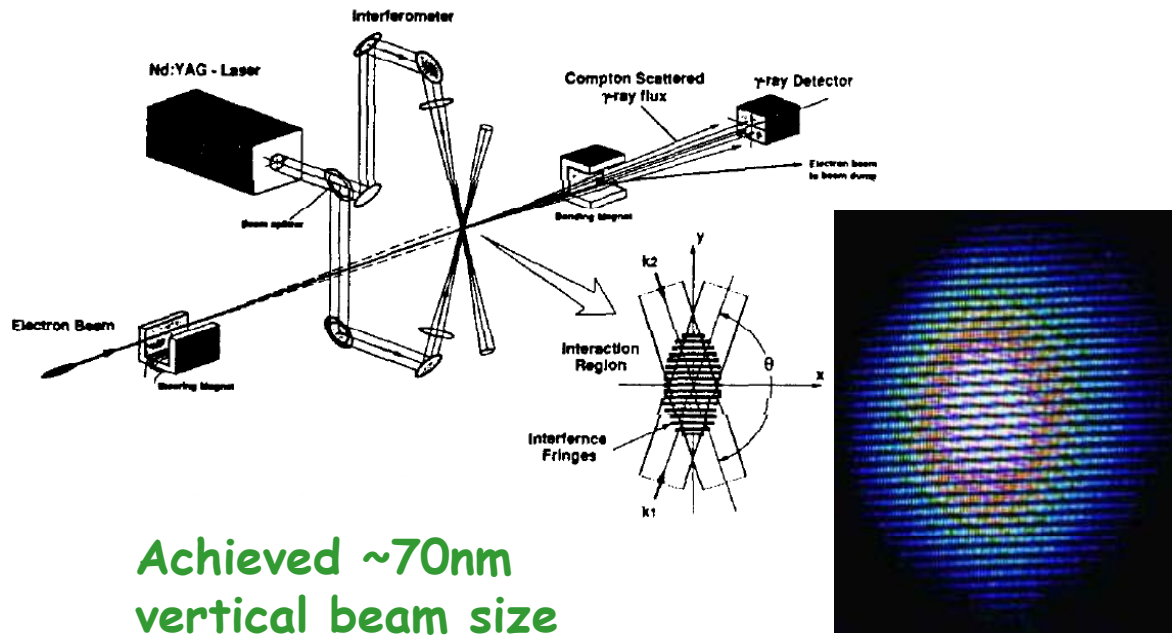
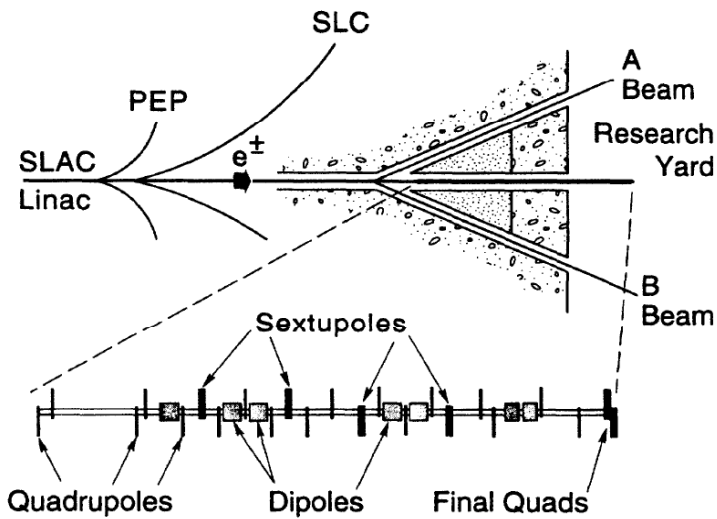

Achieved ~70nm vertical beam size



NB08, A.Seryi, May 26, 2008

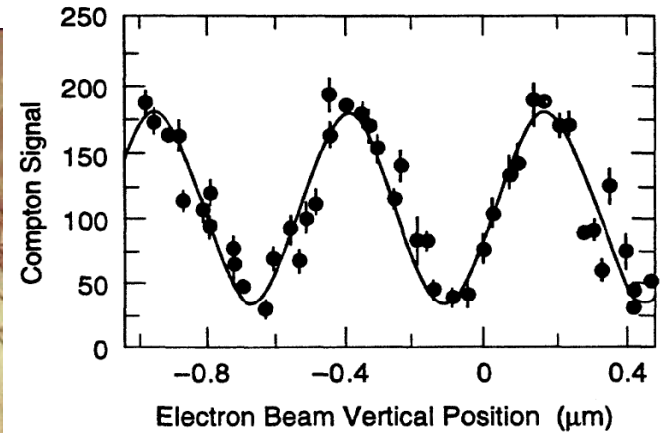
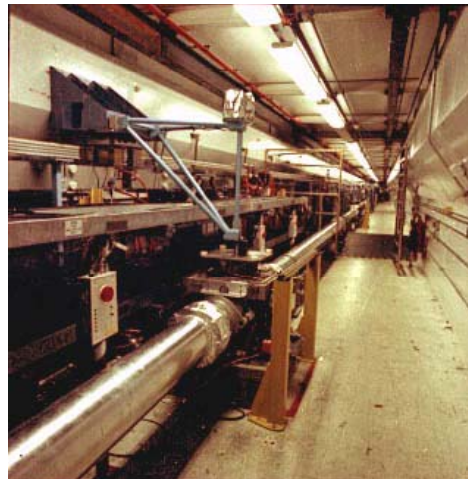



TeV FF with non-local chromaticity compensation

- Chromaticity is compensated by sextupoles in dedicated sections
- Geometrical aberrations are canceled by using sextupoles in pairs with $M = -1$

Chromaticity arise at FD but pre-compensated 1000m upstream

Problems:

- Chromaticity not locally compensated
 - Compensation of aberrations is not ideal since $M \neq -1$ for off energy particles
 - Large aberrations for beam tails
 - ...

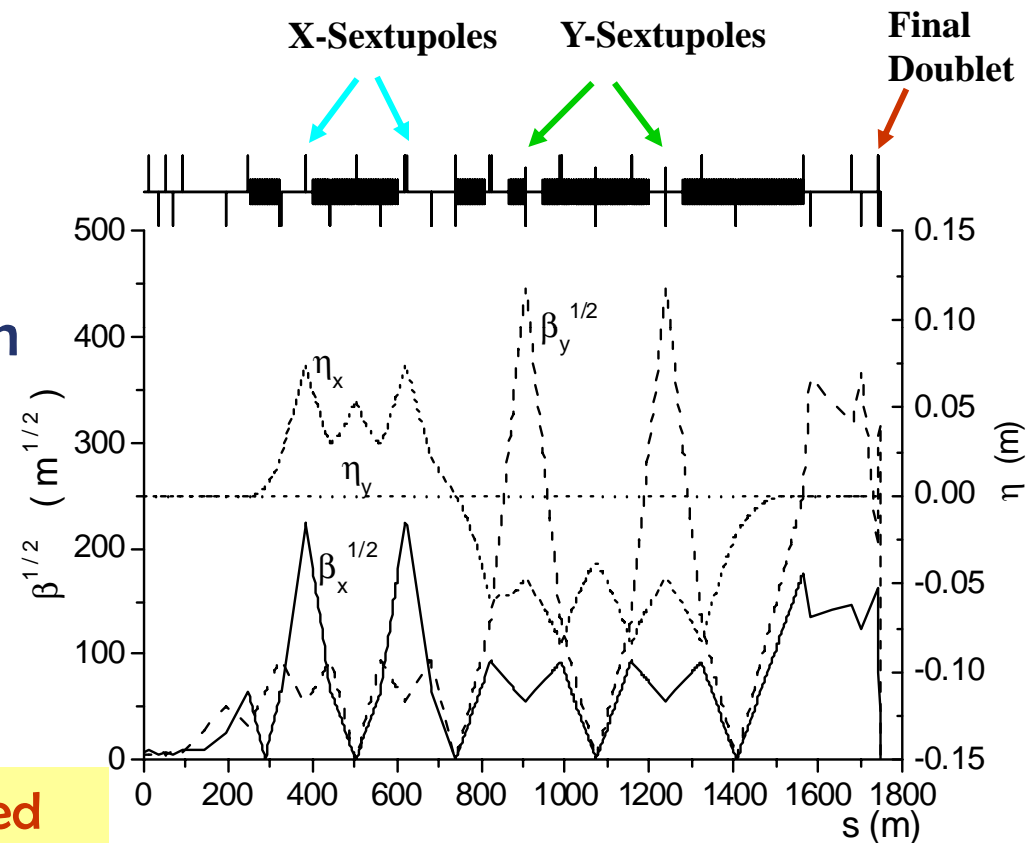

Traditional FF
(NLC FF, circa 1999)
 $L^* = 2\text{m}$, TeV energy reach



FF with local chromatic correction

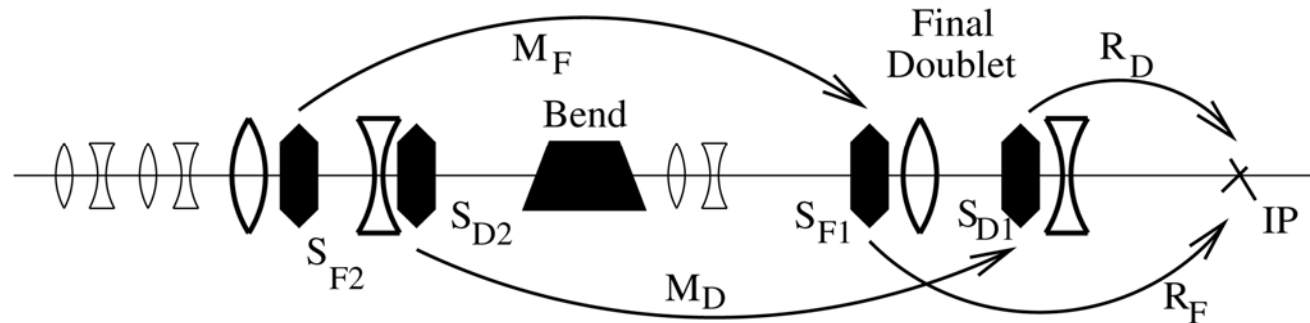

- **Chromaticity** is cancelled **locally** by two sextupoles **interleaved with FD**, a bend upstream generates dispersion across FD
- 2nd order dispersion produced in FD is cancelled locally provided that half of horizontal chromaticity arrive from upstream
- **Geometric aberrations** of the FD sextupoles are cancelled by two more sextupoles placed in phase with them and upstream of the bend
- Higher order aberrations are cancelled by optimizing transport matrices between sextupoles

P.Raimondi, A.Seryi, PRL, 86, 3779 (2001)



Chromatic correction in FD

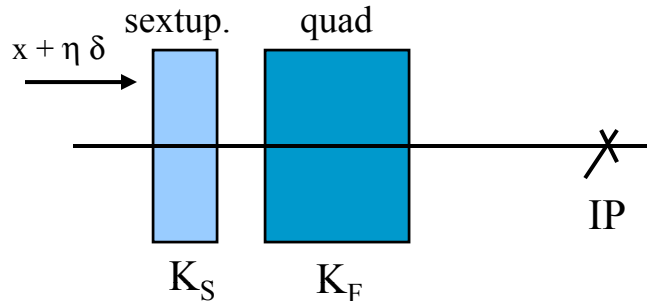

- Straightforward in Y plane
- a bit tricky in X plane:

Quad: $\Delta x' = \frac{K_F}{(1+\delta)}(x + \eta\delta) \Rightarrow K_F(-\delta x - \eta\delta^2)$

chromaticity

Second order dispersion

Sextupole: $\Delta x' = \frac{K_S}{2}(x + \eta\delta)^2 \Rightarrow K_S\eta(\delta x + \frac{\eta\delta^2}{2})$

If we require $K_S\eta = K_F$ to cancel FD chromaticity, then half of the **second order dispersion** remains.

$\Delta x' = \frac{K_F}{(1+\delta)}(x + \eta\delta) + \frac{K_{\beta\text{-match}}}{(1+\delta)}x \Rightarrow 2K_F(-\delta x - \frac{\eta\delta^2}{2})$

Solution:

The β -matching section produces as much X chromaticity as the FD, so the X sextupoles run twice stronger and cancel the **second order dispersion** as well.

$K_{\beta\text{-match}} = K_F \quad K_S = \frac{2K_F}{\eta}$



Compare FF designs

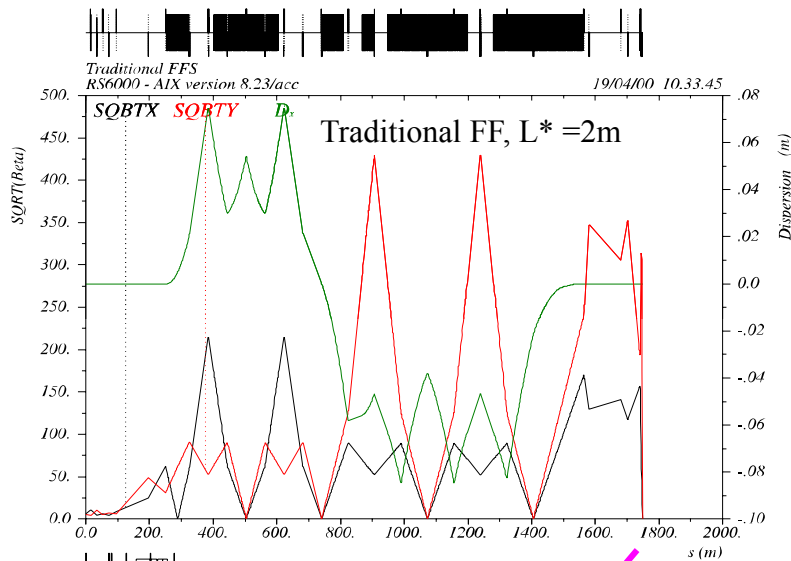

FF with local chromaticity compensation with the same performance can be ~300m long, i.e. 6 times shorter

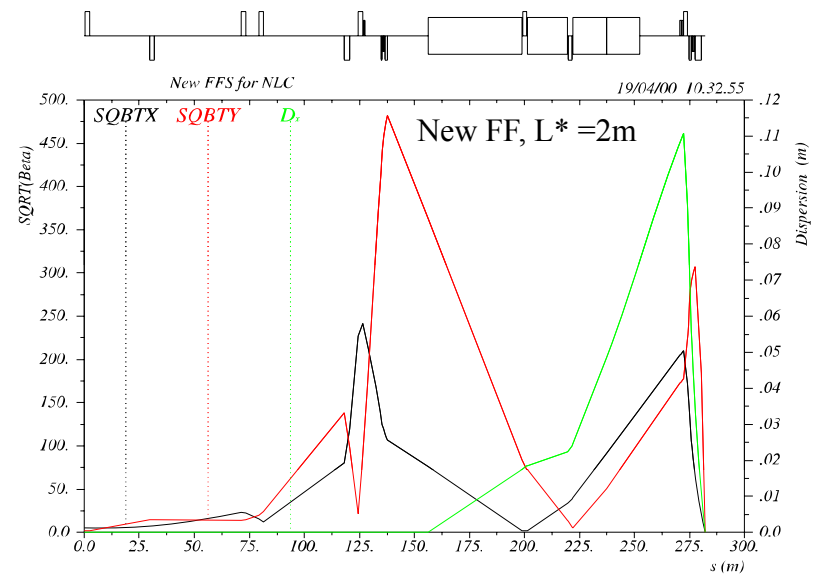
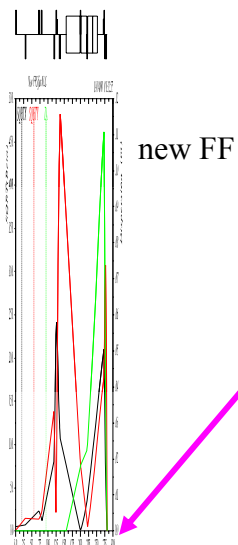



IP bandwidth

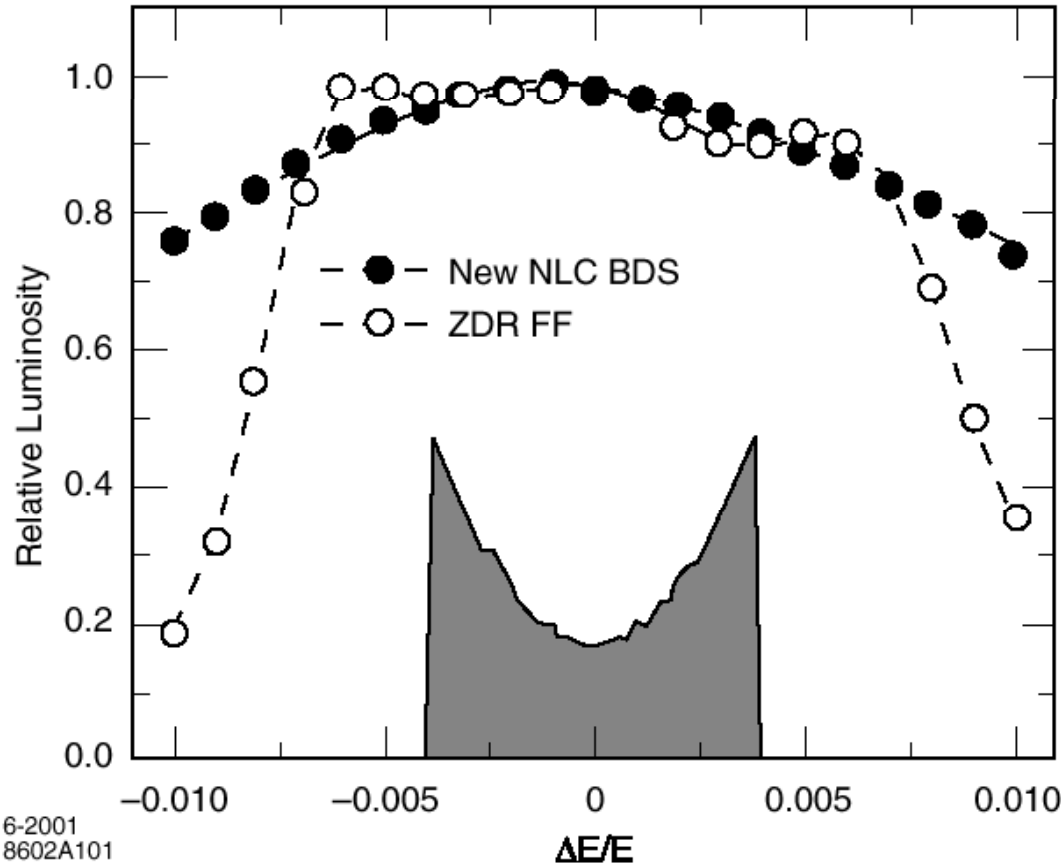

Bandwidth of FF with local chromaticity correction can be better than for system with non-local correction

6-2001
8602A101



BDS design methods & examples

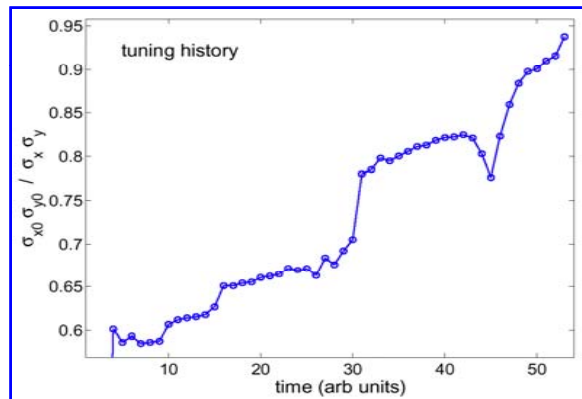
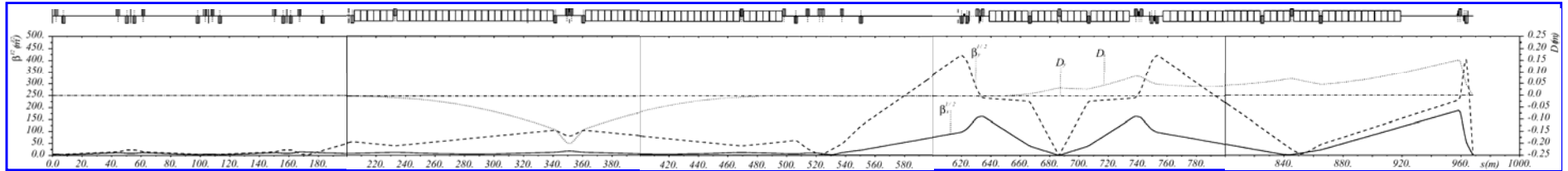

Example of a 2nd IR BDS optics for ILC; design history; location of design knobs

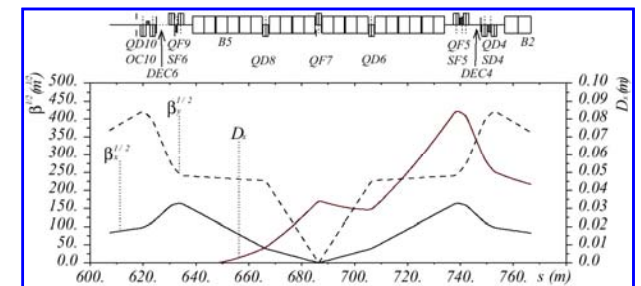
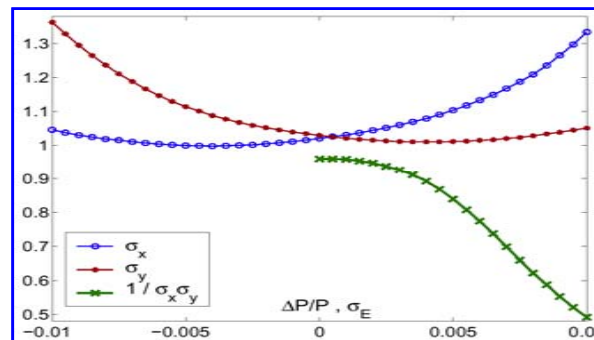
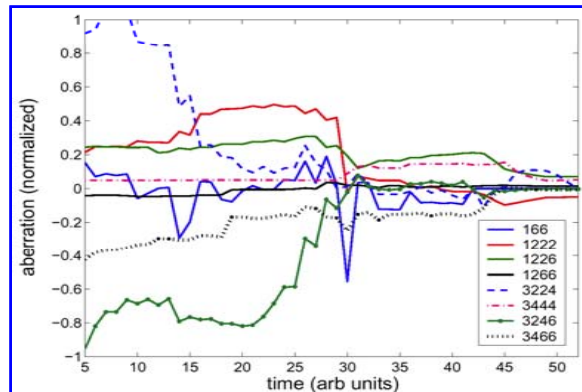
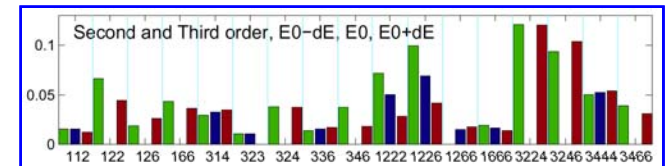
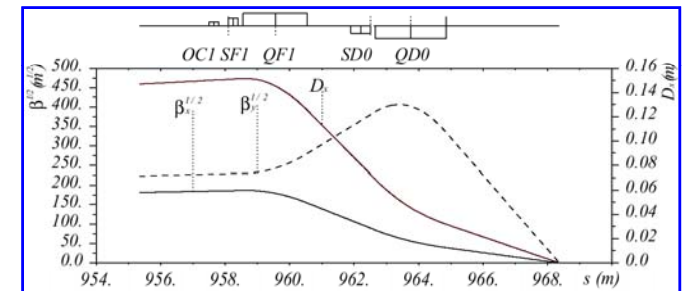



Aberrations & halo generation in FF

- FF with non-local chr. corr. generate beam tails due to aberrations and it does not preserve betatron phase of halo particles
- FF with local chr. corr. has much less aberrations and it does not mix phases particles

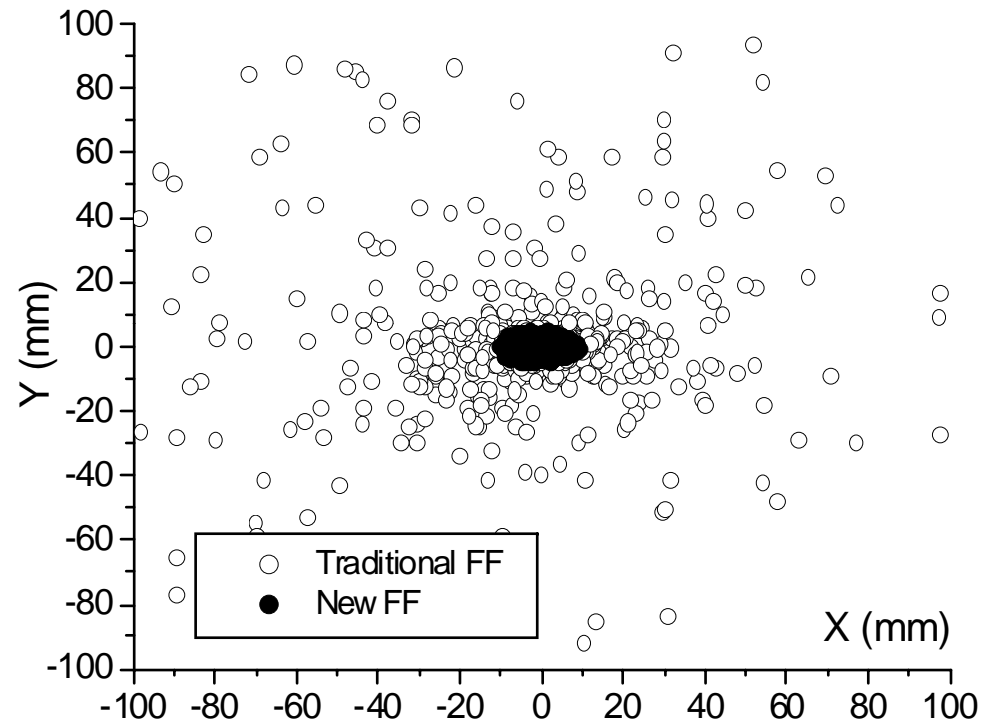
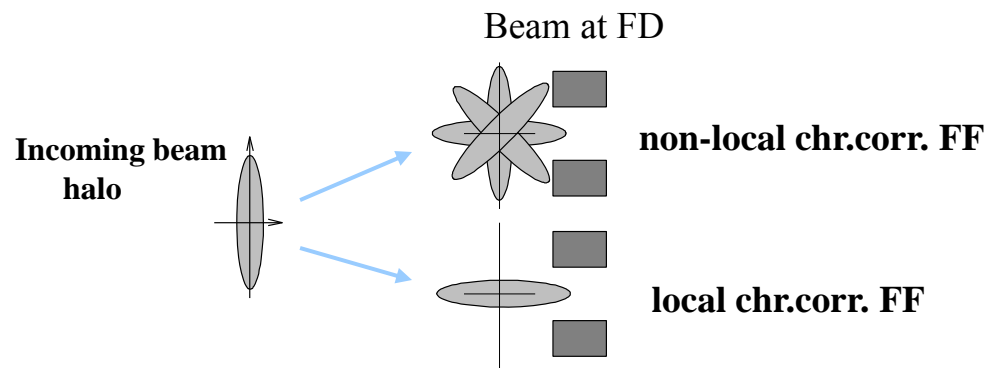

**Halo beam at the FD entrance.
Incoming beam is ~ 100 times larger than
nominal beam**



Beam halo & collimation

- Even if final focus does not generate beam halo itself, the halo may come from upstream and need to be collimated

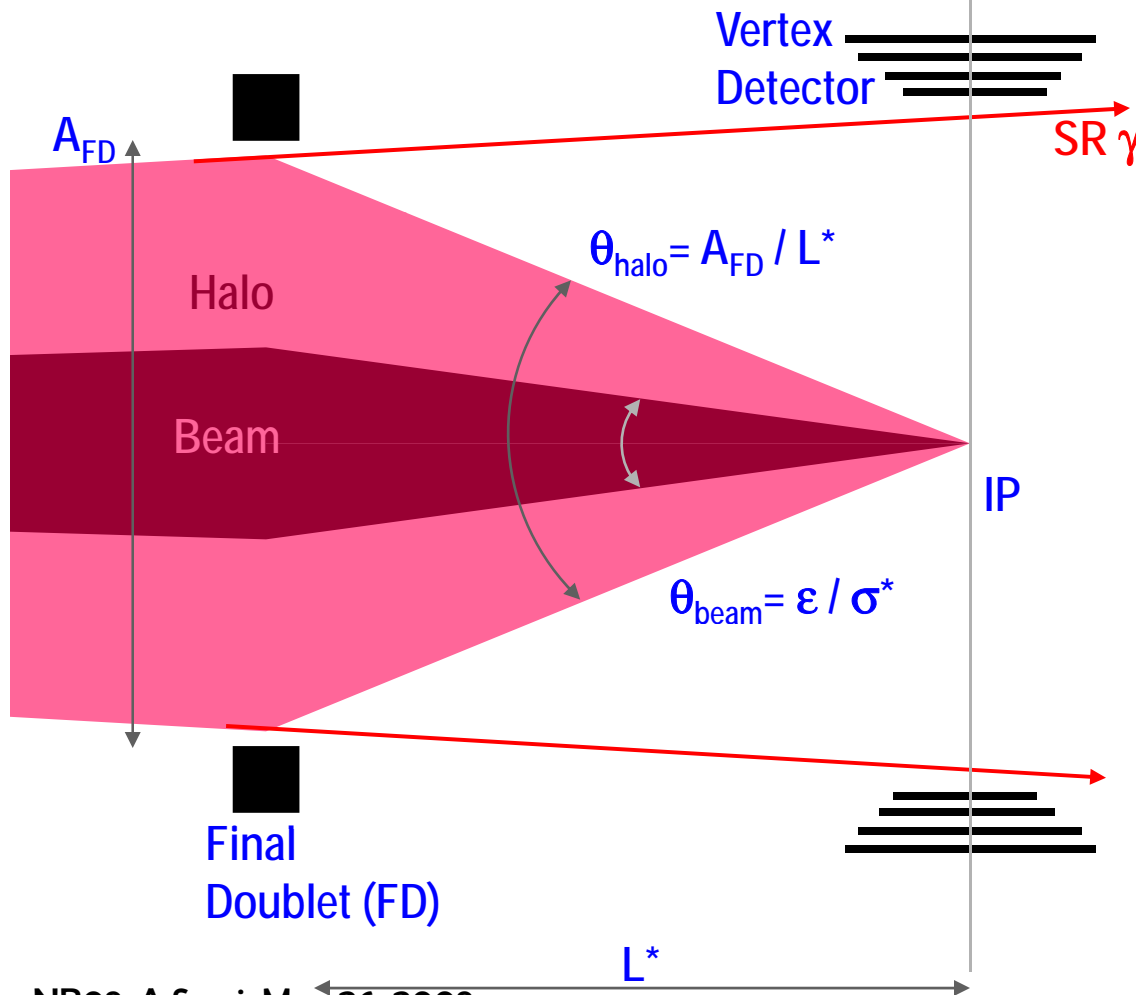

- Halo must be collimated upstream in such a way that SR γ & halo e^+ do not touch VX and FD
- \Rightarrow VX aperture needs to be somewhat larger than FD aperture
- Exit aperture is larger than FD or VX aperture
- Beam convergence depend on parameters, the halo convergence is fixed for given geometry
- $\Rightarrow \theta_{\text{halo}} / \theta_{\text{beam}}$ (collimation depth) becomes tighter with larger L^* or smaller IP beam size
- Tighter collimation \Rightarrow MPS issues, collimation wake-fields, higher muon flux from collimators, etc.



More on collimation issues

- **Background:** muons generated at collimators
 - collimators has to be placed far from IP

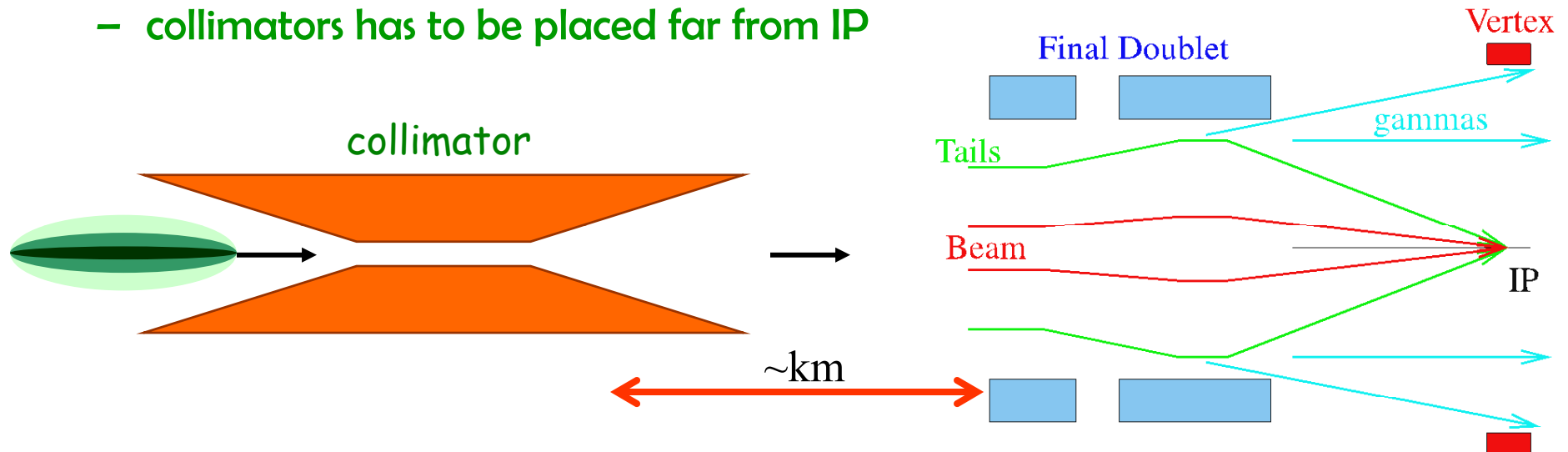

- **Machine protection:** errant bunches hitting the collimator
 - damage due to shower and ionization loss is mitigated by
 - using thin spoiler – thick absorber pairs
 - increase of beam size at spoilers
 - Extraction of the rest of errant train into emergency extraction beamline
- **Wakefields:** emittance growth due to beam offsets in collimators



Spoiler-Absorber & spoiler design

Spoiler / Absorber Scheme

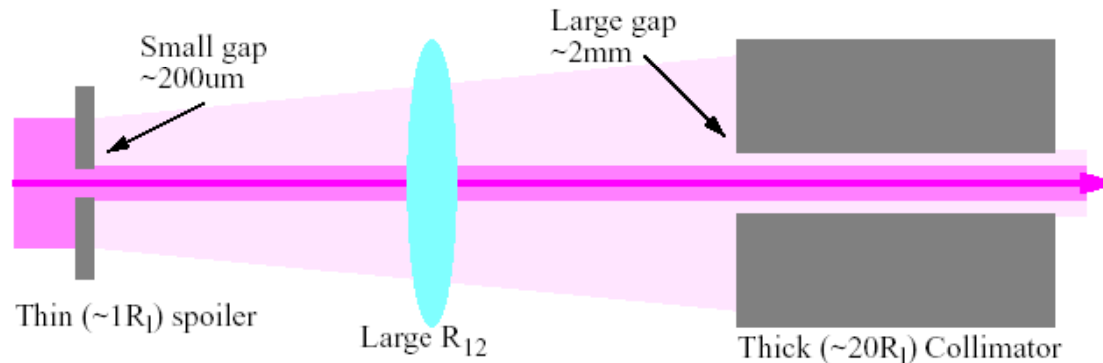

Thin spoiler increases beam angles and size at the thick absorber already sufficiently large. Absorber is away from the beam and contributes much less to wakefields.

Tapered low resistivity surface for wakefields

Thin hi-Z spoiler

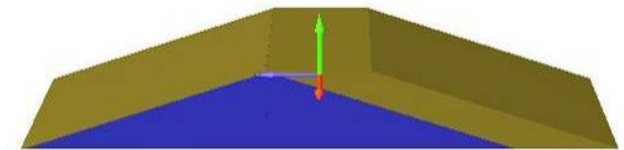
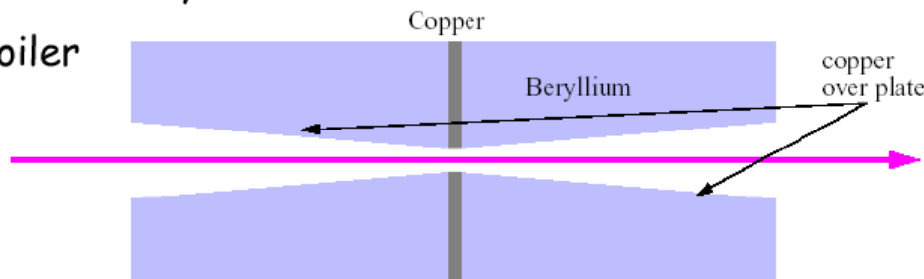

Recently considered design:
0.6 X₀ of Ti alloy leading taper
(gold), graphite (blue), 1 mm thick
layer of Ti alloy

Need the spoiler thickness increase rapidly, but need that surface to increase gradually, to minimize wakefields. The radiation length for Cu is 1.4cm and for Be is 35cm. So, Be is invisible to beam in terms of losses. Thin one micron coating over Be provides smooth surface for wakes.



Survivable and consumable spoilers

- In ILC with 300ns between bunches, Machine Protection System (MPS) will let not more than 2 errant bunches onto the spoiler
 - => for ILC it is practical to increase the beam size at spoilers so that spoilers survive two full charge bunches
- For designs with short (\sim ns) spacing between bunches it may be more practical to use consumable or renewable spoilers
 - E.g. as the design considered earlier for NLC. (This concept is now being applied to LHC collimator system.)

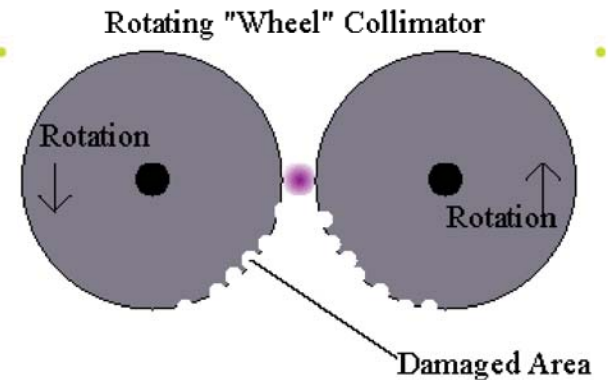

Renewable spoilers considered for NLC

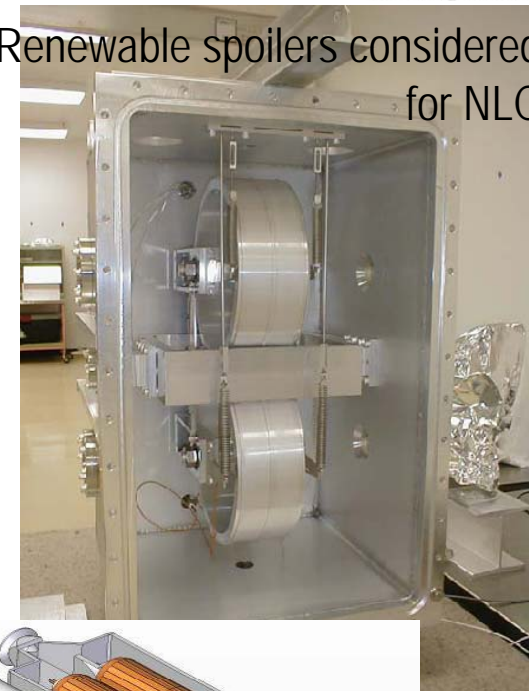



ILC FF & Collimation

- Betatron spoilers survive up to two bunches
- E-spoiler survive several bunches
- One spoiler per FD or IP phase

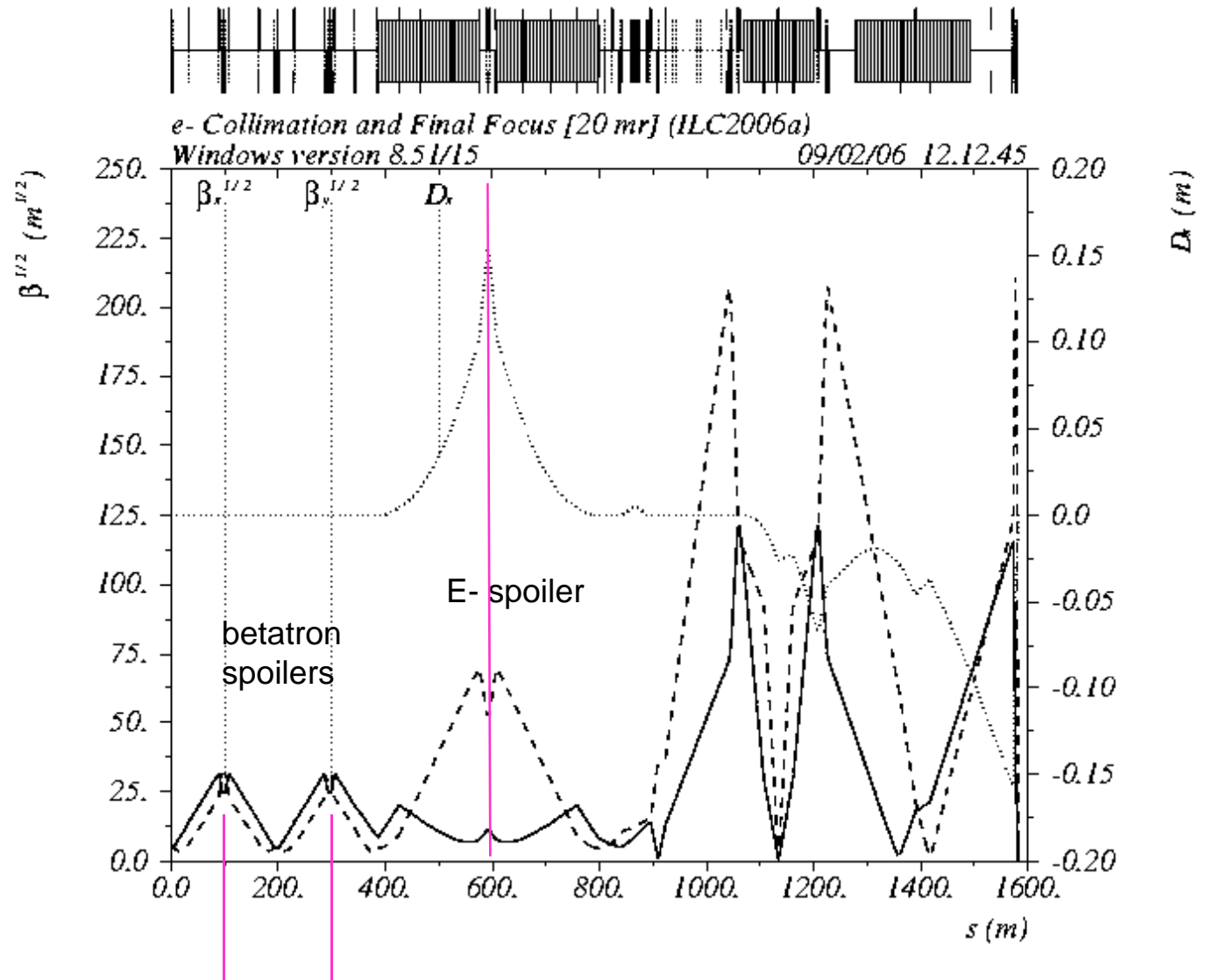

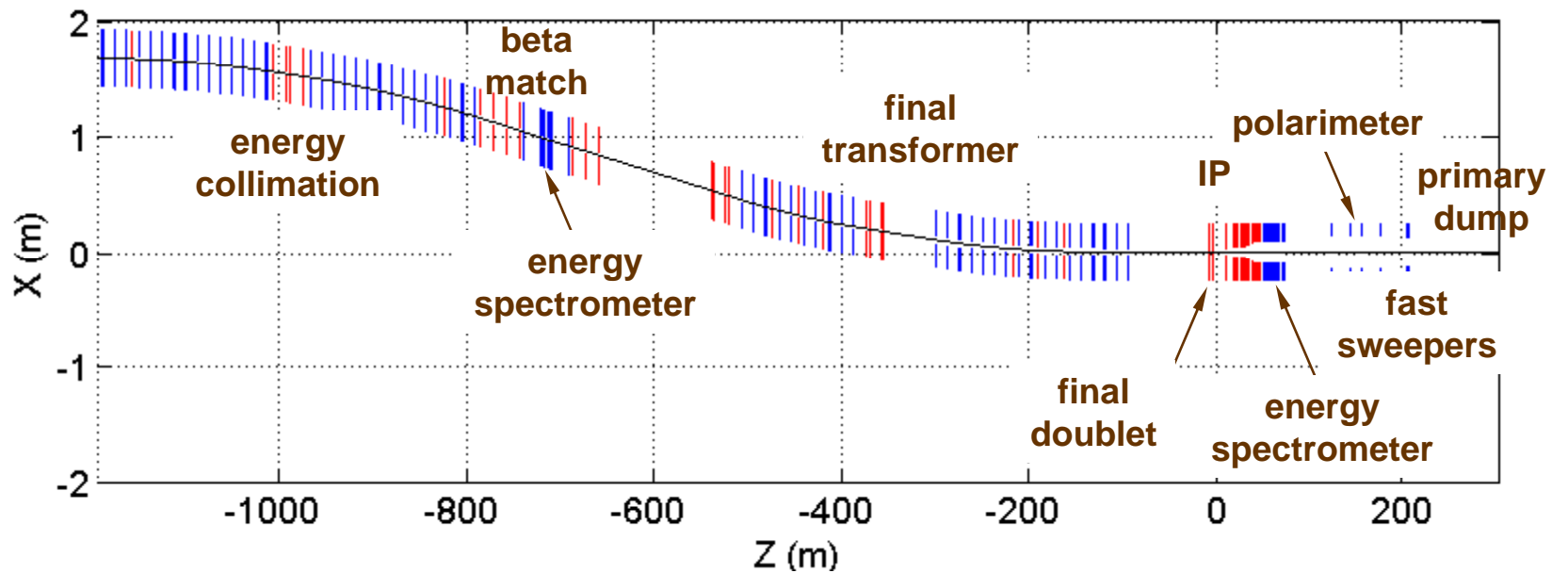
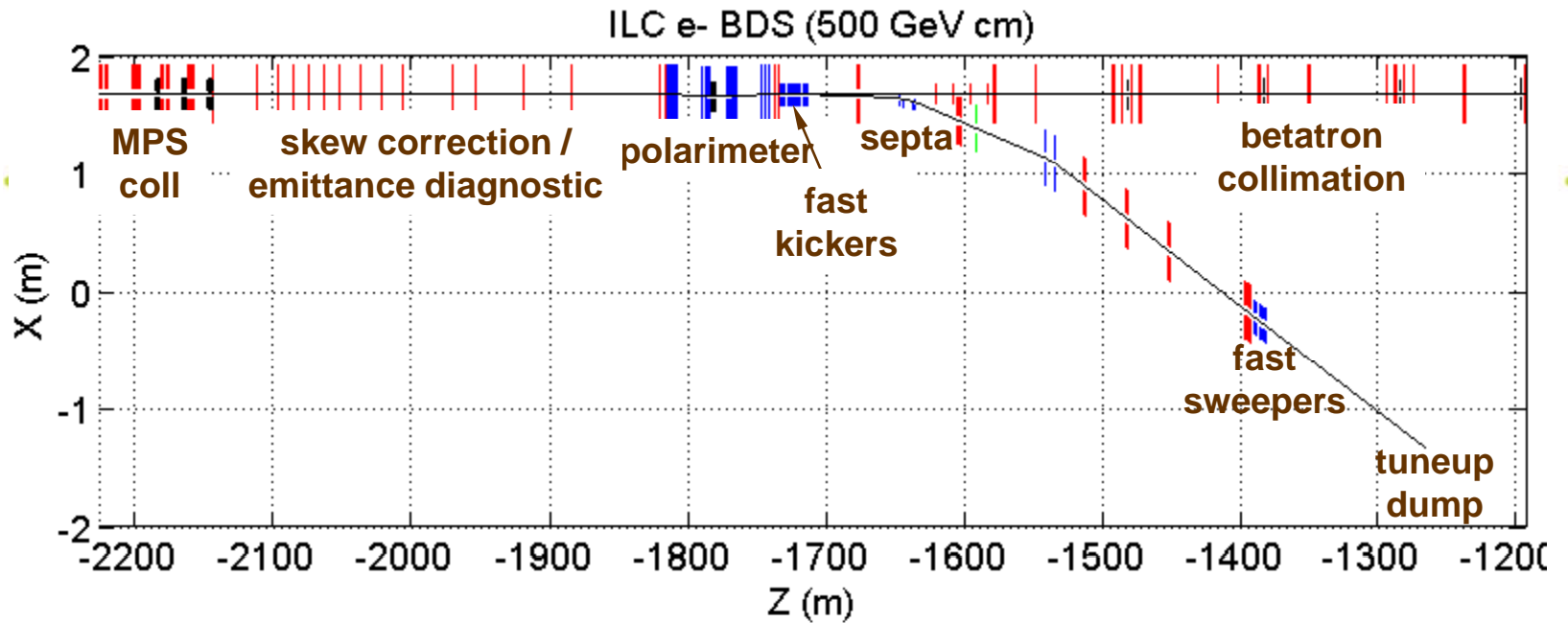



Collimation and nonlinear tail-folding

- Ameliorating incoming beam tails may relax the required collimation depth
 - Focus beam tails but not the core of the beam
=> use nonlinear elements
 - Several nonlinear elements needs to be combined to provide focusing in all directions
- Two octupoles of different sign separated by drift (Octupole Doublet) provide focusing in all directions for parallel beam
 - For this to work, the beam should have small angles, i.e. it should be parallel or diverging

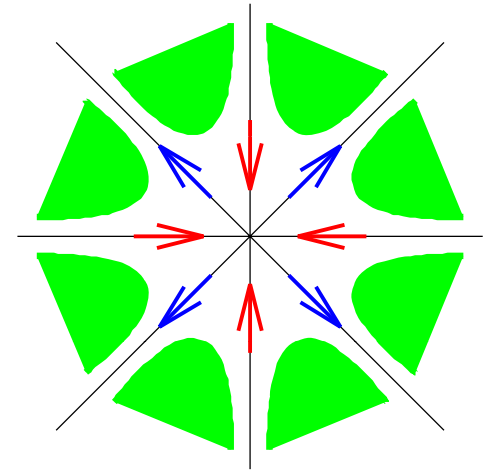

Single octupole focus in planes and defocus on diagonals.

An octupole doublet can focus in all directions => analogy with strong focusing by FODO



Tail folding in ILC FF

- Two octupole doublets give tail folding by ~ 4 times in terms of beam size in FD
- This allows opening β -collimation gaps by \sim a factor of 4

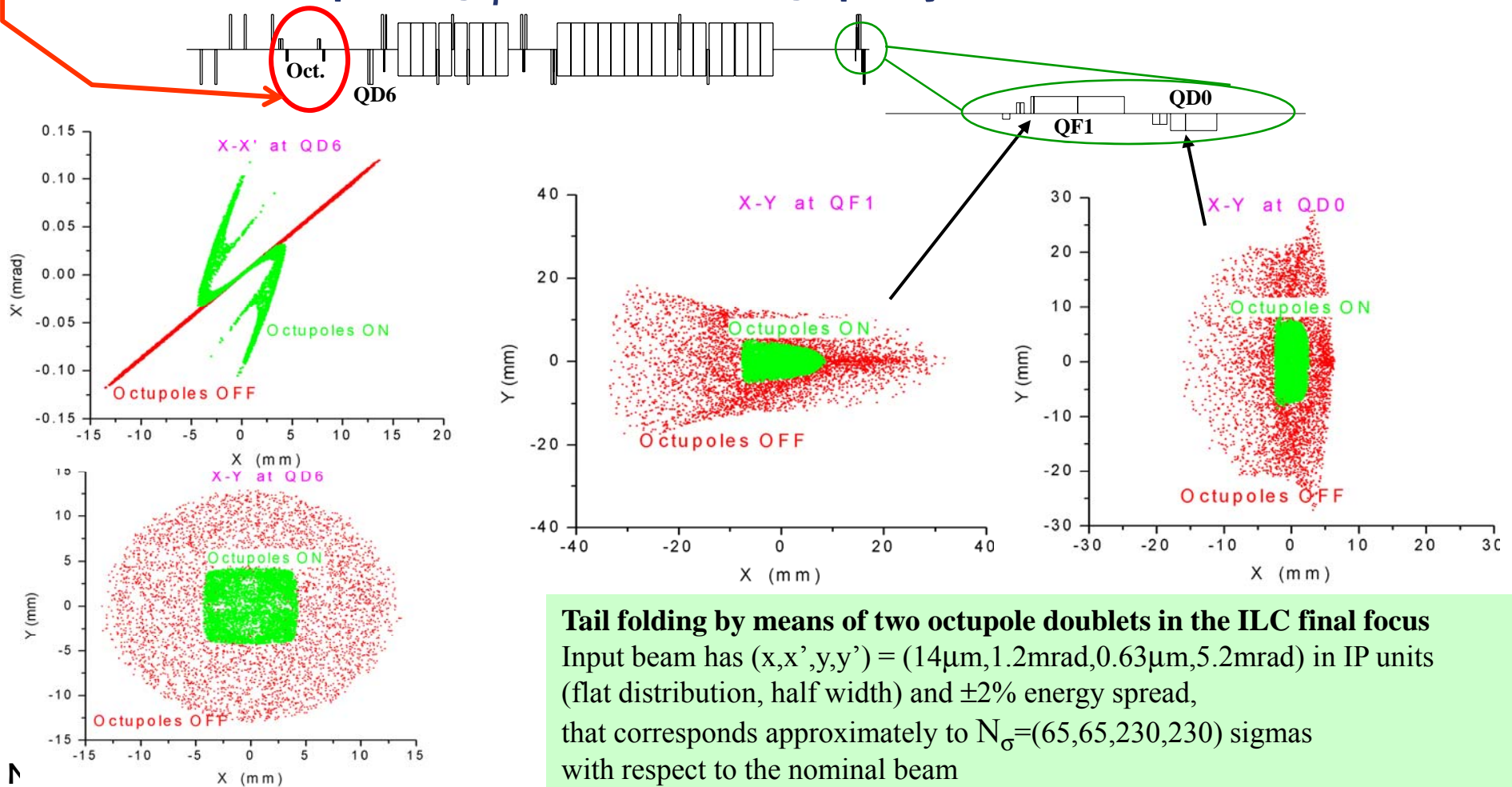



Muons in BDS

- Muons are produced during collimation
- Magnetized muon walls, installed ~300m from IP, may reduce muon background in the detectors to tolerable level even for 0.1% of collimated halo

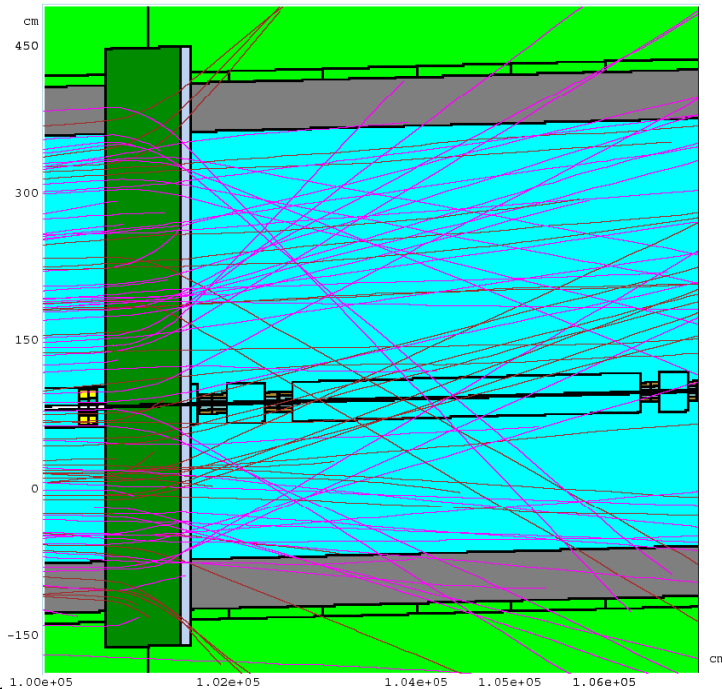
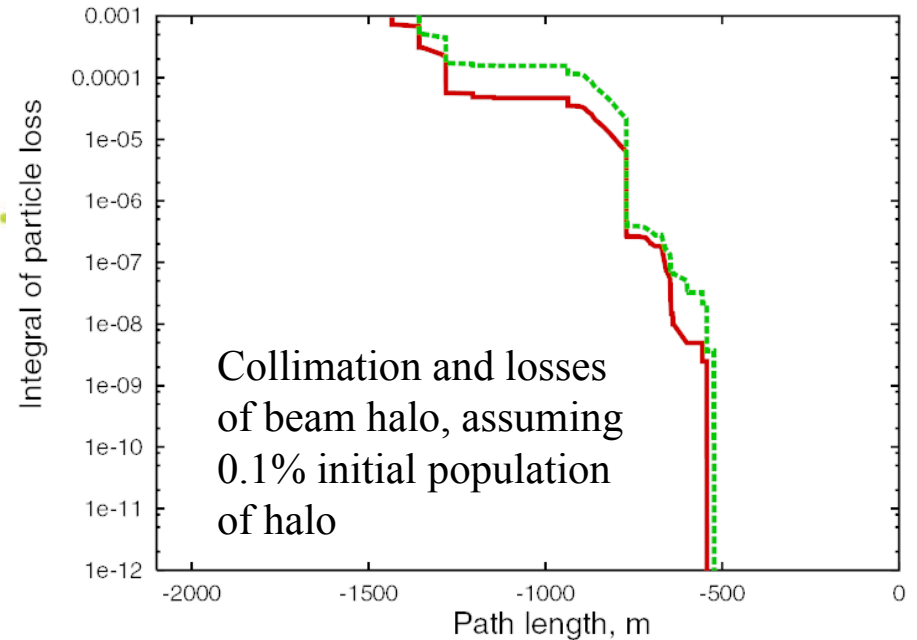

NB08, A.Seryi,

Magnetized muon wall

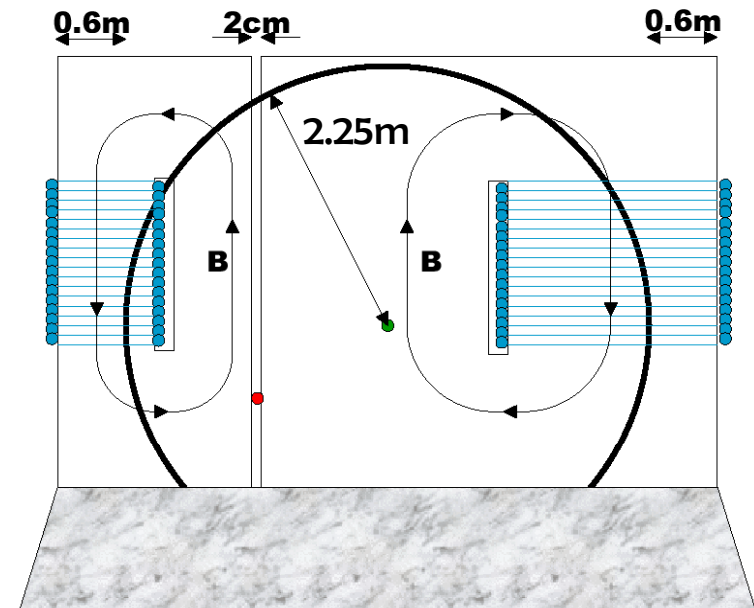



Crab crossing

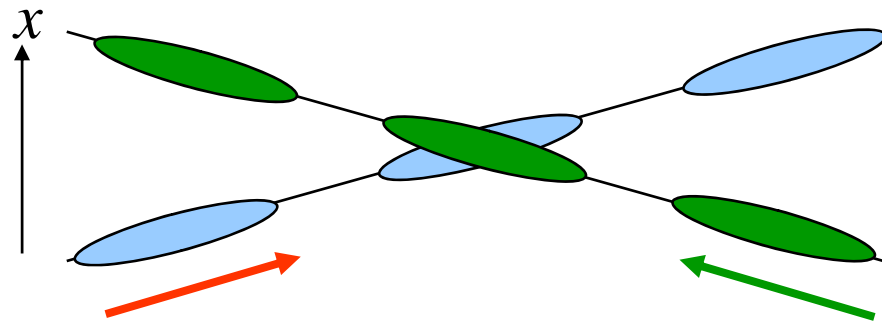

With crossing angle θ_c , the projected x-size is $(\sigma_x^2 + \theta_c^2 \sigma_z^2)^{0.5} \sim \theta_c \sigma_z \sim 4\mu\text{m}$

→ several time reduction in L without corrections

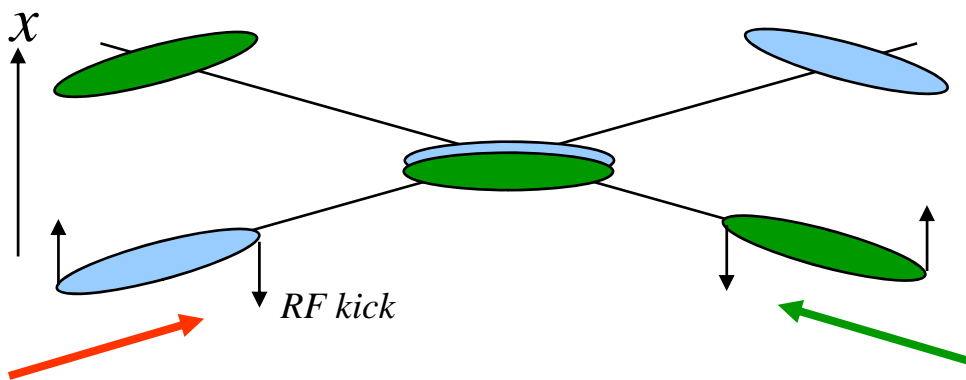

Use transverse (crab) RF cavity to 'tilt' the bunch at IP

TM110 Dipole mode cavity

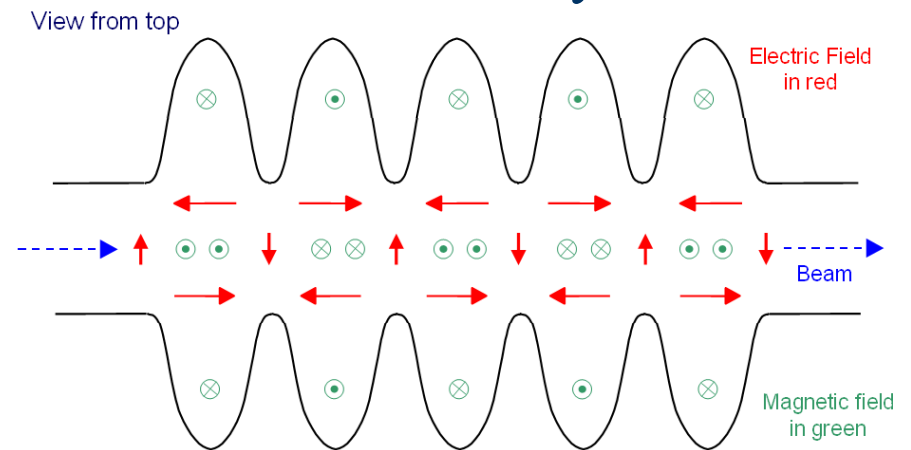

For a crab cavity the bunch centre is at the cell centre when E is maximum and B is zero



Crab cavity design

- Based on FNAL design of 3.9GHz CKM deflecting cavity
- Challenges are damping of parasitic modes, tight phase stability, integration into IR

Crossing angle	14 mrad
Number of cryovessels per IP	2
Number of 9-cell cavities per cryovessel	2
Required bunch rotation, mrad	7
Location of crab cavities from the corresponding IP, m	13.4 – 17.4
Longitudinal space allocated per cryovessel, m	3.8
RMS Relative Phase Stability, deg	0.095
RMS Beam Energy Jitter, %	0.33
X offset at IP due to crab cavity angle (R12), m/rad	16.3
Y offset at IP due to crab cavity angle (R12), m/rad	2.4
Amplitude at 1TeV CM, MV	2.64
Max amplitude with operational margin, MV	4.1

UK-FNAL-SLAC crab-cavity collaboration



FNAL 3.9GHz transverse cavity achieved 7.5 MV/m



Crab Cavity design

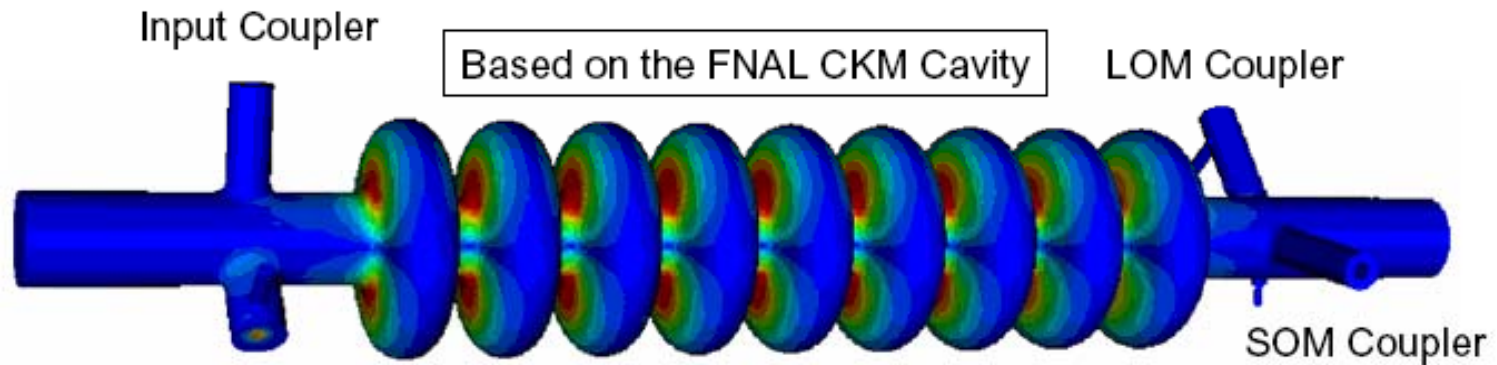

HOM Coupler

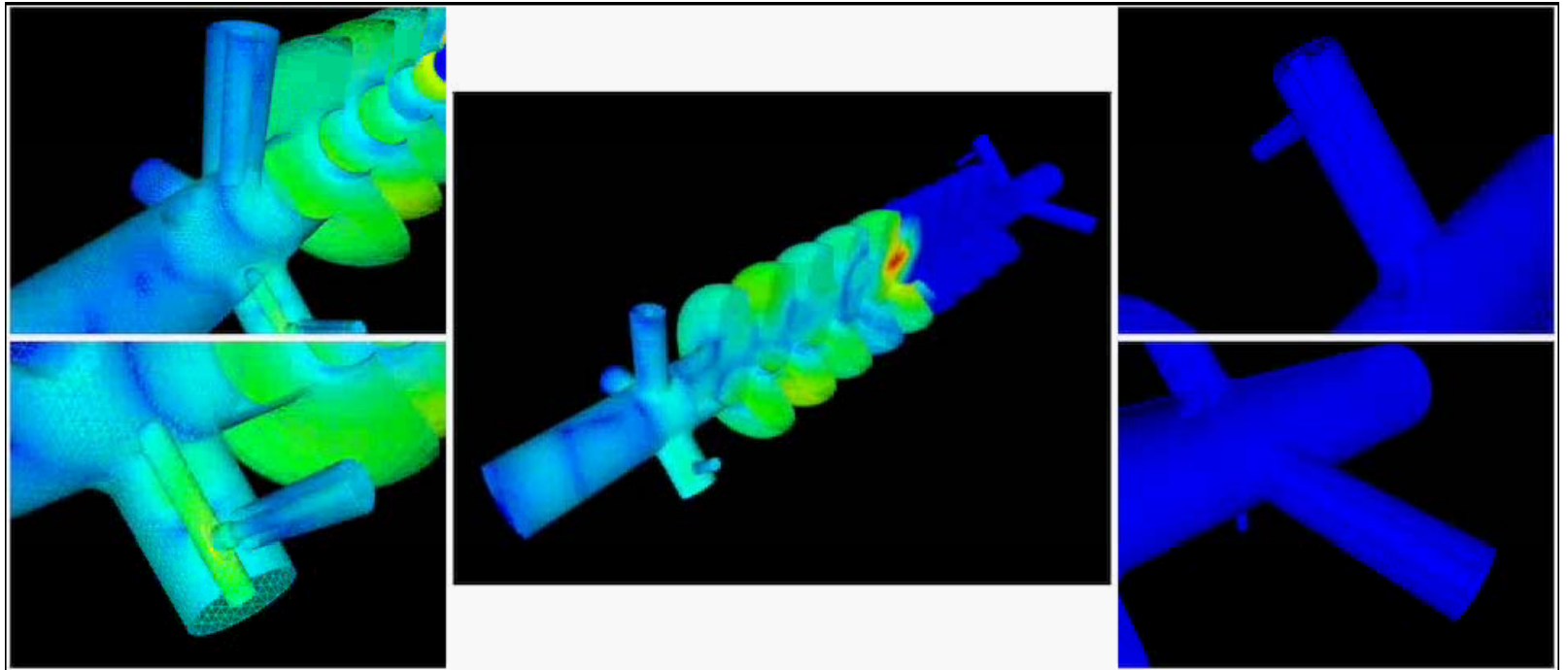



3.9 GHz cavities fabricated and tested at Nlowave Aug 07.

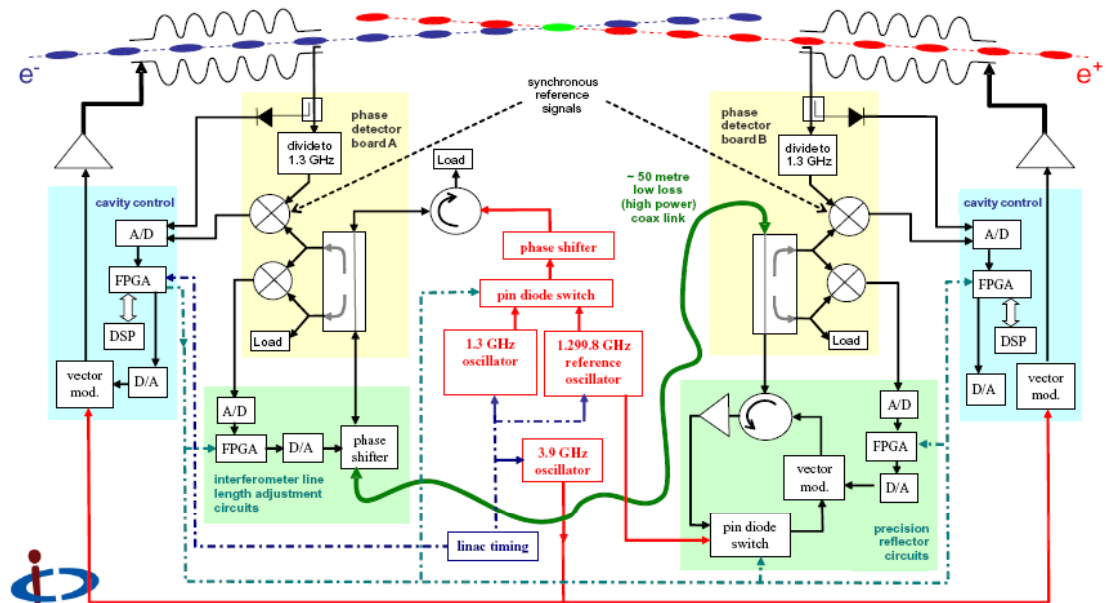
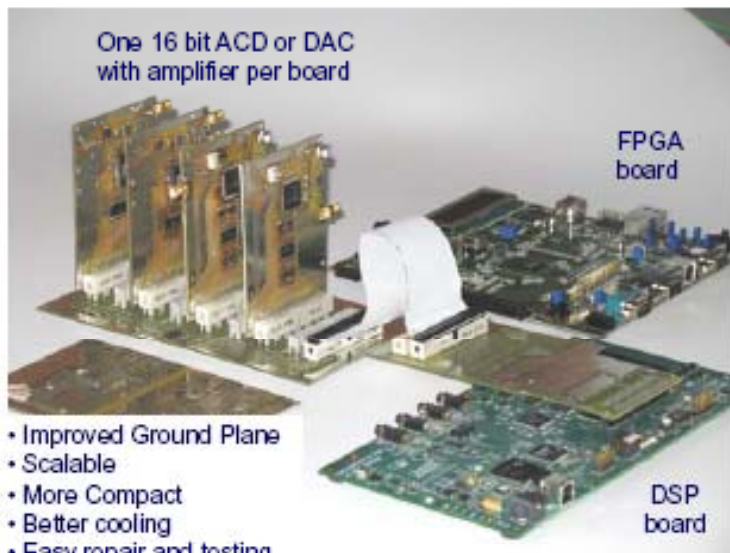

Accelerator Science and Technology Centre

NB08, A.Seryi, Mc Peter McIntosh et al

BDS: 29

IR coupling compensation

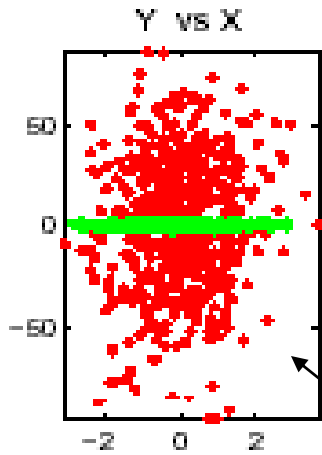

without compensation
 $\sigma_y / \sigma_y(0) = 32$

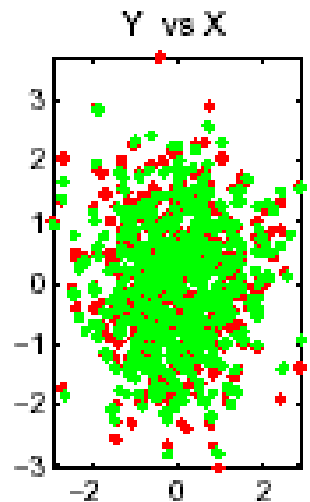

with compensation by antisolenoid
 $\sigma_y / \sigma_y(0) < 1.01$

When detector solenoid overlaps QD0, coupling between y & x' and y & E causes large (30 – 190 times) increase of IP size (green=detector solenoid OFF, red=ON)

Even though traditional use of skew quads could reduce the effect, the local compensation of the fringe field (with a little skew tuning) is the most efficient way to ensure correction over wide range of beam energies

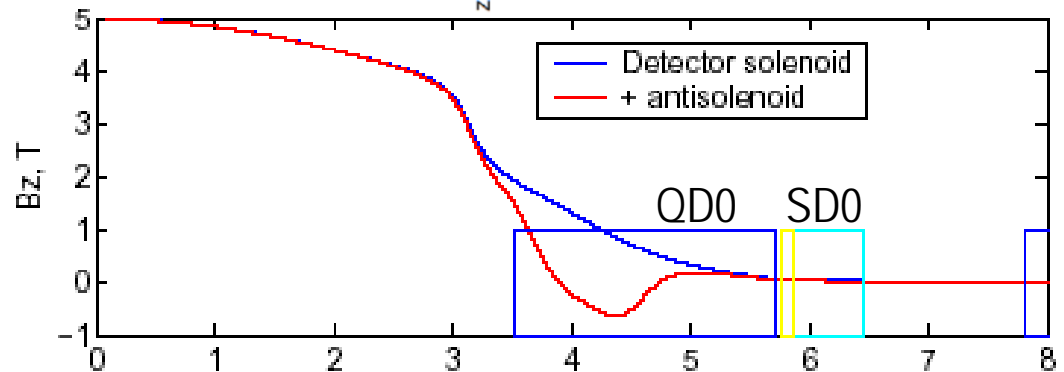
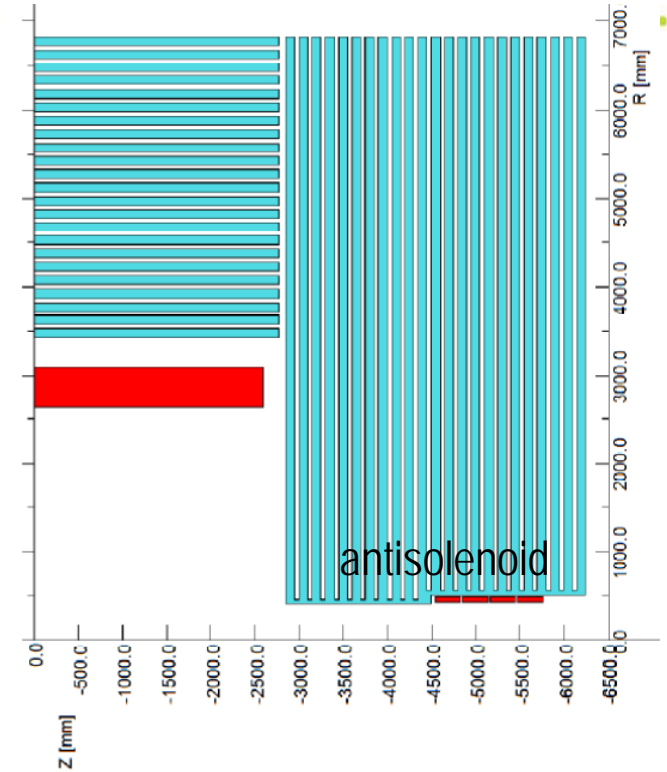

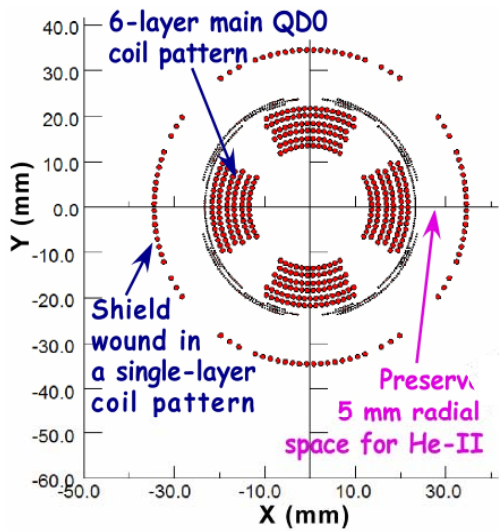

14mr IR



BNL

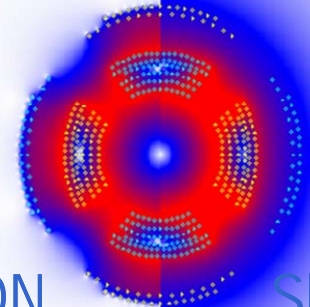

Shield ON

Shield OFF

Intensity of color represents value of magnetic field.

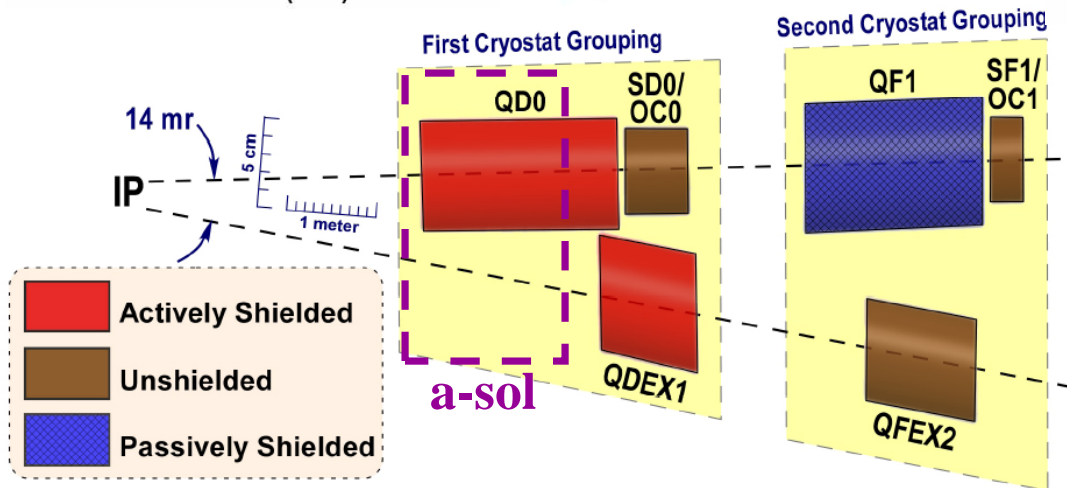

Two Coils; Different Radii
new force neutral antisolenoid

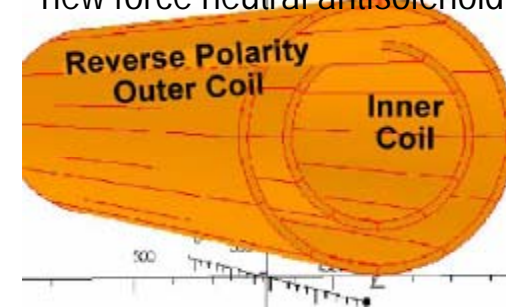

- Interaction region uses compact self-shielding SC magnets
- Independent adjustment of in- & out-going beamlines
- Force-neutral anti-solenoid for local coupling correction

ilc
IR magnets
prototypes at
BNL

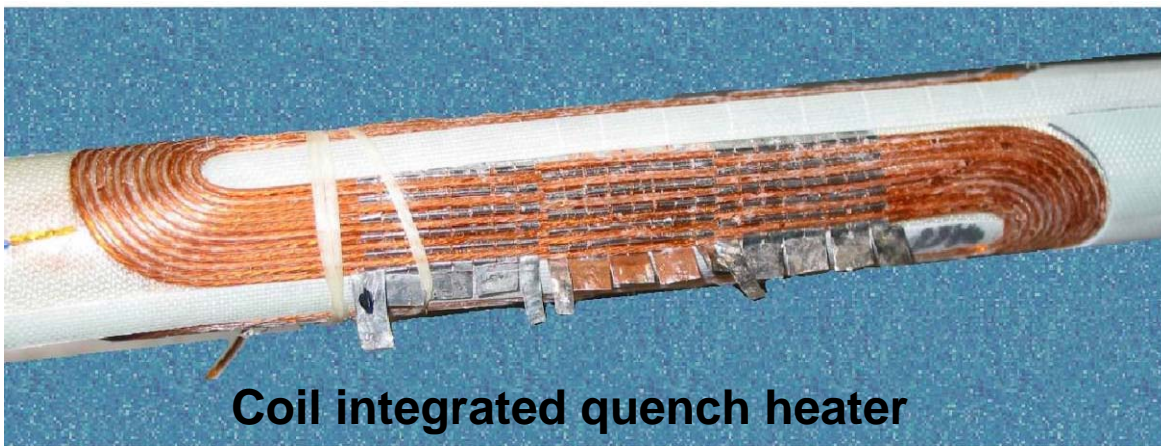



SC final double & its cryo system

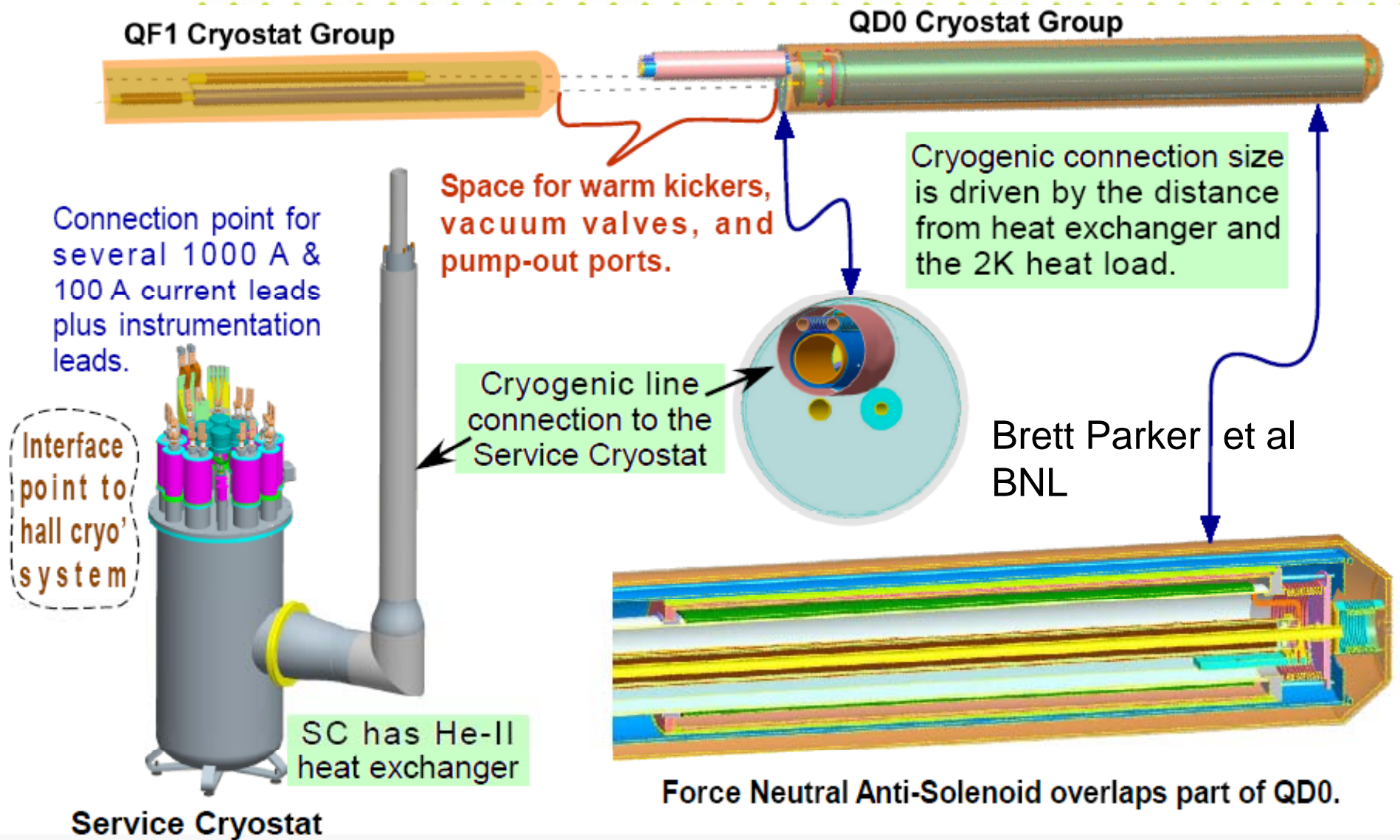



Detector Integrated Dipole

- With a crossing angle, when beams cross solenoid field, vertical orbit arise
- For e^+e^- the orbit is anti-symmetrical and beams still collide head-on
- If the vertical angle is undesirable (to preserve spin orientation or the e^-e^- luminosity), it can be compensated locally with DID
- Alternatively, negative polarity of DID may be useful to reduce angular spread of beam-beam pairs (anti-DID)

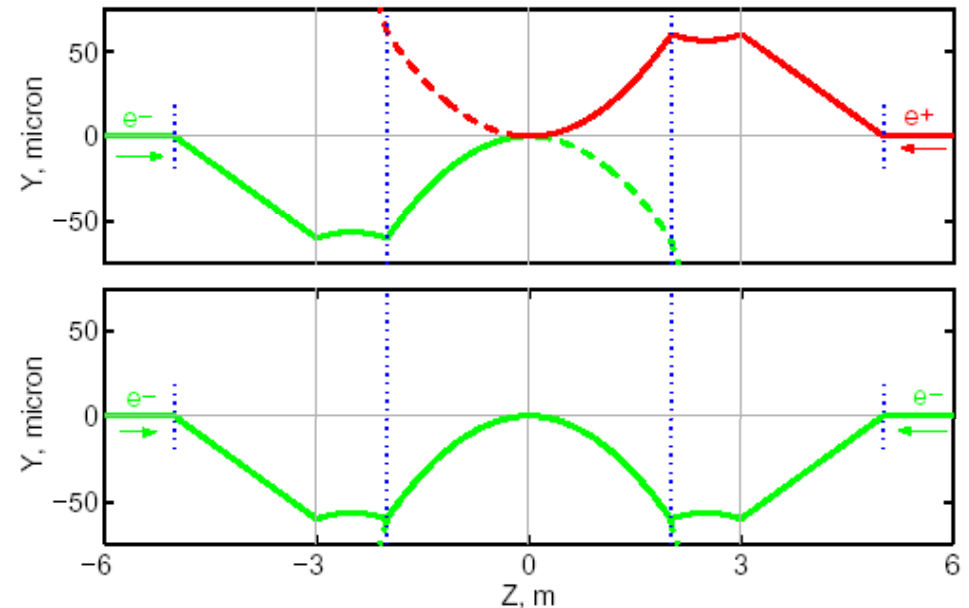
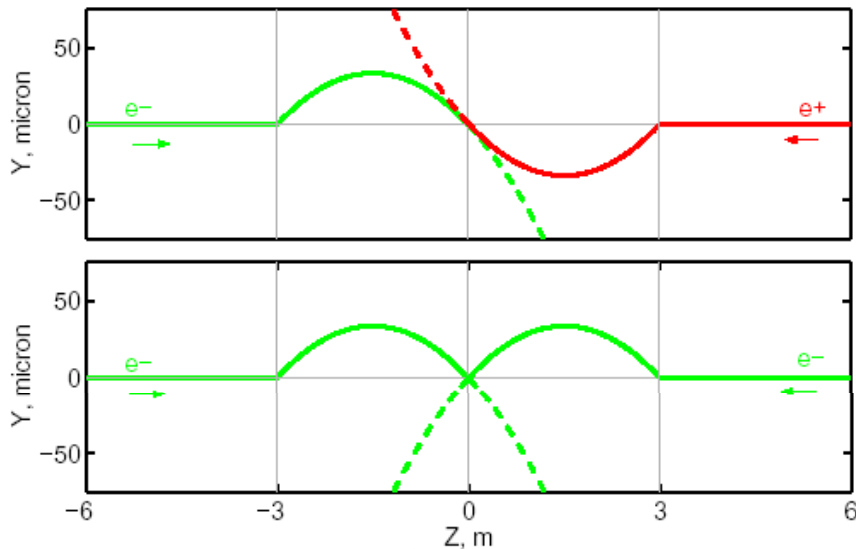
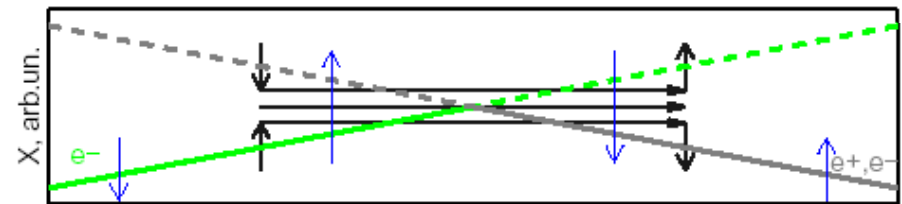

Use of DID or anti-DID

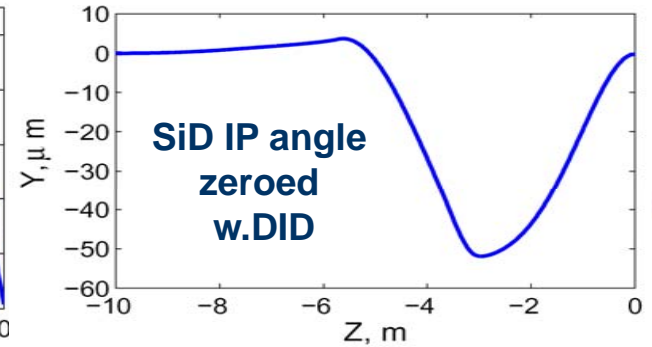
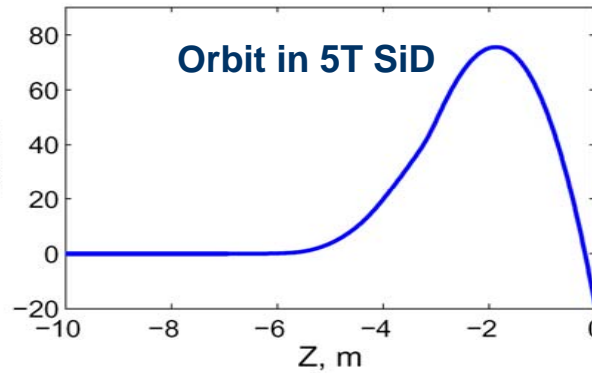

DID field shape and scheme

DID case

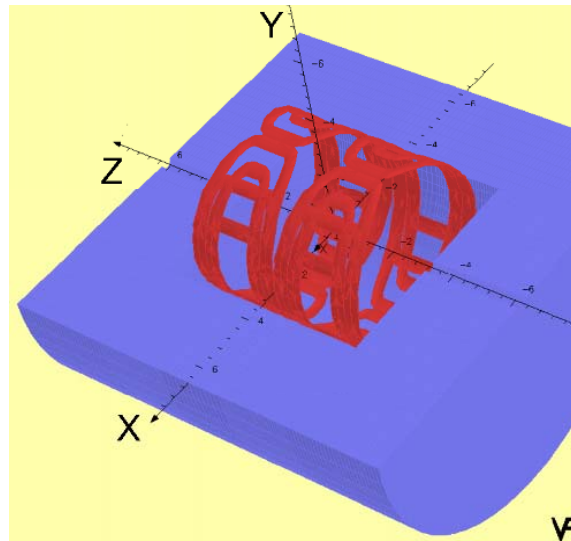
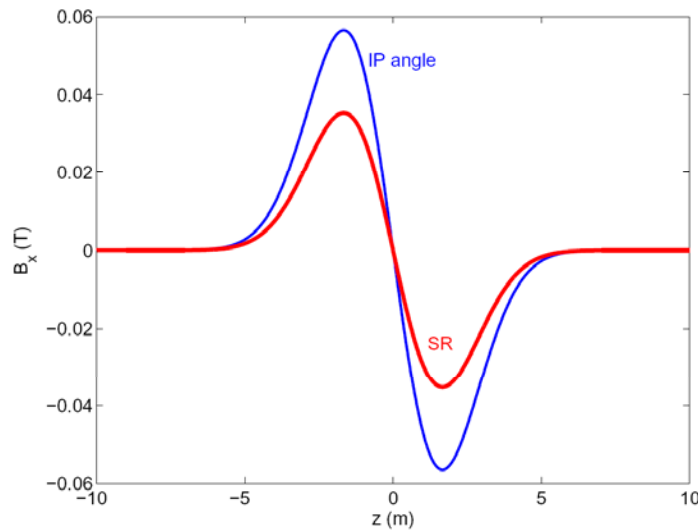

- The negative polarity of DID is also possible (called anti-DID)
- In this case the vertical angle at the IP is somewhat increased, but the background conditions due to low energy pairs (see below) and are improved

ILC e^+e^- pairs in detector solenoid

- Beamstrahlung photons, particles of beams or virtual photons interact, and create e^+e^- pairs
- e^+e^- pairs affected by the beam (de) focusing field
- Deflection angle and P_t correlate
- Pairs are curled by the solenoid field of detector
- Pairs trajectories define geometry of vertex detector and IR vacuum chamber

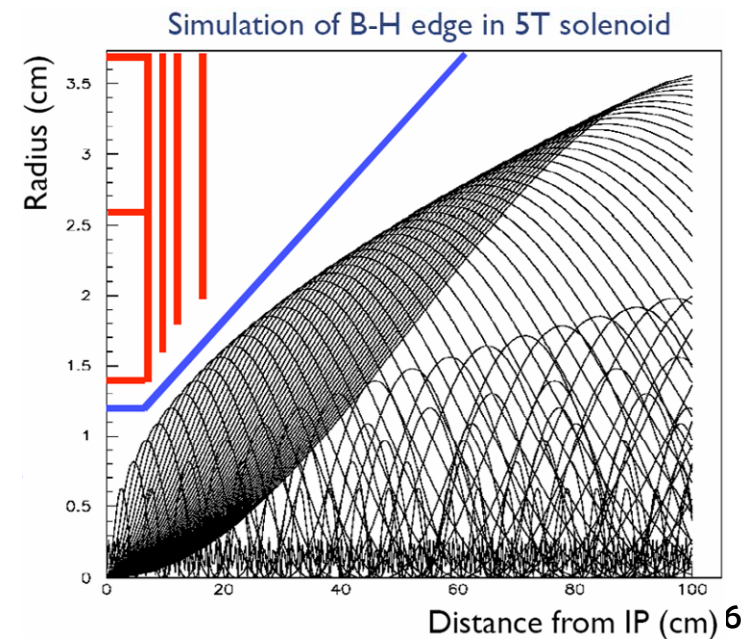
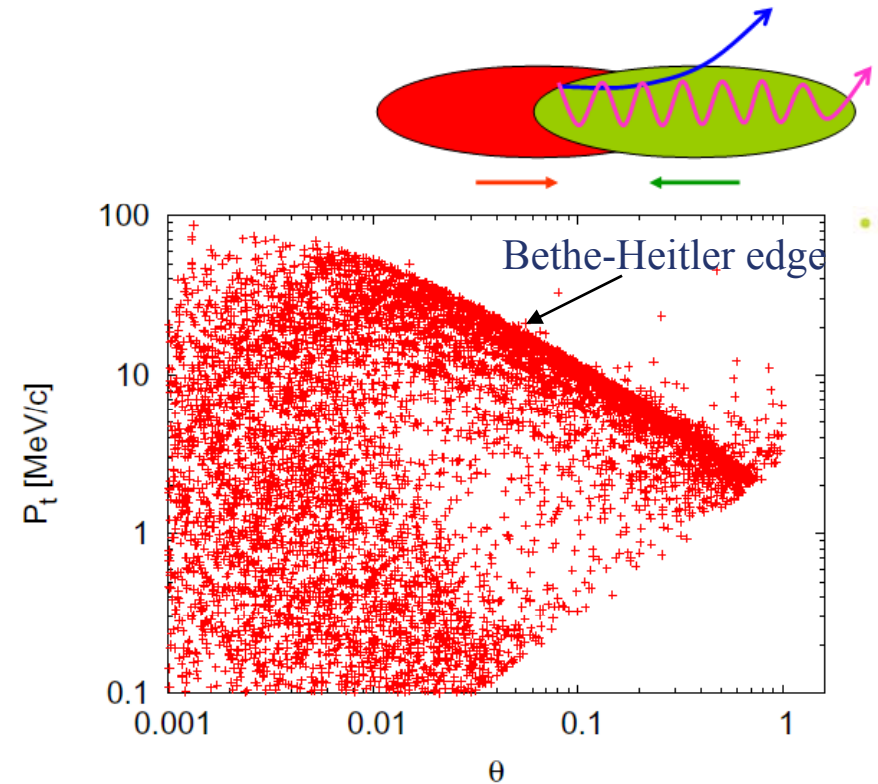



Use of anti-DID to direct pairs

Anti-DID field can direct most of pairs into extraction line, improving background conditions

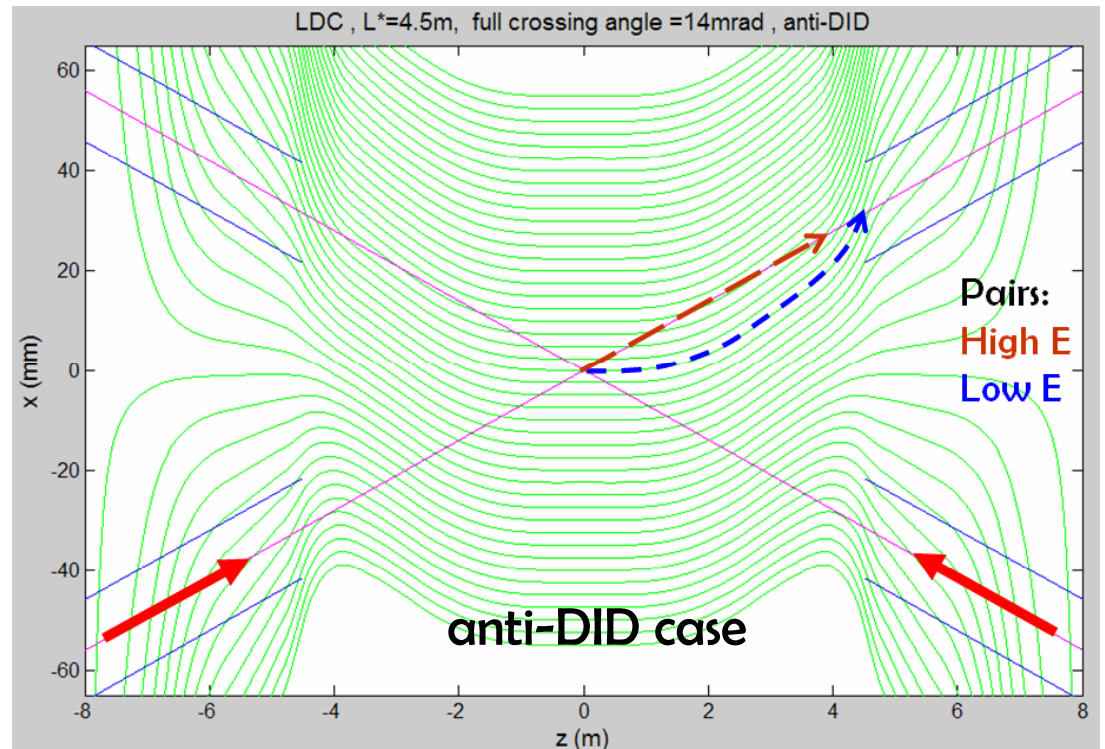
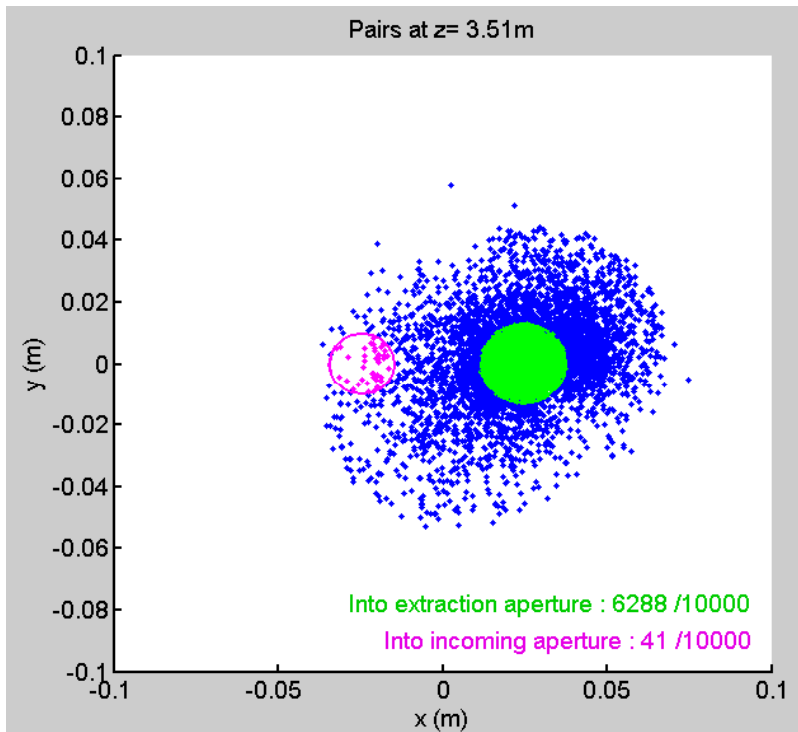
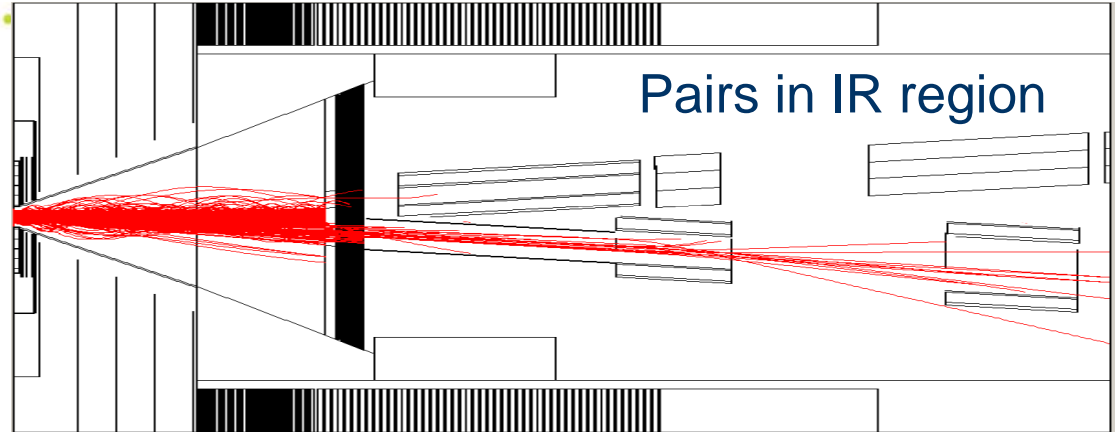



Optics for outgoing beam

IP

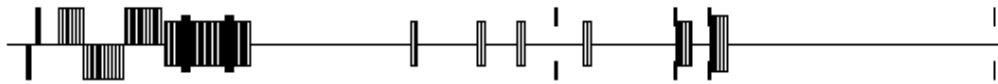

Disrupted beta and dispersion in the extraction line.

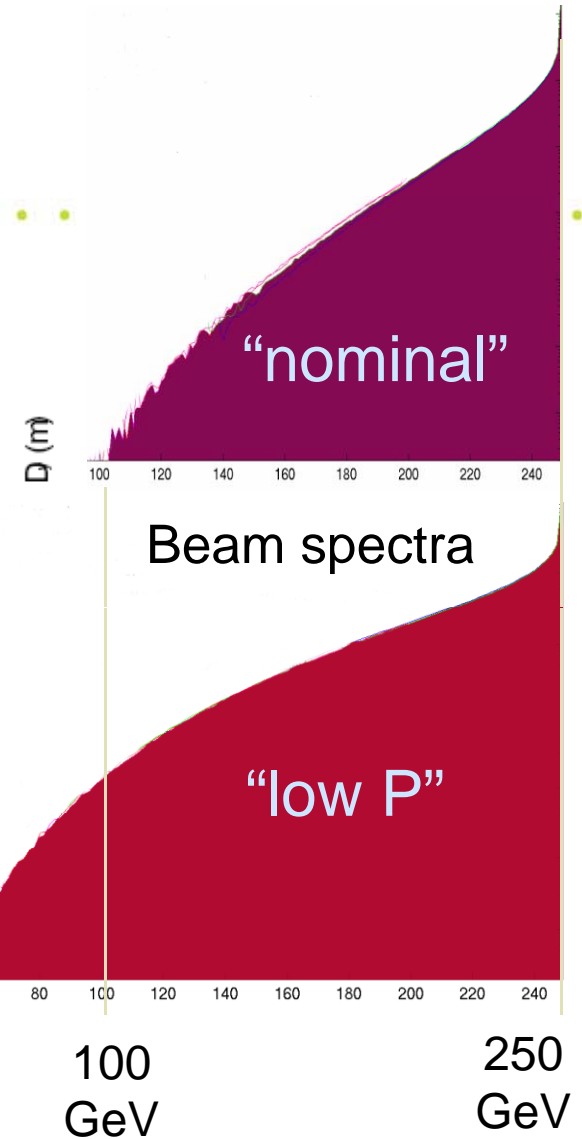
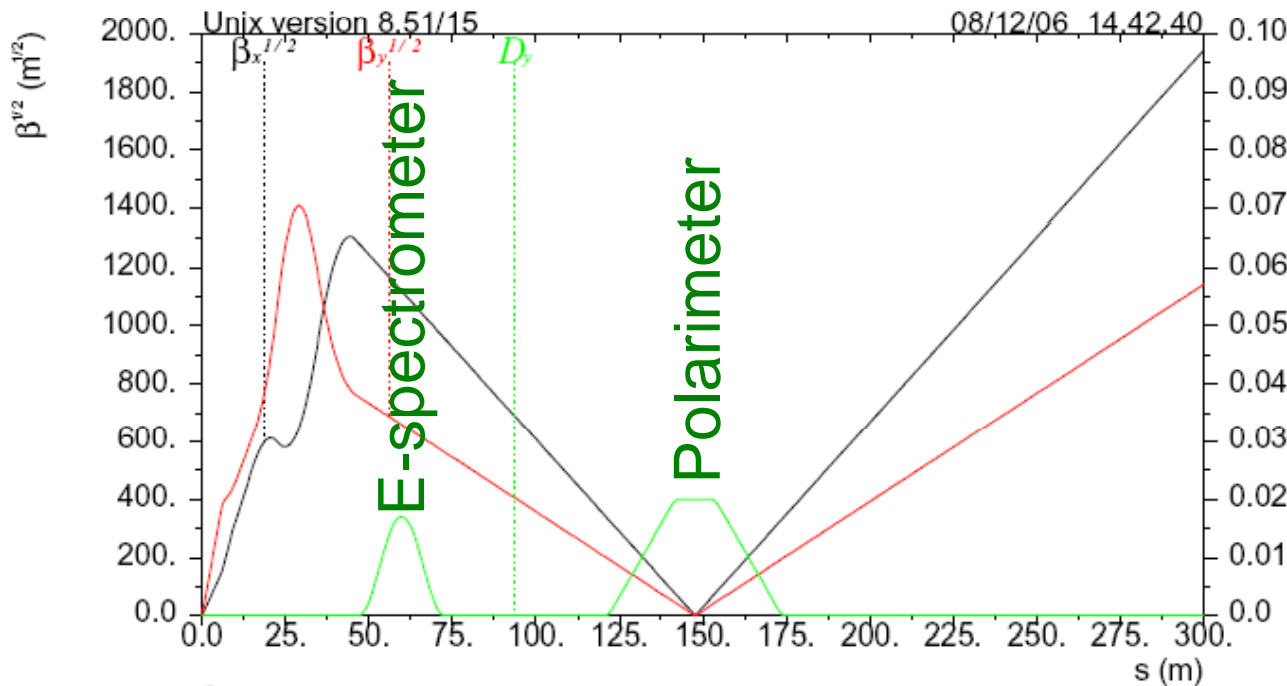

Extraction optics need to handle the beam with ~60% energy spread, and provides energy and polarization diagnostics

ilc Beam dump

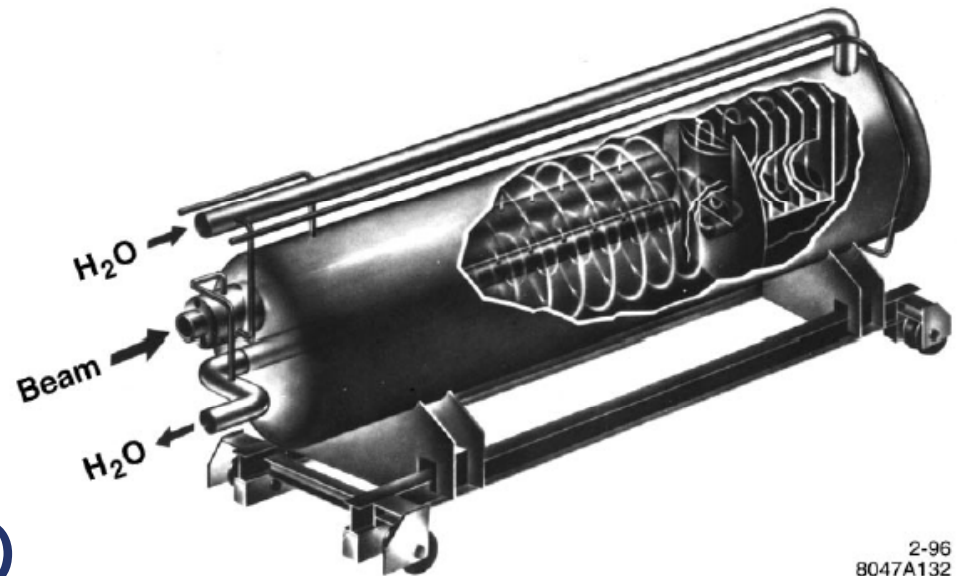

2-96
8047A132

- 17MW power (for 1TeV CM)
- Rastering of the beam on 30cm double window
- 6.5m water vessel; ~1m/s flow
- 10atm pressure to prevent boiling
- Three loop water system
- Catalytic H_2-O_2 recombiner
- Filters for $7Be$
- Shielding 0.5m Fe & 1.5m concrete

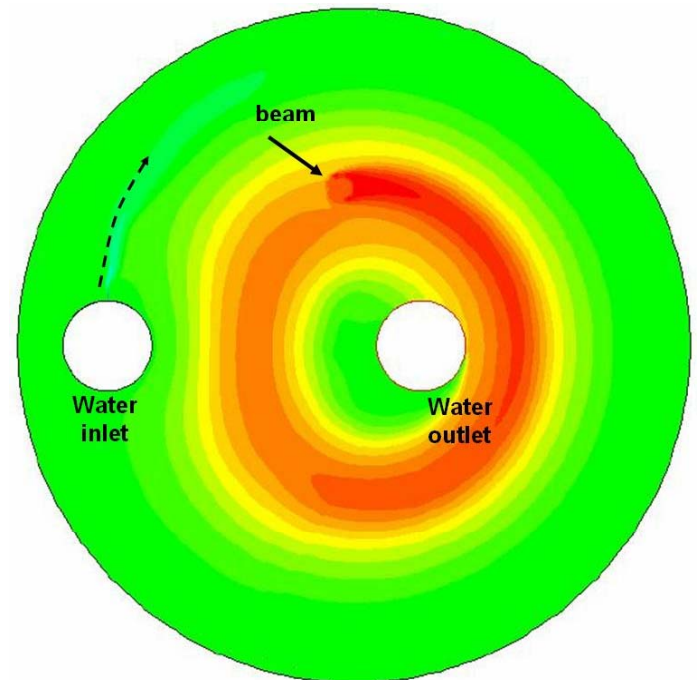



Concept of single IR with two detectors

may be accessible during run

The concept is evolving and details being worked out

accessible during run

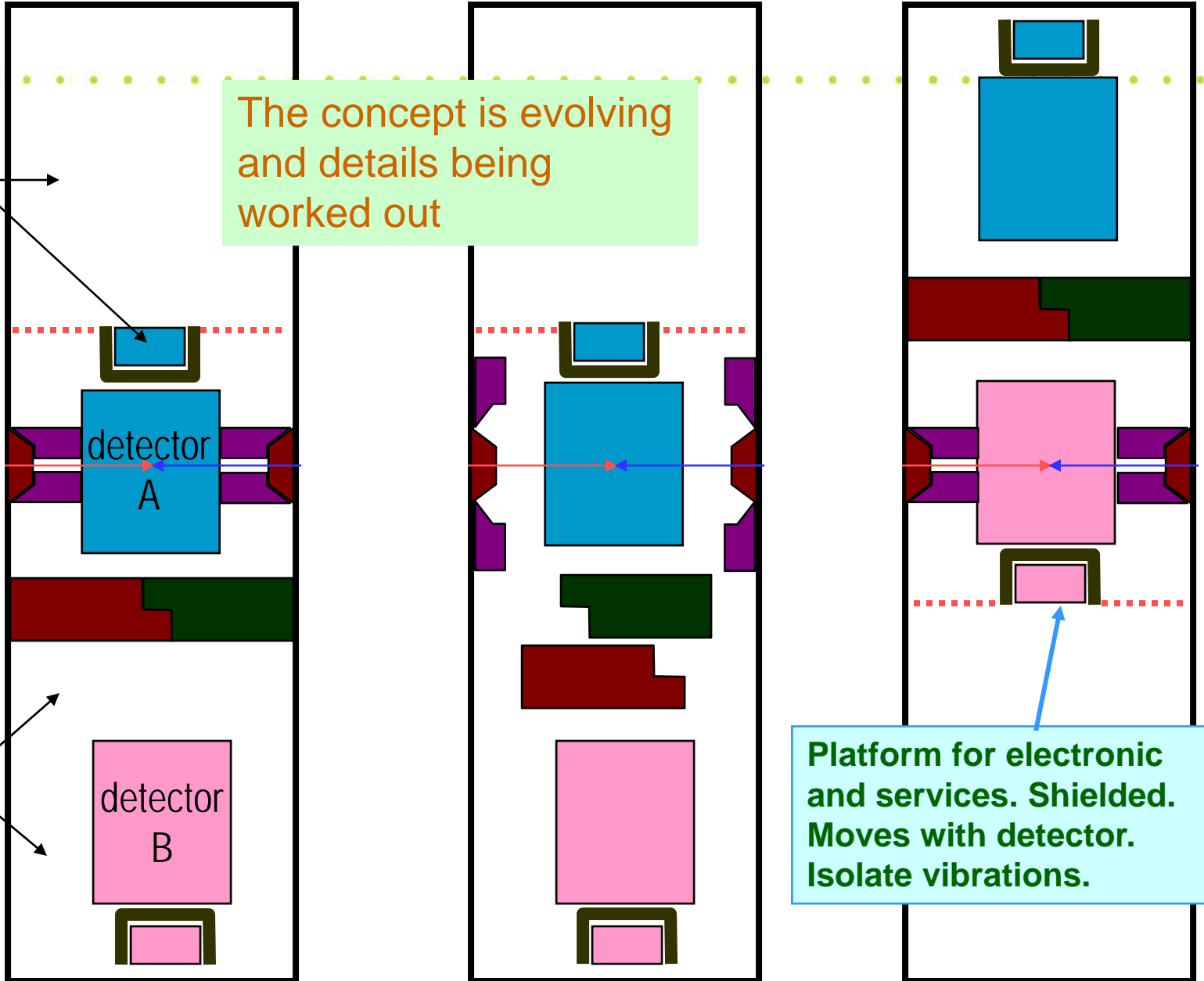

Platform for electronic and services. Shielded. Moves with detector. Isolate vibrations.



Concept of detector systems connections

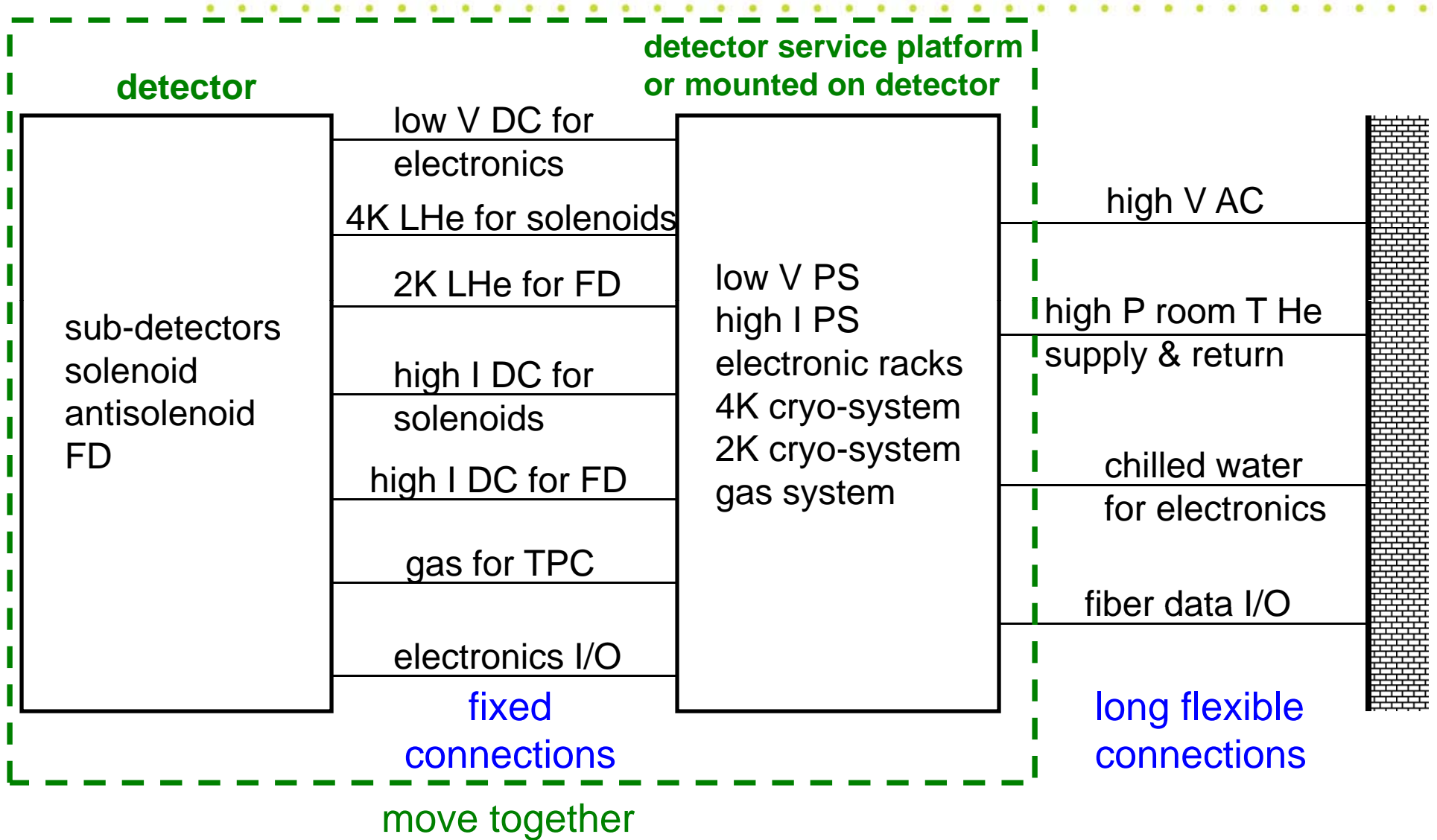



IR integration

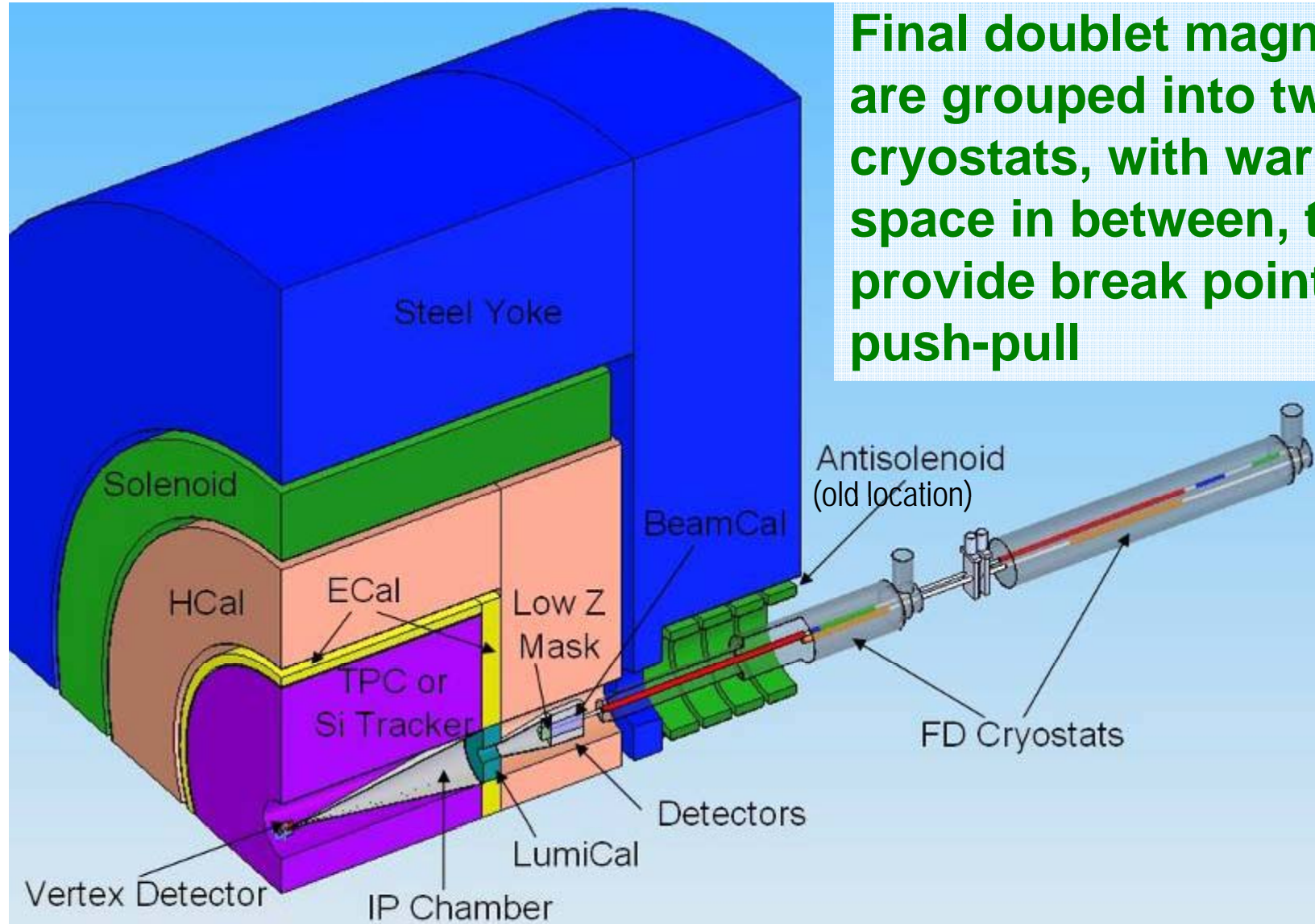

Final doublet magnets are grouped into two cryostats, with warm space in between, to provide break point for push-pull



Present concept of cryo connection



Vertical Layout for the Service Cryostat to QD0 Cryostat Transfer Line.

BROOKHAVEN NATIONAL LABORATORY
Superconducting Magnet Division

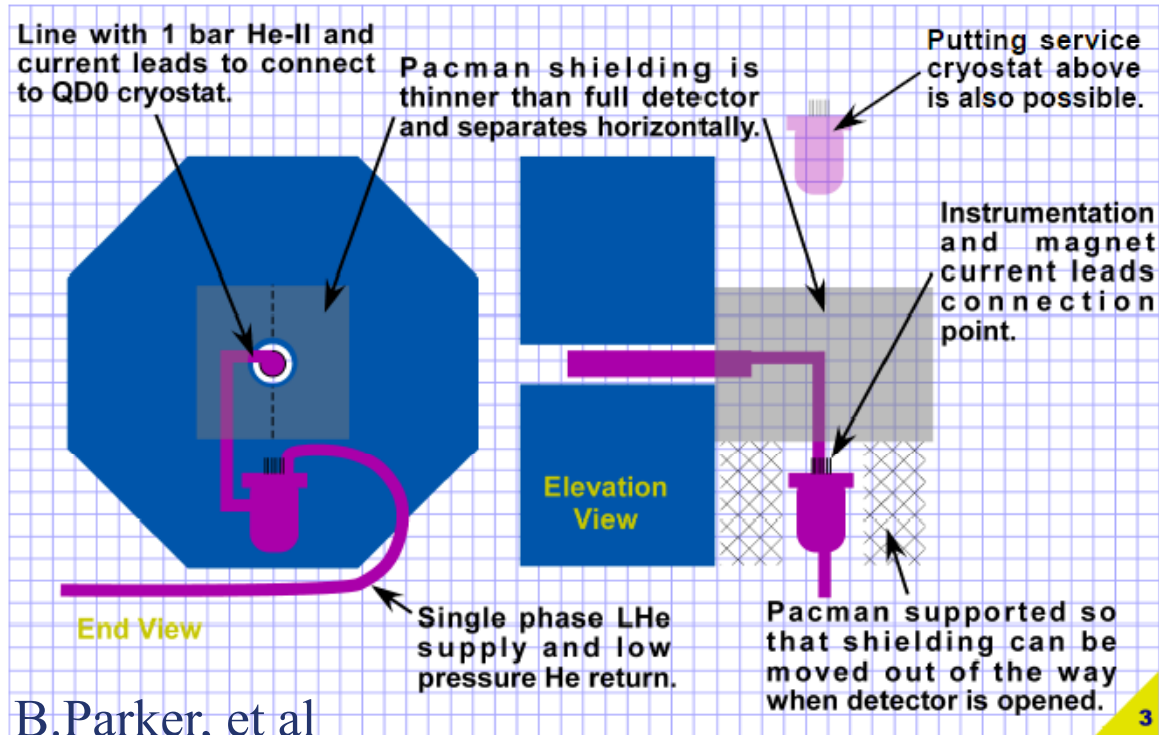

B.Parker, et al

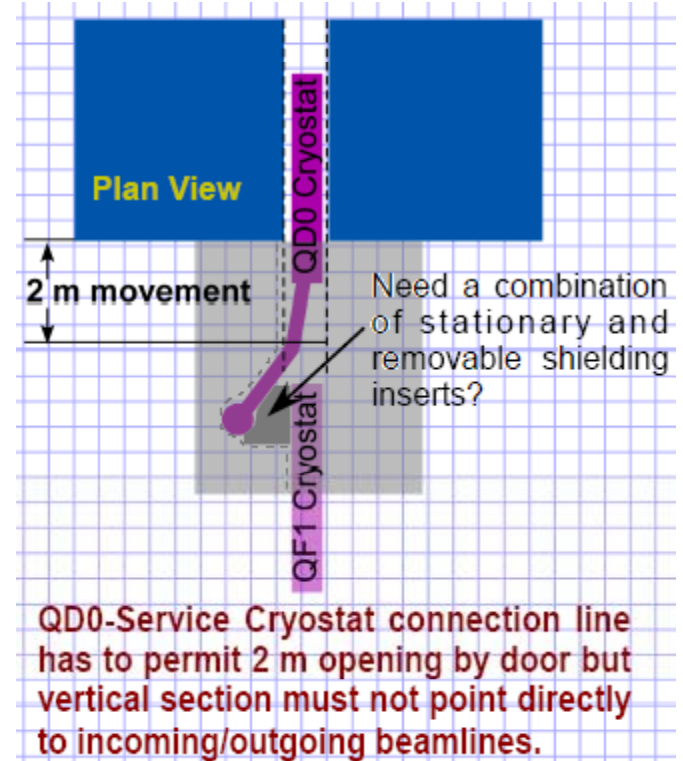



Moving the detector

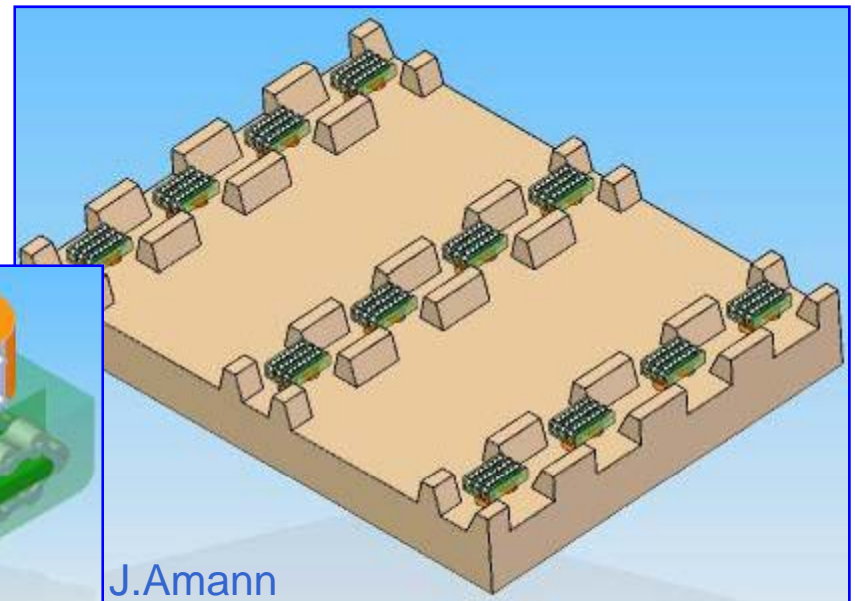
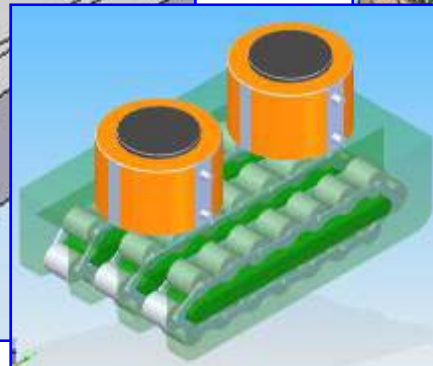
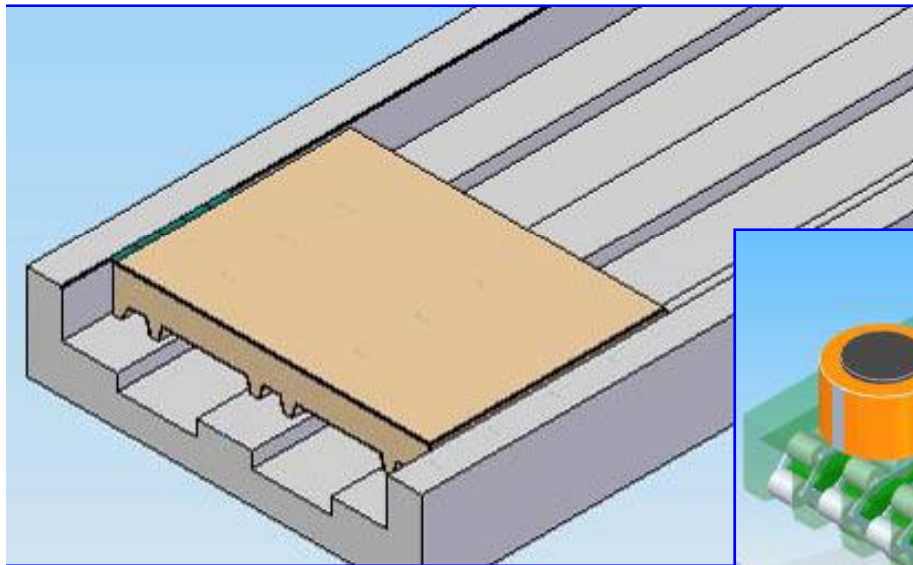
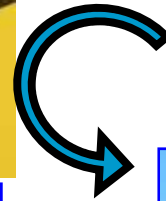
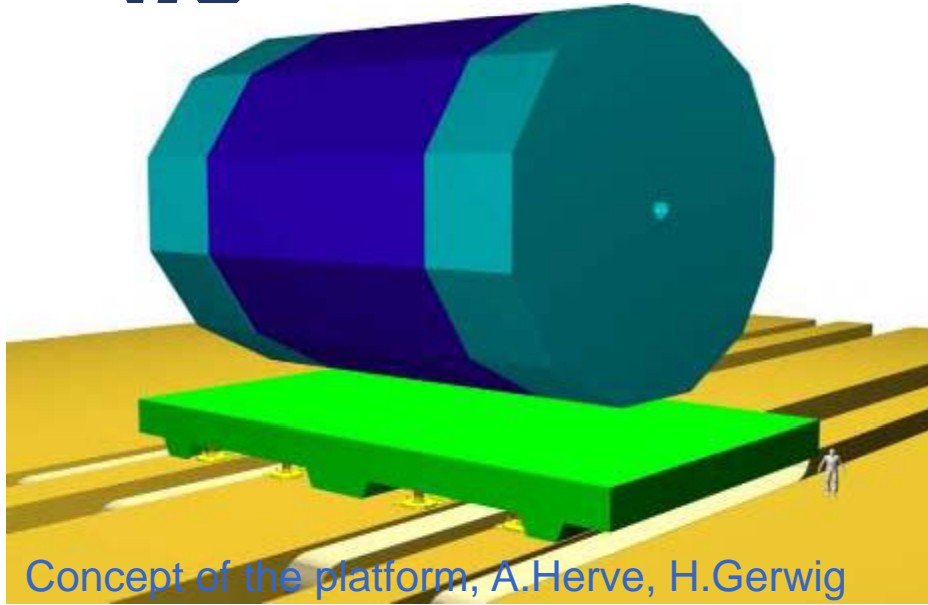



Push-Pull studies for two detectors

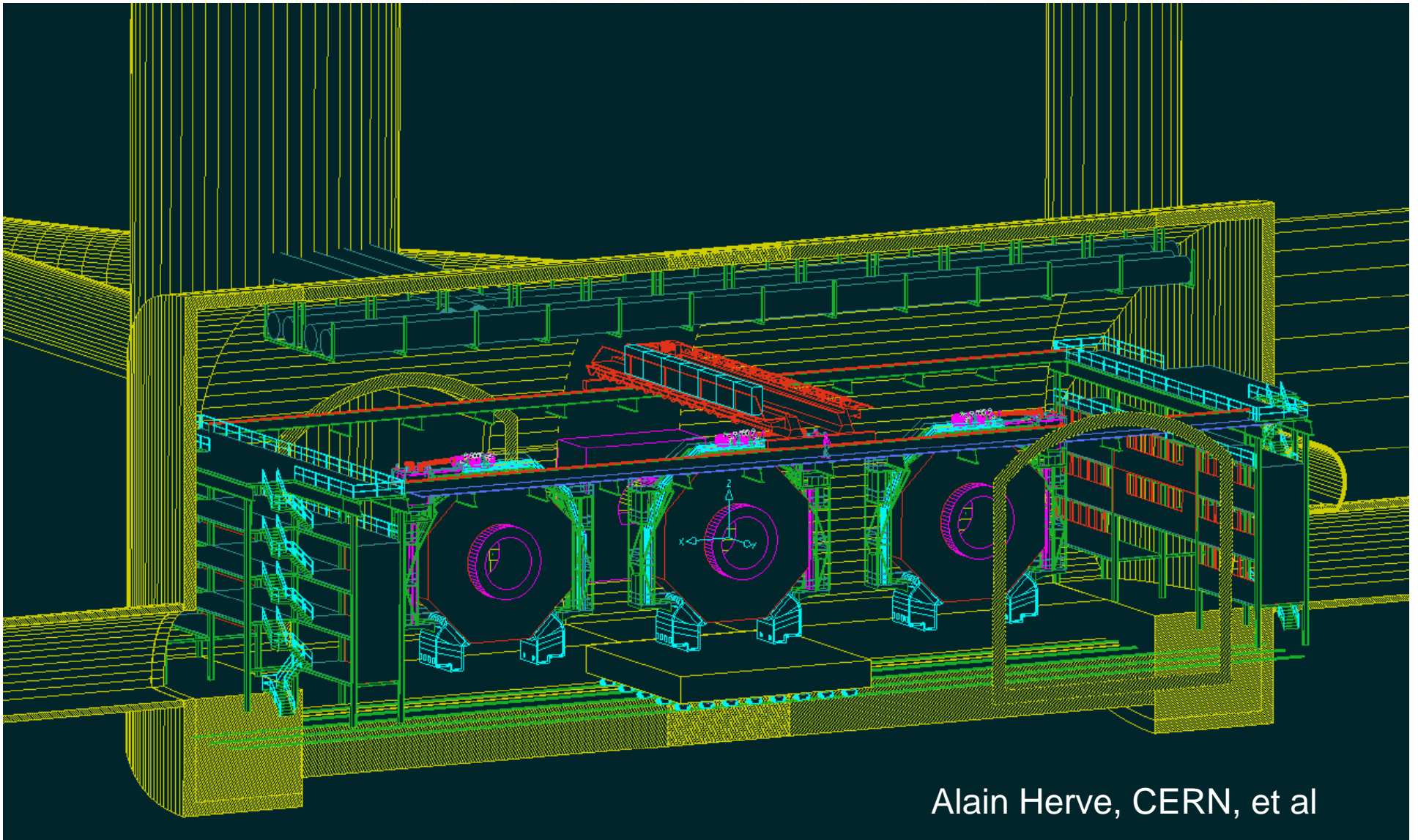

Alain Herve, CERN, et al



Shielding the IR hall

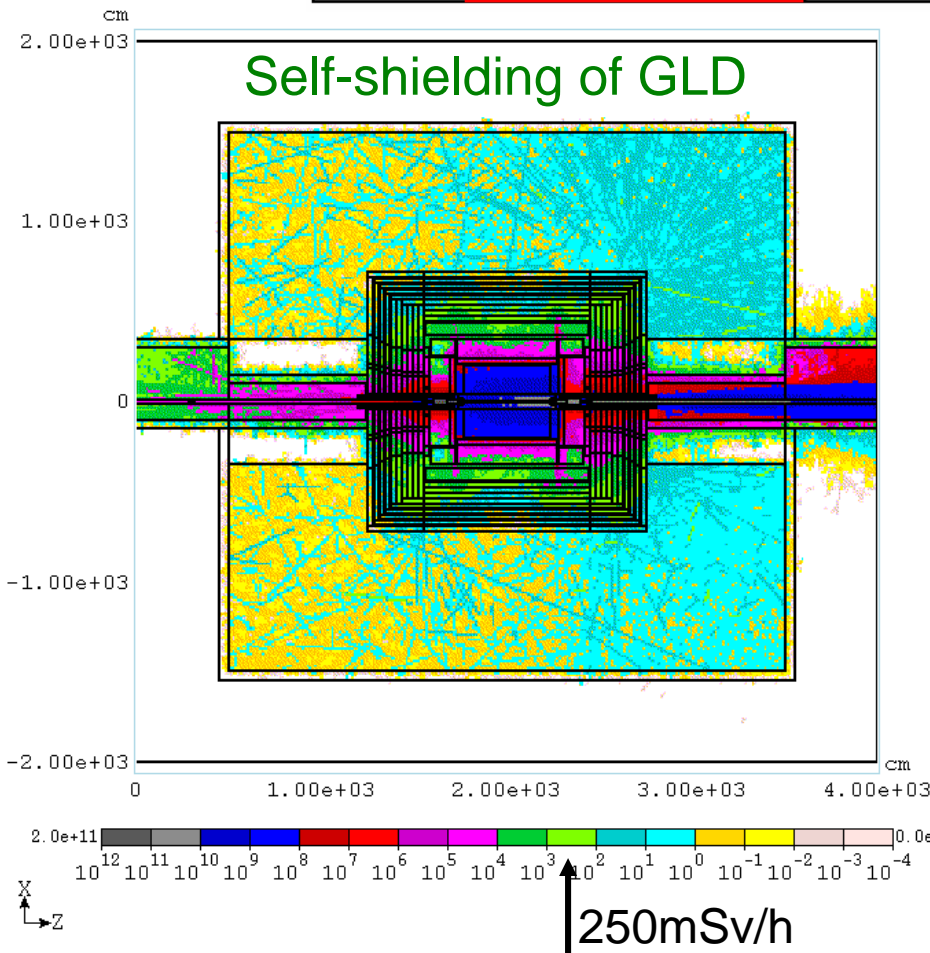
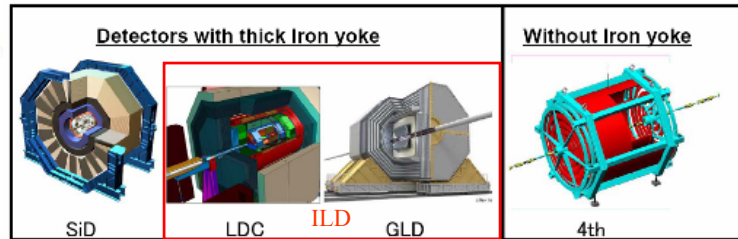

Shielding the "4th" with walls

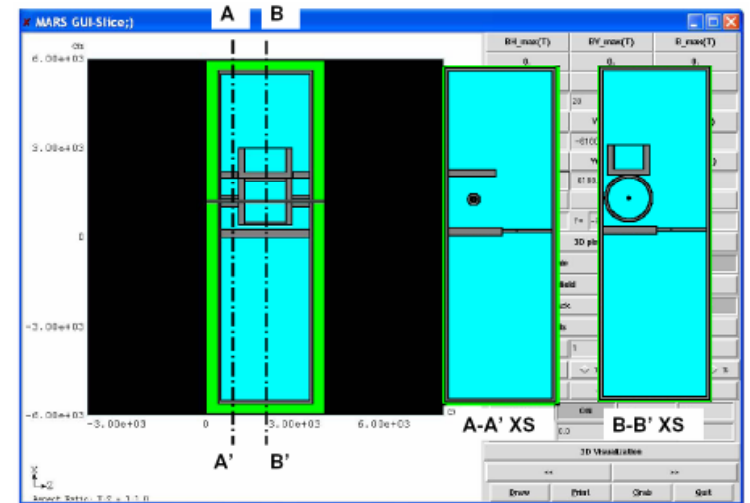
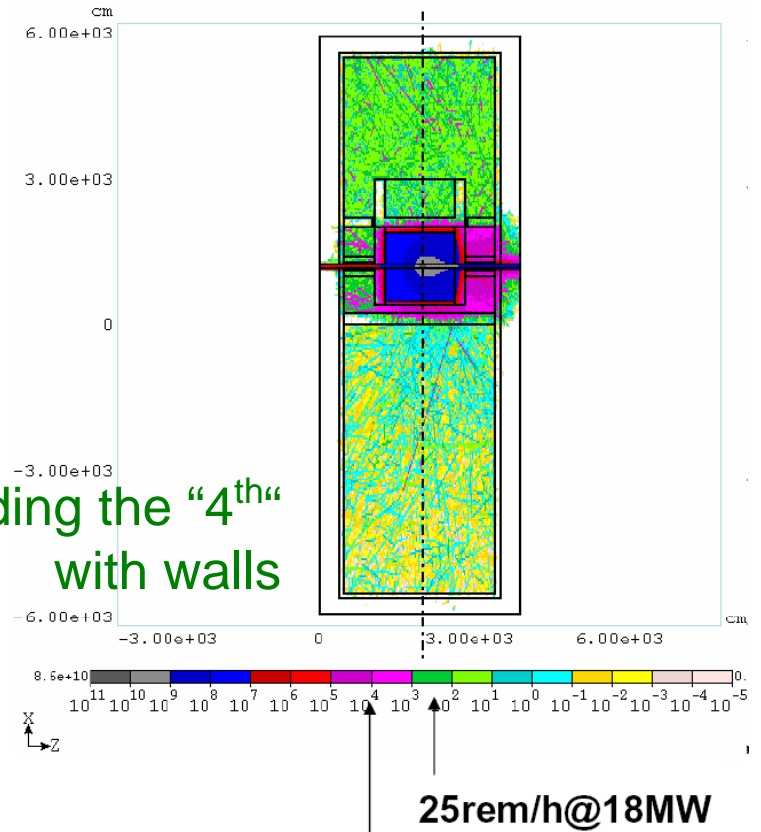

Pacman design

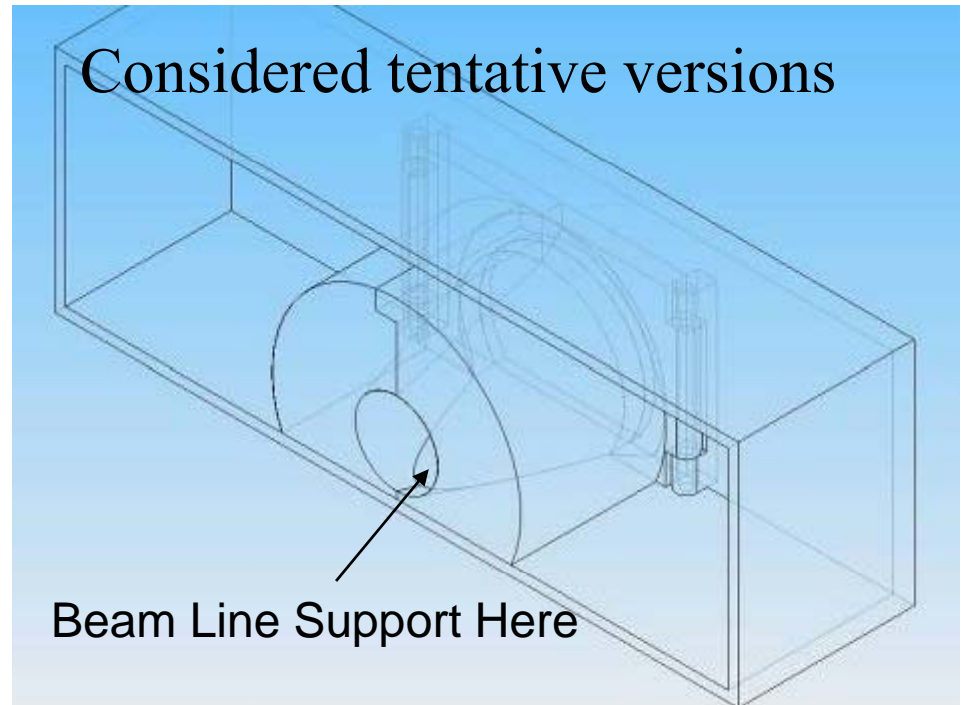
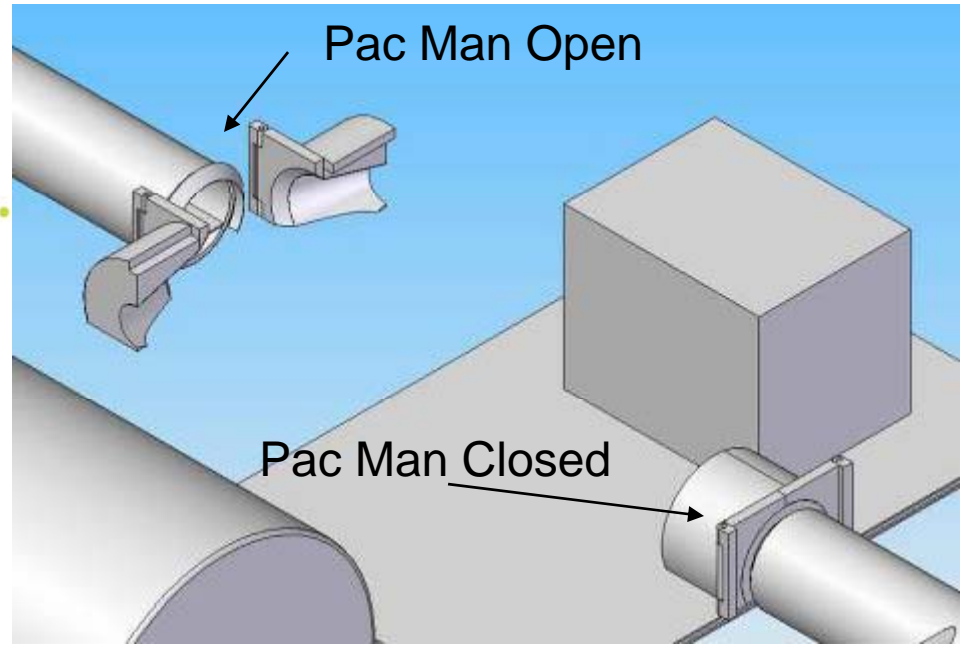

ILC Detector assembly

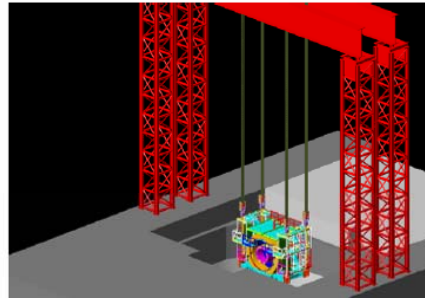
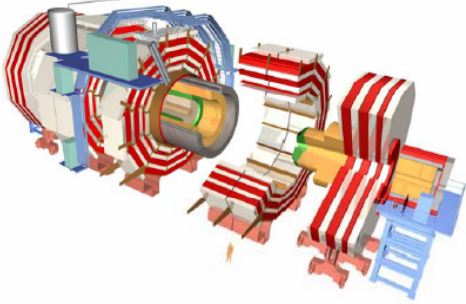

- CMS detector assembled on surface in parallel with underground work, lowered down with rented crane
- Adopted this method for ILC, to save 2-2.5 years that allows to fit into 7 years of construction





Configuration of IR tunnels and halls

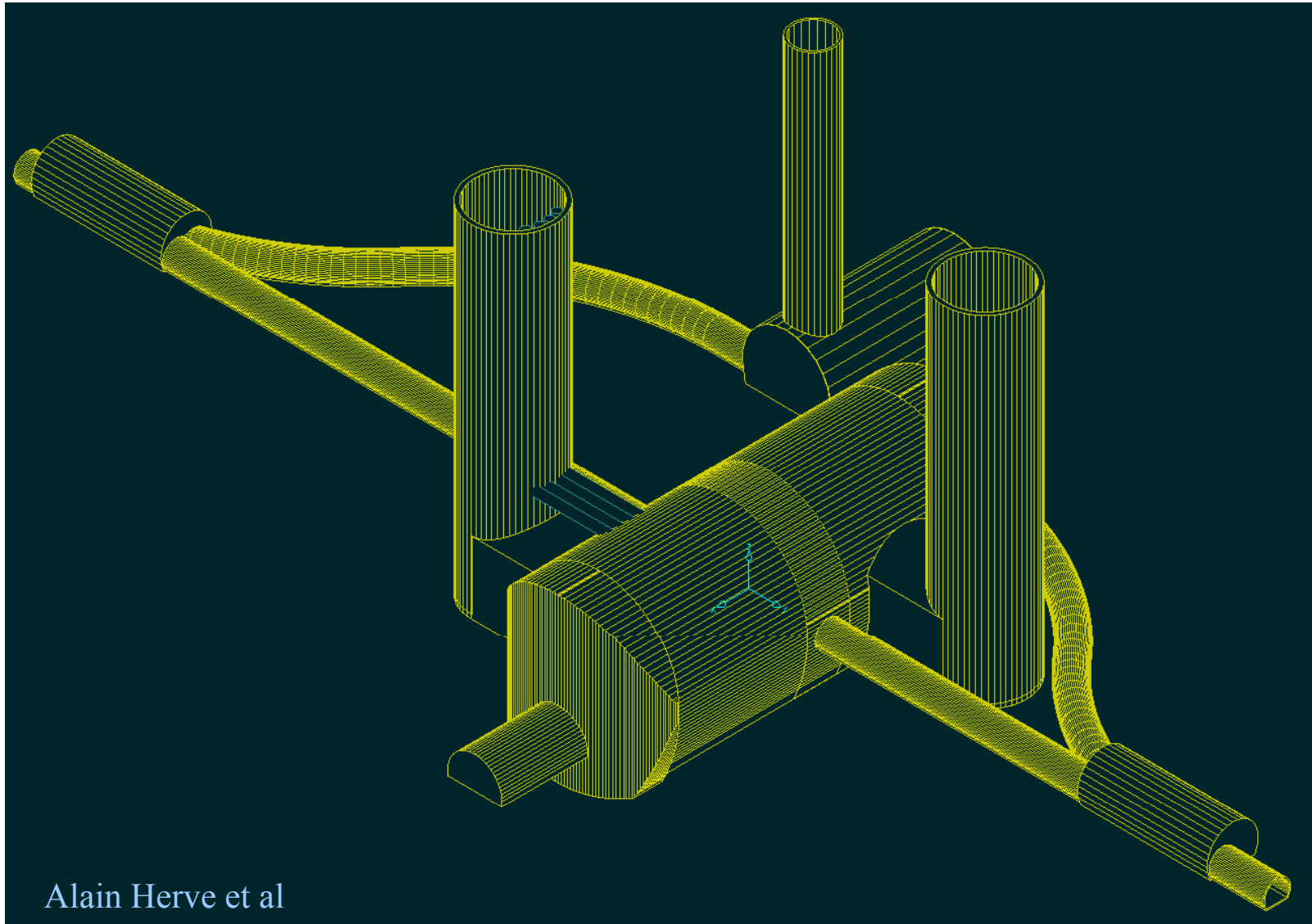

Alain Herve et al



Configuration of surface buildings

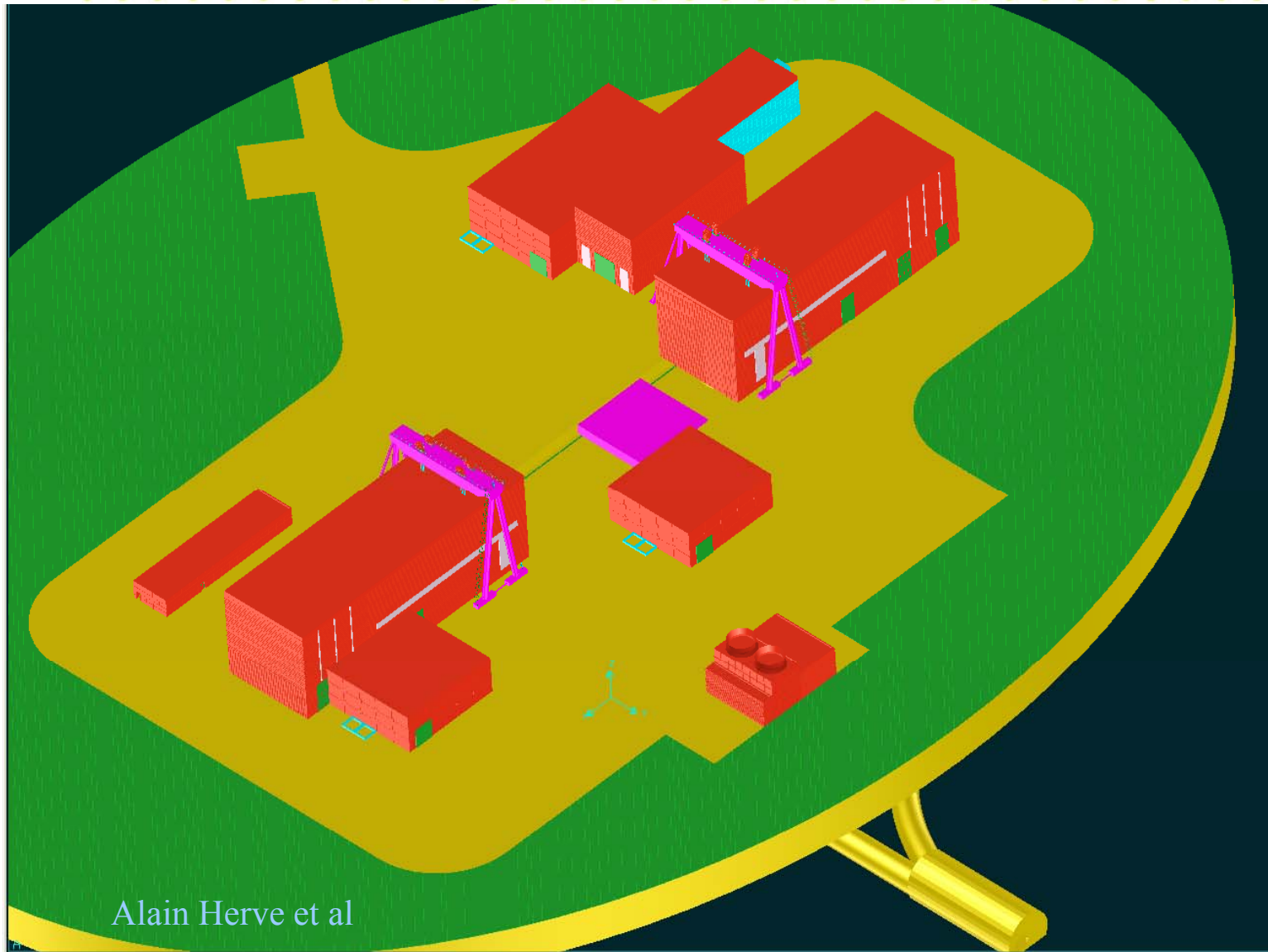

Alain Herve et al



IR integration, SiD example

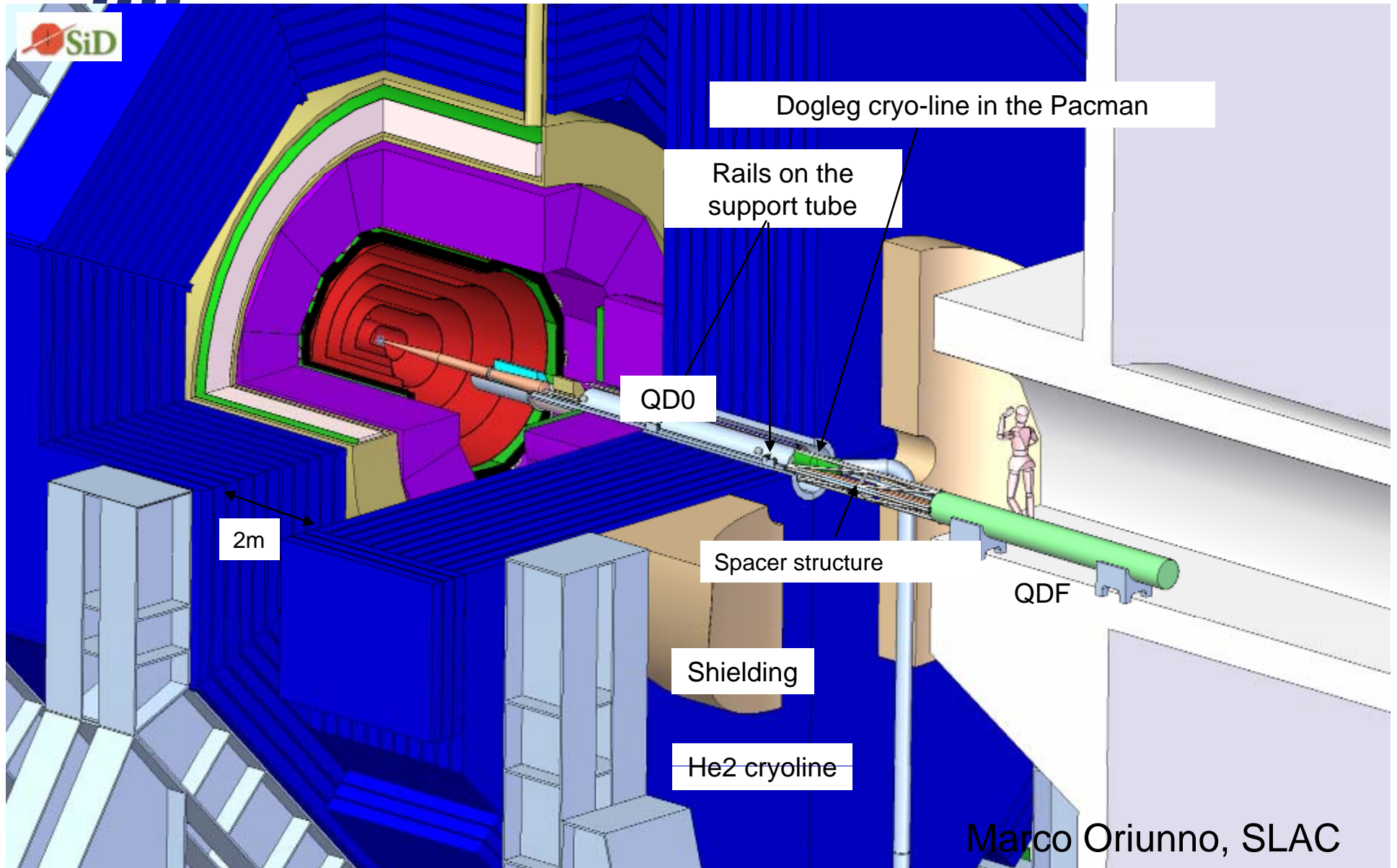



IR integration plans

- Machine – Detector work on Interface issues and integration design is now a major focus of efforts
- IR integration timescale
 - EPAC08 & Warsaw-08
 - Interface document, draft
 - LCWS 2008
 - Interface document, updated draft
 - LOI, April 2009
 - Interface document, completed
 - Apr.2009 to ~May 2010
 - design according to Interface doc.
 - ~May 2010: LHC & start of TDP-II
 - design according to Interf. doc and adjust to specific configuration of ILC
- Details of MDI related issues of detector design and IR Interface document will be discussed in separate talks

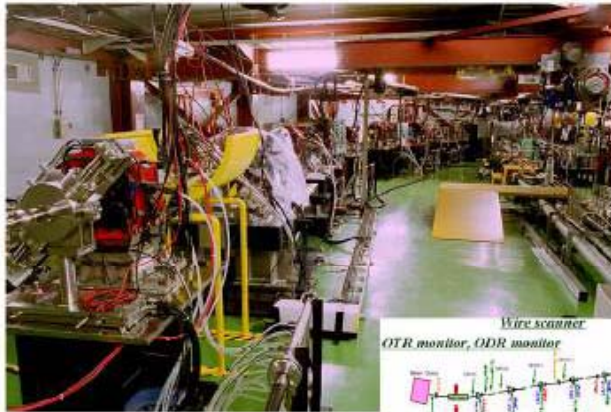

Extraction Line

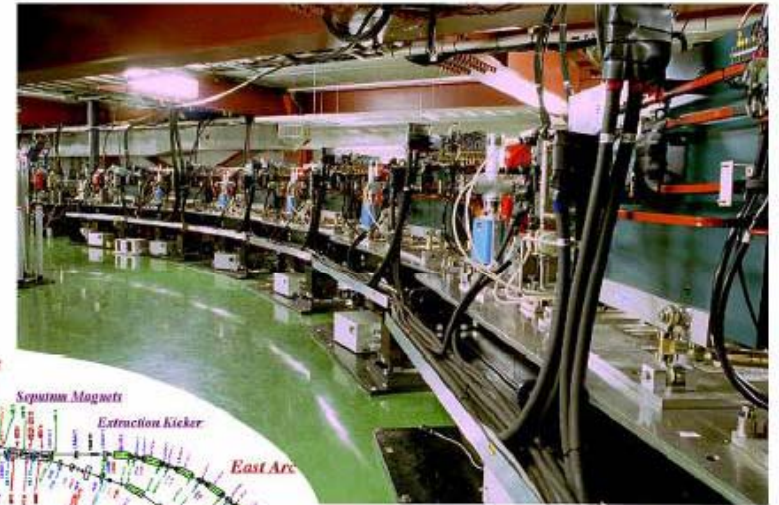

Damping Ring

ATF and ATF2

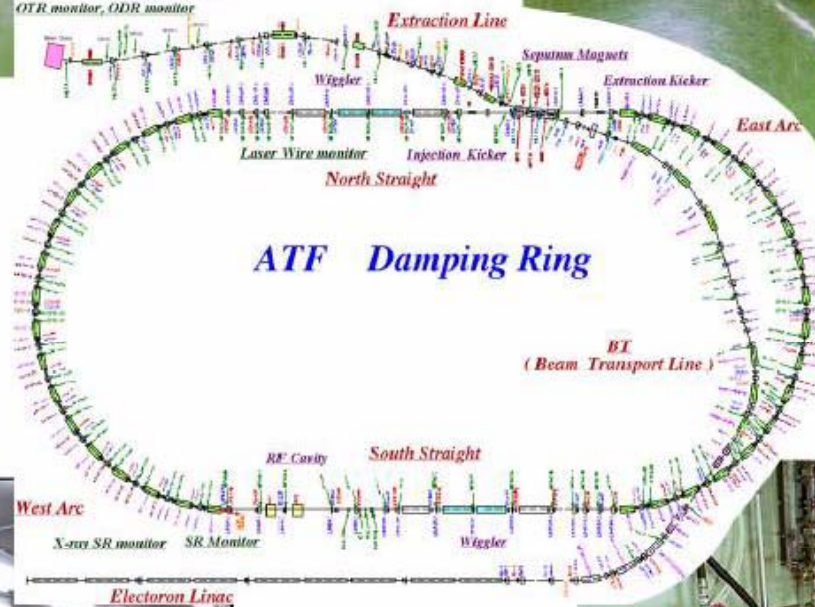

Control Room

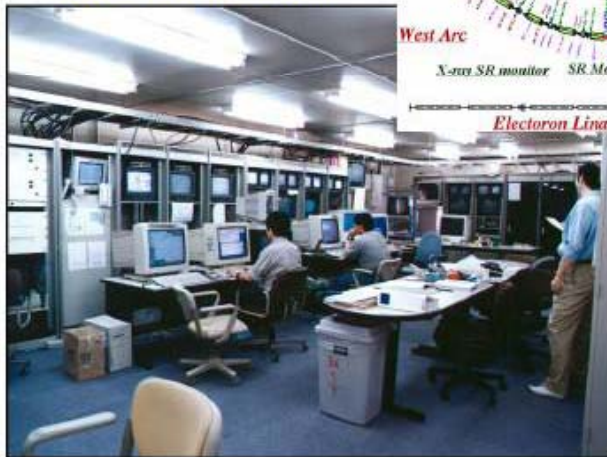

Linac





ATF2

- The idea of a new test facility at ATF, to prototype the **advanced final focus, for linear collider**, was conceived in **2002** at Nanobeam workshop
- Idea evolved, and now being realized in iron and concrete
- ATF2 goals
 - prototype ILC Final Focus system
 - develop FF tuning methods, instrumentation (laser wires, fast feedback, submicron resolution BPMs)
 - learn achieving $\sim 35\text{nm}$ size & $\sim \text{nm}$ stability reliably
 - possibly test ILC Final Doublet prototype with beam
- ATF2 final goal – help to ensure collisions of nanometer beams, i.e. luminosity of ILC

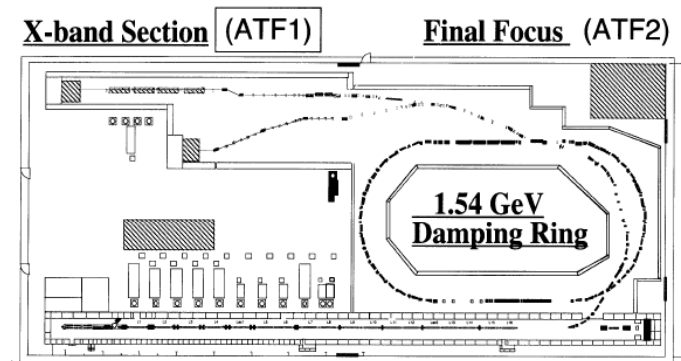

Early scheme presented by Junji Urakawa



ATF Accelerator Test Facility *at KEK*

ATF2

Scaled down model of
ILC final focus

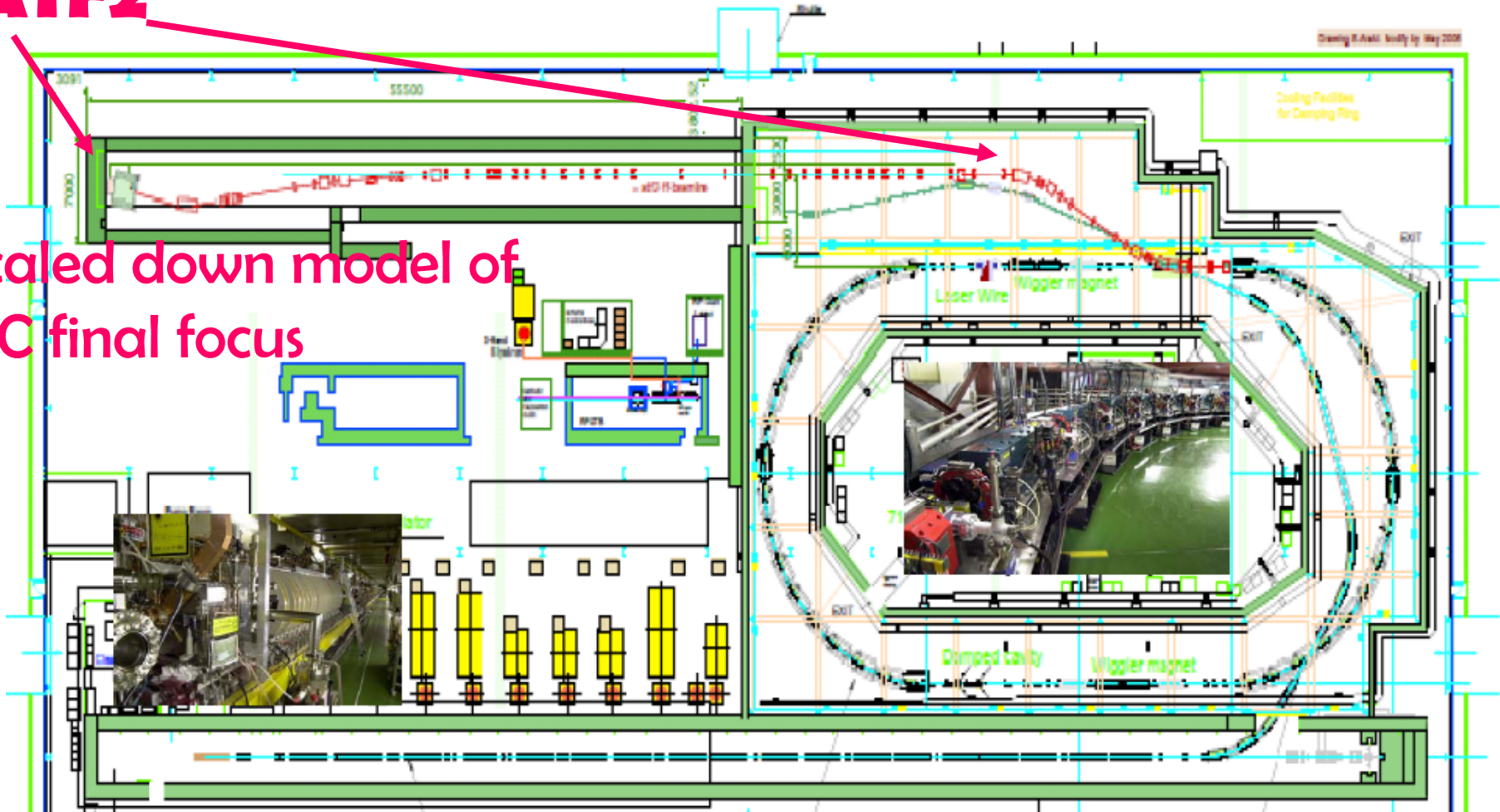

The ATF international collaboration include more than 200 researchers and the ATF MOU is signed by 20 institutions from all over the world



ATF2 – model of ILC BDS

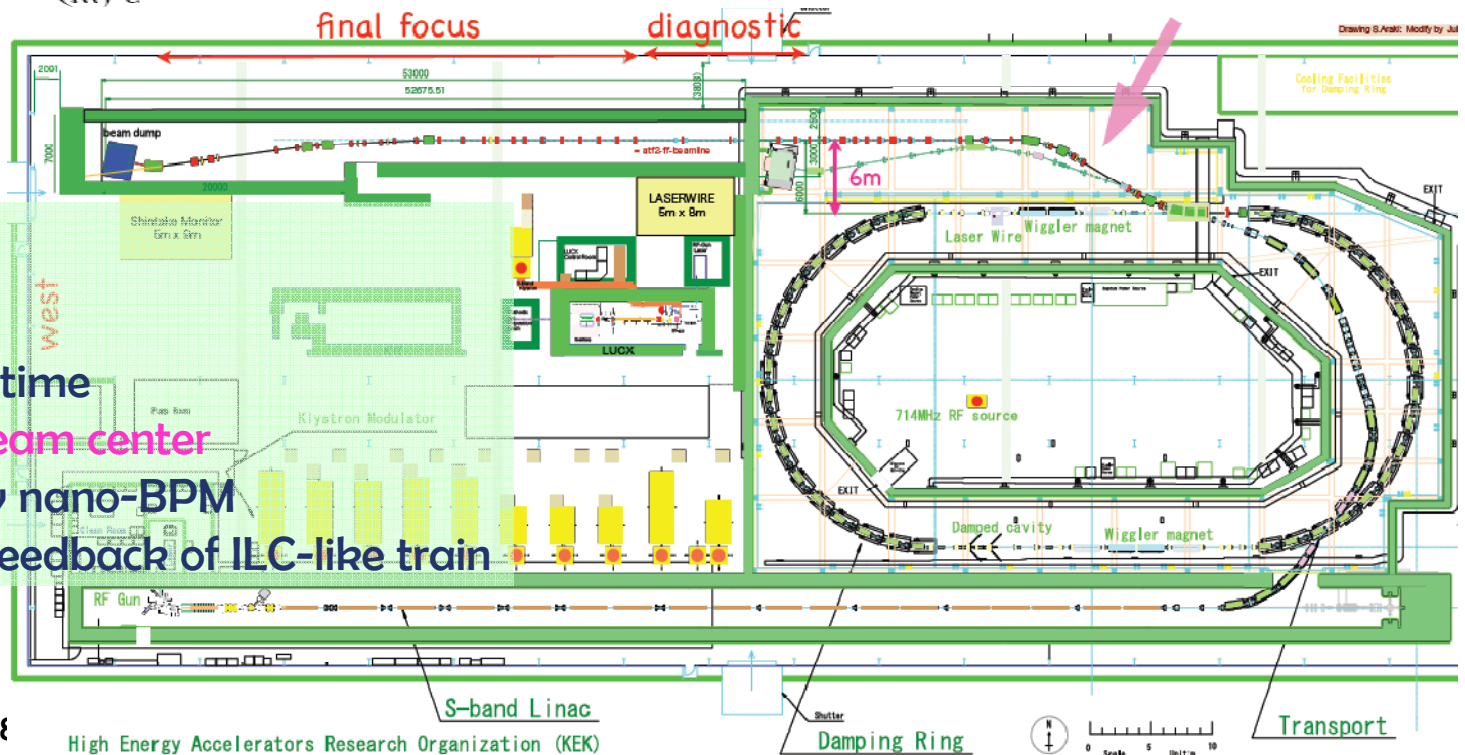
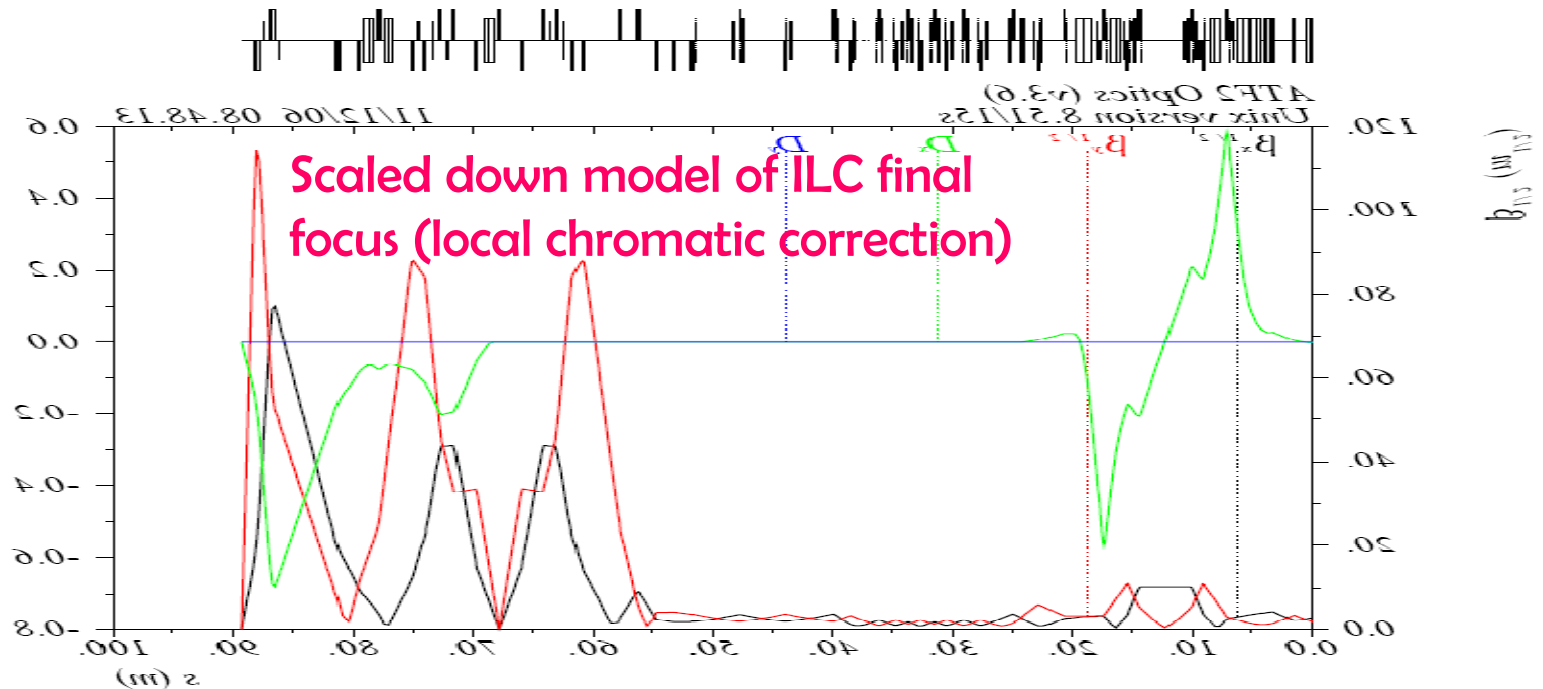

ATF2 goals

- (A) **Small beam size**
Obtain $\sigma_y \sim 35\text{nm}$
Maintain for long time
- (B) **Stabilization of beam center**
Down to $< 2\text{nm}$ by nano-BPM
Bunch-to-bunch feedback of ILC-like train



ATF2 construction – rapid progress in 2007

August – December



Assembly hall before construction



Assembly hall emptied for construction

Photos:
Nobu Toge



Construction of reinforced floor



Construction of shielding : 57

NB08, A.Seryi, May 26, 2008



ATF2 construction – January 2008



The last regular quadrupole is going to the destination

~20 sets of supports, movers & quads were installed in January. R.Sugahara et al



Advanced beam instrumentation at ATF2

- BSM to confirm 35nm beam size
- nano-BPM at IP to see the nm stability
- Laser-wire to tune the beam
- Cavity BPMs to measure the orbit
- Movers, active stabilization, alignment system
- Intratrain feedback, Kickers to produce ILC-like train

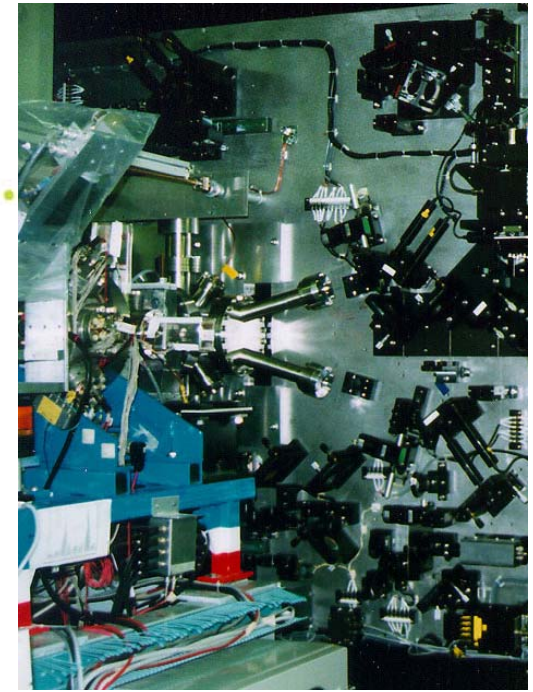

IP Beam-size monitor (BSM)
(Tokyo U./KEK, SLAC, UK)

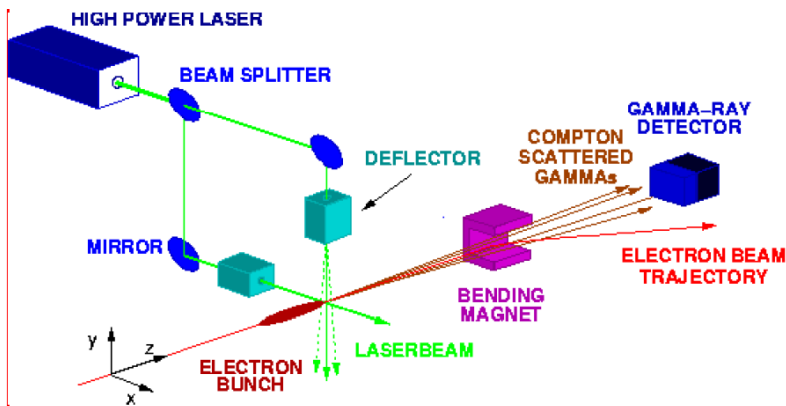

Laser-wire beam-size Monitor (UK group)

Cavity BPMs with 2nm resolution, for use at the IP (KEK)

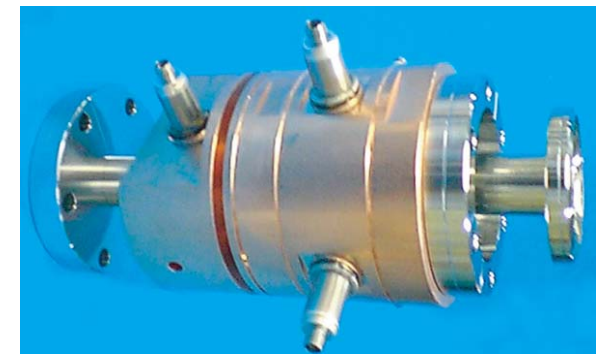
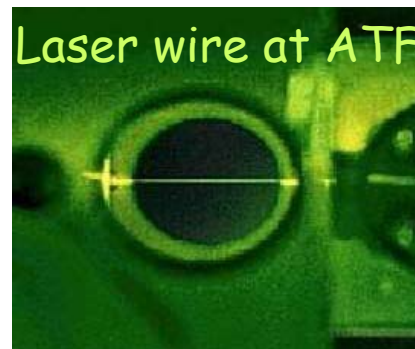
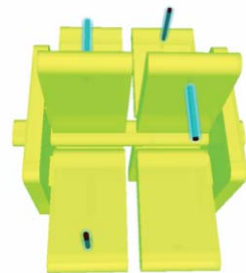

Cavity BPMs, for use with Q magnets with 100nm resolution (PAL, SLAC, KEK)



ATF collaboration & ATF2 facility

- ATF2 will prototype FF,
- help development tuning methods, instrumentation (laser wires, fast feedback, submicron resolution BPMs),
- help to learn achieving small size & stability reliably,
- potentially able to test stability of FD magnetic center.

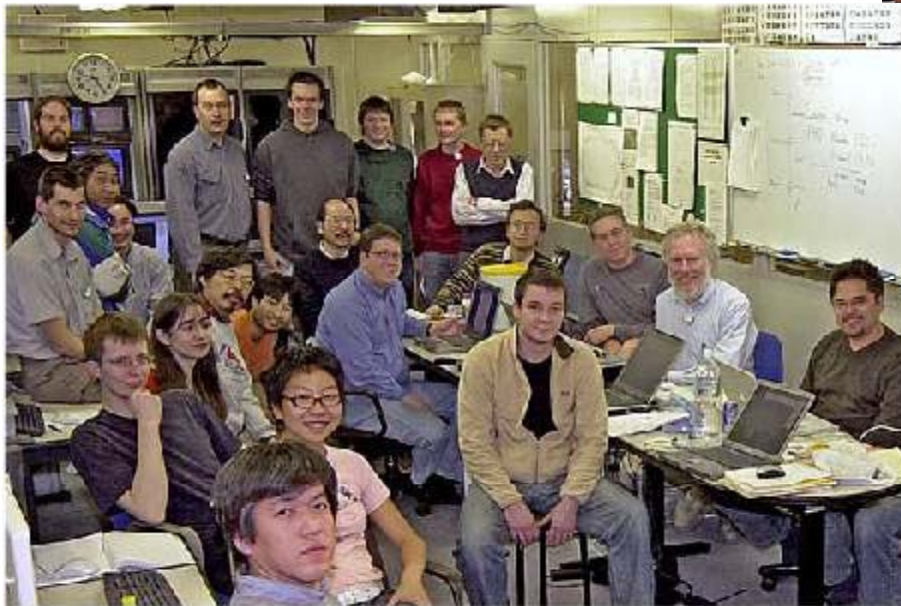

- ATF2 is one of central elements of BDS EDR work, as it will address a large fraction of BDS technical cost risk.
- Constructed as ILC model, with in-kind contribution from partners and host country providing civil construction
- ATF2 commissioning will start in Autumn of 2008



ATF2 schedule

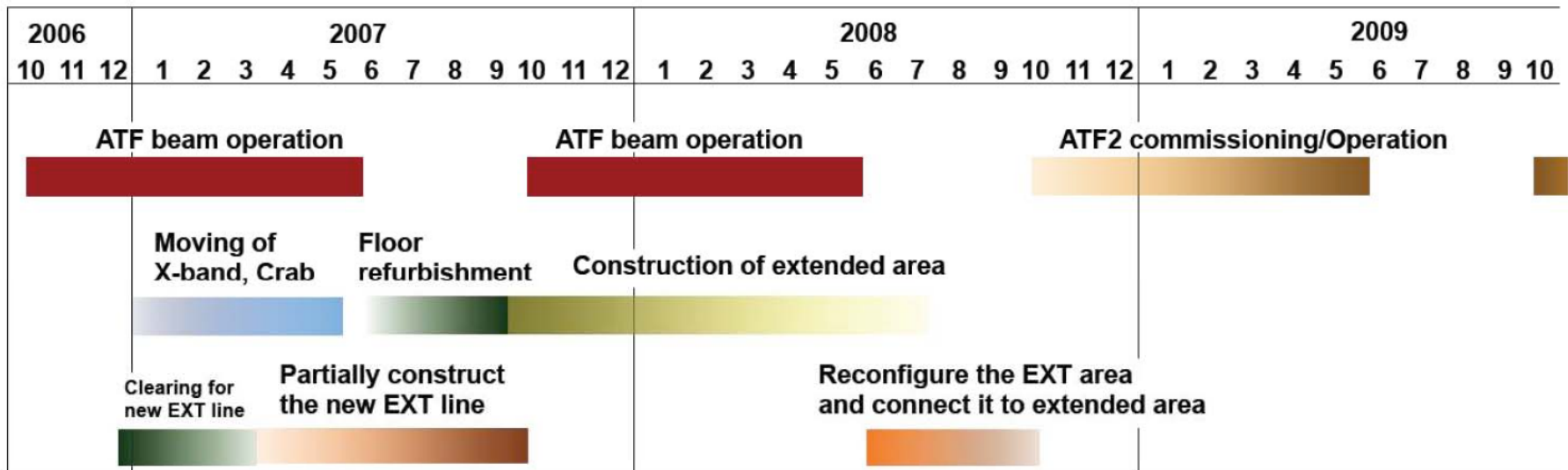

- **Construction of the extended shield area for final focus system can be done during the ATF beam operation.**
- Partial construction beside the current EXT line in shutdown week will release the work load for reconfiguration of the EXT line in summer of 2008.
- **ATF2 beam will come in October, 2008.**



Present BDS planning strategy

- With the newly adopted by ILC GDE Technical Design Phase I and II plan, the scope of work in BDS has changed, and the focus is shifted
 - The earlier planned work on detailed design and engineering of subsystems will not be performed
- The work in BDS will be focused in a few critical directions, which were chosen taking into account the following criteria:
 - Critical impact on performance versus cost;
 - Advanced ideas promising breakthrough in performance;
 - Broad impact and synergy with other worldwide projects
- Based on those criteria, the following three critical directions are suggested as the focus of BDS work and R&D during TDP:
 - General design work on BDS
 - Work on test facilities, in particular ATF2
 - Work on Interaction Region optimization



General design work on Beam Delivery

- The goal of BDS design work is to create a design which has improved performance, lower cost, and good potential for upgrades. The scope of the work will include:
 - Study of lower energy reach shortened BDS and its upgrade paths
 - Conceptual design of beam dump system
 - Design and key prototypes of crab cavity system
 - Collimation design, study crystal channeling for its shortening
 - Feedbacks, emittance and MDI diagnostics, beamline instrumentation
 - Design for the $\gamma\gamma$ option of collider
 - Study alternative design of magnets for system cost reduction
 - Synergy studies with CLIC Beam Delivery
 - Evaluate synergies from LHC collimation and Crab Cavity systems



Test Facilities, ATF2

- The goal of the work at ATF2 is to make system level demonstration of Beam Delivery System, learn to achieve small spot size reliably, develop the methods and instruments needed to achieve the spot size and stability goal, and perform beam tests of critical subsystems, essential for optimization of BDS design. The scope of work will include:
 - Commissioning ATF2 hardware (including cavity BPMs, High Availability Power Supplies, Interferometer Beam size monitor, etc.)
 - Development of algorithmic control software and feedbacks to allow achieving the small size goals
 - Development of Laser Wires for emittance diagnostics
 - Development of Feedback and Feedforward systems for beam stability control
 - Development of Interferometer system for FD stability monitoring
 - Develop methods for low emittance preservation in the ring, extraction line and in FF
 - Tests of Superconducting Final doublet at second stage of ATF2
 - Tests of Permanent magnet Final doublet at second stage of ATF2
 - Tests of electron to gamma conversion for $\gamma\gamma$ option at second stage of ATF2
 - Collimation and dump window damage tests at ATF2



Interaction Region optimization

- The goal of the IR optimization work is to come up with a design where various contradicting interface requirements are balanced and solved. The design would need to work for two detectors working in push-pull arrangement. One of the key efforts is design and prototyping of final doublet, which should address tight space constraints, the need for versatile beam orbit and aberration correction, challenging mechanical stability, and the system level performance. The scope of work will include:
 - Preparation of the IR interface specifications with detector groups
 - Design efforts of machine detector interface
 - Optimization of IR hall and IR external auxiliaries
 - Conceptual design of SC FD and its cryo system
 - Prototyping and vibration test of long ILC-like cold mass
 - Design and production of ILC-like FD for ATF2
 - Study and conceptual design of IR vacuum system
 - Study of machine related background



BDS plans

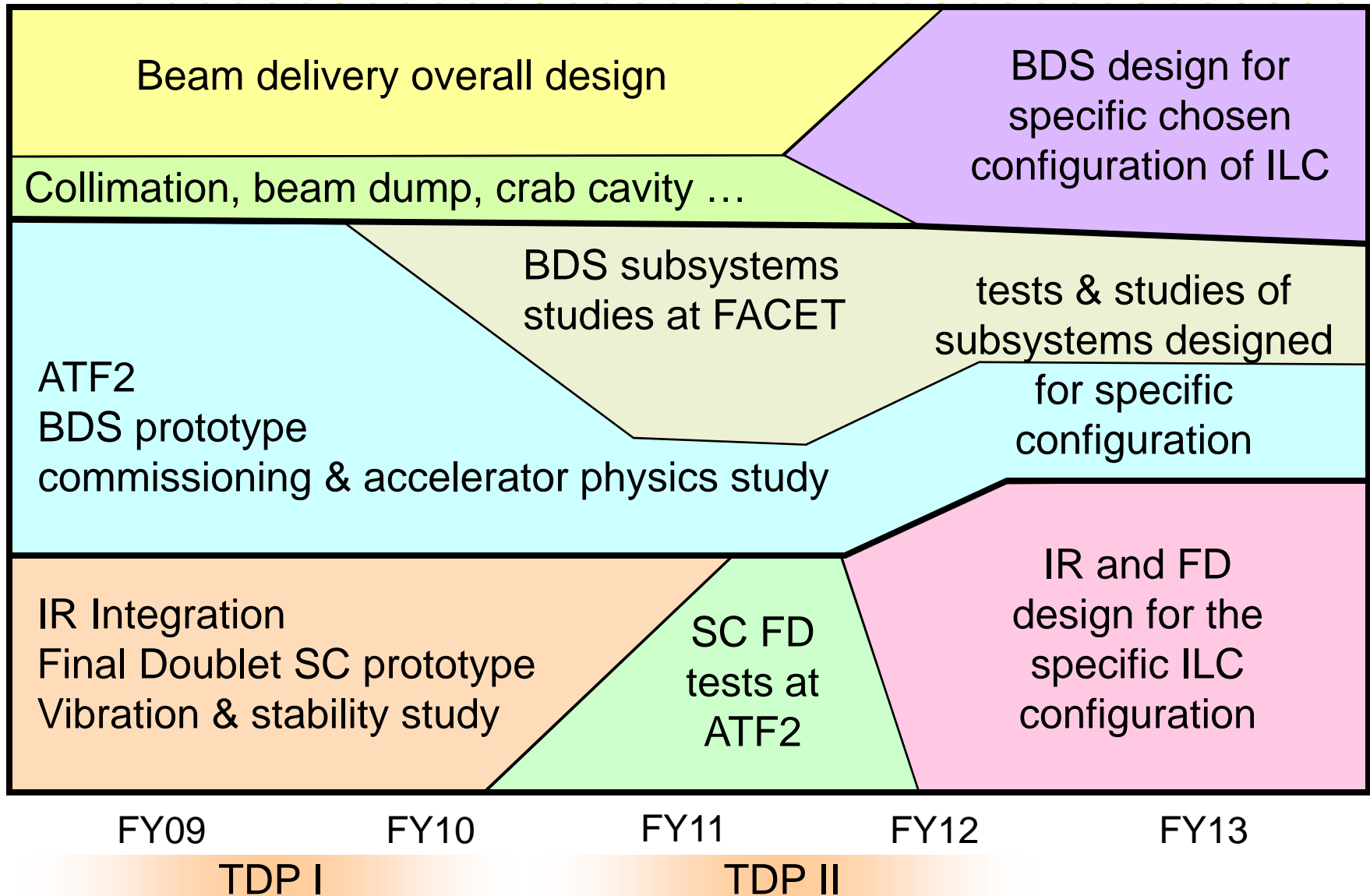



Conclusion

- Design of Beam Delivery system for ILC was produced by international design team
- Critical subsystems (Final Doublet, Crab cavities) are being prototyped
- Complex systems (Interaction Region, Beam dumps) are being designed in details
- BDS System test is being prepared at the ATF2 test facility



Acknowledgement

- Beam Delivery design team, which include colleagues from:
 - BARC, Berkeley Univ., Birmingham Univ., BNL, CEA, CERN, Colorado Univ., DESY, Dundee Univ., FNAL, IFIC, IHEP Ch., Iowa Univ., KEK, Kyoto Univ., Kyungpook Univ., LAL, Lancaster Univ., LAPP, LLNL, LLR/IN2P3, Manchester Univ., Notre Dame Univ., NSF, Oregon Univ., Oxford Univ., PAL, RHUL, SLAC, STFC, Tohoku Univ., Tokyo Univ., Yale Univ., ...