



Linac Quad Field and Position Stability

Chris Adolphsen
SLAC

TDR Quad Layout

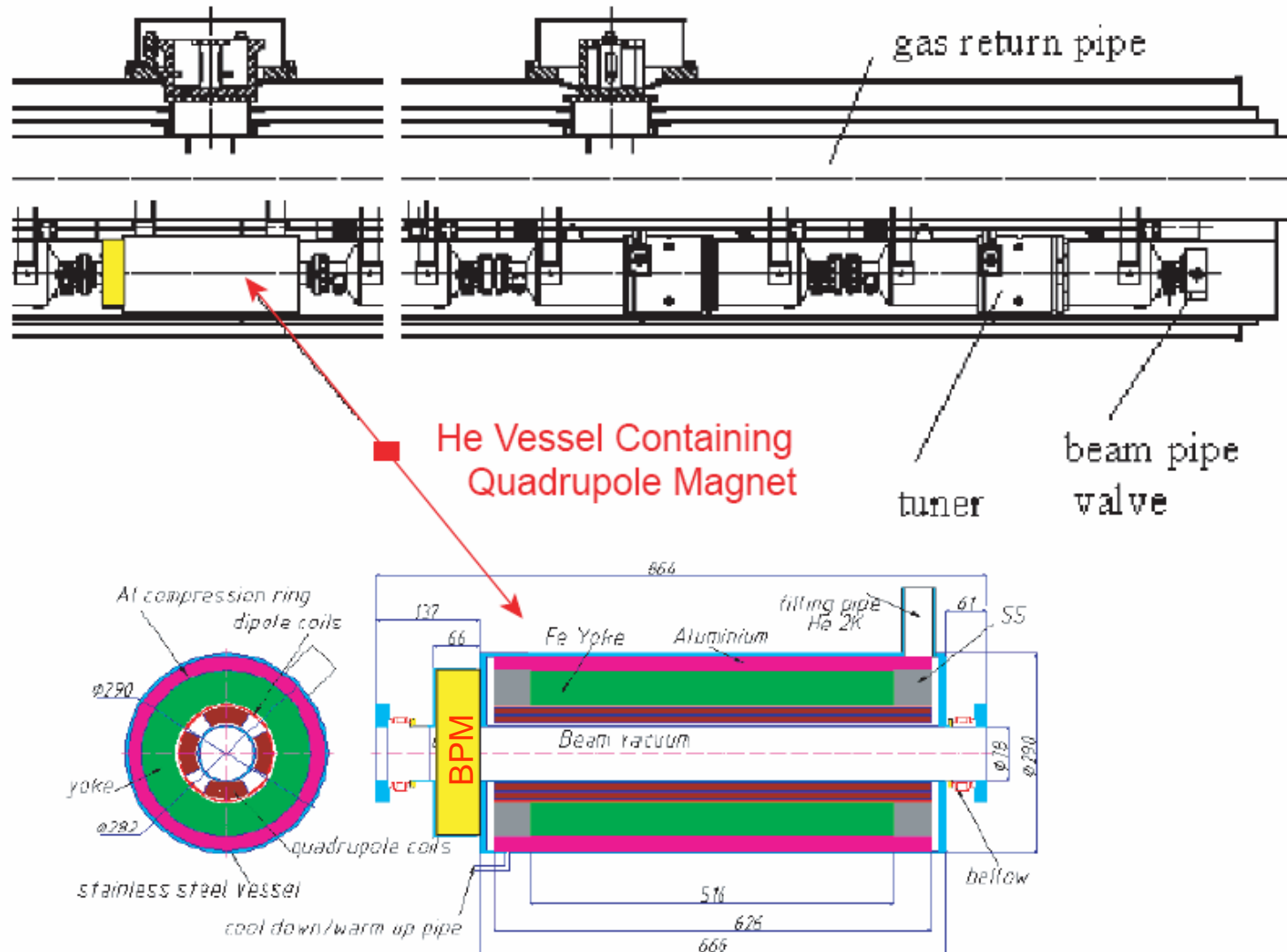

Figure 3.2.12: Cross-section and longitudinal cut of superconducting magnet package.

TDR Quad Specs

- **Quadrupole Coil - Cos(2Phi)**

- Inner Coil Radius = 45 mm

- Coil Total Length = 626 mm

- Nominal Gradient = 60 T/m

- Max Field At Conductor = 3.6 T

- Operating Temperature 2 K

- Nominal Current = 100 A

- Inductance = 3.2 H

- **Dipole Coils, Vert./Horiz. (Cos, Single Layer)**

- Inner Coil Radius = 67 mm

- Coil Total Length = 626 mm

- Max Field on Axis = 0.074 T

- Max Current = 40 A

- Inductance/Coil = 29 mH

- **Field Quality (at 30 mm radius)**

- Skew Quadrupole < $3 \cdot 10^{-4}$

- Higher Harmonics Of Quadrupole < 10^{-3}

- Alignment Error (Angle) < 0.1 mrad rms

Quad Field and Position Requirements

- Fast Motion (Vibration)
 - Require uncorrelated vertical motion $> \sim 1$ Hz to be < 100 nm
 - Many measurements being done – data look close to meeting spec.
- Slow Motion (Drift)
 - For dispersion control, want quad to stay stable relative to its neighbors at few micron level, day to day
 - Although slow ground motion is large, it is correlated over long distance range which makes its net effect small.
 - Little data on local day-to-day motion of quad in a cryostat.
- Change of Field Center with Change in Field Strength
 - For quad shunting technique to be effective in finding the alignment between the quad and the attached bpm, quad center must not move by more than a few microns with a 20% change in field strength
 - No data for prototype ILC quads.

Quad Vibration

- Why is Ground Motion a Concern for the ILC:

It will move the quadrupole magnets, which will steer the beams and cause them to miss at the IP: $\rightarrow\leftarrow$

- Temporal Scale of Problem:

Motion $\lesssim 0.1$ Hz heavily suppressed by trajectory feedback loops.

Motion $\gtrsim 10$ Hz generally not significant.

- Spatial Scale of Problem:

More sensitive to uncorrelated motion,



than to motion correlated over distances \gg betatron wavelength:

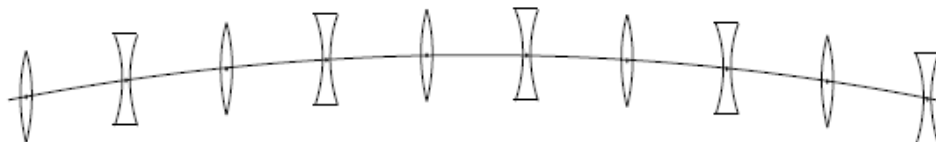

Correlation of Motion

Example of Vertical Motion Correlations in the SLAC Linac Tunnel

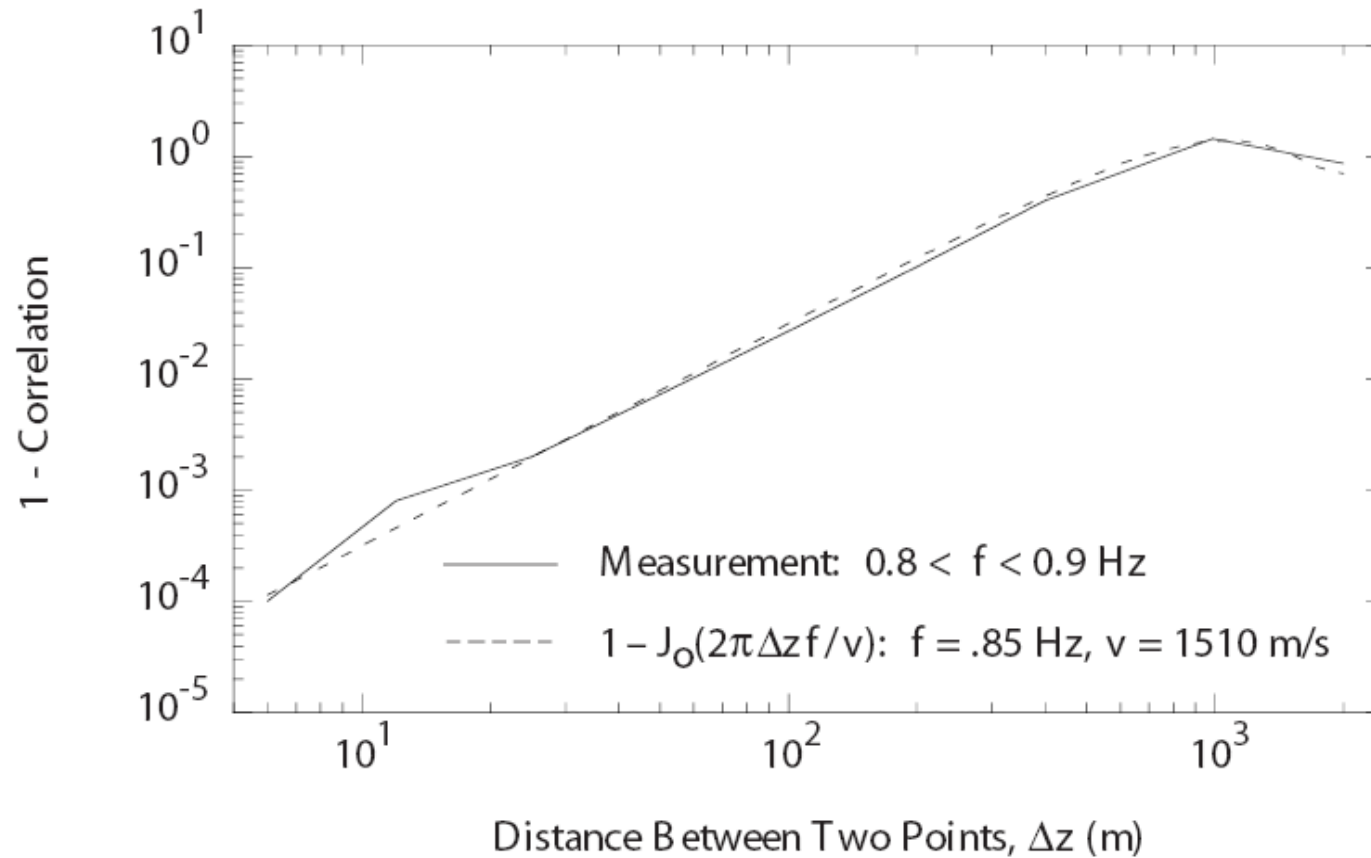

Amplification & Additional Motion

Do not want support system to amplify or add to quad motion.

Recent measurements of DESY M6 show some amplification due to cryostat supports, and some additional high freq motion.

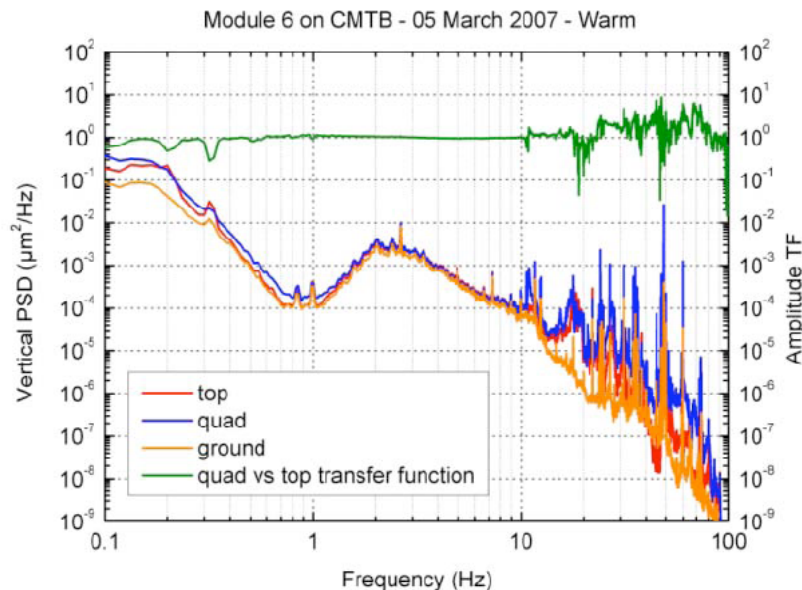

Figure 4. Room temperature PSD spectra measured simultaneously on the CMTB floor, on top of the vacuum vessel and on the quadrupole, quad vs vessel top transfer function is also shown.

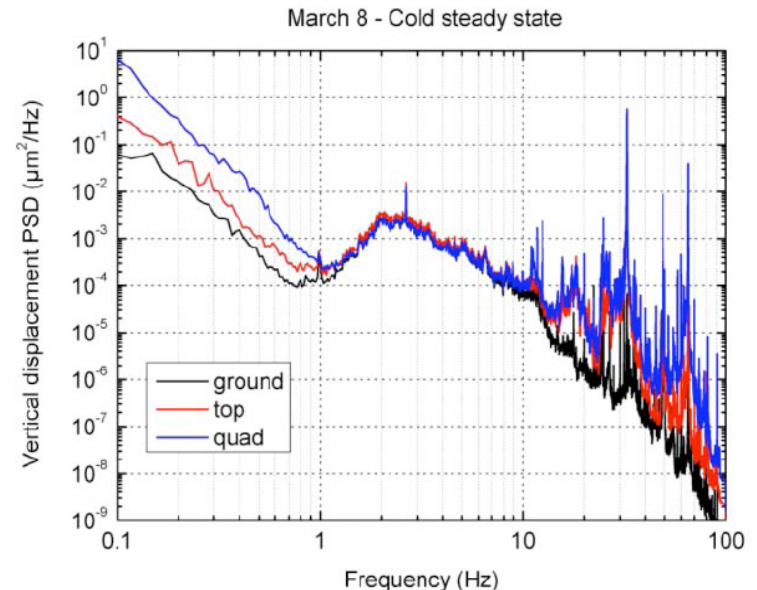
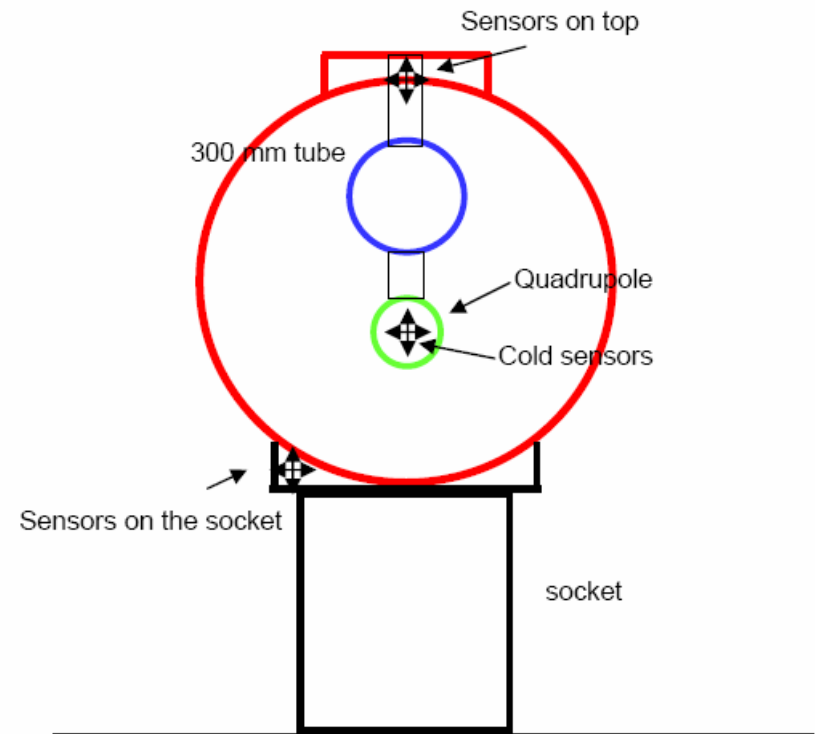
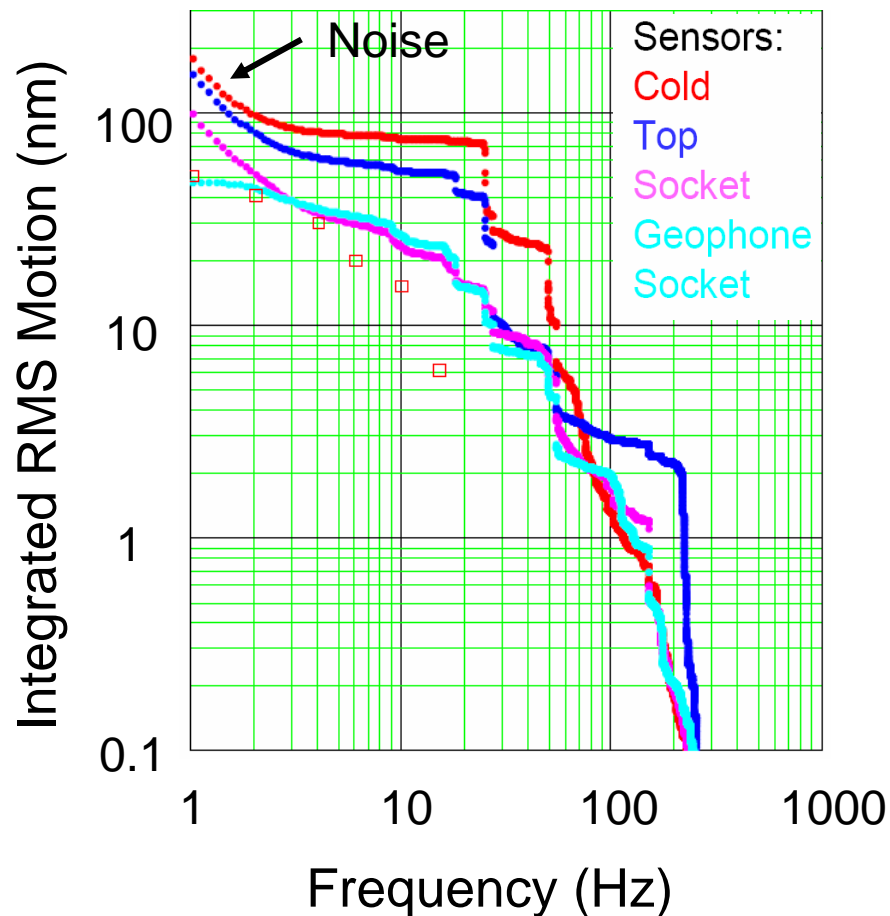

Figure 5: PSDs of ground, vessel top and quadrupole in cold steady state with RF off, measured just after reaching the cold stable conditions at the end of the 11th cooldown.

Earlier Vertical Quad Motion Measurements at TTF

(ILC Goal: < 100 nm for $f > \sim 1$ Hz)



Long (> Minutes) Term Quad Motion

- One Concern is that He Gas Return pipe supports are intercepted by 40-80 K shield
- As heat load varies (rf on-off, beam on-off), the shield temperature may vary up to ~20 degK
- From Paolo Pierini (INFN)
 - A 1 K temperature variation results in a positional variation in the range of 0.3 micron. Again, this is for a variation of the shield temperature, but a similar effect applies if the tunnel temperature changes (and this may explain also the measurements remembered by Carlo).
 - Furthermore, fiberglass expansion coefficients depend on the orientation of the thermal gradient with respect to the primary fibers and on the fiber sizes, but we do not have any direct thermal expansion measurement (or thermal conductivity) data on our composite material, so I am relying on literature data.

Also, varying corrector magnet lead heat loads may change quad position (only 2K systems temp stable)

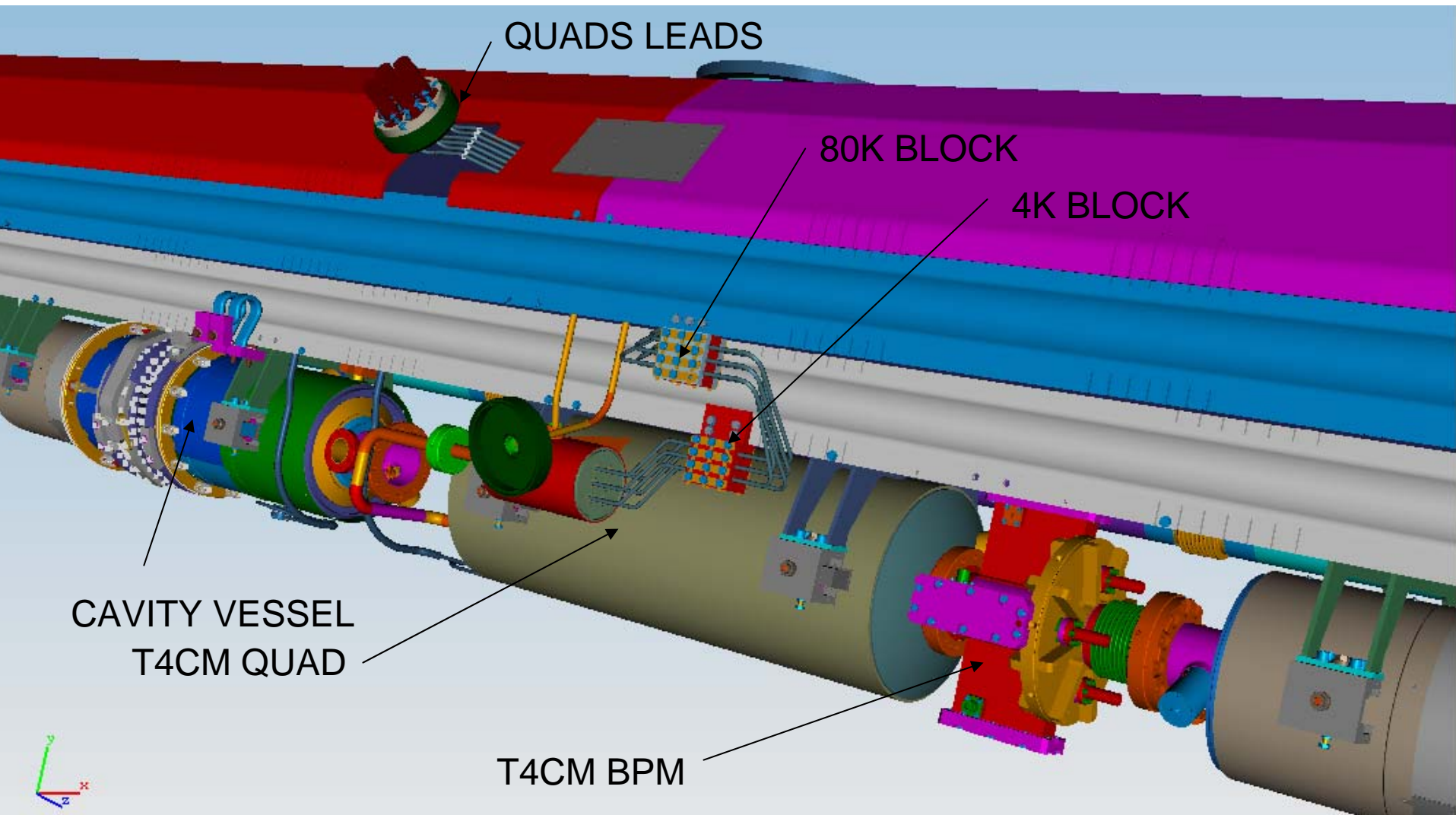

Motion of Quad Center -vs- Field Strength

CIEMAT
Cos(2Φ) SC Quad
(~ 0.7 m long)

combined quadrupole TESLA500 2 block coil design

27/10/00 12.23

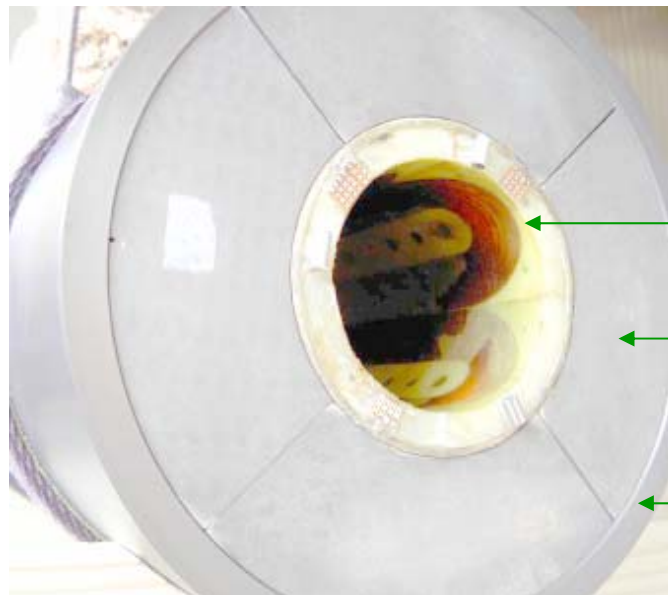
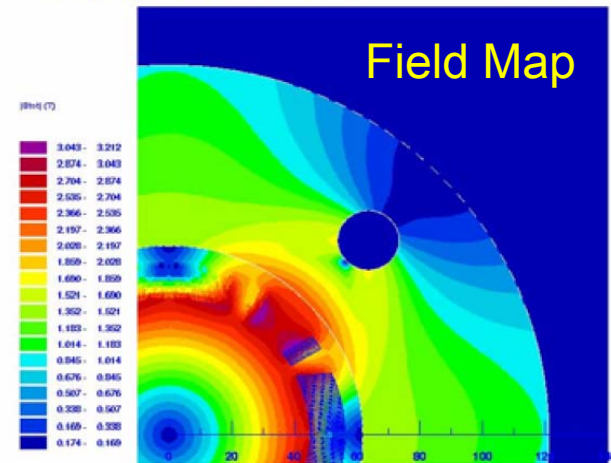

He Vessel →

SC Coils →

Iron Yoke Block →

Al Cylinder →

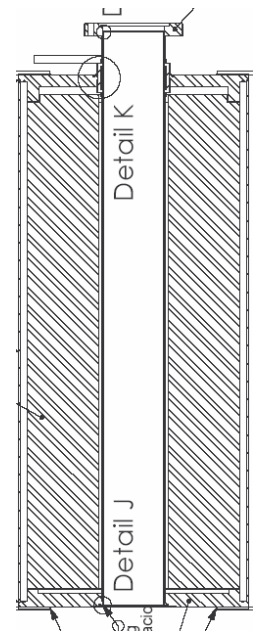

Why combined function (quad + corrector) magnets may not be a good idea – these data show the measured quad strength for various corrector settings (ID) for the CIEMAT quad in tests at DESY

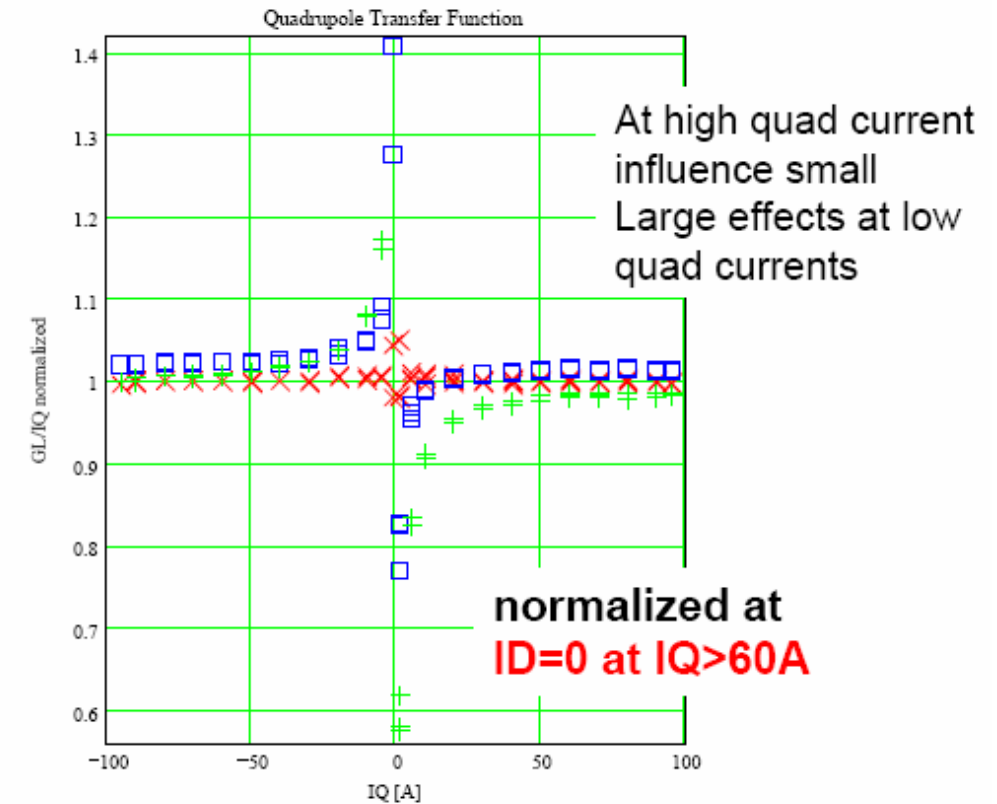
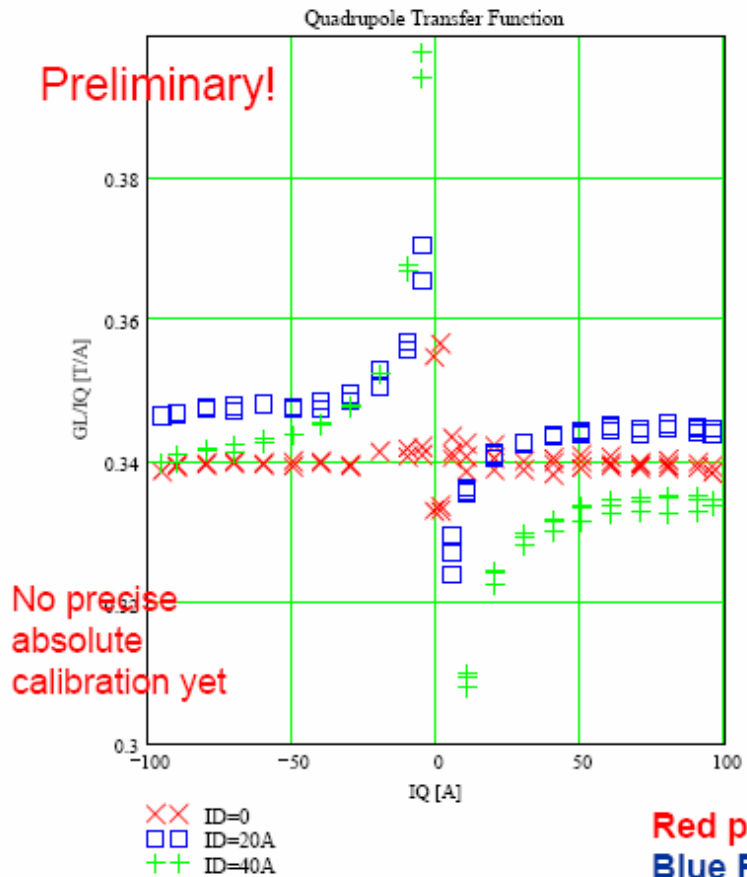

Red points: ID=0A

Blue Points: ID=20A

Green Points: ID=40A

Cryostat and Cryogenic System

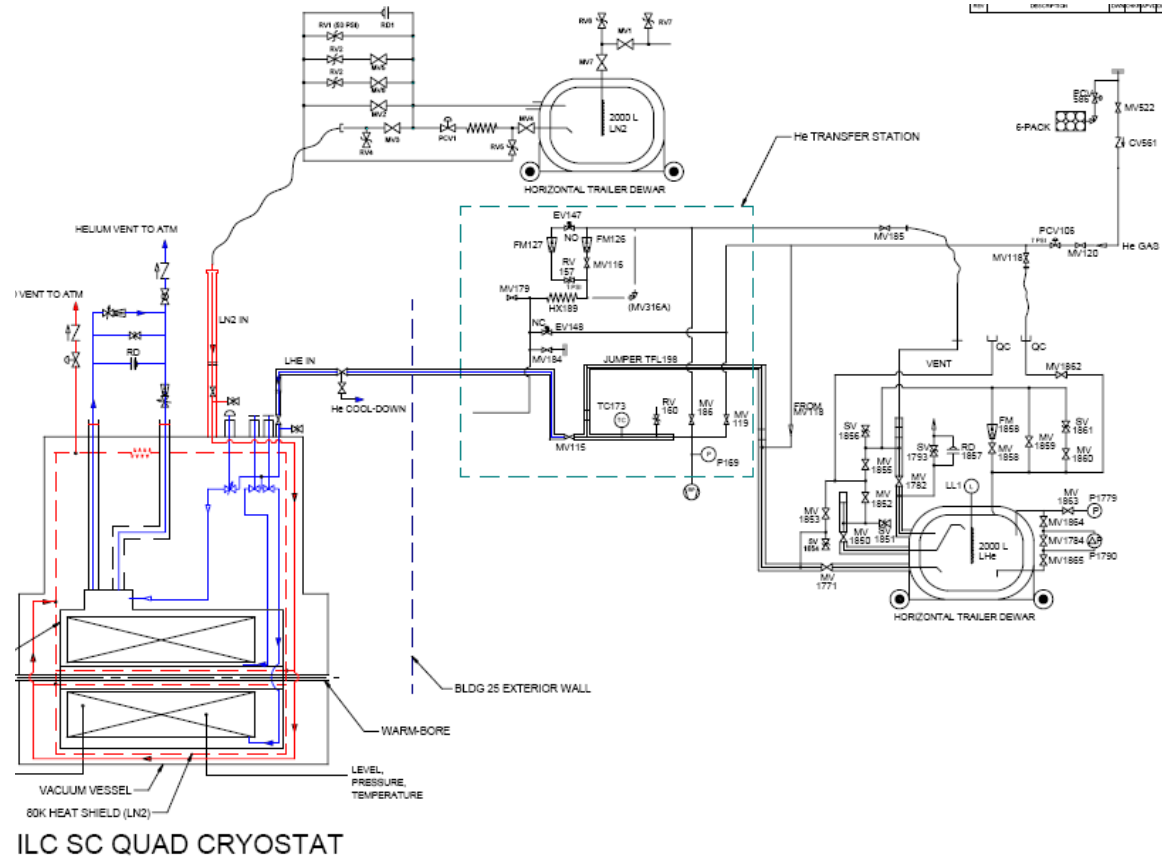
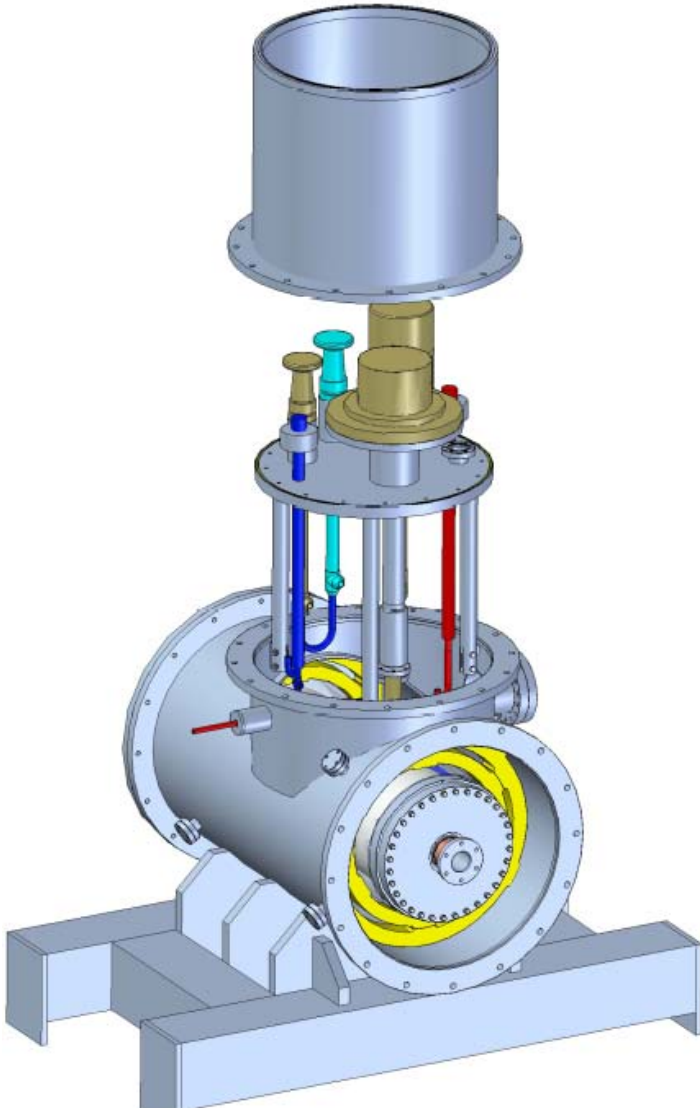

New Rotating Coil Set-up Designed For Measuring Large Bore Quads

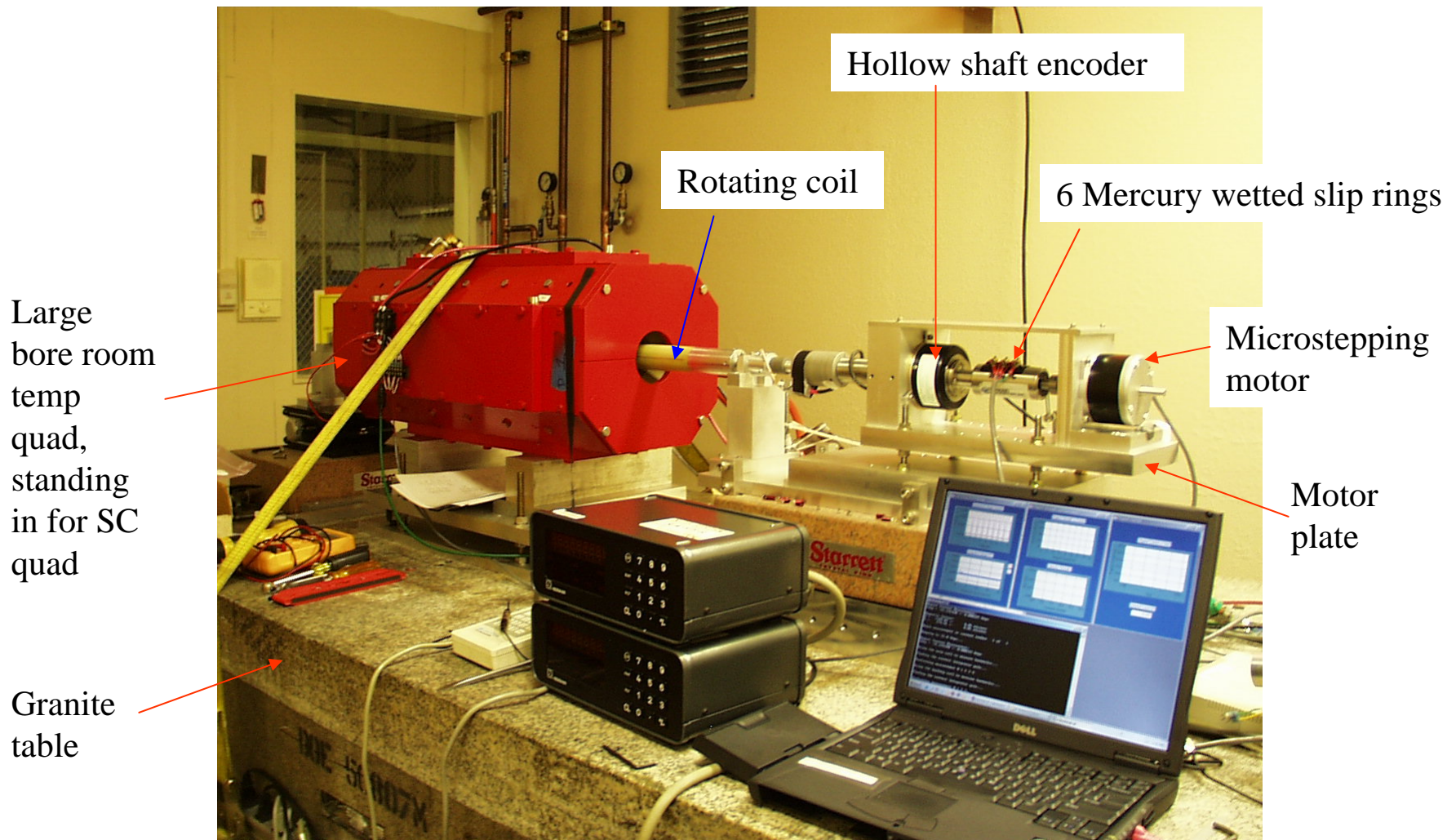

Normal-Conducting Quad Center Stability Data Taken Over Five

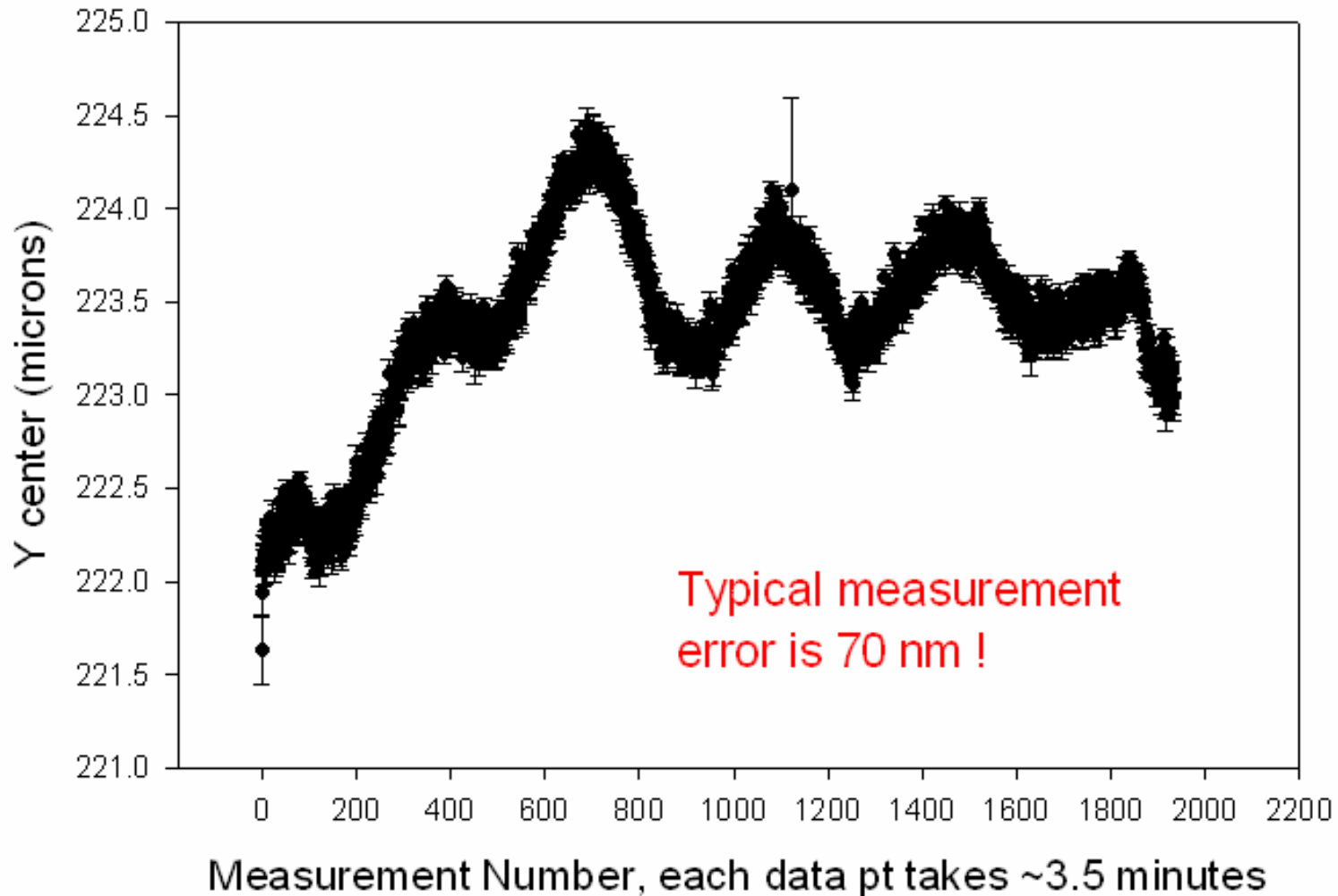

Magnetic Center Movement in RHIC SC Quads

Magnetic Center of RHIC Quads Vs. Excitation

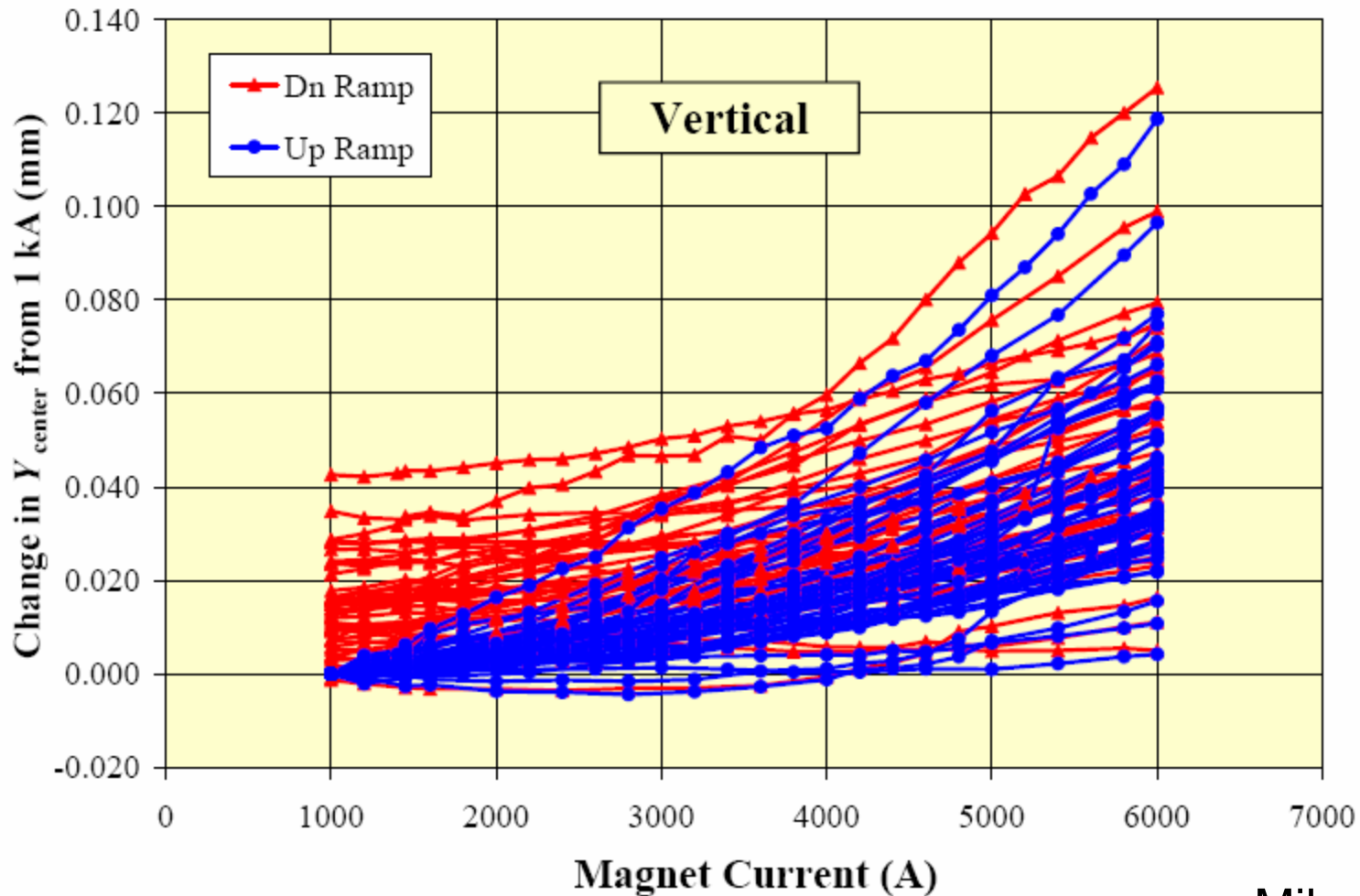

From XFEL quad studies, it appears one can achieve 60 T/m
in a 35 mm radius superferric quad
(i.e., $35 \text{ T/m} * 56 \text{ mm} \sim 60 \text{ T/m} * 35 \text{ mm}$)

The magnetic center in such a iron-dominated quad may be
more stable than in coil-dominated design

Design criteria of XFEL Magnets

Requirements

	Quadrupole	Inner dipole	Outer dipole
Strength	5.6 T	0.006 T·m	0.006 T·m
Current	50 A	50 A	50 A
Temperature	2 K	2 K	2 K
Aperture	112 mm	100 mm	105 mm
Field quality	$ b_6 < 10$ units	-	-
Gradient/Field	35 T/m	0.04 T	0.04 T
Length	200 mm	250 mm	250 mm
Operation	DC	DC	DC

Kashikhin: Pro/Con of Having Quadrupole Package Between Cryomodules

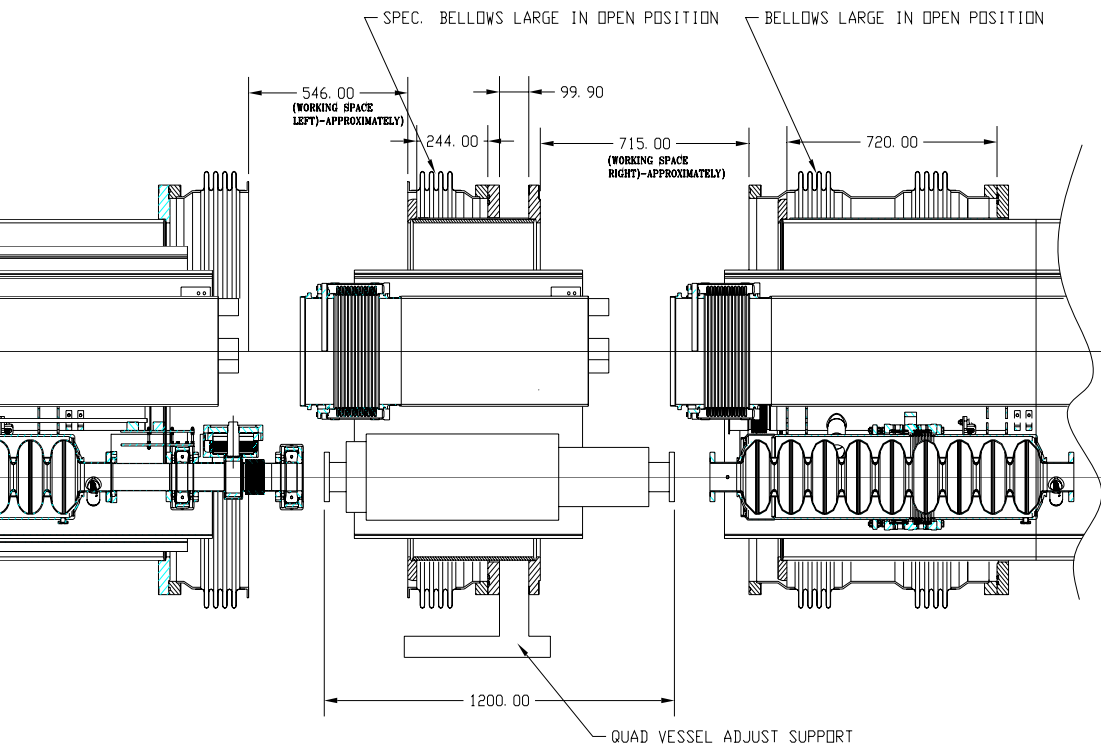

Pros:

- Cryomodules and Quadrupoles having different specs and performance are decoupled
- Cryomodules could be identical
- Manufacturing, assembly and test lines are independent
- Independent design, prototyping and tests
- Could be different (higher) temperature and lower corresponding cryoload
- Lower influence of fringing fields from magnets and current leads
- Feed boxes decoupled from Cryomodule
- Lower quadrupole vibrations
- Higher accuracy of quadrupole positioning
- Easy mechanical position adjustment and long term space stability
- Easy replacement
- Lower fabrication and assembly cost

Cons:

- More connections and higher tunnel installation cost

He Vessel Support in the Cryostat

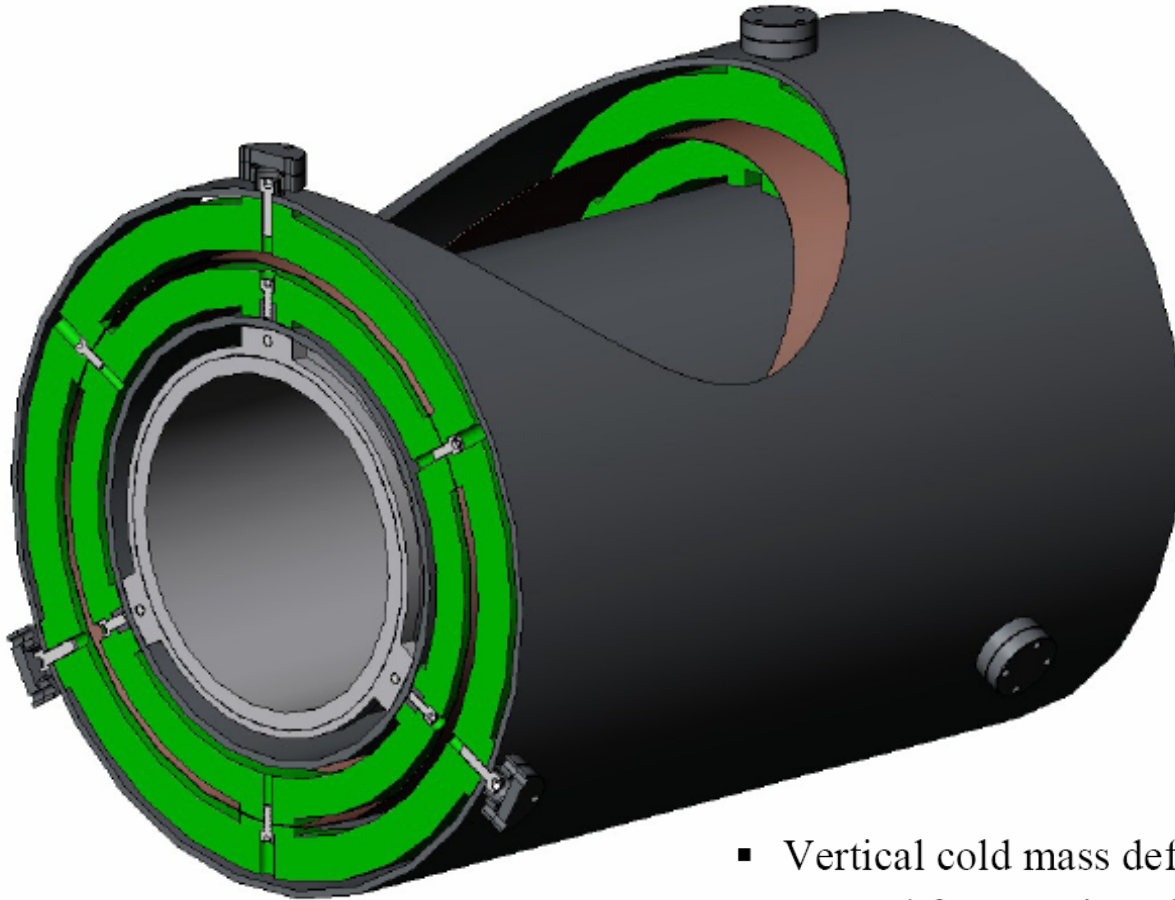

- Vertical cold mass deflection $<0.001''$ due to self-weight.
- Natural frequencies of cold mass and support structure:
 - First axial resonance ~ 72 Hz
 - First lateral resonance ~ 129 Hz
- Conduction heat loads through the G-10 supports:
 - 3.6 W to 80 K (each support)
 - 0.8 W to 4.5 K (each support)

Initial Quad and BPM Alignment

- To make the systematic BPM errors less than the required one micron resolution, want beam centered in BPMs to the 100 micron level
- If the Quad/BPM are on movers (or cryomodules moveable)
 - Only require that the BPM center be aligned to the quad magnetic center to 100 microns – likely ‘bolt’ the two devices together
- If the Quad/BPM are not on movers (baseline) nor cryomodules moveable
 - Also want to quads to be aligned to 100 microns over a betatron wavelength scale ~ 400 m
 - This will be challenging as the quad/bpms are buried in the cryomodules and move (hopefully repeatable) during cooldown

Other Follow-up CM Issue

- XFEL safety exhaust pipe DN 200
 - All safety valves on the cryogenic components in the tunnel will vent into this header. The operation pressure will be at about 1.3 bar absolute. The design pressure will be 20 bar absolute. (In an catastrophic event, the pipe will be connected to the 20 bar system of the helium shield circuits. This is the reason for the 20 bar design.)
 - The pipe will vent into atmosphere via additional exhaust valves at both adjacent shaft buildings. The pipe is a heritage from our original TESLA design. There we introduced this pipe to connect the helium warm gas management of the different helium refrigerators along the tunnel. (In those days we had the illusion that we could avoid safety valves in the tunnel.)