

Design, production and integration issues of the ATLAS Pixel detector

D. Giugni
INFN Sez. Milano

Preface

- I'll talk about the issues related to the design and the production of the ATLAS Pixel detector which is the innermost detector in ATLAS at the LHC at CERN (Geneva).
- The ATLAS Pixel detector is actually installed, connected and its commissioning is taking place right in these days.
- As it happens in all challenging and complex projects people have been working for almost two decades to reach this point and we are now all looking forward for the first physics event.
- This is therefore a very exciting period in which the efforts of hundreds of people along many years turn into a real working detector.

I would like to try to explain how this was made technically possible hoping that our experience could be useful to people that will be working in the future at even more challenging detectors.



Outline

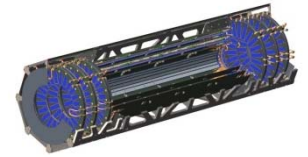

- Description of the mechanical structures that hold the sensors: Thermal management, materials and construction techniques.
- Specs comparison defined at the beginning of the design process with what obtained “as built”.
- Overview of the services required to power, readout and cool the detector. You will see how the powering scheme impacts severely to the performance of the detector.
- Problems encountered during the production and solution adopted
 - Corrosion, cooling performances, tightness
 - Innermost low mass cable failure
 - Poor thermal properties
 - Corrosion again !!!
- Integration and installation sequence, commissioning.



Focusing on the detector



Muon Detectors

Electromagnetic Calorimeters

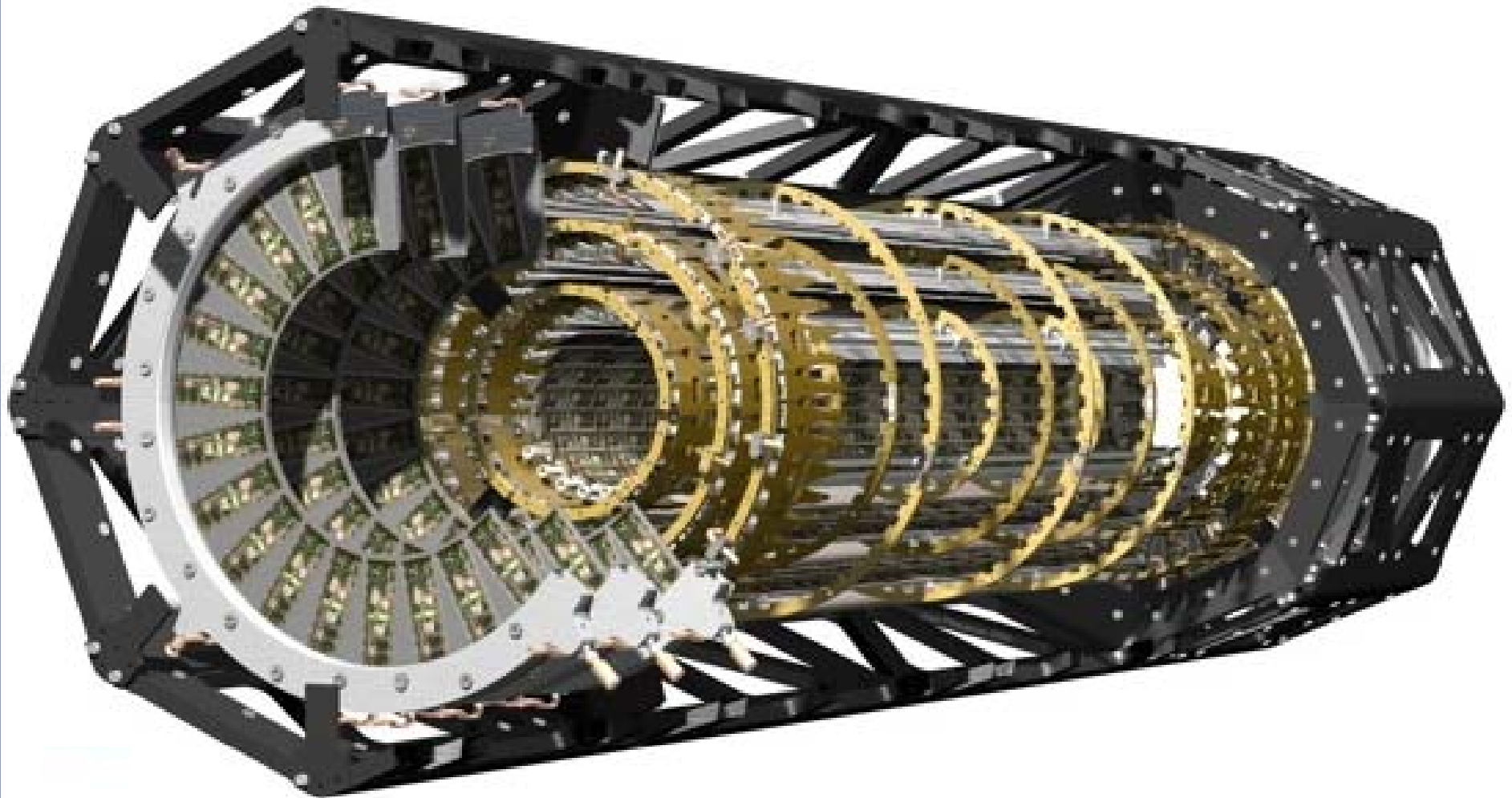

Barrel Toroid

Inner Detector

Hadronic Calorimeters

Shielding



Detector Layout

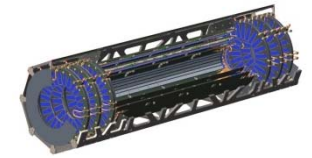

- Services reach the detector via a complex chain ~160m long. The part closest to the detector has aluminum conductors wires to reduce the mass. Electrical services provide the power lines while the signal is converted rather close to the modules and sent out optically. This happens in the SQPs (Services Quarter Panels).
- Cooling is provided by a fluorocarbon (C3F8) evaporative system distributed over 88 quasi-independent cooling lines that remove the heat generated by the electronic and by the leakage current in the sensors.

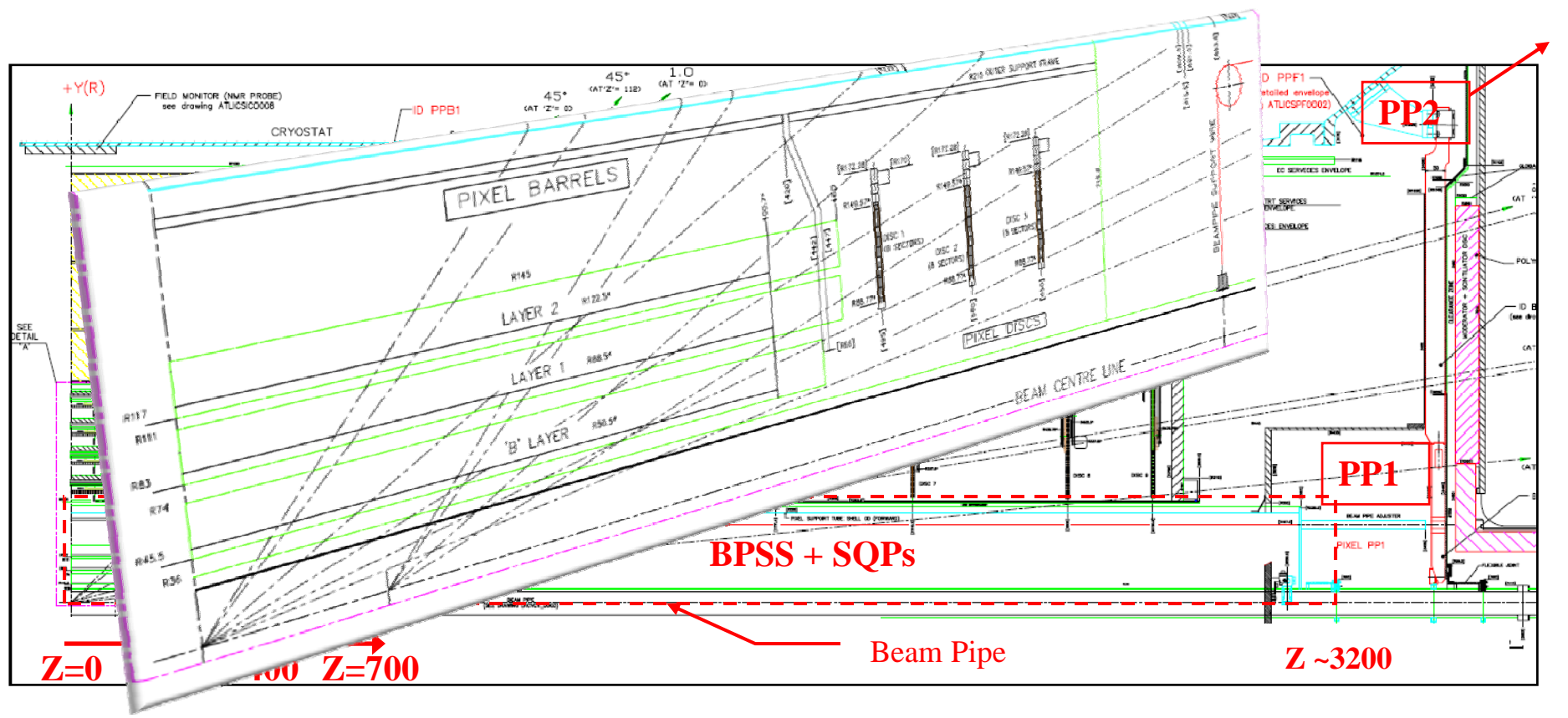



Pixel Package

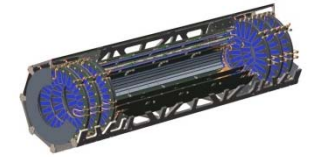

- Beam Pipe is part of the detector and it is integrated on surface. Innermost layer (B-layer) is clamped around the Beryllium beam pipe and it is supported by the BPSS (beam pipe service support) that also support the SQP's. The resulting "package": detector, SQP's., BPSS and Beam Pipe are moved in one go to the pit into the SCT (Silicon Tracker)

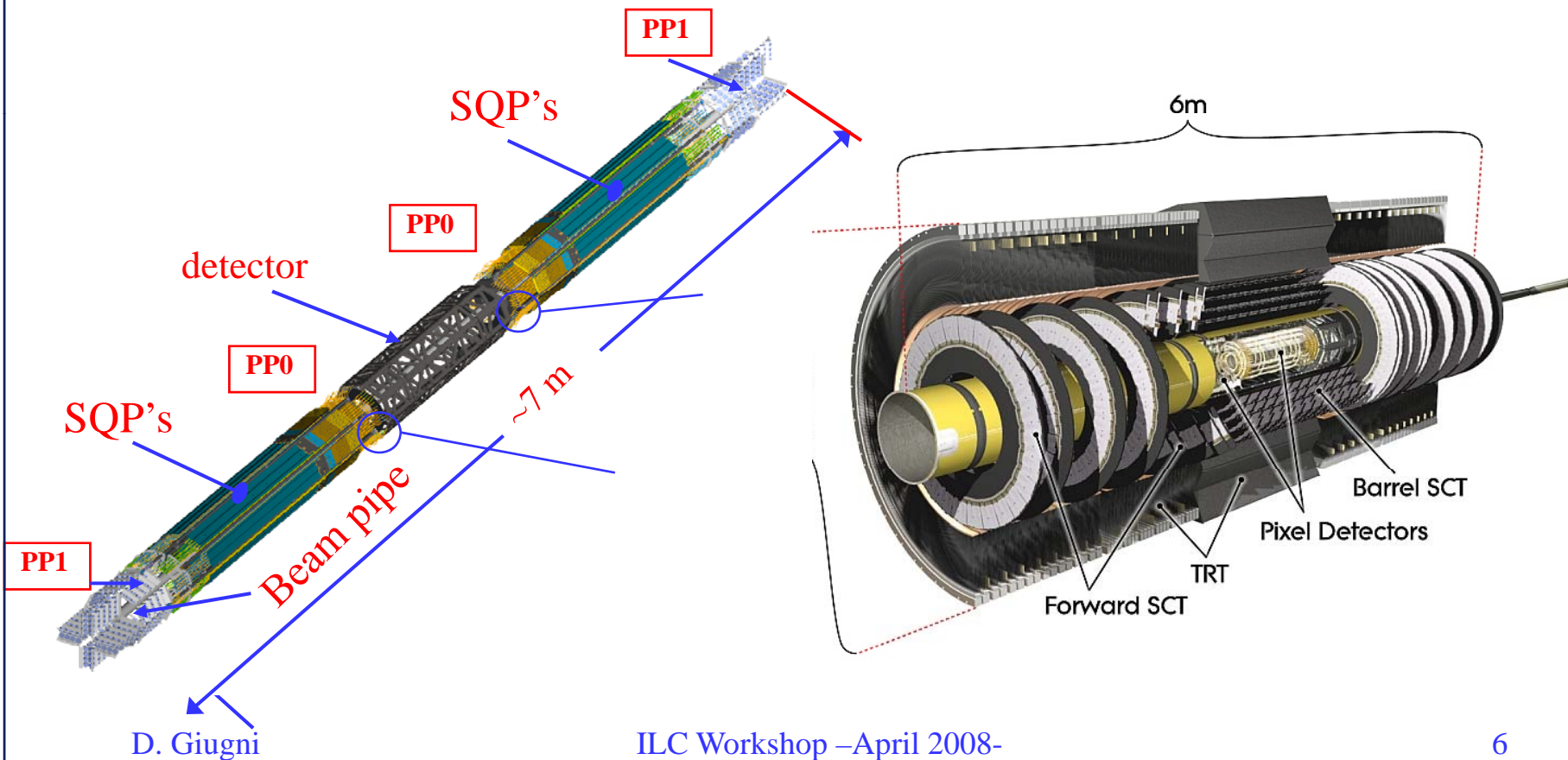



The numbers of the detector

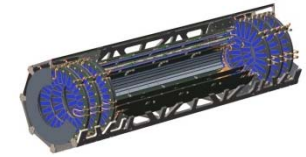

	BARREL			ENDCAPS			TOTAL
	Layer 2	Layer 1	B-layer	Disc 1	Disc 1	Disc 1	
Radius [mm]	122.5	88.5	50.5	-	-	-	
Z [mm]	-	-	-	+/- 495	+/- 580	+/- 650	
# Bi-staves	26	19	11	-	-	-	56
# Staves	52	38	22	-	-	-	112
# Bi-Sectors	-	-	-	2 x 4	2 x 4	2 x 4	24
# Sectors	-	-	-	2 x 8	2 x 8	2 x 8	48
# Modules	676	494	286	2 x 48=96	2 x 48=96	2 x 48=96	1456+288=1744
# Pixels	31.15*10 ⁶	22.76*10 ⁶	13.17*10 ⁶	2 x 2.212*10 ⁶	2 x 2.212*10 ⁶	2 x 2.212*10 ⁶	80.36*10 ⁶
# Cooling loops	26	19	11	2 x 4	2 x 4	2 x 4	56+24+ [8] = 88
Cooling power	220W x 56= 12.3 KW			110W x 24= 2.64 KW			14.9KW+ [1.7KW]

- To remove the heat generated by the electronics at the temperature at which the sensor can handle the radiation dose, the cooling system is EVAPORATIVE and the evaporation temperature set at -25C
- The temperature sensor becomes critical at the end of the life of the detector (~10 years at nominal luminosity) when the leakage current contributes significantly at the total power generated by the modules.



Expected dose in the detector

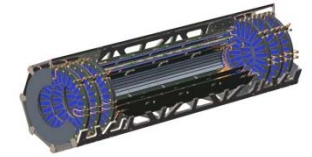

The total ionization dose on the closest structures at $\mathcal{L}=10^{34} \text{ cm}^{-2}\cdot\text{s}^{-1}$ for 10^7 s/year is:

500KGy [50Mrad]

Jan03 Base (24620) - Ionization Dose, Gy/Yr (TID)

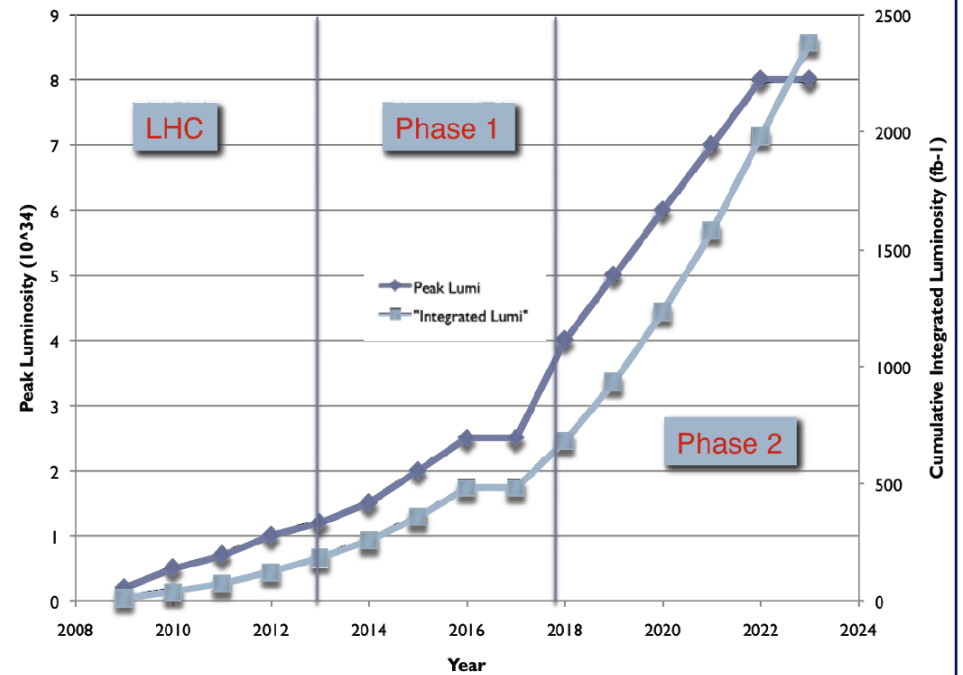
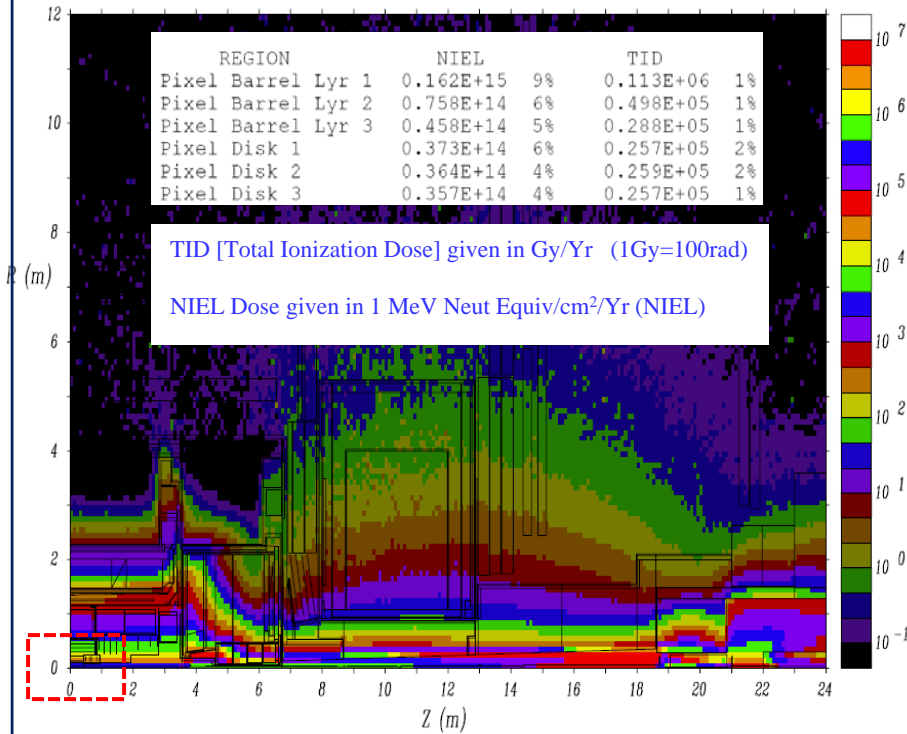



Mechanical structure of the detector

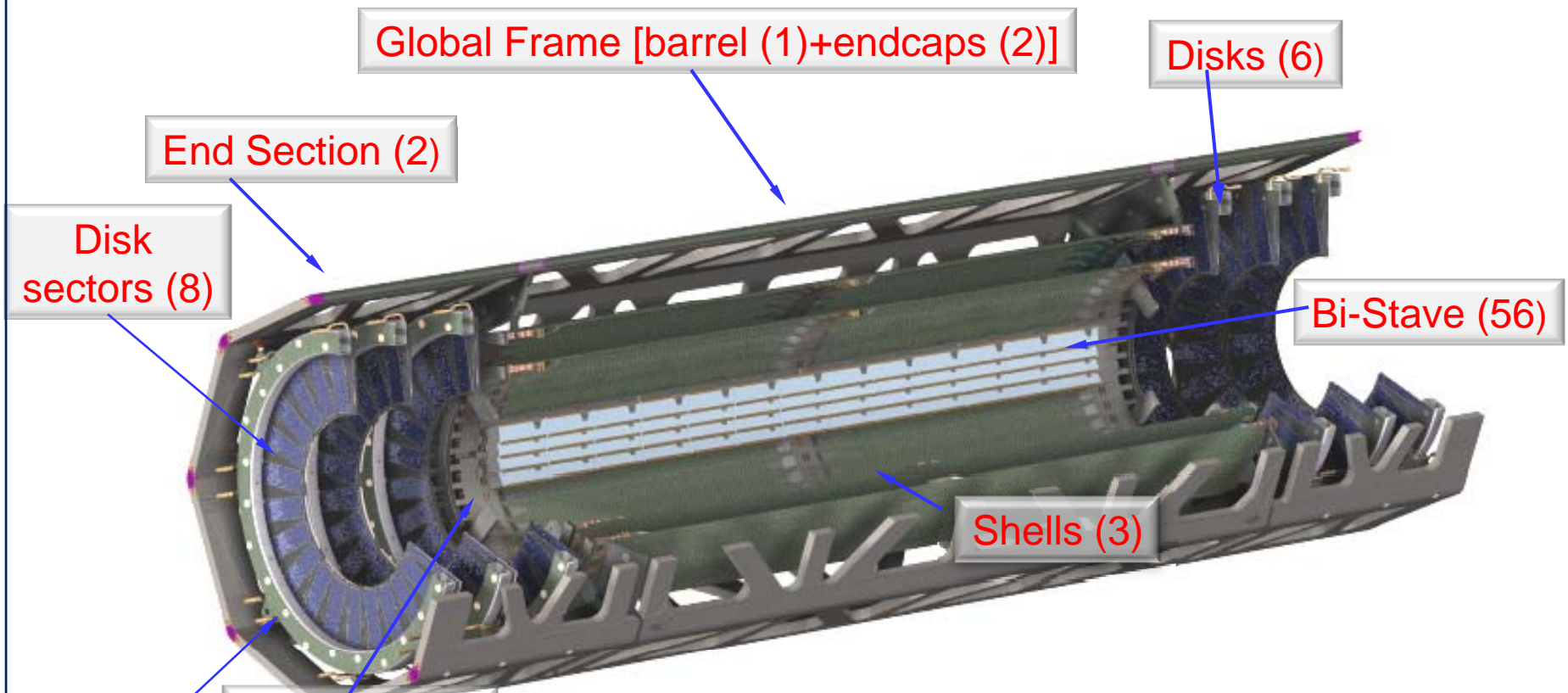
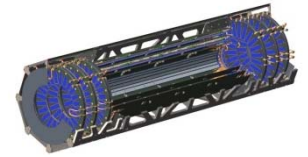

	<i>STABILITY BUDGET [μm]</i>			
	<i>Global Frame</i>	<i>Shell</i>	<i>Stave</i>	<i>TOTAL</i>
Radial motion "R"	5	5	40	50
Tangential motion- "φ"	1.7	1.7	13.6	17
Axial motion-"Z"	10	10	80	100



Global Frame

- It is an high modulus carbon fibers honeycomb construction.
- Performances for a 28.9Kg total mass detector:
 - Gravitational sag over 4 supports: 11.5 μ m
 - Mechanical noise rejection: Induced displacement excitation in the detector is <10 μ m with an excitation of 0.01g . Resonance mode 89Hz
 - Torsion stiffness (in case of a misalignment of the fourth support): 53 μ m
 - Deformation induced by the cooling (-30C) 1.4 μ m/C

Global Support Frame Item	Material
Outer Frame	
Sandwich Facings	YSH90 unitape with RS3 or EX1515 cyanate ester resin, quasi-isotropic laminate
Honeycomb Core	XN50 woven cloth/cyanate ester resin, by YLA Cellular, 6.35mm cell, density 48kg/m ³
Vertex Corner Mounts (frame section connections)	YSH50 woven cloth and RS3 cyanate ester resin laminate
Corner Tubes	YSH90 unitape and RS3 cyanate ester resin
Corner Splice	YSH90 unitape and RS3 cyanate ester resin
Vertex Joint Inserts	Aluminum

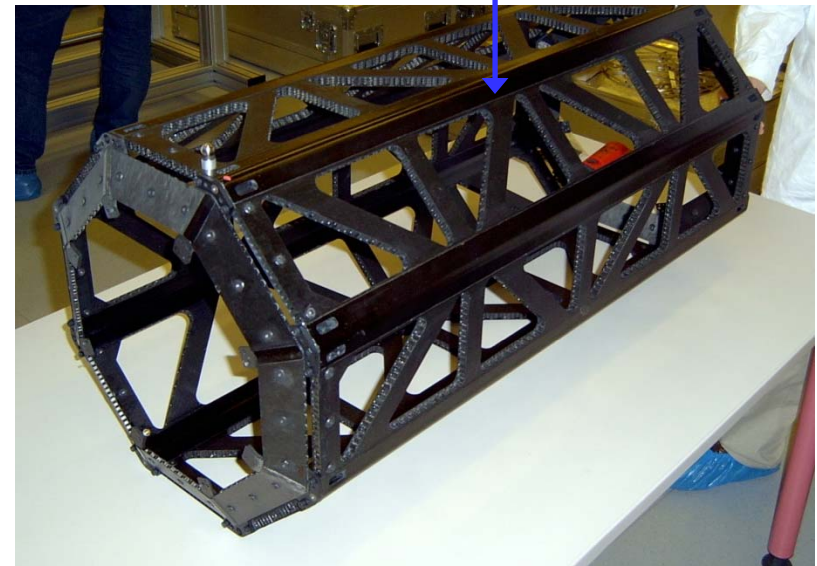
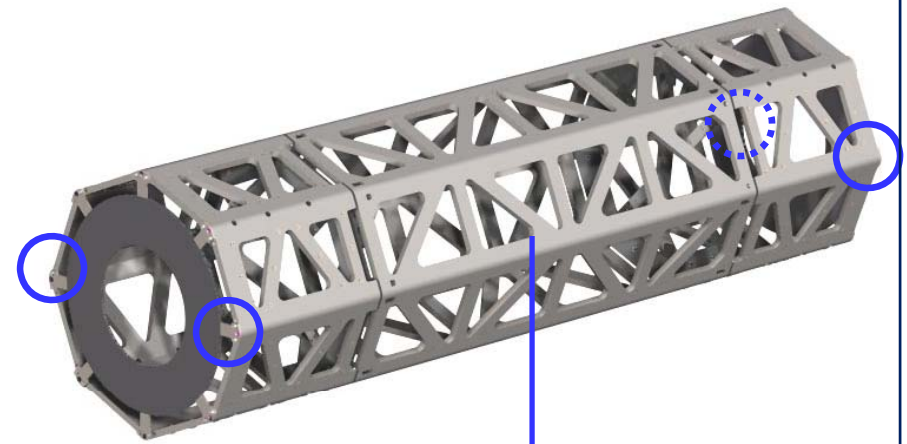

Above pictures show the Global Frame during the “dry fit” in 2004.

Note the octagonal section and the cutout to reduce the mass



Barrel Shell

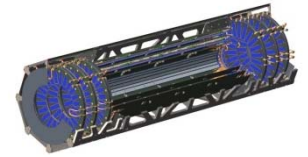

- Barrel shell provides the *interface* to the local support that finally supports the pixel sensors and the FE electronics (modules) .
- As said there are *three coaxial shells* that are mechanical connected to the Global Frame by means of the Support Cones.
- Specs and material :
 - *Laminate* YS80/EX1515 six plies (0/60°/-60°)_{s2}
 - *Geometrical Accuracy* at the interfaces: 50μm
 - *Stability*
 - Radial $R < 5\mu\text{m}$
 - Tangential $\varphi < 1.7\mu\text{m}$
 - Axial “Z” $< 10\mu\text{m}$

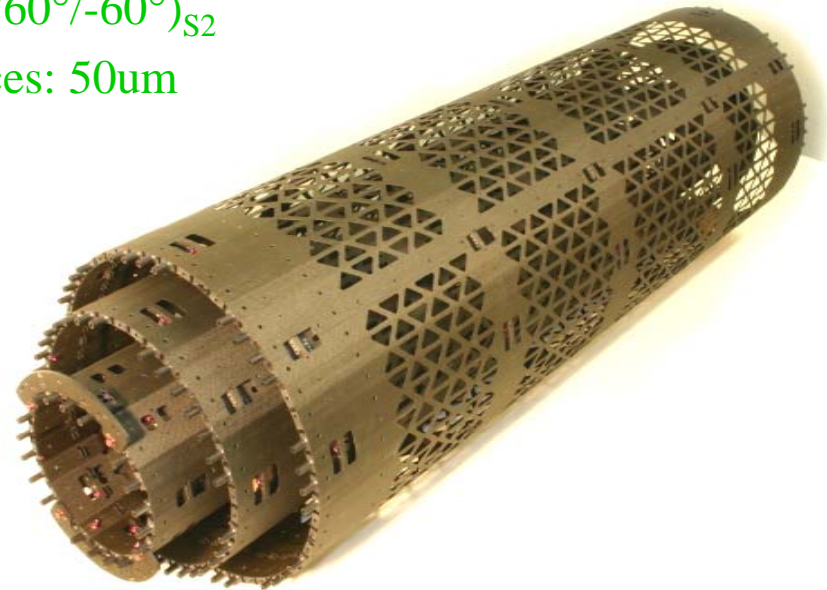



Survey of the shell “as built”

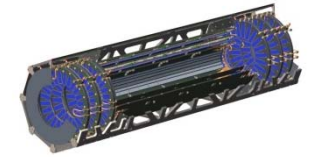

- Green arrows set the displacement with the tolerance: $50\mu\text{m}$
- Blue arrow is “slightly” off tolerance by $10\mu\text{m}$.

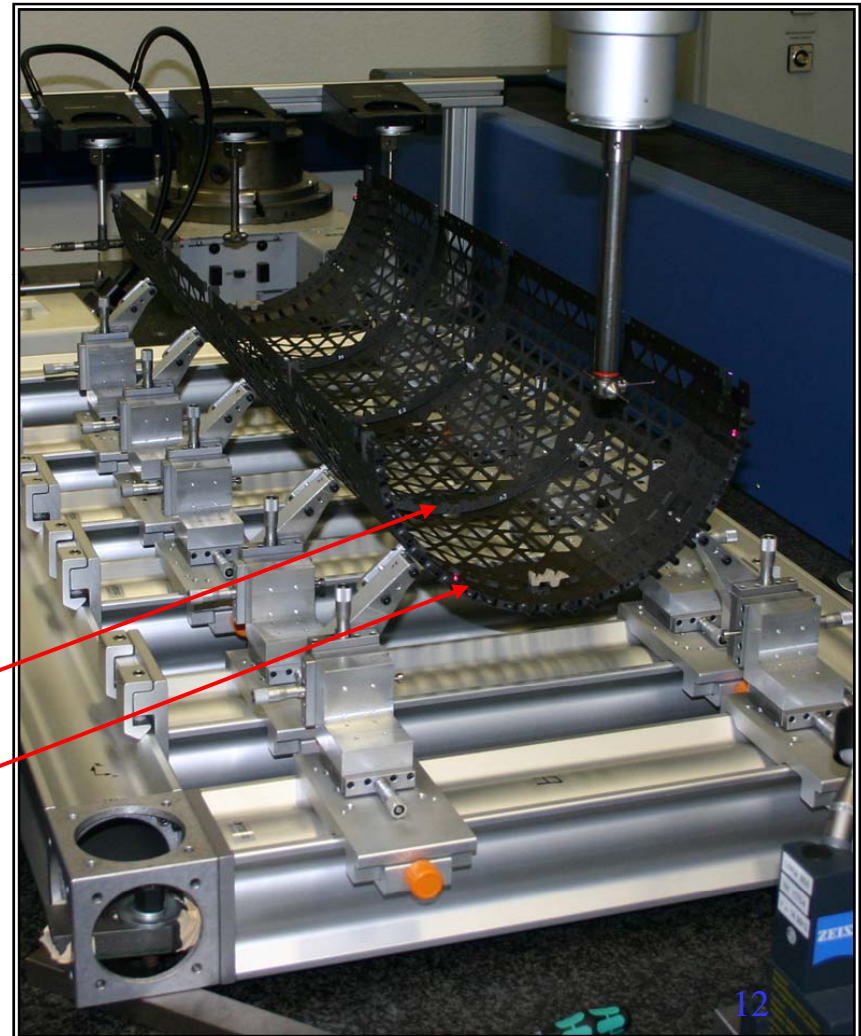
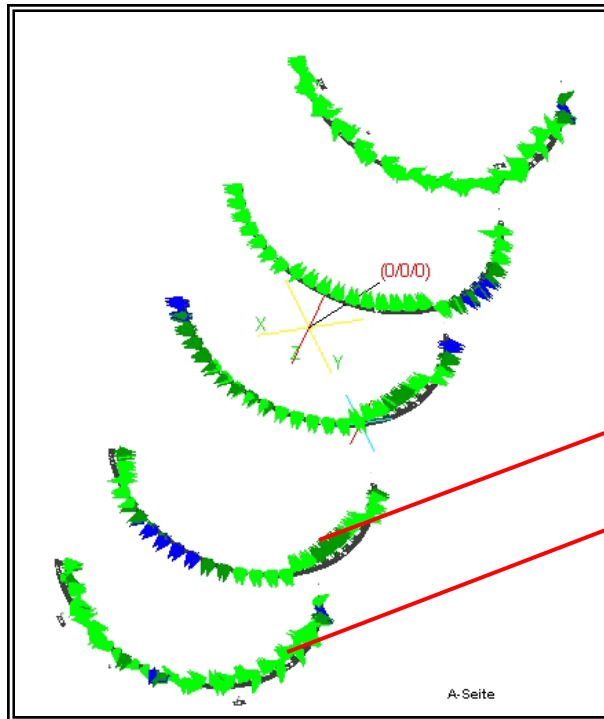



Survey of the shell “as built” under load

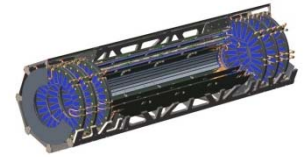

To survey the deformation under load a weight of 110g has been added to the Shell:

$$52\text{staves} \times 110\text{g} = 5720\text{g}$$

Results (Max. displacements)

- B-layer = 16 μm
- layer 1 = 18 μm
- layer 2 = 15 μm

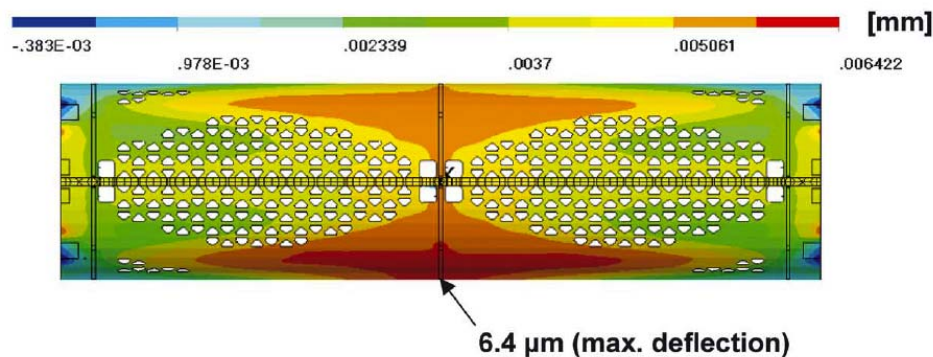
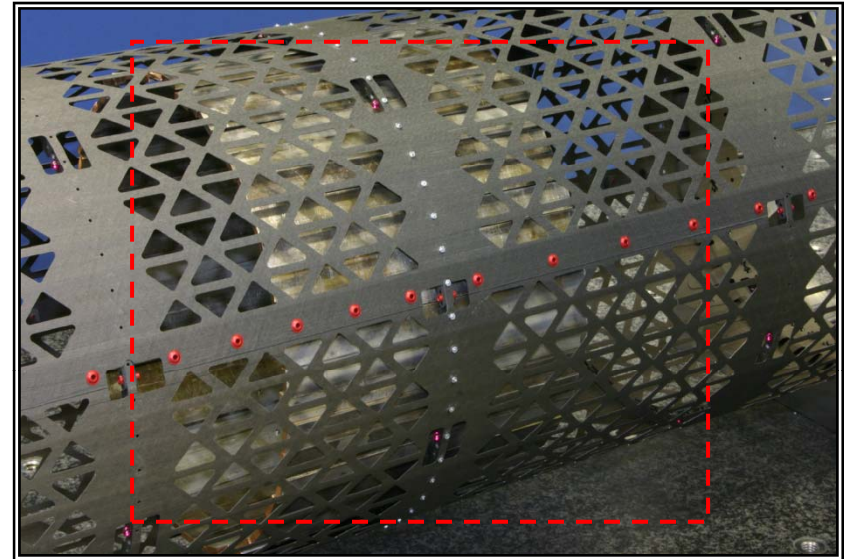



Local support –stave-

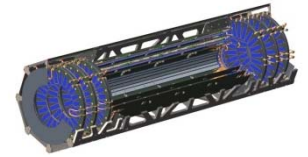

Stave is the local support of the pixel modules and it has two main functions:

- Support the modules.
- Remove the heat generated by the readout.
maintaining the temperature of the sensor $< 0^{\circ}\text{C}$.



Stave/Bi-stave

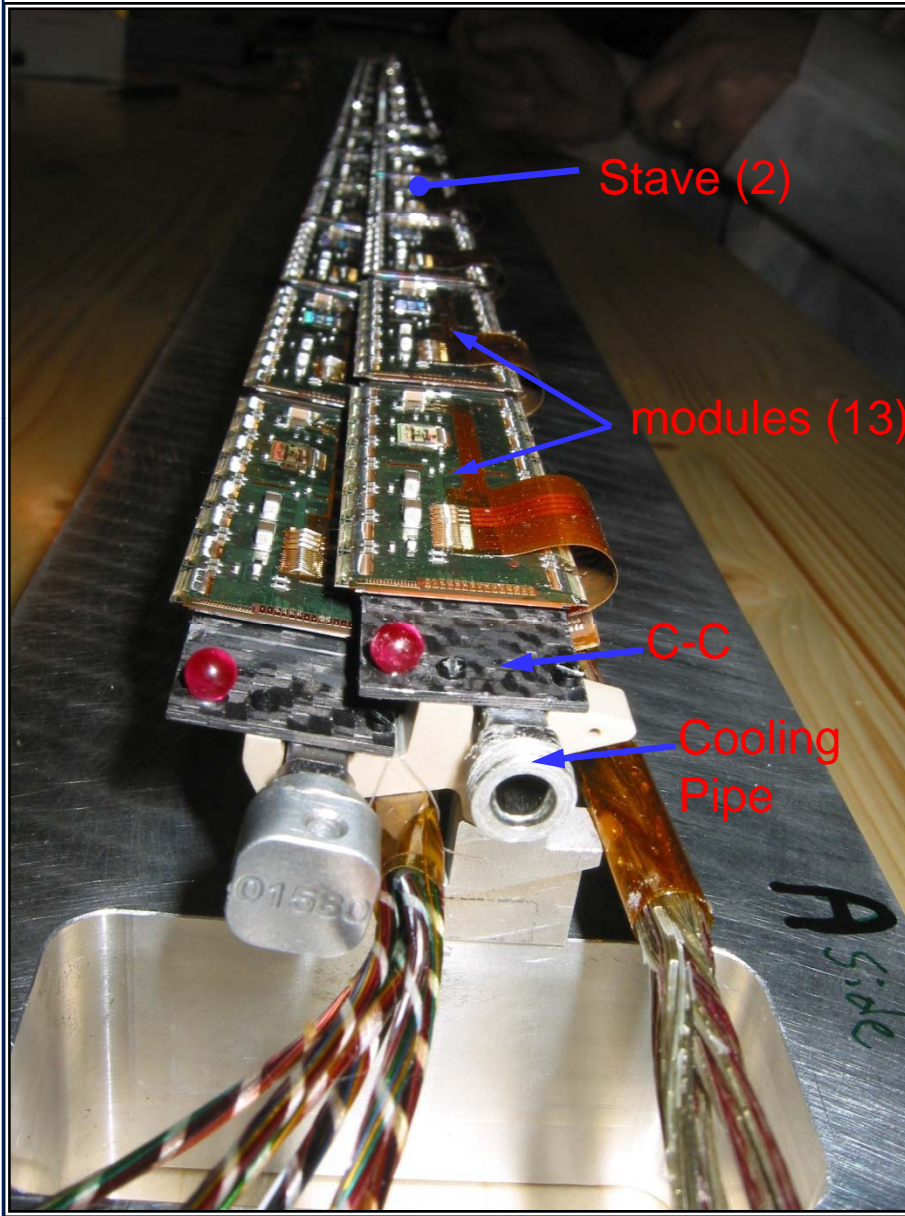
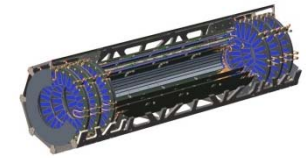

- 112 staves in total sharing a single cooling loop in a Bi-stave.
- Cooling is evaporative fluorocarbon fixed flow system (see later). Fluid evaporates in the pipe underneath the modules.

The design of the stave is optimized to minimize the thermal impedance and maximize the geometrical stability.

- The mechanical structure is based on C-C material. As known in the standard composite material the thermal properties (thermal conductivity [W/m.K]) are excellent in plane but very poor in the transverse direction where it is dominated by the resin system.
- To enhance the thermal properties in the transversal direction the matrix of the laminate is "graphitized" at high temperature. The thermal conductivity K can be of the order of $\sim 30\text{W/mK}$
- Also the CTE (Coeff. Thermal Expansion) is very low matching the requirements for the geometrical stability vs. temperature.



Digression on the cooling system

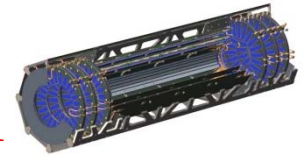

- Flu
- 1 l
- T_{ev}
- P_{loc}
- Cr
- P_{dro}
- wa
- ΔT
- P_{dro}

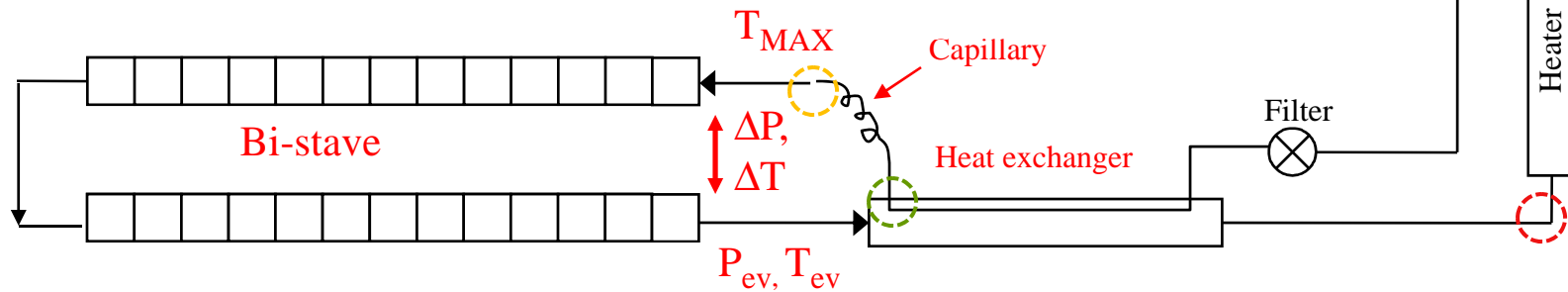
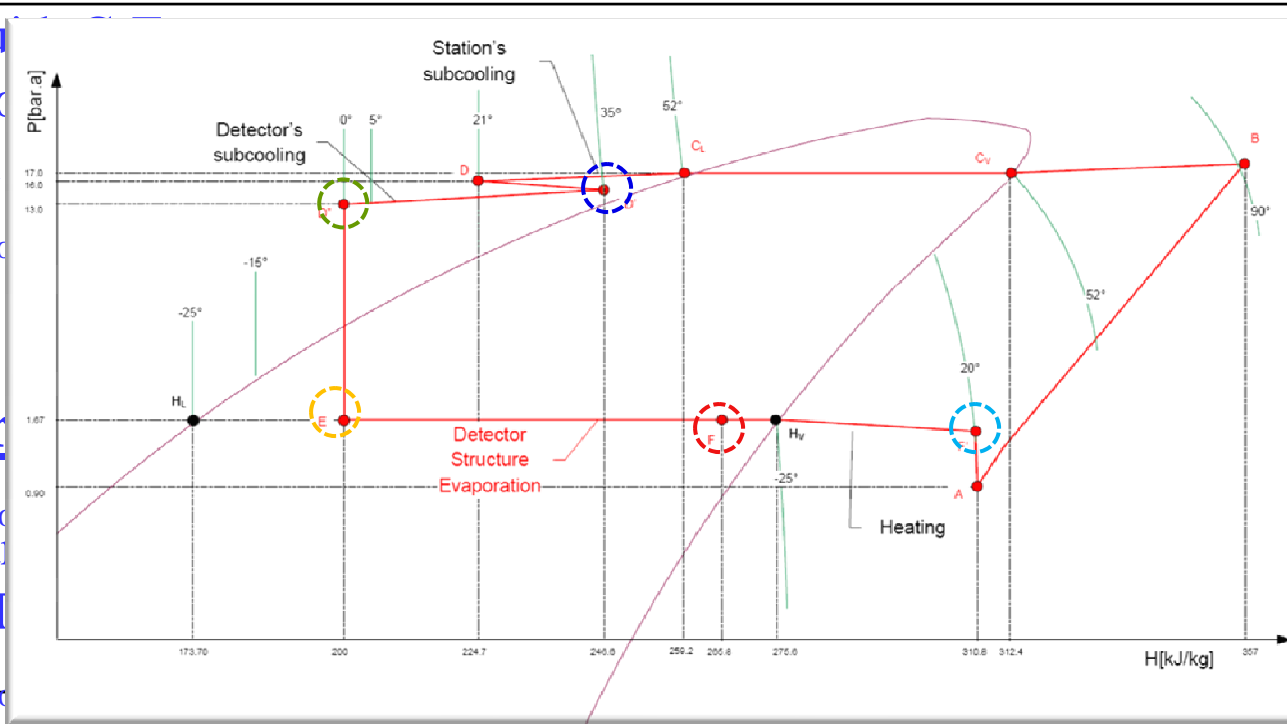



Designing specs for the stave

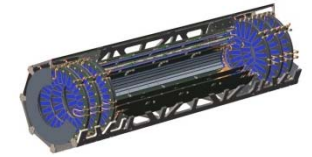

Thermal (related) Properties

- ΔT from coolant to face of local support $<15\text{ }^{\circ}\text{C}$
- Operating pressure at full Power $2\text{ bar}(a)$
- Maximum pressure drop across stave/sector at Full Power $<200\text{mbar}$
- Minimum temperature of Local Supports and Modules on start-up of cooling $-35\text{ }^{\circ}\text{C}$
- Once-per-lifetime pressure fault for one hour 8 bar
- Maximum leak rate of each cooling connection $10^{-7}\text{ atm.cc}^{-1}\text{.s}^{-1}$

Geometric Properties

- Max deviation from nominal shape (along Z) 0.25mm
- Max torsion angle of each step $\pm 0.32\text{deg}$
- Single step planarity 0.05 mm

“Physic” related Properties

- Total dose 50 Mrad
- Radiation length (active) region – goal- $\leq 0.7\% X_0$



Geometrical Accuracy achieved

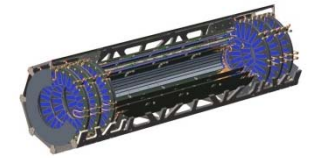

The resulting geometrical accuracy after the full production is like :

- *Max deviation from nominal shape*
- *Max torsion angle of each step*
- *Step planarity*

mean over the population	Specs
0.173mm	[0.25mm]
0.329deg	[0.32deg]
0.063mm	[0.05mm]

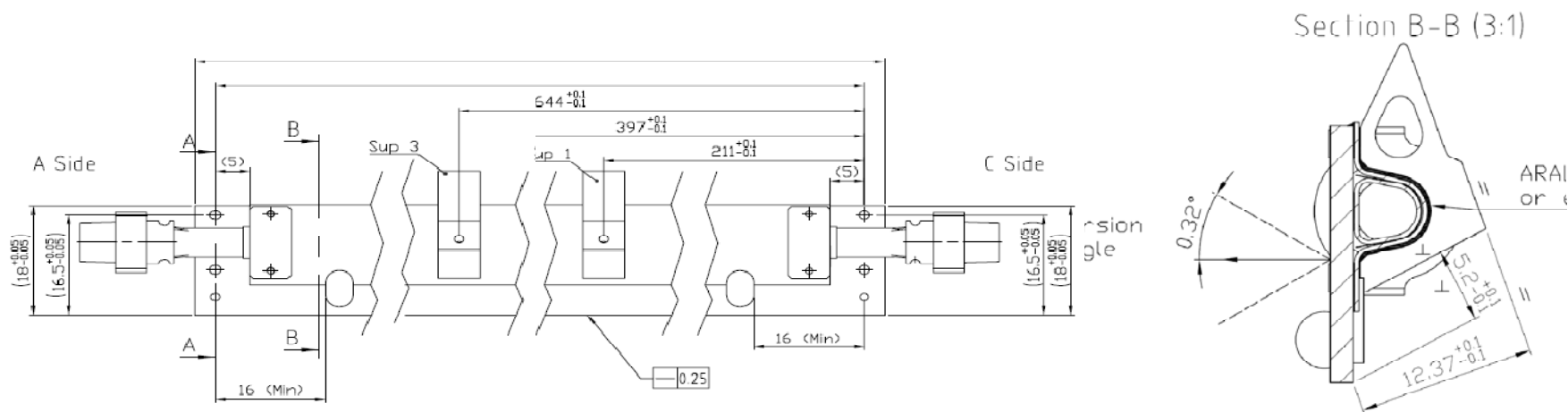



Accuracy and Survey: Reference system

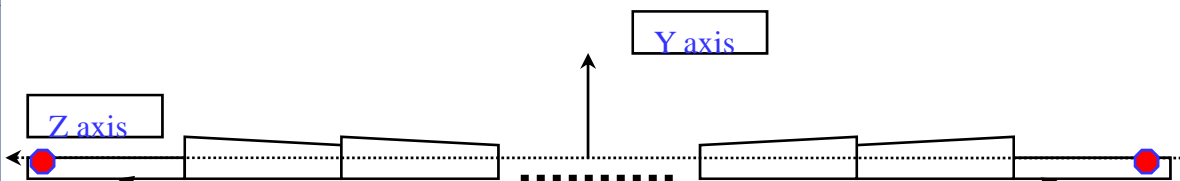
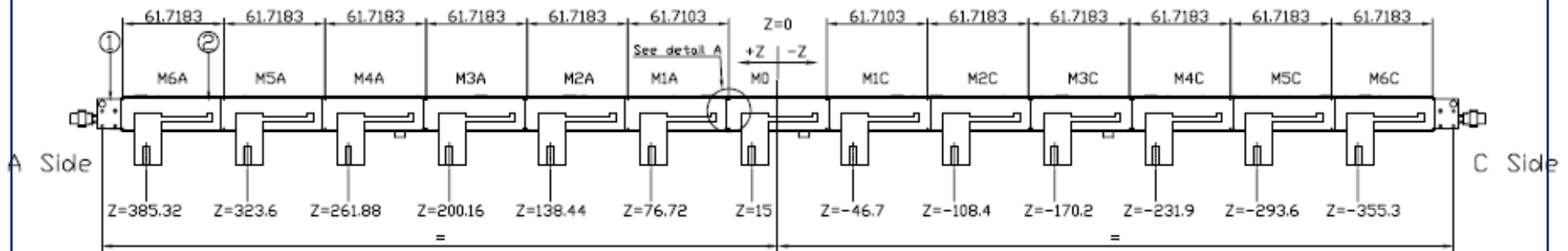
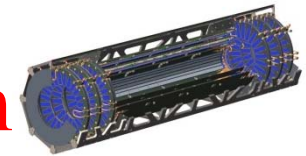

Reference plates

Rubyballs

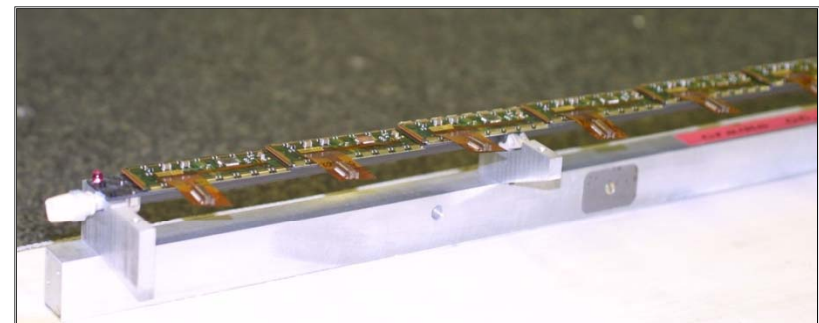

- 1) The local reference system is built via ruby balls and ref planes
- 2) Modules are loaded and surveyed with respect to the local ref system
- 3) Stave are surveyed with respect to the global supports

Z axis

X axis



Accuracy and Survey

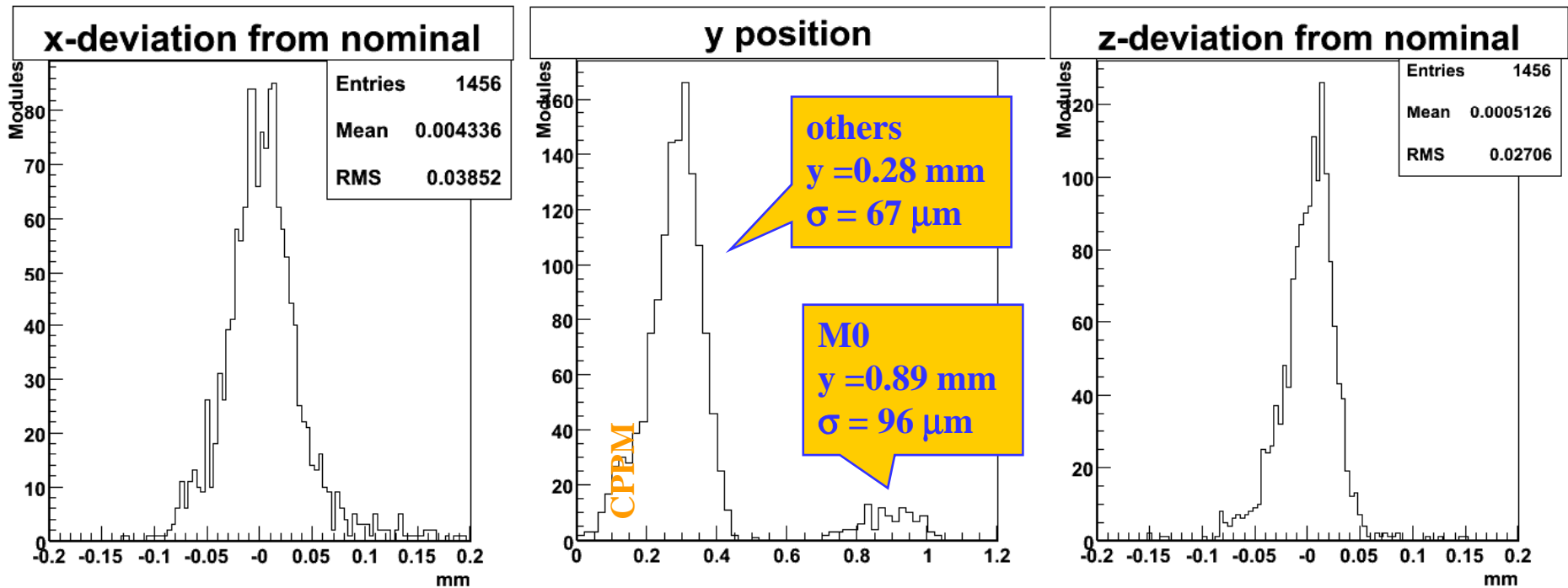
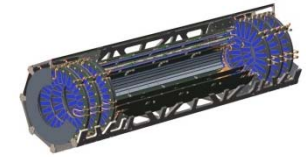

MODULE DEPOSITION ACCURACY on LOCAL SUPPORTS

- *In-plane* (Φ) deposition accuracy is 30-40 μm
- *Off-plane* (R) is about $\sim 100 \mu\text{m}$
- *Along Z* accuracy is $\sim 30 \mu\text{m}$



Barrel Survey data: stave position

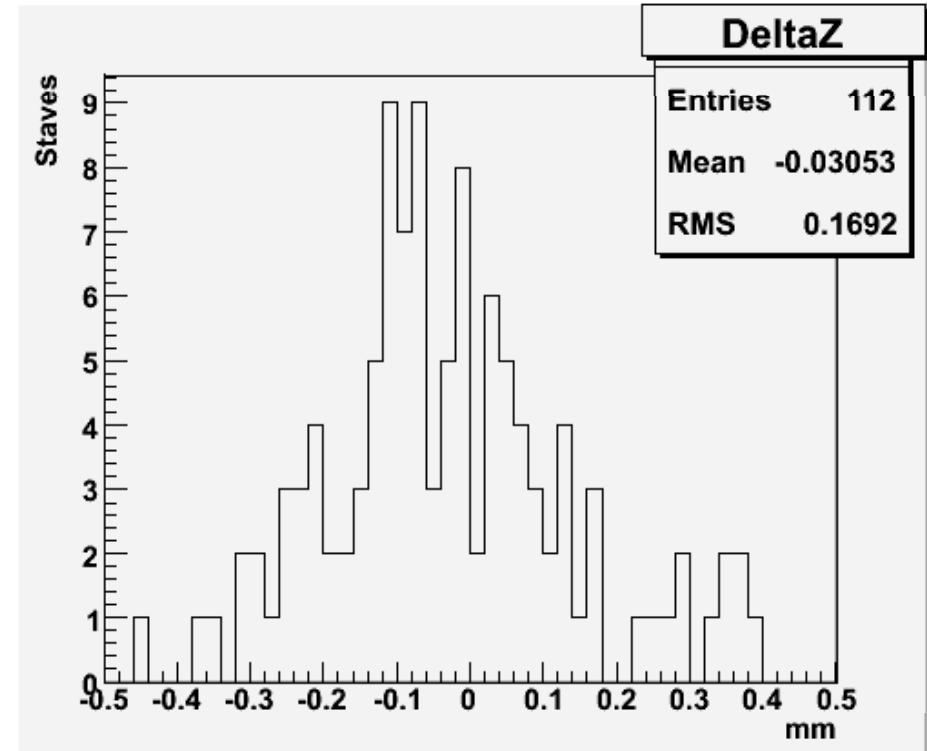
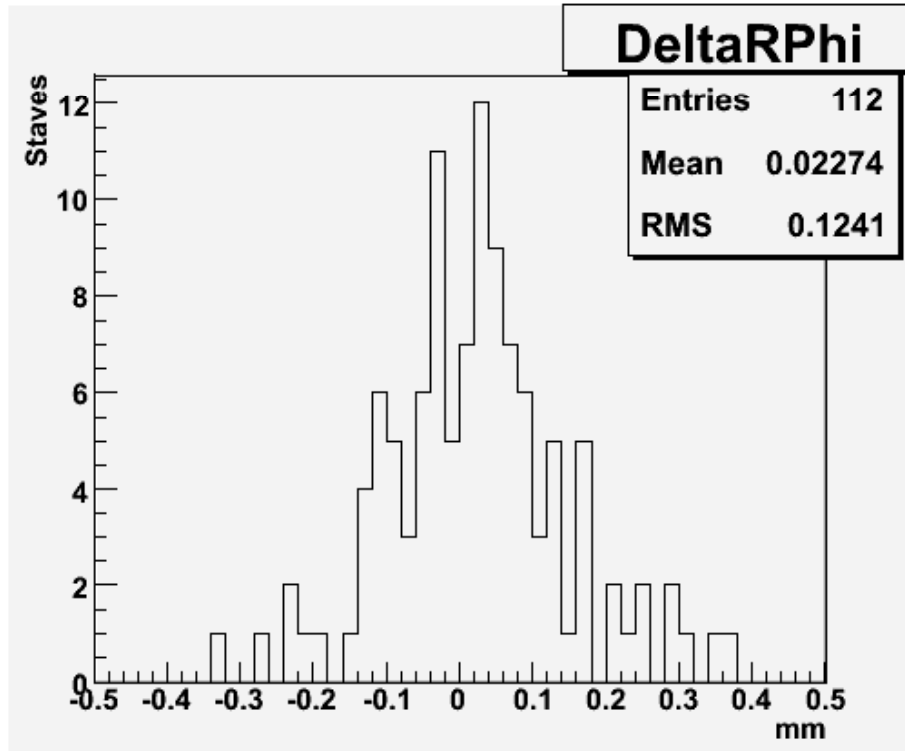
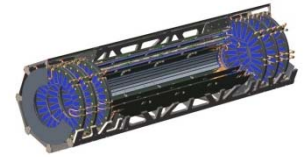

- R.M.S.: 120, 170 μm
- CMM accuracy is $\sim 8 \mu\text{m}$, match between CMM and staves is $20 \mu\text{m}$



Detector mass estimate

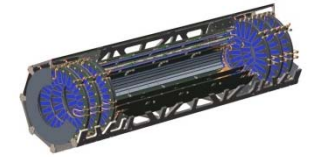

Tracking the mass and the elements that go into the detector is mandatory to know the radiation length as function of η

Plot at the bottom shows the contribution to the X_0 of the various parts of the detector as it will be published soon. In the barrel region we are about $\sim 10\% X_0$

Nevertheless a rigorous review of the mass is on going and the bottom-up will be compared with the top-down estimate: good book keeping is essential. This will certainly change the estimate

Barrel	21.8 Kg
EndCaps	2 x 3.5 Kg
Services	169.2Kg
=====	
Total Package	196.9Kg

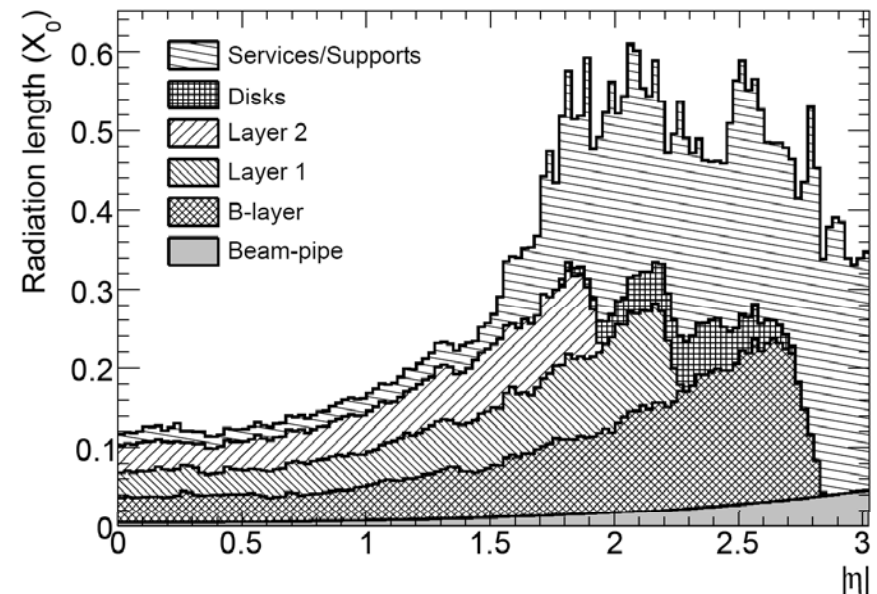

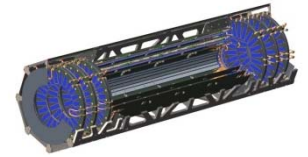

SERVICES



Services Overview

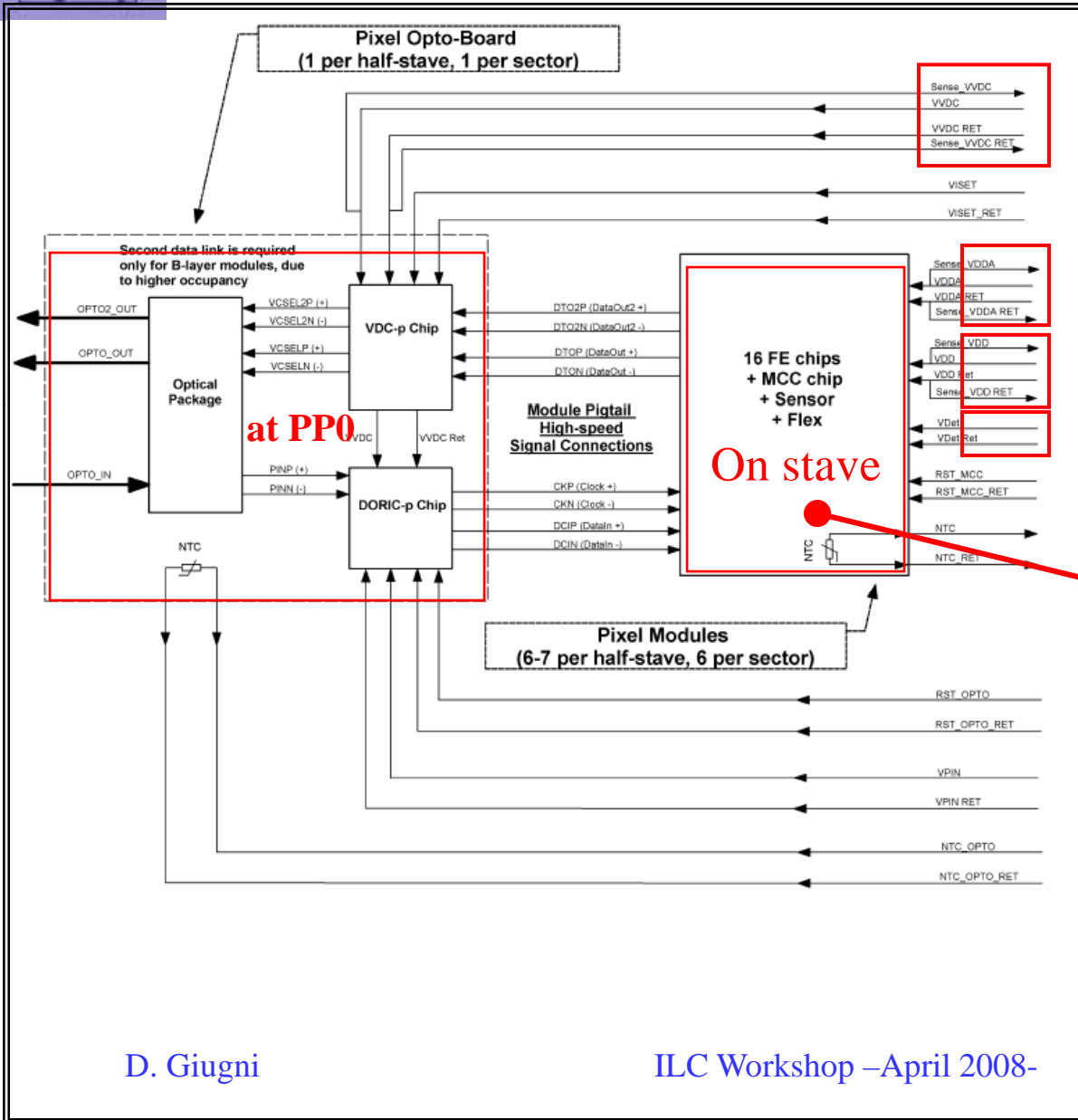
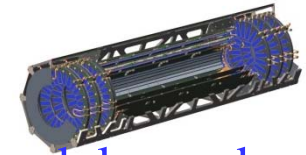

- Each single module needs three different power voltages (two LV and one HV). The optoconverter needs another LV line.
- The total number of connection needed to operate the module is 22 and...

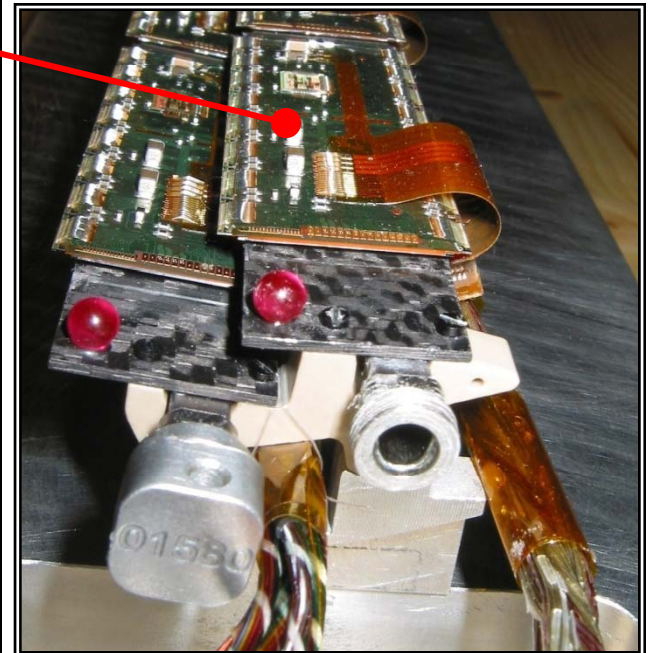



Independent powering

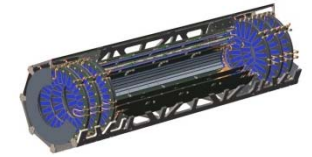

It's like each single light in the Christmas tree is powered individually with dedicated voltage regulator, power supply and cable.

- Power efficiency is low: To provide ~15KW to the active parts in the detector requires more than 30KW. Efficiency is about the 50%
- Mass belonging to the services is significant.

This approach will be soon abandoned for the detector of the next generation in favour of serial/parallel powering

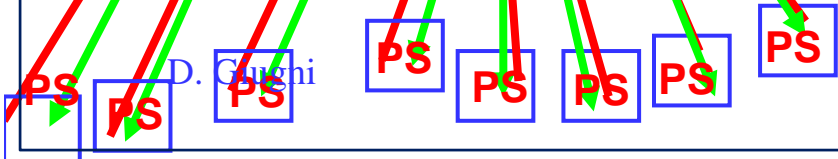

D. Guigni



Services Overview

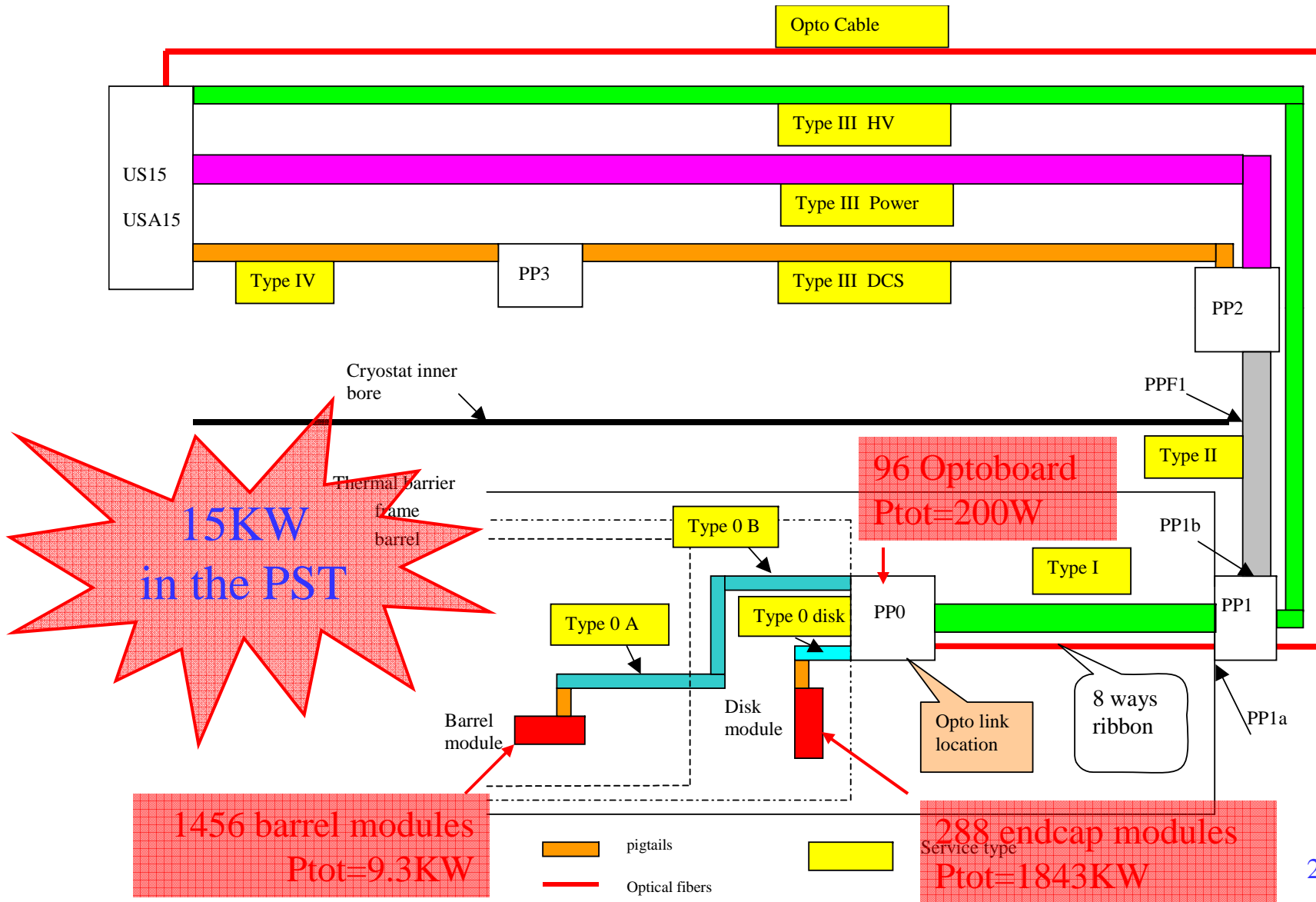
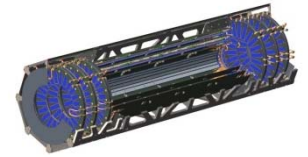

**15KW
in the PST**

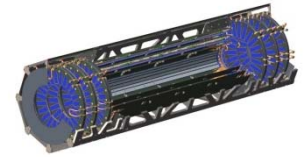

... often things go wrong



Corrosion in the cooling channel

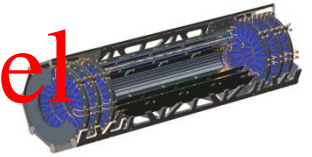

- Originally the cooling channel was a D-shape an Alu [6061-T6] pipe, 200 μ m thick. Fitting is brazed with a silver alloy 3.5AgSn after nickel plating of around 10 μ m .
This generates a galvanic couple at the interface that could, in presence of an electrolyte and defects in the nickelization, trigger a fast corrosion process.
- The corrosion appears with the presence of white aluminum oxide and significant erosion of the aluminum alloy through the pipe wall.

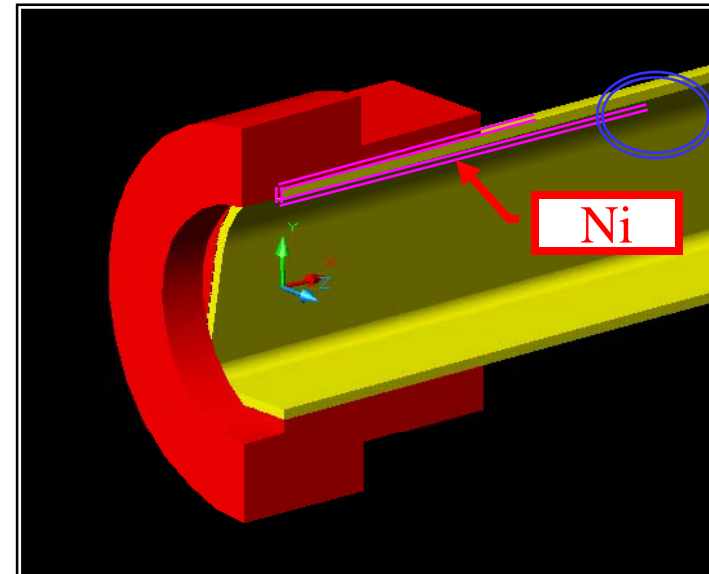
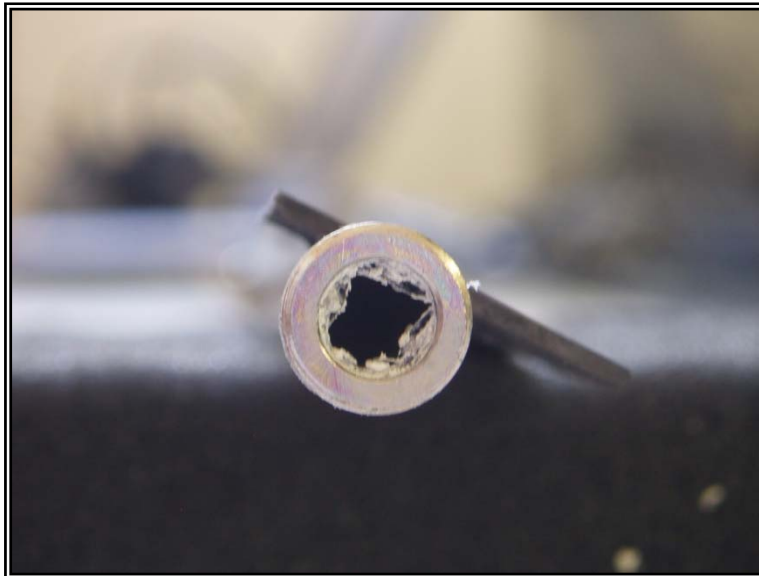



Corrosion effects



On the right picture the corrosion generated a passing through hole in the pipe and consequent loss of tightness.

Bottom picture shows a typical pitting phenomena also induced by the galvanic couple shown in the sectioning plane.

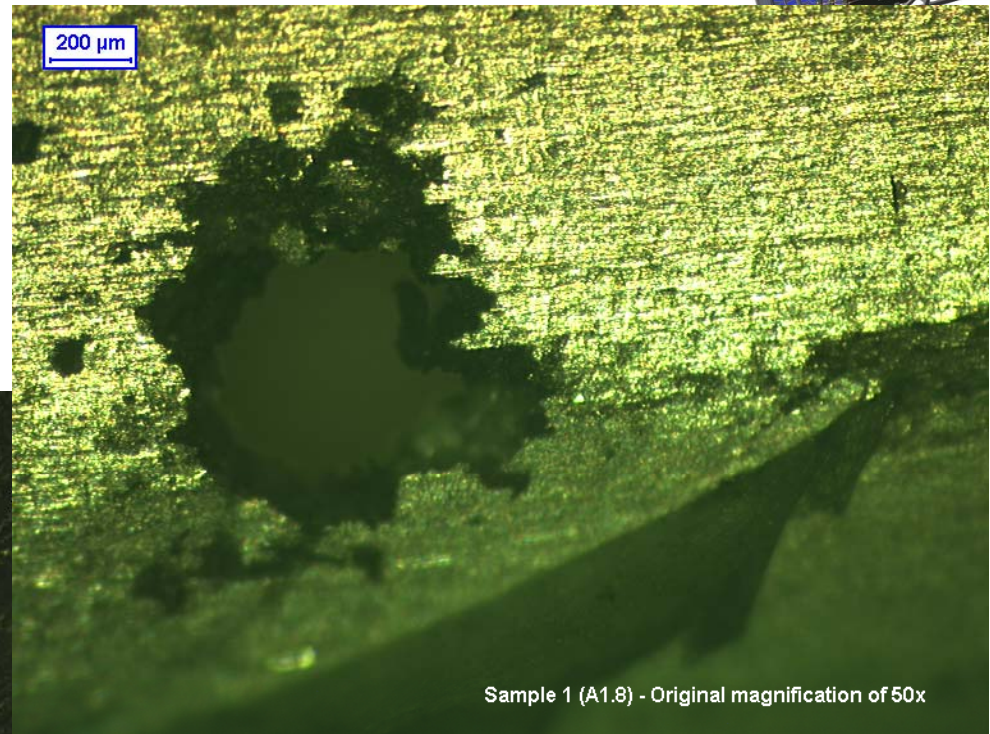

Sample 1 (A1.8) - Original magnification of 50x

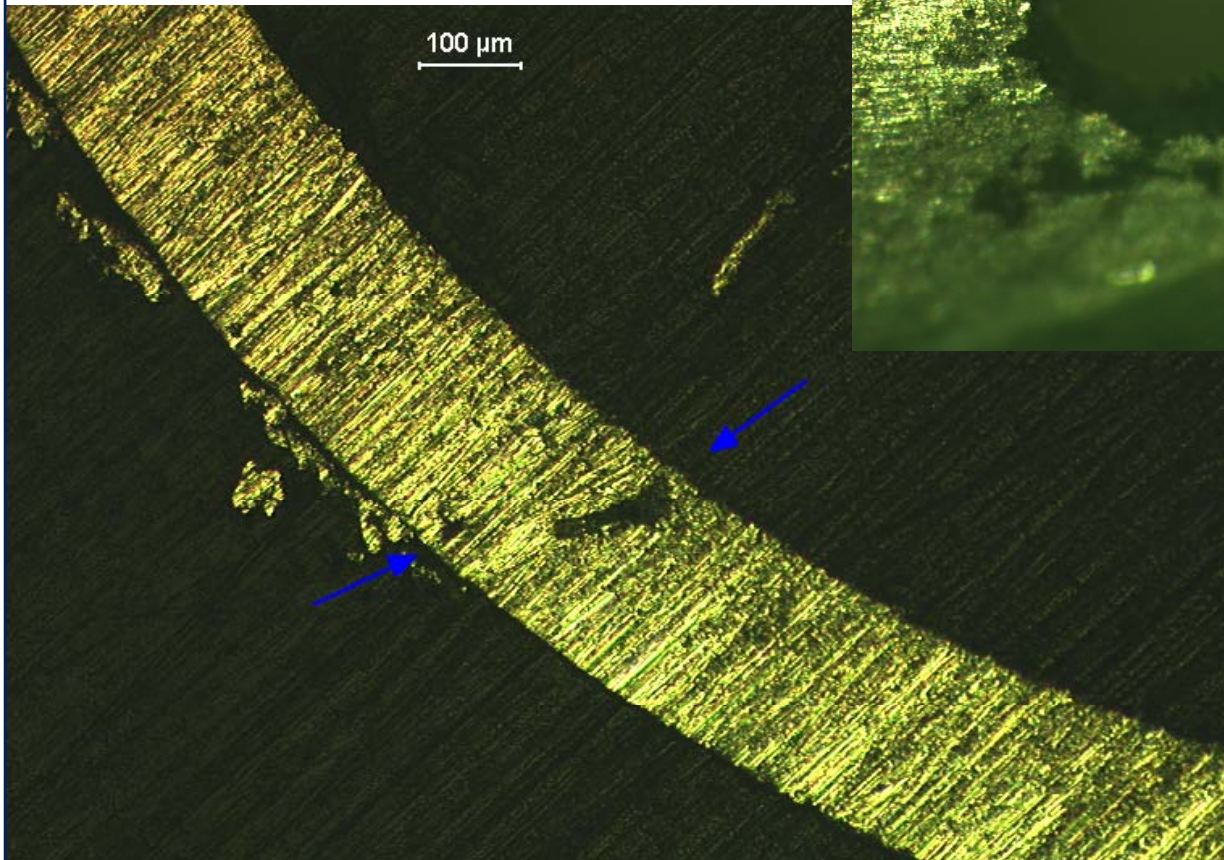



How to repair the staves already loaded

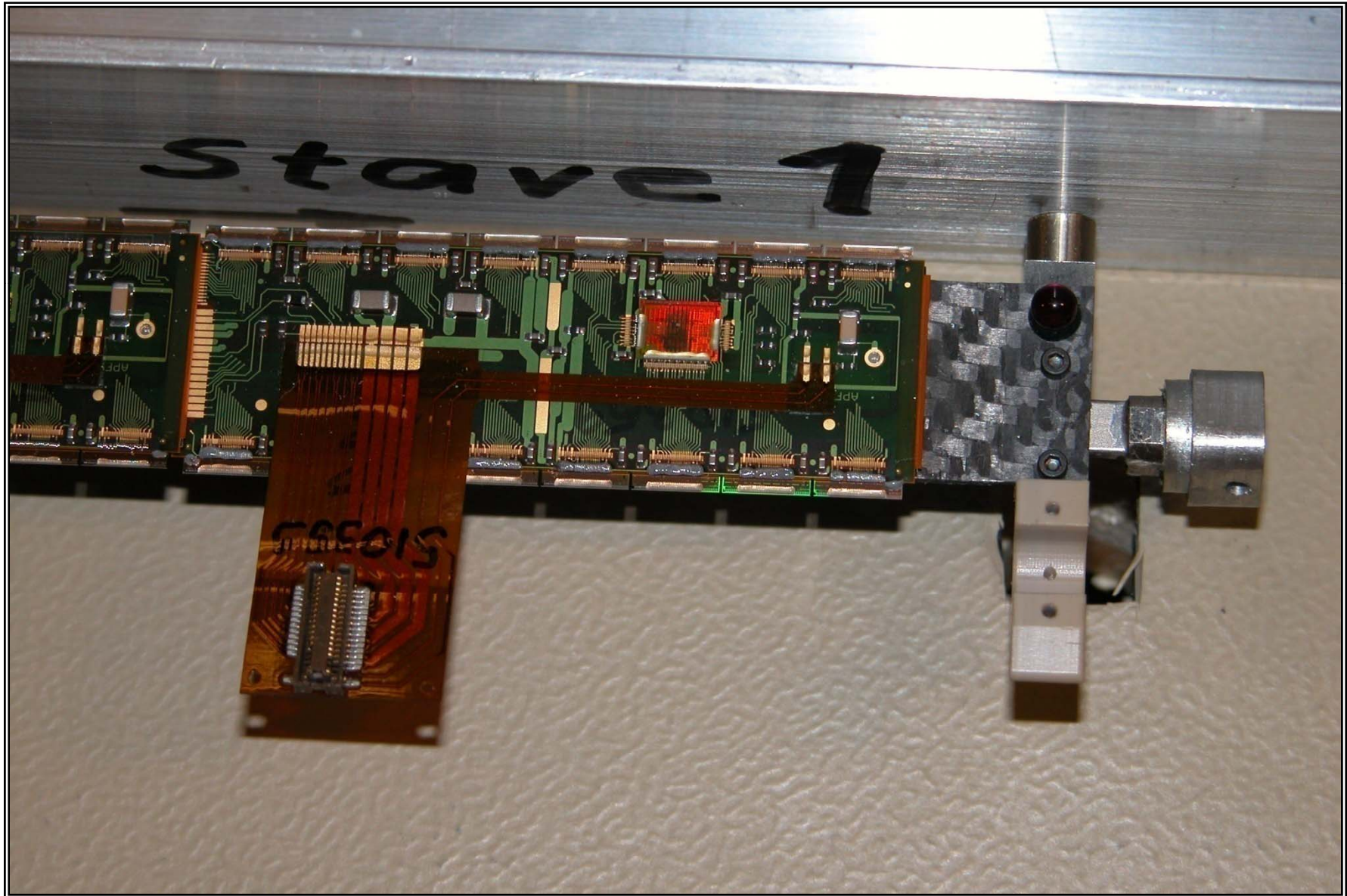
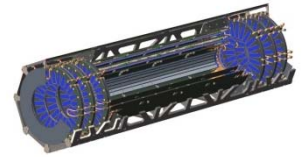

Injection technique

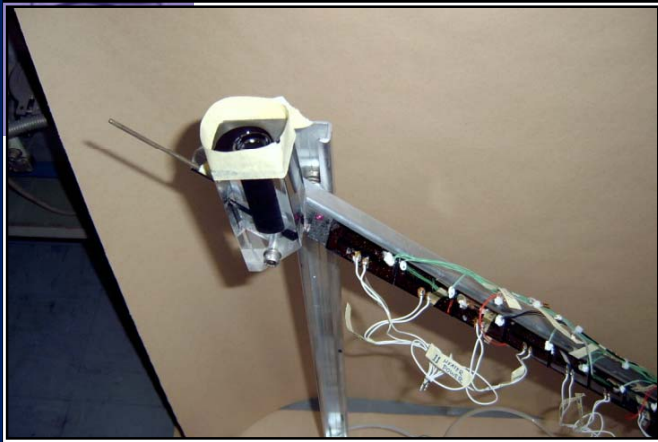

View of the section of the “inserted” pipe. Note the excellent coverage of the thermal compound

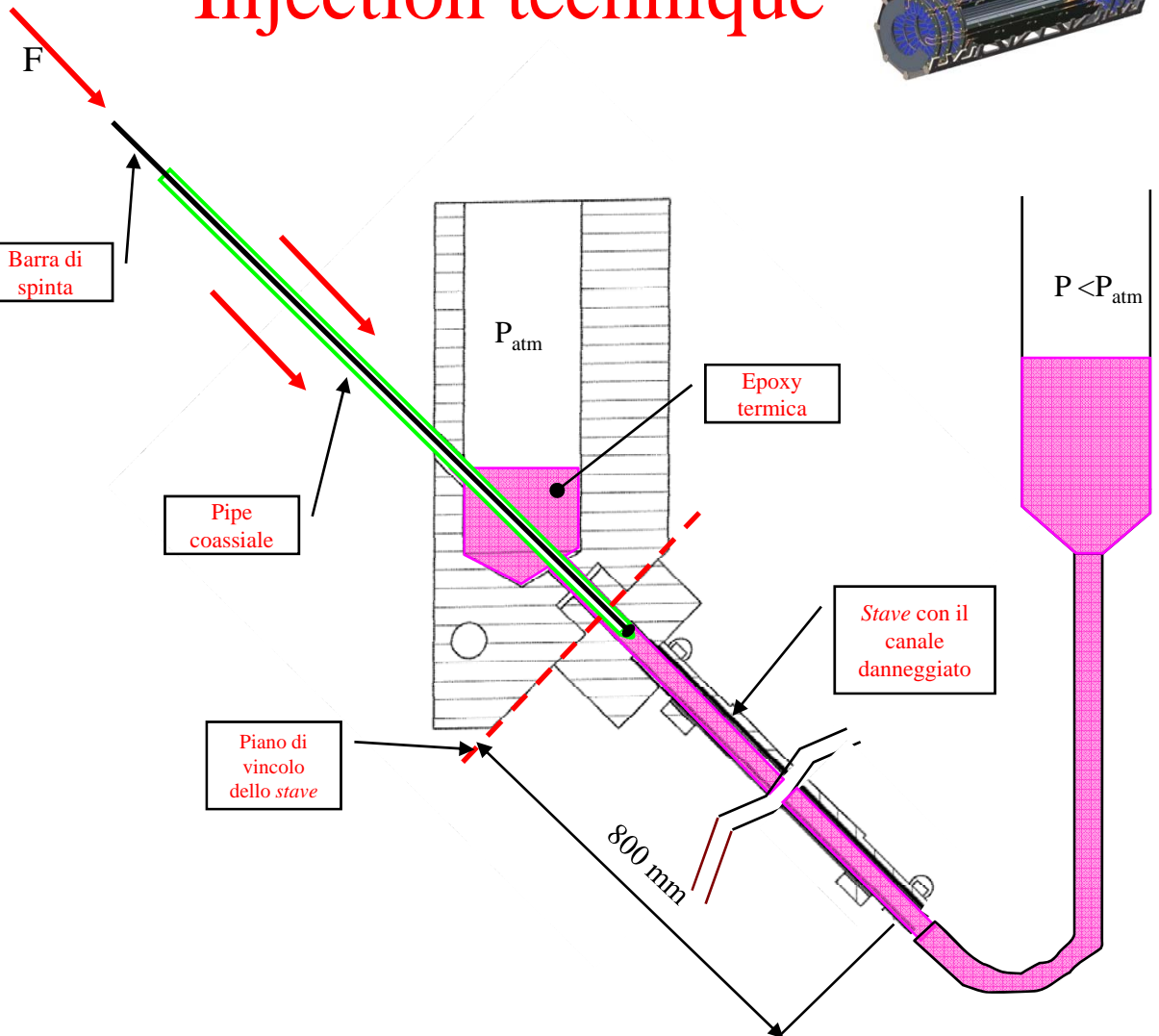

The inner pipe is inserted when the thermal compound is already filling the corroded pipe. The top vessel provide the fluid displaced by the insertion avoiding voids and bubbles.



Thermal performances simulation

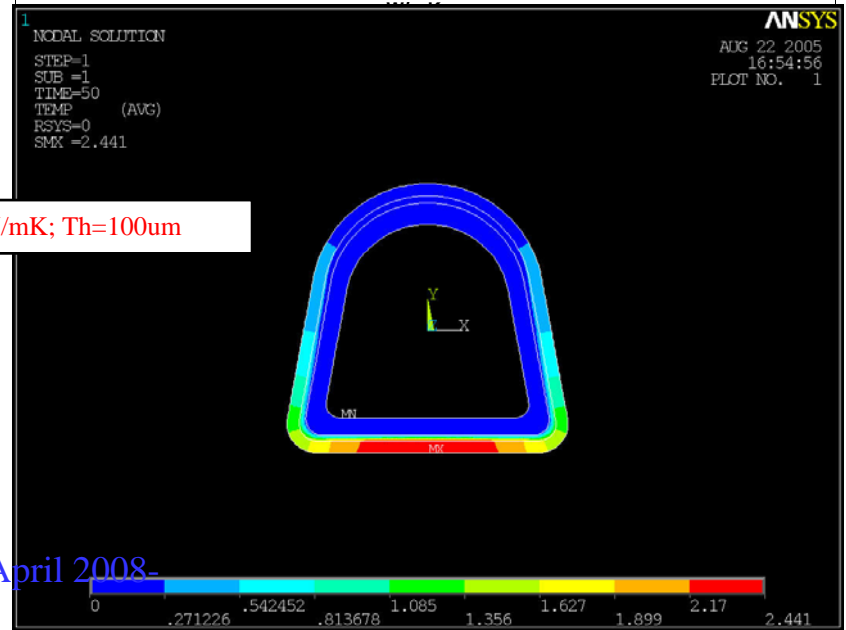
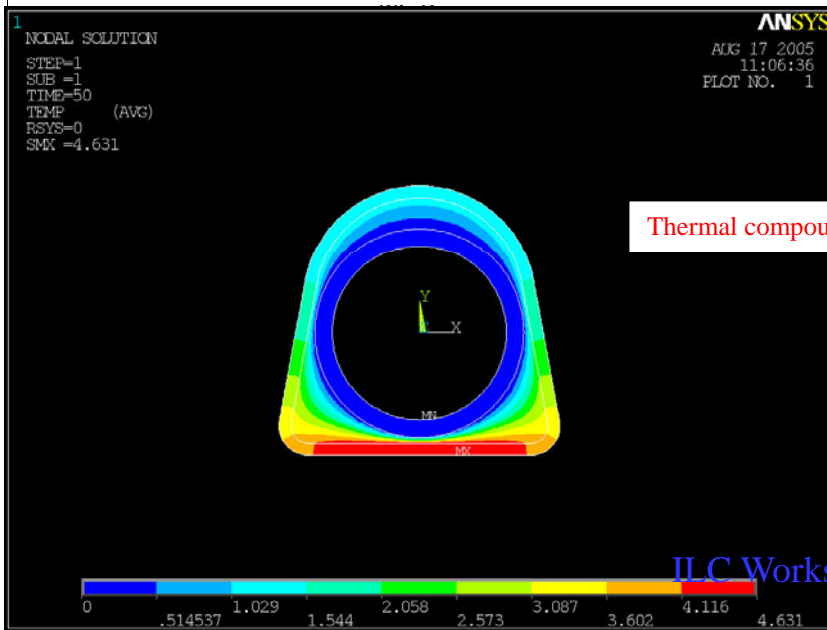
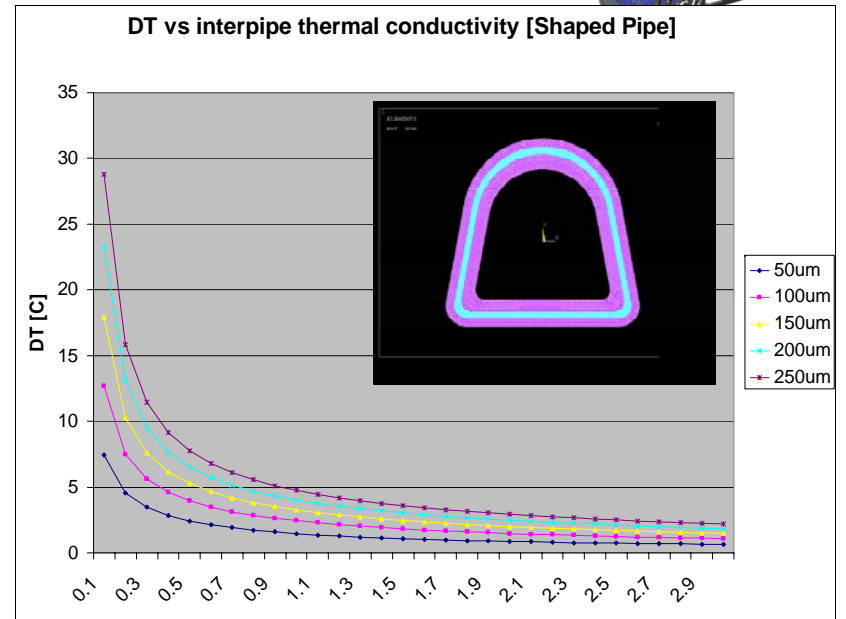
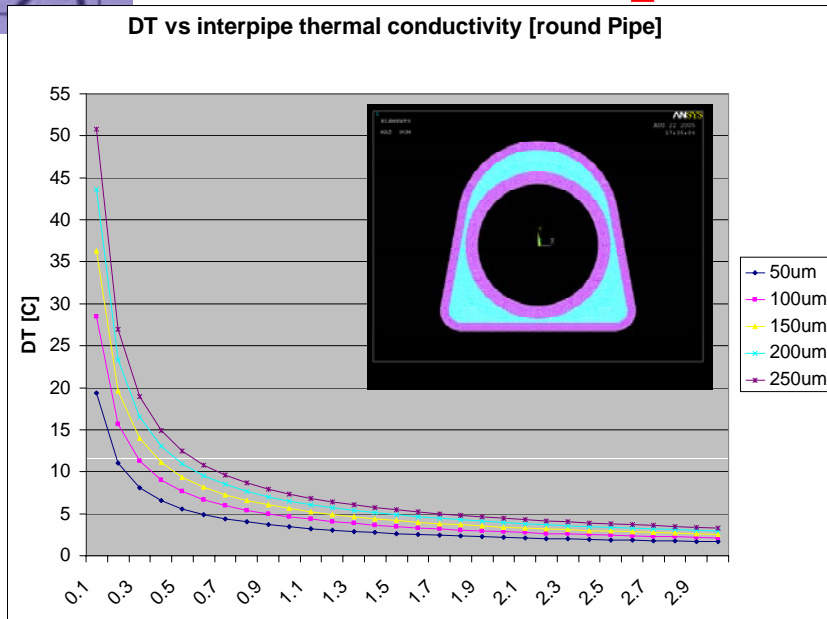
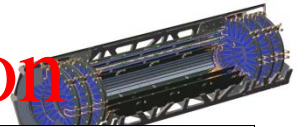



What we see now in the inserted stave

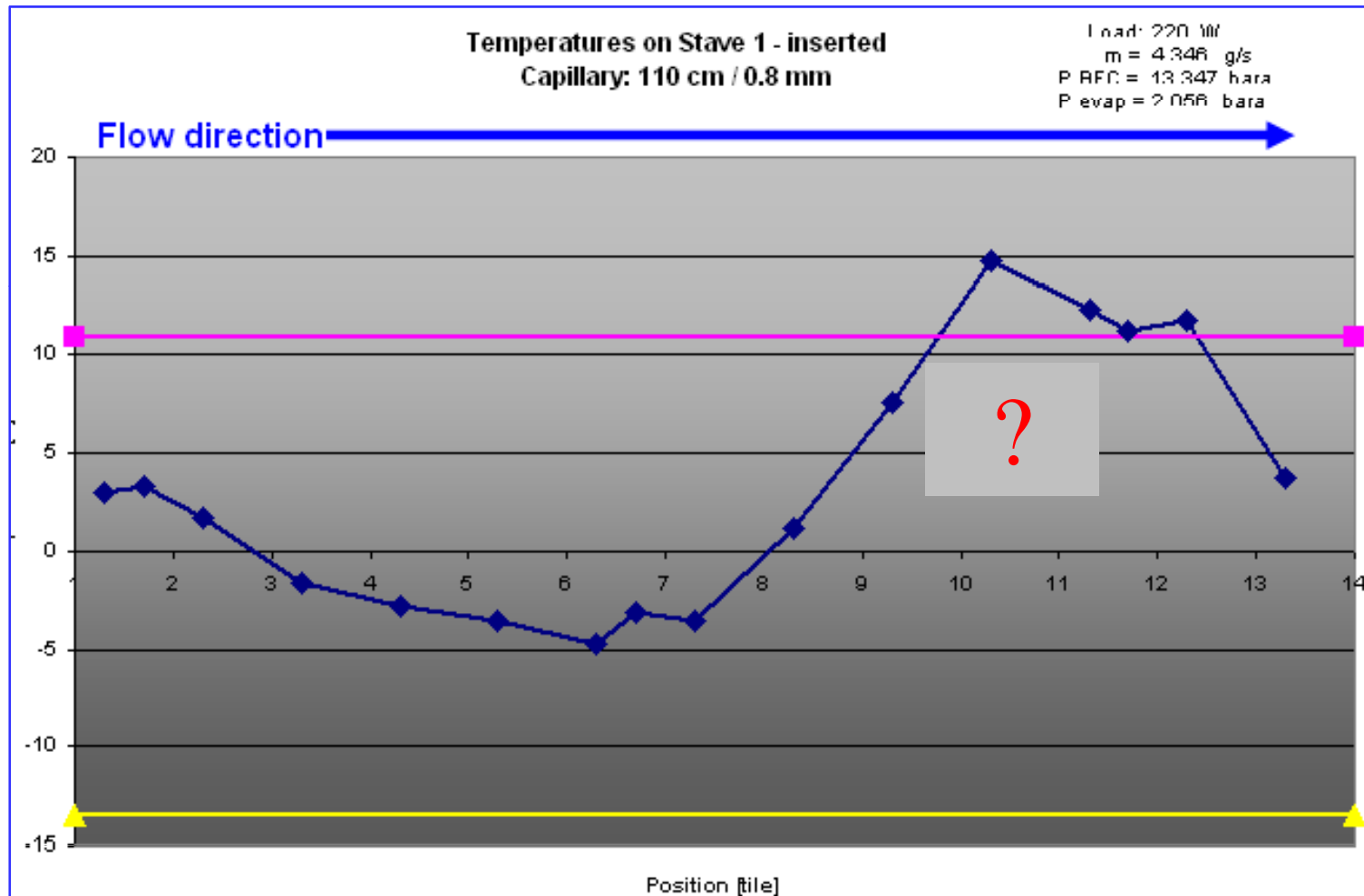
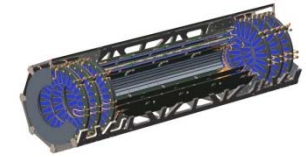



Mapping the stave allocation as function of the “flavors”

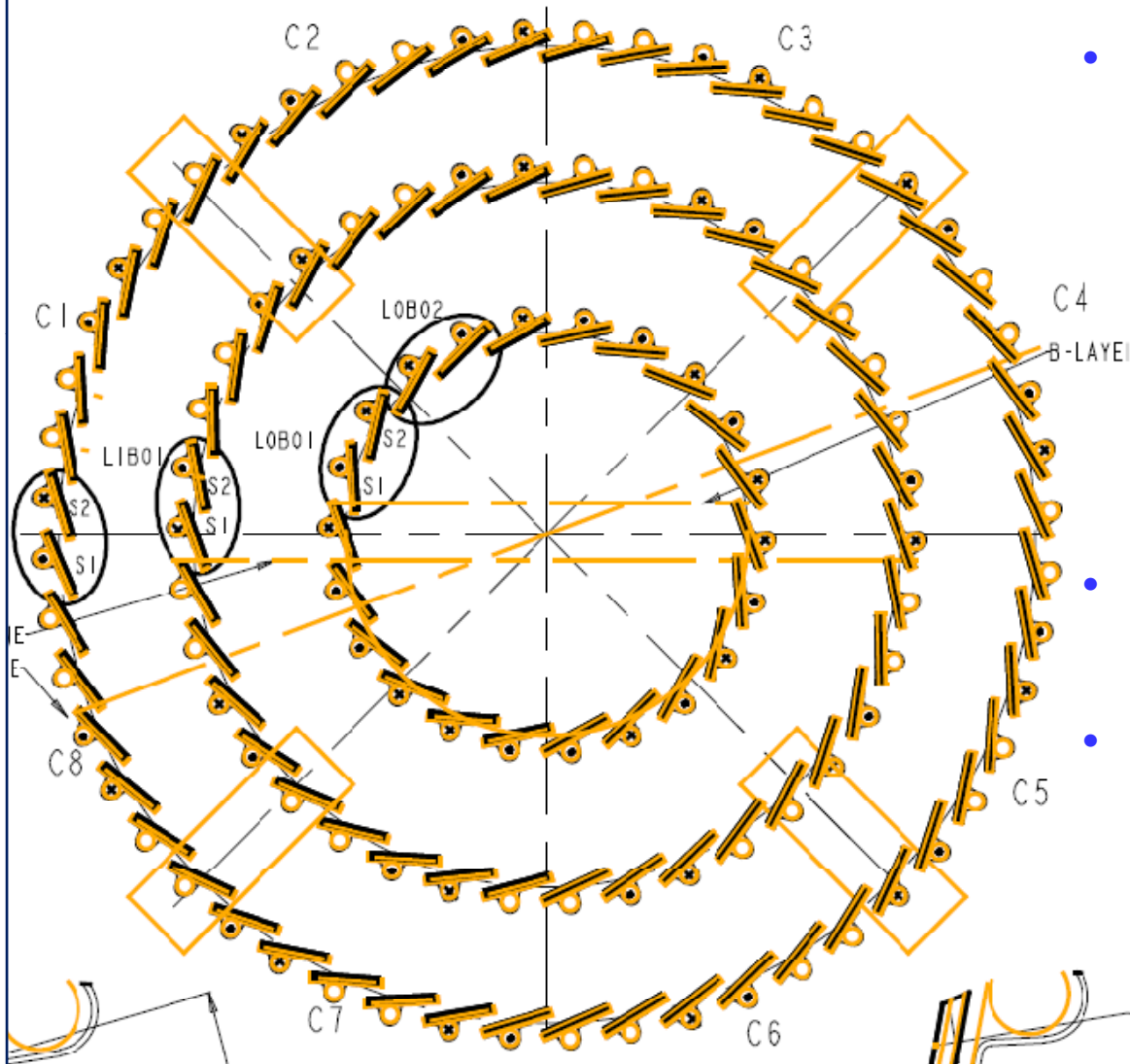
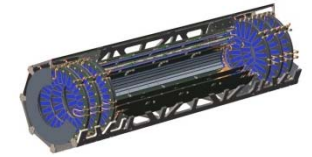

- L2 has all “mixed” bi-staves (inserted and clean).
The motivation is in the lower radiation damage of the of L2. Leakage current of the sensors degrade less and the power of the module increases proportionally. Staves with worse thermal properties should stay away from the IP.
- The inserted stave is the first streamwise to reduce the ΔP
- L1 and BL have always bi-staves with best thermal properties

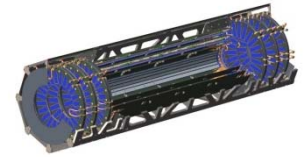

another severe problem...



Description of the Type0 cable

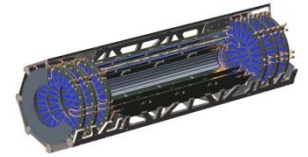

- All round aluminum conductors
- Connectors at both ends (mounted on PCB board)
 - “Up to 30 individual wires per cable
 - 16 “thin” 100 μ m diameter
 - ≤ 14 “thick” 300 μ m diameter
 - Custom thickness polyurethane insulation

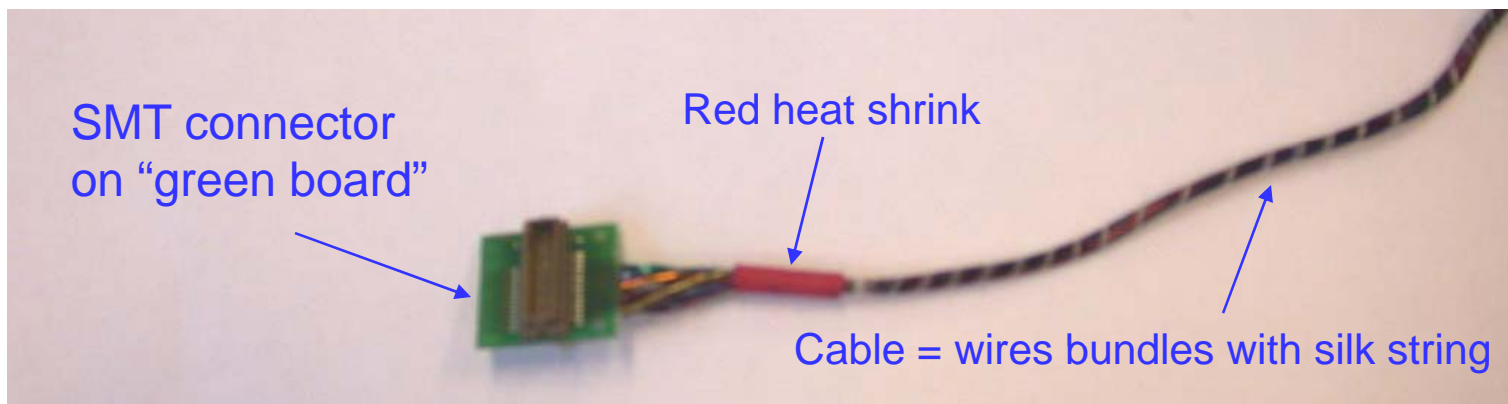
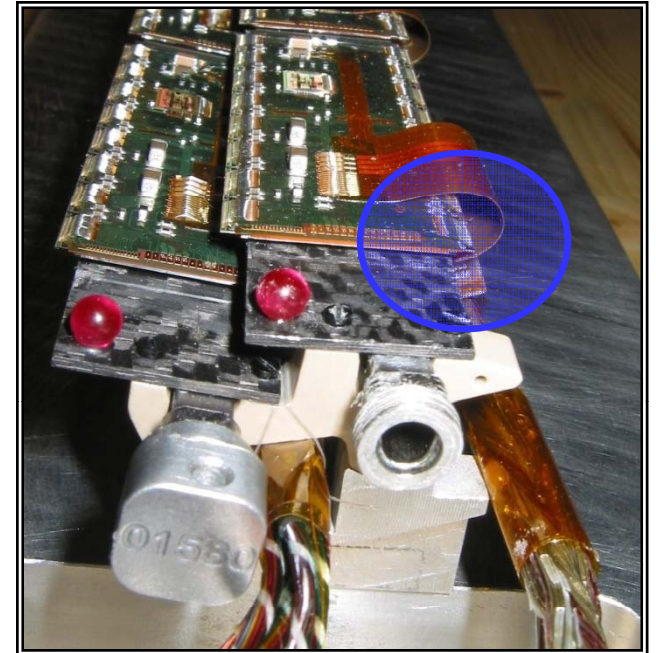



Pictures of damage

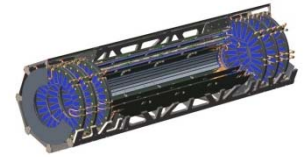

Close-up of typical cable
Close to the heat shrink
tubing

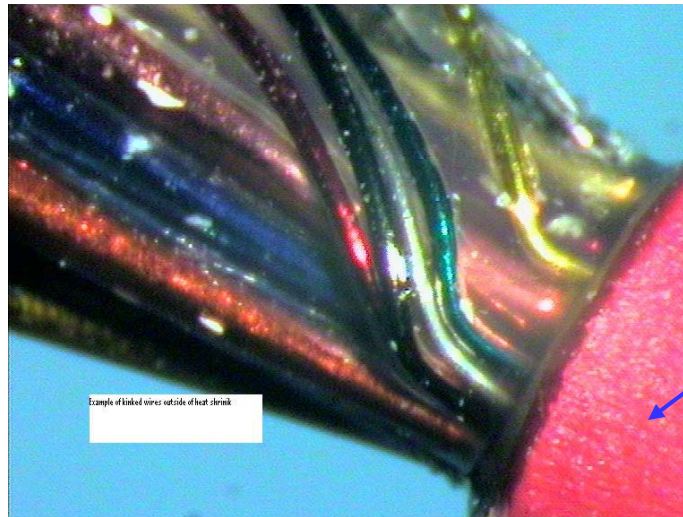

Red heat shrink tubing

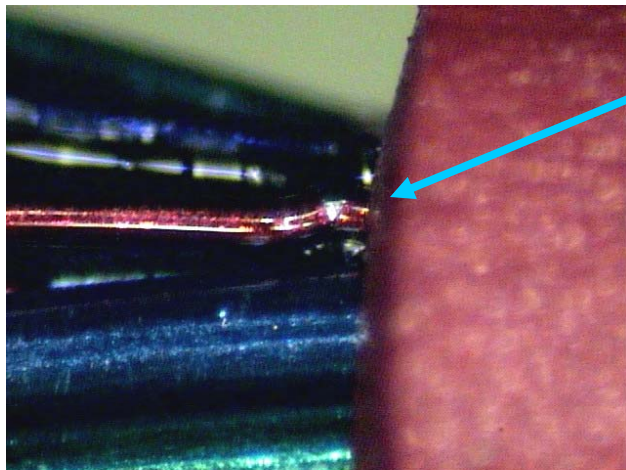

Examples of damage.
The insulation is
broken. This leaves
the aluminum
vulnerable to failure
with even very
delicate handling or
with thermal cycling.

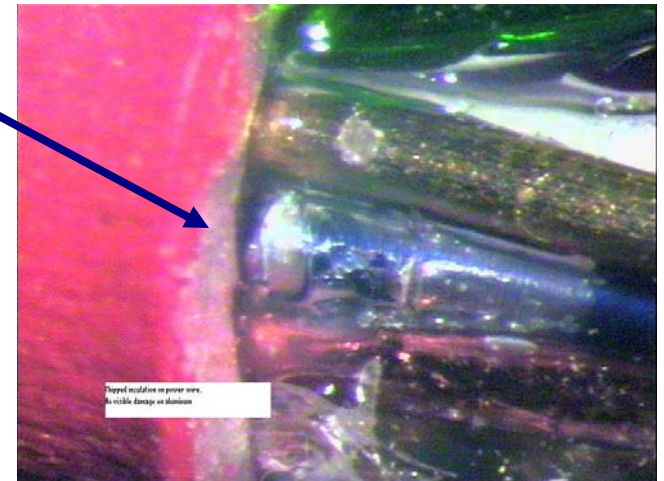



One bad process step

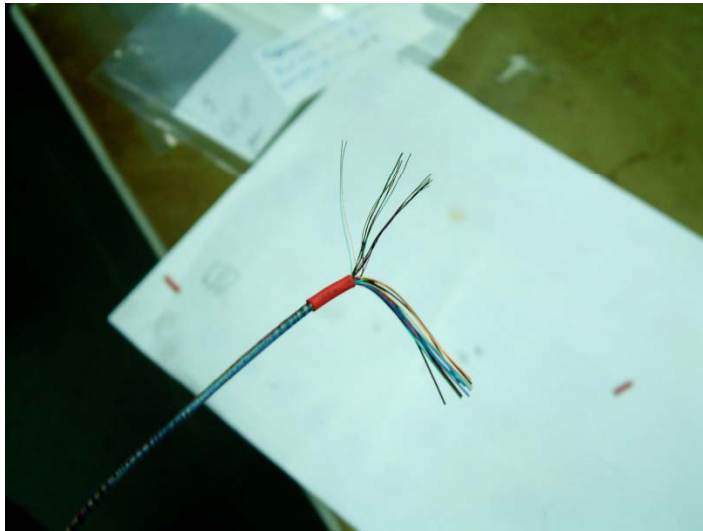
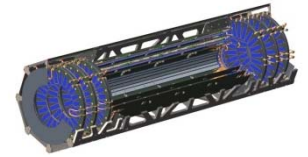

- Wires were bent before stripping. Thin and thick wires were separated to be stripped in two different phases.
- Stripping solution is molten NaOH; $T \sim 400\text{C}$
- What happens to the insulation when heated above 250C :



Bent, then heated



Heated, then bent

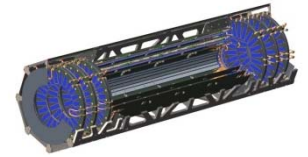

... after all this
(and others problems not mentioned here)
finally → Detector Integration



Bi-stave Integration

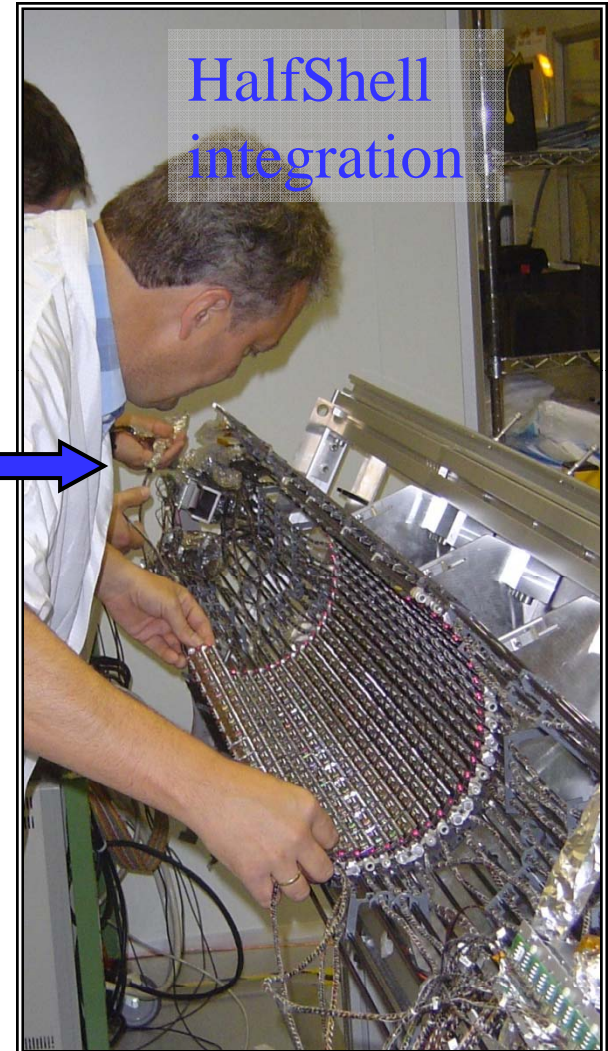
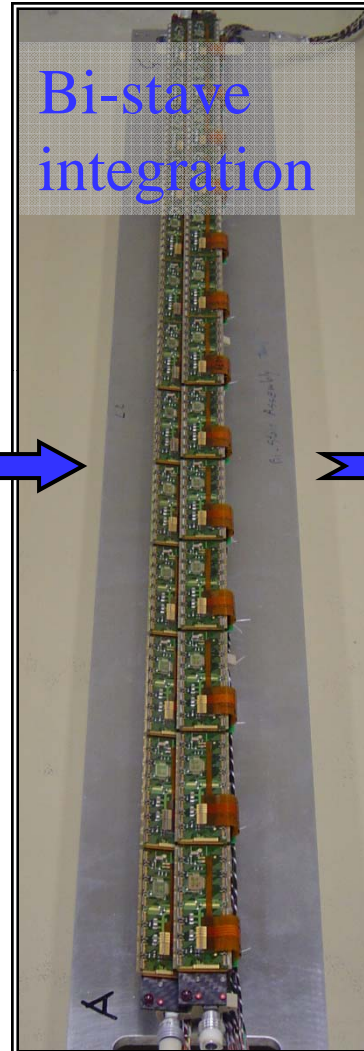
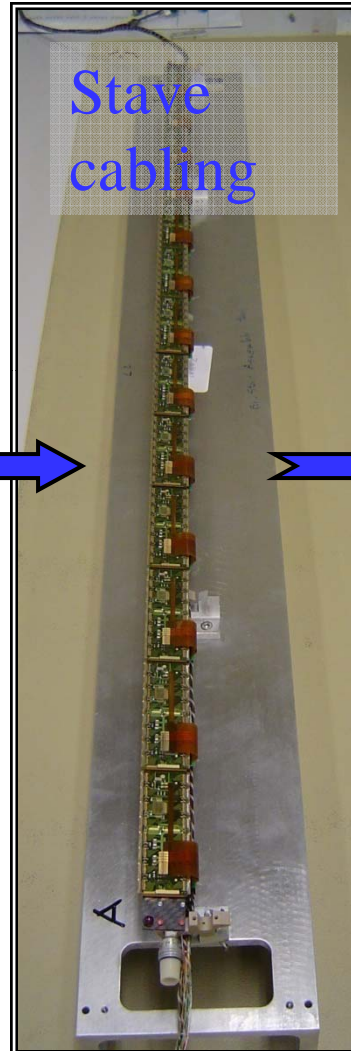
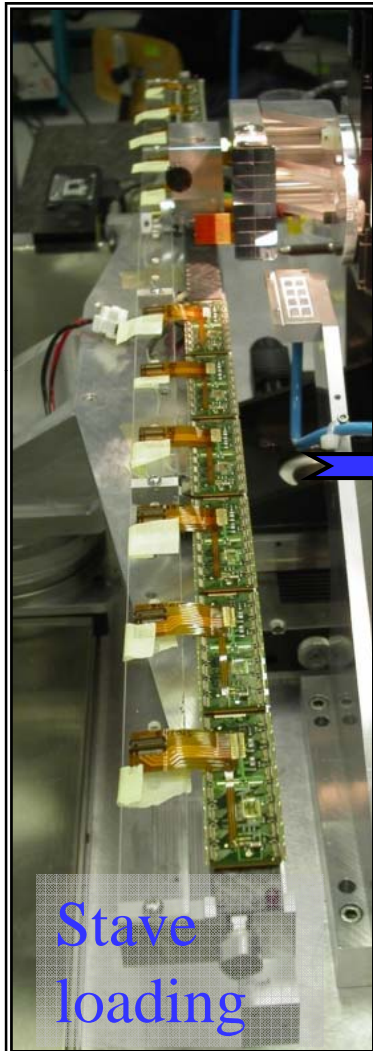
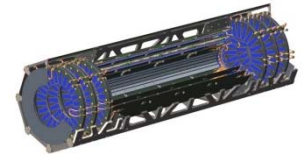



HalfShell integration

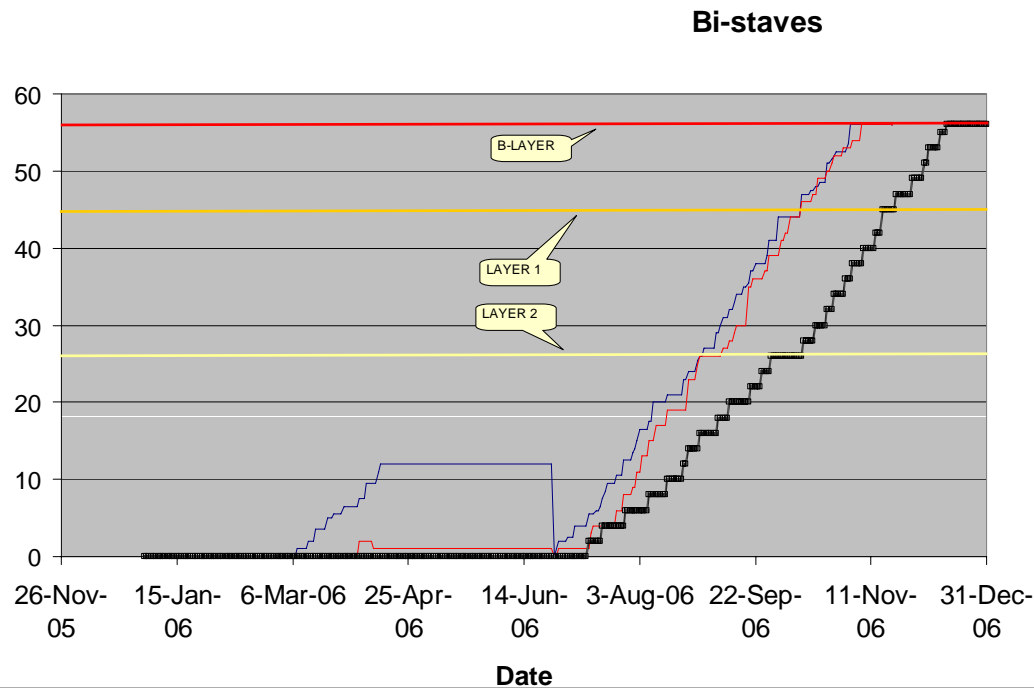

- The progress was impressive.
- Plots shows how the red line (number of bi-staves loaded in the HalfShell vs. time) is significantly ahead of the schedule (black line)



Lifting up

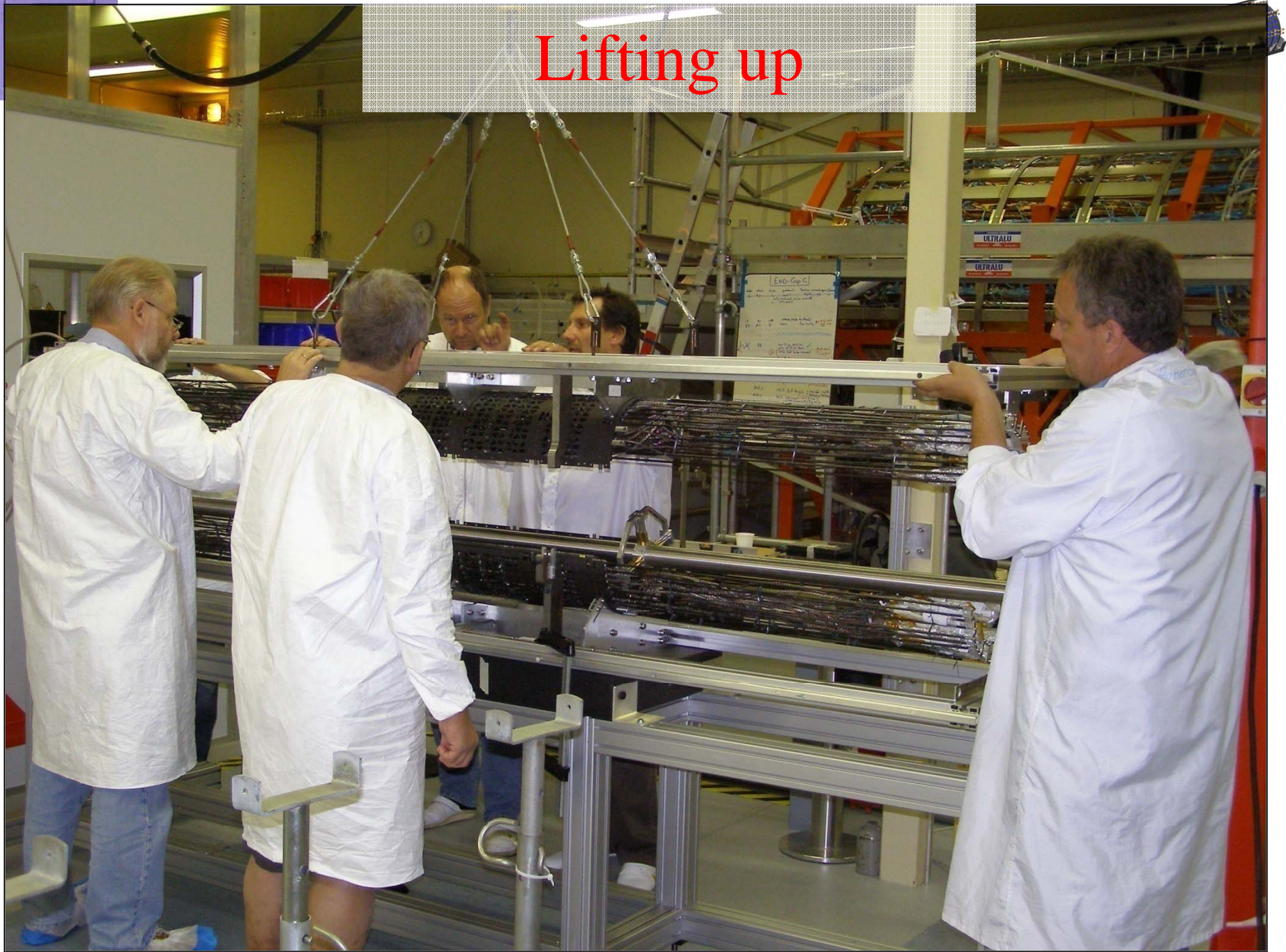

Engaging the clamping guides



Layer 2 on the structural pipe

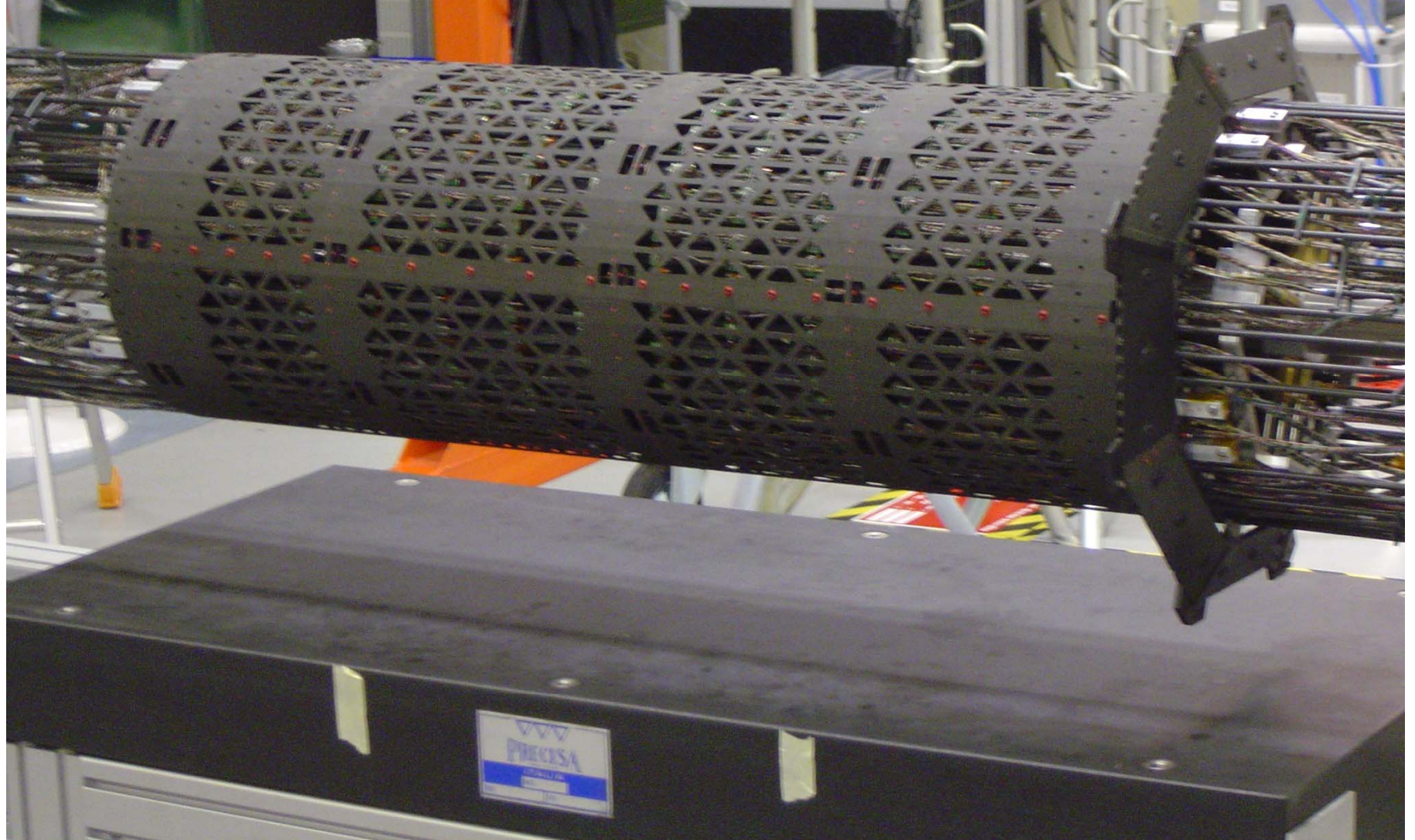



Layer 2 on the ITT

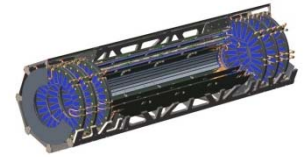



L2 insertion into the Global Frame

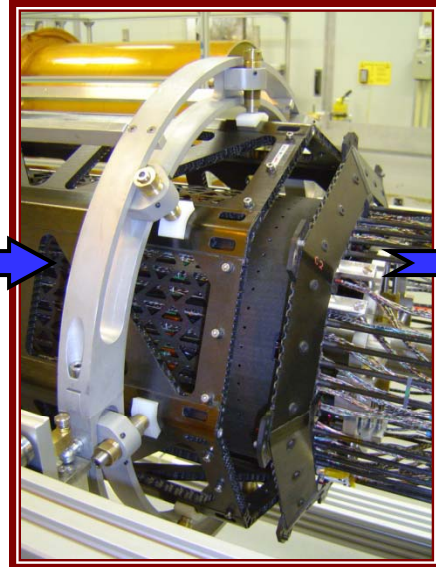
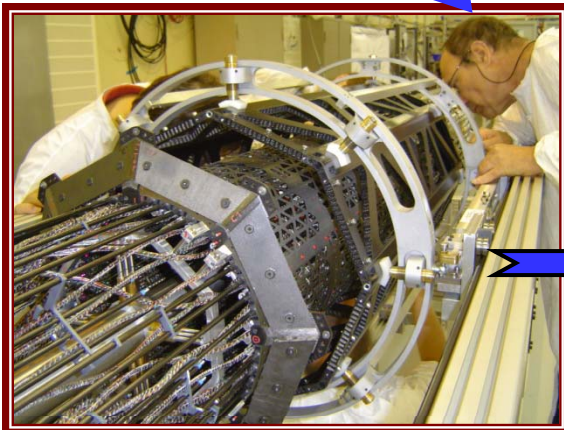
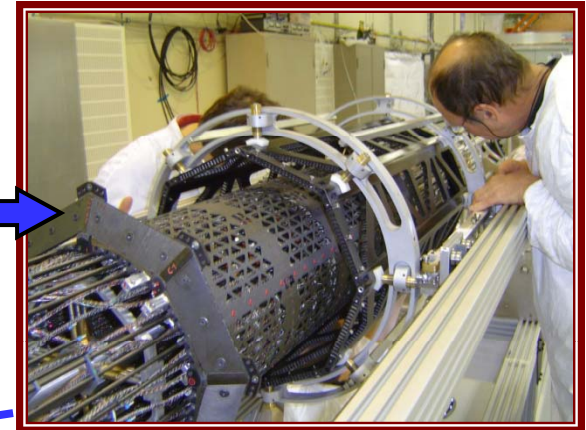
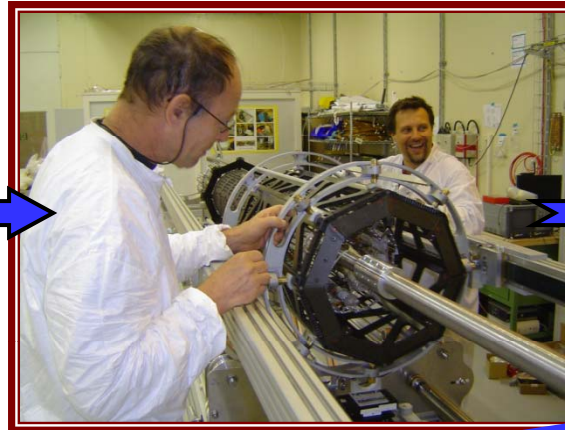

D. Giugni



Later 2 on the ITT with the type0 cables folded back.

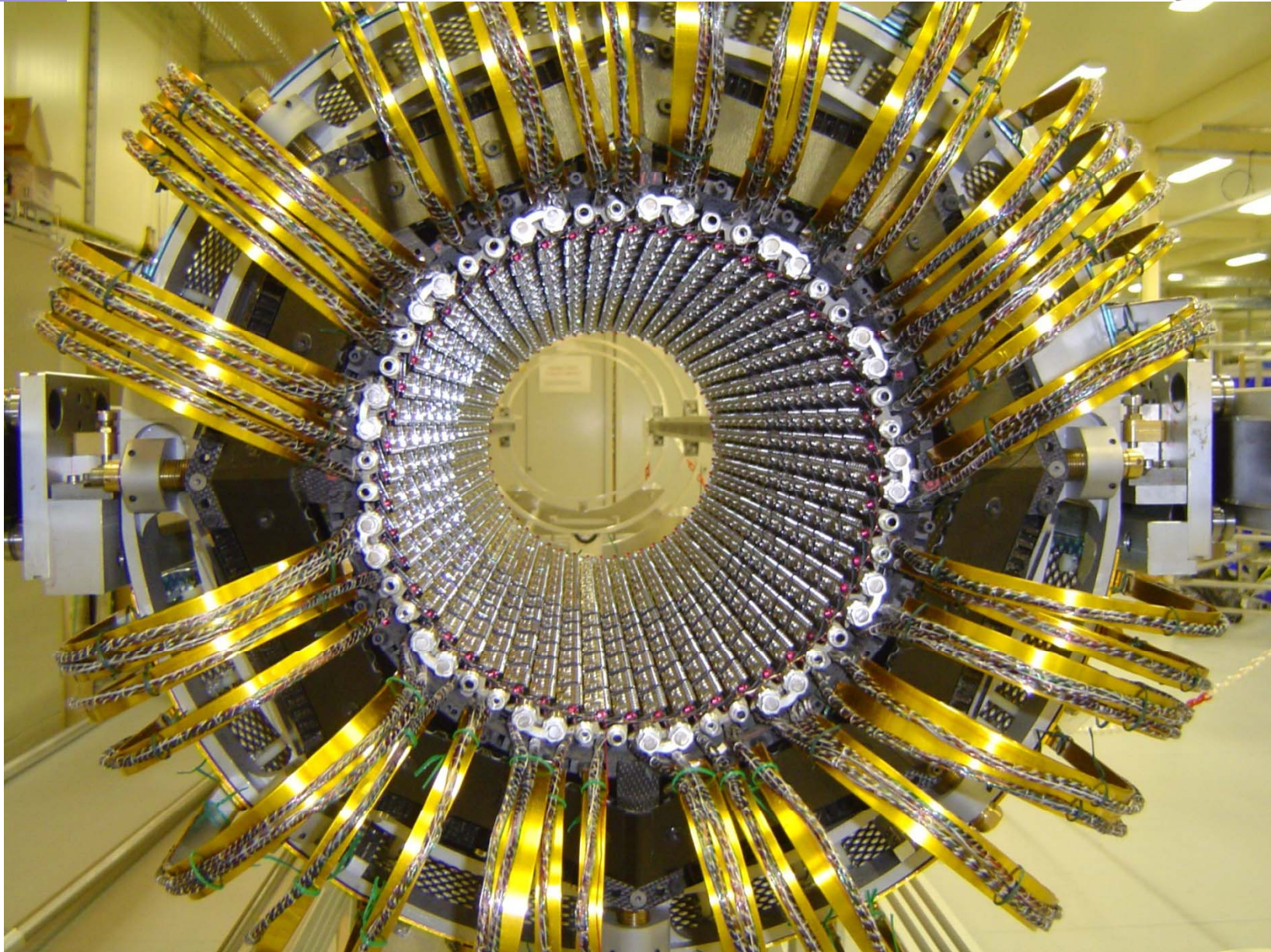



Detector Integration: damage and repair of the HalfShell

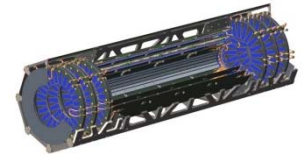

- L1 clamping was done late in October 06.
- During the preparation of the HalfShell bottom the structure was severely damaged.
The structural integrity was compromised and a repair was necessary.
- Almost $\frac{1}{4}$ of the section of the HalfShell was affected.
- Detailed report is available here:

http://dgiugni.web.cern.ch/dgiugni/integration/half_shell_repair/halfshell_repair.pdf

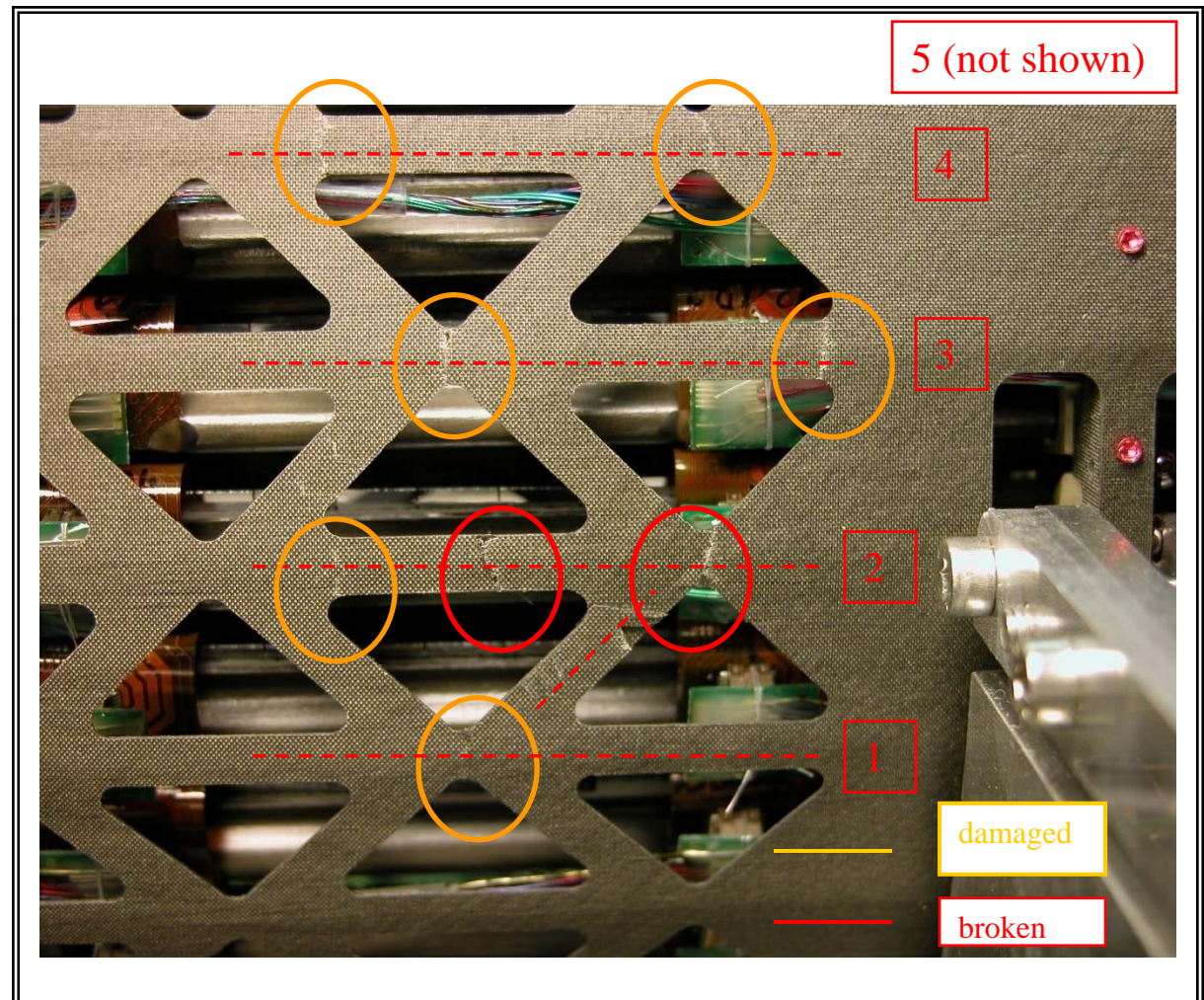



Damage and repair of the HalfShell

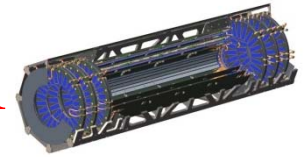

- No modules have been fortunately affected; therefore the repair was just a mechanical issue.
- Five patches 15x75mm made of the same material have been glued on top of the damaged zone.
- No damages to the staves or to the modules behind the affected area.

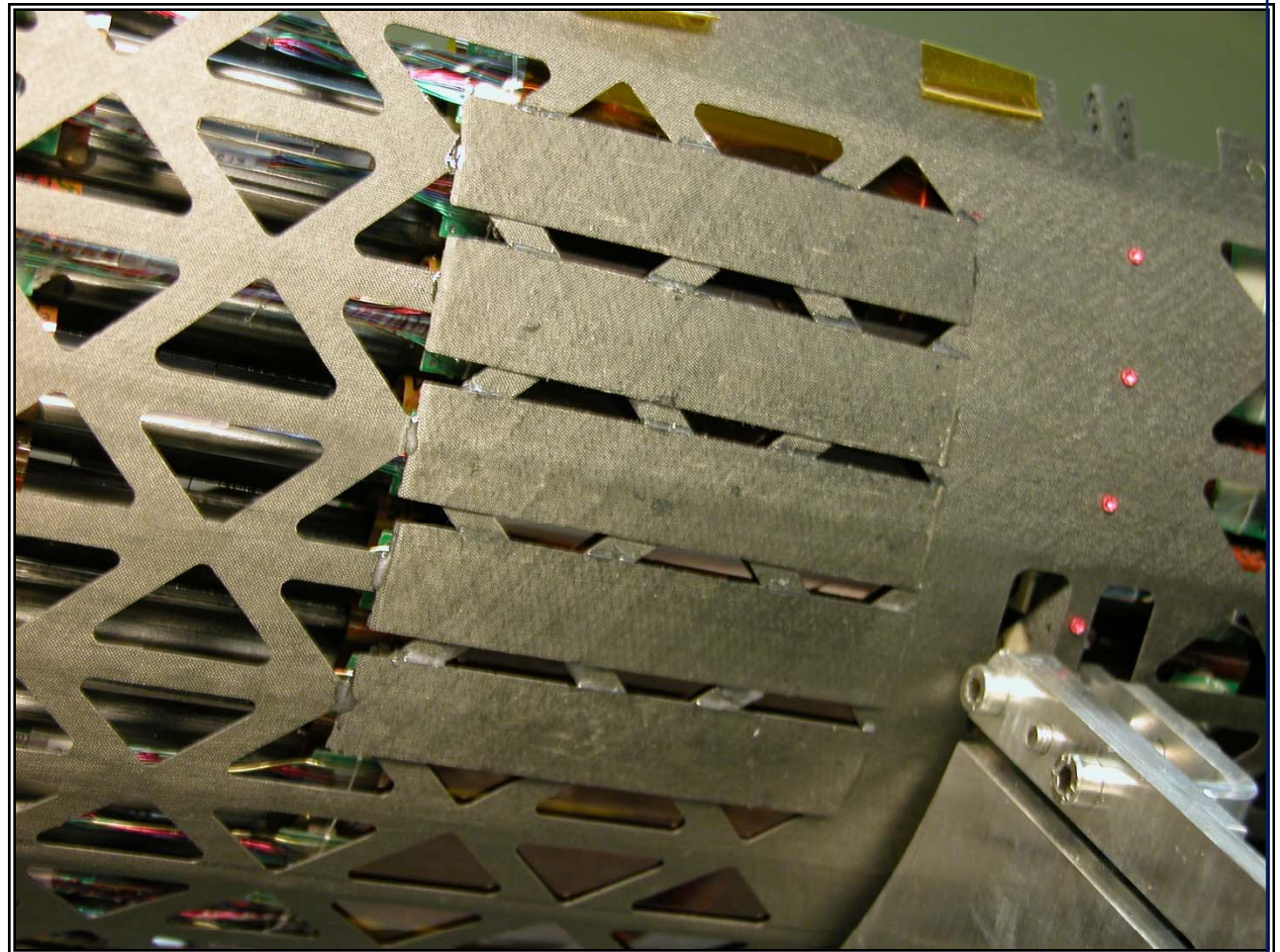



L1 Clamped late October 06

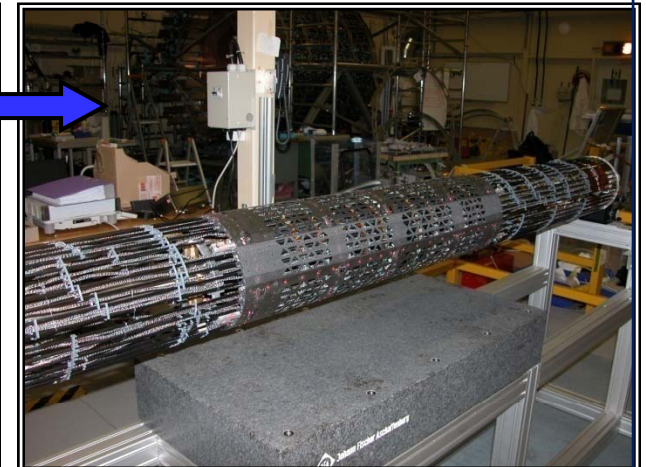
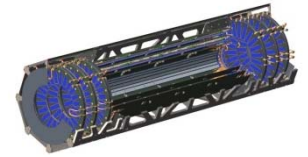



L1 insertion – Early November 06-

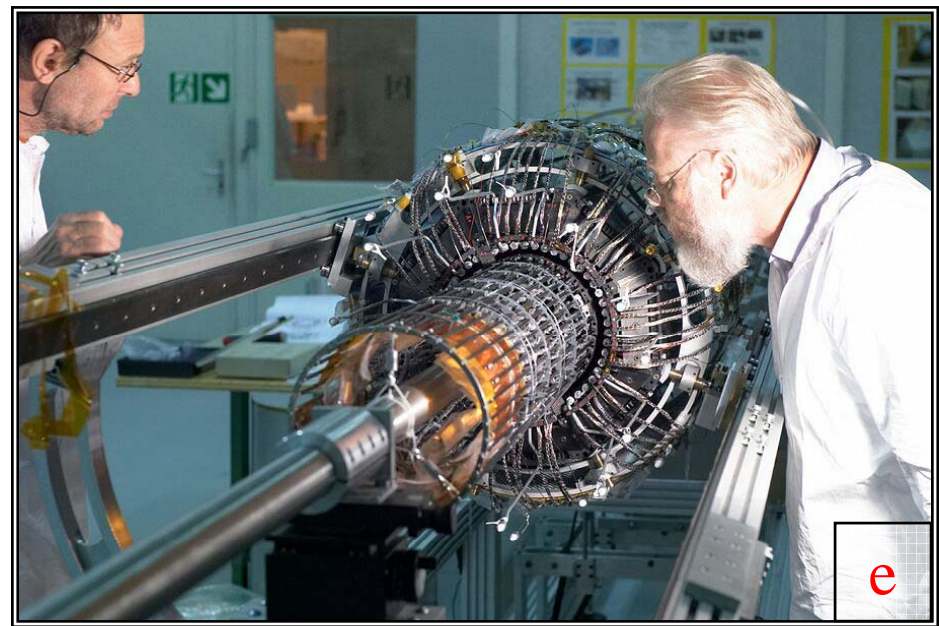
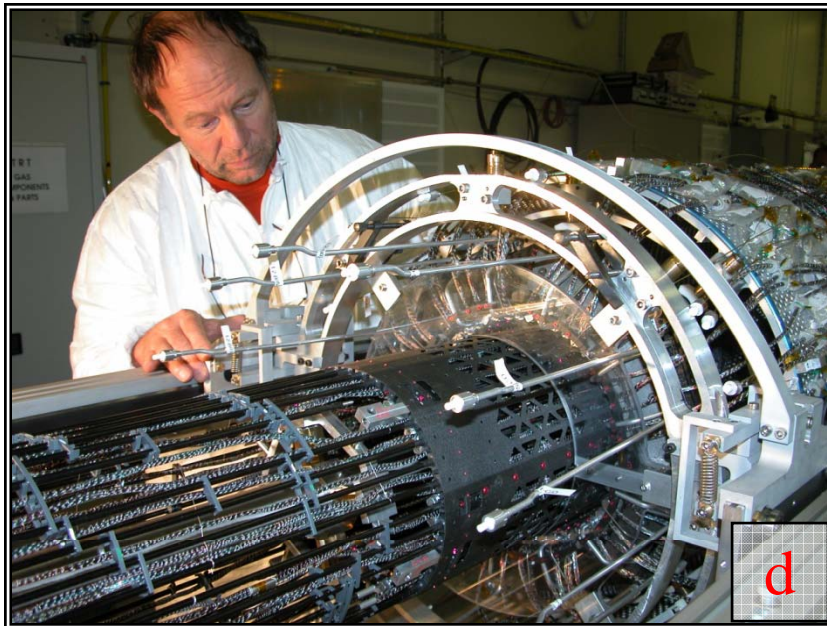
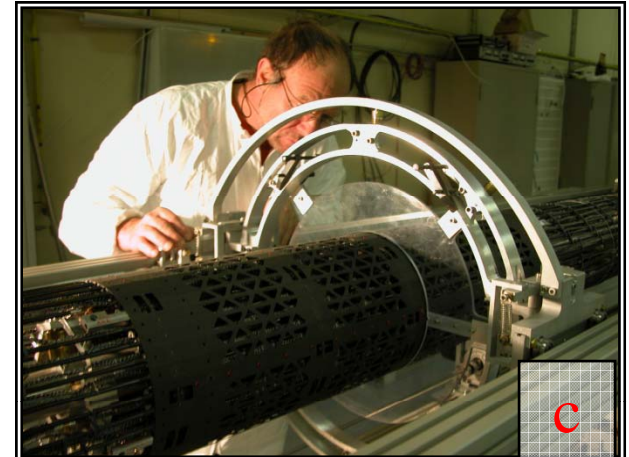
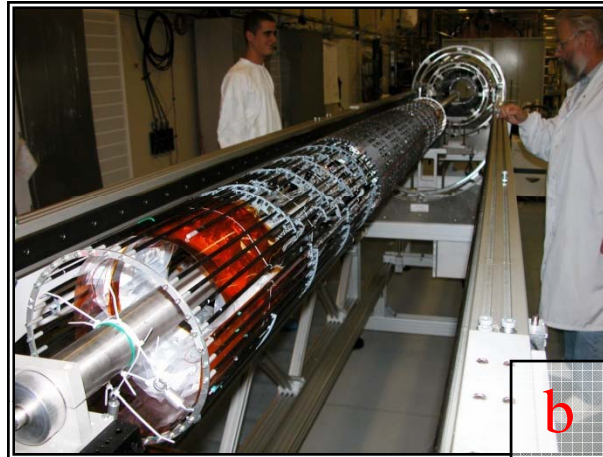
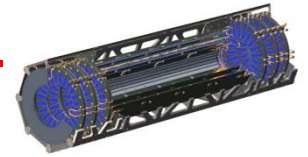

D. Giugni

Leak at the B-Layer

EndPlate

Disk 3

Disk 2

Disk 1

BeamPipe

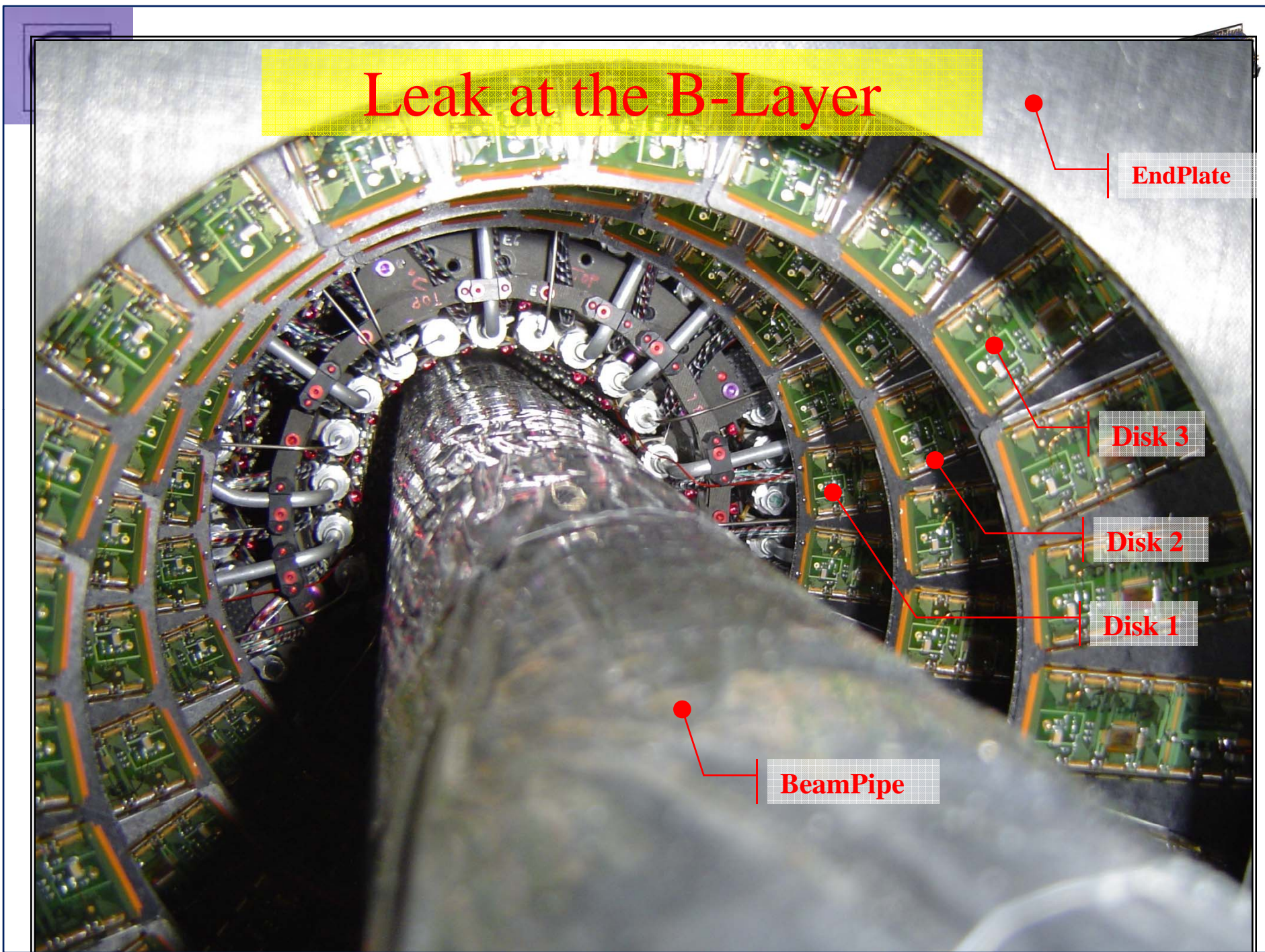



From ITT to the DST

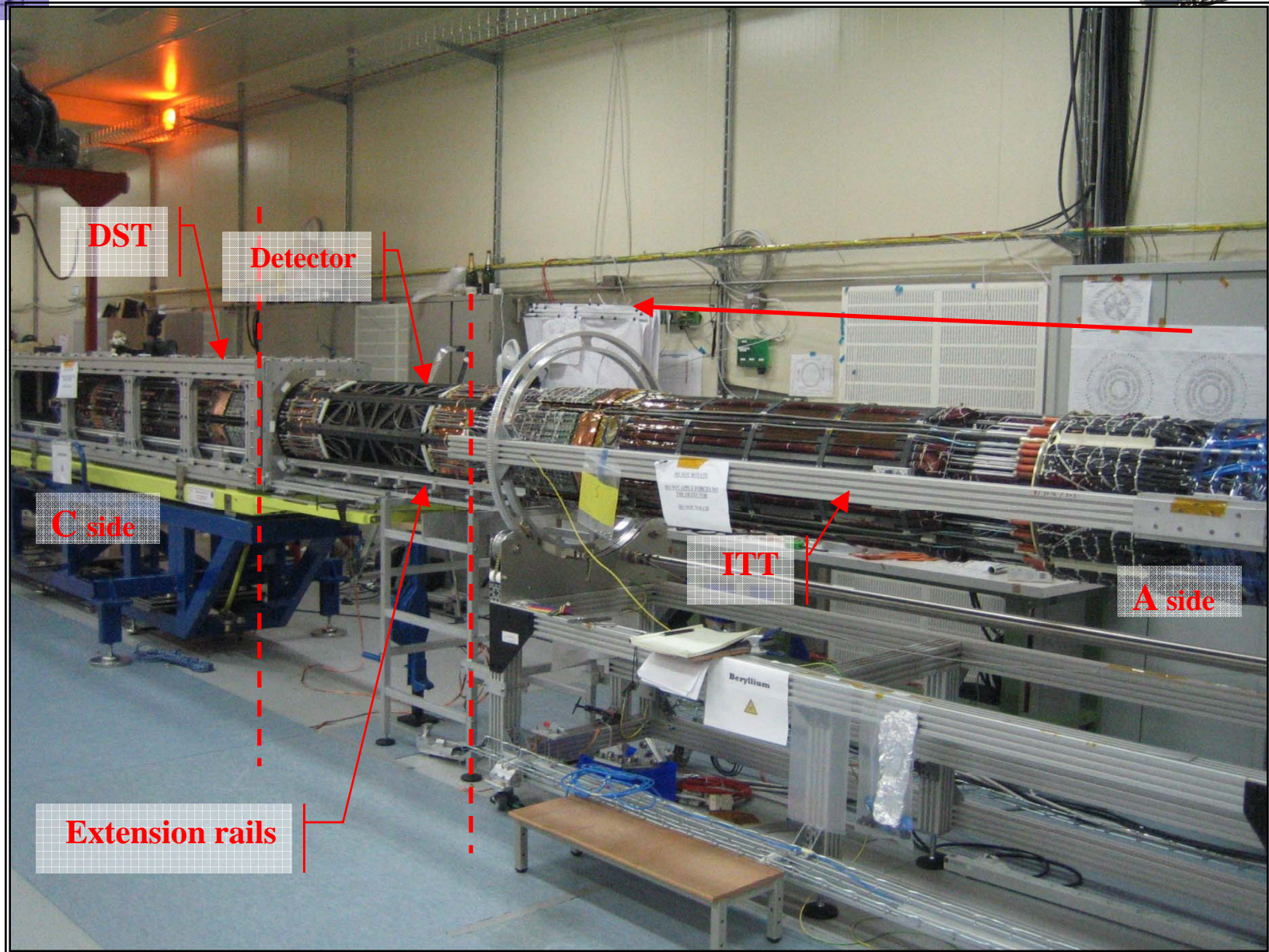
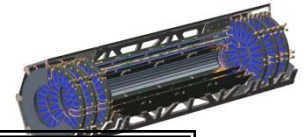



Moving the detector to the SX1 (June 07)

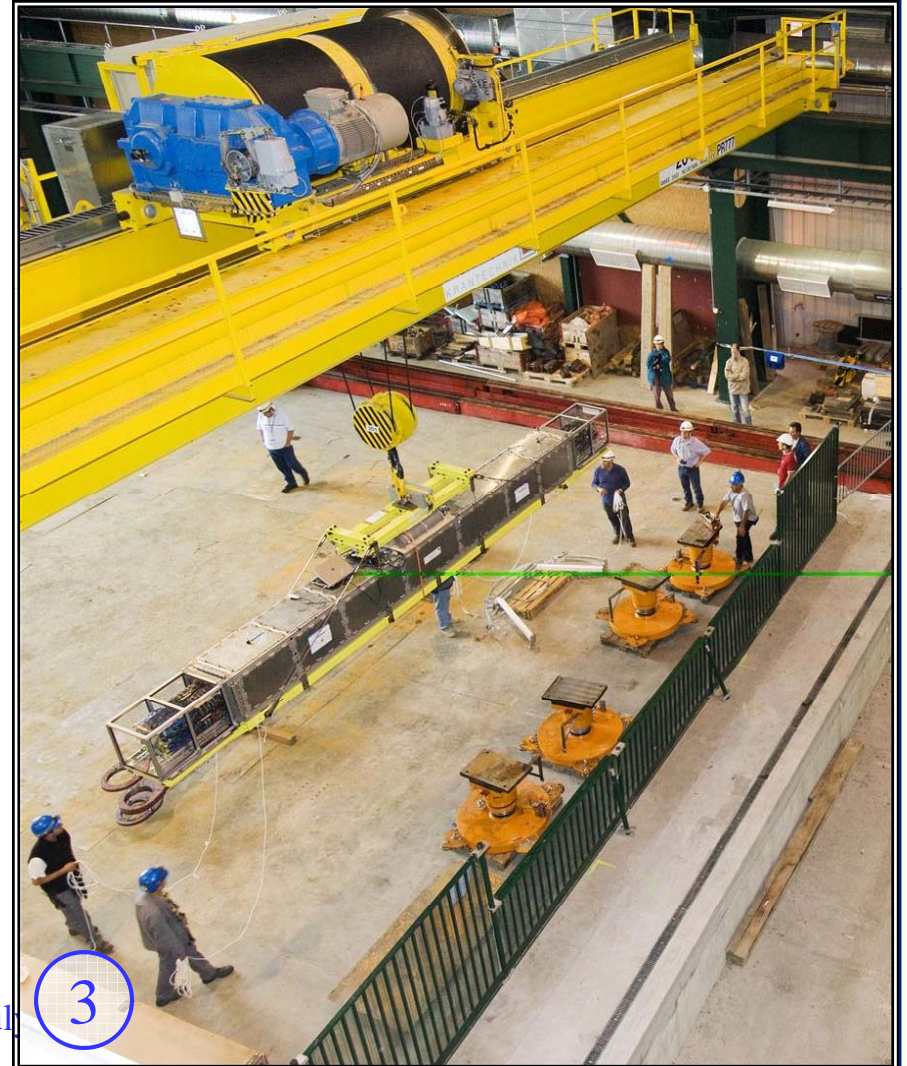
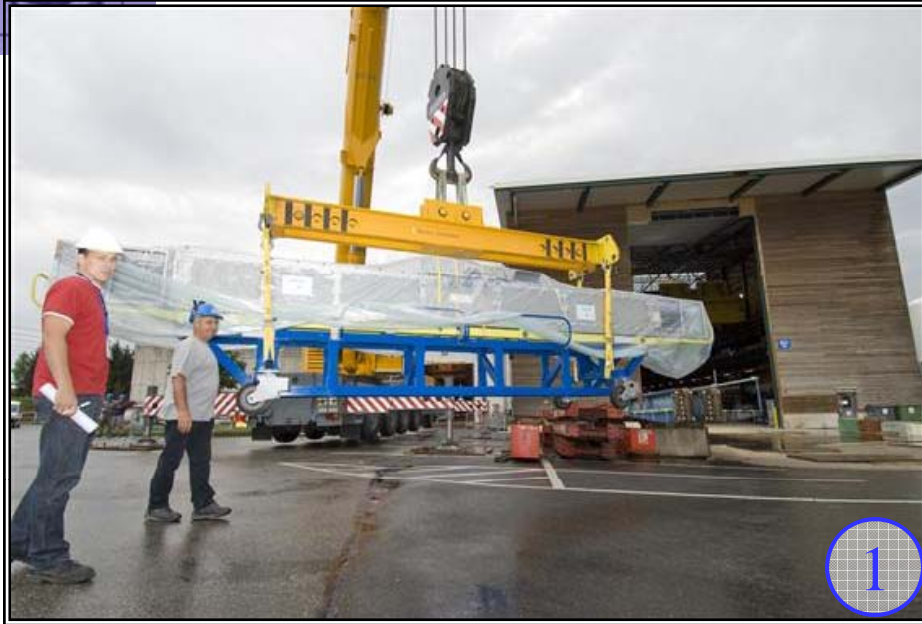

ul



Some pictures

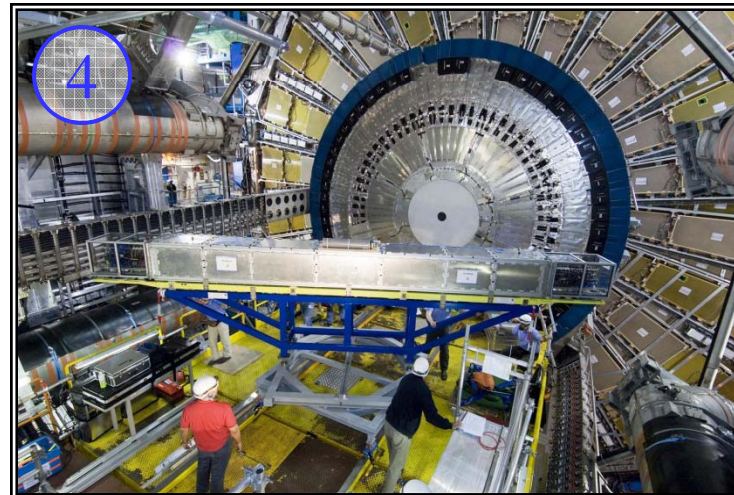
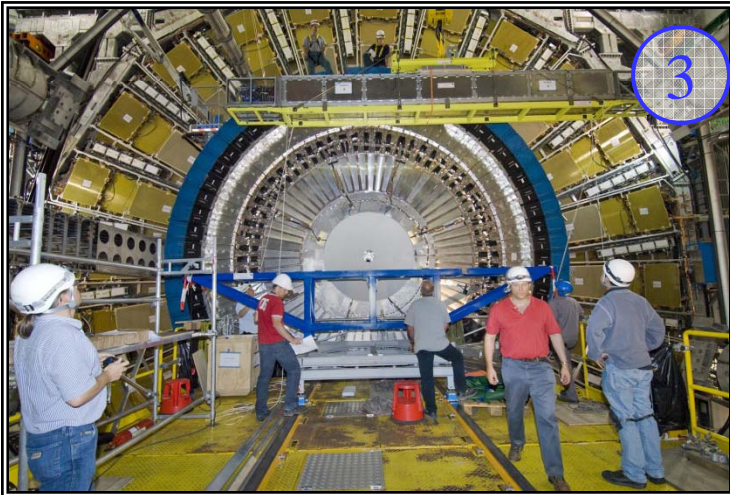
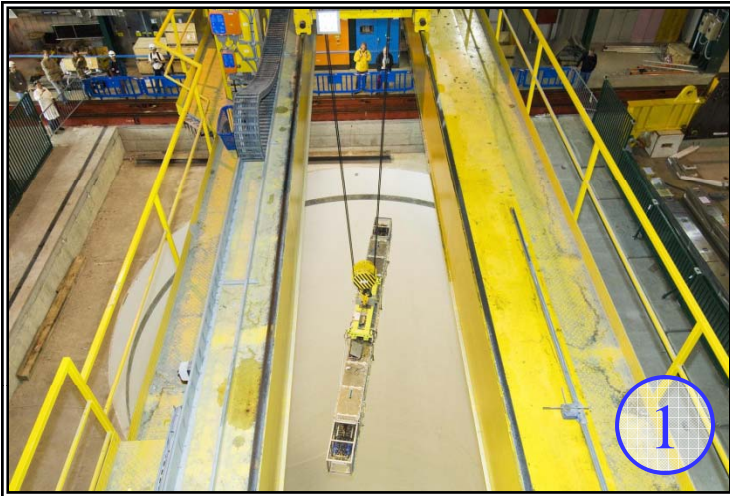
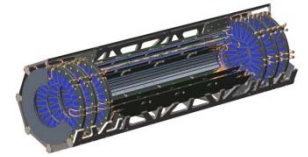



Some pictures

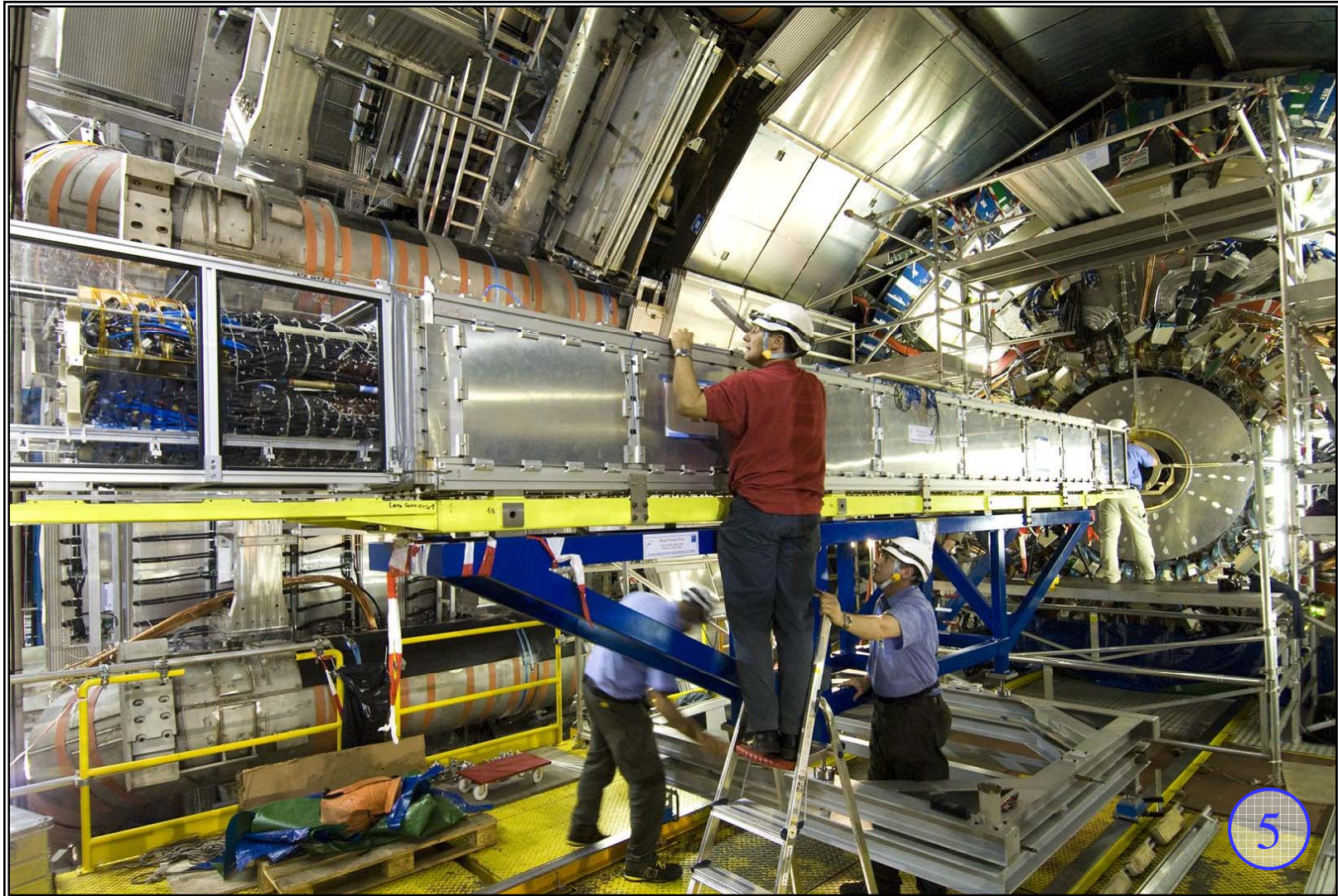

5

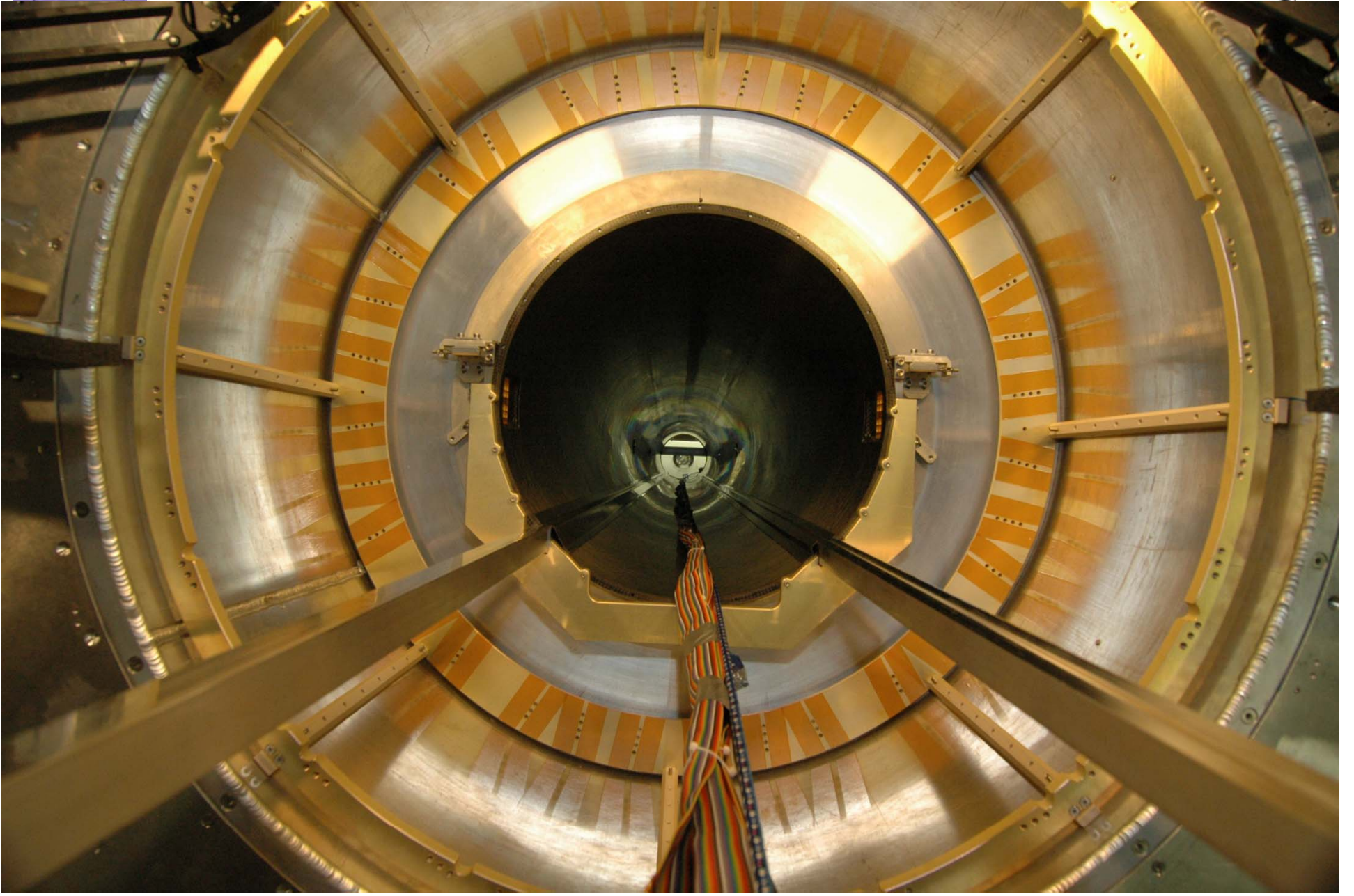

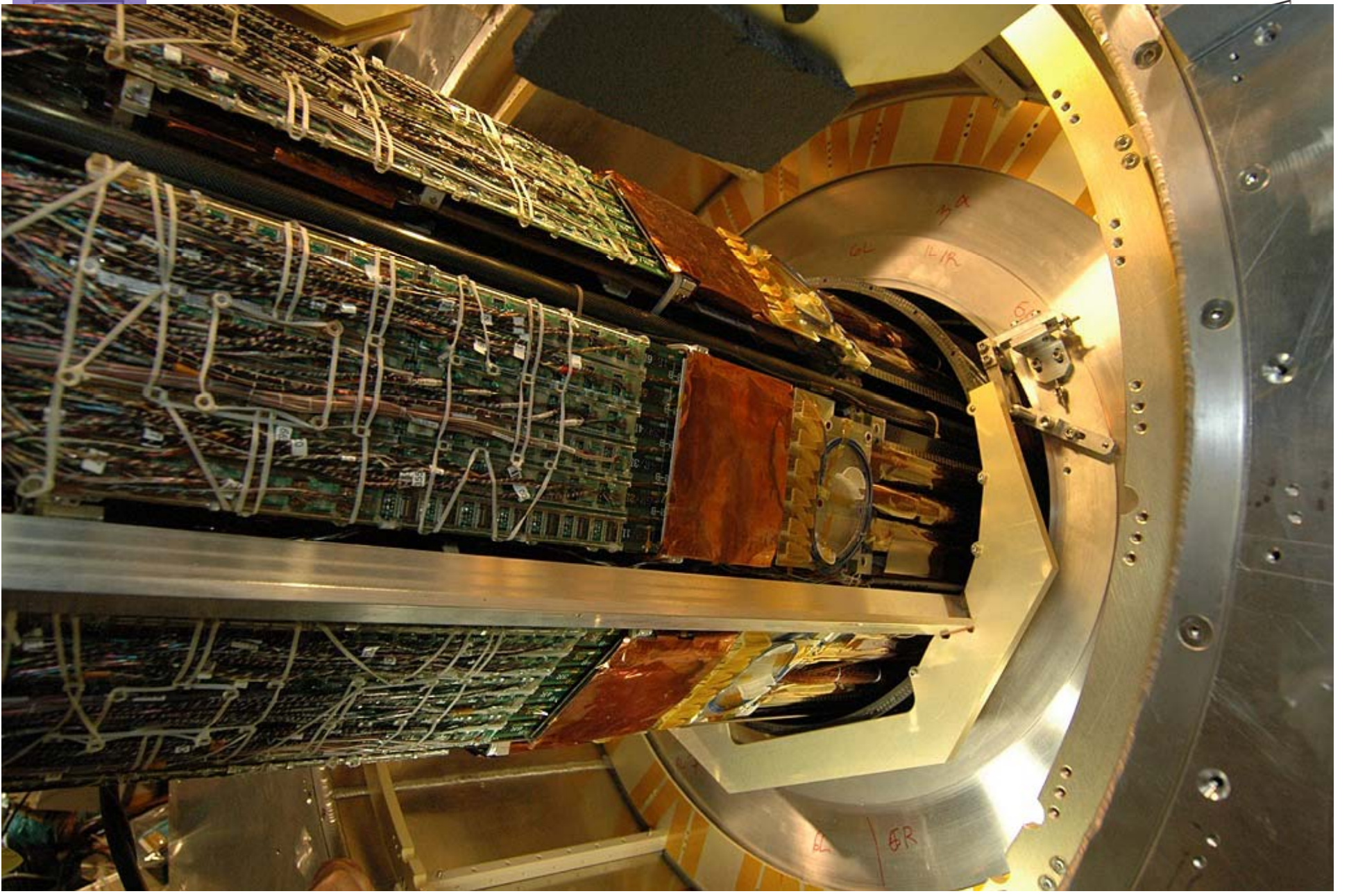

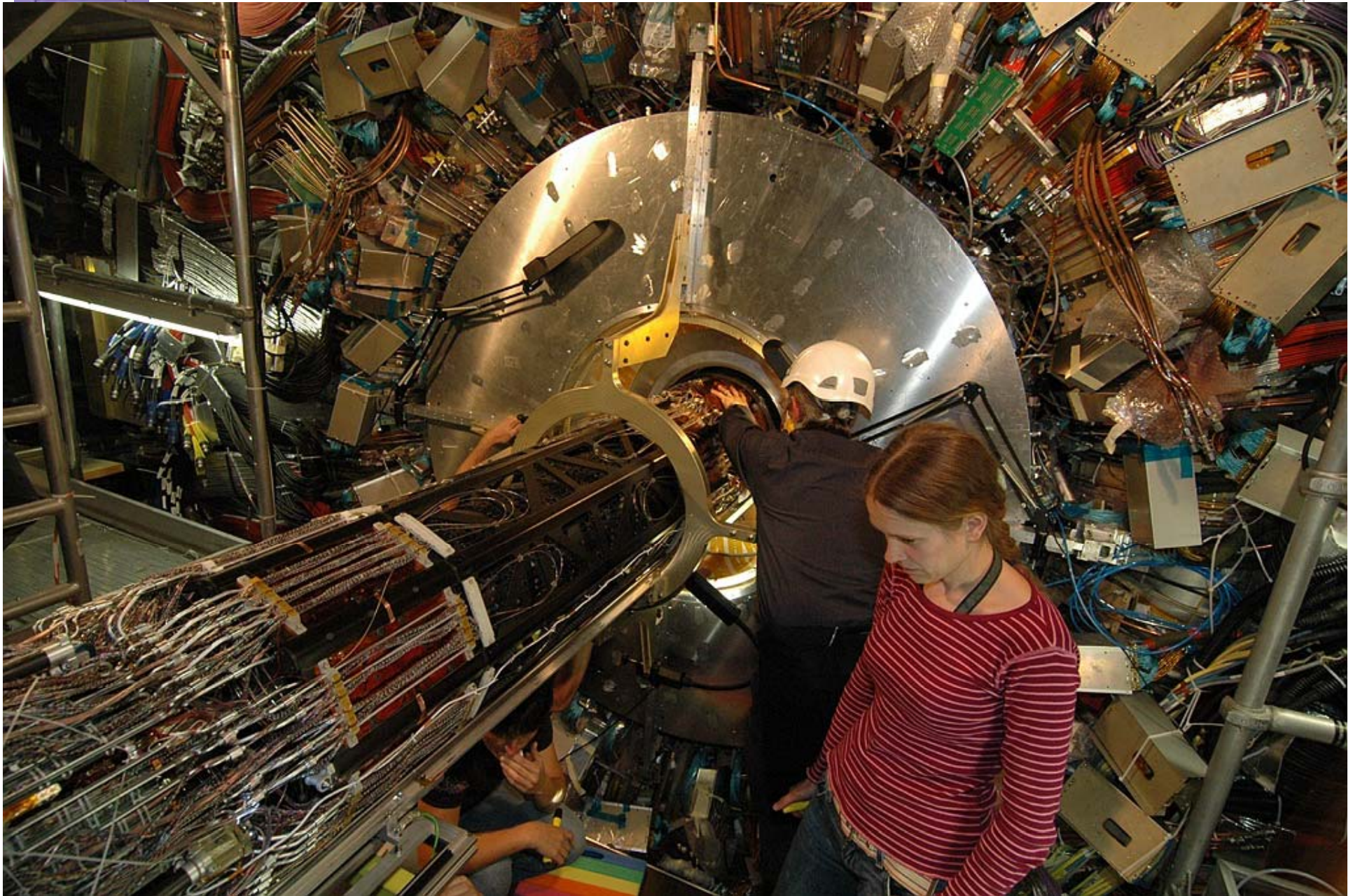

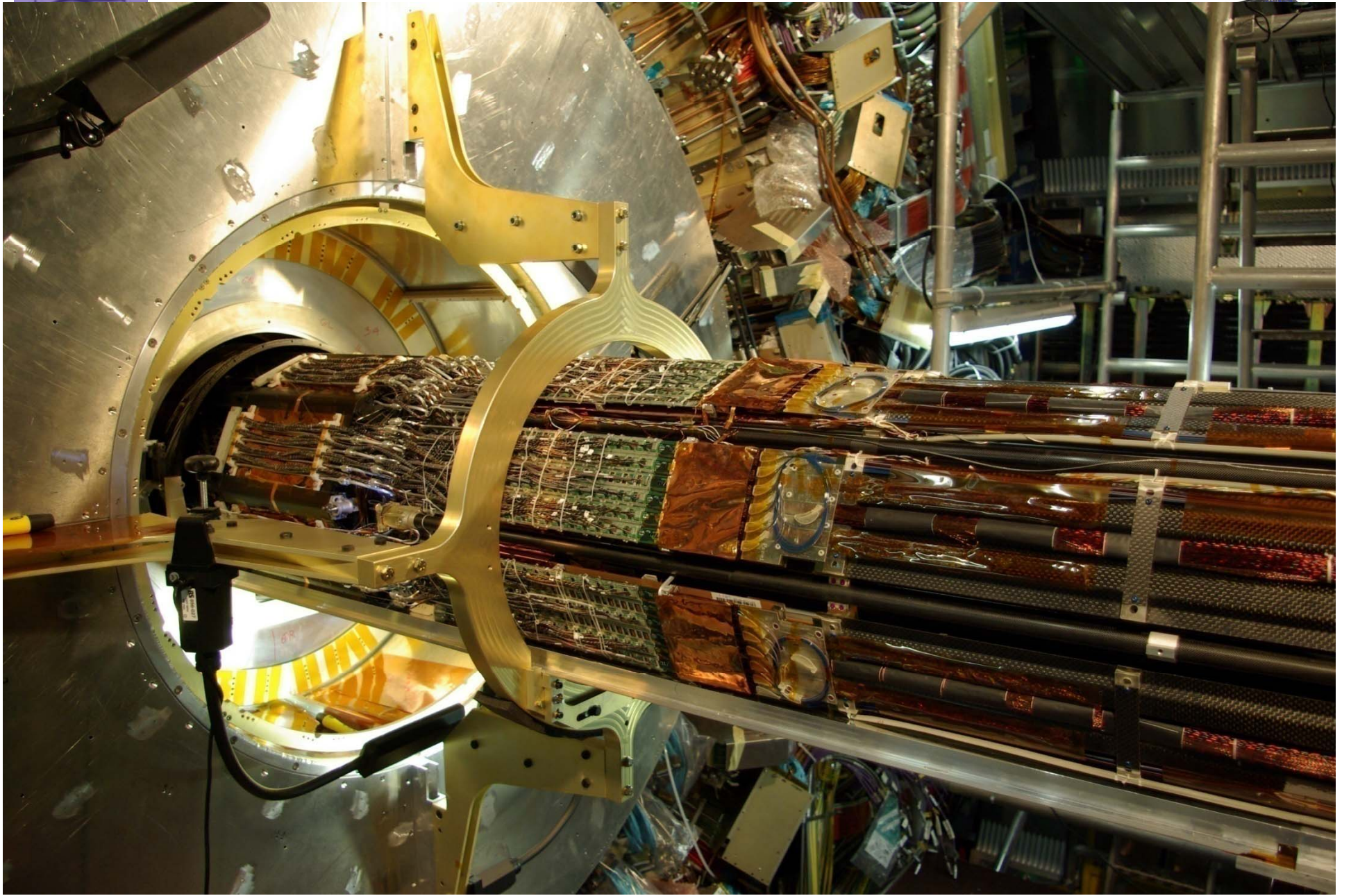

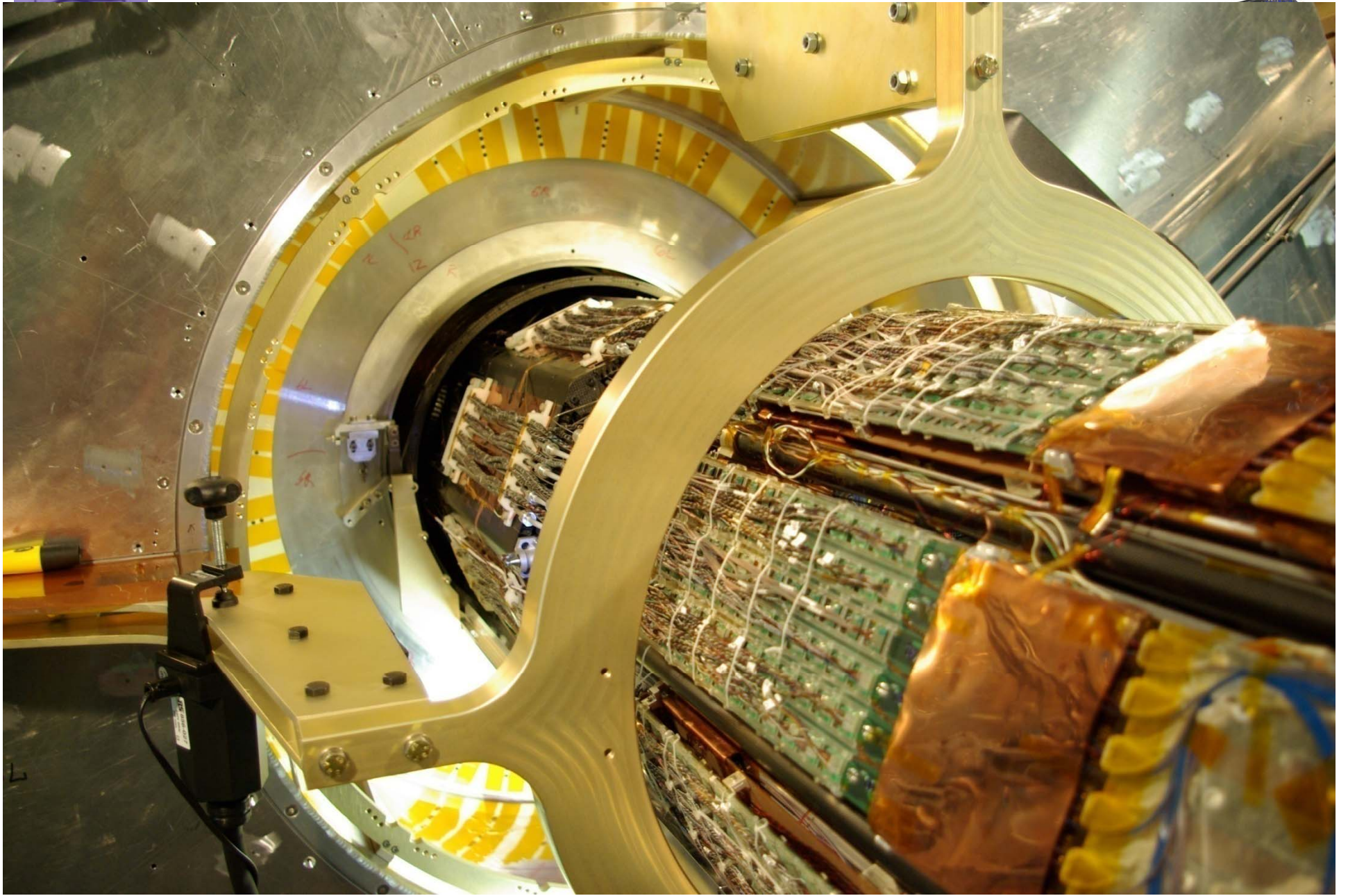

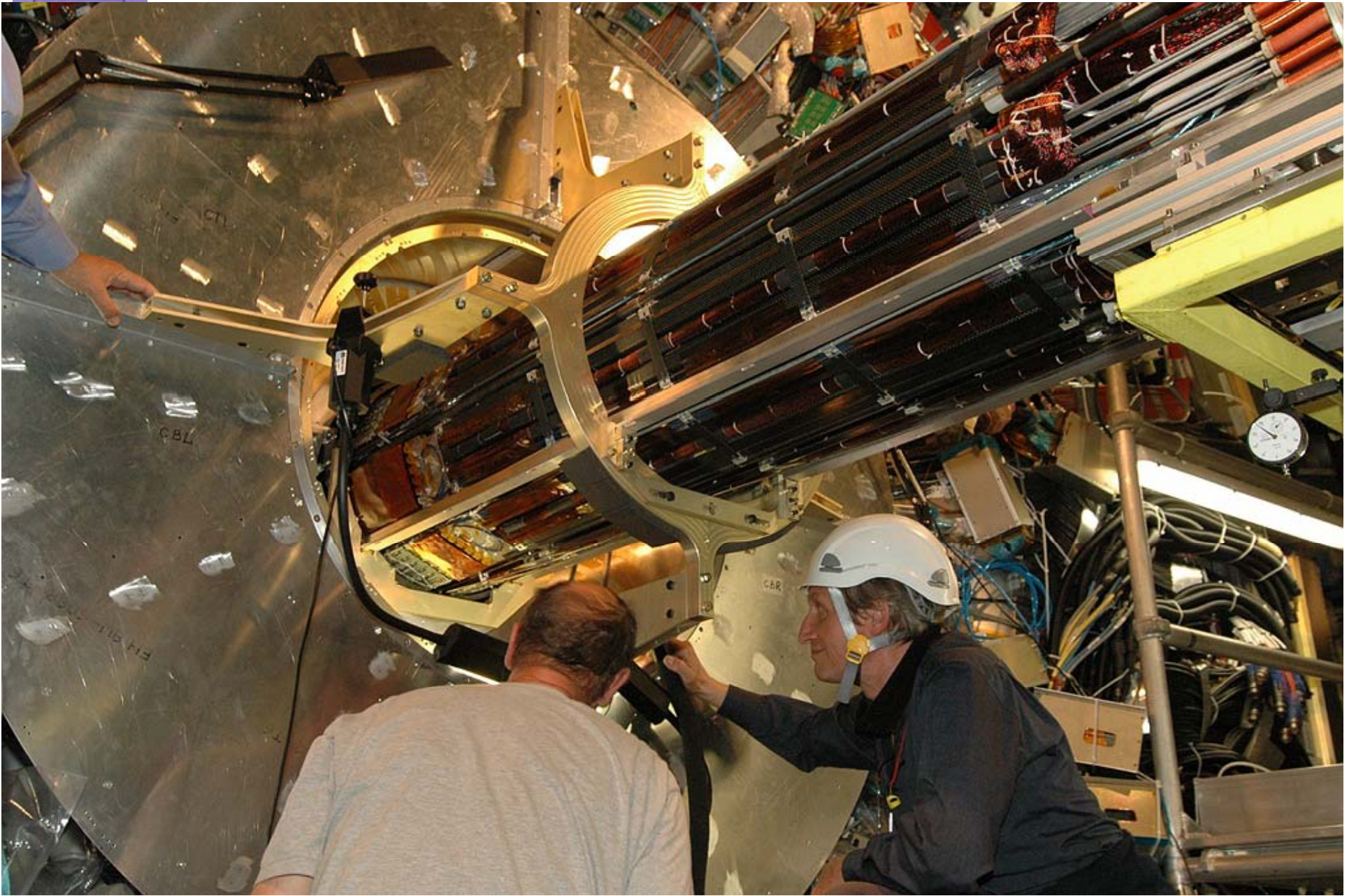

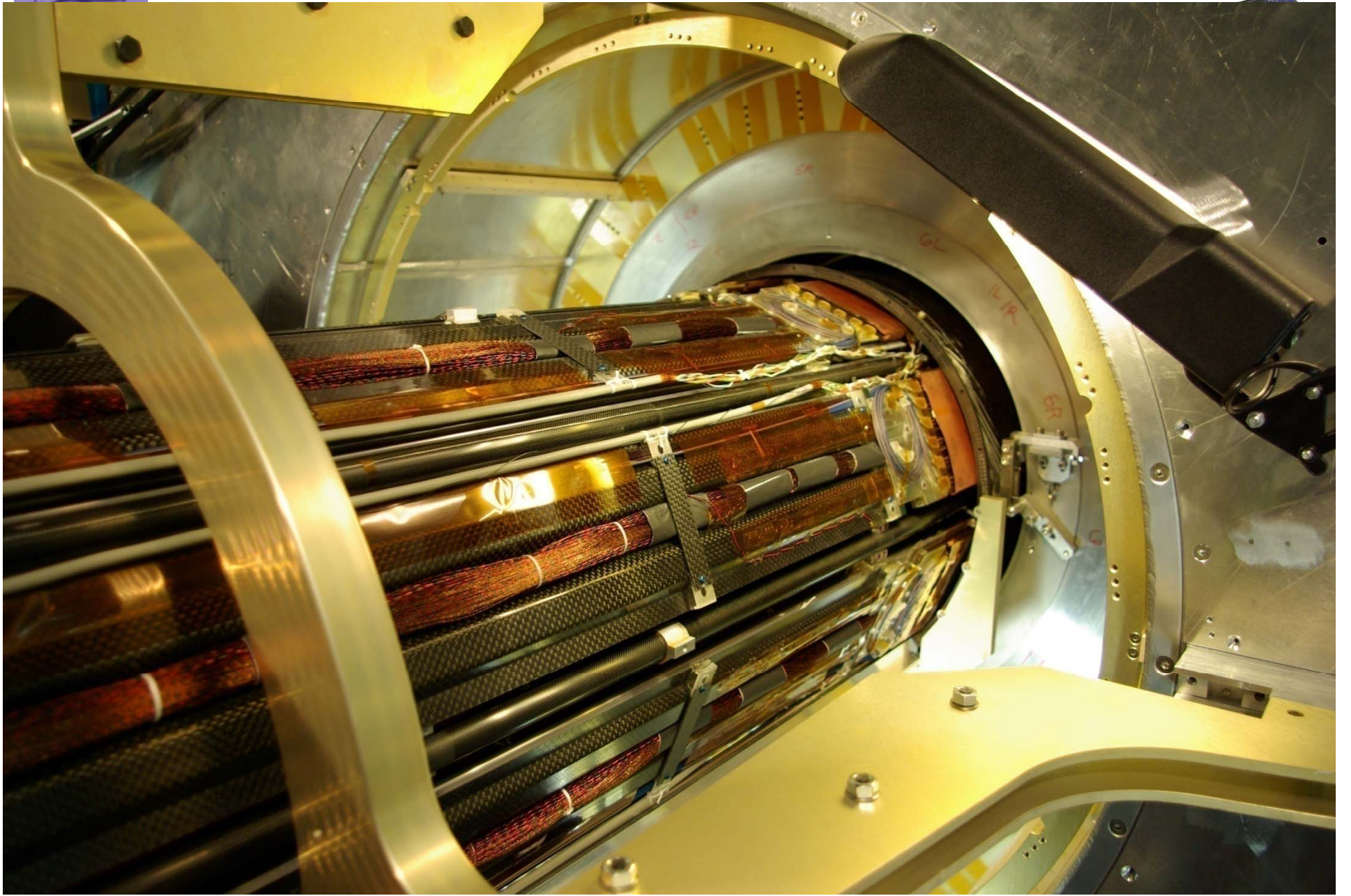

June 07

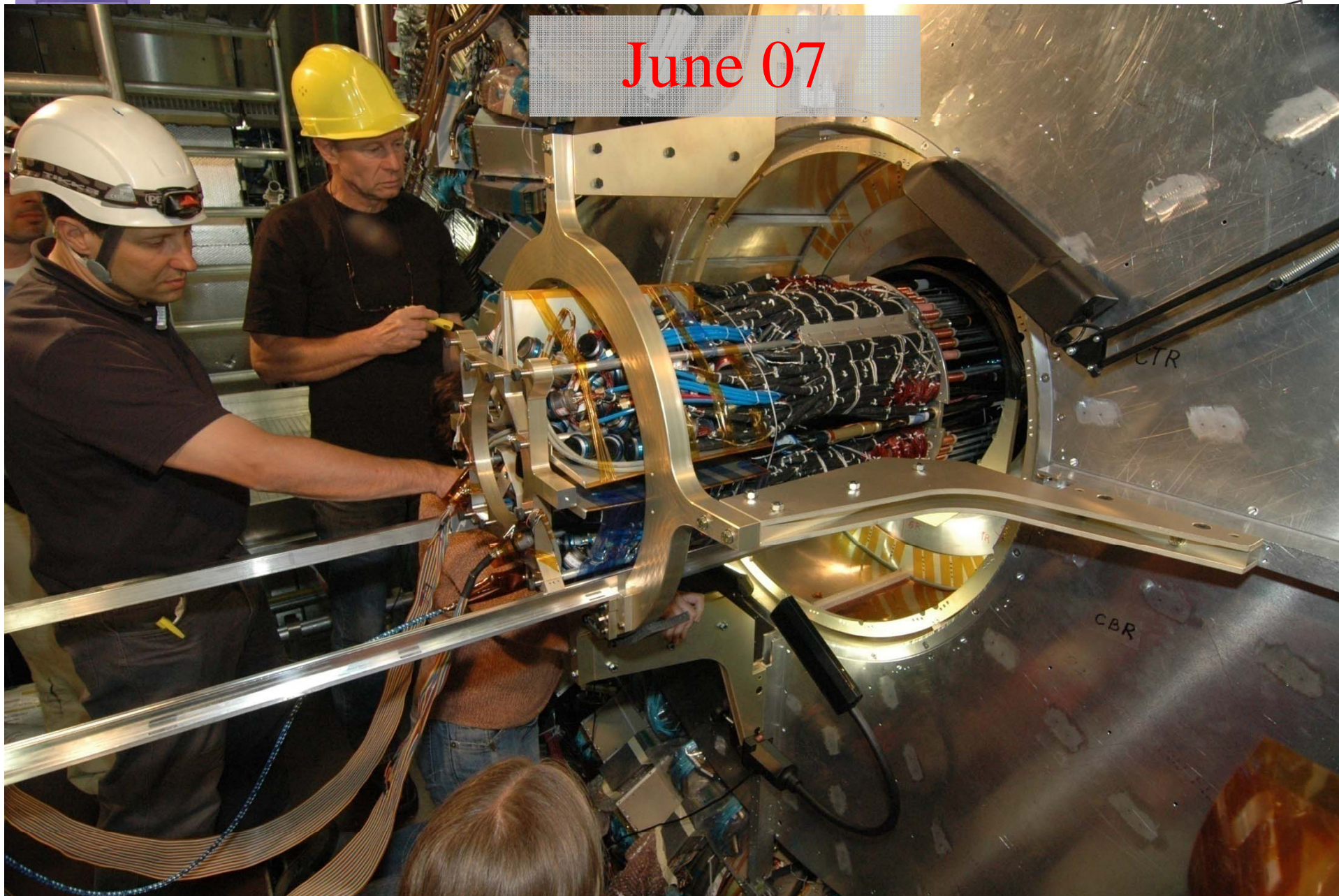

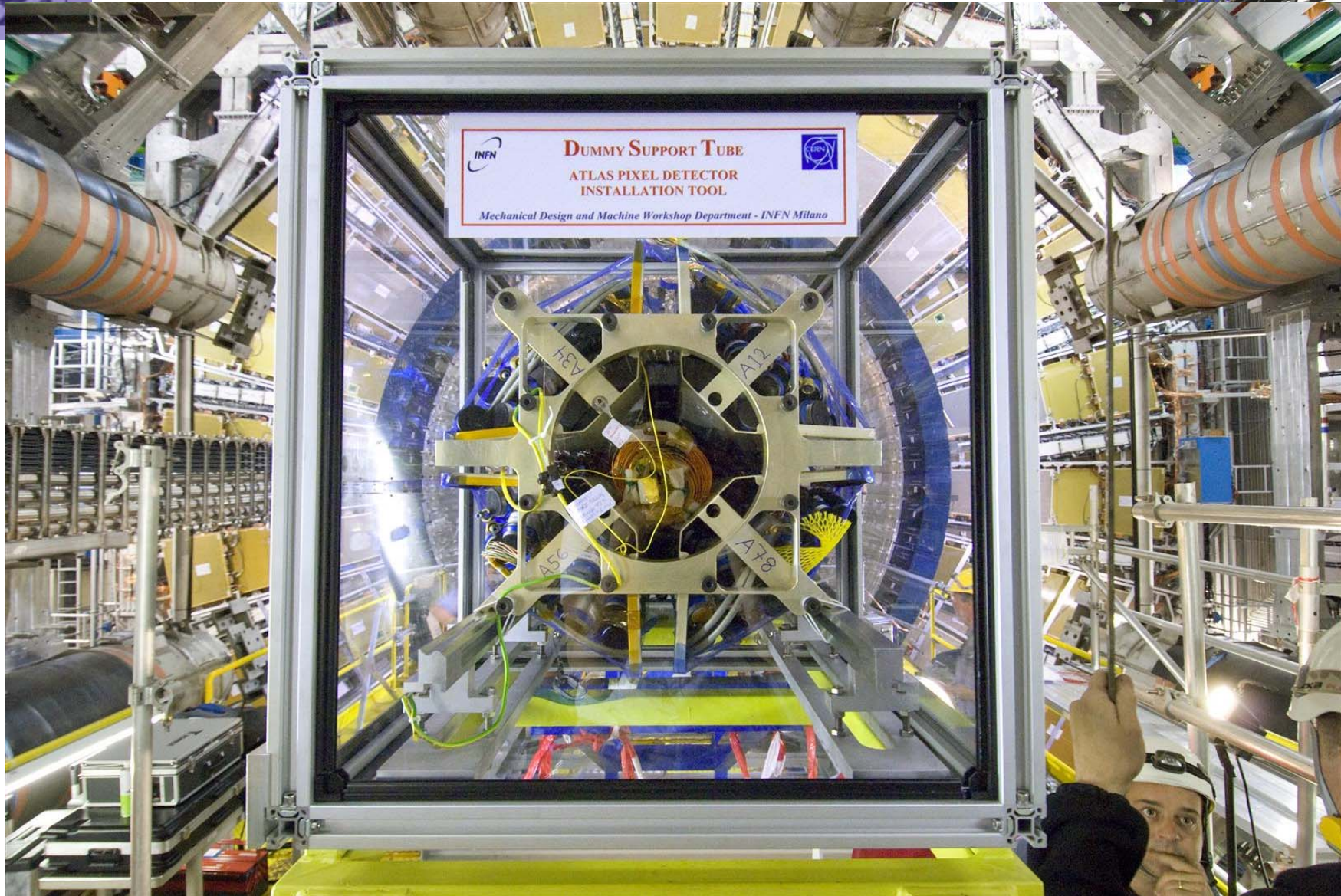
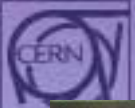

A photograph showing a dense arrangement of cables and conduits. The cables are bundled together and run through metal frames. A red dashed circle highlights a specific area where several white cables are bundled together. The overall scene is a technical setup, likely for a large-scale experiment or data center.

... BUT

April 08



Corrosion again !!!

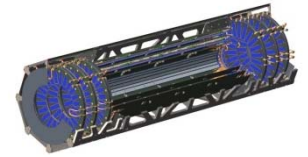

- During the installation of the last section of pipes right before the commissioning, defects inside the pipes have been noticed.
- The analysis revealed a pitting corrosion induced by chemical contamination.
- Pipes assemblies have been re-built under rush... and again a corrosion patterns have been found.
- Still the event has not been properly analyzed but preliminary indications exclude evident mistreatments.



Conclusions

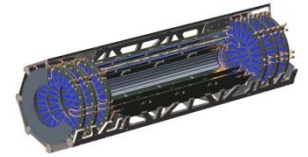

Mistakes and errors are a kind of “normality” in any project. I would like to outline the most common sources in our field:

Design phase

- Requirements are often over estimated. In particular the geometrical accuracy of the detector drives to complicated and expensive solutions. Complicated things usually do not work better!
- Mass of the detector tends always to be underestimated. Needs to keep track of the mass budget during the evolution of the design.
- The concurrent engineering can be a solution for widely distributed collaboration but the technical coordination has to be centralized.

Formal reviews plan is mandatory.

- Risk assessment has to be part of the game since the beginning and the design should take care of its indications.



Conclusions (2)

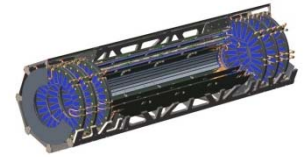

Production phase

- The quality assurance plan is the tool to nail down and mitigate the effects of the production unconformities: need qualification procedure for each single part.
- Book keeping and traceability of single parts that mount onto the detector.
- Only qualified and trained people should work on the production parts. The quality of the manpower is what makes the difference.