



LHeC Status

John Dainton

Cockcroft Institute and Univ Liverpool,
Daresbury Science and Innovation Campus, GB

1. Why?
2. LHeC with and for the physics - some snapshots
3. Machine steering group
4. Experiment
5. When: Towards a CDR

<http://www.lhec.org.uk>

Polarised Positron
Workshop
Meeting
Cockcroft Institute
March 28th 2008

THE COCKCROFT INSTITUTE
of ACCELERATOR
SCIENCE and TECHNOLOGY



UNIVERSITY OF
LIVERPOOL



1. Why?

Why? The Energy Frontier

- 1968-1986

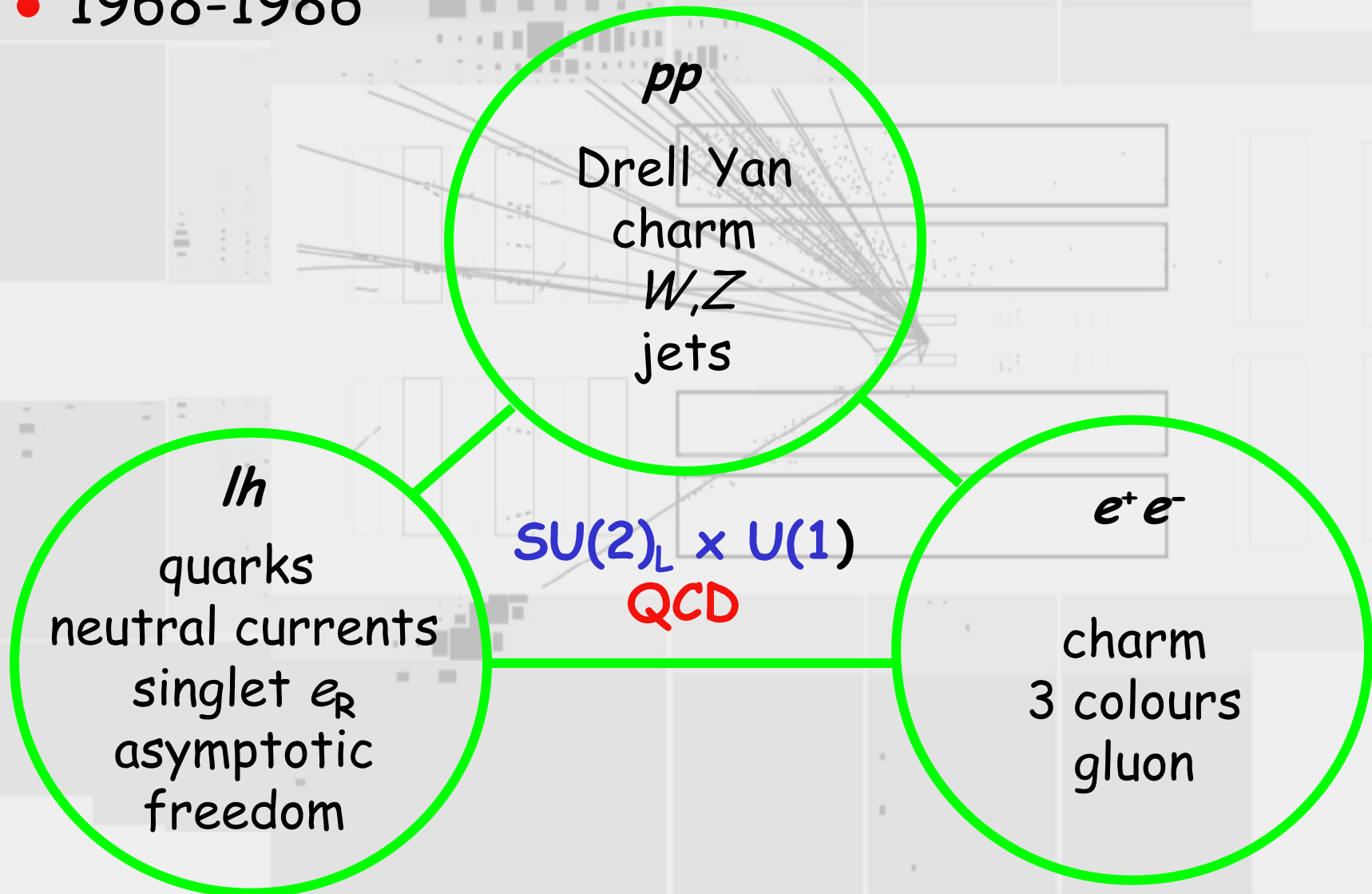

Why? The Energy Frontier

- 1986-2010
Fermi scale

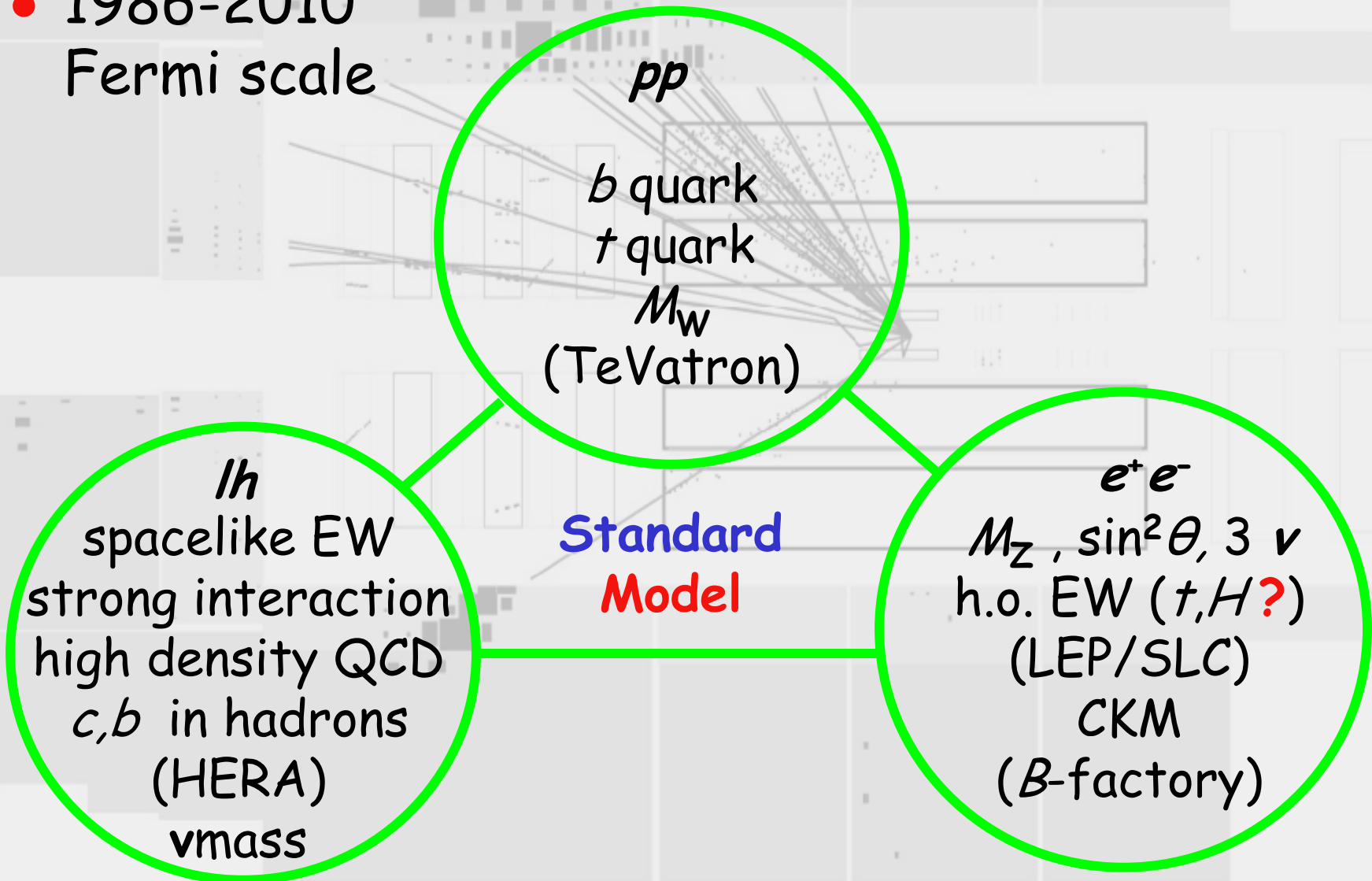

Why? The Energy Frontier

- 2008-2033?

Terascale

pp
TeV discovery ?
Higgs?
new particles?
new symmetries?
(LHC)

lh
TeV discovery
& precision ?
particles ?
symmetries ?
dense QCD
(LHeC)

Beyond
Standard
Model
new physics

e^+e^-
 $t\bar{t}$
discovery &
precision ?
spectroscopy
Higgs ?
(ILC/CLIC)

Why? The Matter Frontier

- 2008-2033?
chromodynamic
creation ?

AA
QGP ?
QCD phase
equilibria?
nuclear dynamics?
nuclear formation
(LHC)

lepton A
QCD dof @
extremes
strong QCD $\leftrightarrow 1_c$
(LHeC)

matter creation
new physics

e^+e^-
pQCD
(ILC/CLIC)

Why: Leptons \leftrightarrow Quarks ?

- how are leptons and quarks related ?

THE UNCONFINED QUARKS AND GLUONS

Abdus Salam

International Centre for Theoretical Physics,
Trieste, Italy and Imperial College, London,
England

1. Introduction

Leptons and hadrons share equally three of the basic forces of nature: electromagnetic, weak and gravitational. The only force which is supposed to distinguish between them is strong. Could it be that leptons share with hadrons this force also, and that there is just one form of matter, not two?

ICHEP76 Tblisi

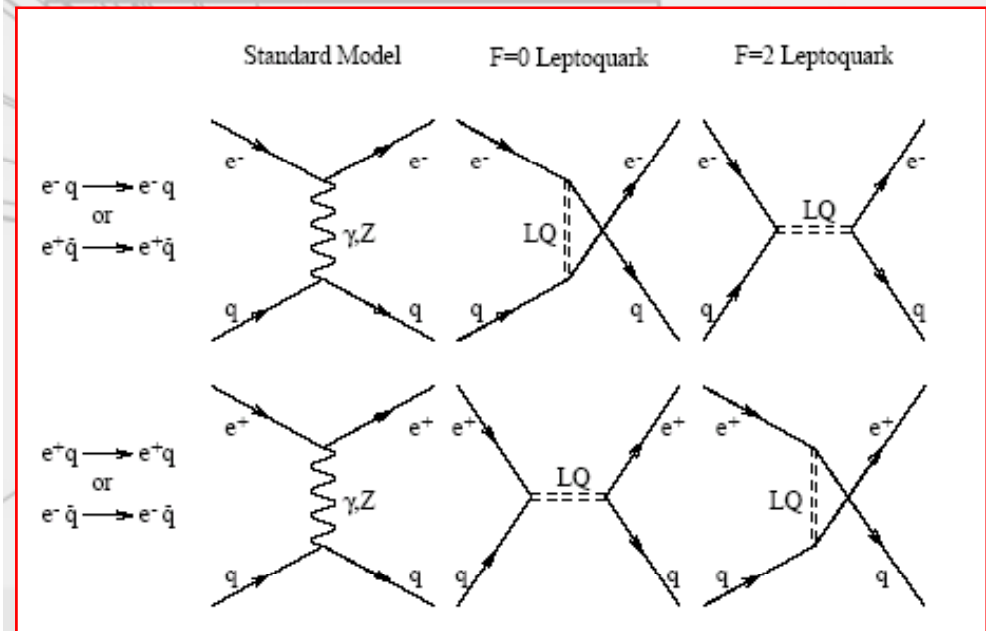

- put them together at the highest energy in the finest detail

Lepton+quark @ TeV



- unique chiral probe @ 0.0001 fm ?
- 70 $e^\pm \otimes p$ 7000 GeV
cm energy < 1.4 TeV

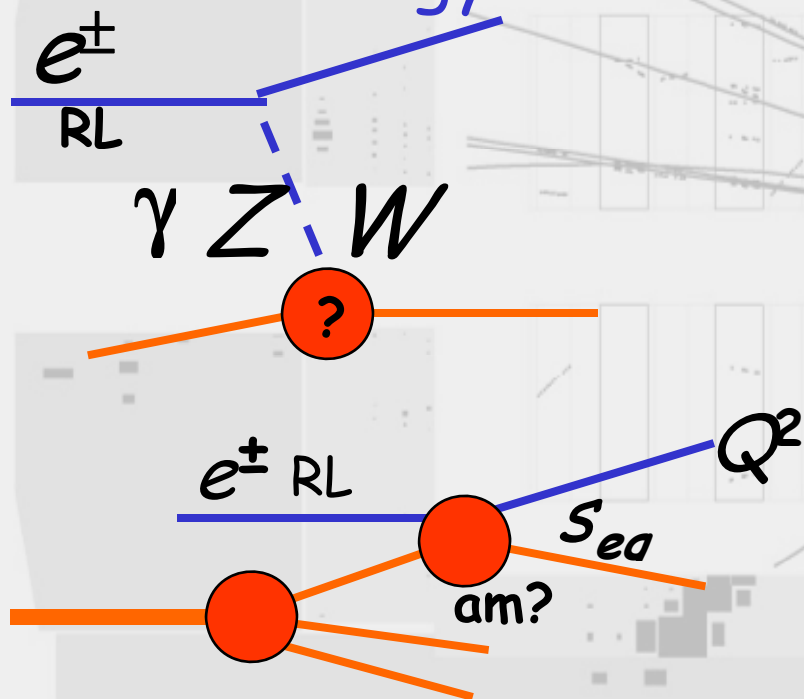

SM + new Lq physics
@ ~ 0.0001 fm ?

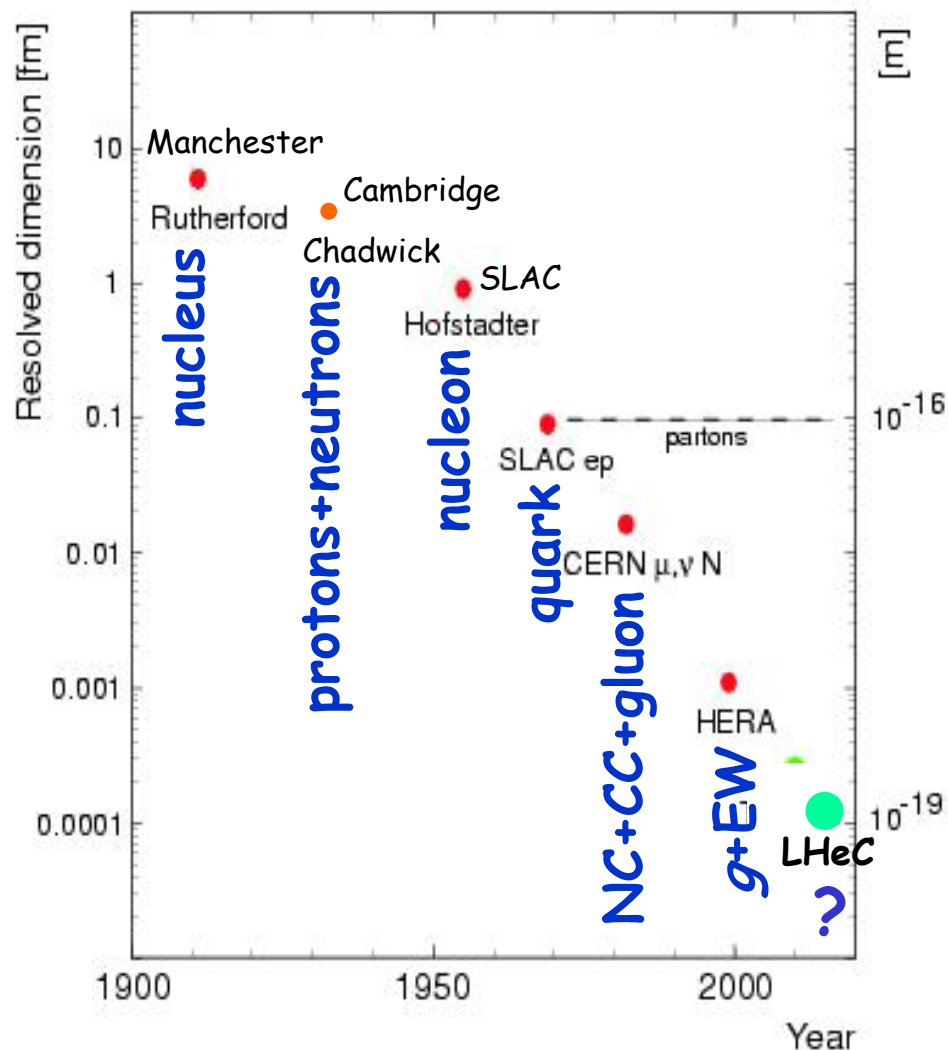

Why: Structure @TeV



- unique chiral probe @ 0.0001 fm ?

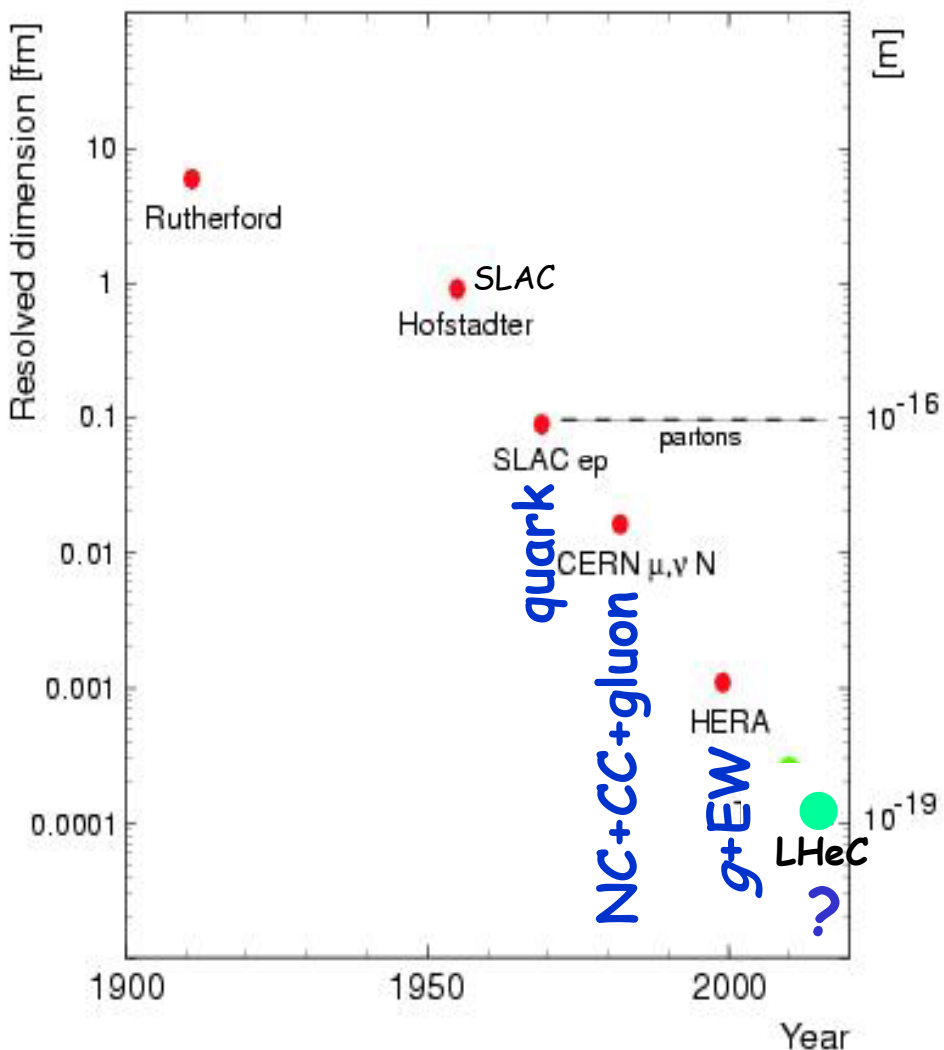
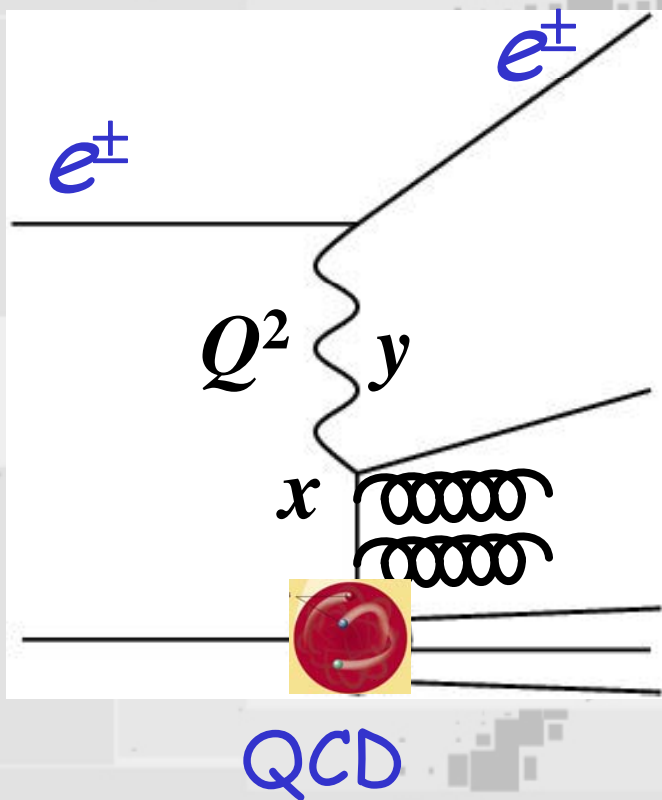

SM + q structure
@ ~ 0.0001 fm ?

Why? The Scope

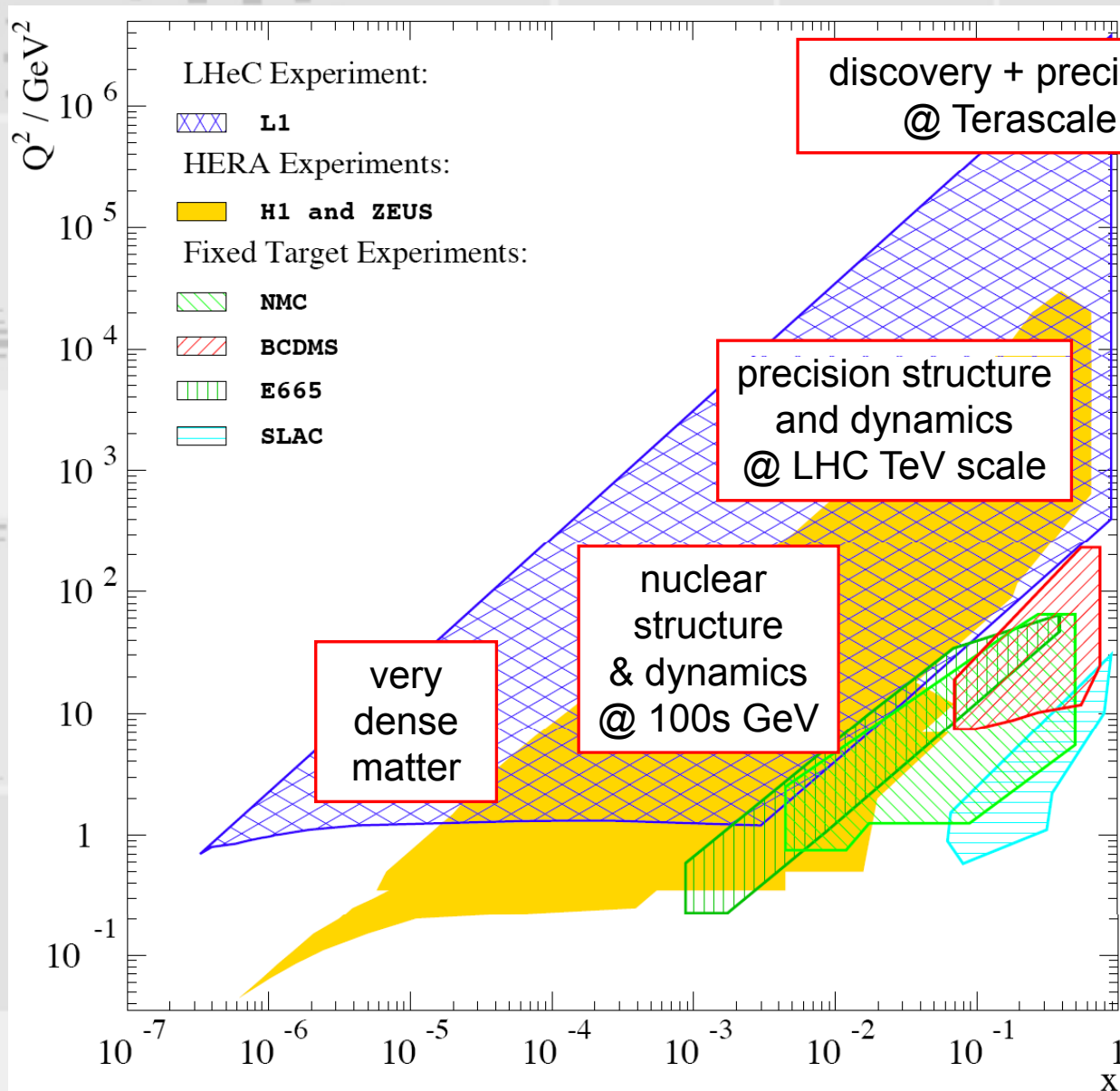

TeV eq Kinematic Reach

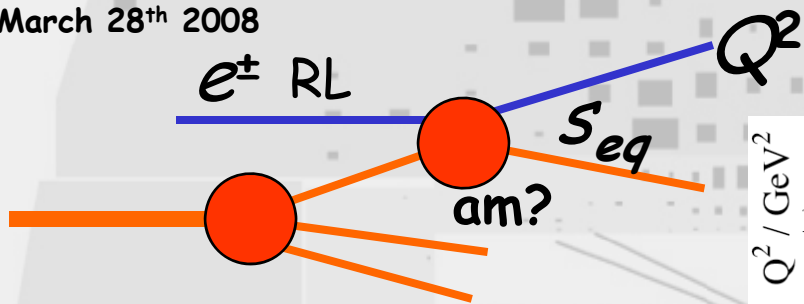

- 2007: HERA
 - $Q^2 \leq 30,000 \text{ GeV}^2$
 - $S_{eq} \sim (300 \text{ GeV})^2$
in $\sim 0.7 \text{ am}$
- $\geq 20..?$: LHeC
 - $Q^2 \leq 4 \times 10^6 \text{ GeV}^2$
 - $S_{eq} \leq (4000 \text{ GeV})^2$
in $\sim 0.1 \text{ am} !$

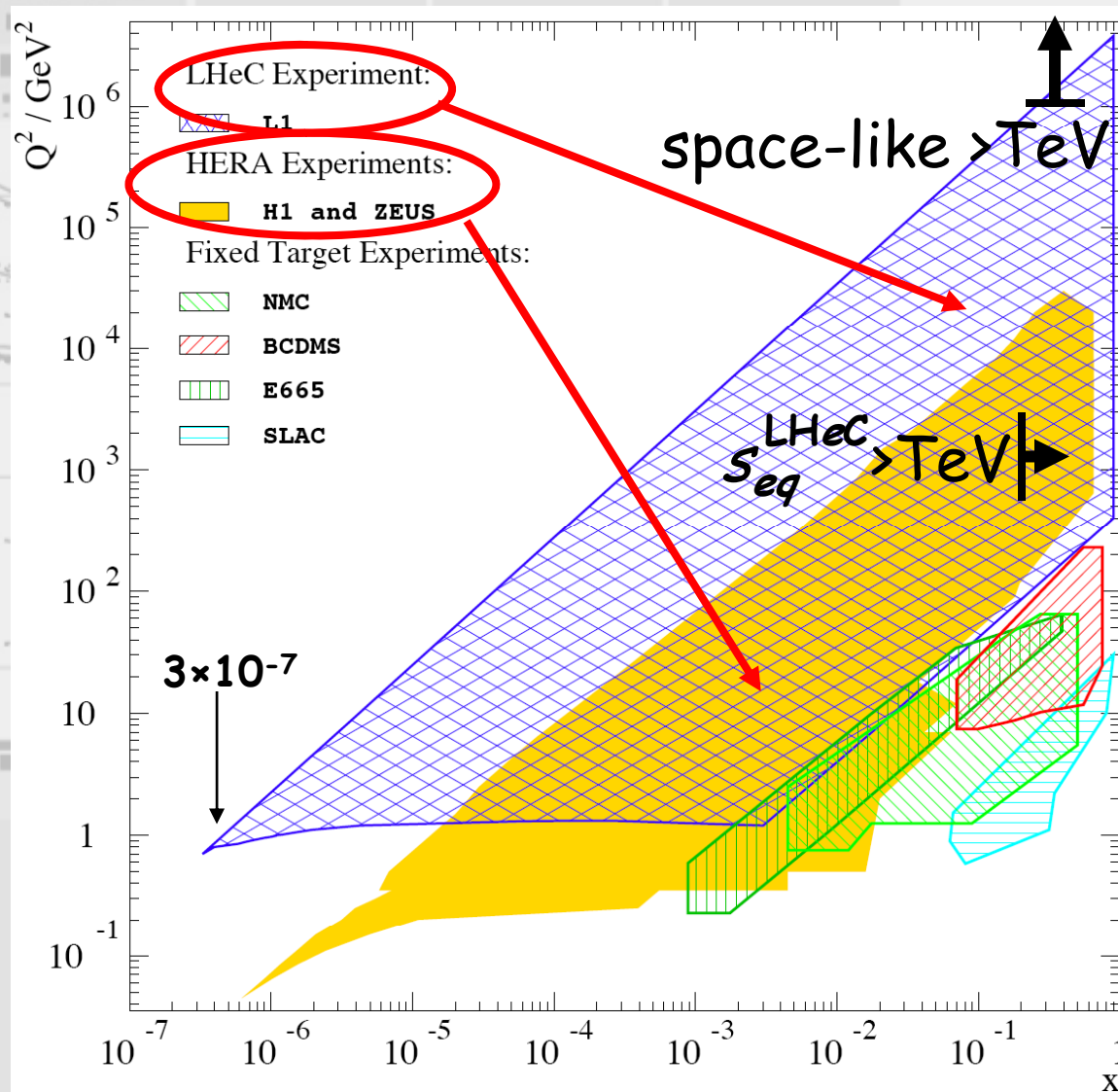

Why: Dense Colour ?



Most of the mass of ordinary matter is concentrated in protons and neutrons. It arises from ... [a]... profound, and beautiful, source.

Numerical simulation of QCD shows that if we built protons and neutrons in an imaginary world with no Higgs mechanism - purely out of quarks and gluons with zero mass - their masses would not be very different from what they actually are. Their mass arises from pure energy, associated with the dynamics of confinement in QCD, according to the relation $m = E/c^2$. This profound account of the origin of mass is a crown jewel in our Theory of Matter.

Frank Wilceek CERN October 11, 2000

- probe hadronic matter at highest parton density

QCD is headline stuff !

- found on a Guardian newspaper web page

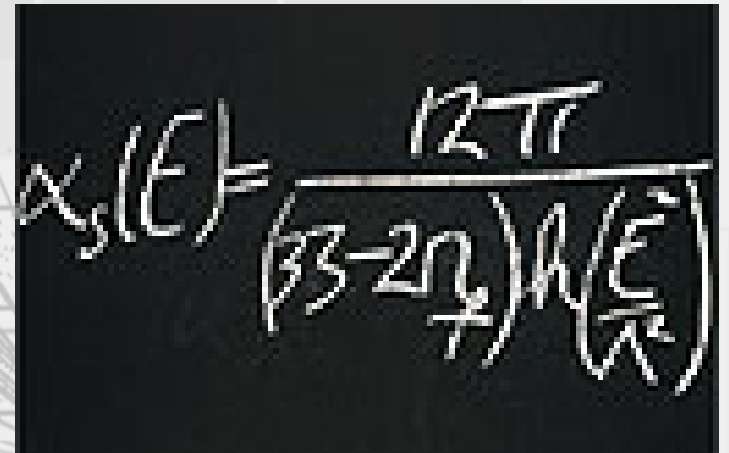
$$\alpha_s(E) = \frac{12\pi}{(33 - 2n_f) \hbar(E)}$$

- found on Frank Wilce's blackboard

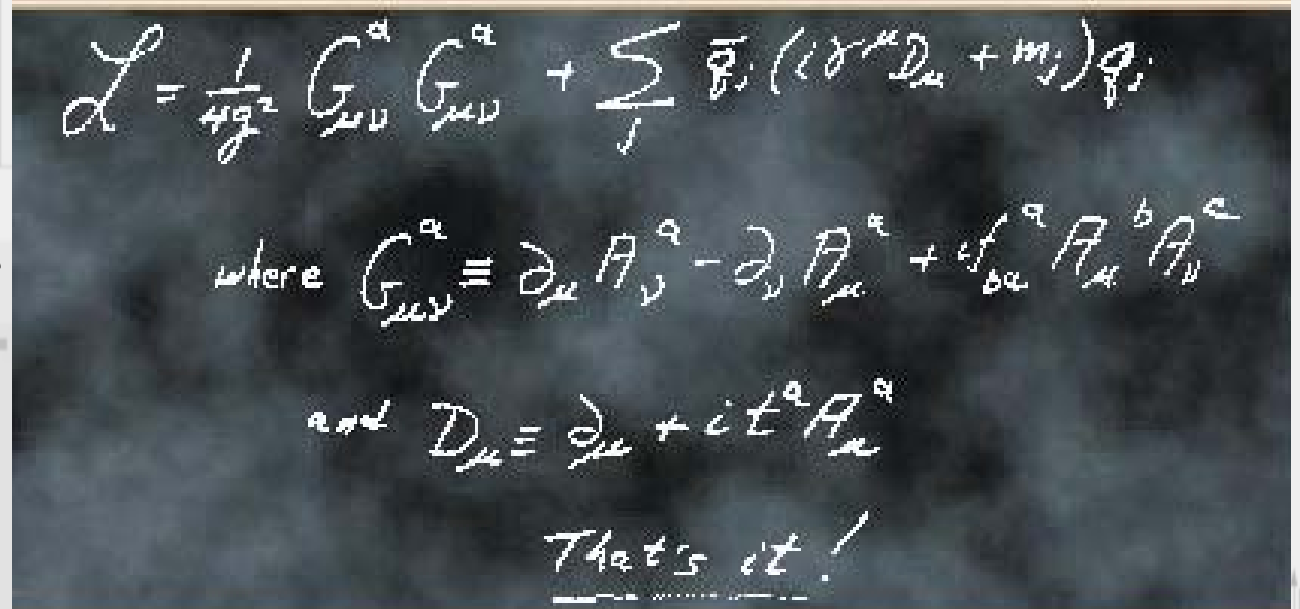
$$\mathcal{L} = \frac{1}{4g^2} G_{\mu\nu}^a G_{\mu\nu}^a + \sum_i \bar{\psi}_i (i\gamma^\mu D_\mu + m_i) \psi_i$$

where $G_{\mu\nu}^a \equiv \partial_\mu A_\nu^a - \partial_\nu A_\mu^a + gf_{bc}^a A_\mu^b A_\nu^c$

and $D_\mu \equiv \partial_\mu + ig A_\mu^a$

That's it!

TeV ep Kinematic Reach



• ~~20017~~:? HERAC

- $Q^2 \geq 1 \text{ GeV}^2$

- $x_{Bj} \geq 5 \times 10^{-5}$

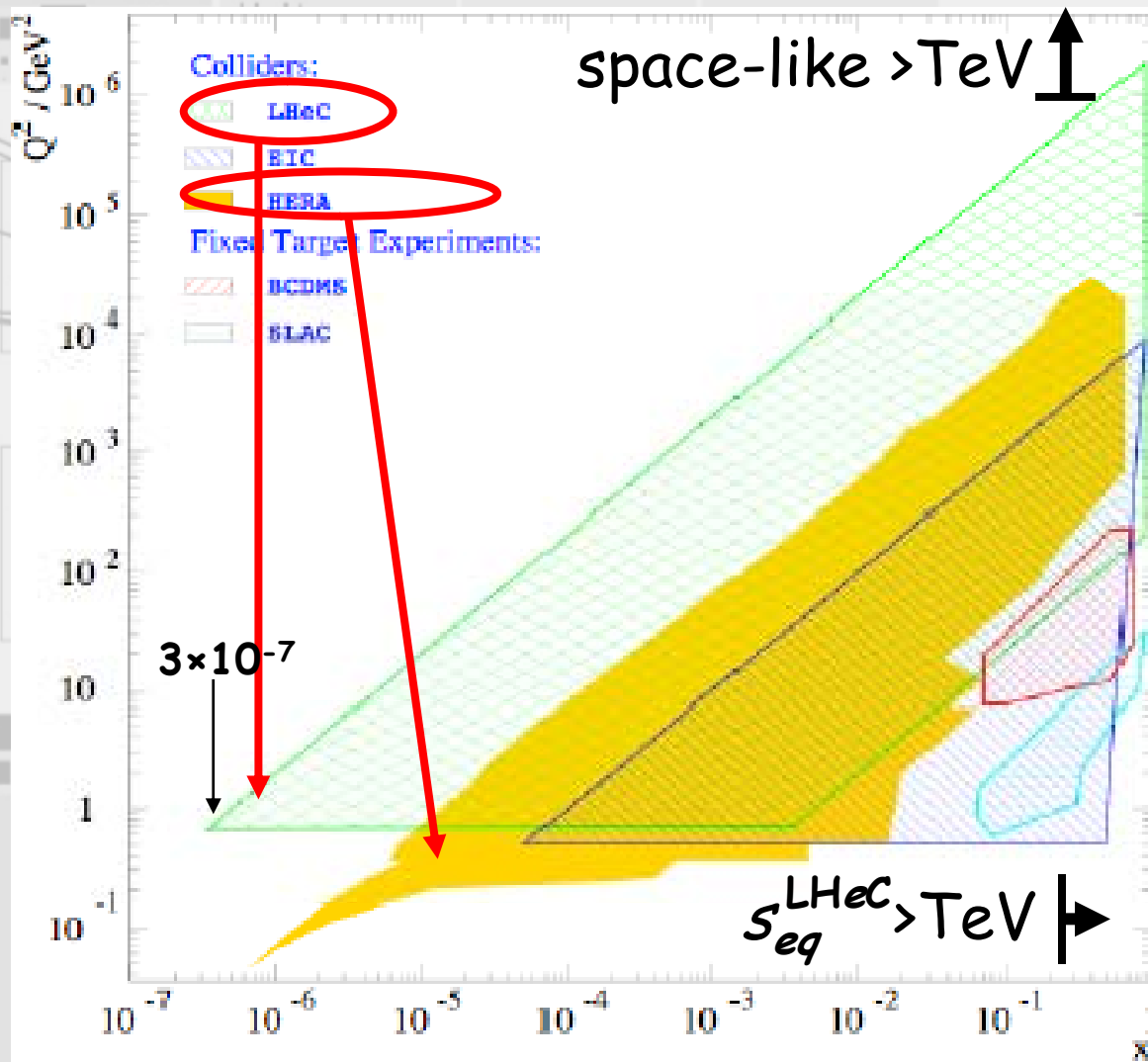
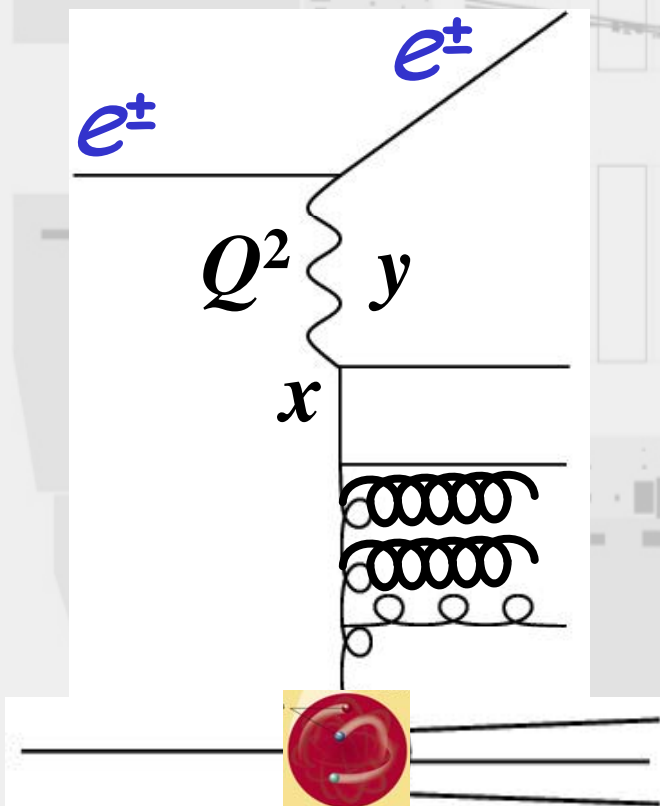

Gluon recombination

- $\geq 20..?$: LHeC
 - $Q^2 \geq 1 \text{ GeV}^2$
 - $x_{Bj} \geq 5 \times 10^{-7}$
- $Q^2 \rightarrow$ size of gluons
- $x_{Bj} \rightarrow$ phase space for gluons

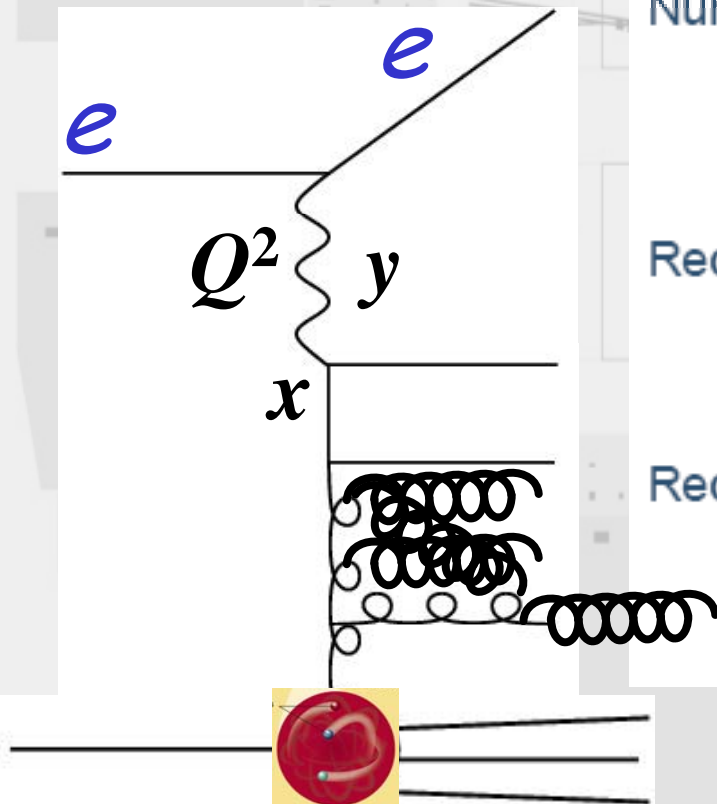

Number of gluons per unit area:

ρ and A

$$\rho \sim \frac{xG_A(x, Q^2)}{\pi R_A^2}$$

Recombination cross-section:

$$\sigma_{gg \rightarrow g} \sim \frac{\alpha_s}{Q^2}$$

Recombination happens if $\rho \sigma_{gg \rightarrow g} \gtrsim 1$, i.e. $Q^2 \lesssim Q_s^2$, with:

$$Q_s^2 \sim \frac{\alpha_s x G_A(x, Q_s^2)}{\pi R_A^2} \sim A^{1/3} \frac{1}{x^{0.3}}$$

low x large nuclei

Polarised Positron
Workshop
Meeting
Cockcroft Institute
March 28th 2008

THE COCKCROFT INSTITUTE
of ACCELERATOR
SCIENCE and TECHNOLOGY



UNIVERSITY OF
LIVERPOOL



2. LHeC physics - some snapshots

Lepton+quark @ TeV

- leptoquark systems - new physics + SM

LHC

LHeC

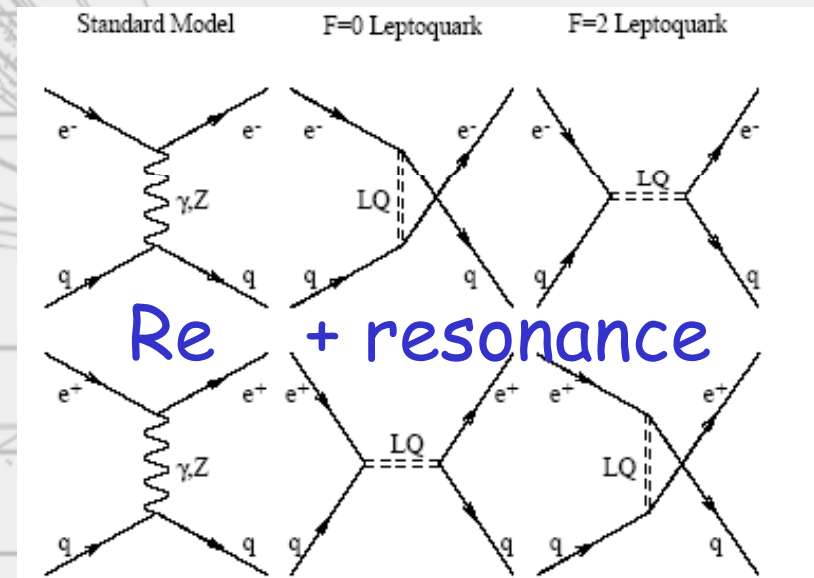
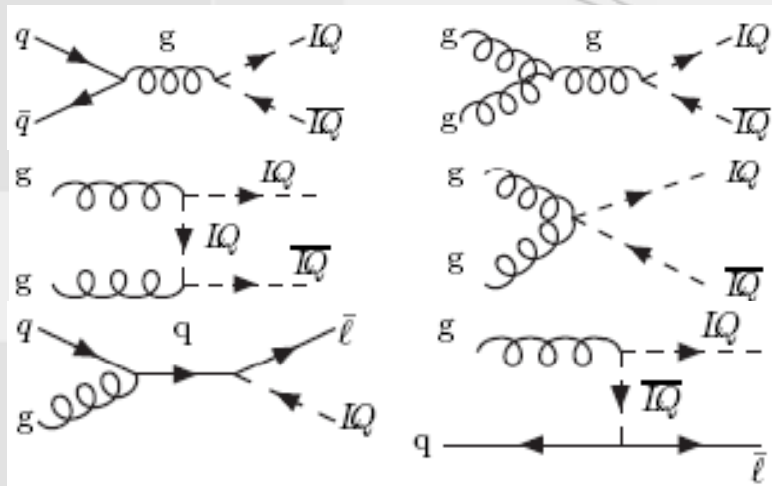

SM (hadronic) + signal
 Lq & $LqLq$ production
 $\sigma \sim \text{few} \times 0.1 \text{ fb} (\Lambda=0.1)$

SM (electroweak) + signal
 Lq formation
 $\sigma \sim 100 \text{ fb} (\Lambda=0.1)$

Lepton+quark @ TeV



- leptoquark systems - new physics + SM

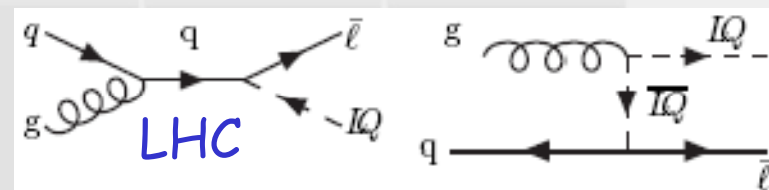
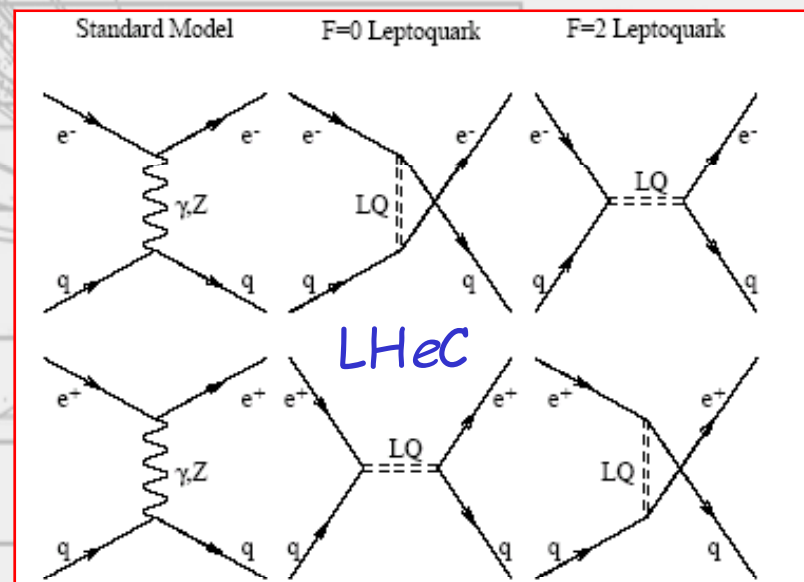
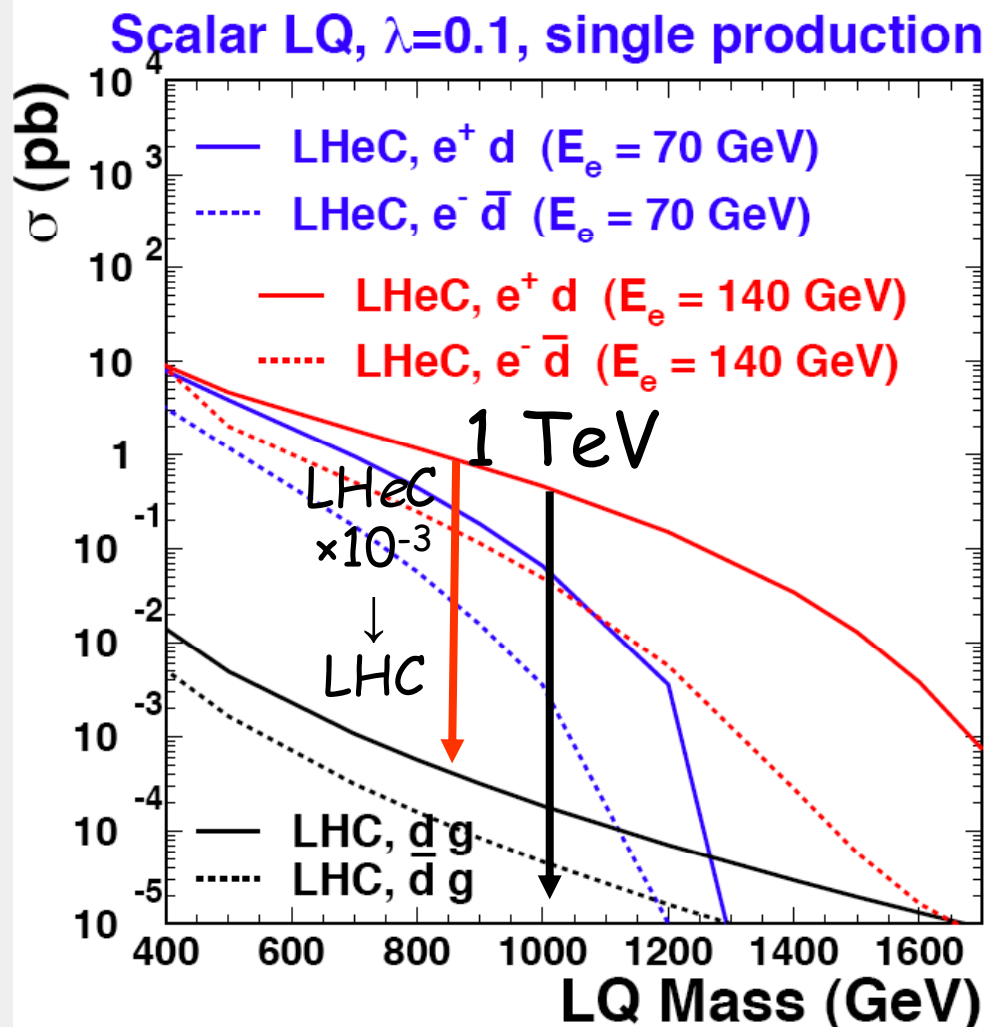

Lepton+quark @ TeV

LHC Lq pairs+decay

LHeC Lq formation+decay

fermion
number

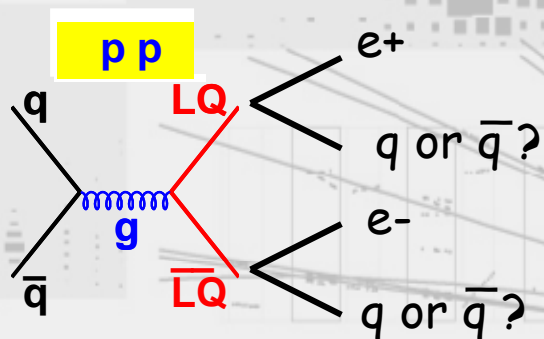

$e p$

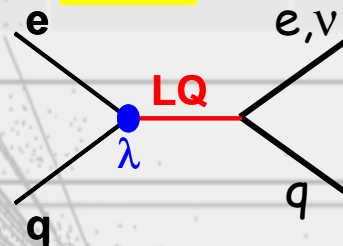

$e^+ F=0$
 $e^- F=2$

spin
parity
and
chirality

$\bar{q}q \rightarrow g \rightarrow \bar{L}q Lq$
production
mechanism ?
disentangle mass
spectrum ?

defined formation (e_{LR})
→ precision BRs (NC CC)

inclusive coherence

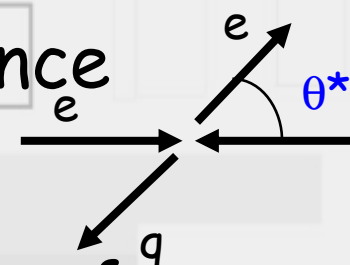

unique PWA

SM + signal + interference

experim!
signature

jets + leptons

jet+lepton+ p_T balance
jet + p_T imbalance

Lepton+quark @ TeV

LHC Lq + decay

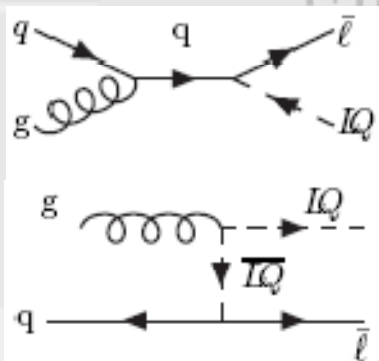

fermion
number

spin
parity
and
chirality

experim-
signature

$gq \rightarrow Lq \bar{l}$
production
mechanism ?
disentangle mass
spectrum ?

jet + leptons

LHeC Lq formation + decay

$e p$

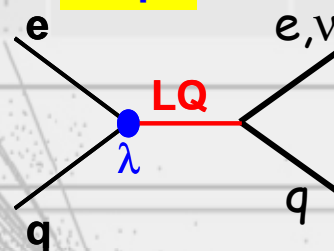

$e^+ F=0$
 $e^- F=2$

defined formation (e_{LR})
→ precision BRs (NC CC)

inclusive coherence

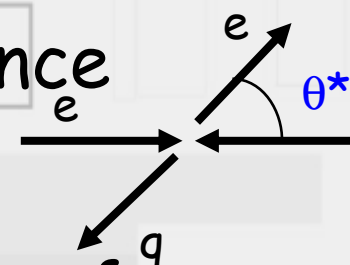

unique PWA

SM + signal + interference

jet+lepton+ p_T balance
jet + p_T imbalance

Unification ?

- precision → QCD at highest energy
- short distance structure of SM+
 - 2007 → @ 10^{-3} ppm
 - 2007 G_F @ 10 ppm
 - 2007 G @ 0.1%
 - 2007 α_s @ 1-2%
 - LHeC + detector → α_s @ few %

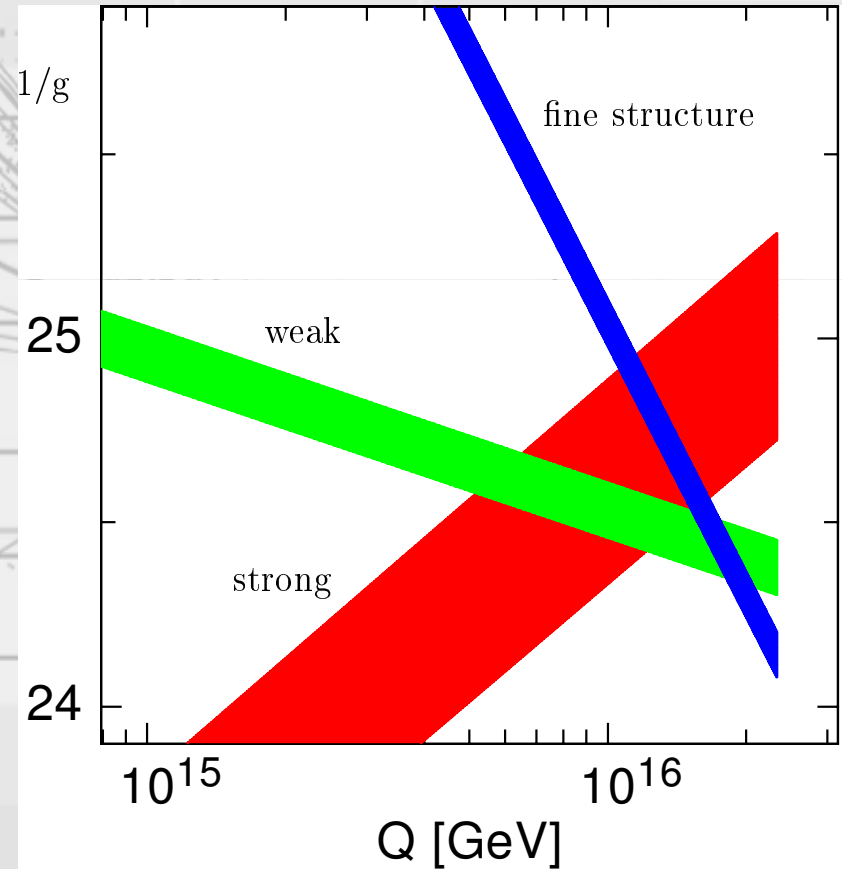

precision → extrapolation → discovery
probe new chromodynamic physics - beyond SM ?

Lepton-Parton and Parton-Parton ?

- $ep \rightarrow eX$

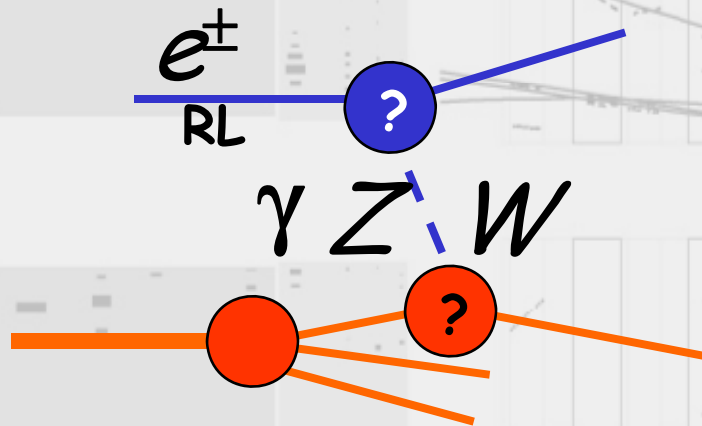

- LHeC energy scale:
 $70 \times 7000 \text{ GeV}$

probe = e^\pm

- $pp \rightarrow (\text{jet} + \text{jet})X$

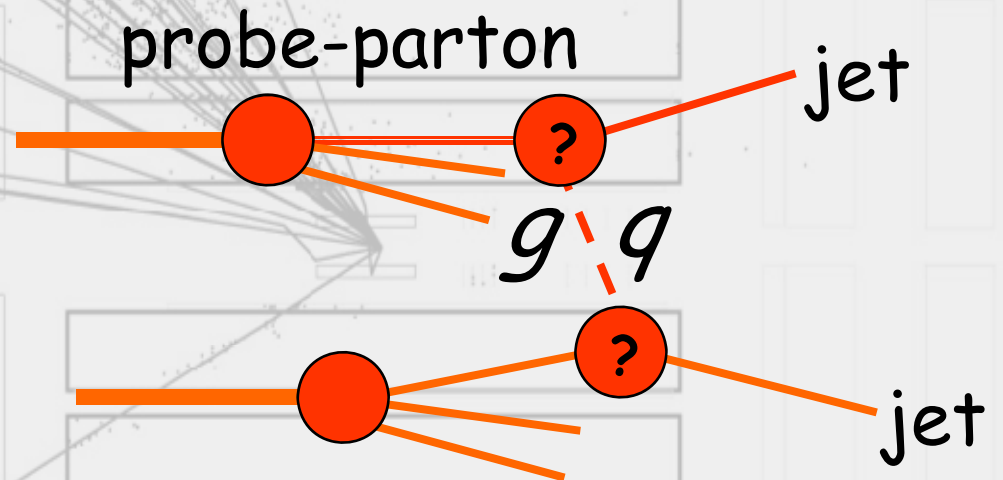

- pp energy scale:
 $7000 \times 7000 \text{ GeV}$

probe + p at LHeC scale

$x_{\text{probe}/p} = 0.01$

LHC probe parton

- probe-parton @ $x \leq 0.01$

$$- xq = xU + xD + x\bar{U} + x\bar{D}$$

$g : q \sim 2:1$ mixed

- probe-parton @ $x \gg 0.01$

$g : q \rightarrow 0$ all quark

↪ "mixed" LHC probe
@ LHeC energy
 q LHC probe
@ LHC top energy

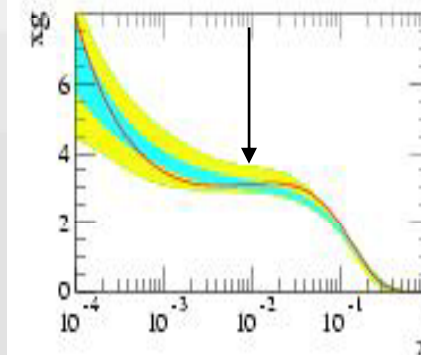
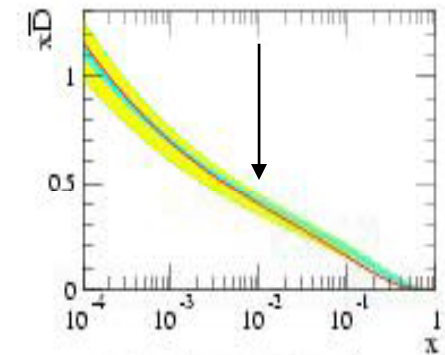
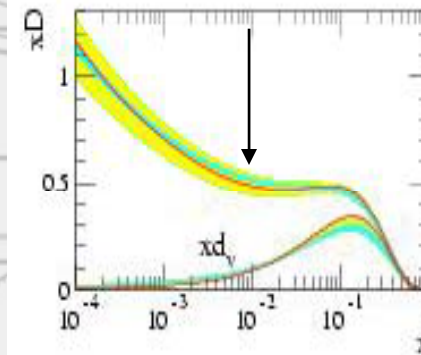
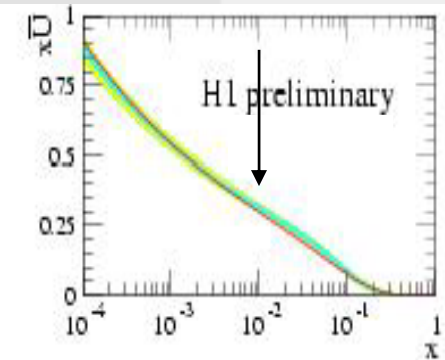
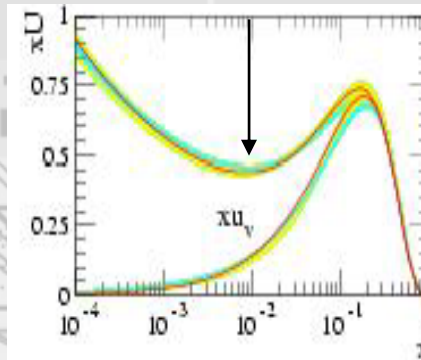

Prel. H1 2002 PDF Fit
Fit to H1 + BCDMS data
— experimental errors
— model uncertainties
Fit to H1 data
— central value
 $Q^2 = + \text{GeV}^2$

Gluon recombination @ HERA

- low- x rise of F_2
- HERA: precision @ $x > 10^{-4}$ @ $Q^2 = 10 \text{ GeV}^2$

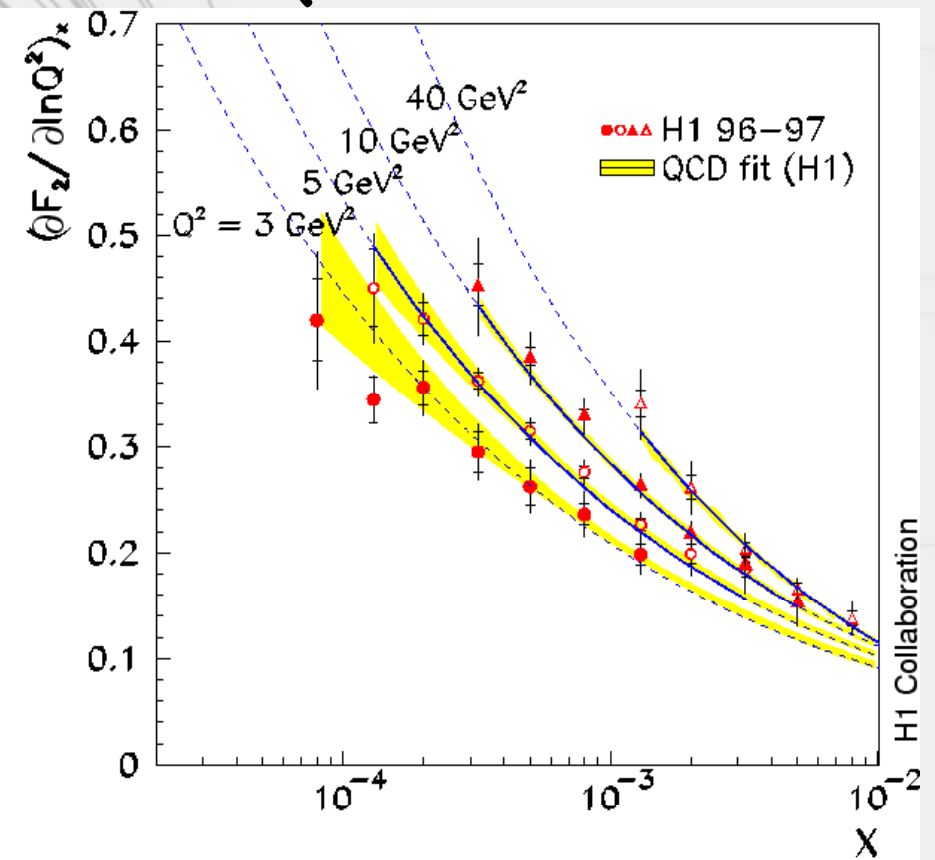
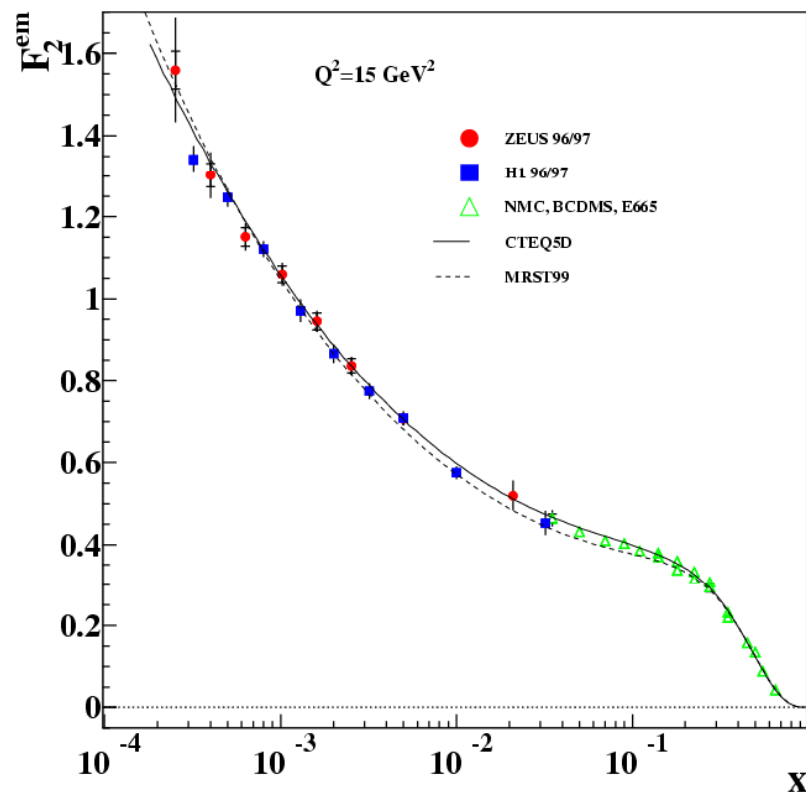

- relentless rise of quark (F_2) and gluon $\frac{\partial F_2}{\partial \ln Q^2}$

Gluon recombination @ LHeC

- low- x rise of F_2
- LHeC: precision @ $x > 10^{-4}$ @ $Q^2 = 250 \text{ GeV}^2$

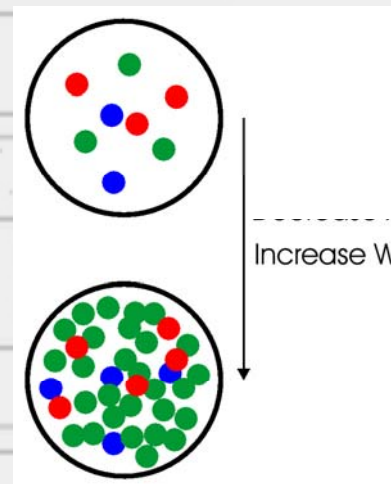
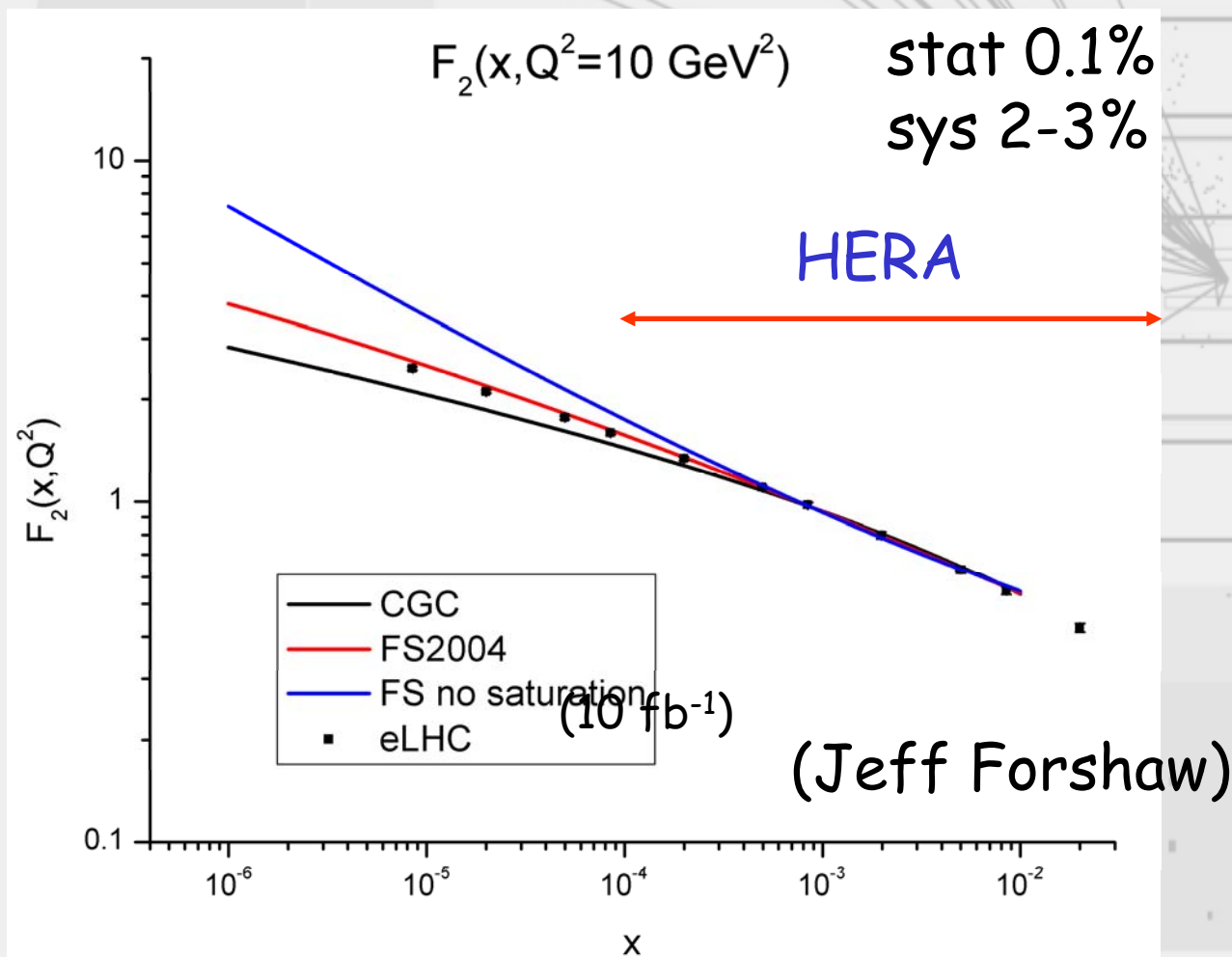

• LHeC
"nails"
saturation

Gluon recombination @ LHeC

- ep saturation $Q^2 \leq 5 \text{ GeV}^2$
- eA saturation $Q^2 \leq 20 \text{ GeV}^2$

$$Q_s^2 \sim \frac{\alpha_s x G_A(x, Q_s^2)}{\pi R_A^2} \sim A^{1/3} \frac{1}{x^{0.3}}$$

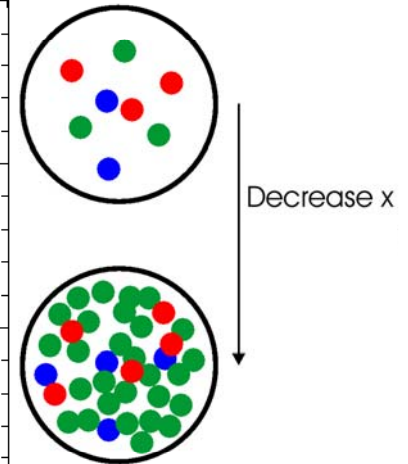
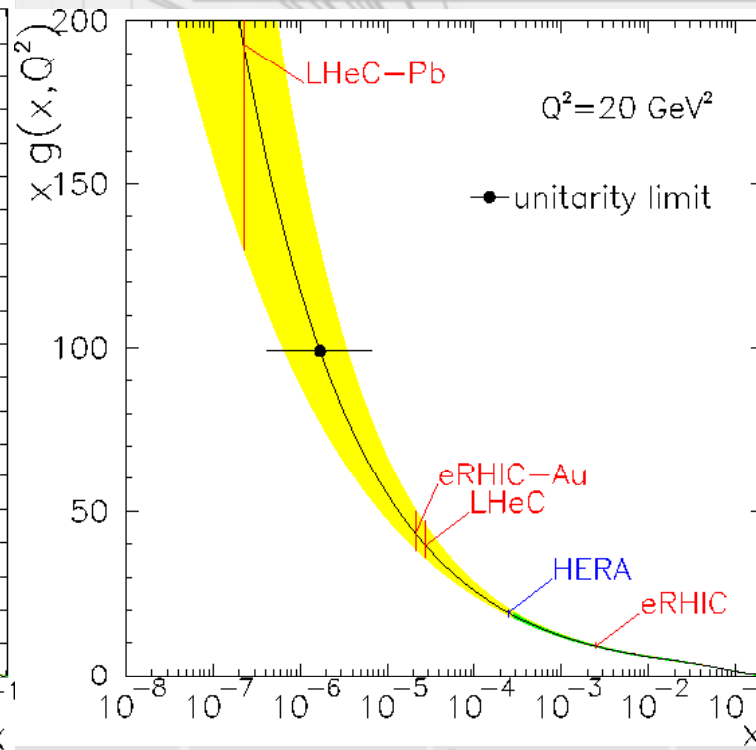
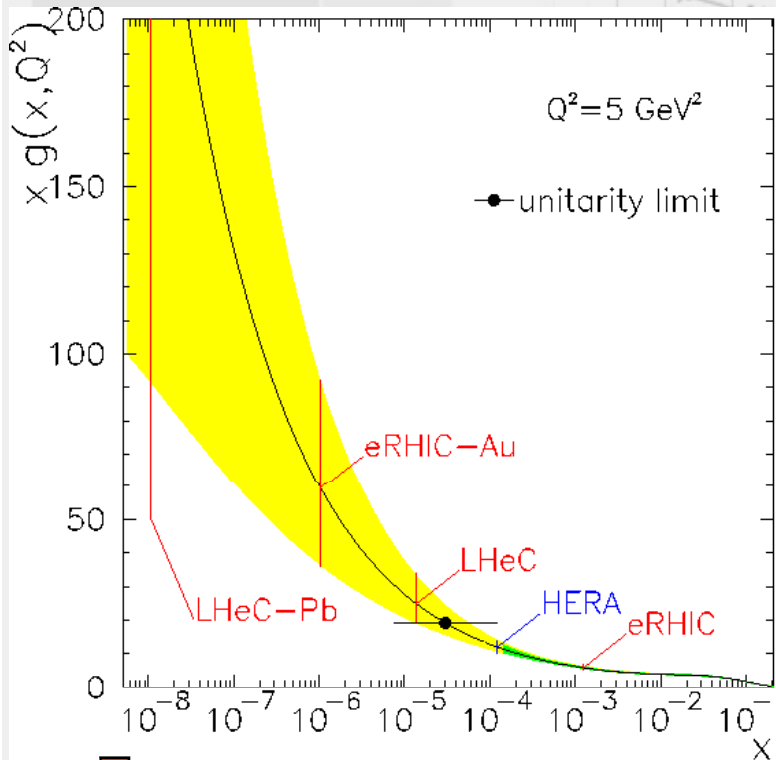

 • LHeC "nails" saturation

Partons in Nuclear Matter

- fundamental to origin of mass in Universe (Wilczek)
 - from nucleon valence to QCD-field dominated ($x \downarrow$)
 - increasing number of valence partons ($A \uparrow$)
- very limited, but tantalising, old data
 - $Q^2 < 1 \text{ GeV}^2$ $x > 0.01$

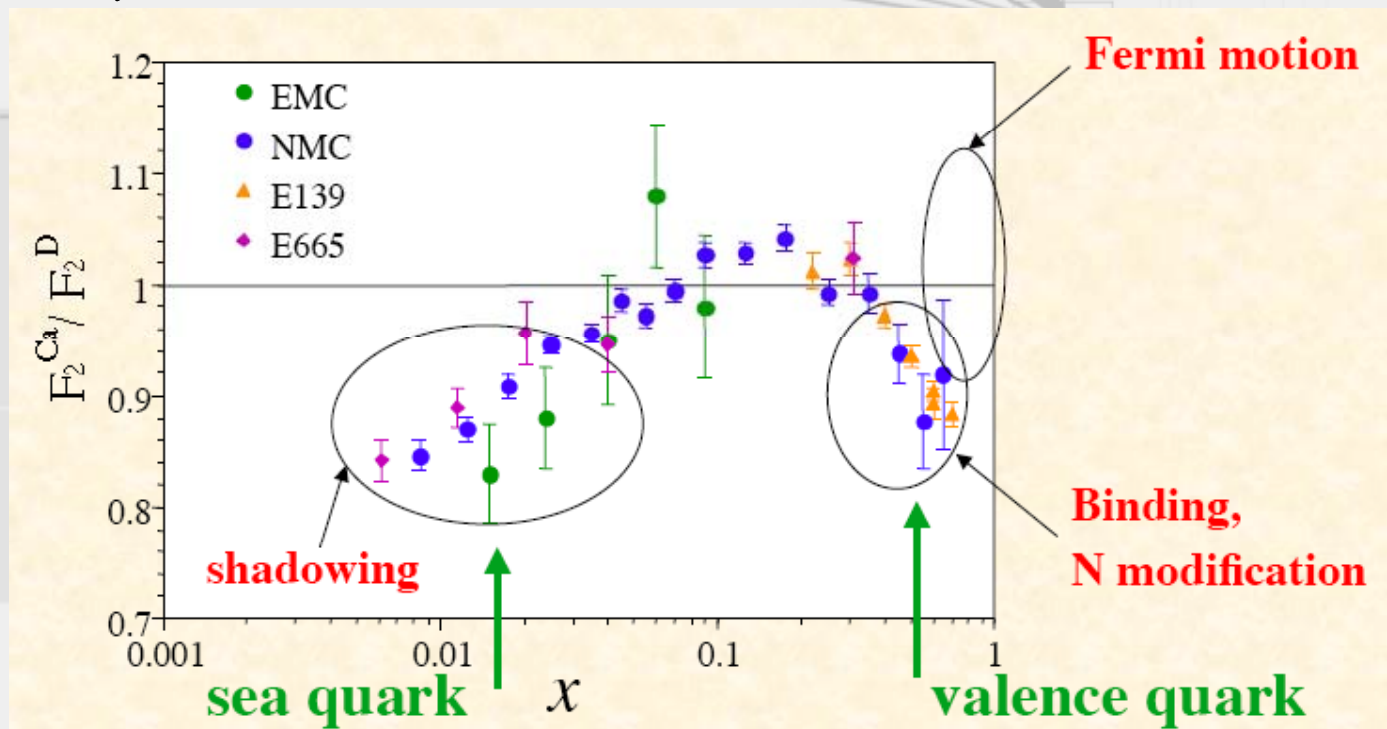

1_c dynamics in *p* and *A*

- low-*x* reach at LHeC
precision @ $x > 10^{-4}$
@ $Q^2 = 250 \text{ GeV}^2$ ($x = \beta x_{IP}$)

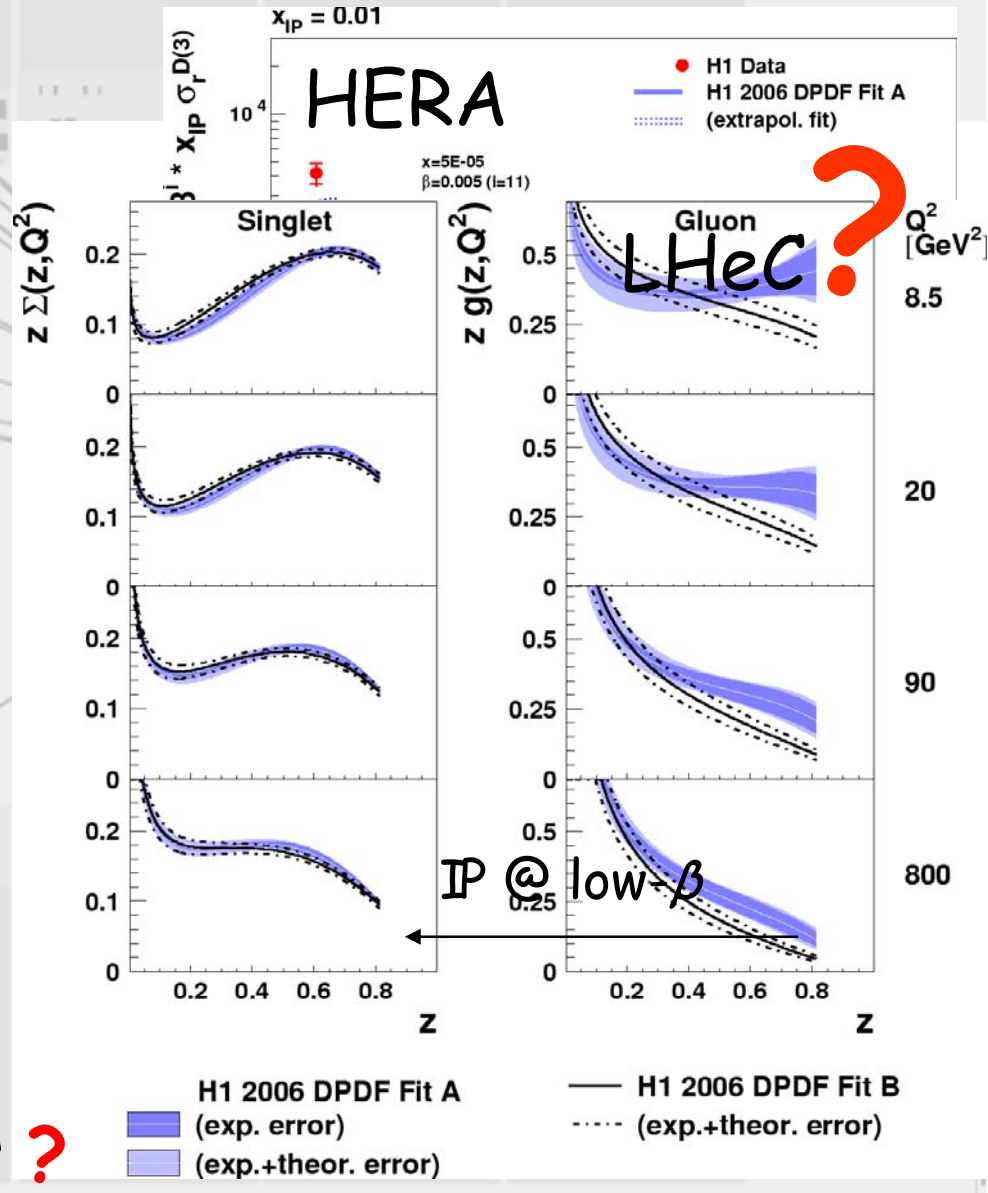
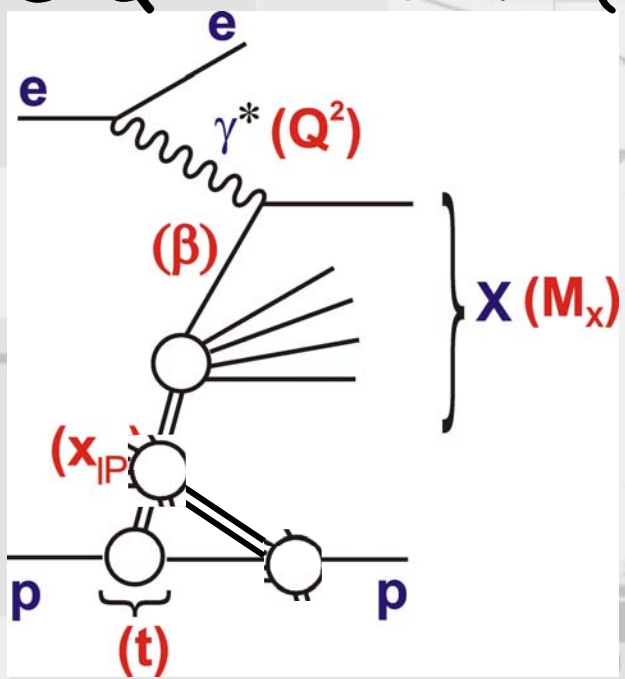

- low *x* physics of IP
IP in IP: triple IR
QCD → reggeon calculus ?

1_c dynamics in p and A

- low- x \mathbb{P} physics at LHeC

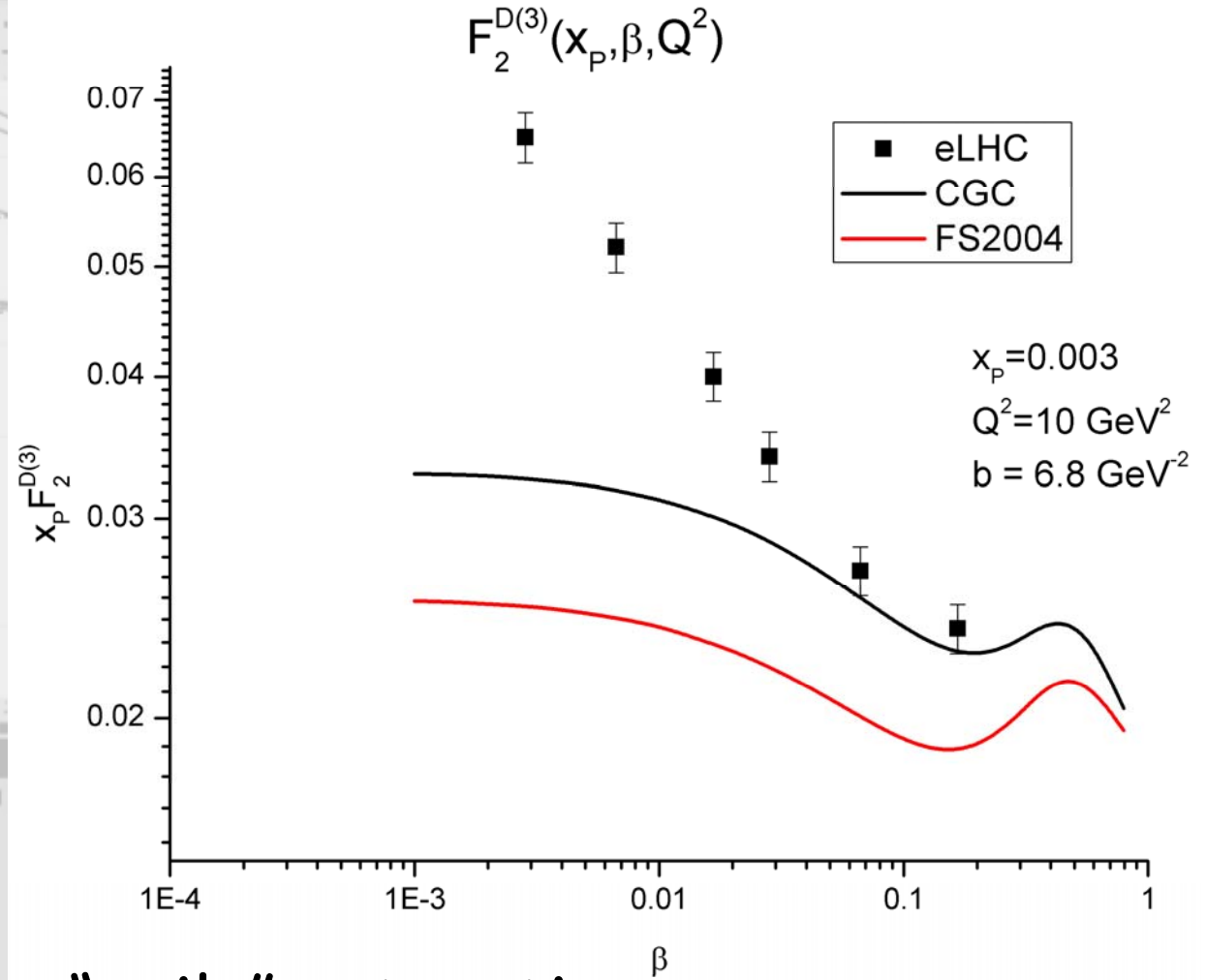
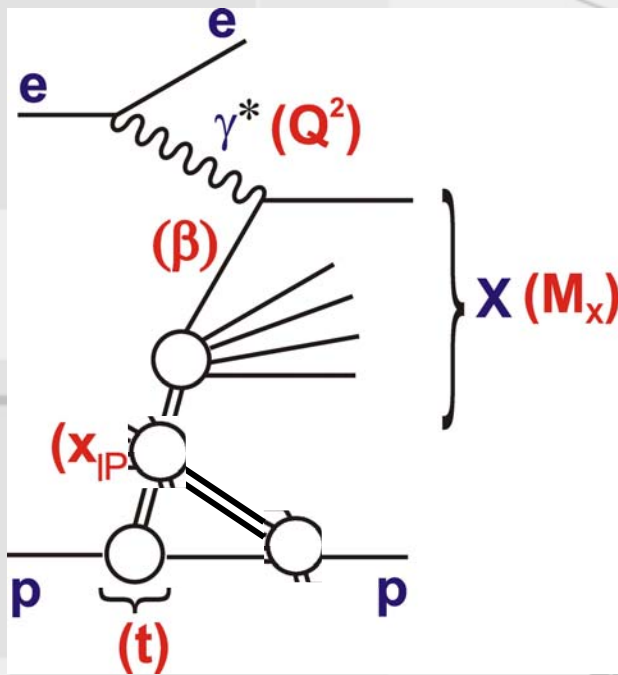

- LHeC diffraction "nails" saturation

1_c dynamics in p and A



- \mathbb{P} physics at LHeC
0⁺ "vacuum" physics

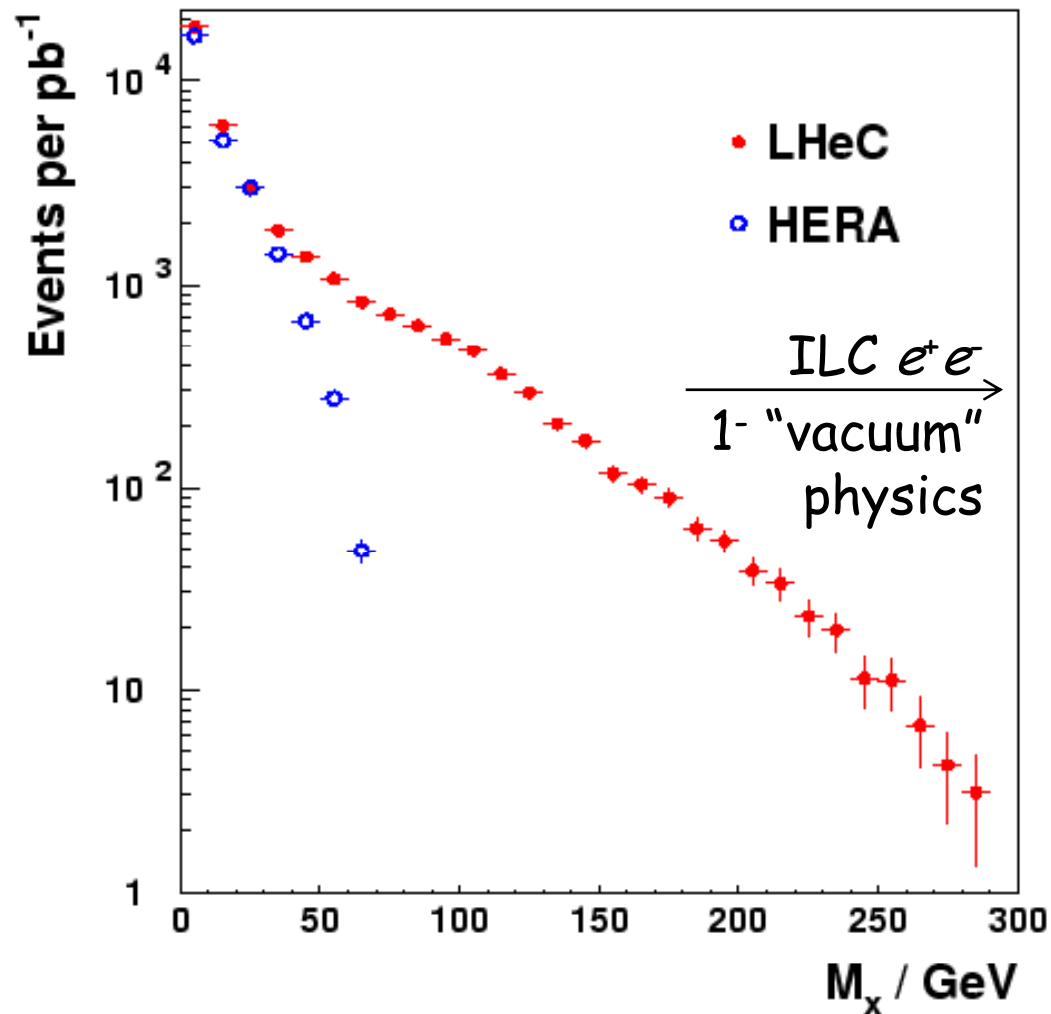
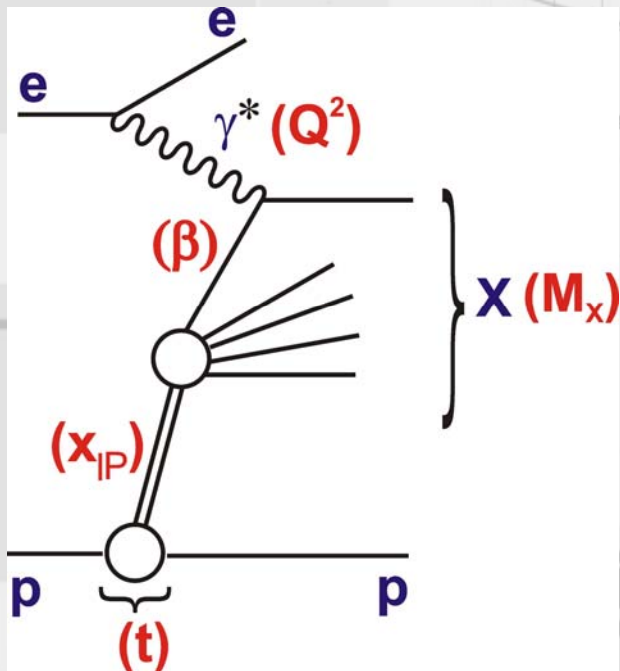

- \mathbb{P} physics @ 100 GeV: leptonomers ?

Polarised Positron
Workshop
Meeting
Cockcroft Institute
March 28th 2008

THE COCKCROFT INSTITUTE
of ACCELERATOR
SCIENCE and TECHNOLOGY



UNIVERSITY OF
LIVERPOOL



3. Machine

Proton beam



- "standard" LHC protons ... with electrons?

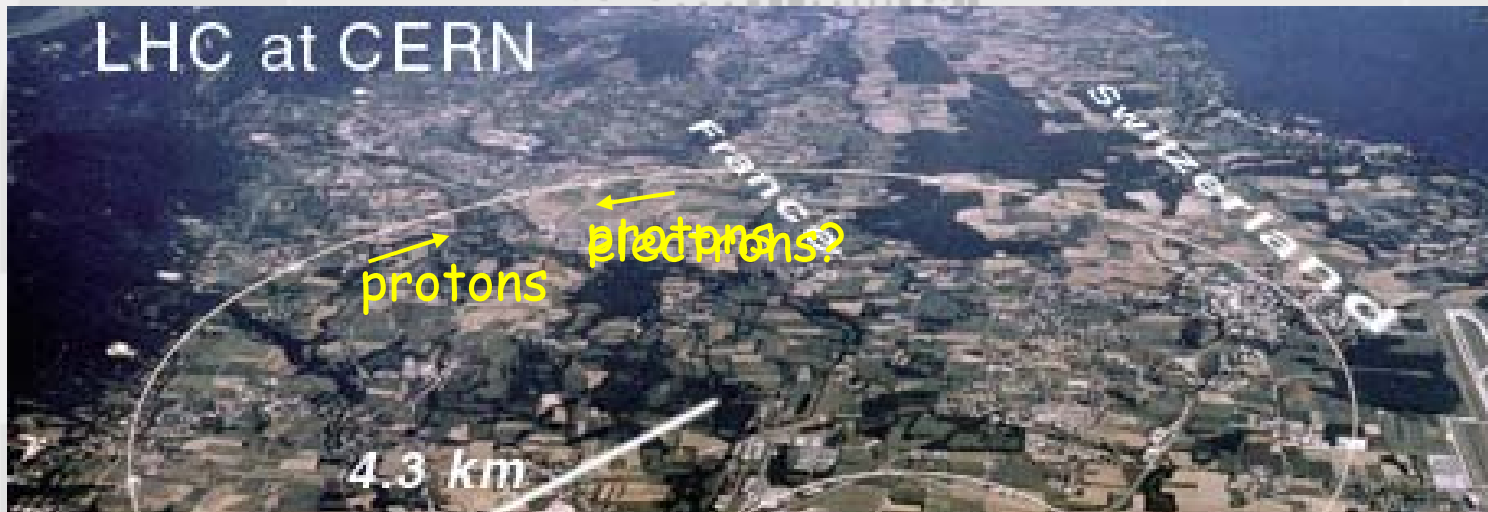

Proton Beam Energy	TeV	7
Circumference	m	26658.883
Number of Protons per bunch	10^{11}	1.67
Normalized transverse emittance	μm	3.75
Bunch length	cm	7.55
Bunch spacing	ns	25

N_p
 ϵ_{pN}

LHC

LHC PROJECT

UNDERGROUND WORKS

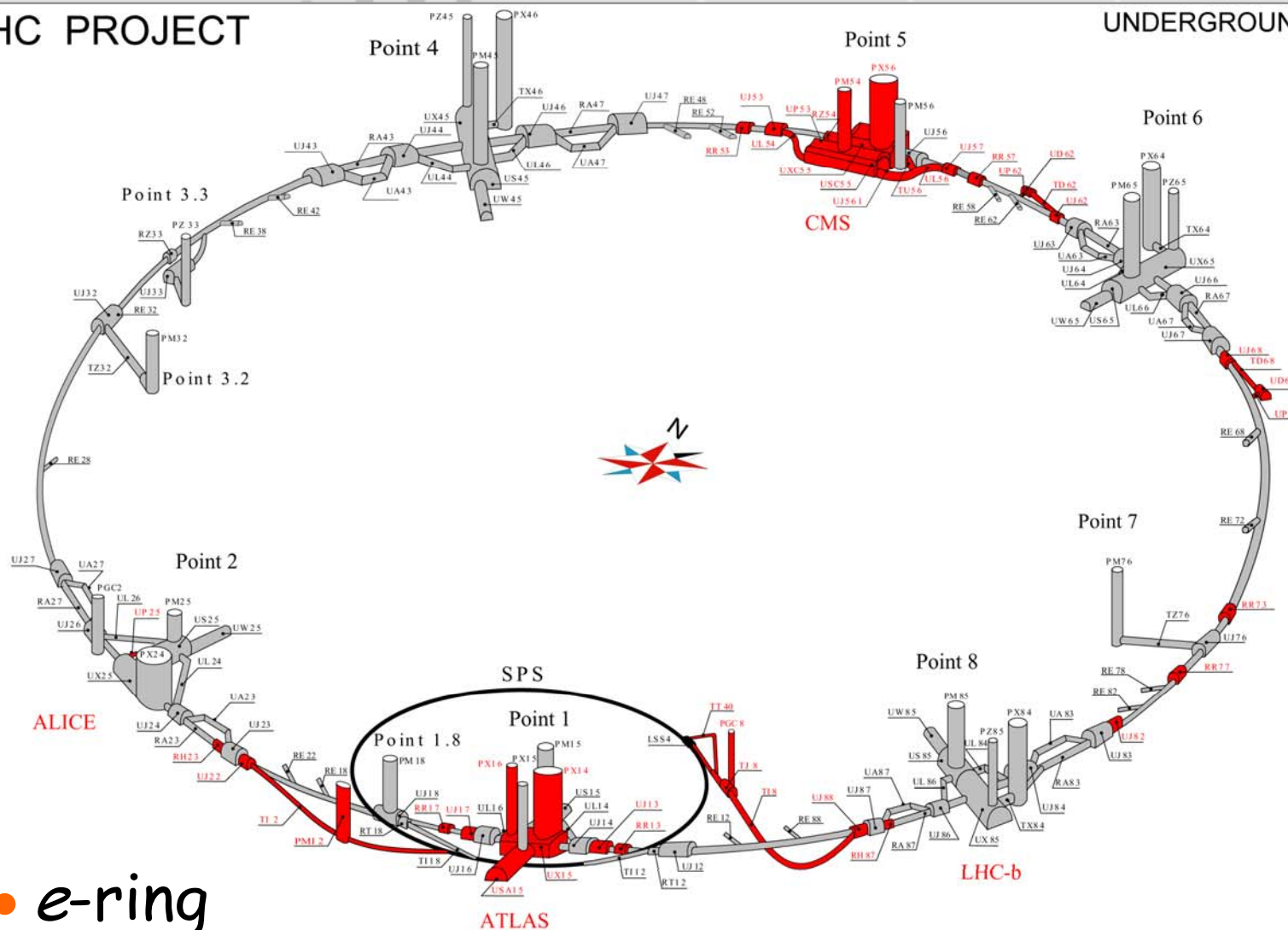

• e-ring

- bypass experiments and RF ?

ep Collisions

- after B physics @ LHC ?

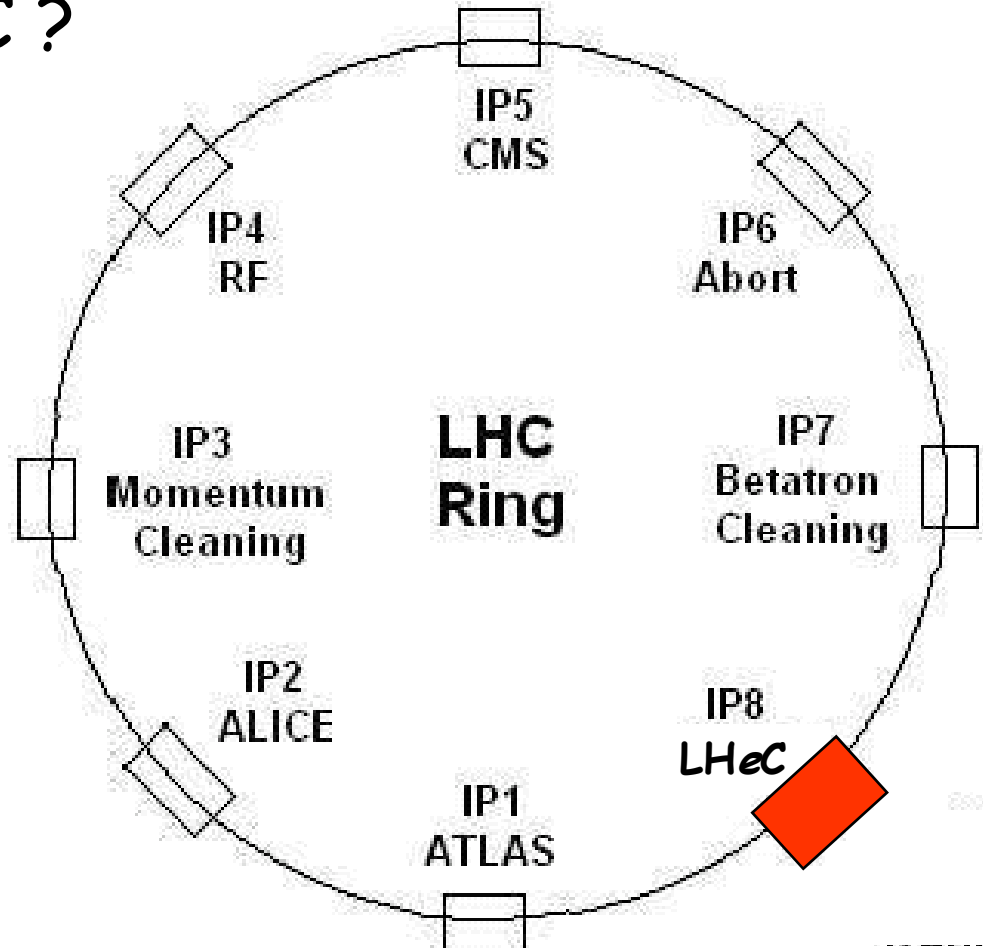
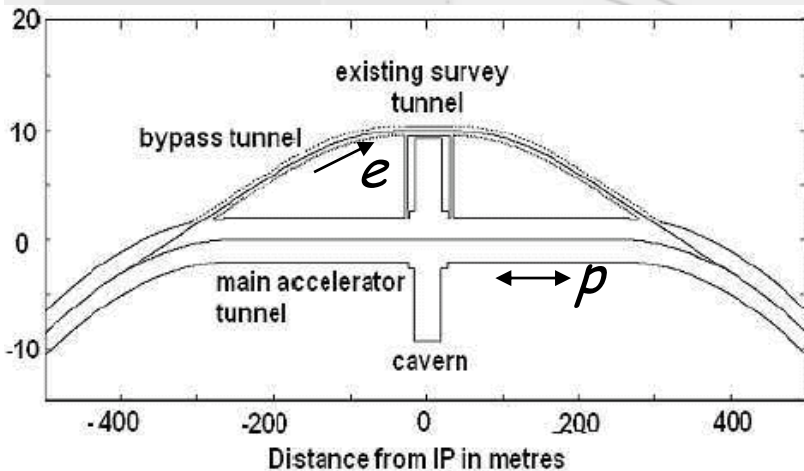

civil engineering
tunnel $>2 \times 250\text{m} \times 2\text{m} \varnothing$ @IP

ep alongside pp data-taking @ LHC

Luminosity: e-Ring



$$L = \frac{N_p \gamma}{4\pi e \epsilon_{pn}} \cdot \frac{I_e}{\sqrt{\beta_{px} \beta_{py}}} = 8.310^{32} \cdot \frac{I_e}{50\text{mA}} \frac{m}{\sqrt{\beta_{px} \beta_{pn}}} \text{cm}^{-2} \text{s}^{-1}$$

$$I_e = 0.35\text{mA} \cdot \frac{P}{\text{MW}} \cdot \left(\frac{100\text{GeV}}{E_e} \right)^4$$

$$\epsilon_{pn} = 3.8\mu\text{m}$$

$$N_p = 1.7 \cdot 10^{11} \quad \beta_{px} = 1.8\text{m}$$

$$\beta_{py} = 0.5\text{m}$$

$$\sigma_{p(x,y)} = \sigma_{e(x,y)}$$

- e-ring
- $10^{33} \text{ cm}^{-2} \text{ s}^{-1}$
- $E_e < 80 \text{ GeV}$
- power $P < 60 \text{ MW}$
- ERL $\rightarrow 10^{34} \text{ cm}^{-2} \text{ s}^{-1}$?
- (eRHIC)

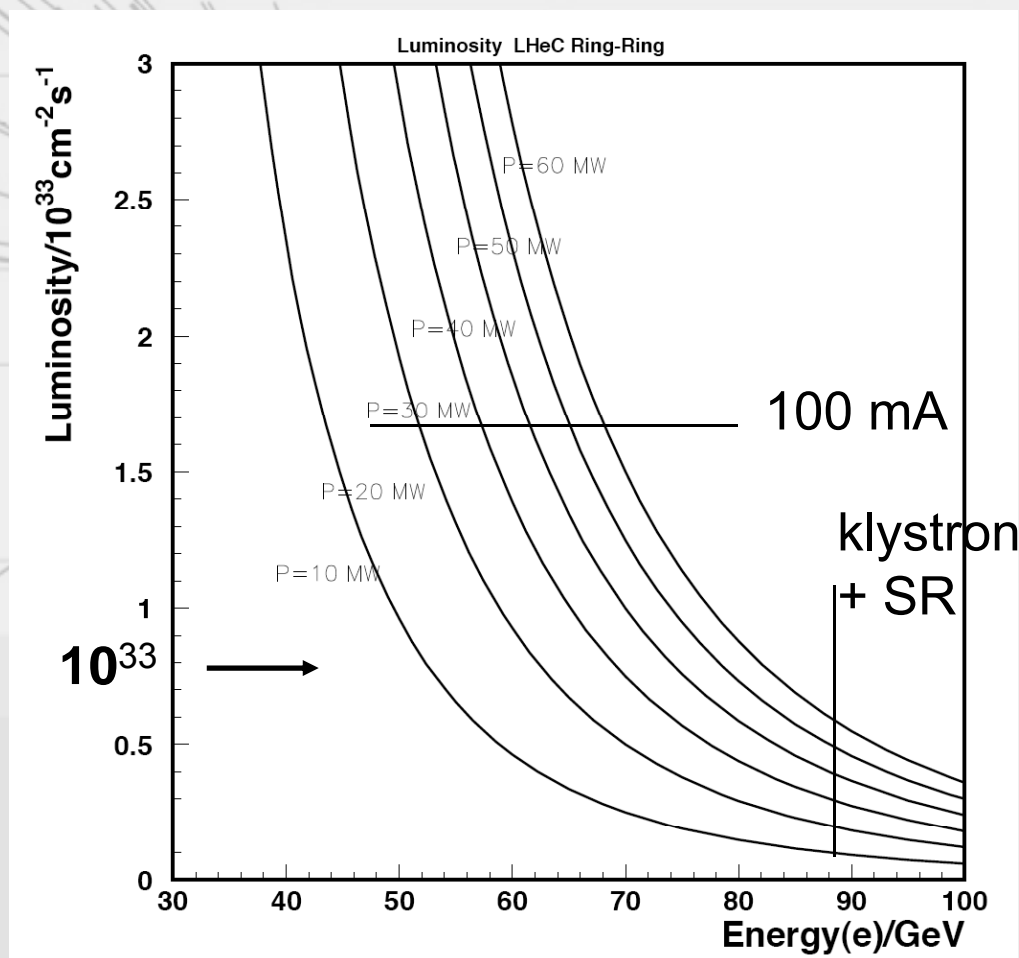

e-Ring IR

Table 3: Main Parameters of the Lepton-Proton Collider

Property	Unit	Leptons	Protons
Beam Energies	GeV	70	7000
Total Beam Current	mA	74	544
Number of Particles / bunch	10^{10}	1.04	17.0
Horizontal Beam Emittance	nm	7.6	0.501
Vertical Beam Emittance	nm	3.8	0.501
Horizontal β -functions at IP	cm	12.7	180
Vertical β -function at the IP	cm	7.1	50
Energy loss per turn	GeV	0.707	$6 \cdot 10^{-6}$
Radiated Energy	MW	50	0.003
Bunch frequency / bunch spacing	MHz / ns	40 / 25	
Center of Mass Energy	GeV	1400	
Luminosity	$10^{23} \text{cm}^{-2} \text{s}^{-1}$	1.1	

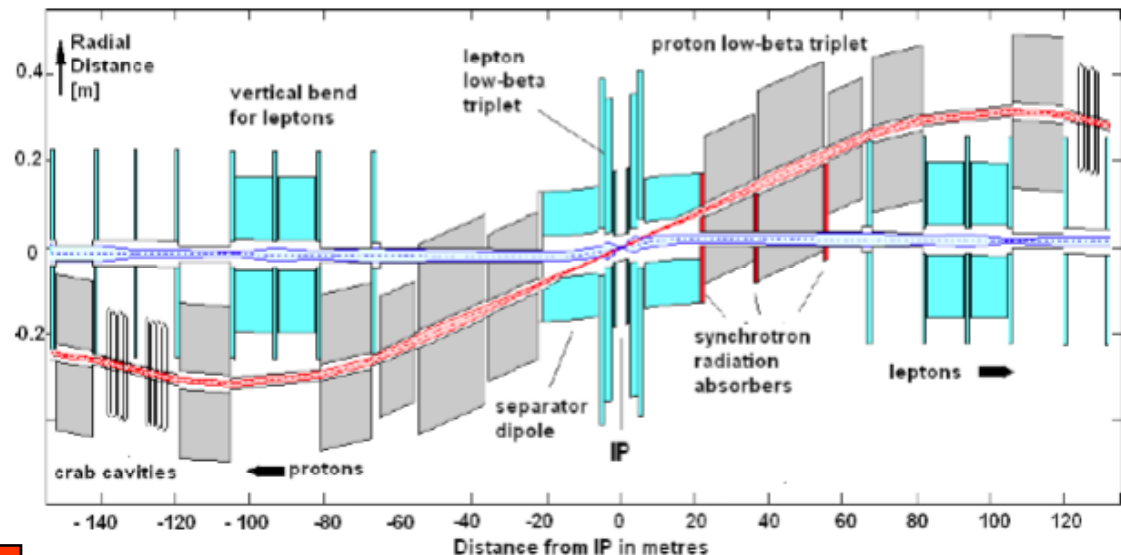
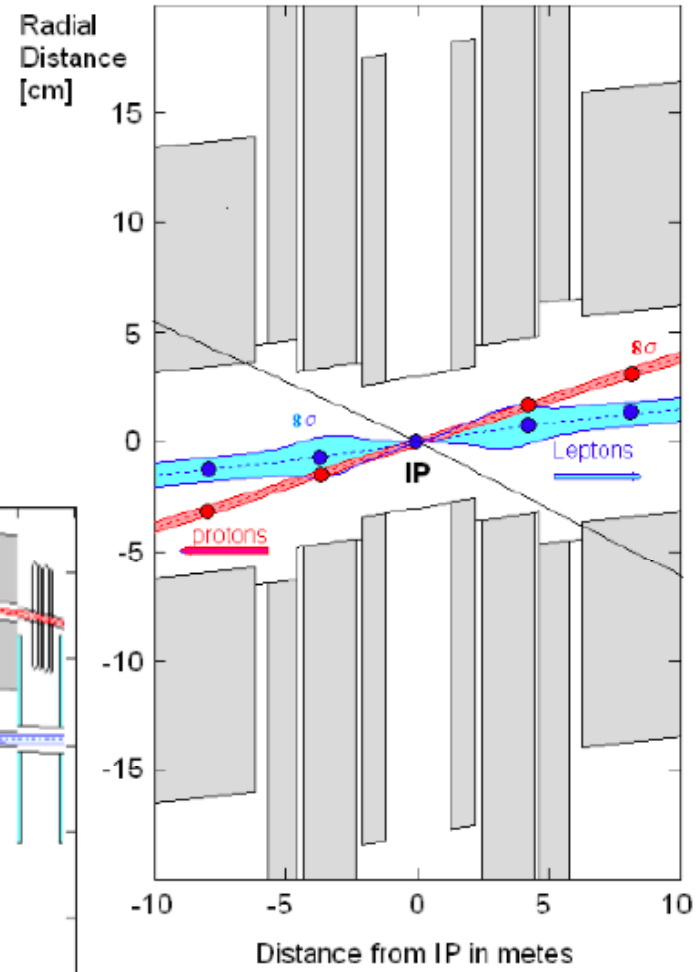

simultaneous pp (AA) and ep (eA)

e-ring

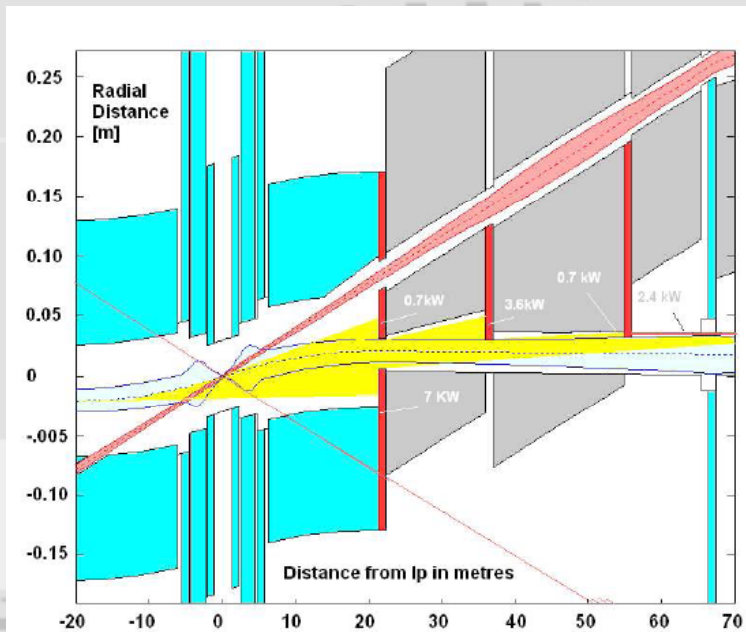

Synchrotron radiation fan
and HERA type absorber $9.1 kW$
 $E_{crit} = 76 keV$

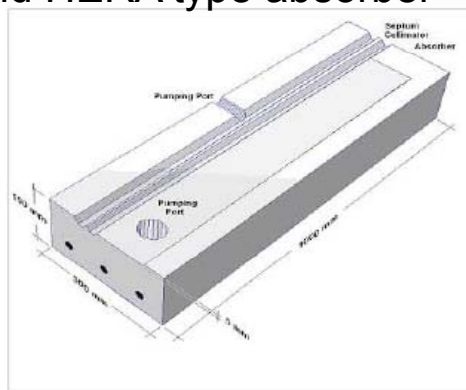

100W/mm²

cf also W. Bartel
Aachen 1990

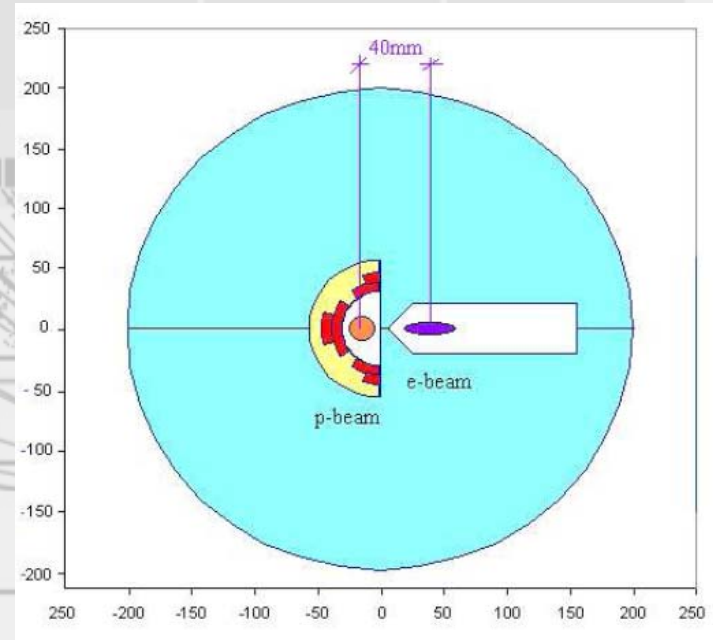

First p beam lens: septum quadrupole.
Cross section and Field calculation

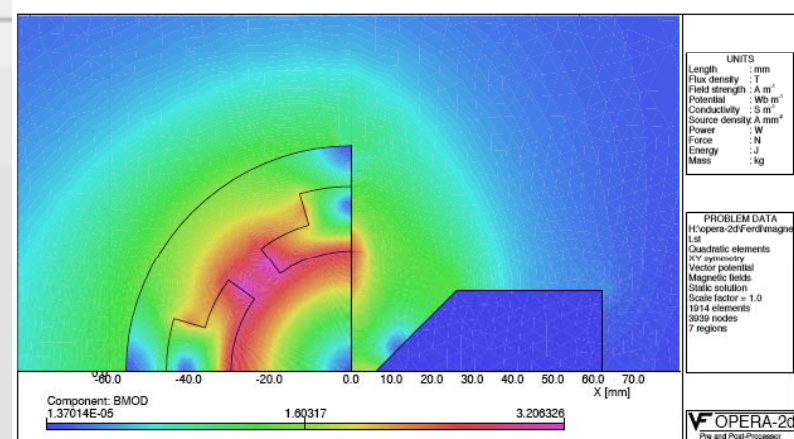

e-ring Issues

- power: 25 ns \rightarrow nx40 MHz RF I < 100 mA
60 klystrons @ 1.3MW, coupler 0.5MW, 66% effy
extra RF in bypasses
- injection: 1.4×10^{10} e in 2800 bunches
(LEP2 4×10^{11} in 4)
energy < 20 GeV (ELFE, KEK ...)
- SR \rightarrow LHC magnets:
water cooling+Pb
- bypasses: ATLAS CMS + RF
 \rightarrow ~500m from arcs
~ -20cm radius of e-ring
- space: above LHC

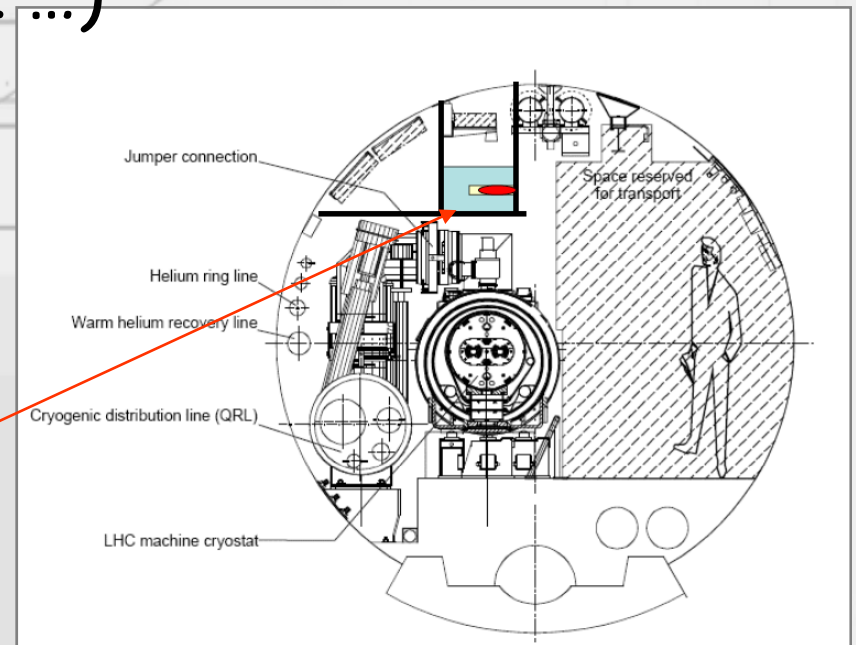

Equipment above installed LHC beamlines....

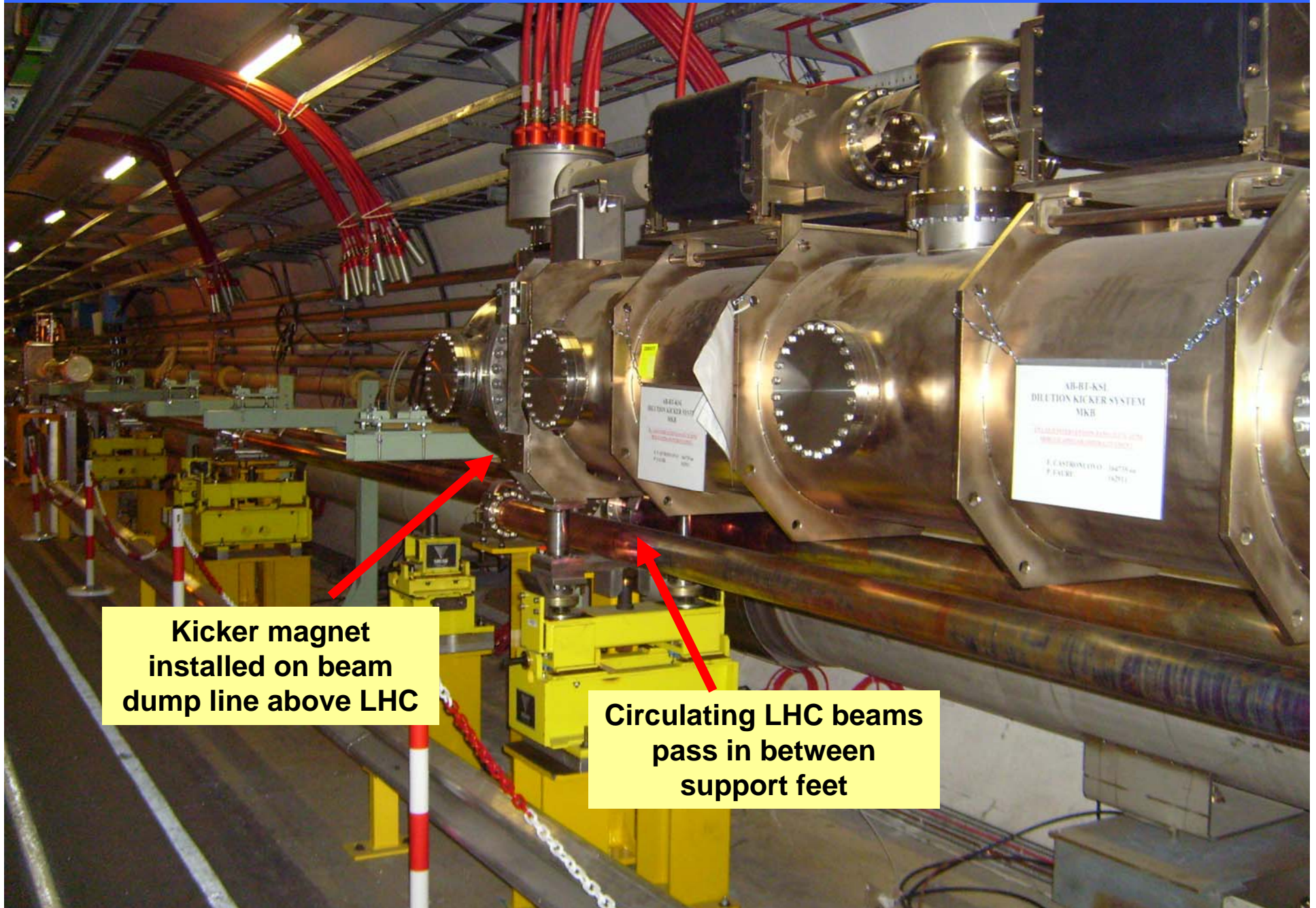

**Kicker magnet
installed on beam
dump line above LHC**

**Circulating LHC beams
pass in between
support feet**

$e^{\pm}p$ Luminosity

- astounding!

• $\times 10^2 L_{NMC} HP$
@ 0.01 fm

• $L_{eRHIC} e_{pol} p_{pol} eA$
@ 0.007 fm

• $\times 10^2 L_{HERA} e_{pol} p$
@ 0.001 fm

• $L_{LHeC} e^{\pm} p eA$
@ 0.00014 fm

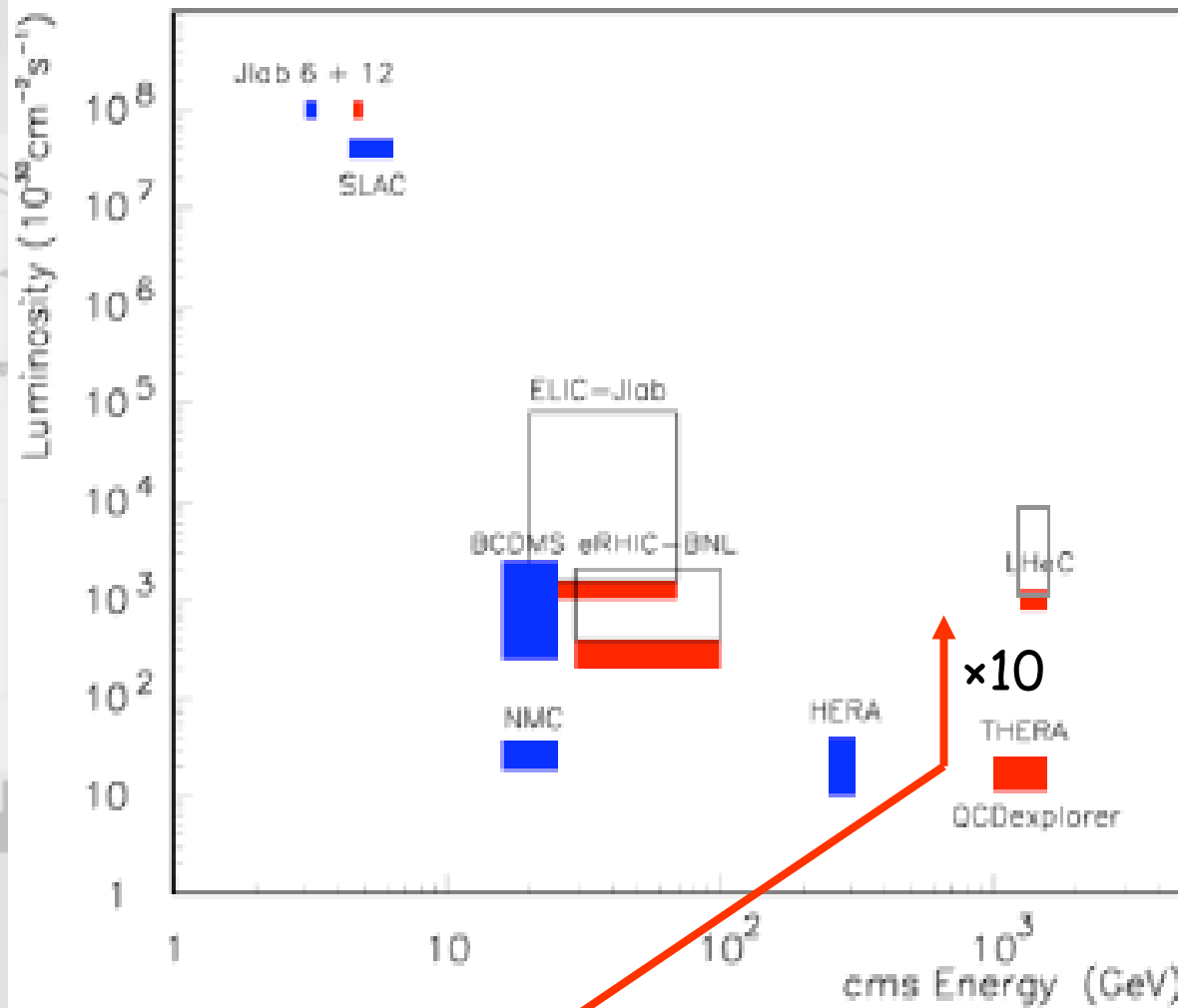

indisputably a next step ?

e-linac + LHC

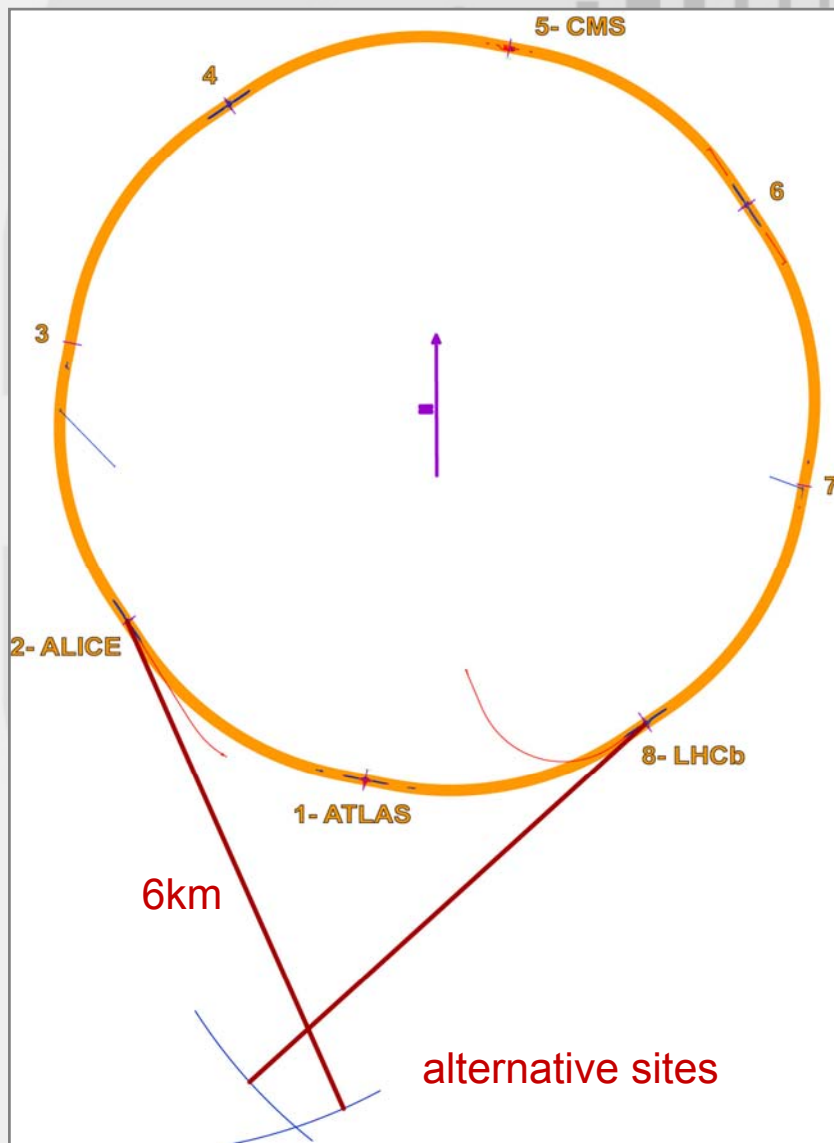

	units	ring-linac pulsed		ring-linac, cw, ~99% energy recovery	
		e-	p	e-	p
energy	GeV	70	7000	70	7000
punch population	10^{10}	2	17	2	17
σ_z	cm	0.03	7.55	0.03	7.55
beam current (pulsed)	mA	101	858	101	858
emittance $\epsilon_{x,y}$	nm	0.5, 0.5			
$\beta^*_{x,y}$	cm	15, 15			
spacing	ns	25			
e-linac/ring length	km	3.5	7 (2 linacs)		
e- pulse length		1 ms	cw		
repetition rate		5 Hz	continuous		
e- beam power	MW	35	7000		
peak luminosity	10^{32} $\text{cm}^{-2} \text{s}^{-1}$	0.6	2x110		

D Brandt (CERN), F.Zimmermann (CERN), et al. "QCD Explorer"

S. Chattopadhyay (Cockcroft), F.Zimmermann (CERN), et al.

Luminosity: Linac-Ring



$$L = \frac{N_p \gamma}{4\pi\epsilon_{pn} \beta^*} \cdot \frac{P}{E_e} = 1 \cdot 10^{32} \cdot \frac{P / MW}{E_e / GeV} \text{ cm}^{-2} \text{ s}^{-1} \quad I_e = 100 \text{ mA} \cdot \frac{P}{MW} \cdot \frac{GeV}{E_e}$$

$$\epsilon_{pn} = 3.8 \mu\text{m}$$

$$\beta^* = 0.15 \text{ m}$$

$$N_p = 1.7 \cdot 10^{11}$$

- e-linac
 - $10^{32} \text{ cm}^{-2} \text{ s}^{-1} \sim \text{HERA}$
 - $E_e < 140 \text{ GeV}$ (\$s)
 - power $P < 60 \text{ MW}$
 - 6 km+gaps @23 MV/m

↪ lumi + energy horizon

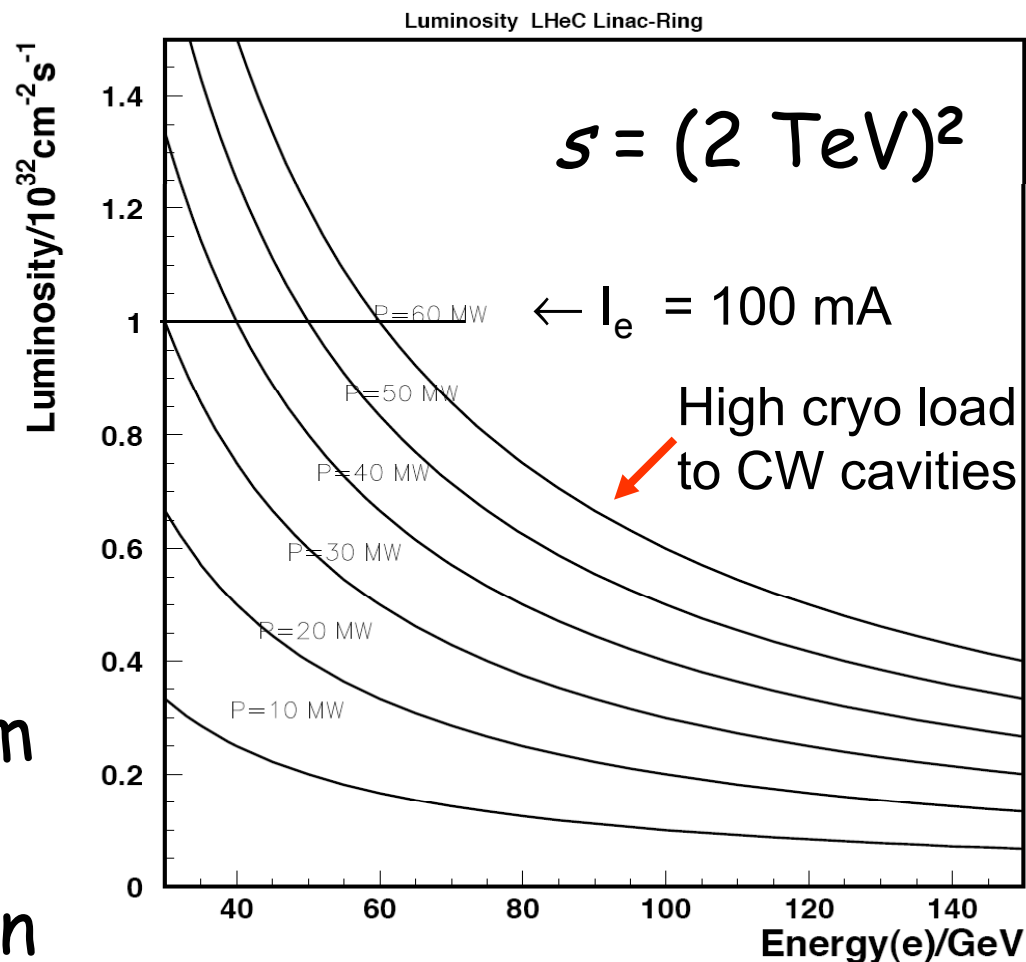

Linac-Ring & Ring-Ring



	L-R	R-R
Energy / GeV	40-140 ...	40-80
Luminosity / $10^{32} \text{ cm}^{-2} \text{ s}^{-1}$	0.5	10
Mean Luminosity, relative	2	1 [dump at L_{peak} / e]
Lepton Polarisation	60-80%	30% [?]
Tunnel / km	6	2.5=0.5 * 5 bypasses
Biggest challenge	CW cavities	Civil Engineering Ring+Rf installation
Biggest limitation	luminosity (ERL,CW)	maximum energy
IR	not considered yet one design? (eRHIC)	allows ep+pp 2 configurations [lox, hiq]

Machine

- ring-ring
 - stupendous lumi (\sim LHC)
 - energy horizon ~ 1.2 TeV
 - civil engineering impact on LHC
 - e -polarisation (Sokolov-Ternov)
 - ep (eA) with pp (AA)
 - linac-ring
 - moderate (\sim HERA) lumi (\sim LHC)
 - energy horizon \sim multi-TeV
 - less civil engineering impact on LHC
 - e -polarisation (source: e^+ ?)
 - ep (eA) with pp (AA)
-  • LHC upgrade: cost ?

eRHIC and ERL



Coherent Electron
Cooling

IP#12 - main

Main beneficiary from the cooling of hadron beams

- Reduction of the hadron bunch length shortens vertex
- It also reduces e-beam disruption
- Emittance reduction provides for proportional reduction of the electron beam current (less X-ray back-ground in the detector, higher energy eRHIC above 20 GeV, ...)
- The reduction of emittance and bunch length allow reduction of β^* to few cm from present 25 cm and corresponding increase would
- push e^-p luminosity to $10^{34} \text{ cm}^{-2}\text{s}^{-1}$ ($\beta^* = 10 \text{ cm}$) and above

Ø1.22 km

RHIC

Four multiple passes:
vertical separation of the arcs

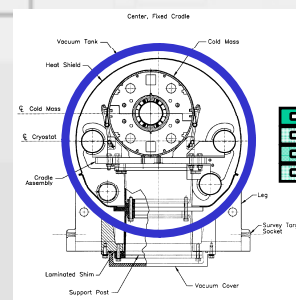
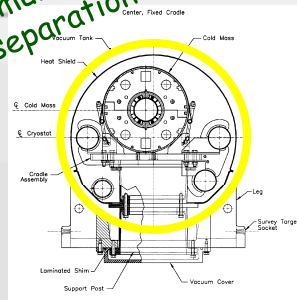
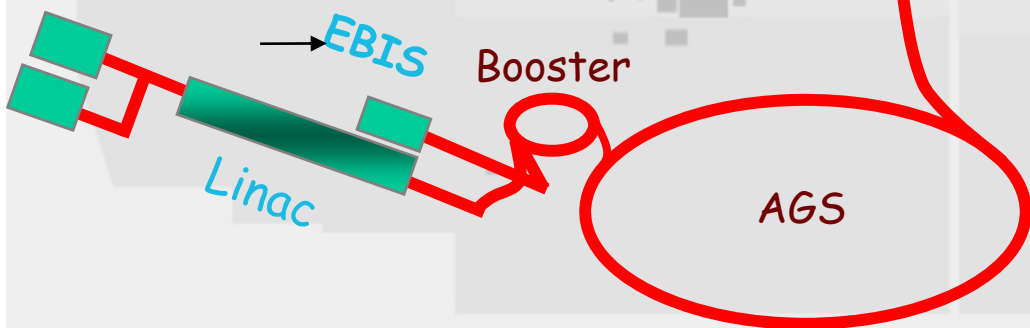

eRHIC loop magnets



- Small gap provides for low current
- Very low power consumption magnets

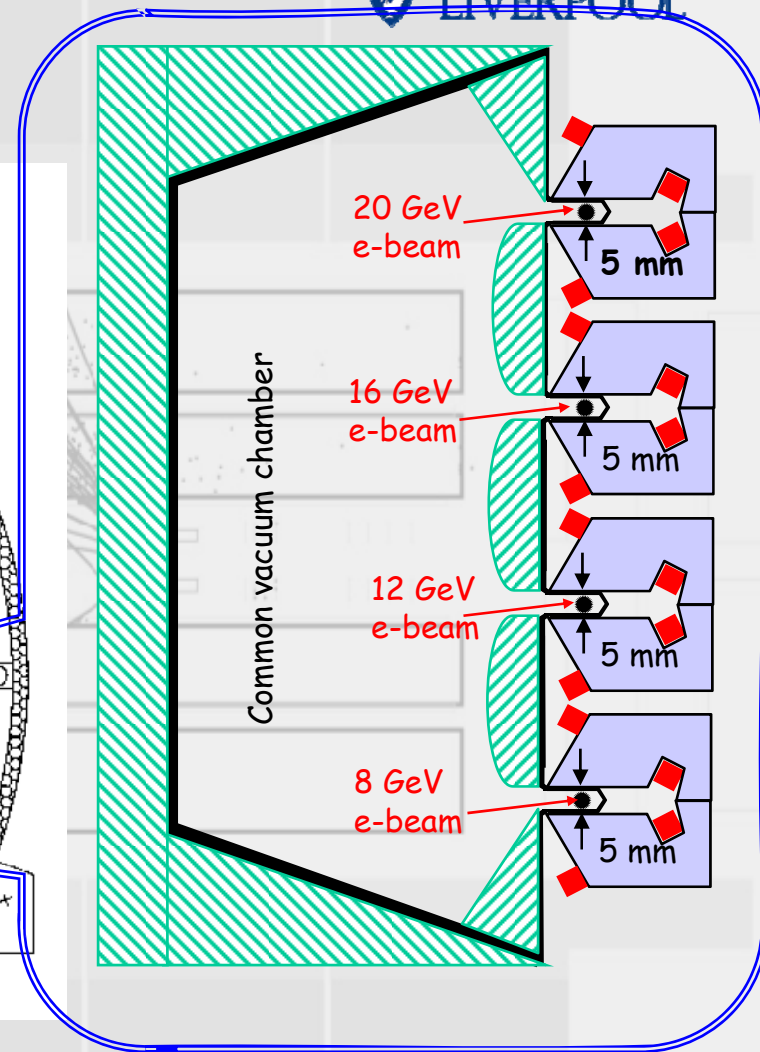
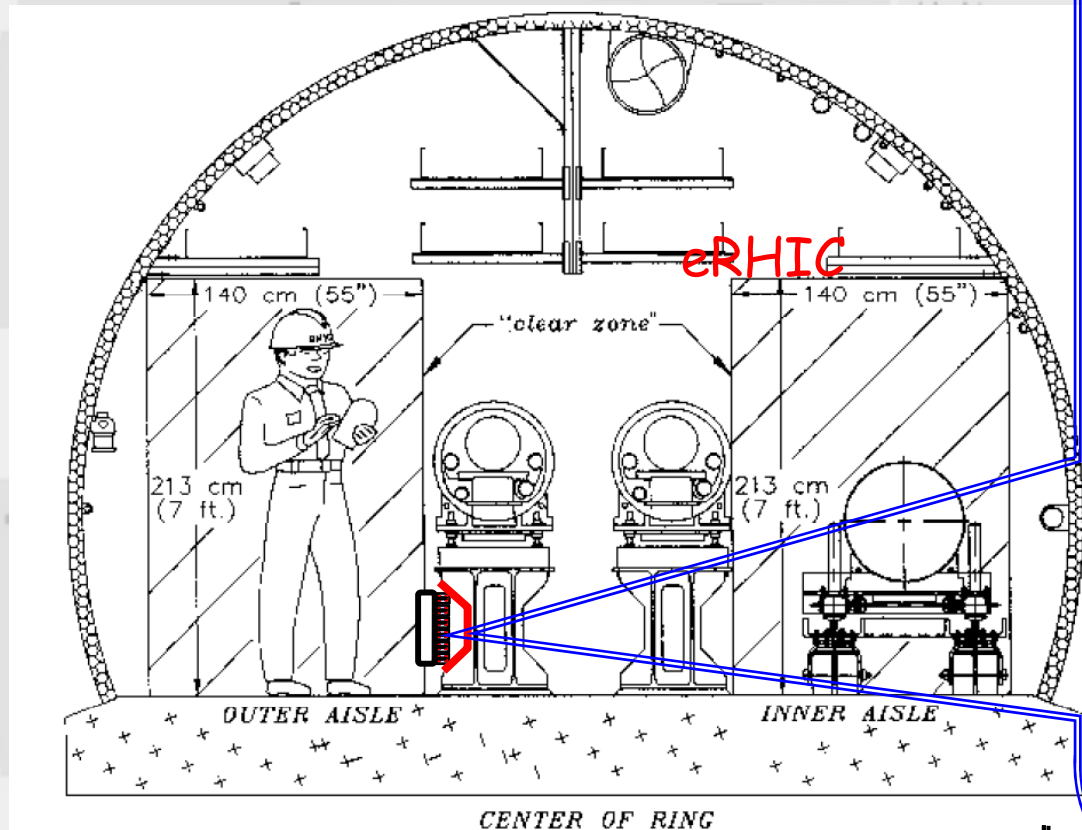

C- Dipole

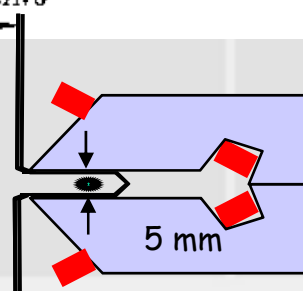

C-Quad

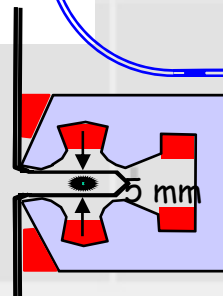

ERL spin transparency



Bargman, Mitchel, Telegdi equation

$$\frac{d\hat{s}}{dt} = \frac{e}{mc} \hat{s} \times \left[\left(\frac{g}{2} - 1 + \frac{1}{\gamma} \right) \vec{B} - \frac{\gamma}{\gamma+1} \left(\frac{g}{2} - 1 \right) \beta (\beta \cdot \vec{B}) - \left(\frac{g}{2} - \frac{\gamma}{\gamma+1} \right) [\vec{\beta} \times \vec{E}] \right]$$

$$a = g/2 - 1 = 1.1596521884 \cdot 10^{-3}$$

$$\hat{\mu} = \frac{g}{2} \frac{e}{m_o} \hat{s} = (1+a) \frac{e}{m_o} \hat{s}; \quad v_{spin} = a \cdot \gamma = \frac{E_e}{0.44065 [GeV]}$$

$$\Delta\phi = a \cdot \gamma\theta$$

Total angle $\phi = \pi a \cdot (\gamma_i(2n-1) + n(\Delta\gamma_1 \cdot n + \Delta\gamma_2(n-1)))$

Has solution
for all
energies!

$$\begin{cases} \gamma_i + 2 \cdot (\Delta\gamma_1 + \Delta\gamma_2) = \gamma_f \\ a \cdot (\gamma_i(2n-1) + n(\Delta\gamma_1 \cdot n + \Delta\gamma_2(n-1))) = N \end{cases}$$

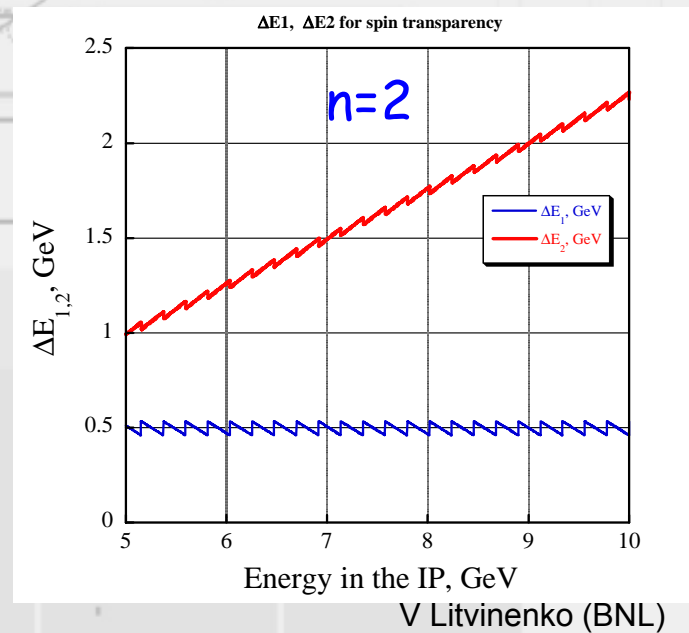
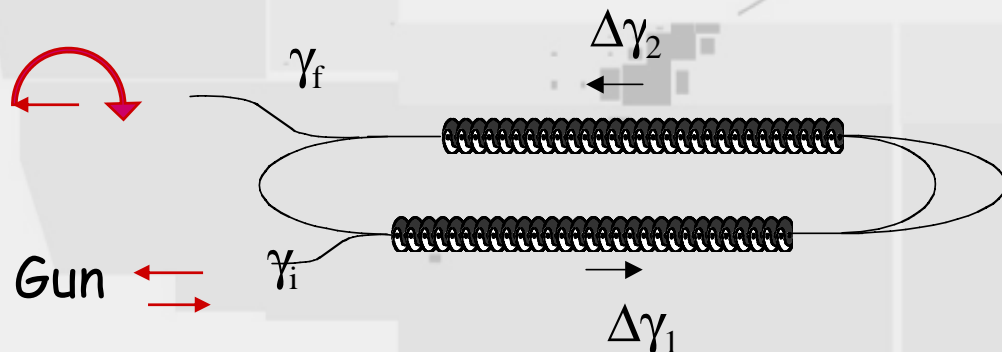
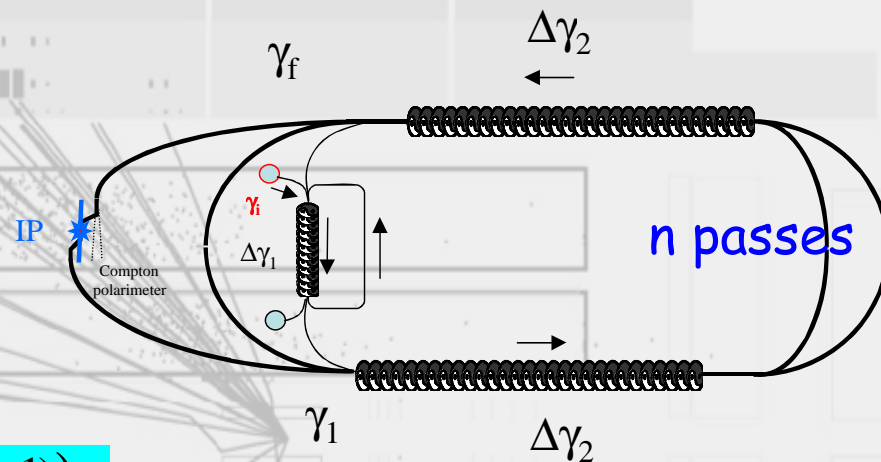

Ring-Ring LHeC is limited by power of synchrotron radiation from the e-beam!



Luminosity: Ring-Ring

$$L = \frac{N_p \gamma}{4\pi \epsilon \epsilon_{pn}} \cdot \frac{I_e}{\sqrt{\beta_{px} \beta_{py}}} = 8.310^{32} \cdot \frac{I_e}{50 \text{ mA}} \frac{m}{\sqrt{\beta_{px} \beta_{pn}}} \text{ cm}^{-2} \text{ s}^{-1}$$

$$\begin{aligned} \epsilon_{pn} &= 3.8 \mu\text{m} \\ N_p &= 1.7 \cdot 10^{11} \\ \sigma_{p(x,y)} &= \sigma_{e(x,y)} \\ \beta_{px} &= 1.8 \text{ m} \\ \beta_{py} &= 0.5 \text{ m} \end{aligned}$$

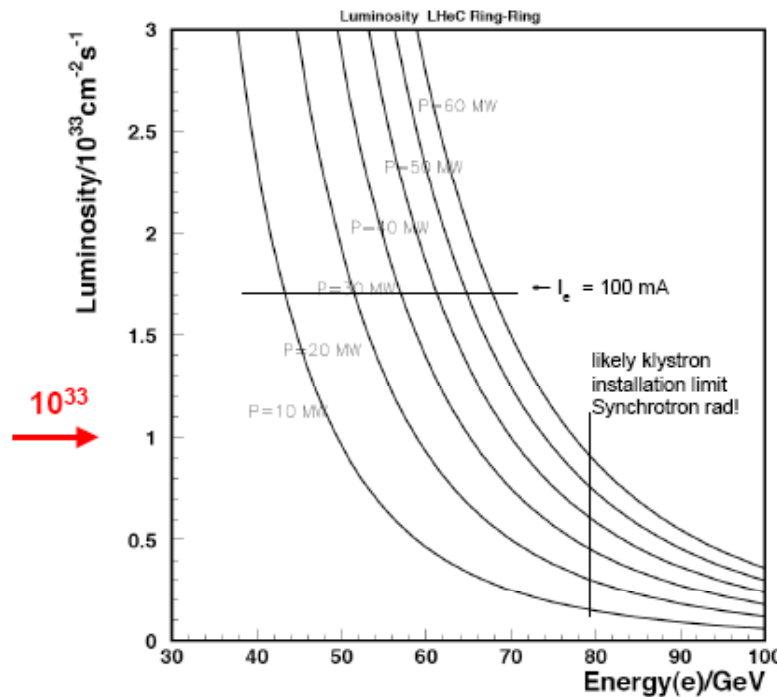

$$I_e = 0.35 \text{ mA} \cdot \frac{P}{\text{MW}} \cdot \left(\frac{100 \text{ GeV}}{E_e} \right)^4$$

10³³ can be reached in RR
E_e = 40-80 GeV & P = 5-60 MW.

HERA was 1-4 10³¹ cm⁻² s⁻¹
huge gain with SLHC p beam

F.Willeke in hep-ex/0603016:
Design of interaction region
for 10³³ : 50 MW, 70 GeV

May reach 10³⁴ with ERL in
bypasses, or/and reduce power.
R&D performed at BNL/eRHIC

M.Klein, ecfa07 talk

cf also A.Verdier 1990, E.Keil 1986



For linac-ring LHeC a pulsed linac with 0.5% duty factor (1 msec, 5 Hz) without energy recovery considered

Luminosity: Linac-Ring

$$L = \frac{N_p \gamma}{4\pi e \epsilon_{pn} \beta^*} \cdot \frac{P}{E_e} = 1 \cdot 10^{32} \cdot \frac{P / MW}{E_e / GeV} cm^{-2} s^{-1}$$

$$\begin{aligned} \epsilon_{pn} &= 3.8 \mu m \\ N_p &= 1.7 \cdot 10^{11} \\ \beta^* &= 0.15 m \end{aligned}$$

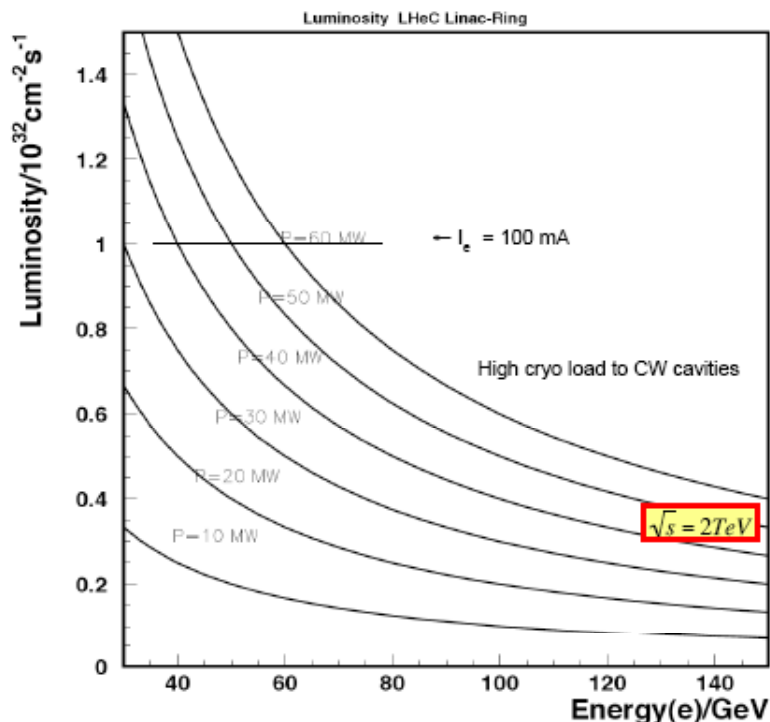

$$I_e = 100 mA \cdot \frac{P}{MW} \cdot \frac{GeV}{E_e}$$

LHeC as Linac-Ring version can be as luminous as HERA II:
4 10³¹ can be reached with LR:
 E_e = 40-140 GeV & P=20-60 MW
 LR: average lumi close to peak
 140 GeV at 23 MV/m is 6km +gaps
 Luminosity horizon: high power:
 ERL (2 Linacs?)

M.Klein, ecfa07 talk

ERL based LHeC



	Electrons	Protons Cooling/no Cooling
Energy	140 GeV	7 TeV
N per bunch	0.088 10^{11}	1.7 10^{11}
Rep rate, MHz	40	
Beam current, mA	5.6	1090
Norm emittance, μm	6	0.3 / 3.8
β^* , m	1.3	0.5
ξ^*	6.3	0.0006/ 0.0001
D	.14	
Luminosity, $\times 10^{34} \text{ cm}^{-2} \text{ sec}^{-1}$	0.24 / 0.06	
Loss for SR, MW	67	Kink $\Lambda=0.03$

Hard radiation may be a problem

ERL based LHeC

- Luminosity $3 \cdot 10^{34} \text{ cm}^{-2} \text{ sec}^{-1}$
at all energies of e-beam (probably will be limited by
burn-off of the proton beam)
*Or "ring-ring" luminosity of $10^{33} \text{ cm}^{-2} \text{ sec}^{-1}$ with 3 mA electron beam
current and 2.2 MW loss for SR*
- e-beam current is low (because of the cooling!)
- If further reduction of β^* is possible, $L \sim 10^{35}$ is feasible
- Higher energies of electrons are possible
- e-Beams with very low emittance are possible -> larger β^*
for electron - easier optics, longer detectors, less synch
modulation effects....
- 140 GeV, 5 mA e-beam and luminosity of $4 \cdot 10^{33} \text{ cm}^{-2} \text{ sec}^{-1}$
- Tiny beam pipe to "thru-pass" pp IR regions ?

Low e -current



$$\xi_p = \frac{N_e}{\gamma_p} \cdot \frac{r_p}{4\pi\epsilon_p} = \frac{N_e \cdot r_p}{4\pi\epsilon_p \text{ norm}};$$

- Normalized emittance of electrons $\sim 3 \mu\text{m}$ is possible - no problems to match the proton beam
- @ 100 GeV, $\gamma_e = 2 \cdot 10^5 \sim 300 \gamma_p$, i.e. proton normalized emittance can be as low as $0.01 \mu\text{m}$
- $N_e \sim \epsilon_{\text{norm}}$
- $\sim \epsilon_{\text{norm}} : 3.8 \mu\text{m} \rightarrow 0.1 \mu\text{m} : N_e = 4 \cdot 10^9$
- $I_e = 20 \text{ mA}$, $SR_{\text{loss}} = 57 \text{ MW}$ (the same as Ring-Ring with 100 x luminosity!)

Other considerations

- May (for the most part) fit inside the LHC tunnel.

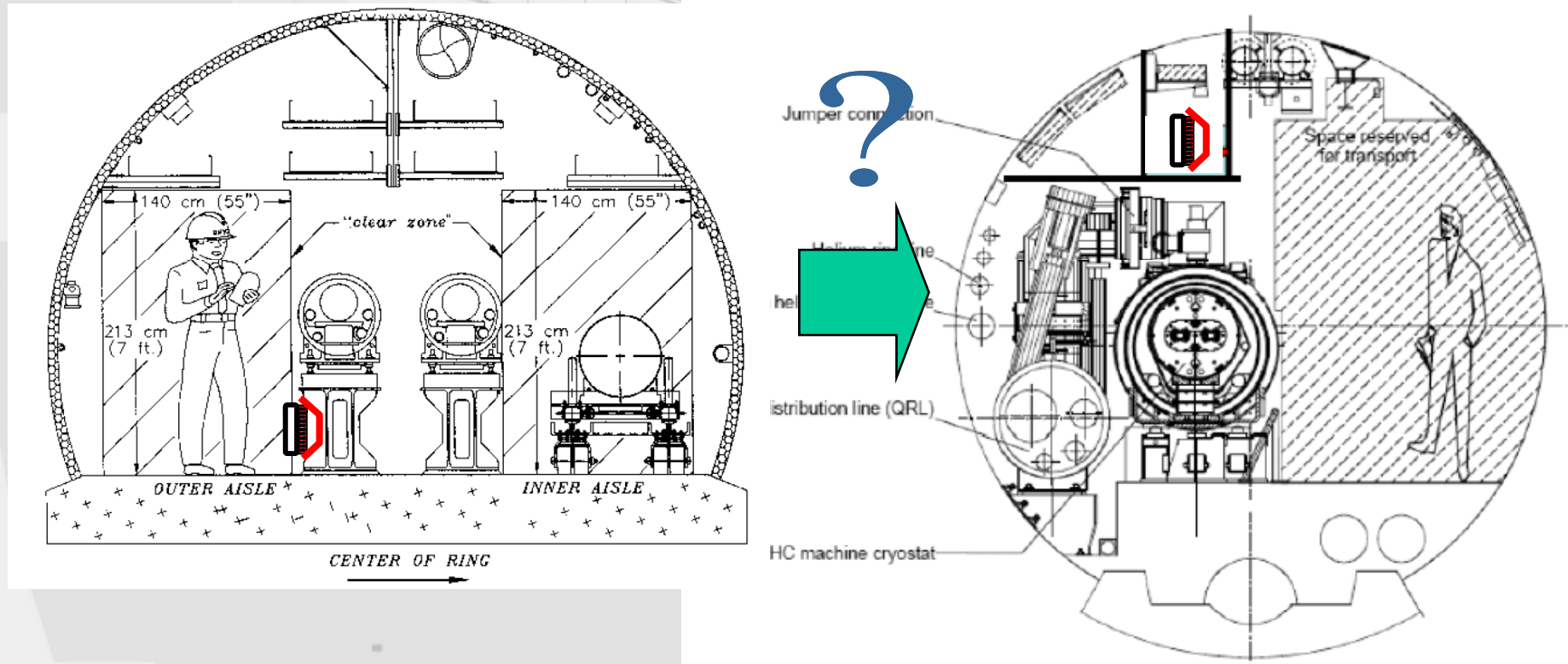

- Tiny e beam pipe to thru-pass pp IRs ?

Other considerations

- Is there room for linac in the straights?

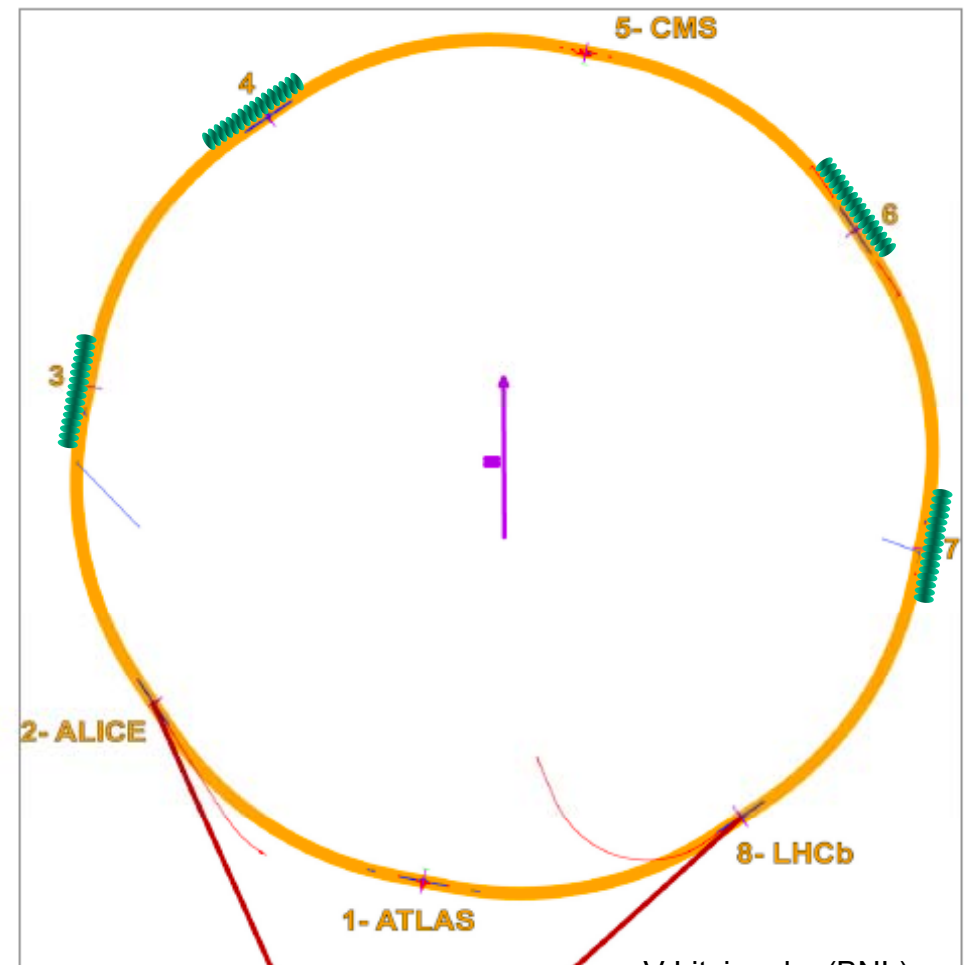
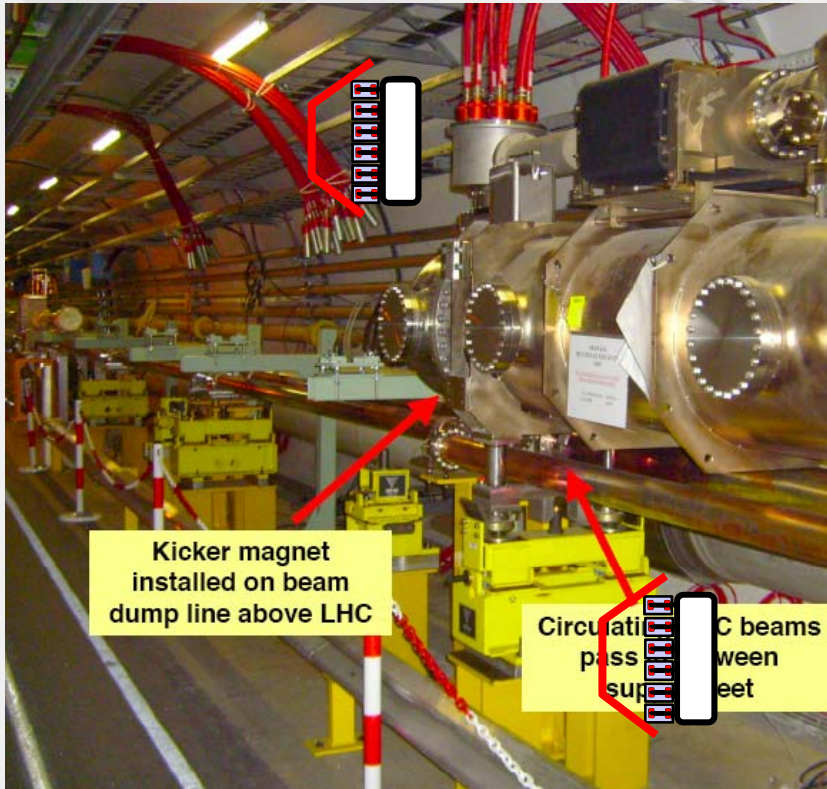

Conclusions: ERL



- ERL seems to be the most promising approach for high energy, high luminosity electron-ion and polarized electron-proton collider
- It can take advantage of any ring-ring concept and go further
- Presently there is no show-stoppers but a significant amount of R&D
- At BNL the R&D ERL tests in 2009, MIT's progress with developing high current polarized gun, prototyping of small gap magnets will next step-stones towards QCD factory at BNL.
- LHeC based on this principle reach 10^{34} - 10^{35} level of luminosity

Polarised Positron
Workshop
Meeting
Cockcroft Institute
March 28th 2008

THE COCKCROFT INSTITUTE
of ACCELERATOR
SCIENCE and TECHNOLOGY



UNIVERSITY OF
LIVERPOOL



4. Experiment

Sensitivity



- rates: energy can win you TeV^2 in Q^2

100 fb^{-1} 70 GeV e-ring

10 fb^{-1} 140 GeV e-linac

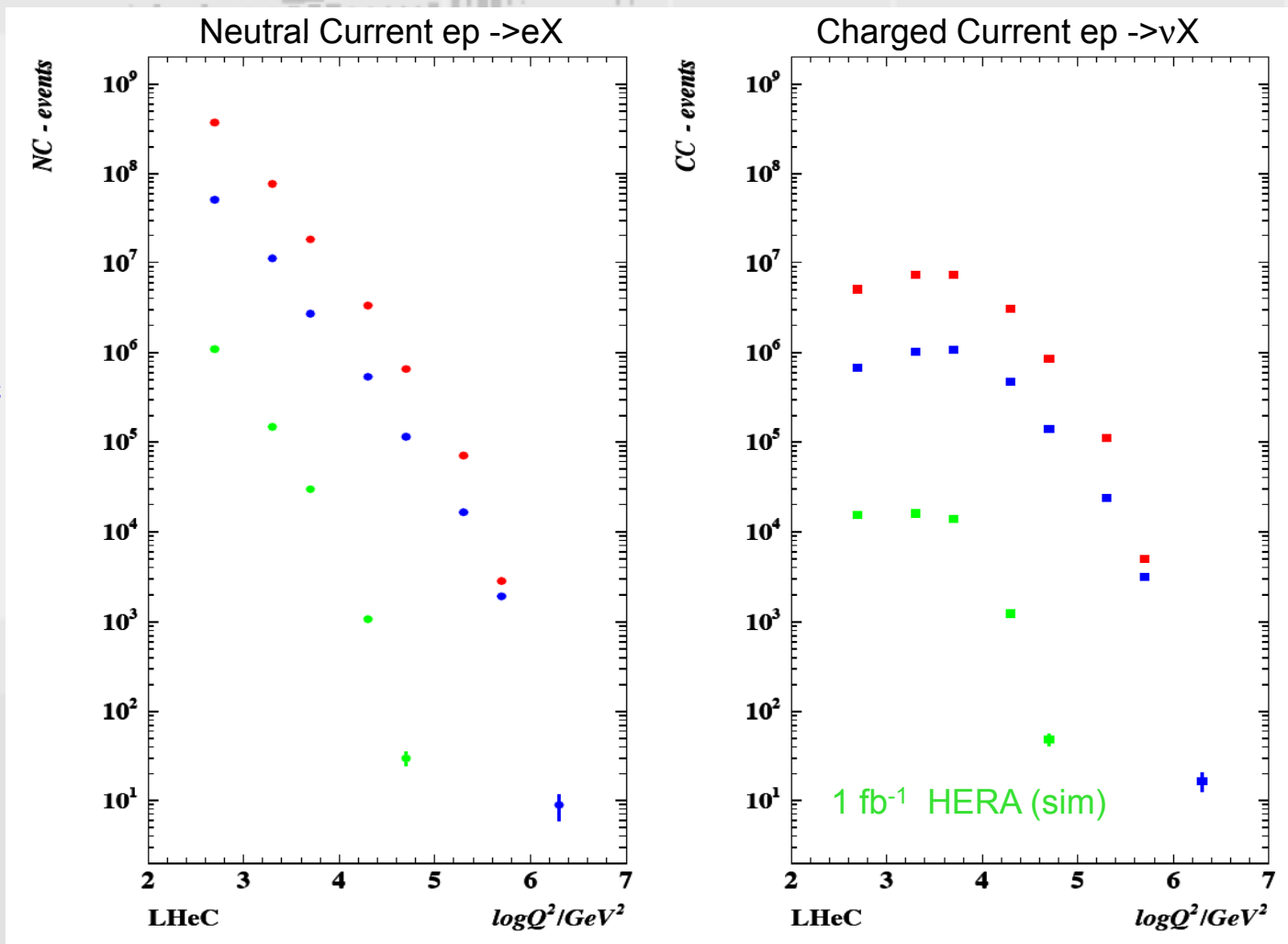

IR and Experiment



- IR \pm many m
- IR $\geq 9.4^\circ$ around beam

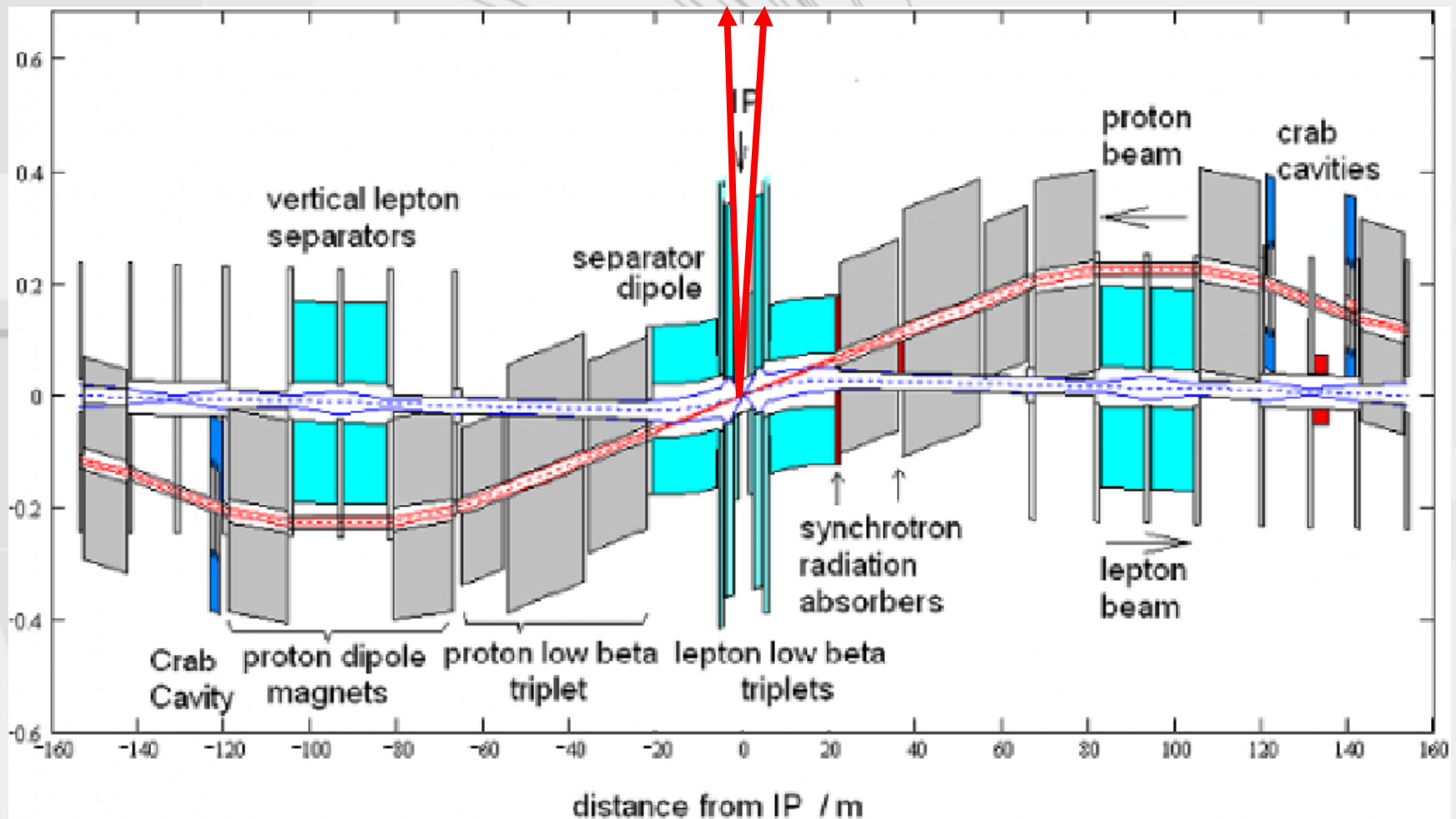

Asymmetric Collider

- asymmetric beam momenta: LHeC

~ TeV

quark

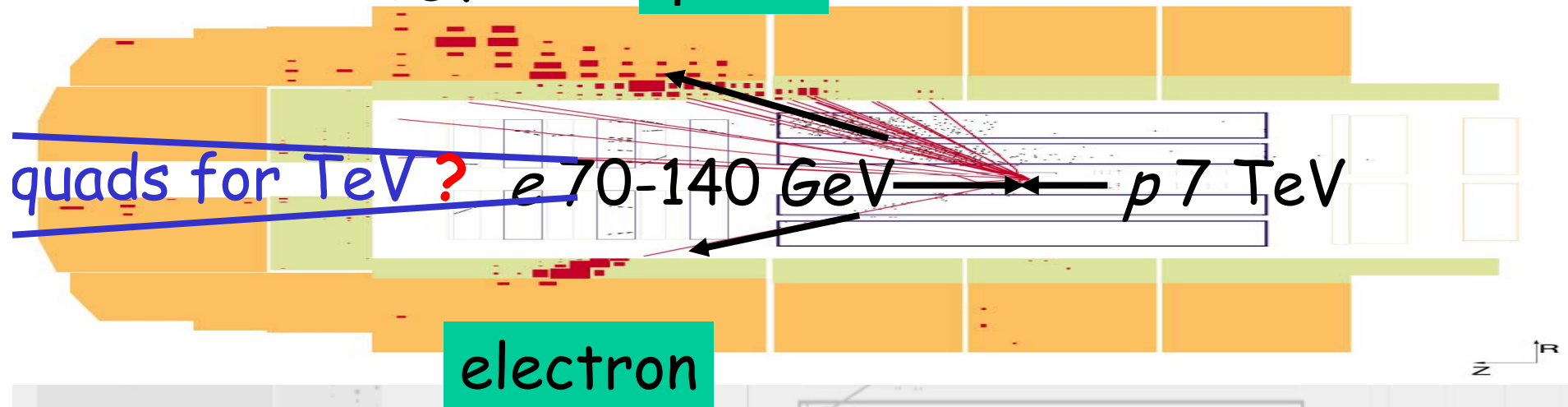

- "forward" hemisphere detection to multiTeV
topological challenge
precision challenge
- "backard" hemisphere detection to fewx10 GeV

IR Kinematics

LHeC – Low x Kinematics

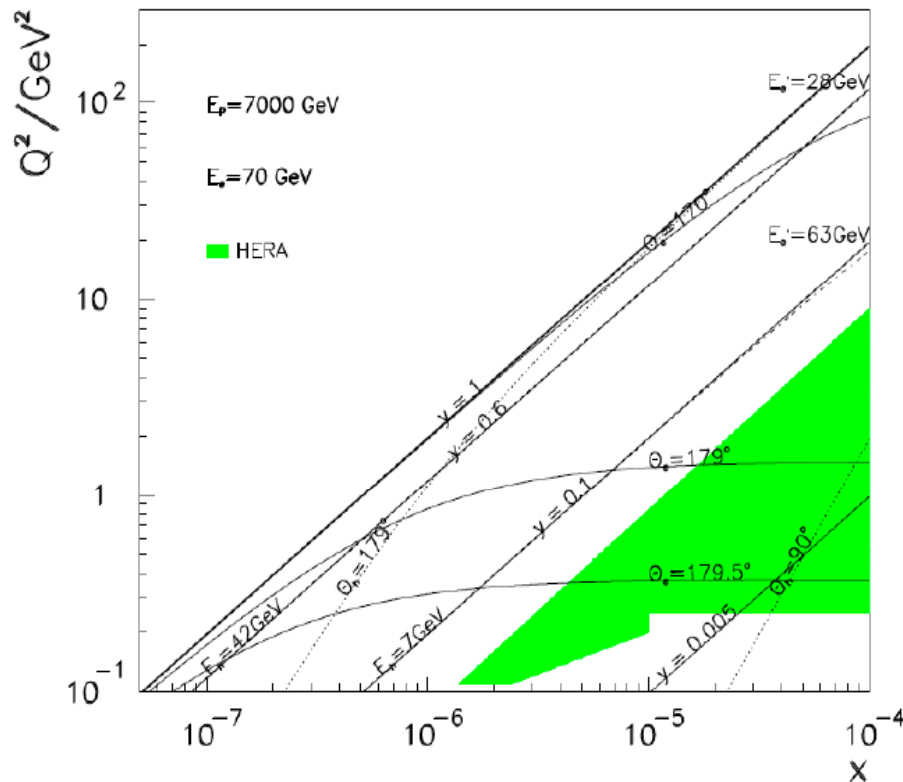

- backward e
- forward remnant 1_c

LHeC – High Q^2 Kinematics

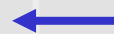
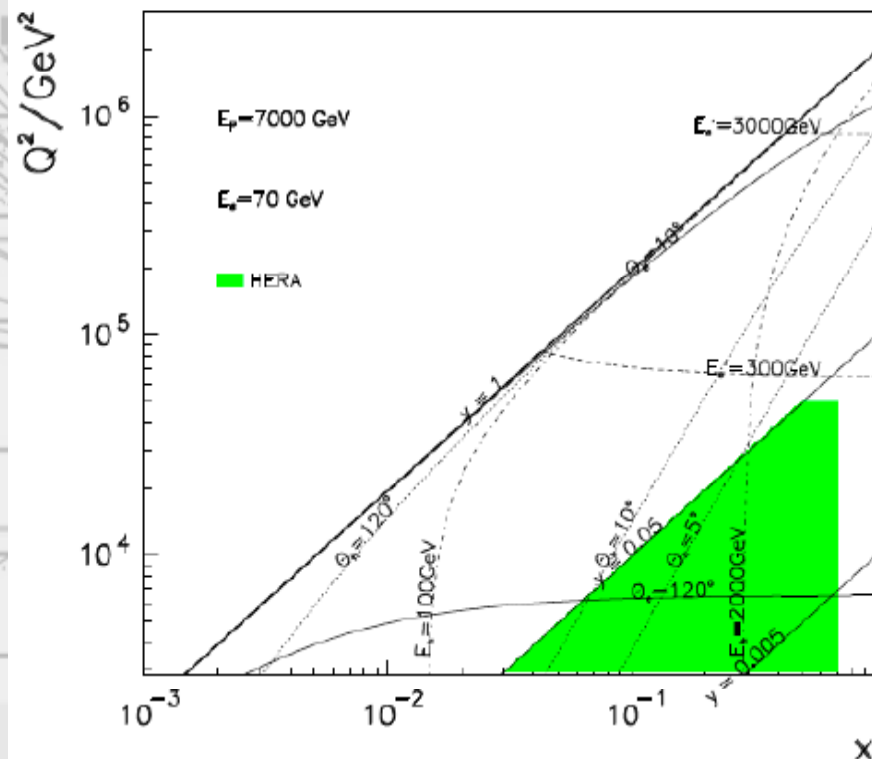

- forward TeV hadrons

ep is precision @ every scale

- Neutral Current

$$ep \rightarrow eX$$

~~$p_{T\text{miss}}$~~

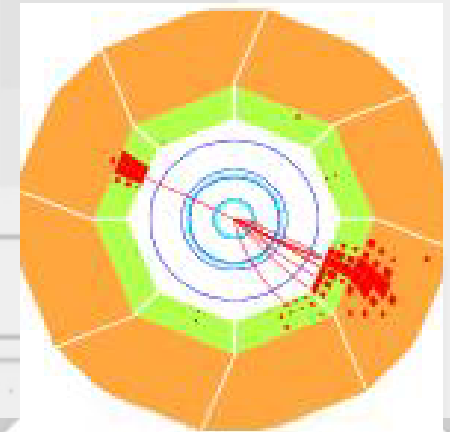
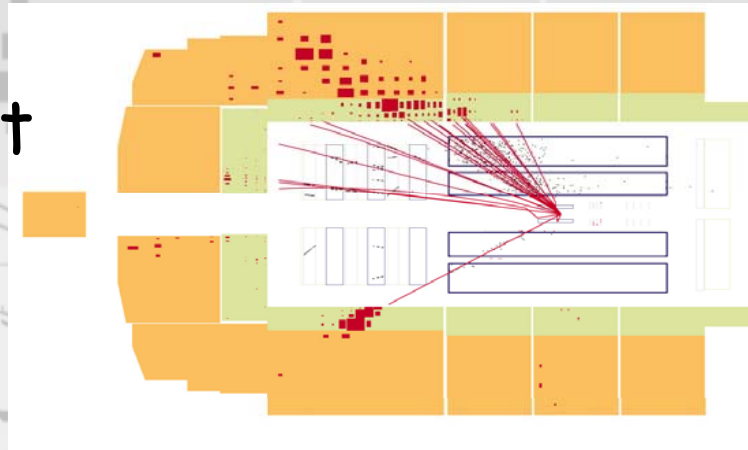

- $ep \rightarrow ? + \text{lepton} + X$
 $p_{T\text{miss}} + \text{lepton}$

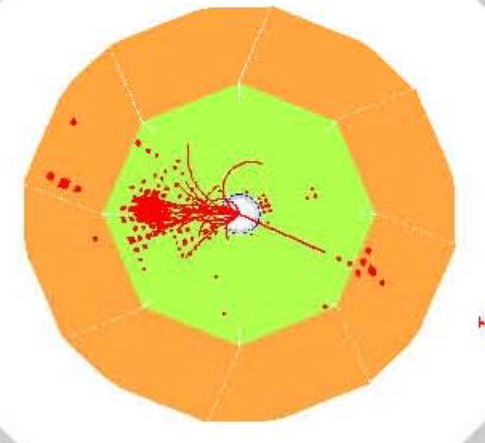
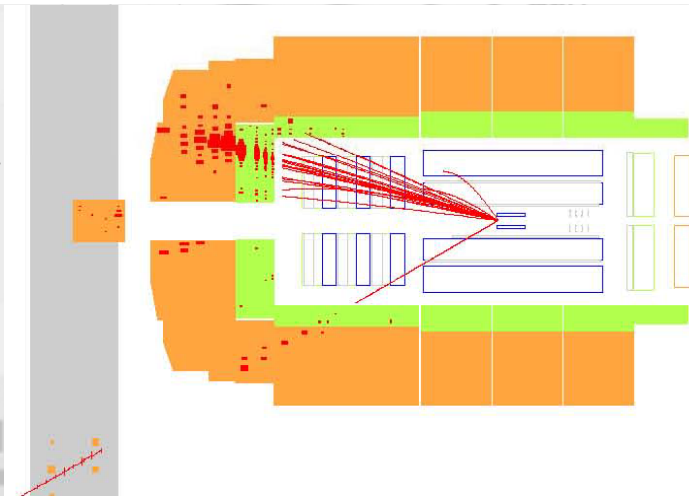

- precision @ TeV scale of lepton+quark

eq vq tq cf HERA

Polarised Positron
Workshop
Meeting
Cockcroft Institute
March 28th 2008

THE COCKCROFT INSTITUTE
of ACCELERATOR
SCIENCE and TECHNOLOGY



UNIVERSITY OF
LIVERPOOL



5. When? Towards a CDR

Timeline

- 2007: form working groups + steering committee ✓
initial meeting of conveners + committee ✓
SAC ✓ overview
- 2007/8: ECFA/CERN endorsement "work out" ✓
- 2008: workshop I September 8+9 Divonne CH
- 2009: workshop II
LHeC CDR [LHC Committee]
- 2011: LHeC TDR
 - construction 8 years ?
 - impact on LHC: civil engineering + installation
e-ring and e-linac
 - be aware of CLIC progress

WG Structure



- accelerator (injector, ring or linac)

Oliver Bruening (CERN) JBD (CI)

- interaction region (+ small angle detectors)

tba

- infrastructure

CERN + tba

- detector

tba

- the new physics

tba

- precision QCD and electroweak

tba

- physics of high parton density

tba



Accelerator Design [RR and LR]

Closer evaluation of technical realisation: injection, magnets, rf, power efficiency, cavities, ERL...

What are the relative merits of LR and RR? Recommendation.

Interaction Region and Forward Detectors

Design of IR (LR and RR), integration of fwd detectors into beam line.

Infrastructure

Definition of infrastructure - for LR and RR.

Detector Design

A conceptual layout, including alternatives, and its performance [ep and eA].

New Physics at Large Scales

Investigation of the discovery potential for new physics and its relation to the LHC and ILC/CLIC.

Precision QCD and Electroweak Interaction

Quark-gluon dynamics and precision electroweak measurements at the TERA scale.

Physics at High Parton Densities [small x and eA]

QCD and Unitarity, QGP and the relations to nuclear, pA/AA LHC and SHEv physics.

LHeC Scientific Advisory Committee



Experimentalists

Joel Feltesse (Saclay/DESY)

Aharon Levy (Tel Aviv)

Allen Caldwell (MPI München) Chair

Roland Horisberger (PSI)

Richard Milner (MIT)

John Dainton (Univ Liverpool)

Accelerator

Stephen Myers (CERN)

Swapan Chattopadhyay (Cockcroft Inst)

A Skrinsky (Budker)

Roland Garoby (CERN)

Ferdy Willeke (DESY/BNL)

Theory

Guido Altarelli (Roma)

Lev Lipatov (Petersburg)

Frank Wilczek (MIT)

Stan Brodsky (SLAC)

John Ellis (CERN)

Labs

Jos Engelen (CERN)

Young-Kee Kim (Fermilab)

Rolf Heuer (DESY)

Peter Bond (BNL)

Steering Group



Oliver Bruening	(CERN)
John Dainton	(Cockcroft)
Albert DeRoeck	(CERN)
Stefano Forte	(Milano)
Max Klein - chair	(Liverpool)
Paul Newman	(Birmingham)
Emmanuelle Perez	(CERN)
Wesley Smith	(Wisconsin)
Bernd Surrow	(MIT)
Katsuo Tokushuku	(KEK)
Urs Wiedemann	(CERN)

- setting up WGs + workshop I

Polarised Positron
Workshop
Meeting
Cockcroft Institute
March 28th 2008

THE COCKCROFT INSTITUTE
of ACCELERATOR
SCIENCE *and* TECHNOLOGY



UNIVERSITY OF
LIVERPOOL



4. Summary



- $LHeC$ 70-140_e \otimes 7000_p GeV
 - can be built
 - has **startlingly** good **luminosity** $\geq 10^{34}$ cm⁻²s⁻¹
grows with LHC *pp* luminosity
 - extends substantially, uniquely, and with synergy
to LHC_{TeV} **discovery** physics
 - probes chromodynamics
@ new density frontier
in uniquely comprehensive manner *ep eA*
with unchallengable **precision**
synergetically with LHC *pp pA AA*

Proposal to ECFA



As an add-on to the LHC, the LHeC delivers in excess of 1 TeV to the electron-quark cms system. It accesses high parton densities 'beyond' what is expected at the unitarity limit. Its physics is thus fundamental and needs to be further worked out, also with respect to the final state of the LHC and the final results both from the Tevatron and the LHC.

First considerations of a linac-ring and a linac-ring accelerator layout lead to an optimal combination of energy and luminosity for high energy physics, exploiting the latest developments in accelerator and detector technology.

It is thus proposed to hold two workshops (2008 and 2009), under the auspices of ECFA and CERN, with the goal of having a Conceptual Design Report on the accelerator, the experiment and the physics. A Technical Design report will then follow if appropriate.

Endorsed by ECFA
November 30th 2007

Lepton + quark @ TeV

- **energy** for
TeV *eq* discovery
extreme chromodynamics

LHeC and LHC

- **precision** for
TeV *eq* discovery
eq understanding
extreme chromodynamics

LHeC and ILC/CLIC

- **luminosity** for
TeV *eq* discovery

LHeC and LHC

- **energy range** for
QCD phase equilibria

LHeC RHIC FT LHC

Polarised Positron
Workshop
Meeting
Cockcroft Institute
March 28th 2008

THE COCKCROFT INSTITUTE
of ACCELERATOR
SCIENCE and TECHNOLOGY



UNIVERSITY OF
LIVERPOOL



Extras

Lepton Ring



- in LEP tunnel ... so like LEP

- FODO in eight arcs

- β -tron phase advance $\varphi_H=108^\circ$ $\varphi_V=90^\circ$

- bending radius 3133.3 m

- $(\delta E/E_{\text{beam}})_{\text{rms}} = 1.1 \times 10^{-3}$

- SR 26 W/cm ($E_c=254$ KeV)

- scRF @ 1GHz resonators @ 12 MV/m
100 m structure = 670 cells

- sync. phase 31°

- bucket takes $10 \times (\delta E/E_{\text{beam}})_{\text{rms}}$

- unlikely e -beam instability
single bunch current modest
impedance \ll LEP

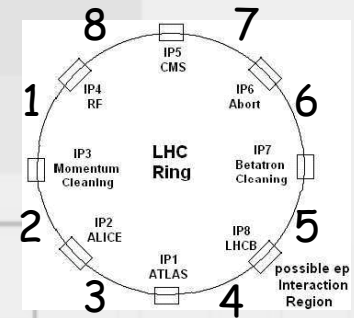

LEP=9 W/cm

HERA=13.5 W/cm

scRF proven
@ > 6 MV/m

Interaction Region

- highest lumi
 - low β_e
 - ↪ close sc quads
 - low X-ing angle
 - ↪ "hard" bend
 - 8 σ beam sepⁿ
 - ↪ SR fan
 - sc p-beam
 - « HERA
 - "crab" RF cavity
 - p-bunch rotation
- 1^o beam access = low-lumi/low-x option (cf HERA)

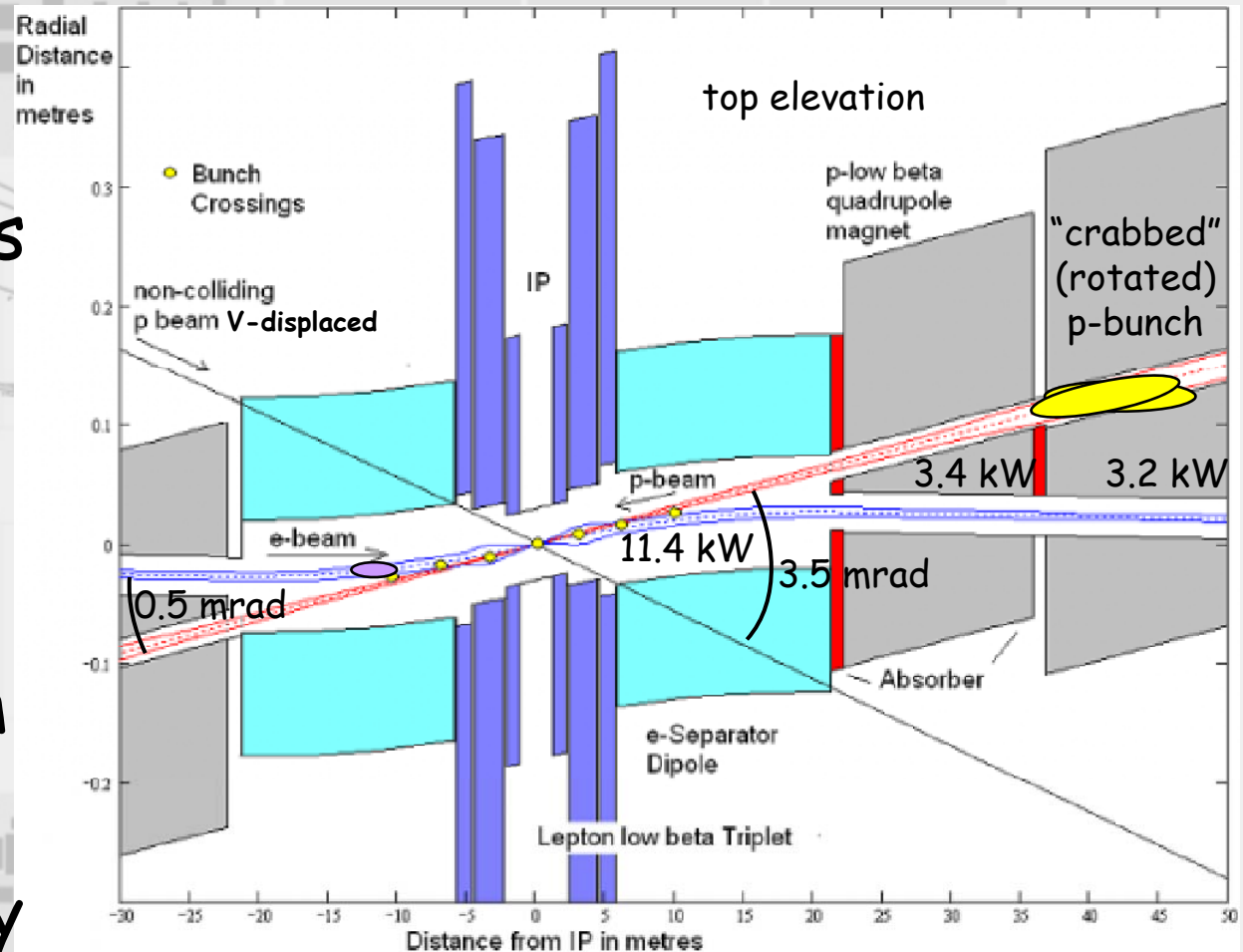

Operational Luminosity

- beam-beam
 - "hour-glass"
 - dynamic β : < HERA
 - long range beam-beam (parasitic interactions):

marginal



↪ operational luminosity

$$I_e = 74 \text{ mA}, N_p = 1.68 \cdot 10^{11}, \gamma_f = 7460, \epsilon_p = 0.5 \text{ nm}$$

$$\epsilon_{xe} = 25 \text{ nm}, \epsilon_{ye} = 5 \text{ nm} \text{ and } R = 0.89$$

$$L = \frac{I_e \cdot N_p \cdot \gamma_p \cdot R}{4 \cdot \pi \cdot e \cdot \sqrt{\epsilon_p \beta_{xp} + \epsilon_{ye} \beta_{ye}} \cdot \sqrt{\epsilon_p \beta_{yp} + \epsilon_{ye} \beta_{ye}}} = 1.04 \cdot 10^{33} \text{ cm}^{-2} \text{ s}^{-1}$$

Polarisation @ LHeC



SPIN IS IN

B. MONTAGUE
1980

LEB:
hours

The

The

Plan

Depolarization is worst at RESONANCES.
Begin NOW with intense careful study based on experience to investigate tricks.

At high energy the synchrotron sideband resonances take control:

- Need very good alignment Strength scales as $\left(\frac{a\gamma}{Q_s} \frac{\sigma_\delta}{Q_s}\right)^2$
- Siberian Snakes to suppress the effect of energy spread and synchrotron motion on spin
- Overall, roughly at each energy:
These are essential in proton rings to suppress depolarising resonances during acceleration (e.g., RHIC).
- But longitudinal polarization kills the polarisation effect of the system and radiation is only distributed around the IP! and back to the vertical afterwards ==> spin rotators.
- Depolarization can be strongly enhanced by mistakingly using spin rotators etc, etc....

What's been achieved



- Sokolov-Ternov + spin-rotators @ HERA

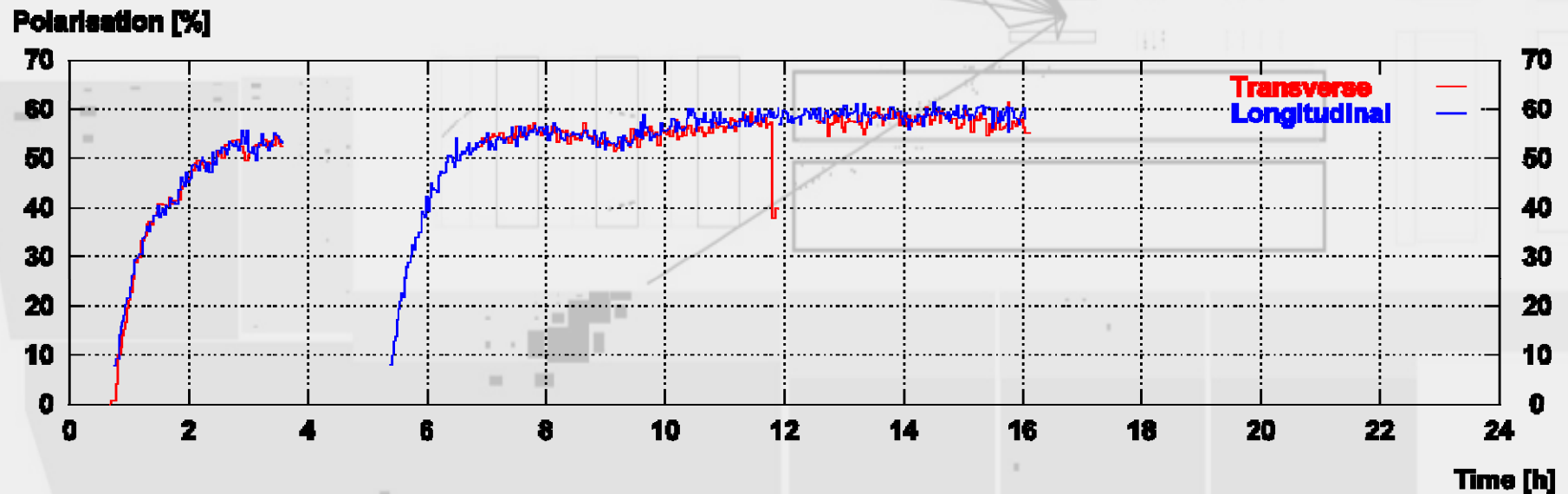
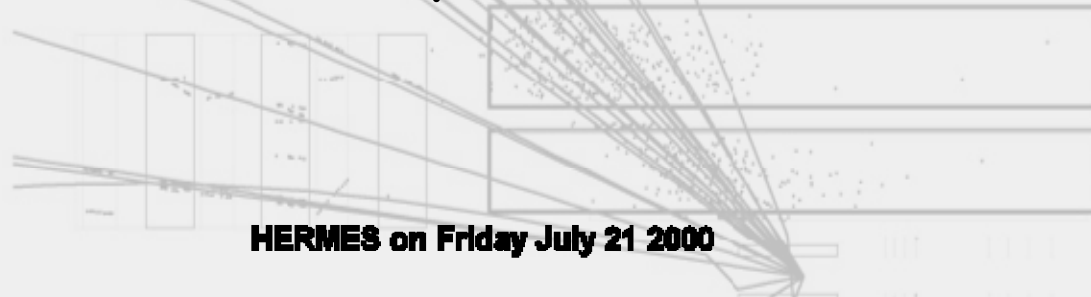

What's been achieved

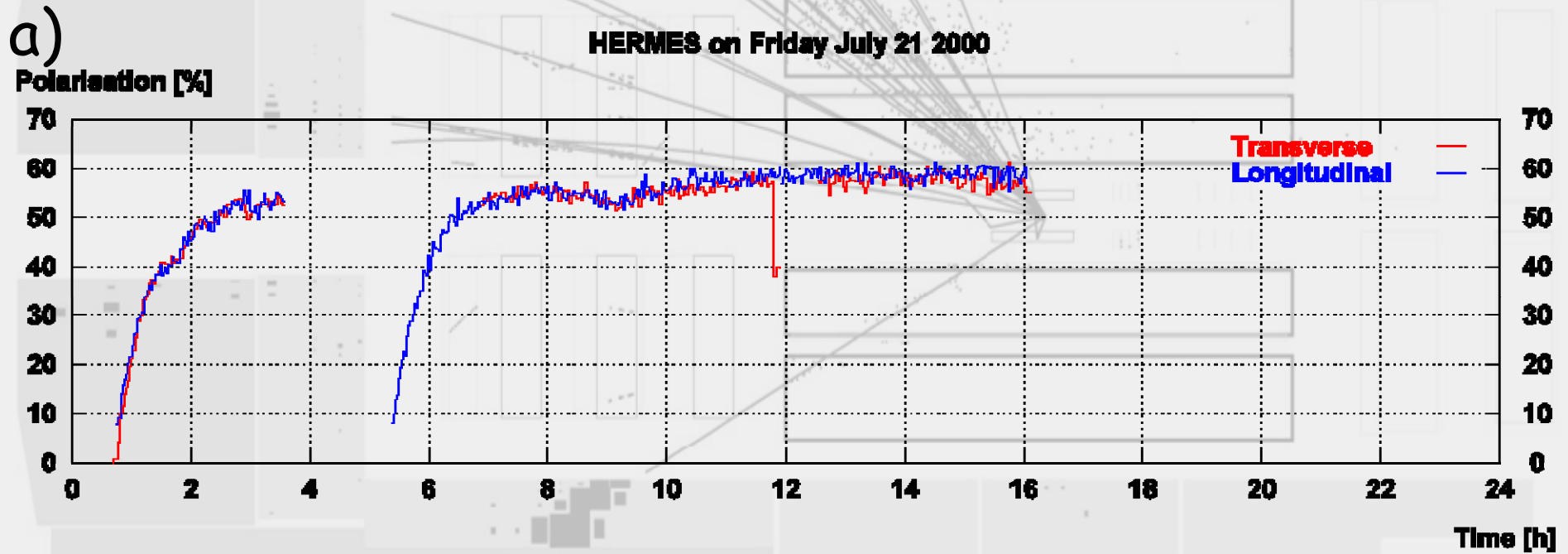

LHeC



- tunnel exists (LEP, LHC)
 - injection once existed (LEP) ?
 - operating p -beam (from 2008)
 - operating A -beam (from 2008)
 - ep eA operating alongside pp pA AA
 - *the* TeV ep collider !
 - "minimal" mods to LHC !
- ↳
- LHC upgrade
 - cost ?

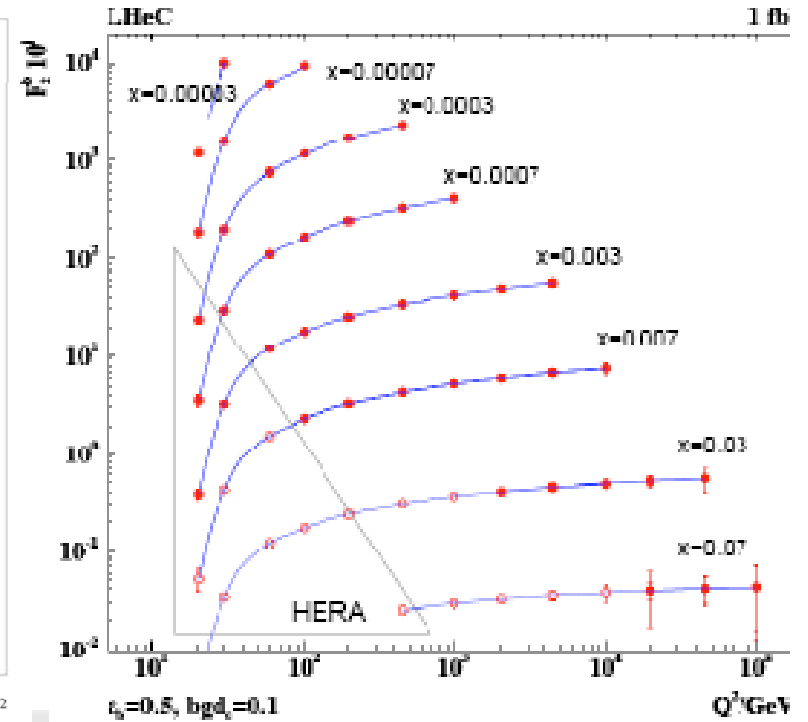
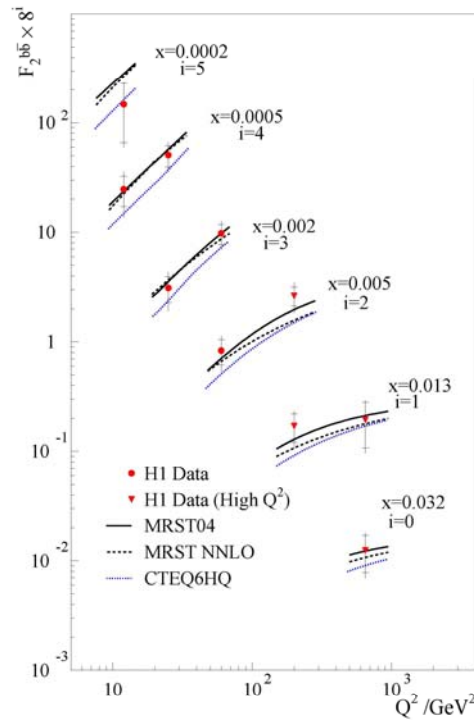
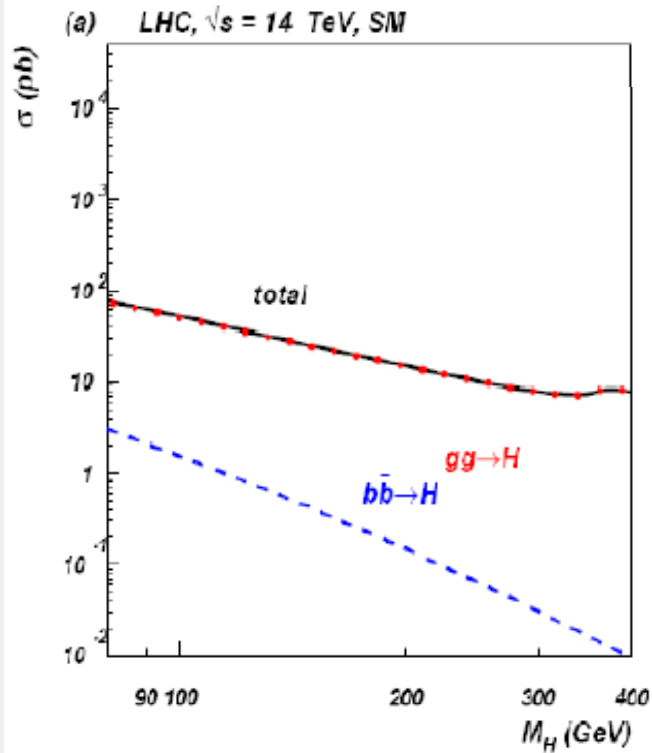

What's been achieved

- Sokolov-Ternov @ LEP₇₀ GeV

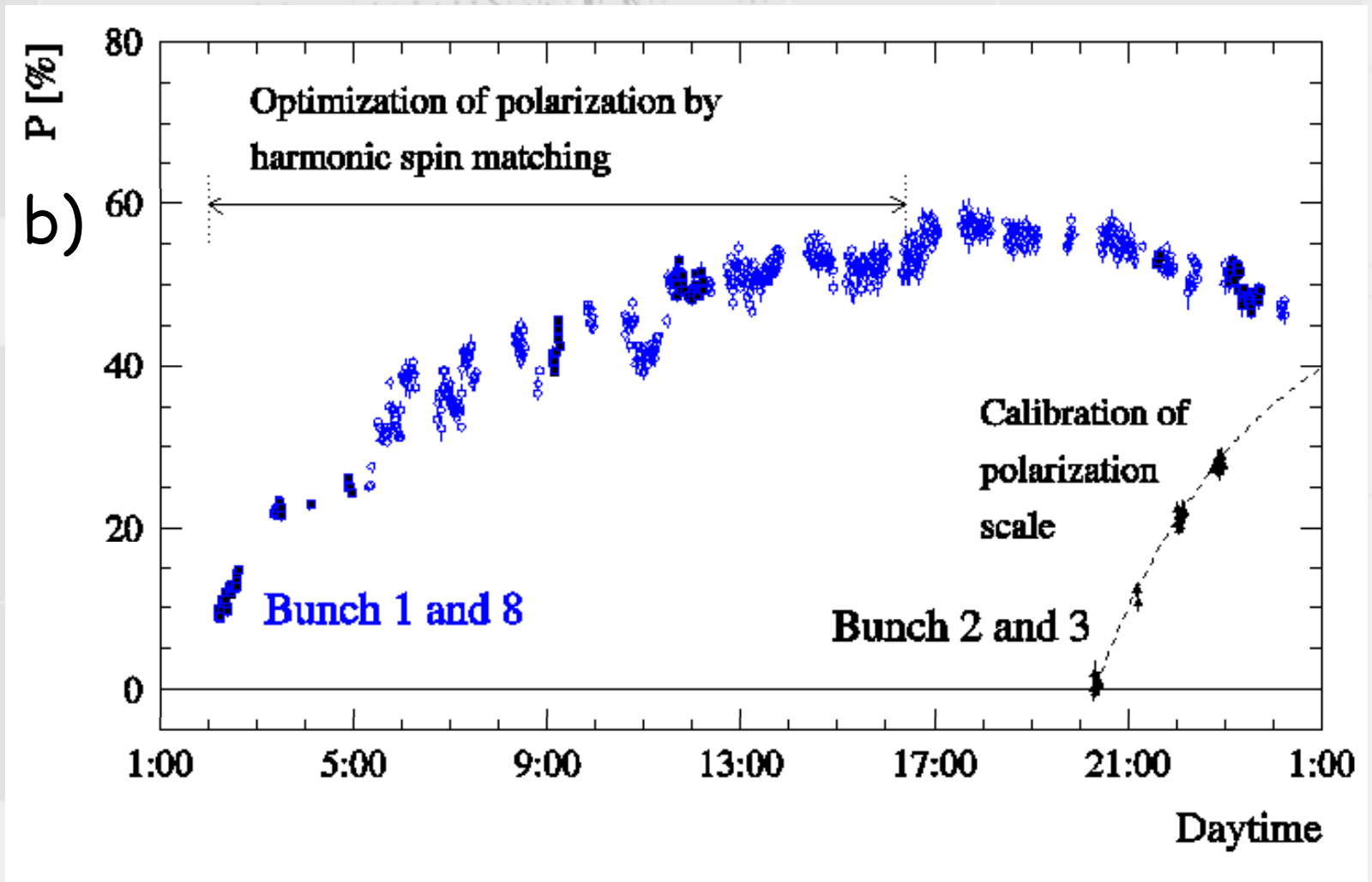

Diffraction and Rapgap



- rapgap @ LHeC ?

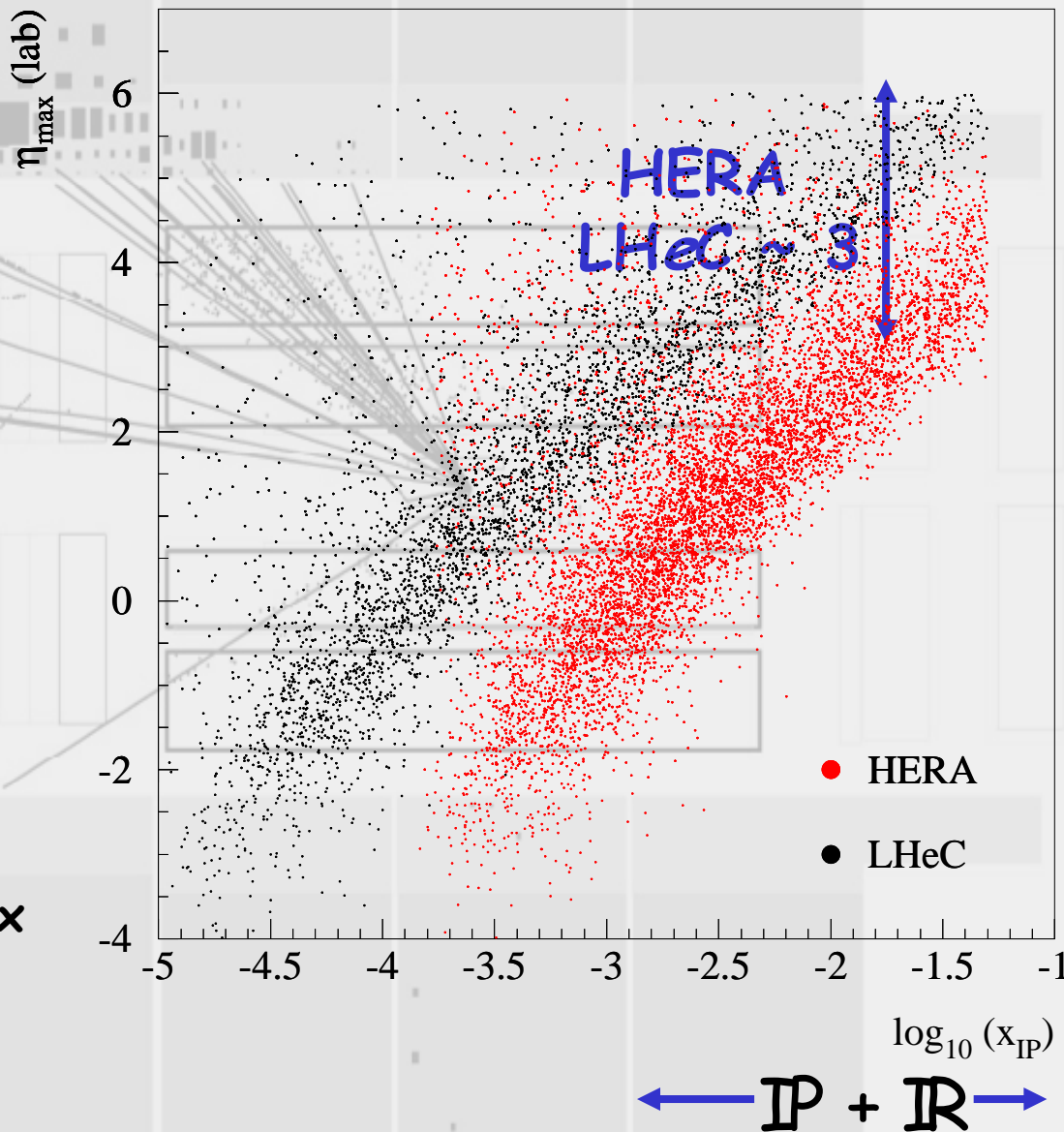
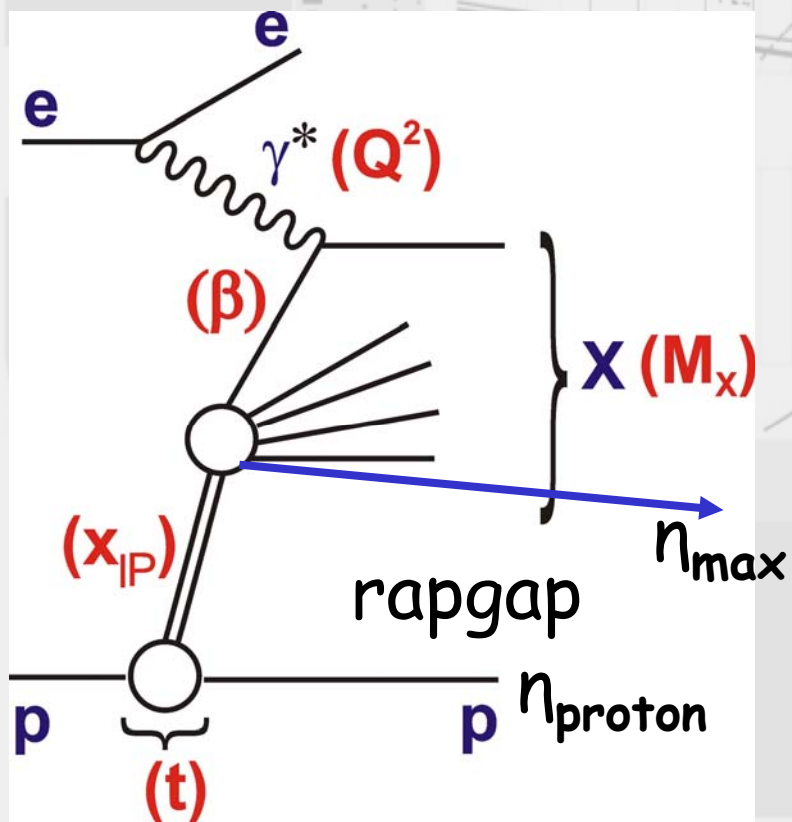

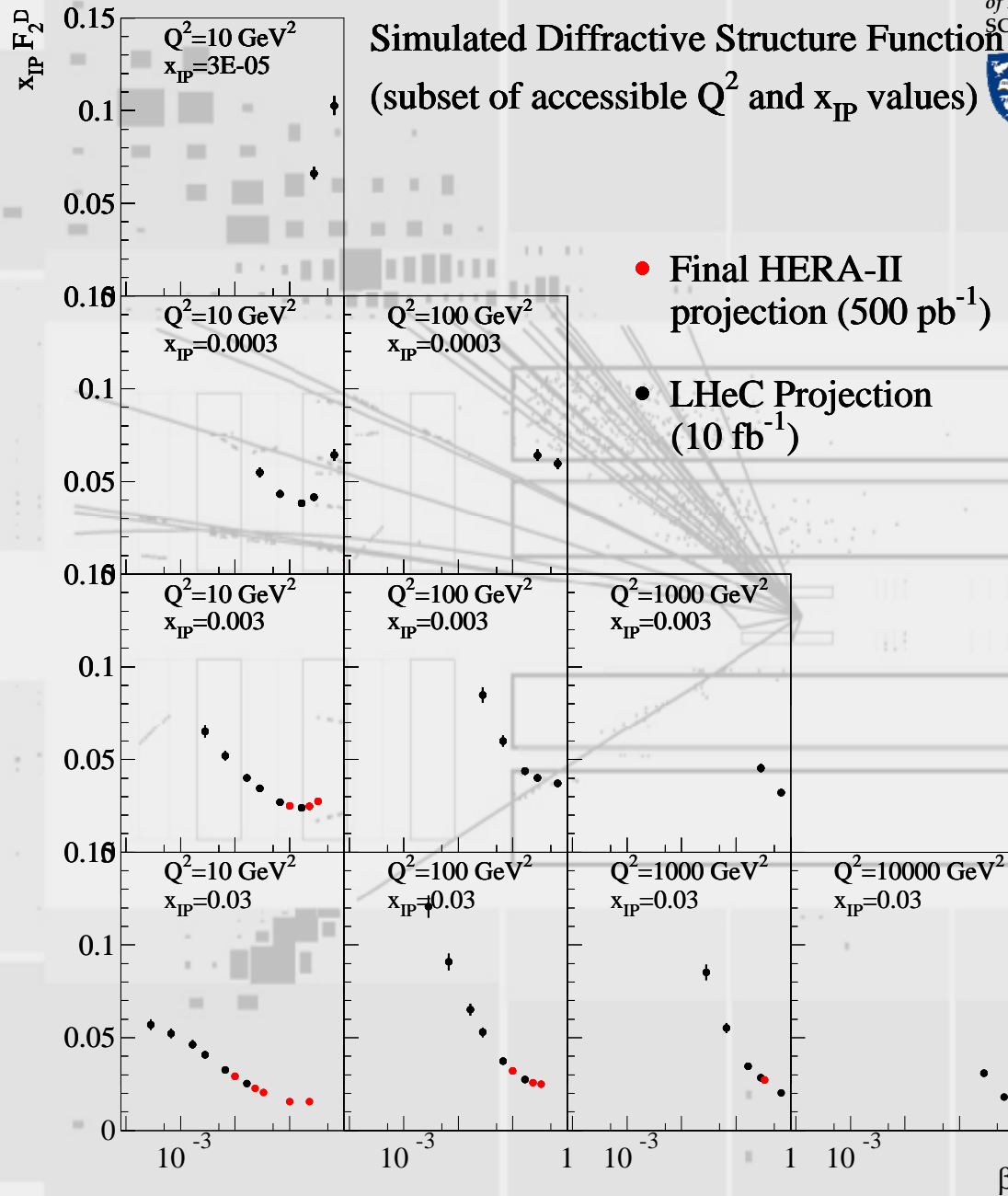

Acceptance and Measurement

- 70 – 7000 GeV
- high lumi quads ($\pm 10^\circ$ bp)
 $Q_e^2 > 100 \text{ GeV}^2$ $x > 3 \times 10^{-5}$
- few GeV $\leq E_{h,e} \leq$ few TeV
- low lumi for low x (no quads)
 $1 < Q^2 < 100 \text{ GeV}^2$
 $x < 3 \times 10^{-5}$

“forward” hadrons:

“forward rapgap” instrumentation

precision e/had -measurement

$170 < \theta_e < 179^\circ$ $170 < \theta_h < 179^\circ$

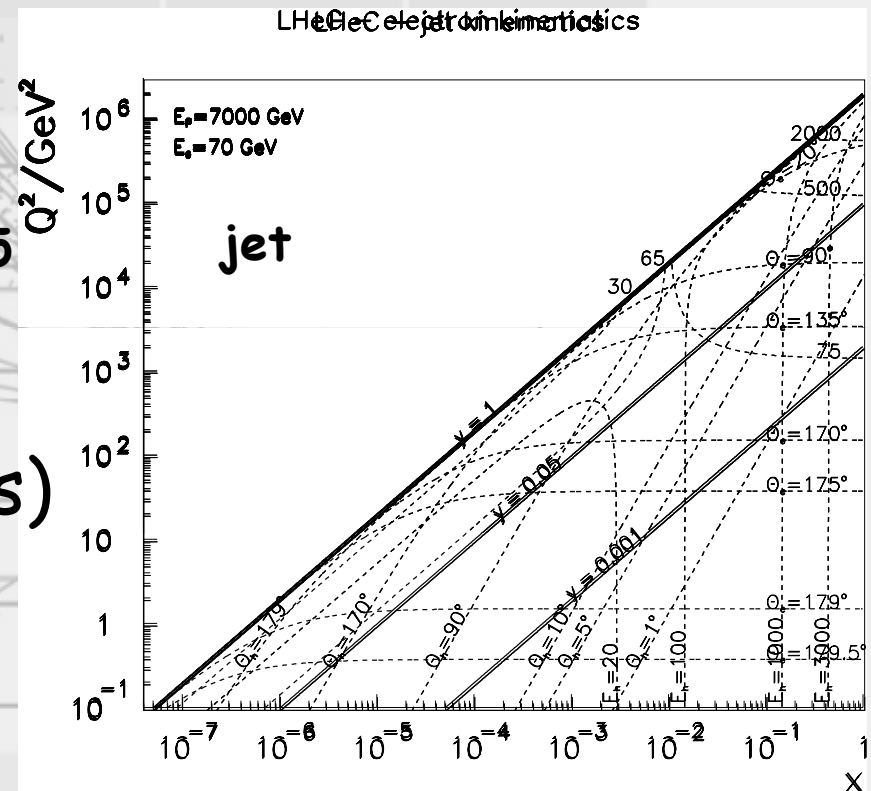

Rate



• $100/10 \text{ fb}^{-1}$
= $100/3 \times \text{LHeC } \gamma$

@ $Q^2 = 1 \text{ TeV}^2$

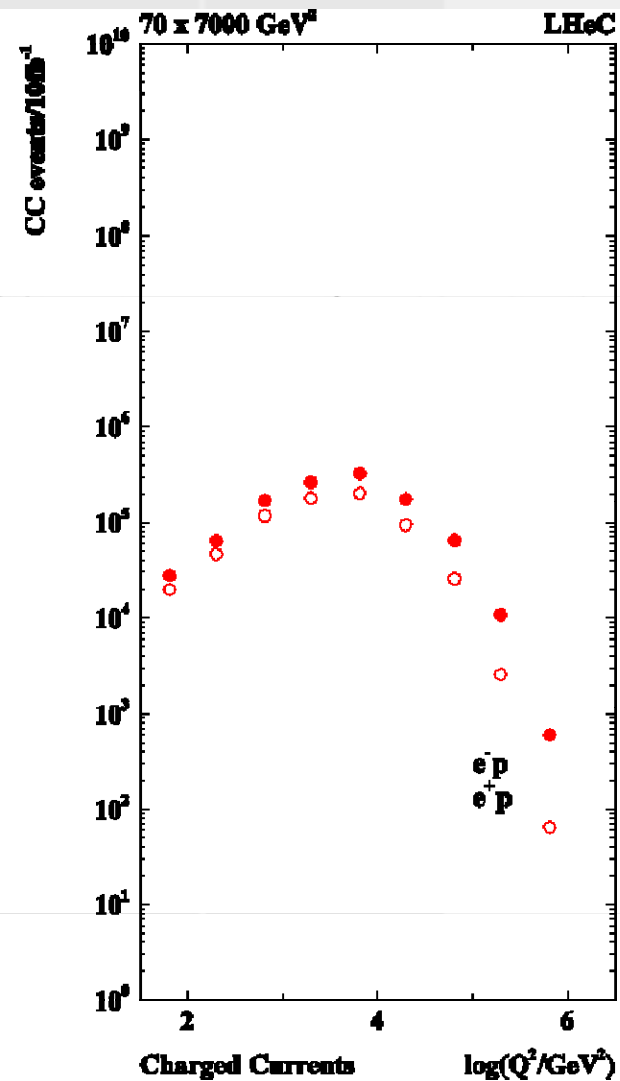
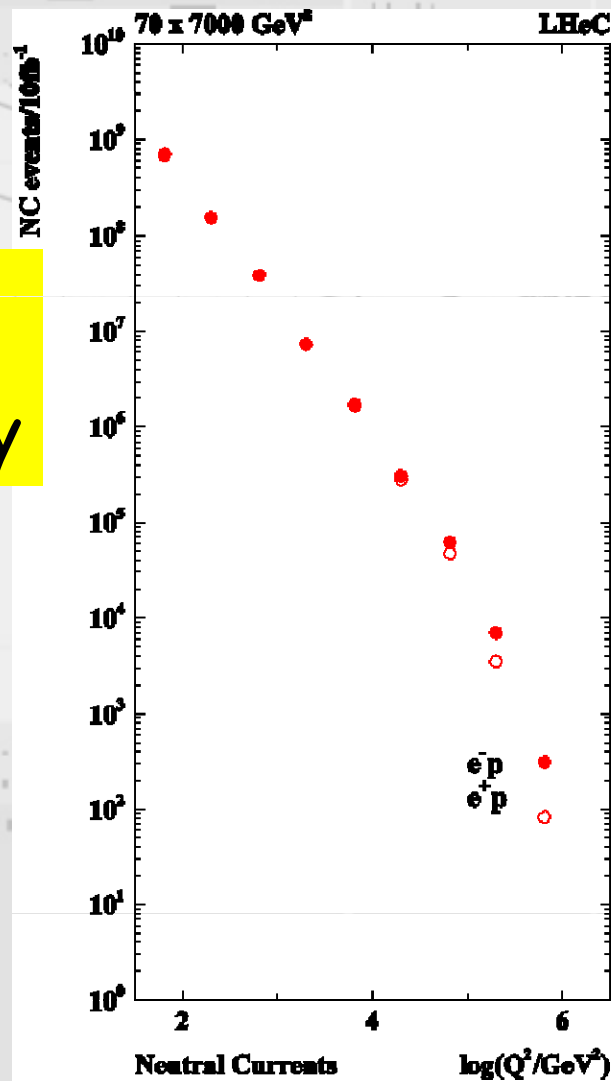



Needle in a haystack.

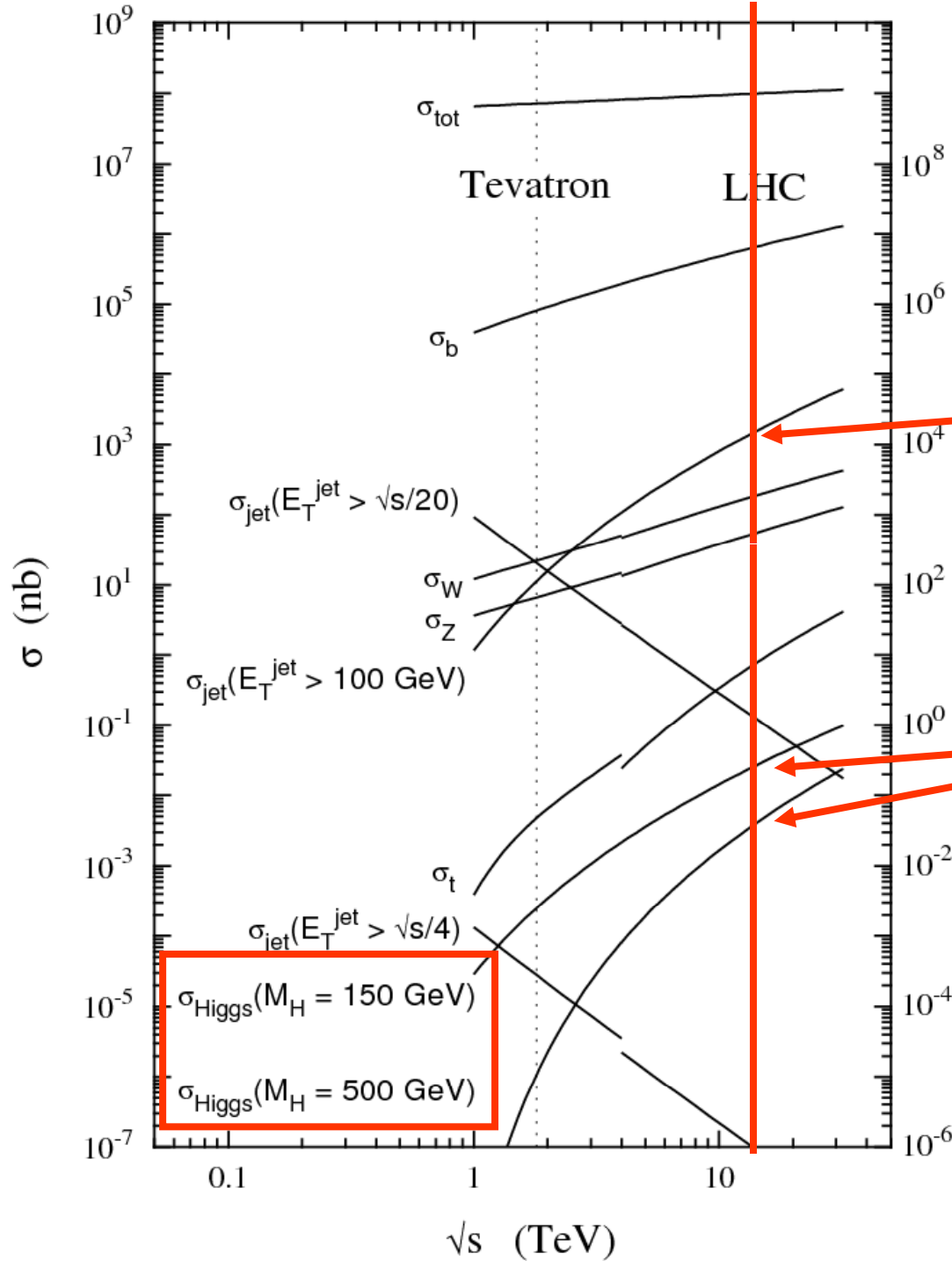

QCD jet production
at high energy

Higgs production

Need to use signatures
with **small backgrounds**:

- Leptons
- High-mass resonances
- Heavy quarks

to avoid being overwhelmed

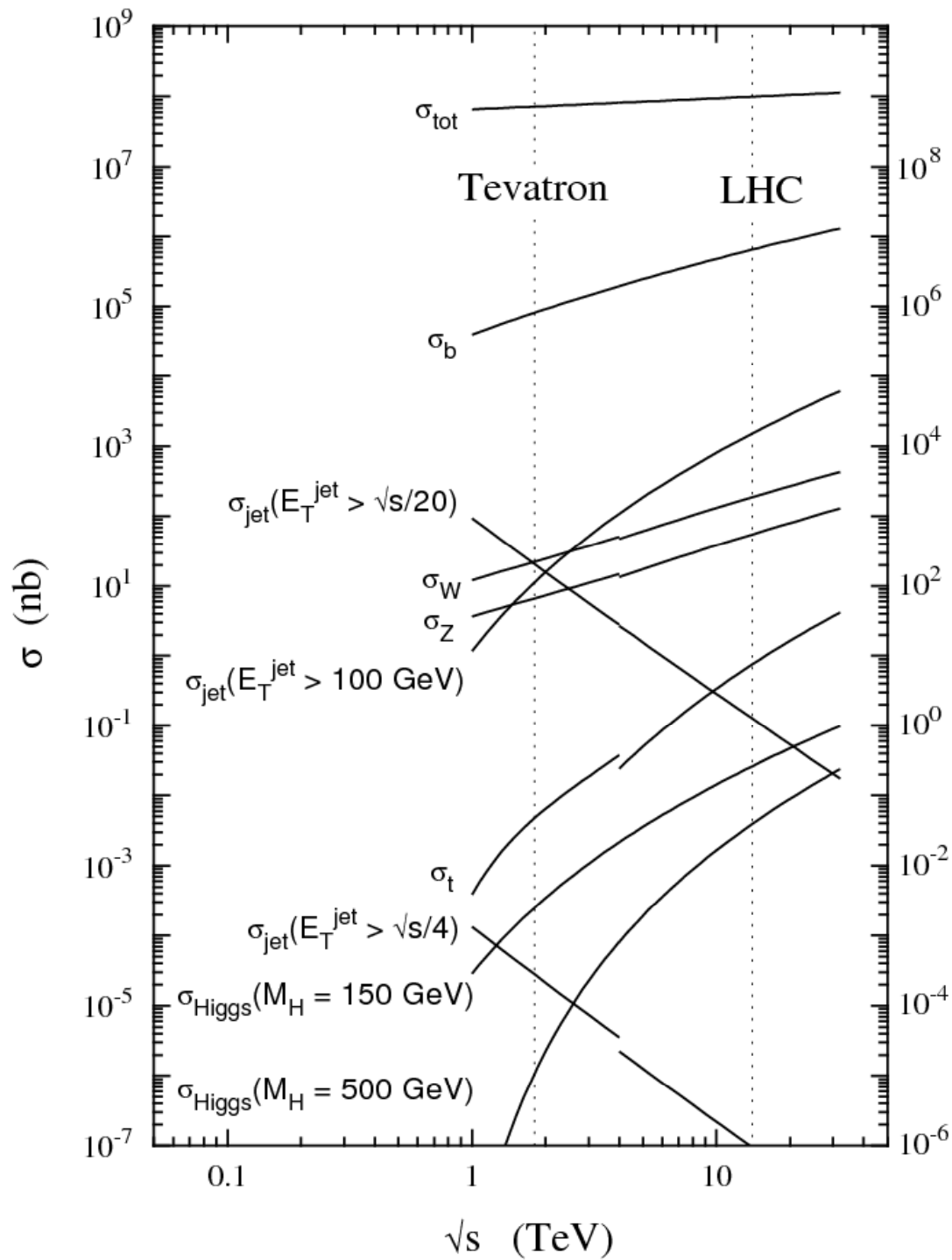

events/sec for $L = 10^{34} \text{ cm}^{-2} \text{ s}^{-1}$

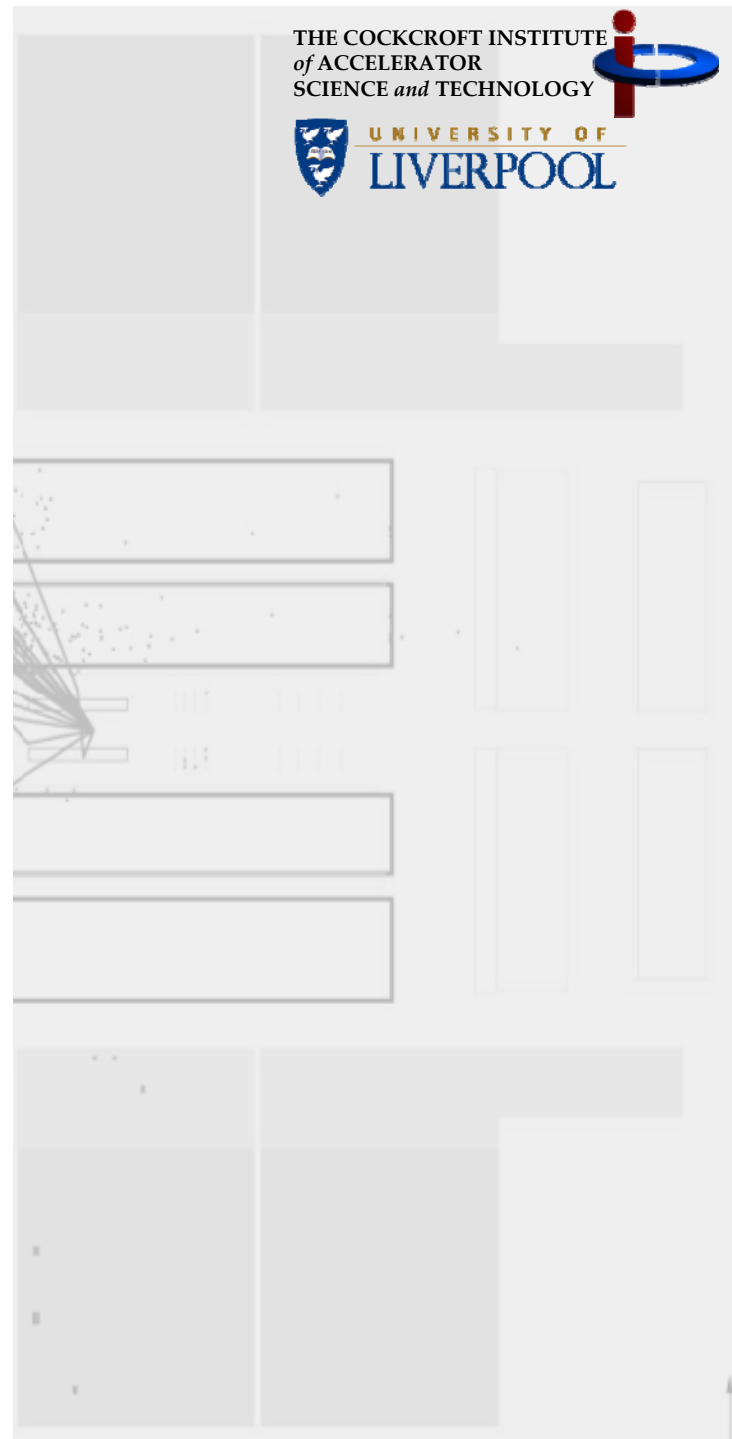

Producing a Higgs

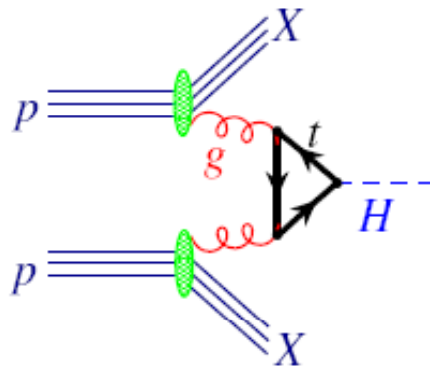

Gluon fusion

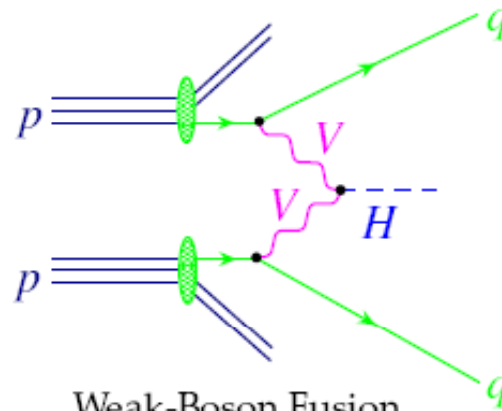

Weak-Boson Fusion

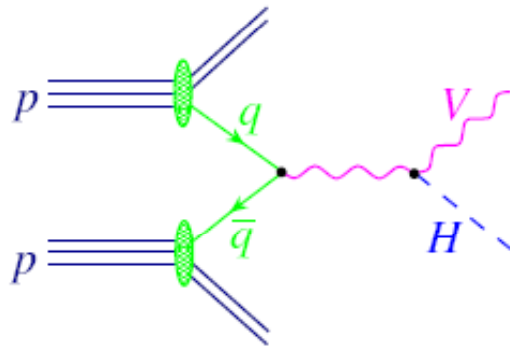

Higgs Strahlung

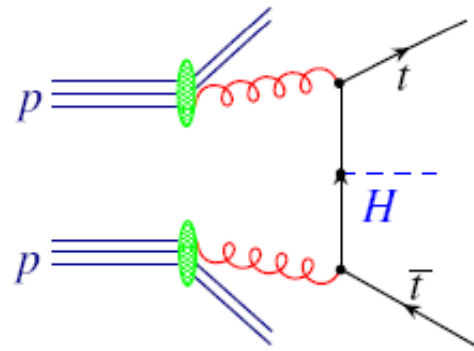

$t\bar{t}H$

- Higgs couplings
 \propto mass
u-ubar \rightarrow H
has very small
cross-section
- Dominant
production via
vertices coupling
Higgs to heavy
quarks or W/Z
bosons



Decay of the SM Higgs

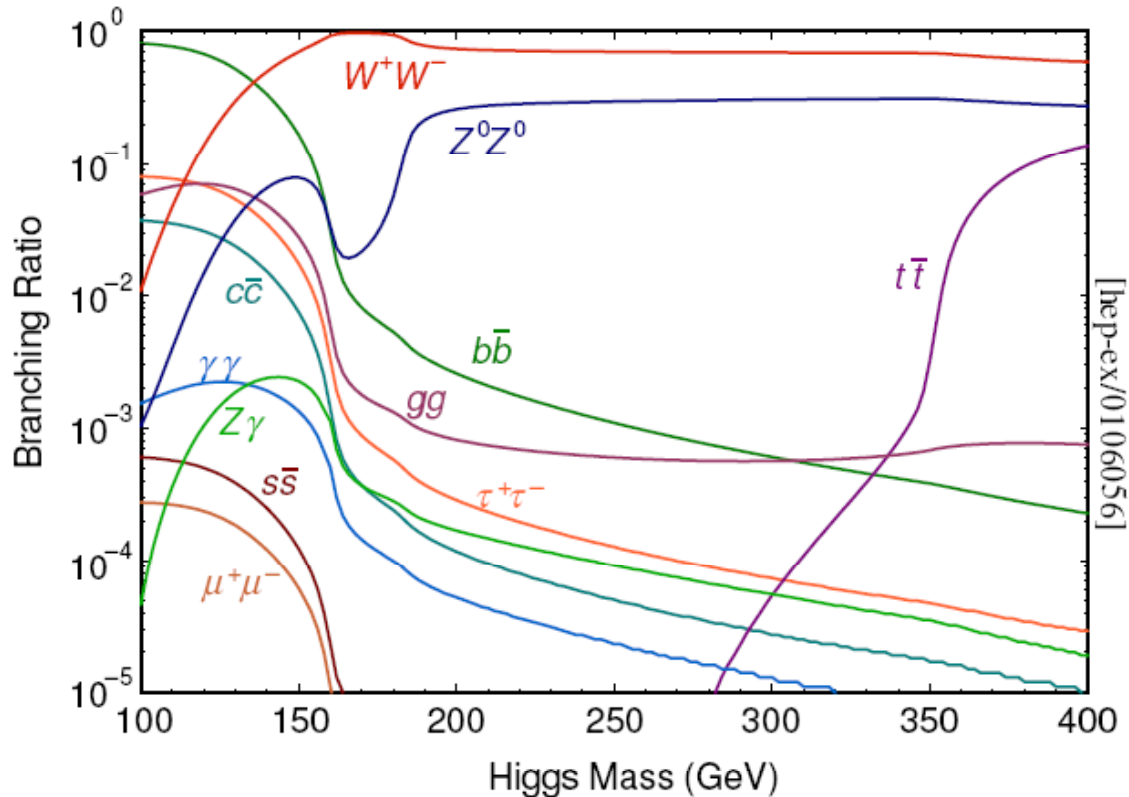

- Width becomes large as WW mode opens
- Branching ratios change rapidly as new channels become kinematically accessible

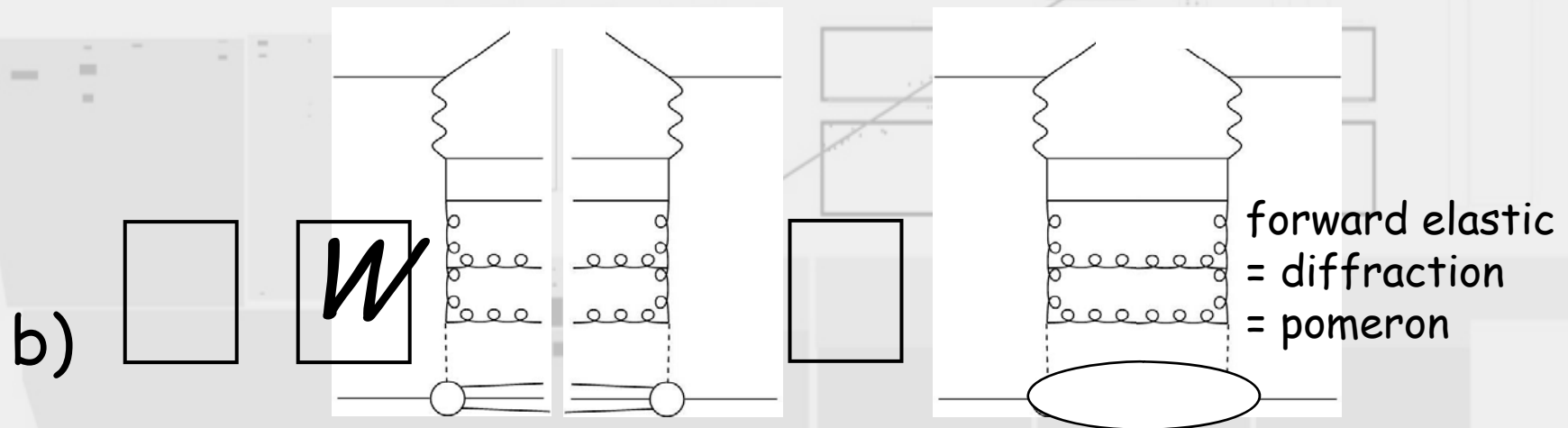
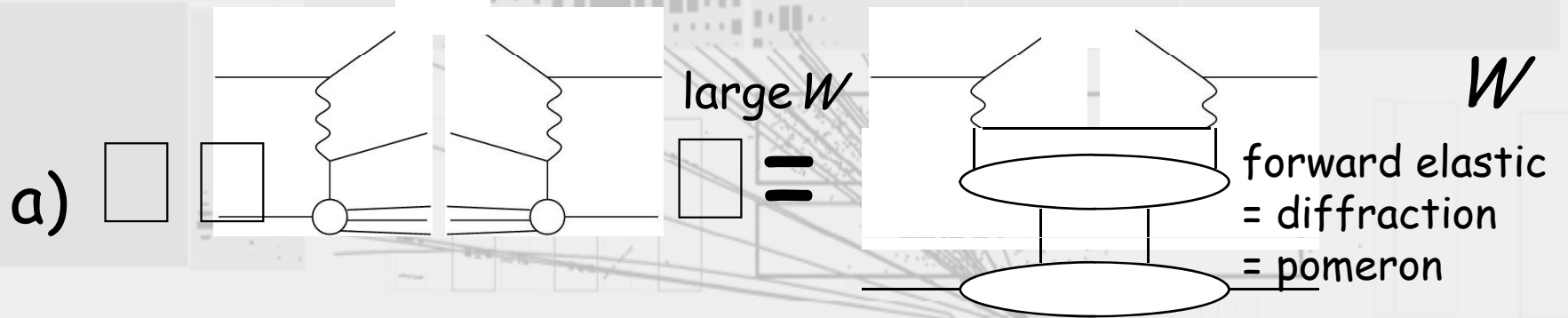

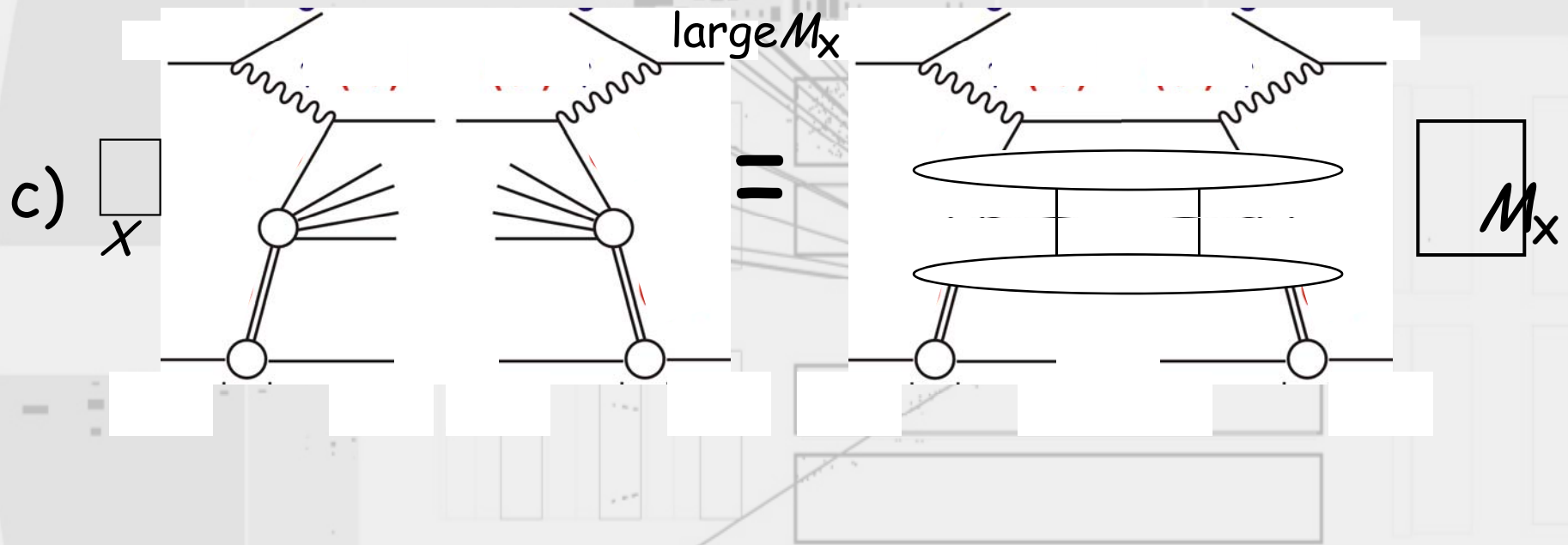

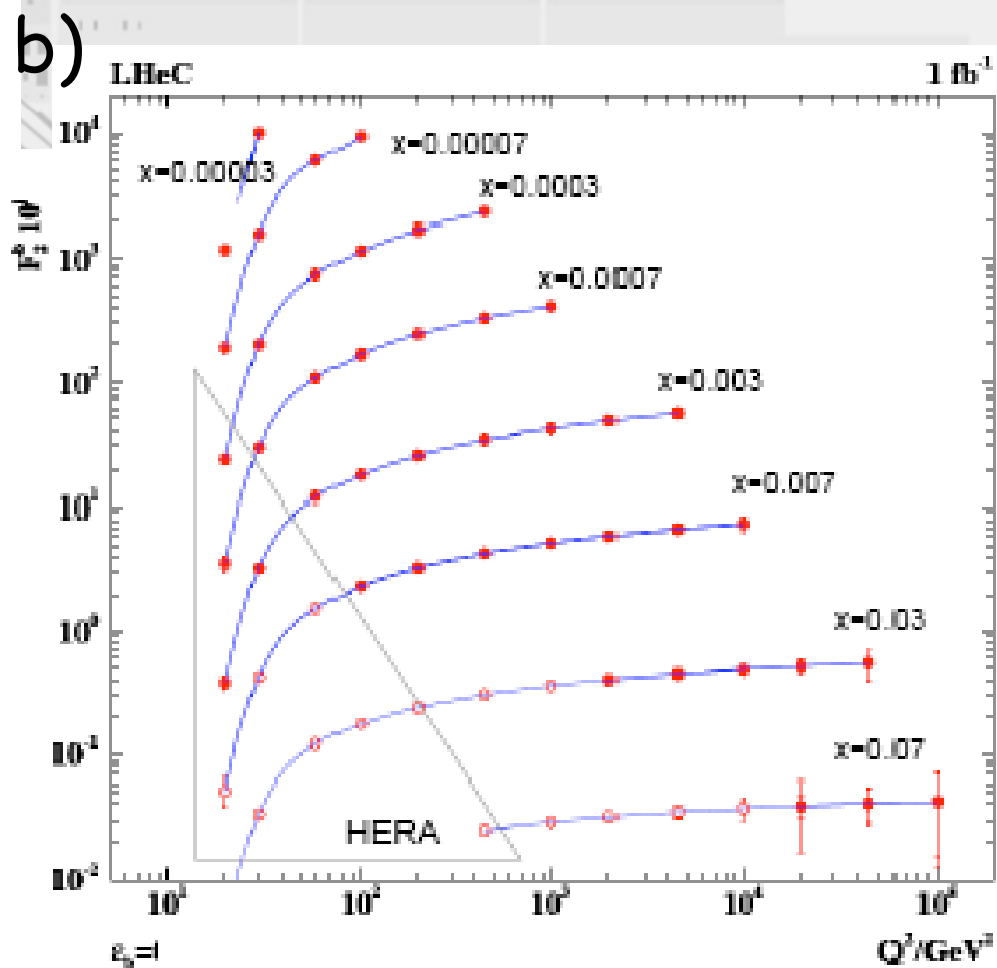
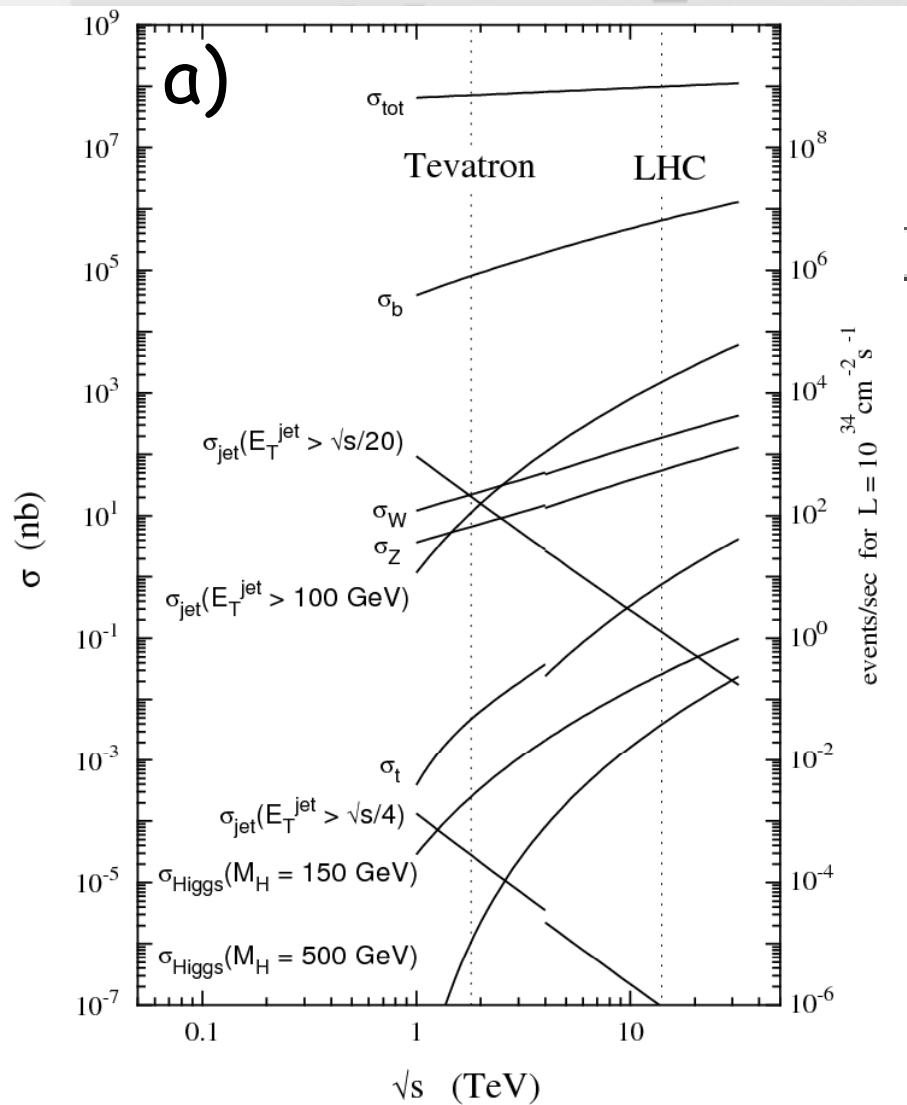

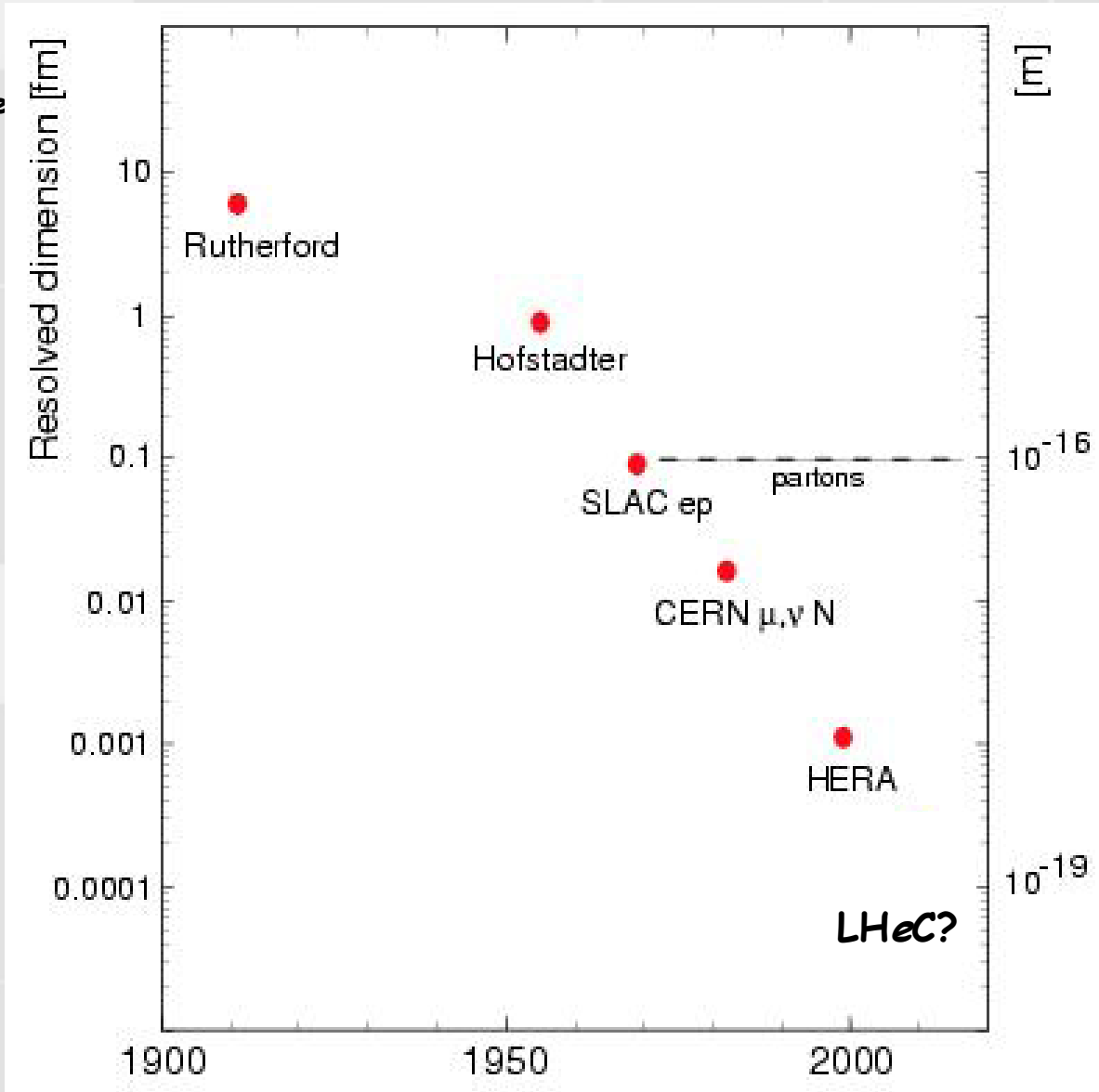

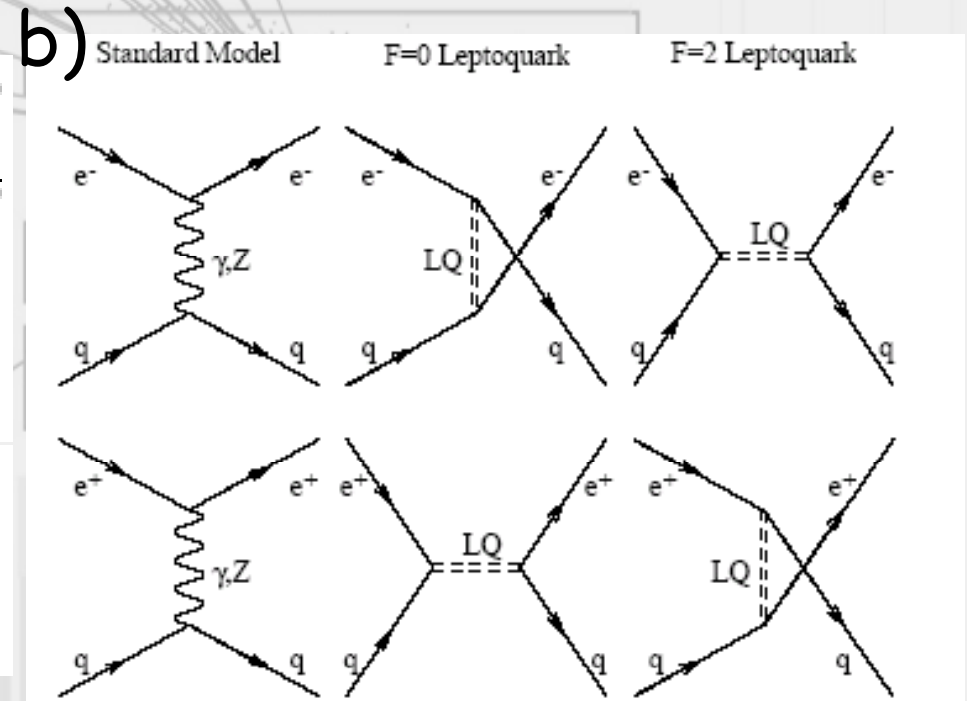
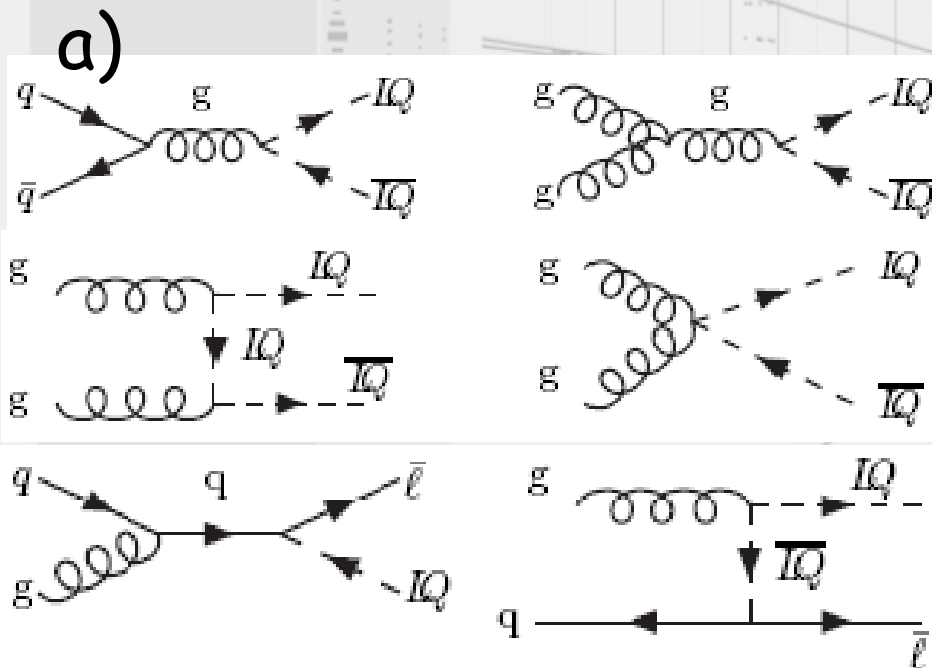

Polarised Positron
Workshop
Meeting
Cockcroft Institute
March 28th 2008

THE COCKCROFT INSTITUTE
of ACCELERATOR
SCIENCE and TECHNOLOGY



UNIVERSITY OF
LIVERPOOL

