

Background studies for the ILD vertex detector

Rita De Masi
IPHC-Strasbourg

Characteristics of the study

- [GuineaPig 0.7.4-](#)

e^+e^- pairs

bremsstrahlung phot

spent beam

- [Mokka-06-06](#)

detector model LDC

VXD_side_band_ele

rangeCut 1mm

LorentzTransformati

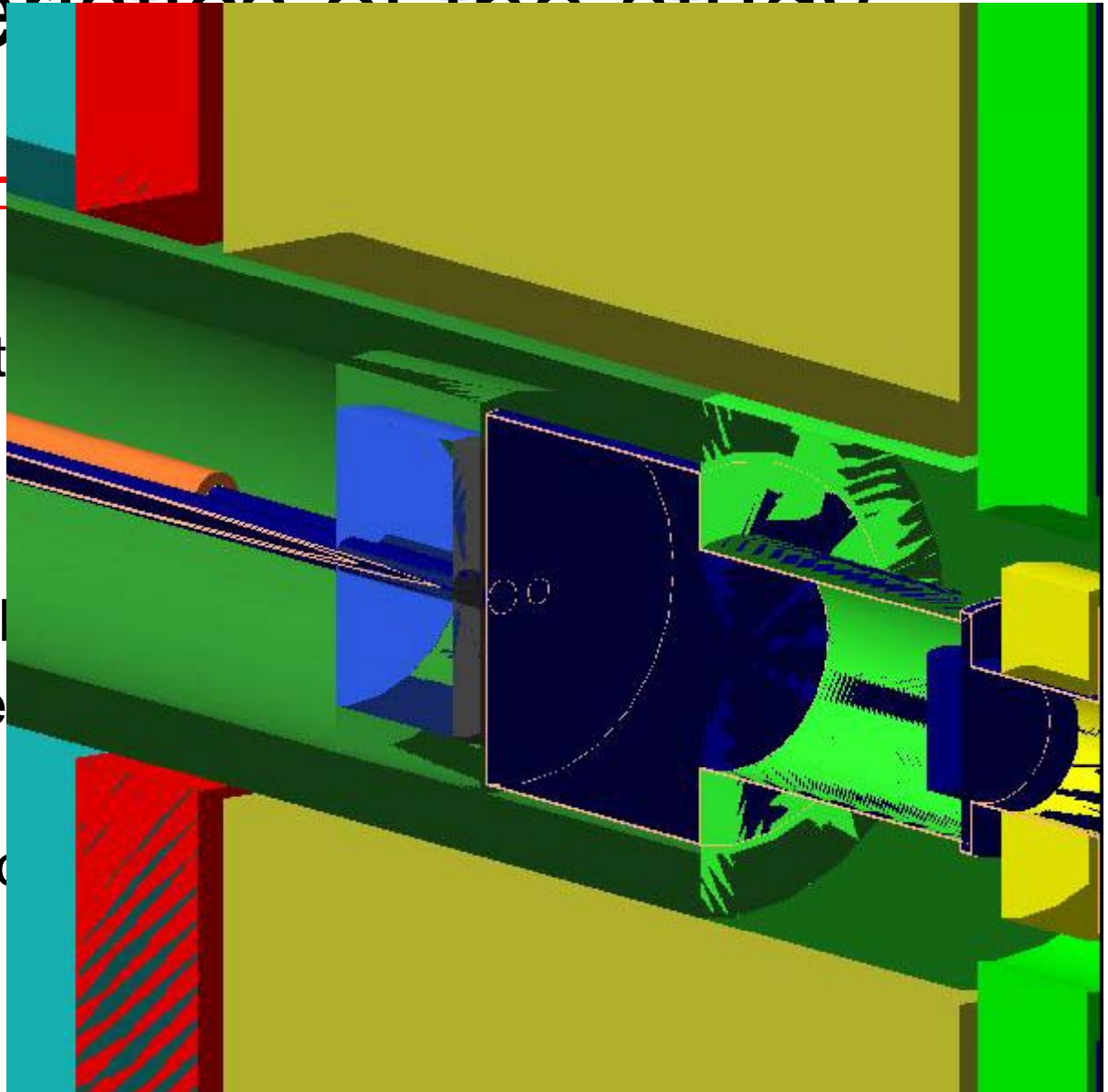

e^+e^- pairs background in $z \dots$

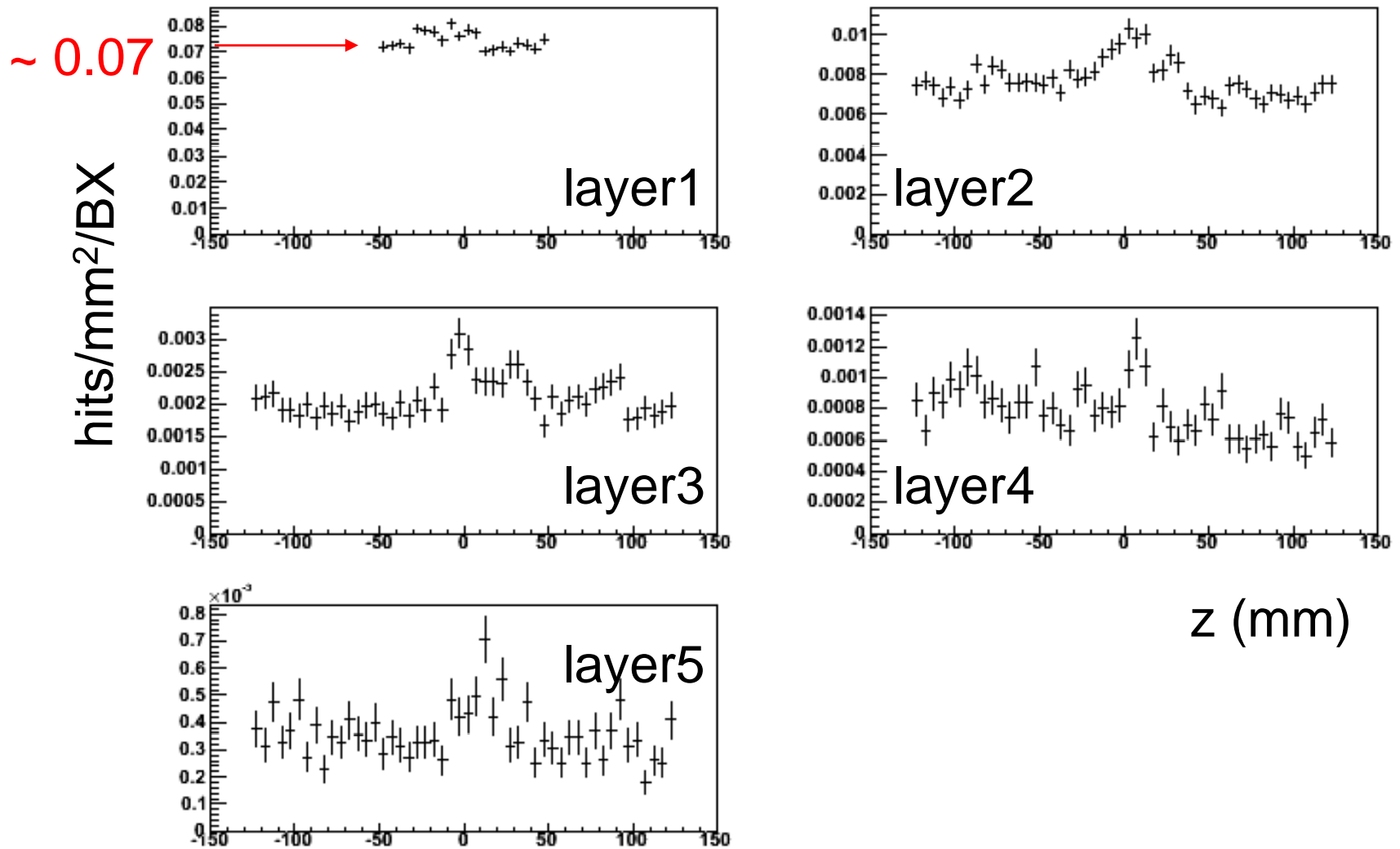

...and ϕ

~ 0.1
 ~ 0.05

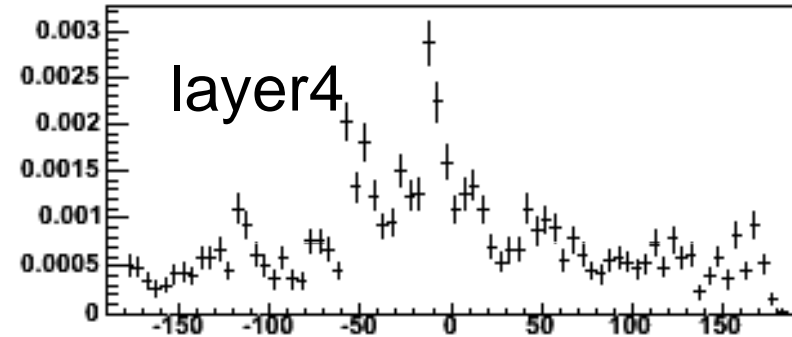
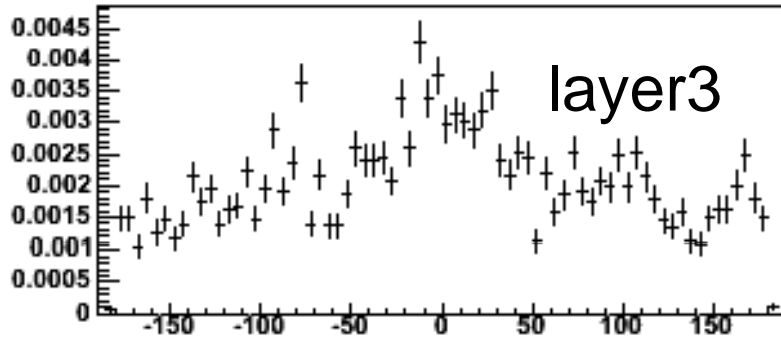
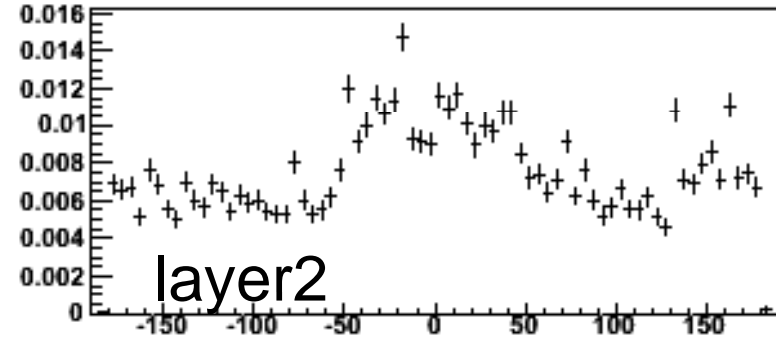
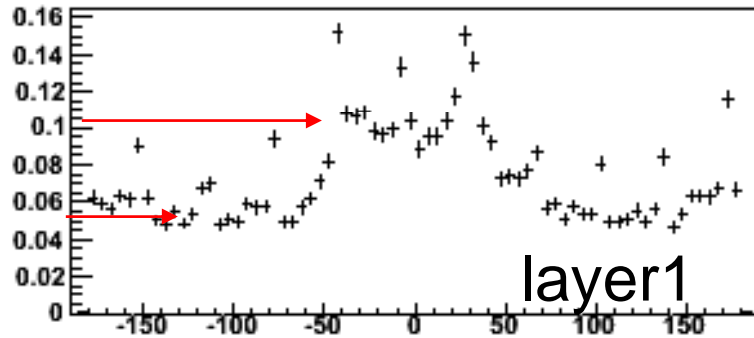

hits/mm²/BX

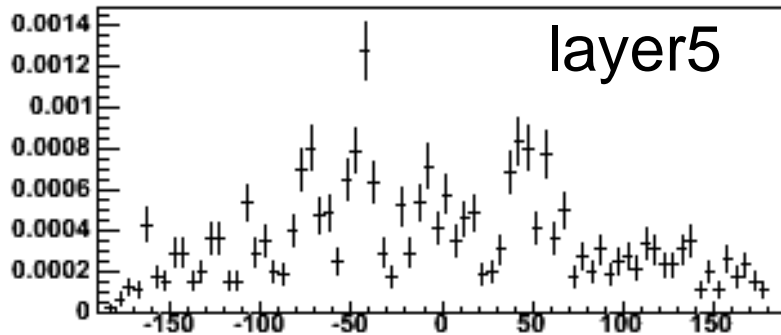

ϕ ($^{\circ}$)

vtx-z of particles hitting the VTX

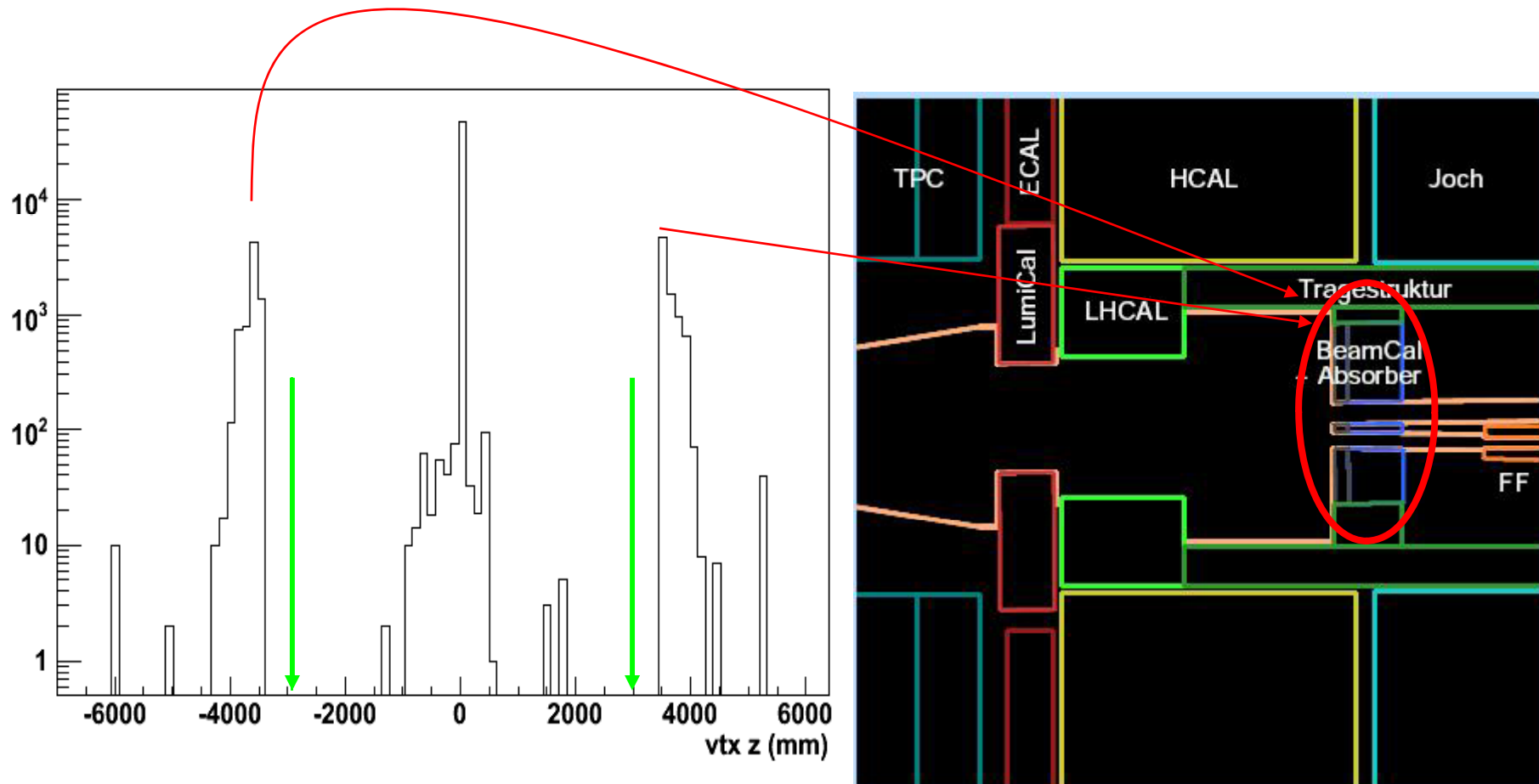

Cut on $|vtx\ z|$ distribution in z...

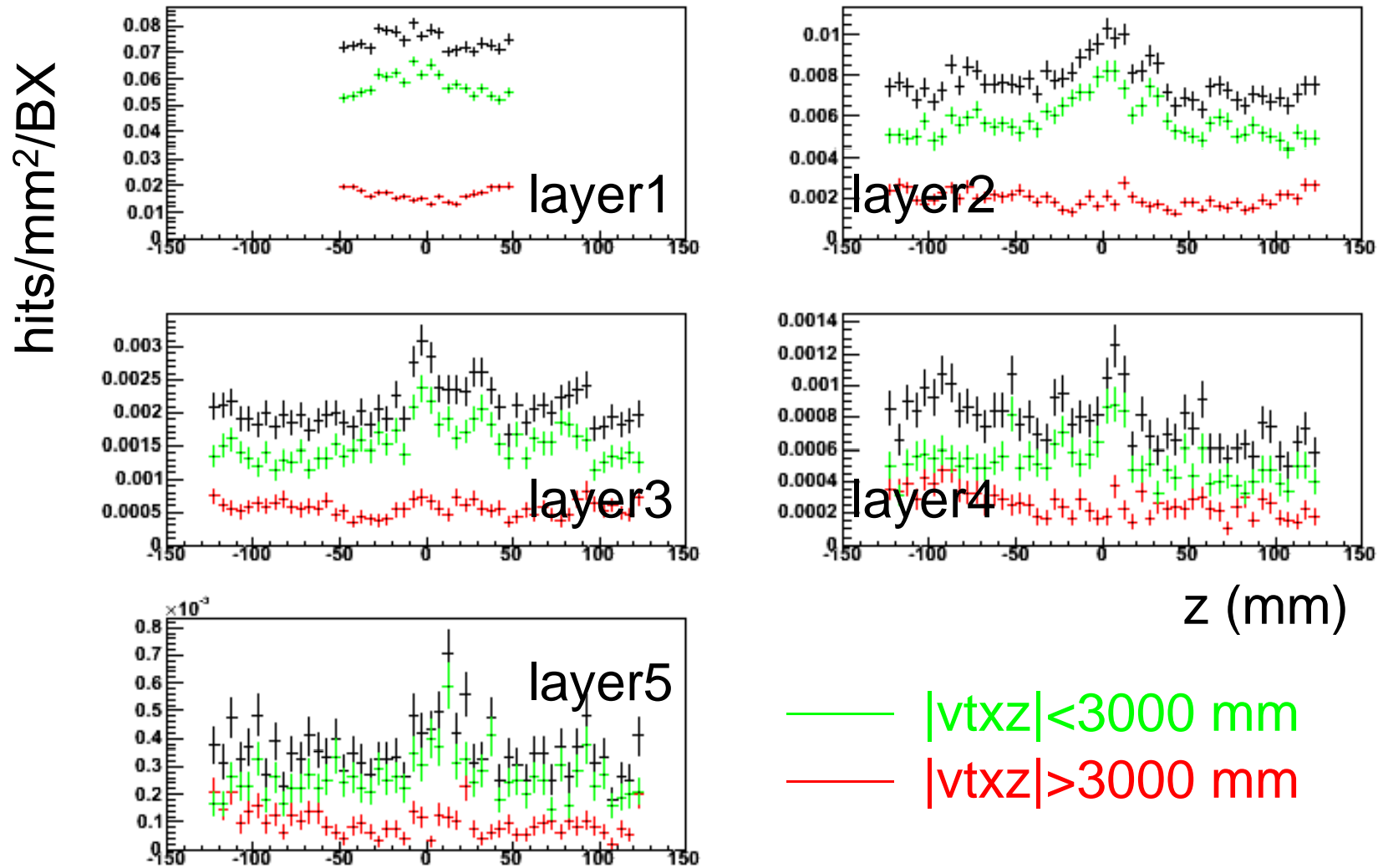

...and ϕ

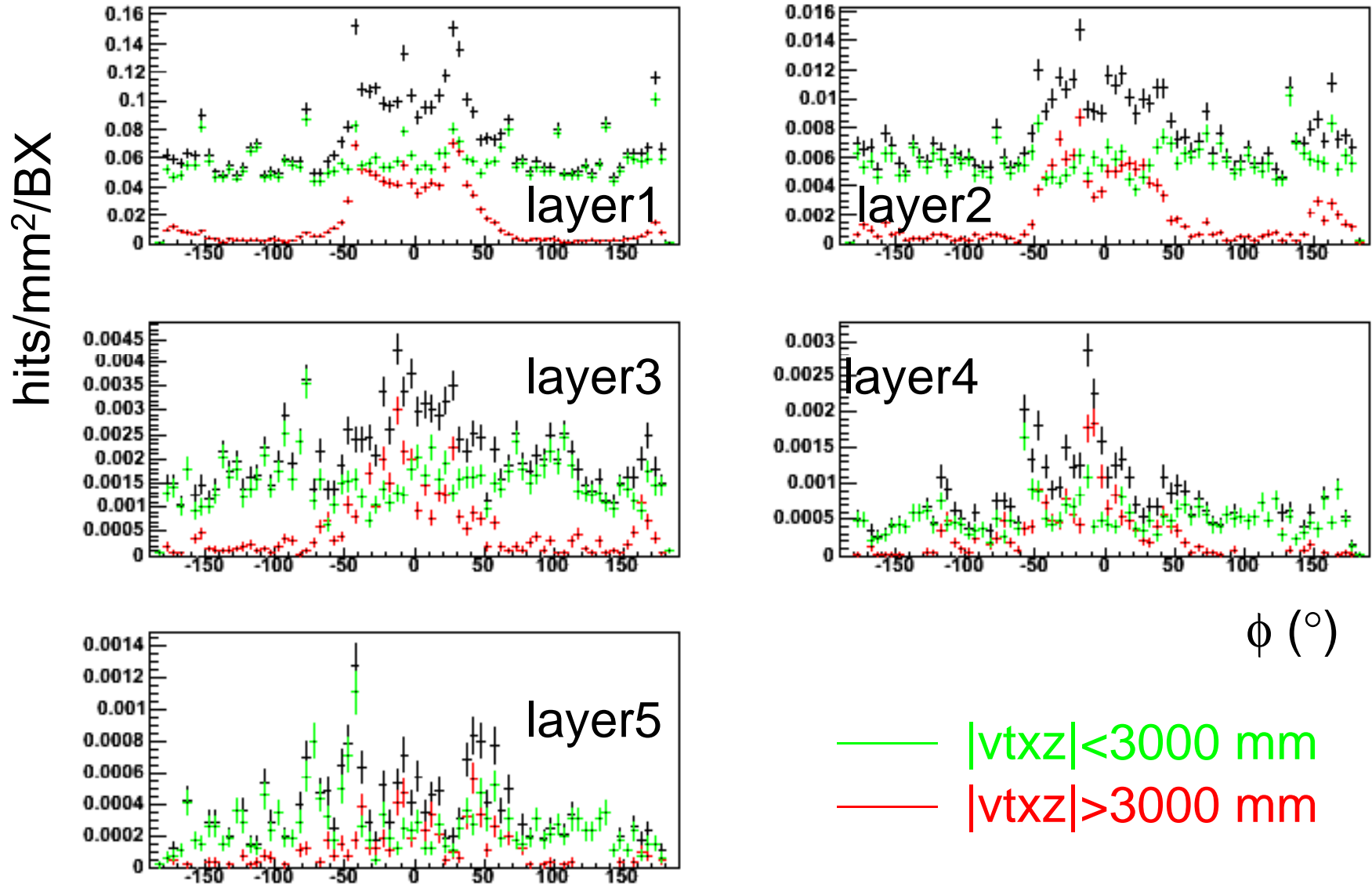

beamstrahlung photons (preliminary)

out of 50 BX
($\sim 2 \times 10^7$ generated particles)
no hits in the VTX
neither direct nor indirect

spent beam (very very preliminary)

~ 0.04 hits/mm²/BX on layer1
(~50% of pairs contribution)

BUT

study out of only 1/20th of BX
(due to extremely long simulation time)

Conclusion

- Pairs:
 - all elements along the beam line
- Beamstrahlung γ : further study
- Spent beam: “
- Bhabbha, ...