

# Electron Cloud Studies at DAFNE

Theo Demma  
INFN-LNF Frascati

# Plan of talk

- Introduction
- ELOUD Simulations for the DAFNE wiggler
  - Secondary Emission Yield
  - bunch patterns
  - magnetic field models
- Preliminary analysis of the instabilities
- ELOUD Simulations for build up in presence of solenoidal field
- Experimental plans
  - Energy-resolved  $e^-$  detectors
- Conclusions

# Electron cloud at DAFNE

A. Drago et. Al DAFNE Tech. Note: G-67 (2006)

- $e^+$  current limited to 1.2 A by strong instability ( $\sim 10 \mu\text{s}$ )
- large positive tune shift with current in  $e^+$  ring, not seen in  $e^-$  ring
- instability depends on bunch current (not total current)
- instability strongly increases along the train
- anomalous vacuum pressure rise has been observed in  $e^+$  ring
- instability sensitive to orbit in wiggler (few mm)
- main change for the 2003 was wiggler field modification

# Wiggler vacuum chamber

A. Chimenti et Al., Proc. Of PAC 93

Wiggler vacuum chamber cross section

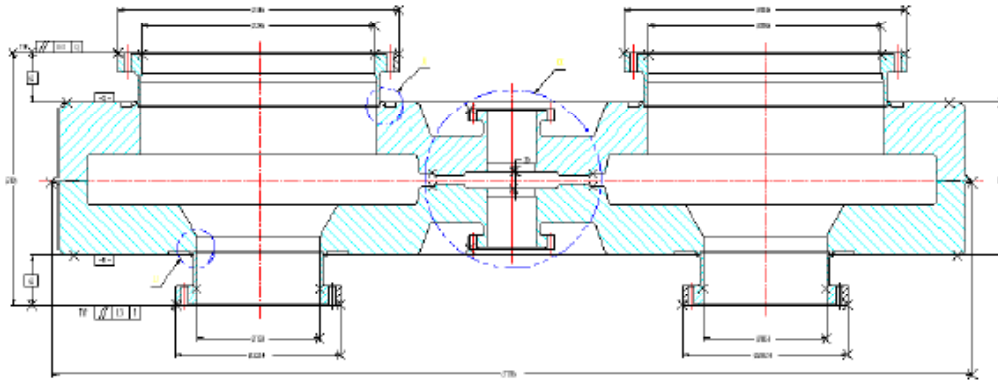

Wiggler beam chamber detail

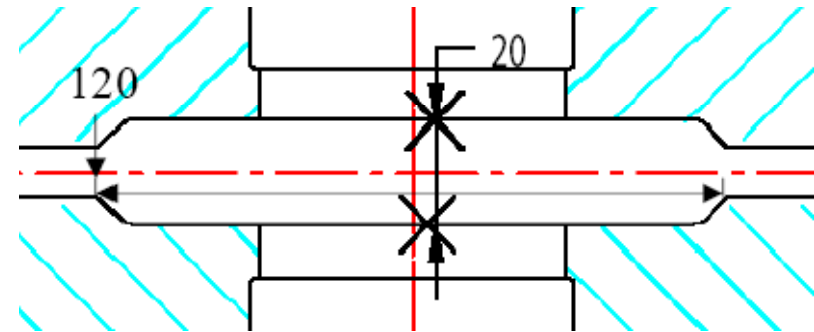

- Al alloy 5083-H321 chamber (120 mm x 20 mm )
- 10 mm slots divide the beam channel from the antechambers where absorbers and pumping stations are located
- 95% of photon flux is intercepted in the antechambers (cite.)

# Wiggler magnetic field model in ECLLOUD simulations

M. Preger, DAFNE Tech. Note L-34 (2003)

magnetic field ( $B_x, B_y, B_z$ ) inside the wiggler as a function of  $x, y, z$  coordinates is obtained from a bi-cubic fit of the measured 2-D field-map data  $B_y(x, y=0, z)$ ; field components  $B_x$  and  $B_z$  are approximated by

$$B_x = \frac{\partial B_y(x, y=0, z)}{\partial x} y$$

$$B_z = \frac{\partial B_y(x, y=0, z)}{\partial z} y$$

$$B_y(x, y, z) = B_y(x, y=0, z) - \frac{y^2}{2} \left( \frac{\partial^2 B_y(x, y=0, z)}{\partial x^2} + \frac{\partial^2 B_y(x, y=0, z)}{\partial z^2} \right)$$

consistent with Maxwell's equations:  $\vec{\nabla} \times \vec{B} = 0, \quad \vec{\nabla} \cdot \vec{B} = 0$

# Wiggler magnetic field

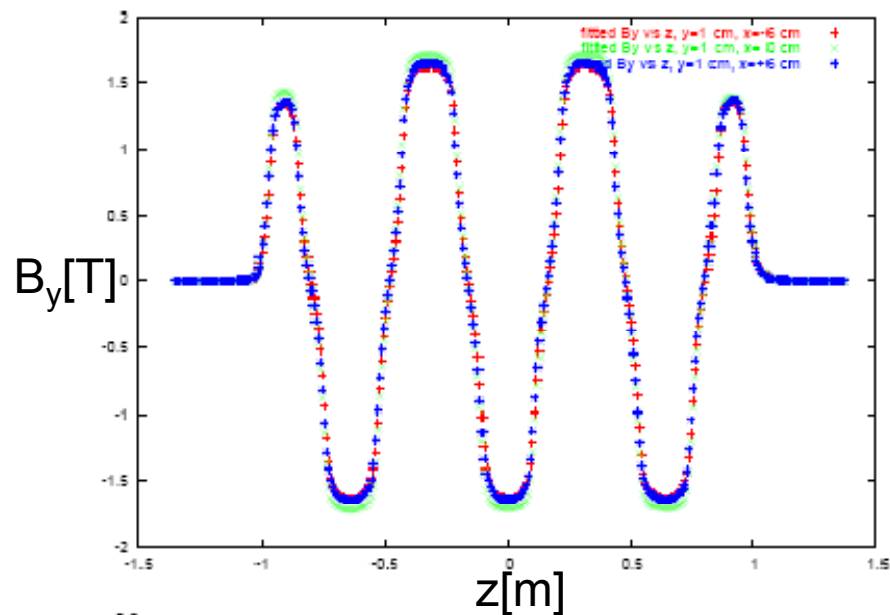

peak field  $\sim 1.7$  T

period  $\sim 0.65$  m

$x = -6$  cm,  $x = 0$  cm,  $x = +6$  cm

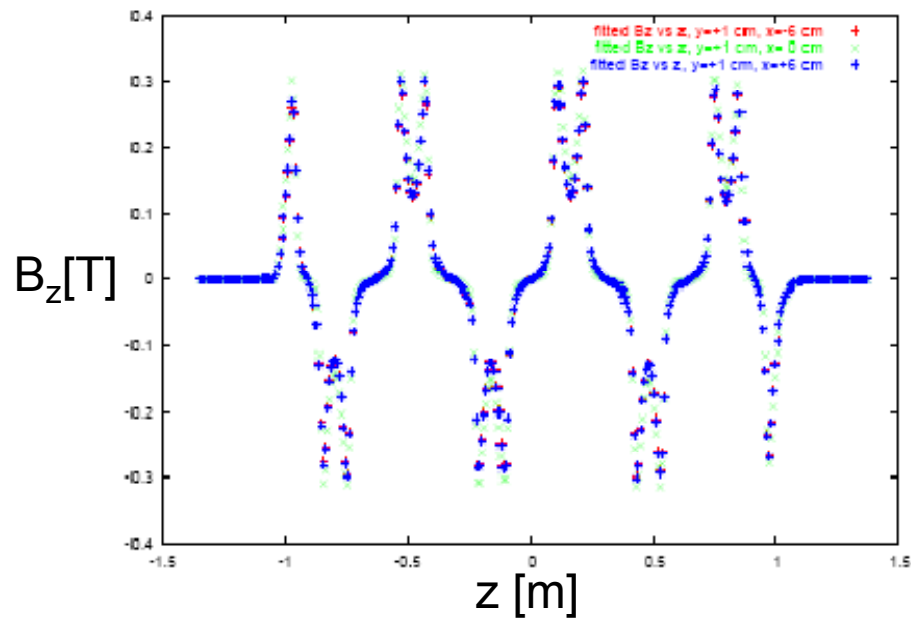
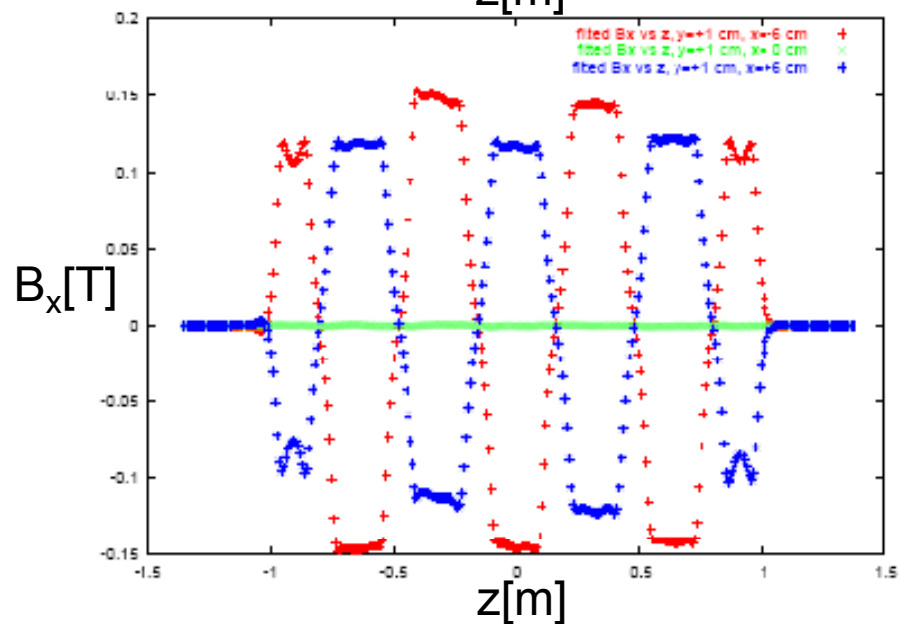

# Input parameters for ELOUD (DAFNE Wiggler 2003)

Bunch population	$N_b$	$2.1 \times 10^{10}$
Number of bunches	$n_b$	100;50;33;25
Missing bunches	$N_{\text{gap}}$	20
Bunch spacing	$L_{\text{sep}}[\text{m}]$	0.8;1.6;2.4;3.2
Bunch length	$\sigma_z [\text{mm}]$	18
Bunch horizontal size	$\sigma_x [\text{mm}]$	1.4
Bunch vertical size	$\sigma_y [\text{mm}]$	0.05
Chamber hor. aperture	$2 h_x [\text{mm}]$	120
Chamber vert. aperture	$2 h_y [\text{mm}]$	10
Al Photoelectron Yield*	$Y_{\text{eff}}$	0.2
Primary electron rate	$d\lambda/ds$	0.0088
Photon Reflectivity*	R	50%
Max. Secondary Emission Yield	$\delta_{\text{max}}$	1.9 (0.2) 1.1
Energy at Max. SEY	$E_m [\text{eV}]$	250
SEY model	Cimino-Collins (50%;100% refl.)	

\* As measured on Al samples with same finishing of the actual vacuum chamber  
 N.Mahne et Al. , PAC'05

# Bunch patterns

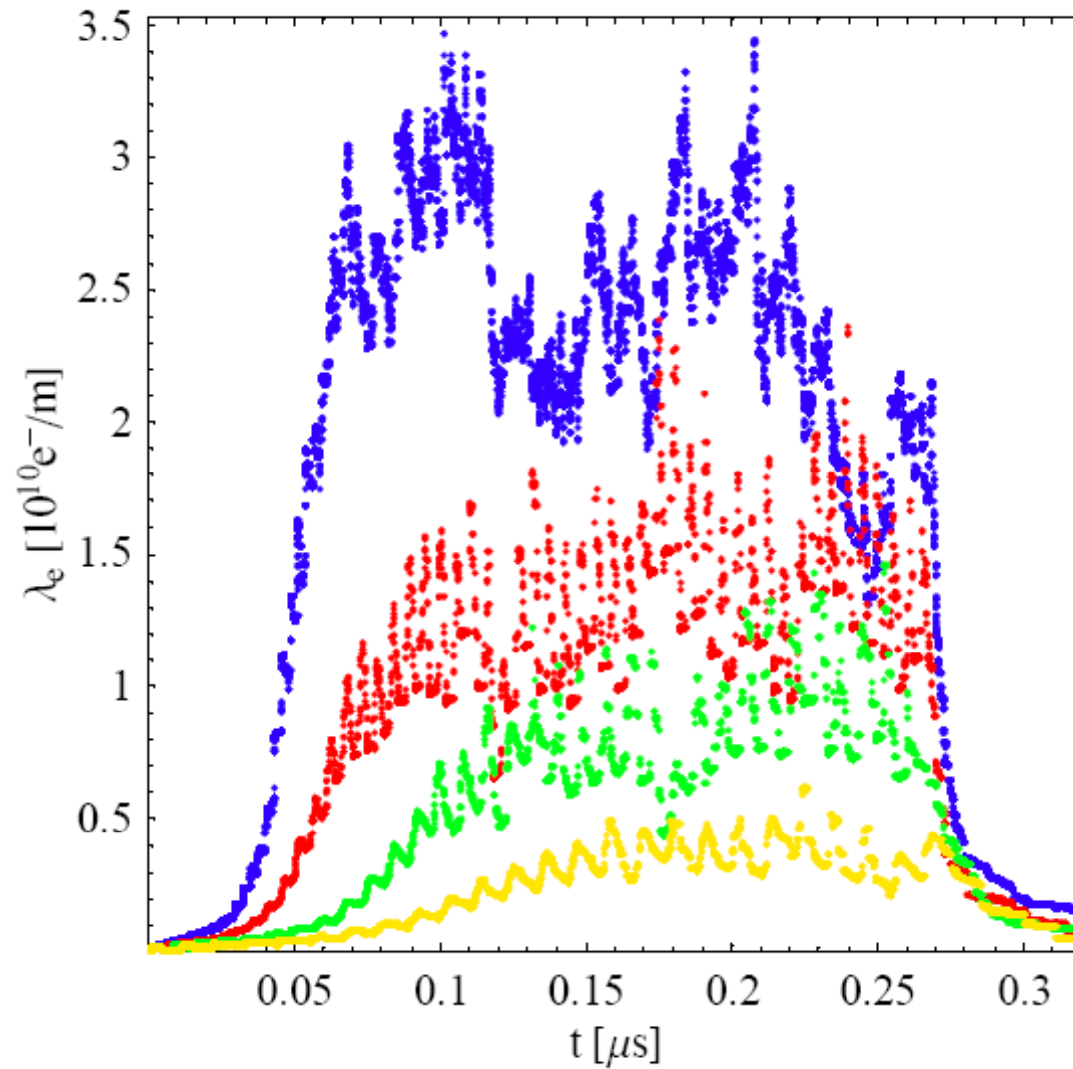

$$N_b = 2.1 \cdot 10^{10}$$

100 bunches

$$L_{sep} = 0.8 \text{ m}$$

50 bunches

$$L_{sep} = 1.6 \text{ m}$$

33 bunches

$$L_{sep} = 2.4 \text{ m}$$

25 bunches

$$L_{sep} = 3.2 \text{ m}$$



## Secondary emission yield maximum ( $\delta_{\max}$ )

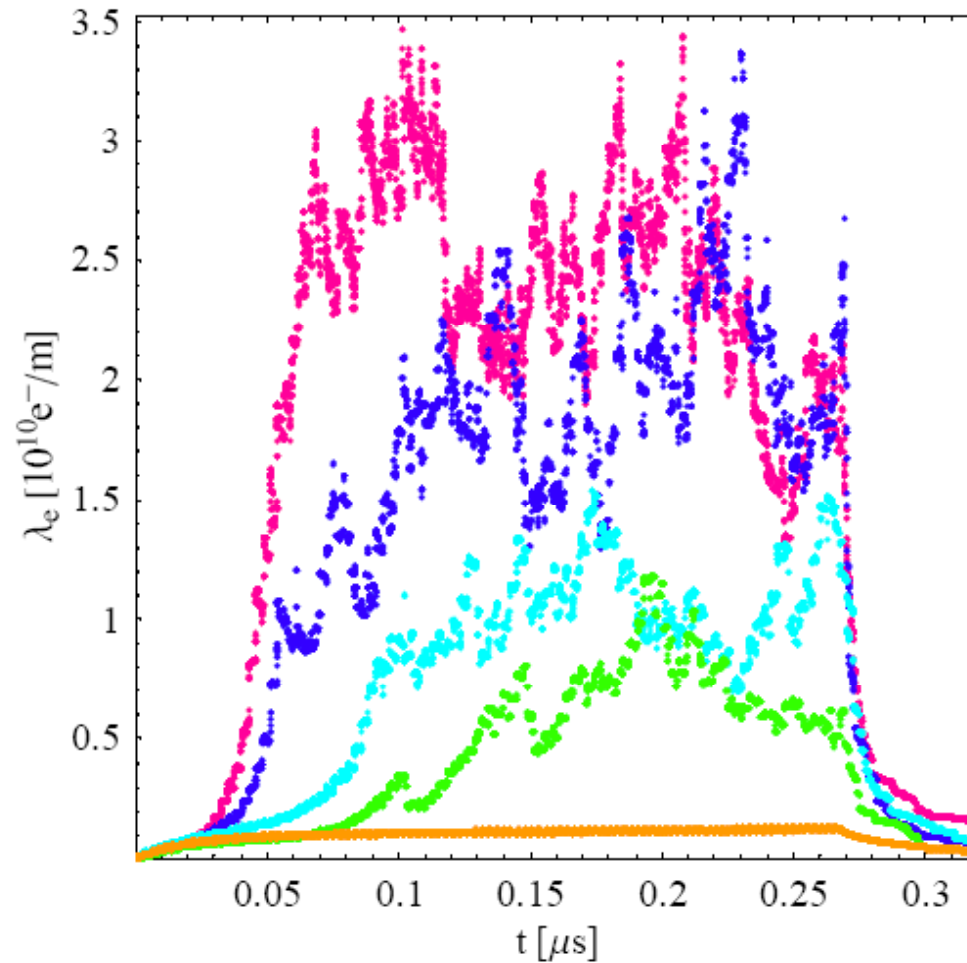

$$\delta_{\max} = 1.9$$

$$\delta_{\max} = 1.7$$

$$\delta_{\max} = 1.5$$

$$\delta_{\max} = 1.3$$

$$\delta_{\max} = 1.1$$

100 bunches ( $N_b = 2.1 \times 10^{10}$ ;  $L_{\text{sep}} = 0.8 \text{ m}$ ;  $N_{\text{gap}} = 20$ )

# Electron reflectivity at 0 energy $\delta_0 = 100\%$

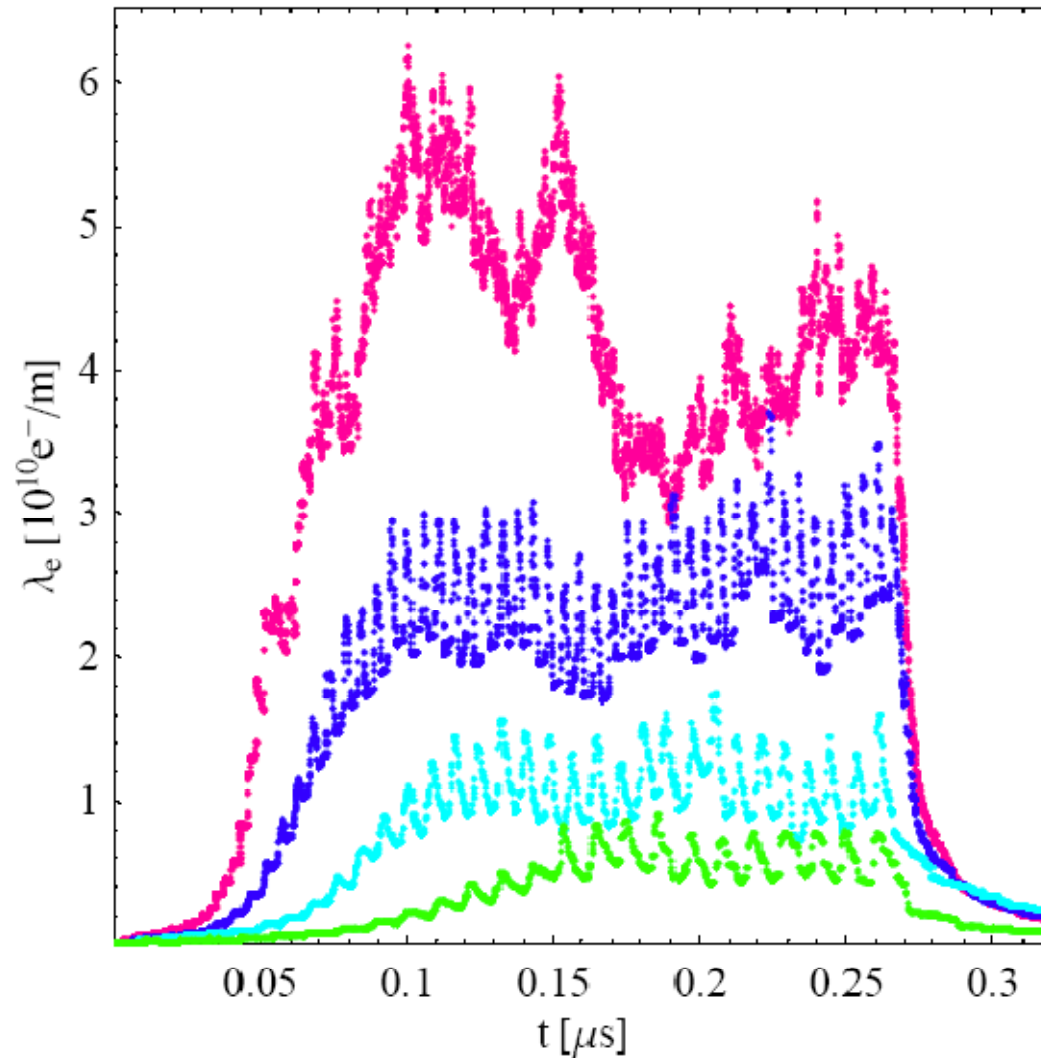

$N_b = 2.1 \cdot 10^{10}$

100 bunches

$L_{\text{sep}} = 0.8 \text{ m}$

50 bunches

$L_{\text{sep}} = 1.6 \text{ m}$

33 bunches

$L_{\text{sep}} = 2.4 \text{ m}$

25 bunches

$L_{\text{sep}} = 3.2 \text{ m}$

# Magnetic field models

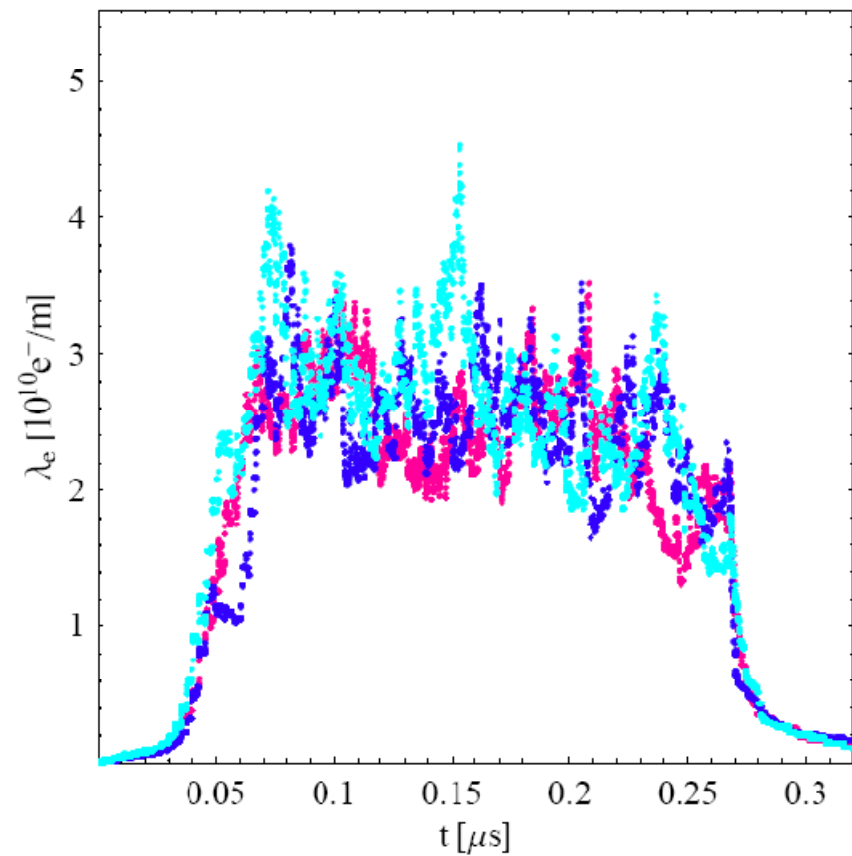
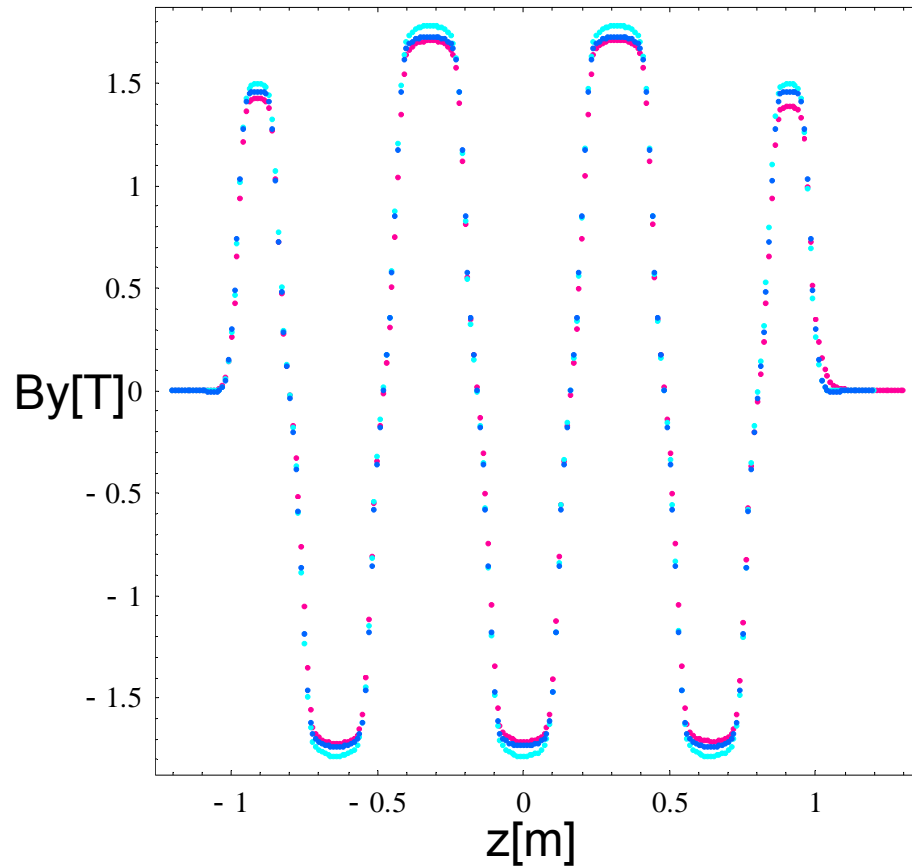

100 bunches,  $L_{sep} = 0.8$  m,  $N_b = 2.1 \cdot 10^{10}$

2003 wiggler 2002 wiggler 2007 wiggler (proposed)

# Instability growth rates

Switching off the horizontal feedback for short periods, transverse grow-damp measurements have been performed to estimate the instability growth rates at different beam currents.

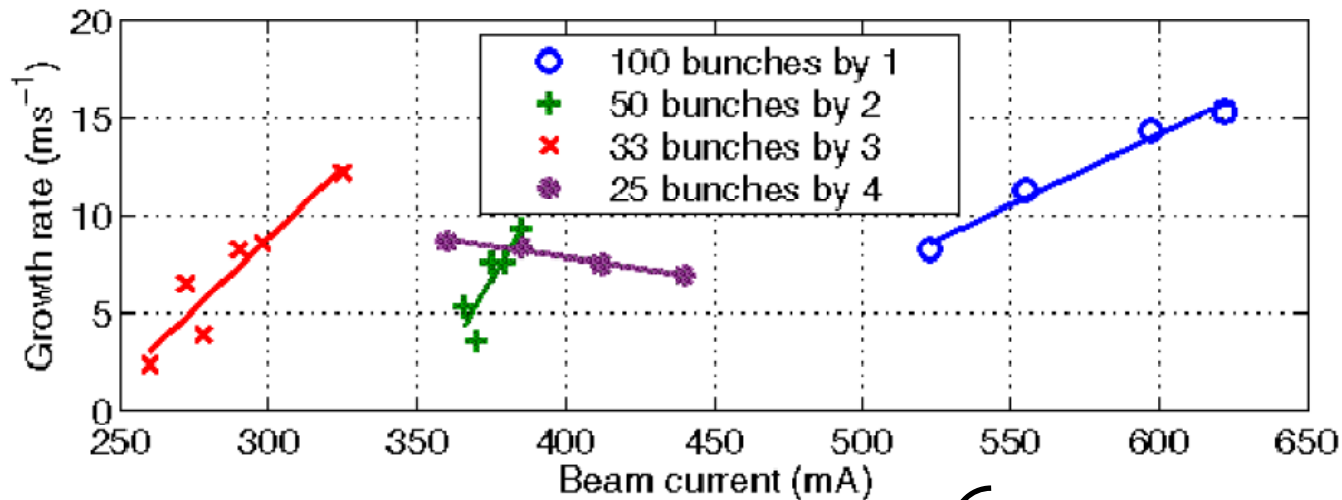

Horizontal growth rates recorded in July 2004.  
(A.Drago et Al. Proceedings of PAC 2005)

$1/\diamond \sim 8 \text{ ms}^{-1}$   $\longrightarrow$

- $N_b = 1.06 \cdot 10^{10}$  (100 bunches)
- $N_b = 1.5 \cdot 10^{10}$  (50 bunches)
- $N_b = 1.9 \cdot 10^{10}$  (33 bunches)
- $N_b = 3.13 \cdot 10^{10}$  (25 bunches)

# Bunch patterns (fixed growth rate)

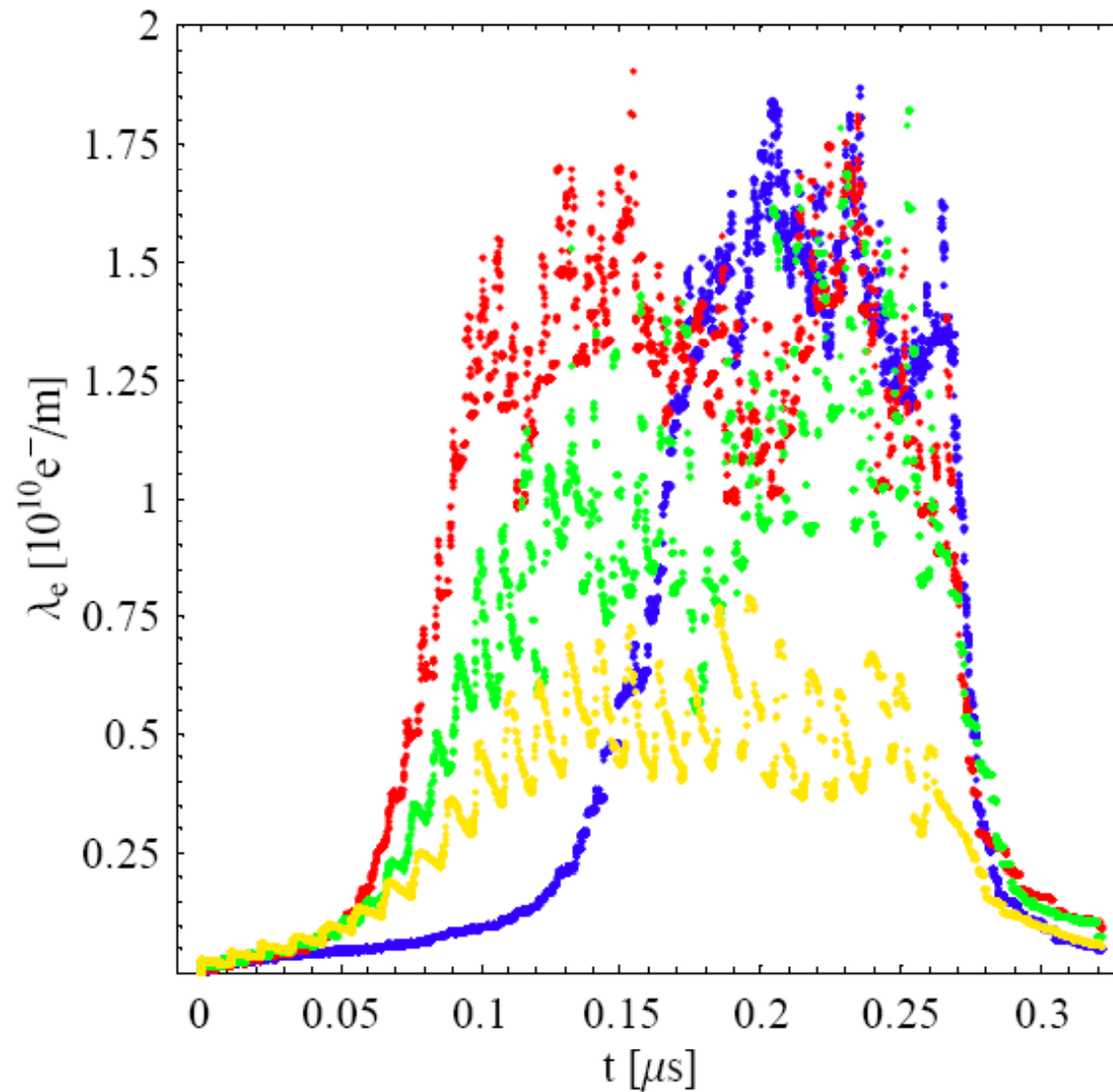

100 bunches  
 $N_b=1.06 \cdot 10^{10}$   
 $L_{sep}= 0.8 \text{ m}$

50 bunches  
 $N_b=1.5 \cdot 10^{10}$   
 $L_{sep}= 1.6 \text{ m}$

33 bunches  
 $N_b=1.9 \cdot 10^{10}$   
 $L_{sep}= 2.4 \text{ m}$

25 bunches  
 $N_b=3.13 \cdot 10^{10}$   
 $L_{sep}= 3.2 \text{ m}$

# Work in progress

- At the startup after the recent shutdown for the setup of the crab waist collision scheme the instability threshold dropped to 270mA for the positron current (feedback switched off).
- Main change was the installation of new interaction regions (20 m straight sections of aluminum SEY>2)
- In the attempt to find a remedy solenoids were installed in the field free regions of DAFNE, leading to an increase of the threshold to 400mA (feedback switched off).

# Solenoids

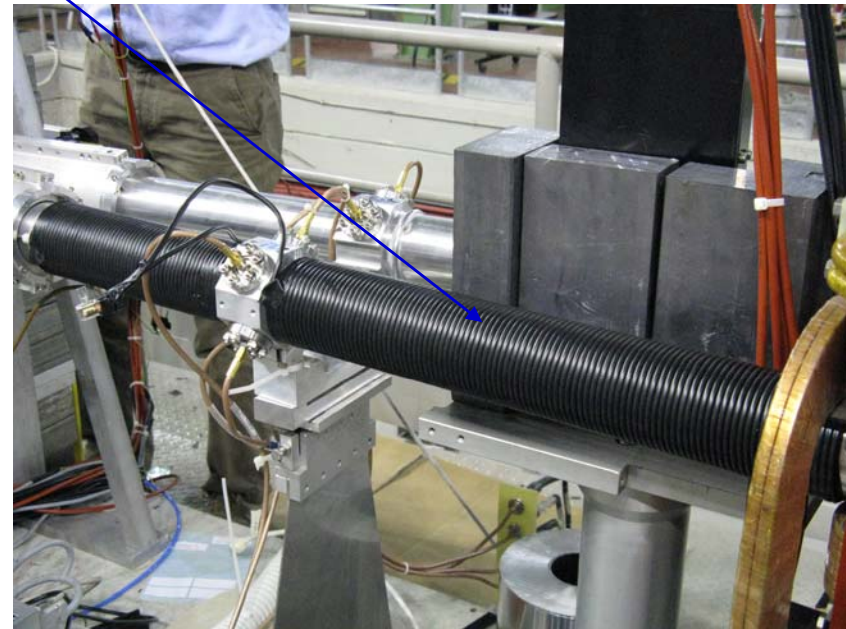
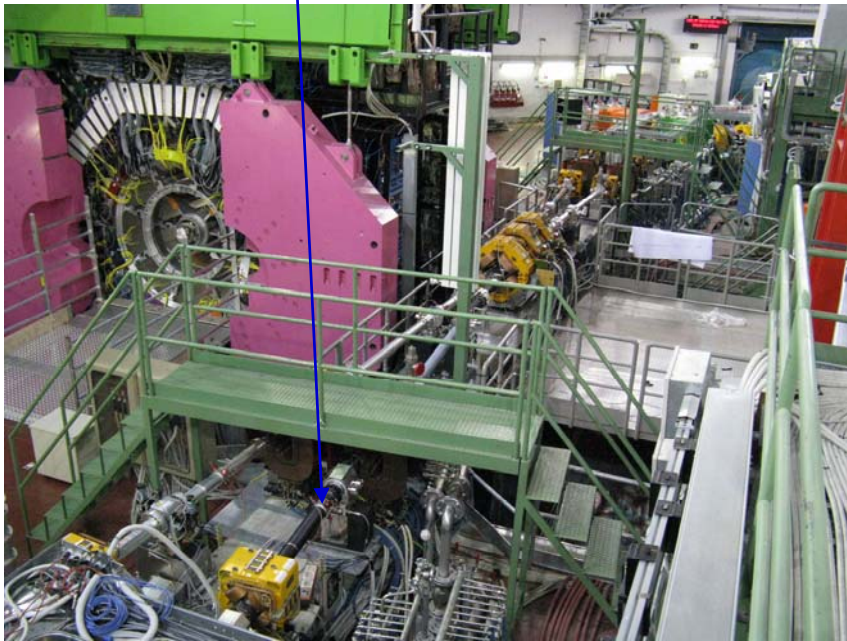
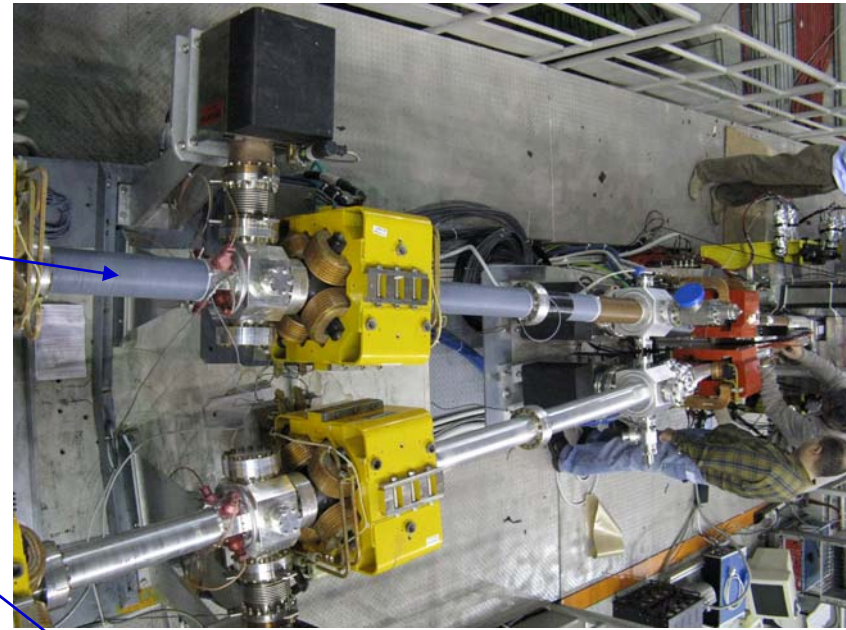

# Multipacting Suppression

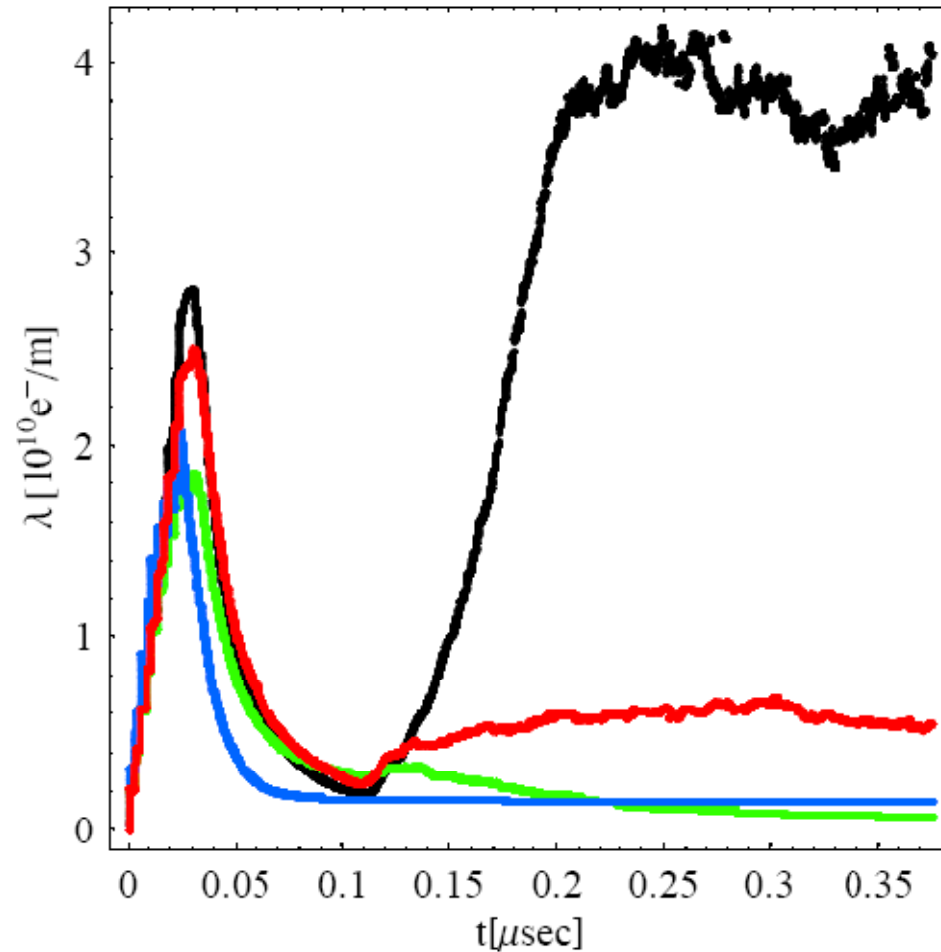

$$N_b = 2.1 \times 10^{10}$$

$$L_{\text{sep}} = 0.8 \text{ m}$$

$$R = 30 \text{ mm}$$

$$\delta_{\text{max}} = 2.4$$

(10f-30e-100f)

$B_z = 0$  G

$B_z = 10$  G

$B_z = 20$  G

$B_z = 40$  G

Photoelectrons are produced only during the passage of the first 10 bunches.



# x-y Phase-Space Snapshot

$B_z=0$  G

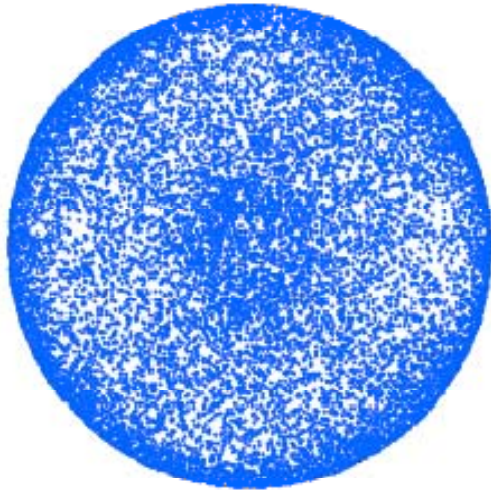

$B_z=10$  G



$B_z=20$  G

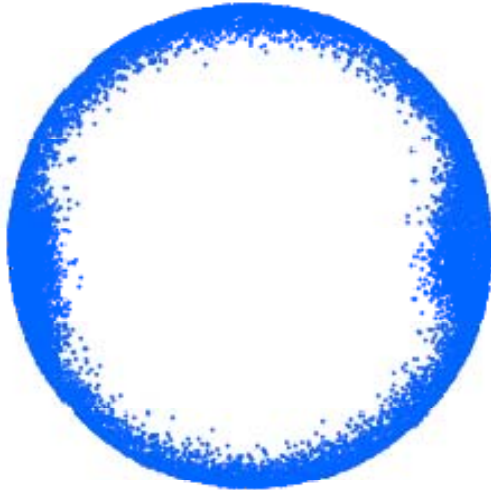

$B_z=40$  G

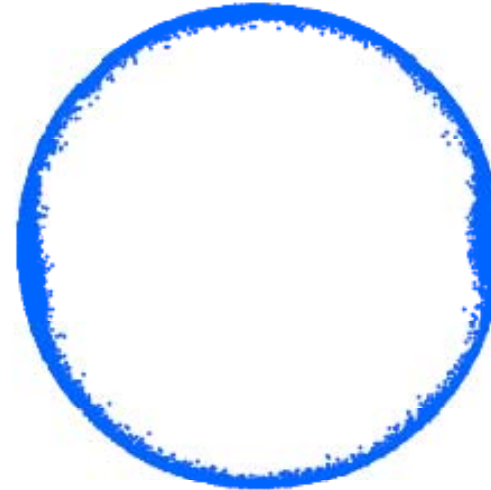

# Effects of Solenoids on Vacuum Pressure Rise

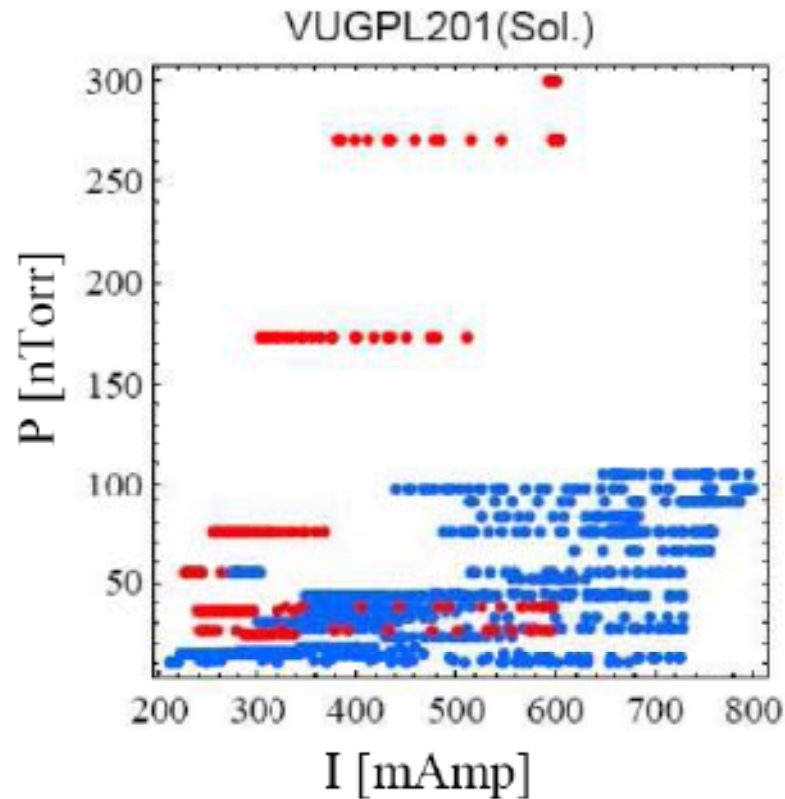

(100f,20e)

Lsep=0.8 m

Bz= 40 G

Sol. Off/Sol. On

Vacuum pressure read-out vs. total current as recorded in a straight section of the positron ring where a 40 G solenoidal field was turned on (blue dots) and off (red dots).

# Experimental plans at DAFNE

For ILC-DR one needs to study the vacuum high tech. materials properties, including:

- 0-1Kev Electron induced el. Emission yield (SEY)
- photoemission yield and photoemission induced electron energy distribution
- surface properties changes during conditioning
- ...

Use the results as input for the simulation codes and compare the results with measurements on a real machine.

## Energy-resolved $e^-$ detectors at DAFNE (R. Cimino)

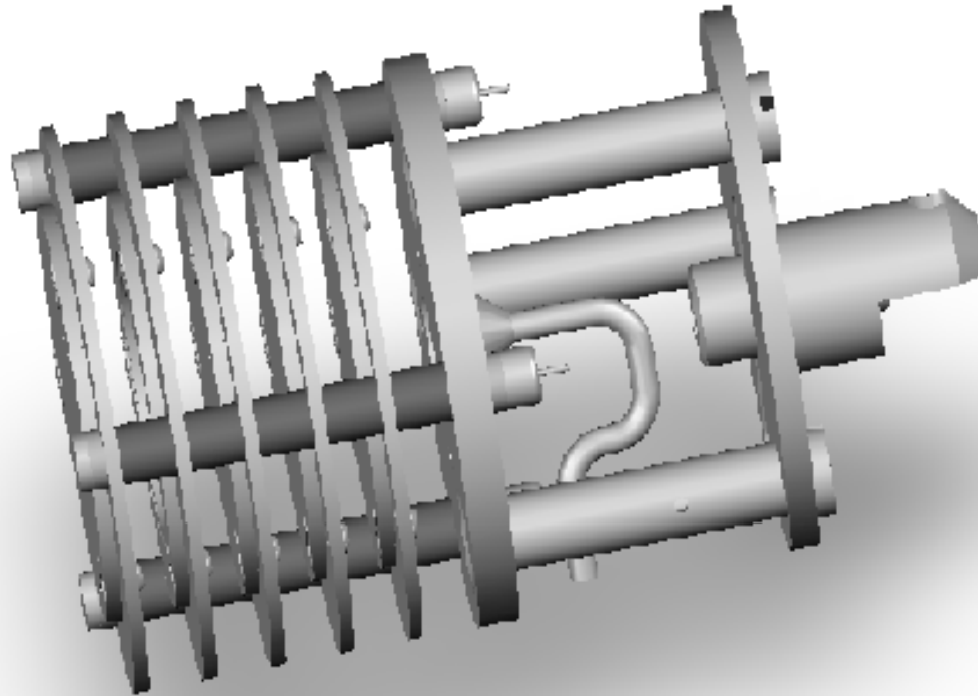

To be inserted in 3 positions looking through the existing slots at the beam:

- electron-ring (for reference)
- positron ring (uncoated chamber)
- positron ring (TiN coated chamber?)

# Summary

- ELOUD build-up simulations for the DAFNE Wiggler show:
  - expected dependence of e-cloud build-up on SEY parameters  $\delta_{\max}$  and  $\delta_0$
  - no dependence of e-cloud build-up on magnetic field model (check with other codes is needed)
  - bunch patterns behavior compatible with experimental observation.
- Solenoids were installed at DAFNE, preliminary observation seems to confirm their effectiveness in reducing e-cloud build-up.
- Energy-resolved e<sup>-</sup> detectors are under test and are planned for installation at DAFNE.
- Multi-bunch and single-bunch instability simulations are being prepared to directly compare results with measurements planned for the next future.

# E-Cloud Task

August 2008

- (1) **new achievements**
- (2) **deliverable no. 1**: documented and experimentally benchmarked code(s) for e-cloud simulations
- (3) **deliverable no. 2**: report on impact of e-cloud and fast ion instabilities on DR performance, including recommendations for controlling the effects

# new achievements

- **scaling of e-cloud instability with beam energy**
  - experimental results from SPS, benchmarked by simulations
  - G. Rumolo et al, Phys.Rev.Lett.100:144801,2008
- **microwave transmission for e-cloud diagnostics (F. Caspers)**
  - method pioneered at SPS now applied at PEP-II and CESR-TA
- **improved models for pinch & incoherent e-cloud effects**
  - PAC'07; G. Franchetti & F. Zimmermann, 2 papers at EPAC'08
- **studies of e-cloud and ion effects for the CLIC DR**
  - G. Rumolo et al, "Electron Cloud Build Up and Instability in the CLIC Damping Rings" and "Collective Effects in the CLIC Damping Rings," EPAC'08 Genoa
- **development & tests of novel countermeasures (ECL2)**
  - enamel-based clearing electrodes, grooved surfaces
  - TiZrV NEG, TiN, black gold & carbon coatings (P. Chiggiato et al)
  - beam measurements in PS and SPS testbeds

# example highlight: microwave transmission

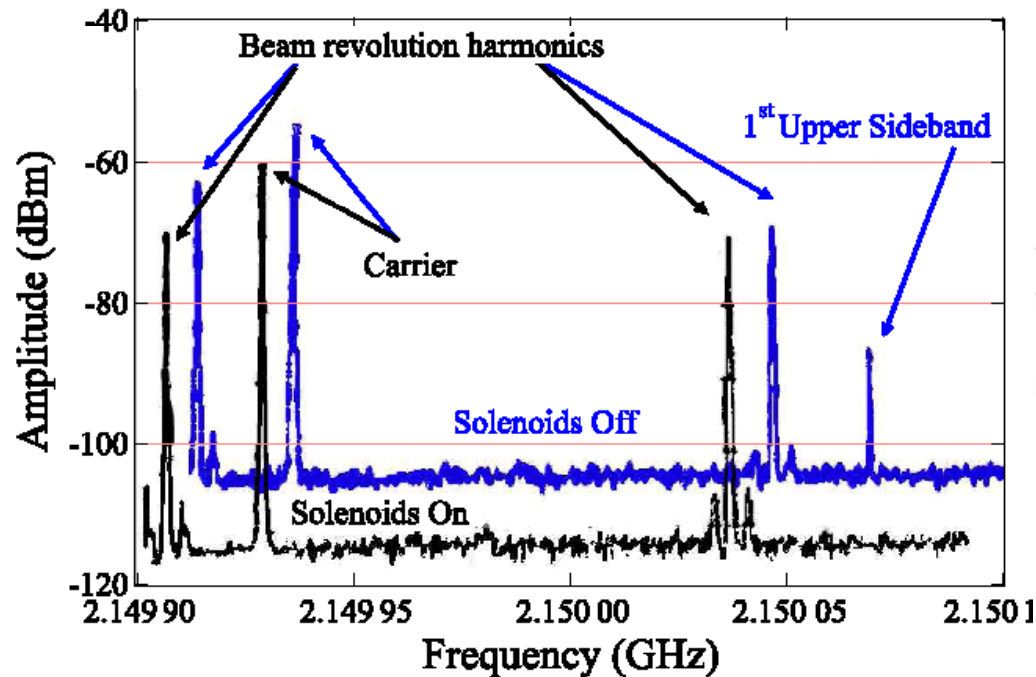

Spectrum analyzer traces showing **microwave carrier and beam signals** measured in the PEP-II Low Energy Ring over a distance of 50 m with a carrier at 2.15 GHz. A phase modulation sideband appears when the solenoid fields of 20 G covering the entire region is turned off, allowing the electron plasma to fill the beam pipe. Only upper sideband is shown.

D. Santis et al, *Phys. Rev. Lett.* 100, 094801, 2008.

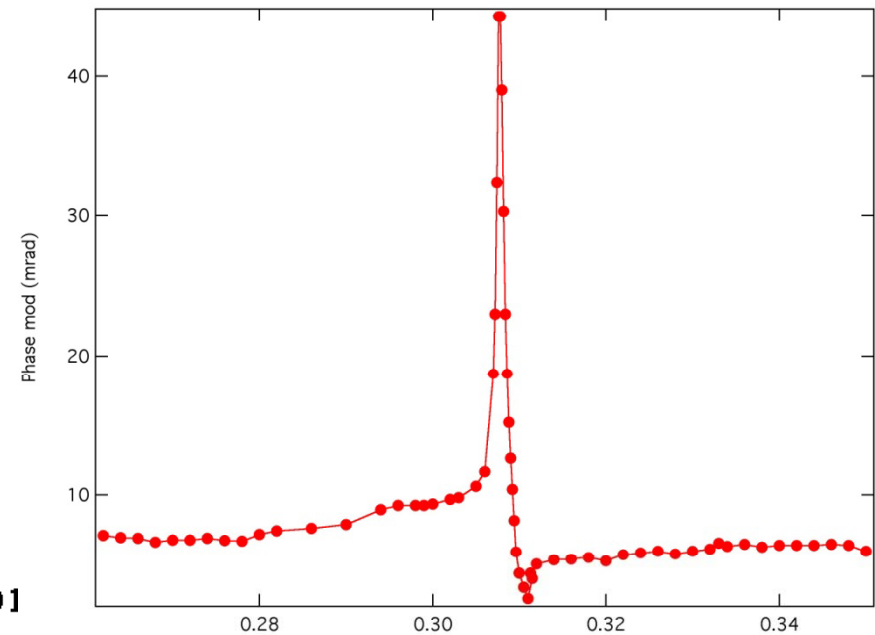

**Microwave phase modulation amplitude measured over a length of 4 m in the CESR-TA accelerator with a carrier frequency of 2.015 GHz. The **dipole setting at the peak of about 0.307 units corresponds to a field of 700 T and to a cyclotron****

**resonance near 2 GHz.**

J. Byrd et al, *ILC Damping Ring R&D Workshop 2008*, 8-11 July 2008



## example highlight: PS clearing electrode study

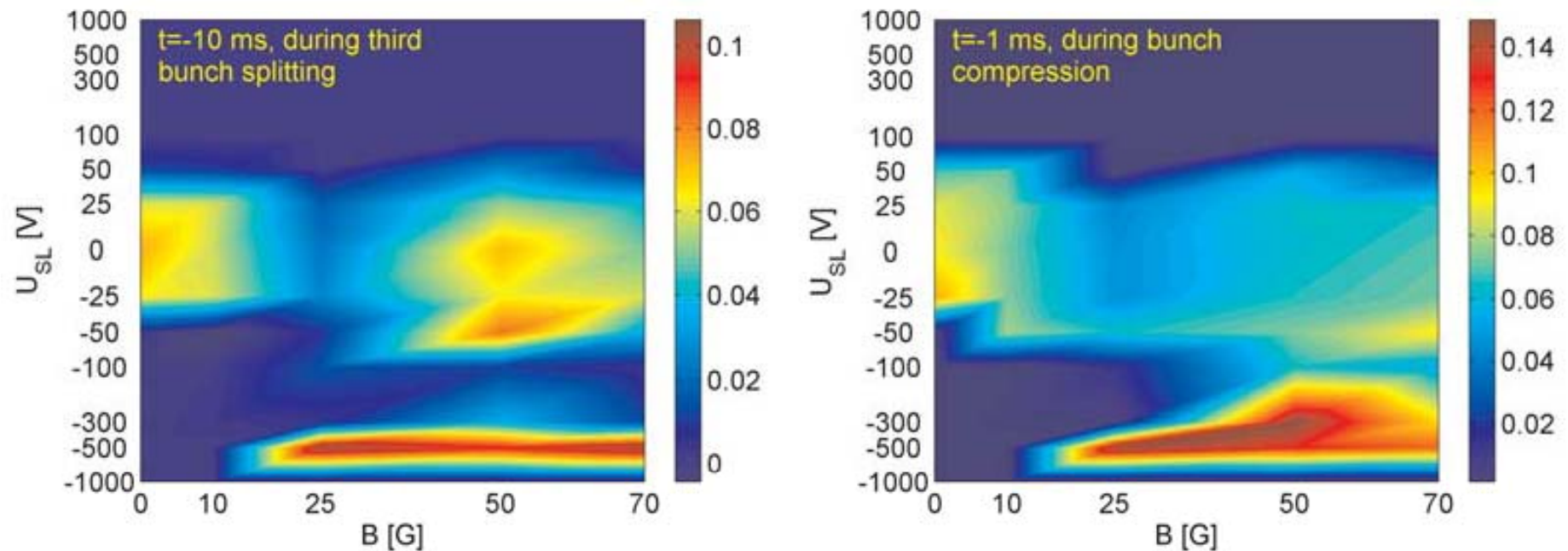

**Electron cloud signal at the CERN PS** in units of Volt measured for various clearing electrode voltages ( $-1 \text{ kV} < U_{SL} < +1 \text{ kV}$ ) and magnetic dipole fields ( $0 \text{ G} < B < 70 \text{ G}$ ).

Measurements were taken continuously during the last 50 ms before beam extraction at  $t = 0 \text{ ms}$ .

E. Mahner, T. Kroyer, F. Caspers, "Electron cloud detection and characterization in the CERN Proton Synchrotron," *PRST-AB*, 2008

F.Zimmermann, CERN

## example highlight: incoherent e-cloud effect

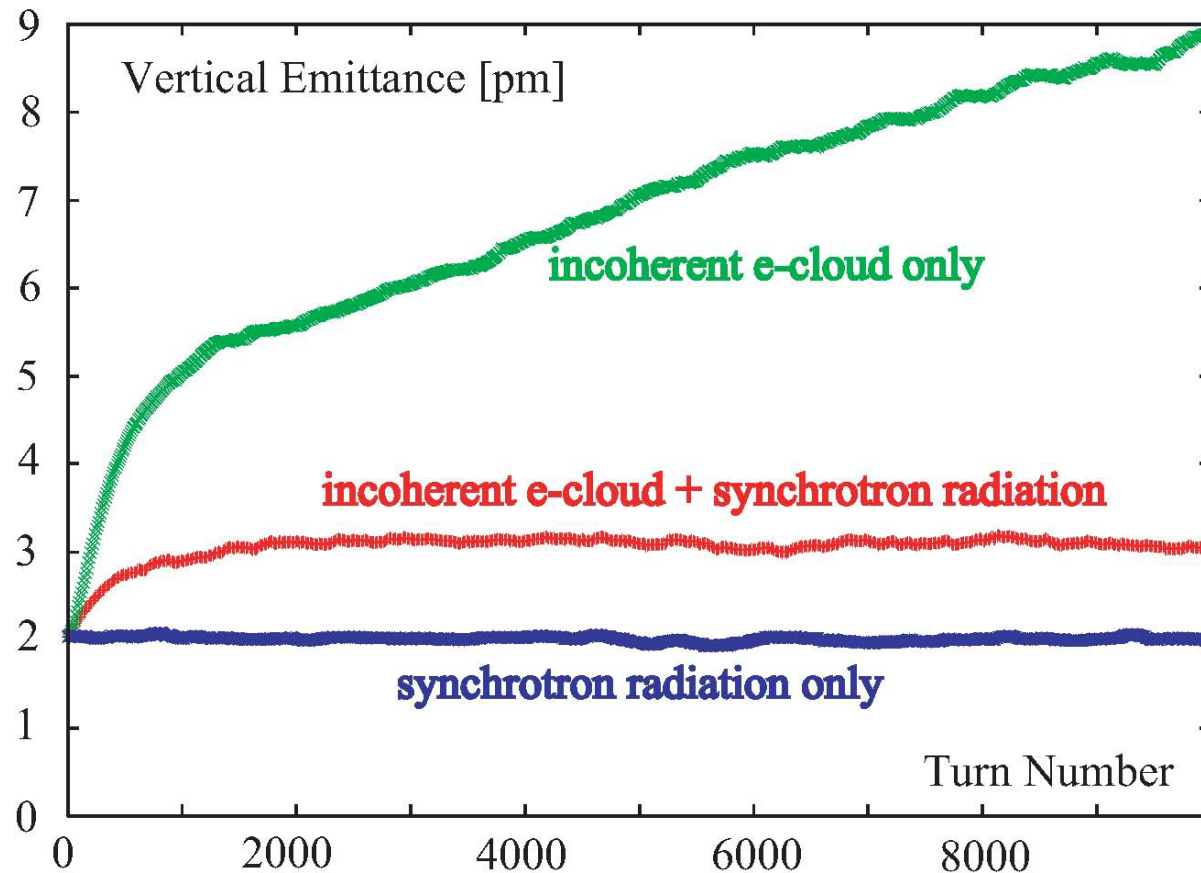

**Vertical emittance in the ILC 6-km damping ring (OCS) as a function of turn number, with synchrotron radiation only, with a frozen electron cloud pinch only, and with the combined effect, simulated by IECP using a single beam electron “IP” per turn and an initial tune shift, at the head of the bunch, of  $\Delta Q \approx 0.01$ , corresponding to an electron density of  $2e^{11}/m^3$ . The incoherent tune shift is taken to increase 140 times during the bunch passage.**

## deliverable 1: e-cloud code

the work-horse e-cloud codes: **E-CLOUD, HEADTAIL, IECP, MICROMAP**  
(also see **e-cloud code repository** at

[http://oraweb.cern.ch/pls/hhh/code\\_website.disp\\_category?cat\\_name=ElectronCloud](http://oraweb.cern.ch/pls/hhh/code_website.disp_category?cat_name=ElectronCloud) and  
the **e-cloud code benchmarking web site** <http://care-hhh.web.cern.ch/CARE-HHH/Simulation-Codes/Benchmark/ElectronCloud.htm>)

were complemented by a new code developed within EUROTeV:  
**FAKTOR2** – a 3D code able to treat arbitrary boundaries

### **Faktor2 Documentation:**

W. Bruns, “Faktor2: Usage,” EUROTeV-Report-2007-071.

W. Bruns, “Faktor2: Rationale,” EUROTeV-Report-2007-072.

### **Faktor2 Custodian:**

Giovanni Rumolo (CERN)

# Faktor2 code examples

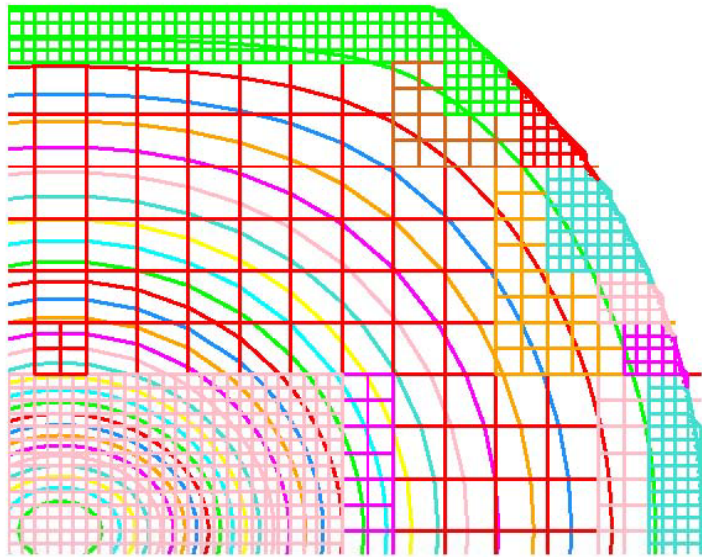

**Subdivision of the grid near the pipe boundary and at the location of the beam. Two levels of refinement are applied. The different colours of the refined cells indicate clusters of cells which are treated as rectangular grids. The curved lines are lines of constant potential of an elliptical beam at the center.**

W. Bruns et al, PAC'07

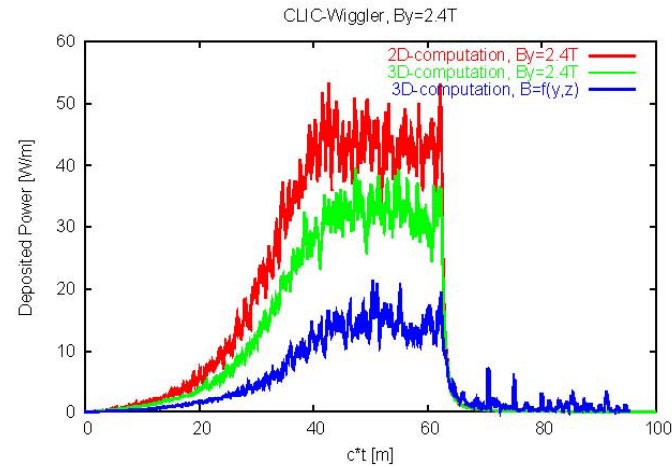

**Power deposited by e-cloud inside a CLIC wiggler from 2D and 3D Faktor2 simulations**

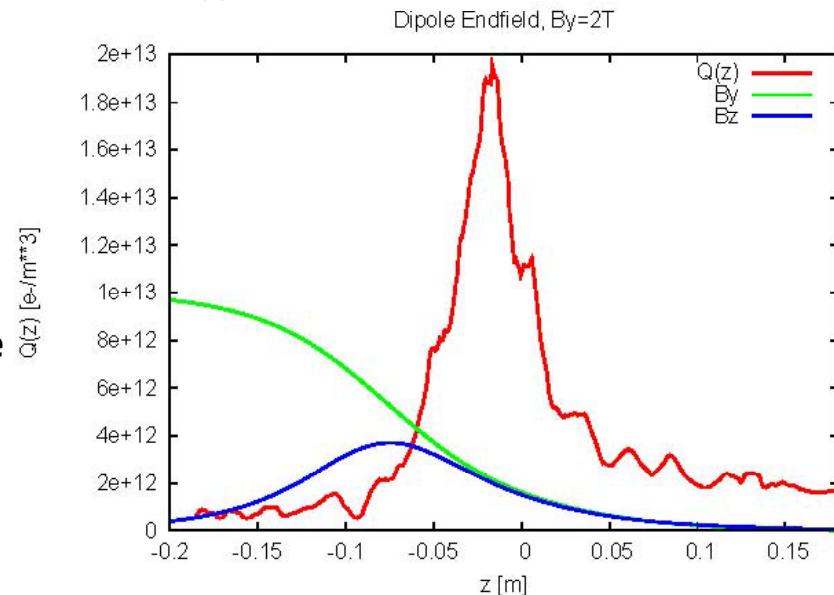

**Time average of the electron density near the axis in the end region of a dipole. Red: Electron density. Green and blue: shape of the By and Bz component.**

F.Zimmermann, CERN

## deliverable 2: report on e-cloud & ion impact on DR

### electron cloud:

**Build-up and instability simulations** show that the **electron cloud is a serious problem** for the positron damping rings. An **antechamber absorbing 99.9% of the synchrotron radiation** and a maximum secondary emission yield **SEY below 1.3** could ensure stable operation by suppressing electron cloud formation. (G. Rumolo, EPAC'08).

**Coatings with NEG, black gold or carbon** may guarantee  $SEY < 1.3$  and could solve this problem (S. Calatroni, P. Chiggiato, M. Taborelli)

### ions:

A **good vacuum pressure of 1 ntorr** plus a **fast bunch-by-bunch feedback** acting after about one turn would suppress the fast beam-ion instability. (G. Rumolo, EPAC'08)

# example results related to deliverables 1 & 2

**ECLLOUD simulations for wiggler chamber** of CLIC DR considering different values of SEY and of antechamber absorption efficiency

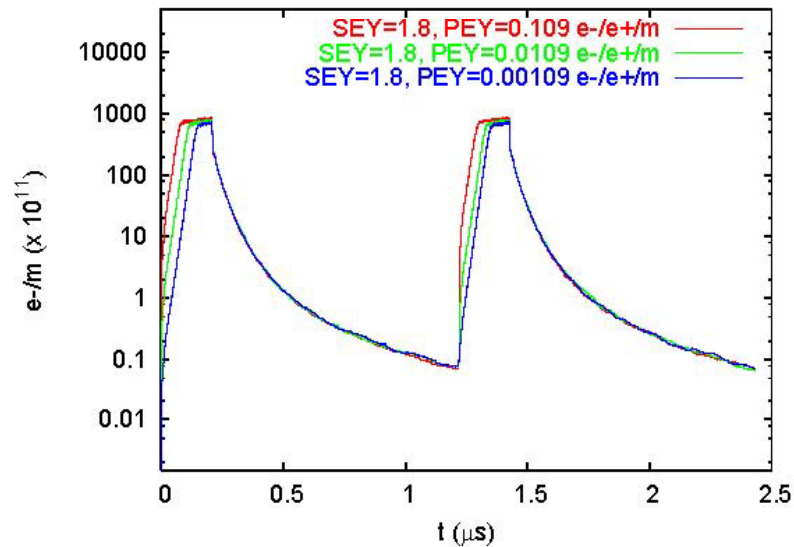
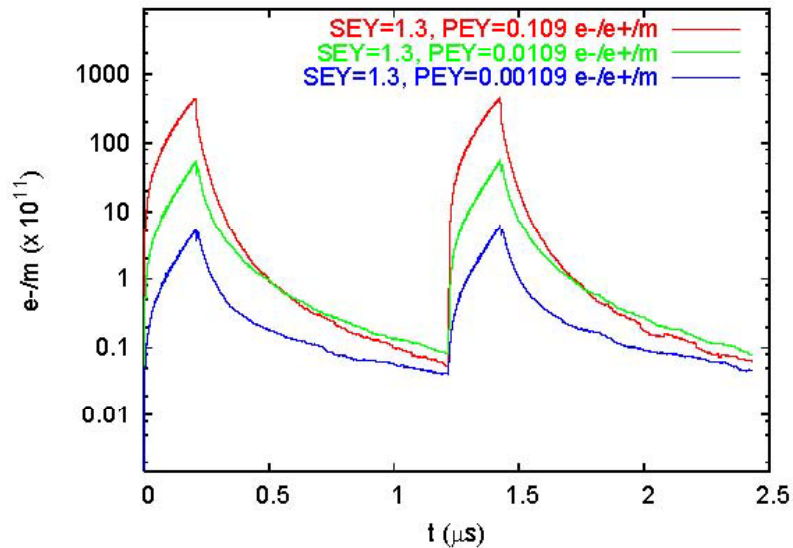

Faktor2 simulations exploring the effect of a **real antechamber geometry**

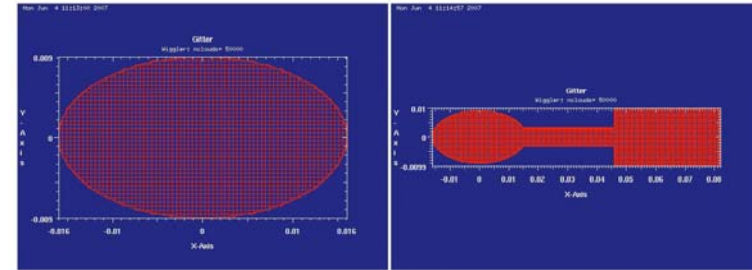

Simulated geometries and grids for the Faktor2 calculations. Ellipse (left) and geometry with antechamber (right).

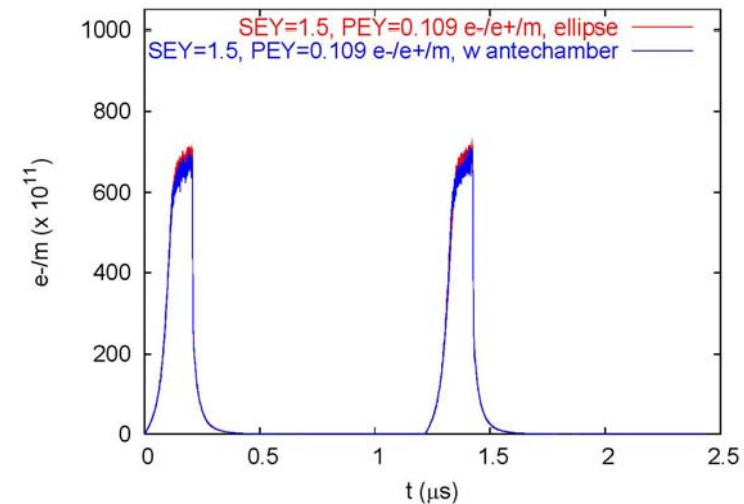

Electron central densities in the wiggler chamber of the CLIC DRs for the labelled value of photoemission yield, and  $\delta_{max} = 1.5$  (simulations with and without the antechamber).

W. Bruns,, G. Rumolo et al, EPAC'08

## ECLLOUD Task - epilogue

the last years have witnessed a remarkable progress in electron cloud diagnostics and suppression techniques

using a suitable technique and with proper precaution the electron cloud will not limit DR performance

# Cyclotron Resonance

Y. Cai et Al., Phys. Rev. ST-AB 7, 024402 (2004)

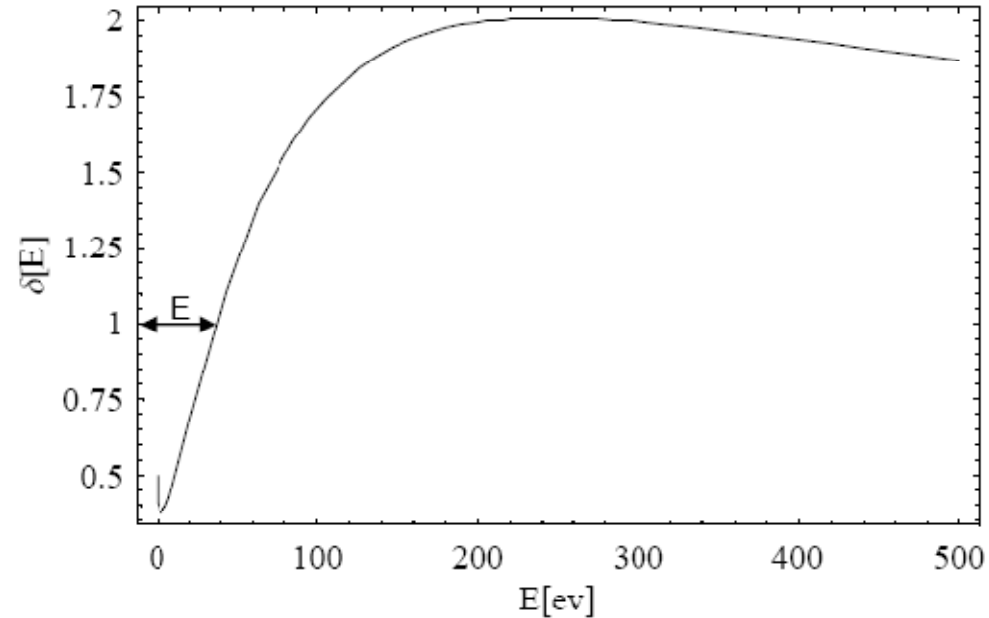

- Resonance condition

$$T_c / 2 = L_{sep} / c \Rightarrow B_z^{res} = \frac{\pi m_e c^2}{e L_{sep}} \approx 66G$$

- Intensity threshold

$$\Delta E_{kick} \geq E_{\delta=1} \Rightarrow N_b = \frac{R}{r_e} \sqrt{\frac{E_{\delta=1}}{2m_e c^2}} \approx \begin{cases} 7.1 \cdot 10^{10} e^+ & (R=33 \text{ mm}, \delta_{max}=2.4) \\ 9.5 \cdot 10^{10} e^+ & (R=44 \text{ mm}, \delta_{max}=1.9) \end{cases}$$



# Simulated Intensity Threshold

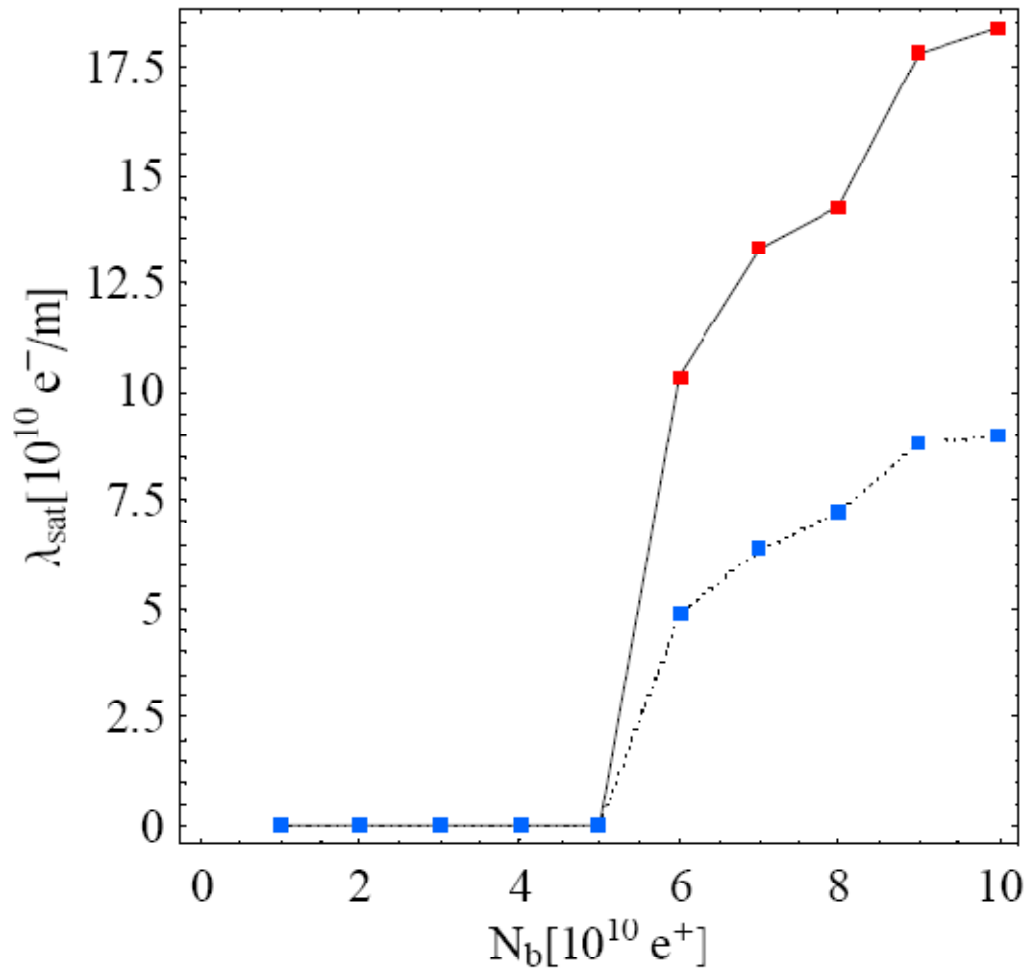

Bz=66 G; Lsep

Bz=33 G; 2Lsep

R=30mm

$\delta_{\text{max}} = 2.4$

$N_b \approx 5 \times 10^{10}$  for both Lsep and 2Lsep is above the DAFNE operated current.