

SiD Hadron Calorimeter Status and the LOI

Andy White
for the SiD HCal Group

SiD Workshop, Boulder, CU
September 2008

HCal Status - Outline

- HCal overview
- Global parameters
- PFA and HCal
- Brief summaries of recent progress for the various technologies:
 - DHCAL - RPC, Micromegas, GEM
 - AHCAL - Scintillator/SiPM
- HCal LOI Planning

SiD Detector

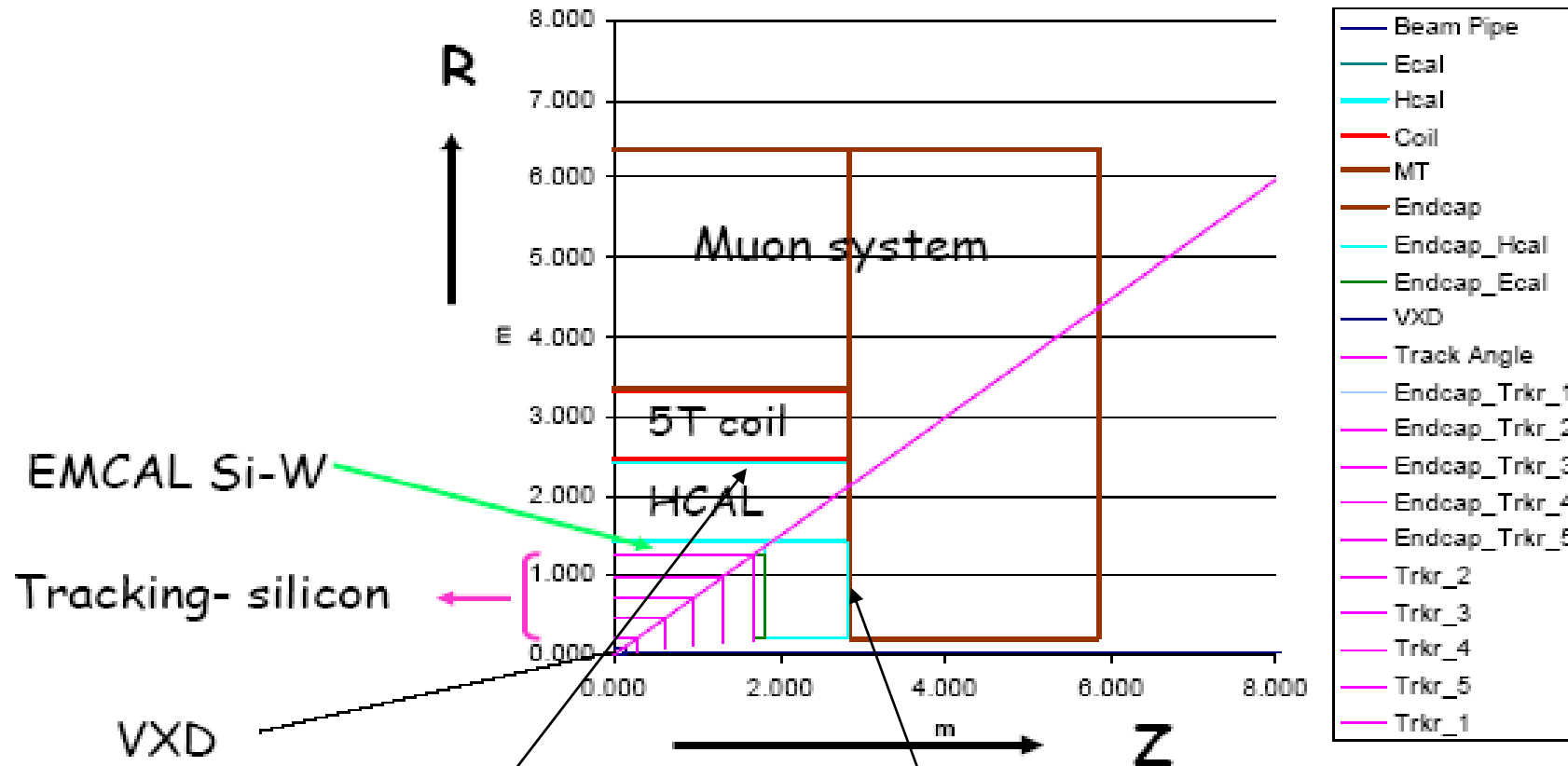

Increasing HCal radius moves coil out - cost increases

Making forward HCal deeper makes coil longer or needs a muon cutout

Global Parameters

New Proposed 4.5 λ Detector

Detector	Radius (m)		Axial (z) (m)	
	Min	Max	Min	Max
Vertex Detector	0.014	0.060	0.000	0.180
Central Tracking	0.206	1.250	0.000	1.607
Endcap Tracker	0.207	0.492	0.850	1.637
Barrel Ecal	1.265	1.409	0.00	1.765
Endcap Ecal	0.206	1.250	1.657	1.800
Barrel Hcal	1.419	2.493	0.000	3.018
Endcap Hcal	0.206	1.404	1.806	3.028
Coil	2.591	3.392	0.000	3.028
Barrel Iron	3.442	6.082	0.000	3.033
Endcap Iron	0.206	6.082	3.033	5.673

New Global Parameters and HCal

- PANDORA/PFA studies (from Marcel Stanitzki) indicate the benefits of deepening HCal from 4λ to 4.5λ
- This deepening of HCal does not have associated prohibitive cost increase.
- SiD/PFA studies from (Mat Charles et al.) indicate benefits of making forward HCal 5λ deep.
- Adding depth to the forward HCal is much preferred to requiring high granularity in the first n-layers of the muon system - but for after LOI.

200 GeV

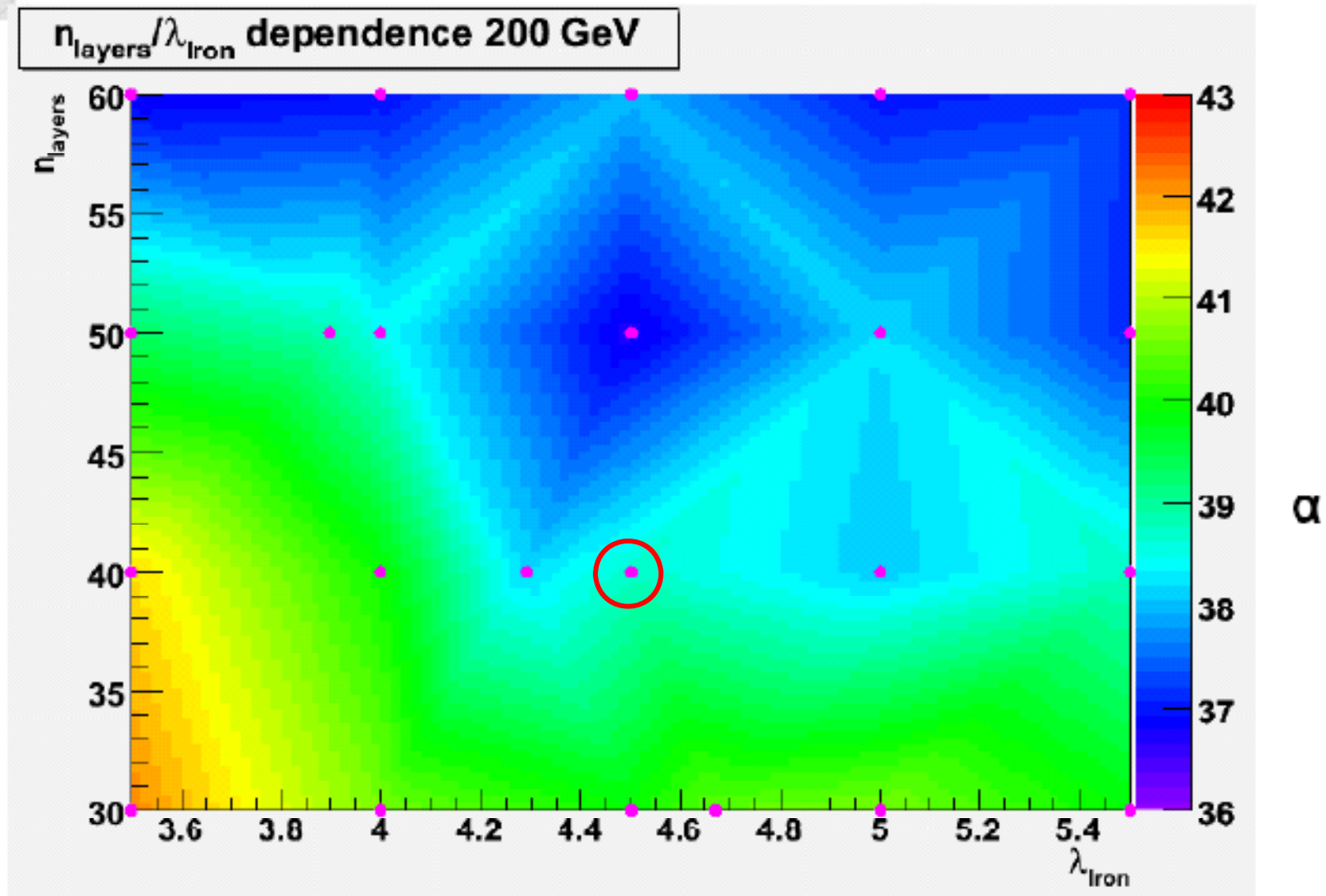
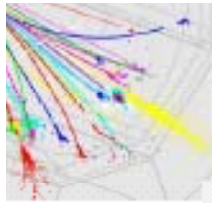

HCal and the Muon system

- Resolution is a lot worse in events with significant leakage into MUCAL
- For qq500, particle multiplicity in MUCAL is low
 - mean 1.0 particle per event with >4 hits in muon system for qq500 (sid01_scint)

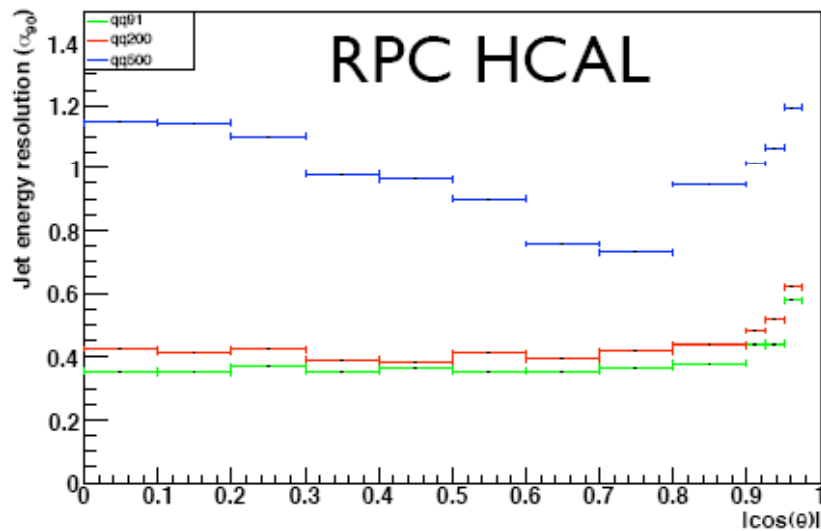

qq500	<20 muon system hits	≥ 20 muon system hits
sid01 RPC HCAL	+1.55 \pm 17.36	-9.46 \pm 23.97
sid01_scint Scintillator HCAL	-1.76 \pm 15.26	-13.09 \pm 22.46

Mat Charles, 8/13/08

Using the MUCAL

Here are a couple of qq500 events that leak into the MUCAL:

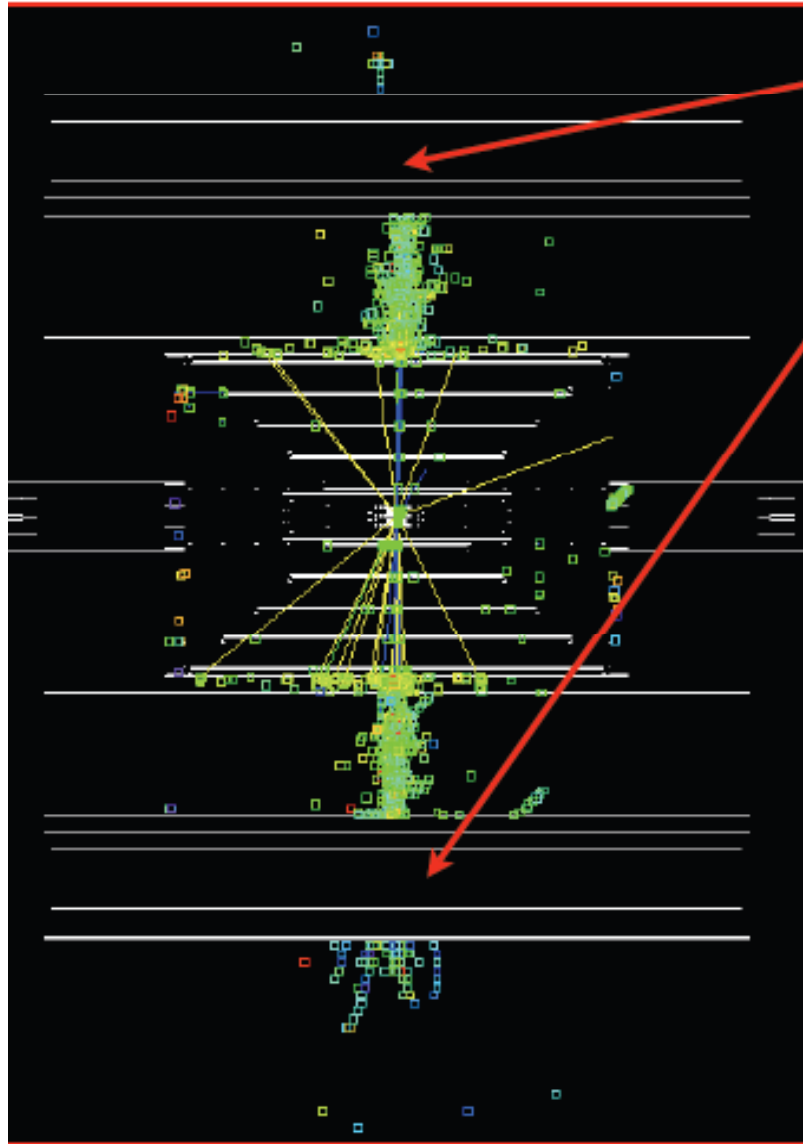

Gap of $\sim 1\text{m}$ between barrel HCAL and MUCAL (and lots of material) \Rightarrow we can match to the right jet but identifying which particle is much harder.

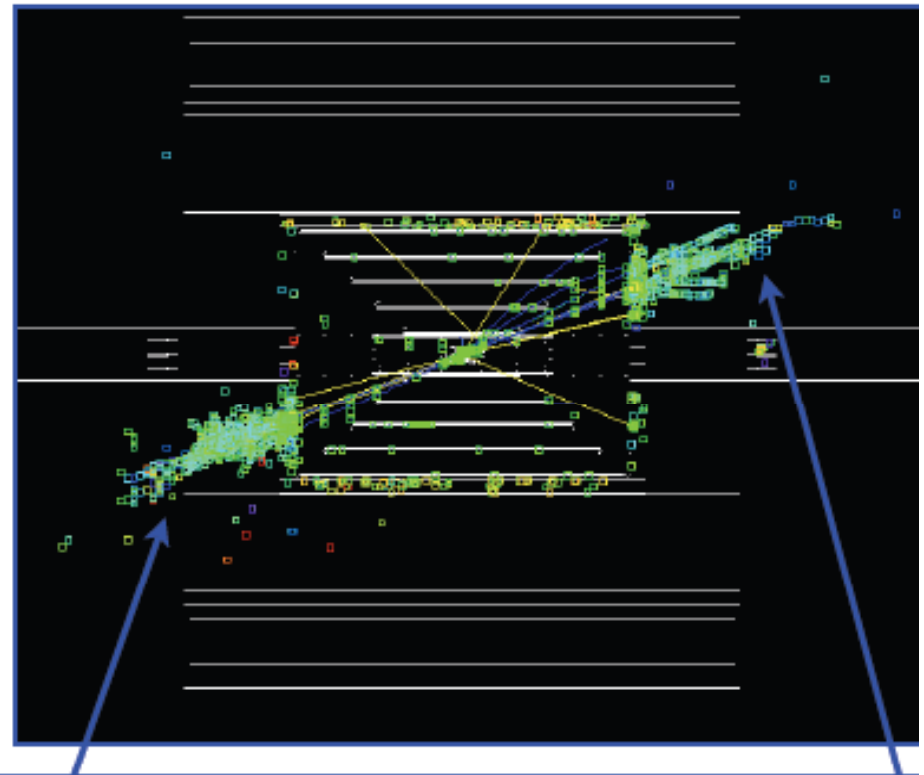

Minimal gap between endcap HCAL and MUCAL \Rightarrow pattern recognition is straightforward and we can match to the right particle.

Using the MUCAL

We can plug the **endcap MUCAL** into the PFA easily (treating it like another HCAL). We don't use the barrel MUCAL at all yet.

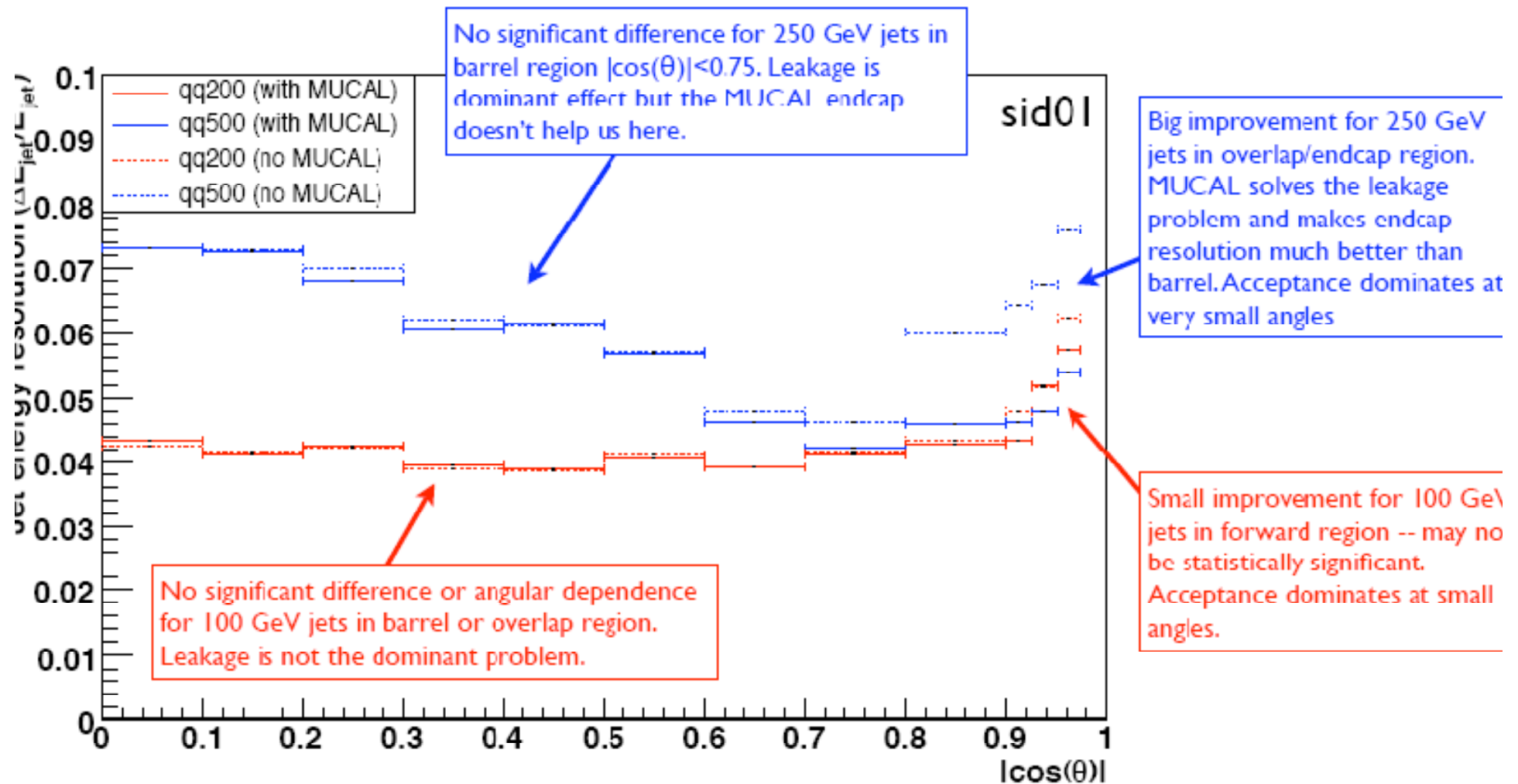

So this is why our qq500 resolution was so awful -- leakage was killing us!

HCal Engineering design(s)

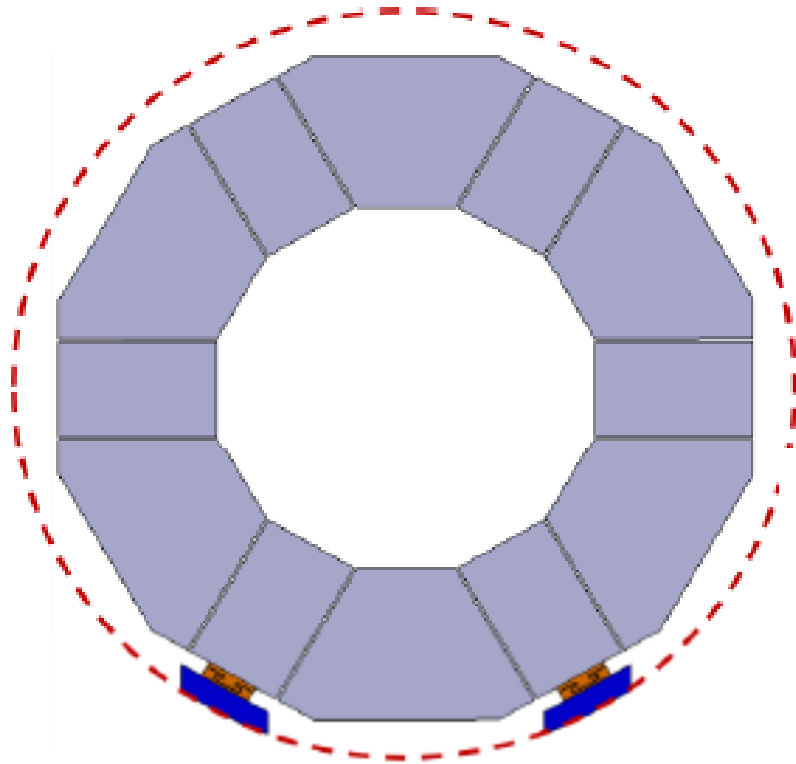

LOI - Need to be consistent between cylindrical simulation approximation and more realistic engineering designs - decision needed!

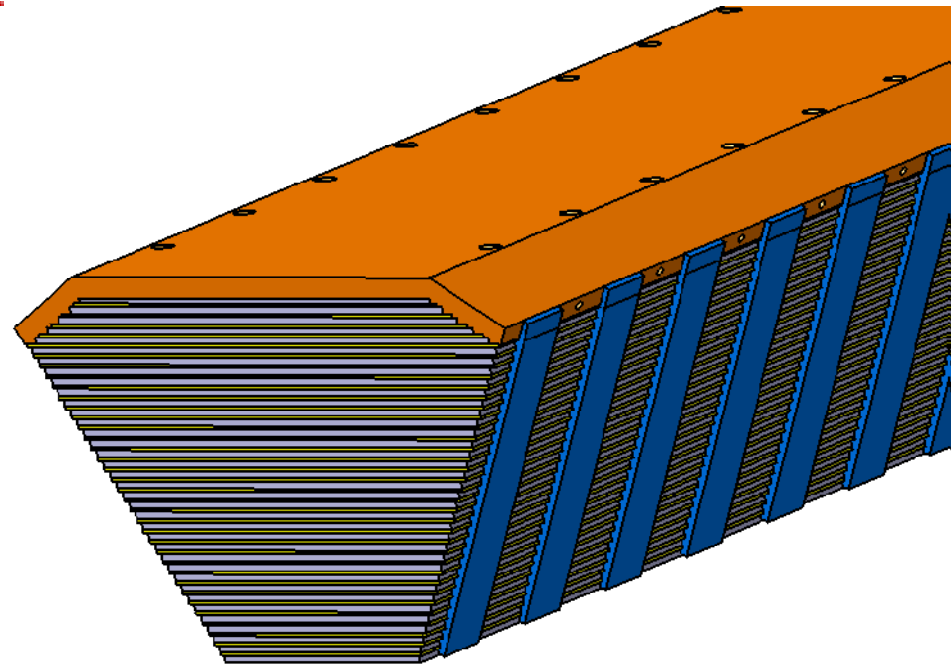

HCal technologies R&D

In parallel with the PFA/simulation studies there has been continued development of the various HCal technologies.

I will give a brief summary of some recent work for each technology, but...

- Not complete
- Not proportional to effort(s) involved
- Too much to cover in short talk

Digital Hadron Calorimeter with Resistive Plate Chambers

Status of the US Project

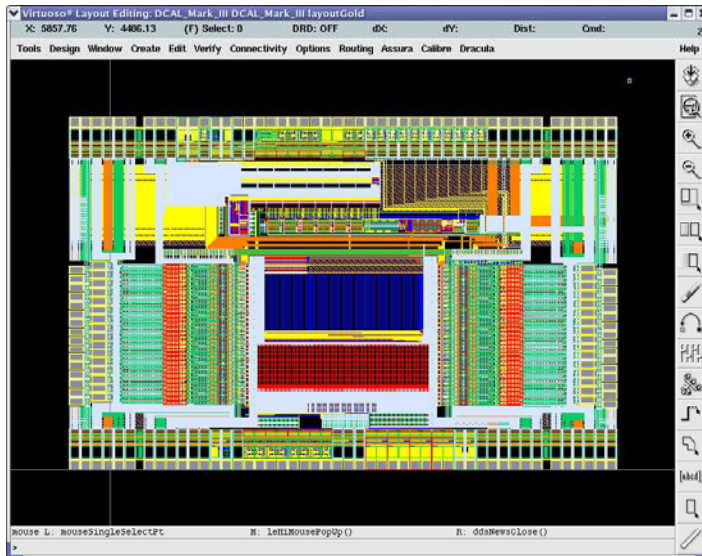

José Repond
Argonne National Laboratory

CALICE Meeting, Manchester, September 8 – 10, 2008

I DHCAL – Overview

Past – Built Vertical Slice Test with up to 10 RPCs (20 x 20 cm²)

Tests included the entire electronic readout chain
Extensive tests with cosmic rays and in Fermilab test beam
3 papers in refereed journal

→ Extensive data analysis

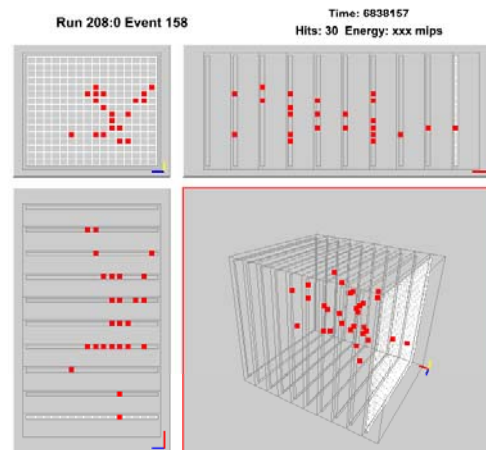

Analysis of the DHCAL Vertical Slice Test Data

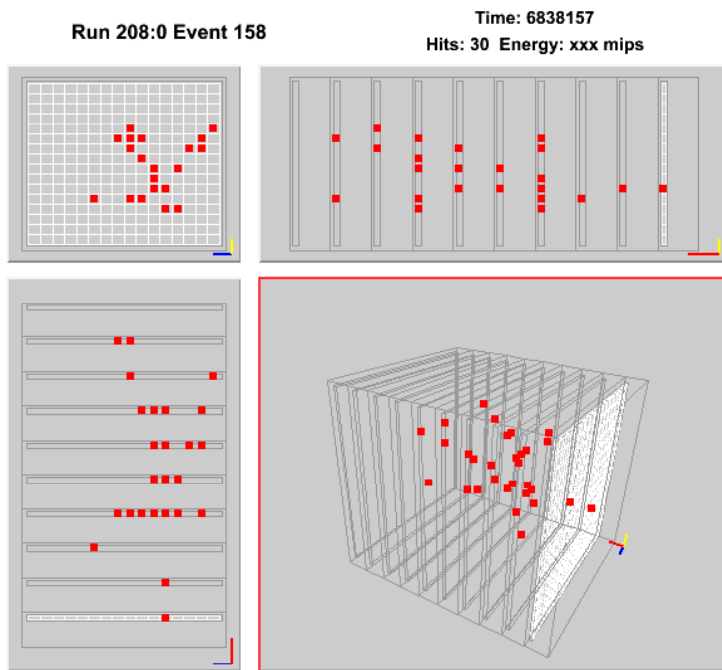

José Repond
Argonne National Laboratory

I Vertical Slice Test

Test of whole system with

Up to 10 RPCs, each 20 x 20 cm²
(Up to 2560 channels)

RPCs

Up to 9 2-glass designs
1 1-glass design
Only use RPC0 – RPC5 in analysis of e^+ , π^+
Only use RPC0 – RPC3 for rate dependence

Absorber

For cosmic rays, muon, pions, electrons: Steel (16 mm) + Copper (4 mm)
Rate capability measurement (120 GeV protons): 16 mm PVC with whole cut out in center

Test beam

Collected data in Fermilab's MT6 beam line
Used

Primary beam (120 GeV protons) with beam blocker for muons
Primary beam without beam blocker for rate measurements
Secondary beam for positrons and pions at 1,2,4,8, and 16 GeV/c



Data selection

- At most 1 cluster/layer
- Fiducial cut around border of RPCs
- At least 3/6 RPCs with hits

Plots used for tuning

- Sum of all hits
- Average number of hits/layer

Simulation looks ~OK

Now let's tune the parameters

Simulation

Number of hits

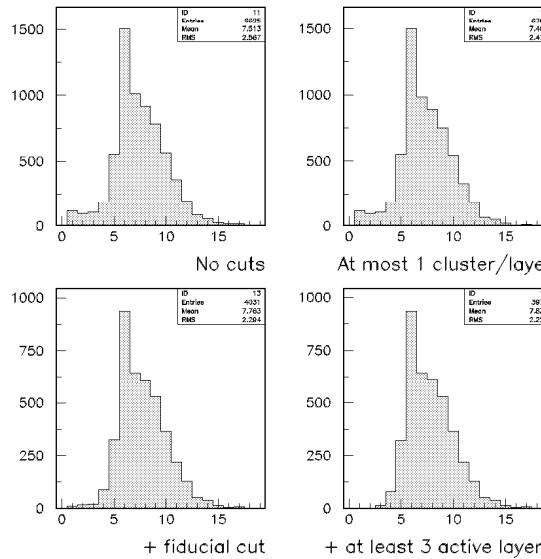

Data

Number of hits

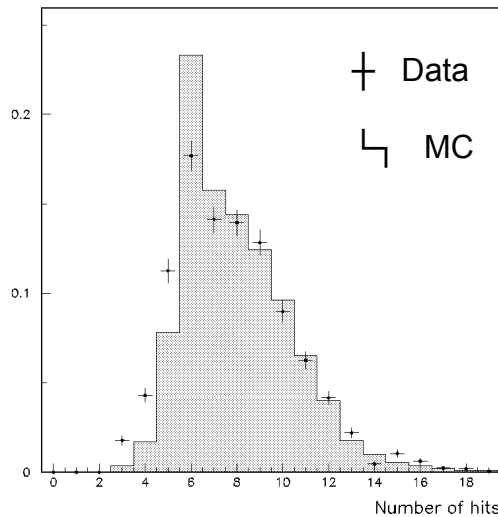
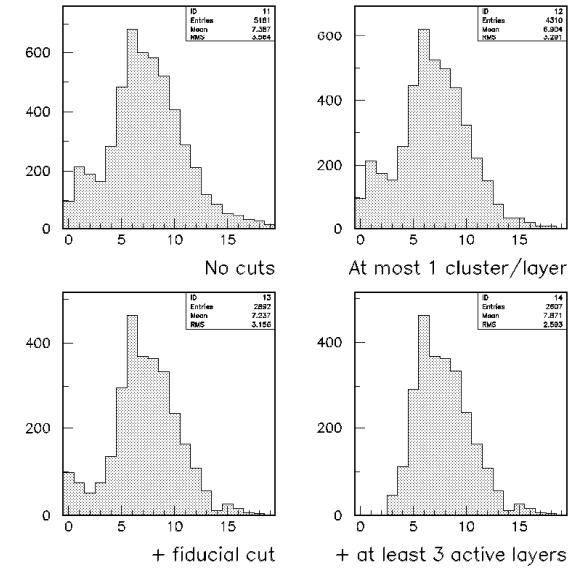

Number of hits/layer

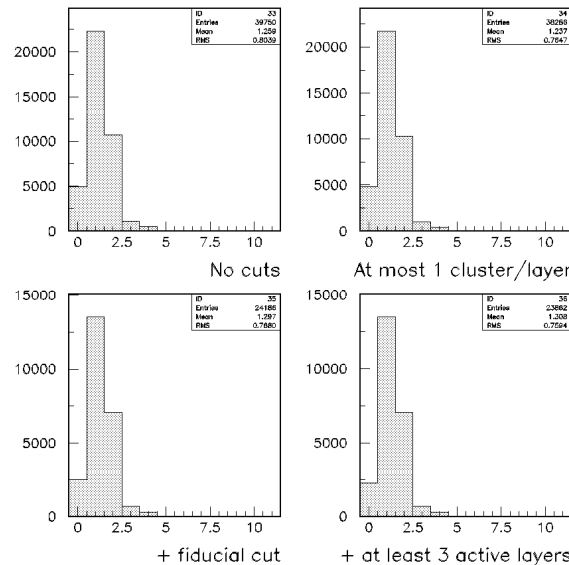

Number of hits/layer

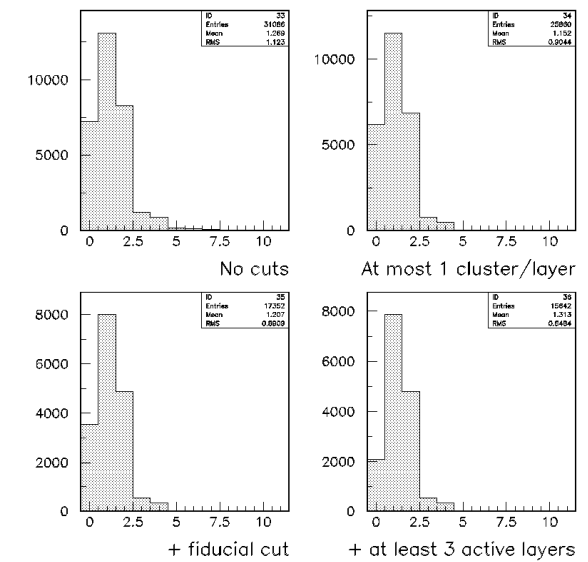

IV Simulation of Positron Data

Concentrate on 8 GeV data for the moment

Position of cluster in layer 0

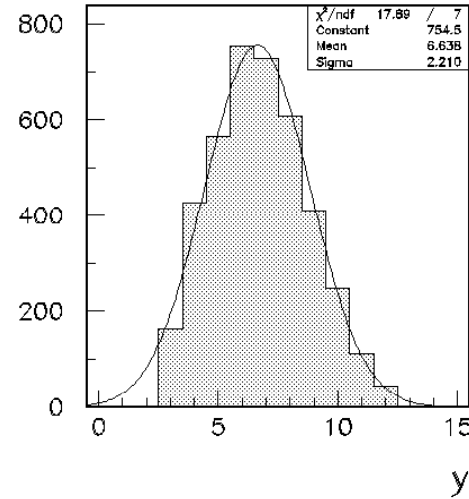
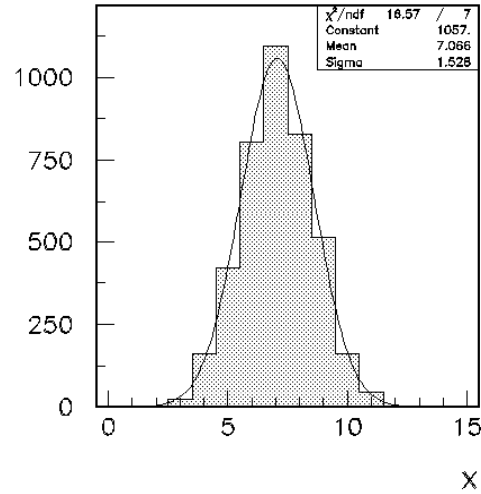

Good enough...

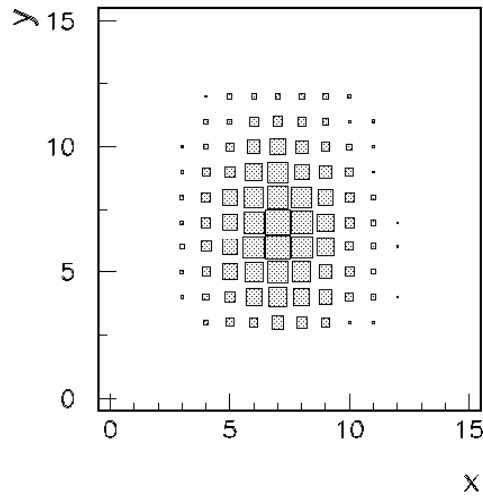

Momentum	Mean - x	Sigma - x	Mean - y	Sigma - y
16	6.94	2.43	6.50	2.94
8 - data	6.91	1.45	6.35	2.28
8 - MC	7.07	1.53	6.64	2.21
4	7.90	2.28	7.60	2.97
2	8.24	3.59	6.11	4.50
1	8.47	5.36	7.69	5.26

Longitudinal shower shape

Extra material in beam helps first layers

Deficit in last layers
→ need to check efficiency using pion data with same beam set-up

- Data
- MC: No material in beam
- ▽ MC: Reasonable material in beam
- ⊕ MC: Lots of material in beam ($1/4 X_0$)

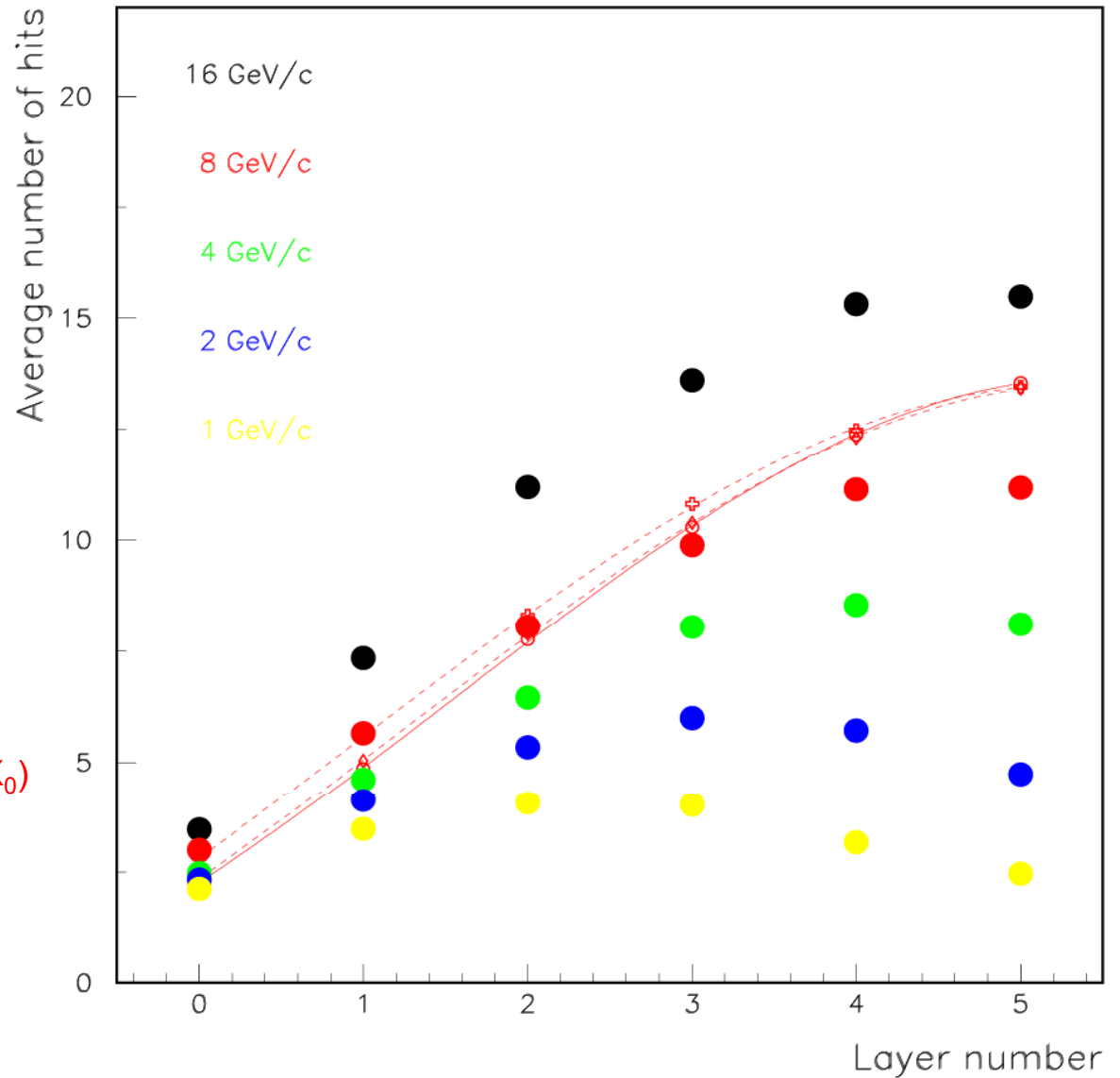

Lateral shower profile

With lots of material ($1/4 X_0$) in beam

Looks good everywhere

Data

Simulation

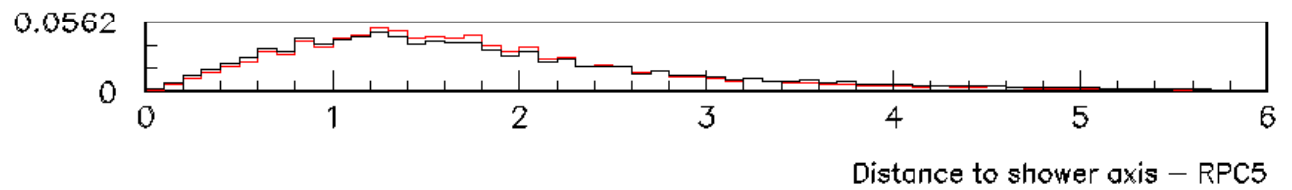
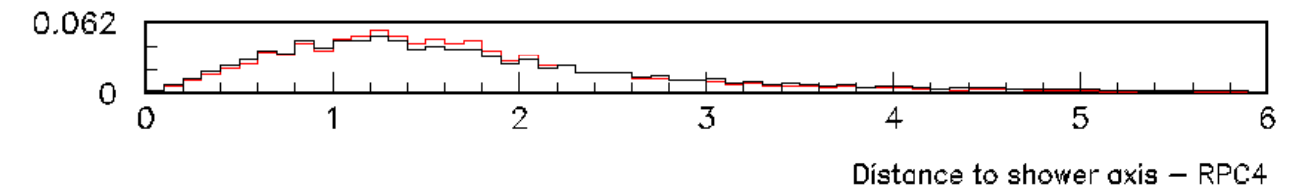
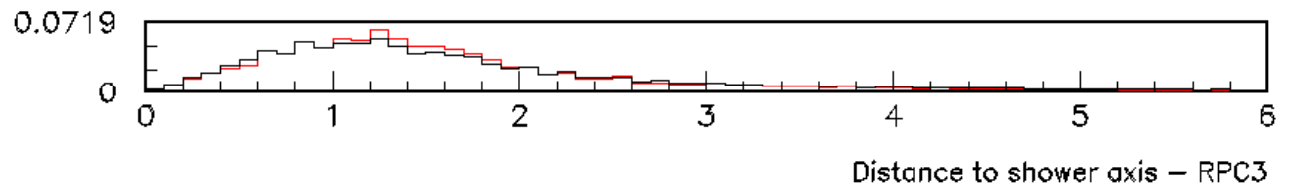
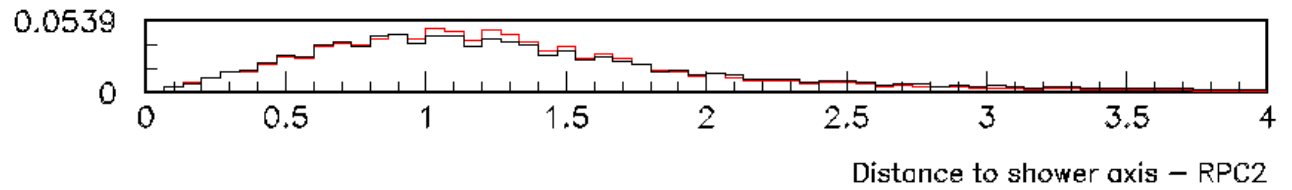
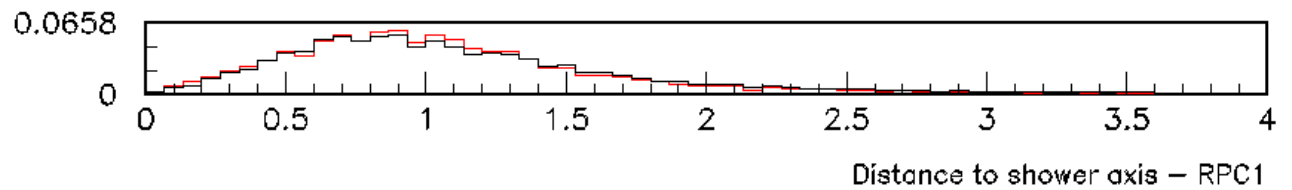
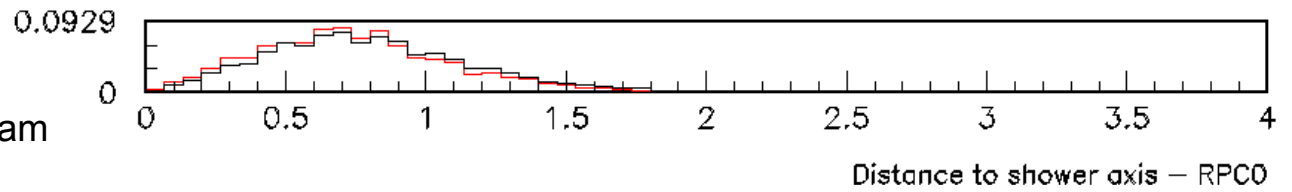

I DHCAL – Overview

Present - Preparation for construction of 1 m³ prototype section

Design and tests of larger RPCs (32 x 96 cm²)

Modifications to the DCAL chip (front-end ASIC)

New DAQ software based on CALICE framework

Extensive tests of RPCs and DAQ system

Future - Construction of 1 m³ prototype section

40 layers each with 96 x 96 readout channels

→ total of ~400,000 channels

To be inserted into CALICE HCAL structure

Goal of 10 layers in early 2009, remainder later in the year

All changes implemented

Design completed in July

Simulation ongoing

Financing of production sorted out

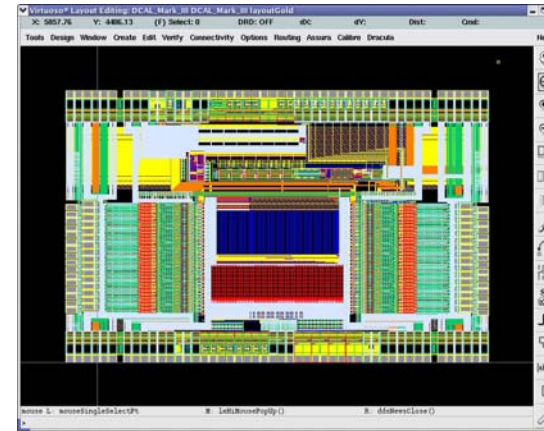

Cost ~ \$150,000 (for mask) + \$50,000 (for >9 wafers) + \$20,000 (for packaging)
Argonne – Fermilab contribute ~ 50:50

Submission on

Wednesday, 9/12/2008

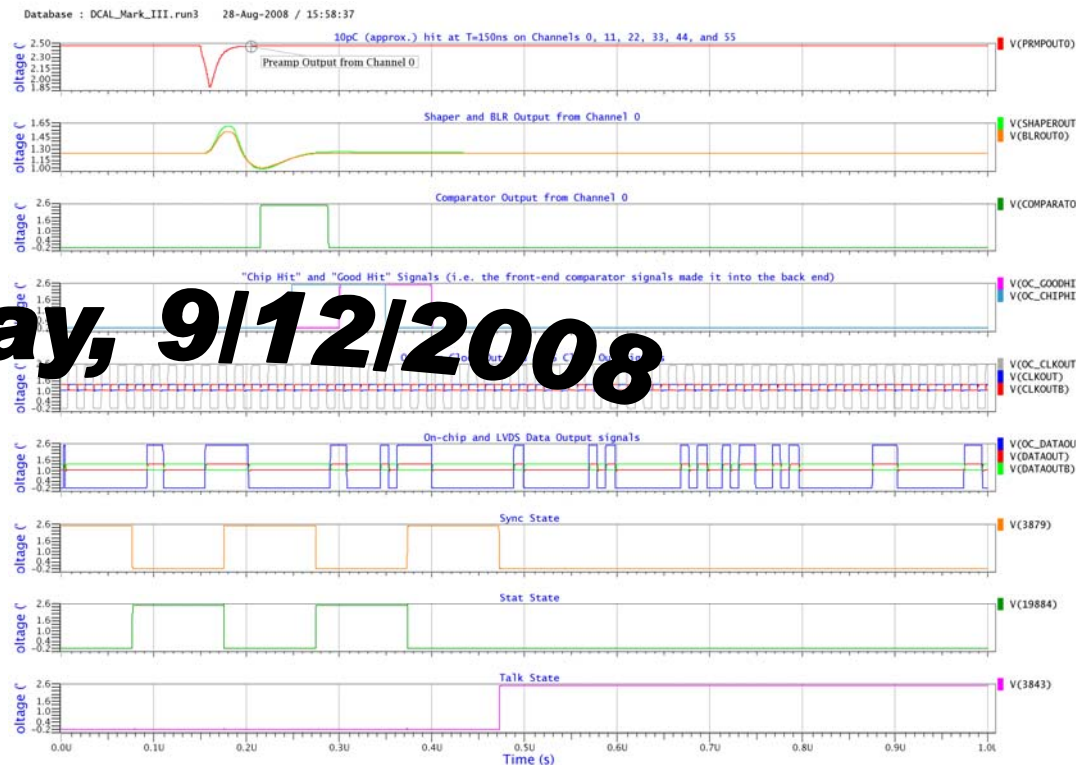

V Large Size RPCs and Cassettes

Large RPCs

32 x 96 cm² corresponding to 3072 channels
1st prototype assembled and being tested
Cosmic rays stand for large RPCs assembled

Cassettes

Design of 1 x 1 m² cassettes complete
Material for (few) cassettes in hand
Assembly of 1st (fake) cassette started

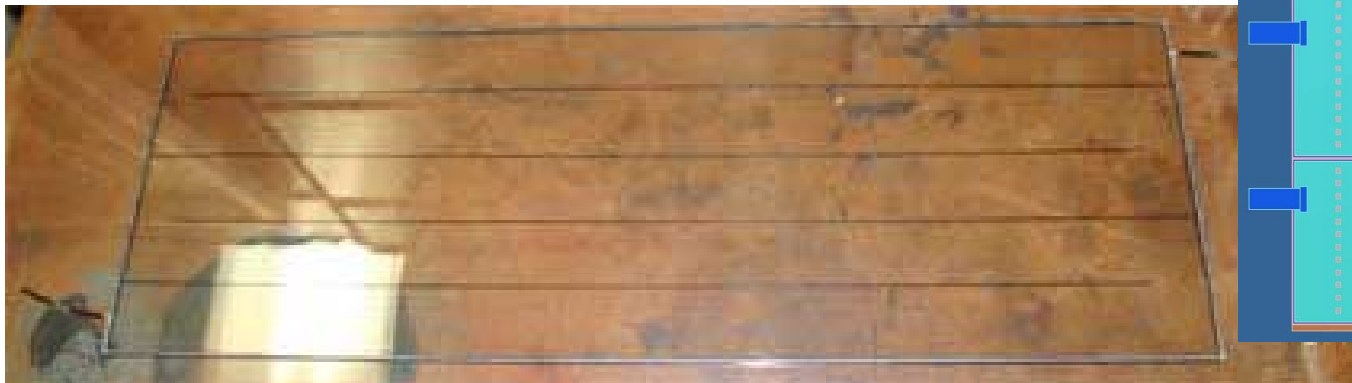
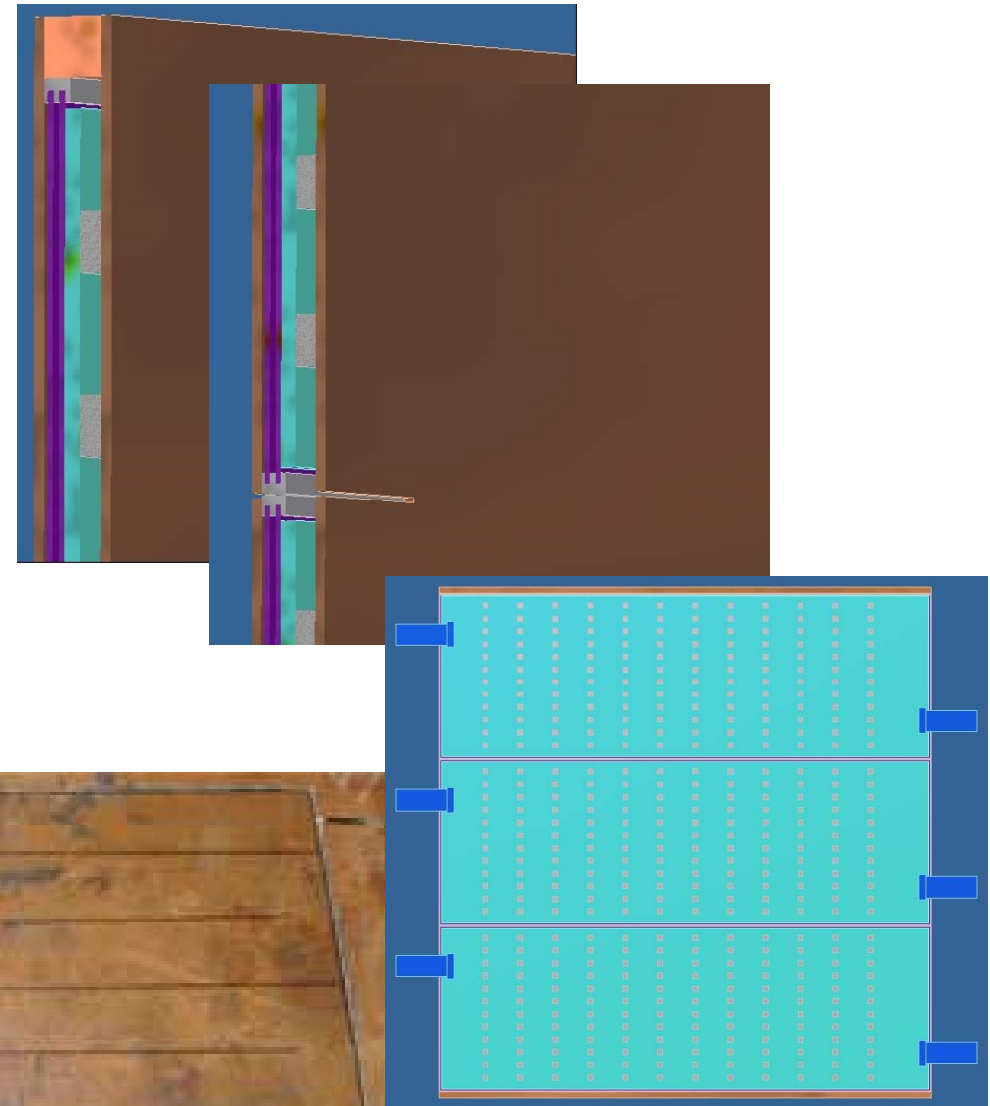

VIII Time Table

Month	9	10	11	12	1	2	3	4	5	6	7	8
RPC production	Build #1 and test	Build #2 & #3	Test									
Cassettes	Assemble 1 st layer	Design layout of supplies										
DCAL chip	Design and simulate Submit for production	Prepare packaged chip tests	Start testing									
Readout system	Complete tests of PadB and FEB Develop gluing techniques	Initiate design of new DCON		Prototype combined FEB & DCON								
DAQ	Test with multiple DCOL			Modify DAQ SW for 1 m ³								
HV and gas	Develop HV control SW Initiate assembly of gas mixing system				Complete gas mixing system							
Miscellaneous												
System					Test layer #1							



Ready for production

DHCAL-MICROMEGAS Test Beam

Catherine ADLOFF



I r f u



Institut de



recherche sur les lois

fondamentales de



l'Univers

saclay



The Setup

- Trigger: 3 scintillators in coincidence
- 3 MicroMegas 6x16 pads **analog**
- **1 MicroMegas 12x32 pads readout**
- Steel absorber optic

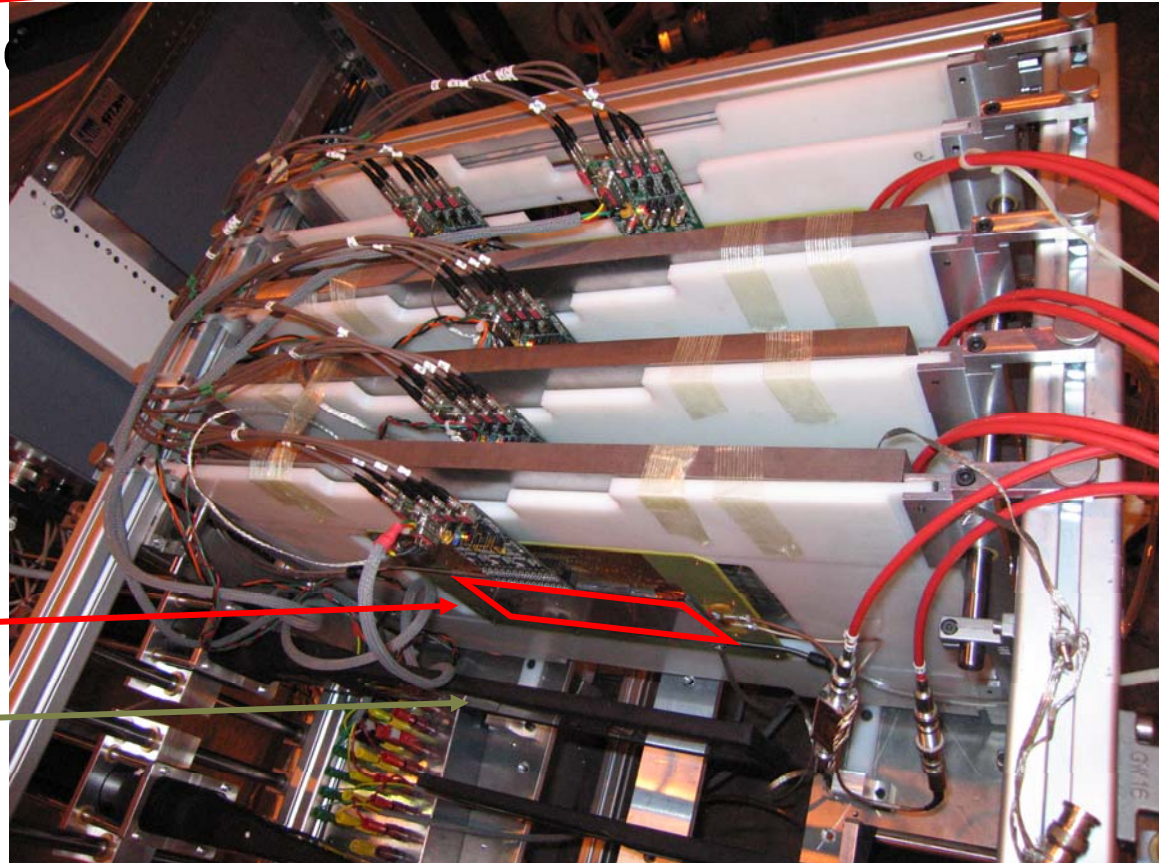
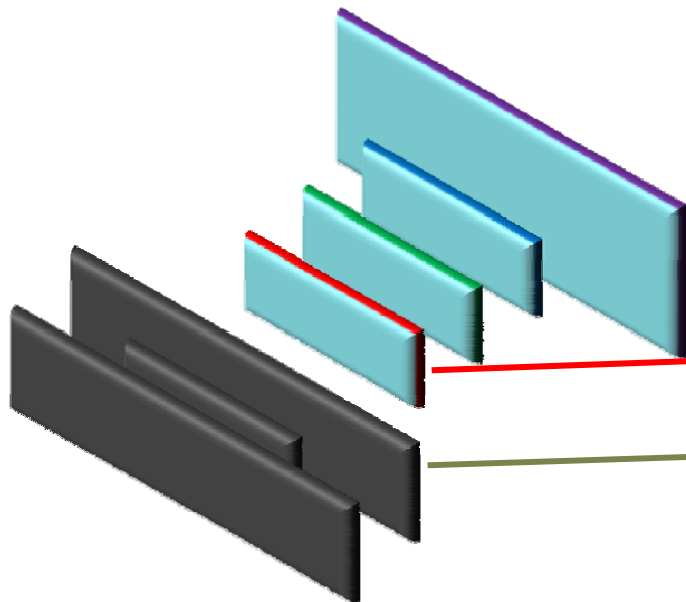
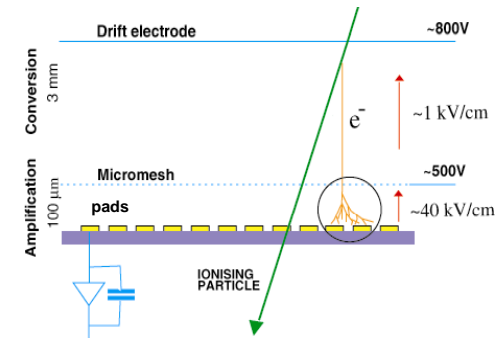

Event tags

– Platinum Events (~30%)

- One single hit per chamber
⇒ the cleanest events
- Pedestal & gain studies

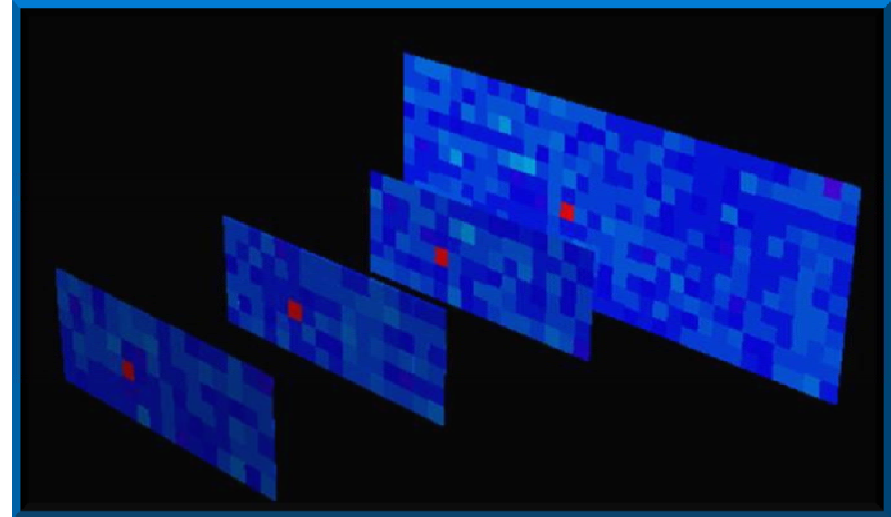

– Gold Events (~70%)

- One single hit for at least 3 chambers
⇒ clean events
- Efficiency & Multiplicity studies for the last chamber

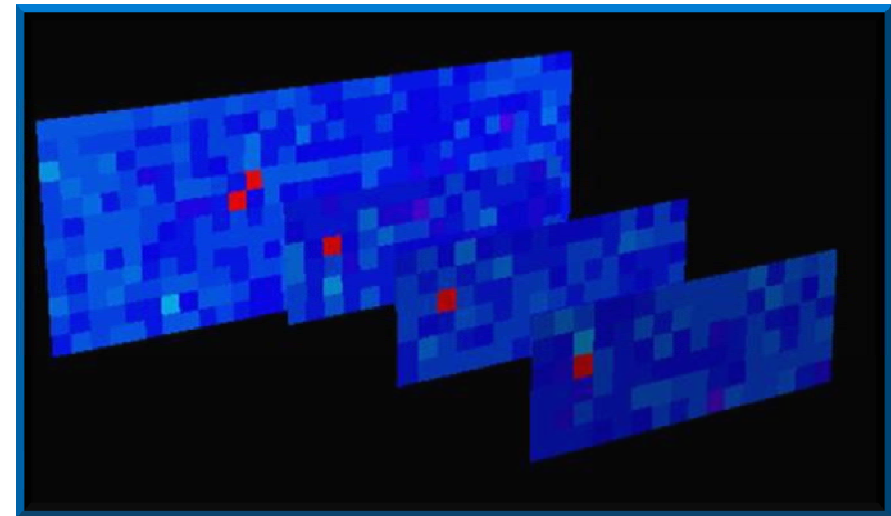

MIP Signal observed on every Single Channel

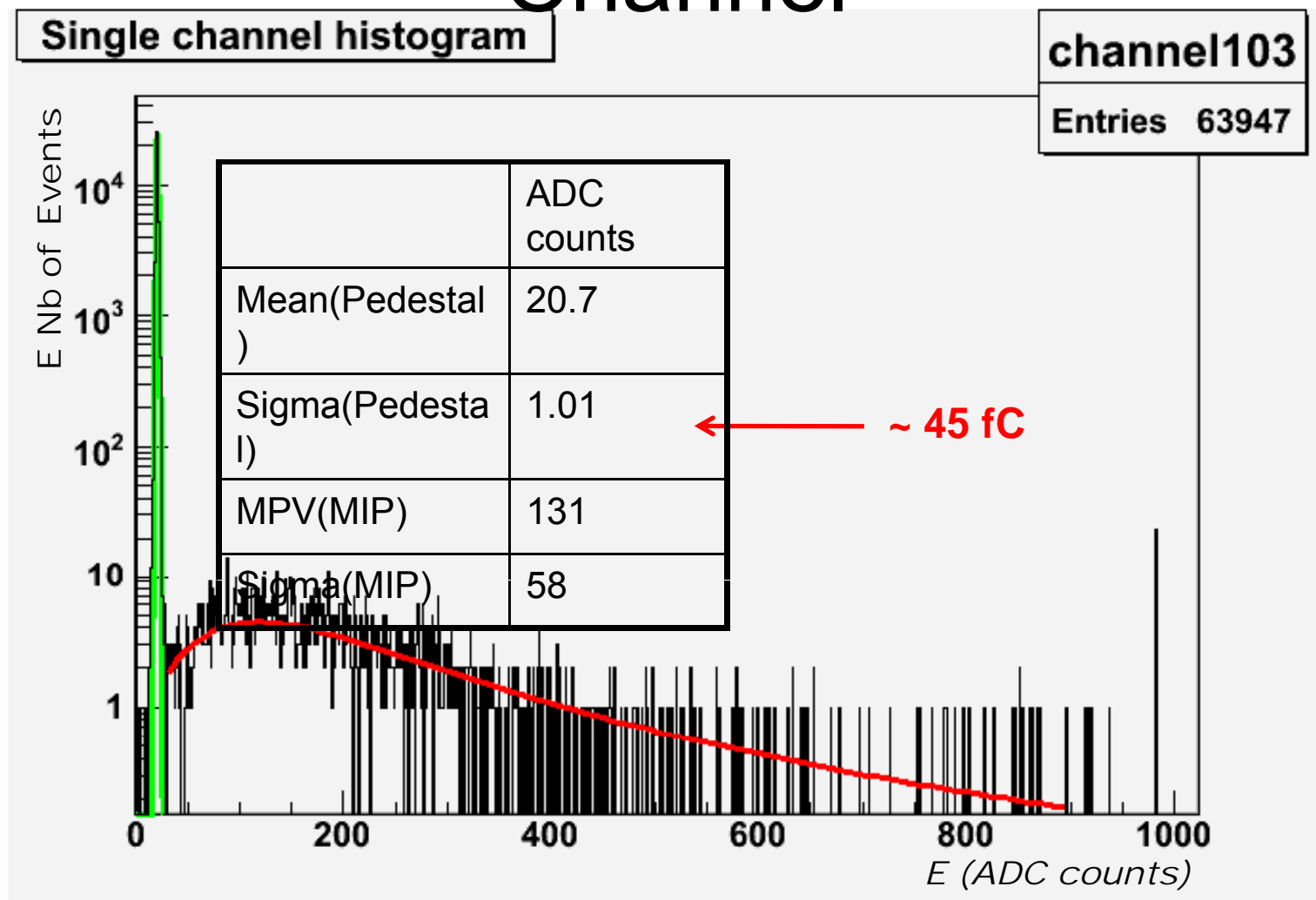

Efficiency Measurements

	Efficiency
Chamber 0	$97,05 \pm 0,07\%$
Chamber 1	$98,54 \pm 0,05\%$
Chamber 2	$92,99 \pm 0,10\%$
Chamber 3	$96,17 \pm 0,07\%$

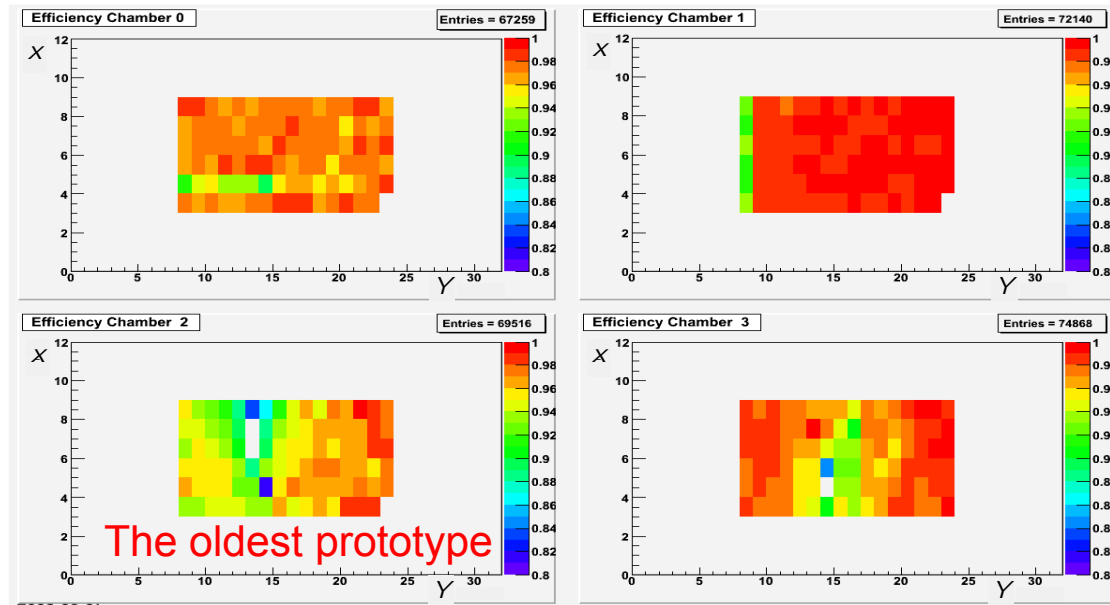

GEM-DHCAL: Update on recent activity

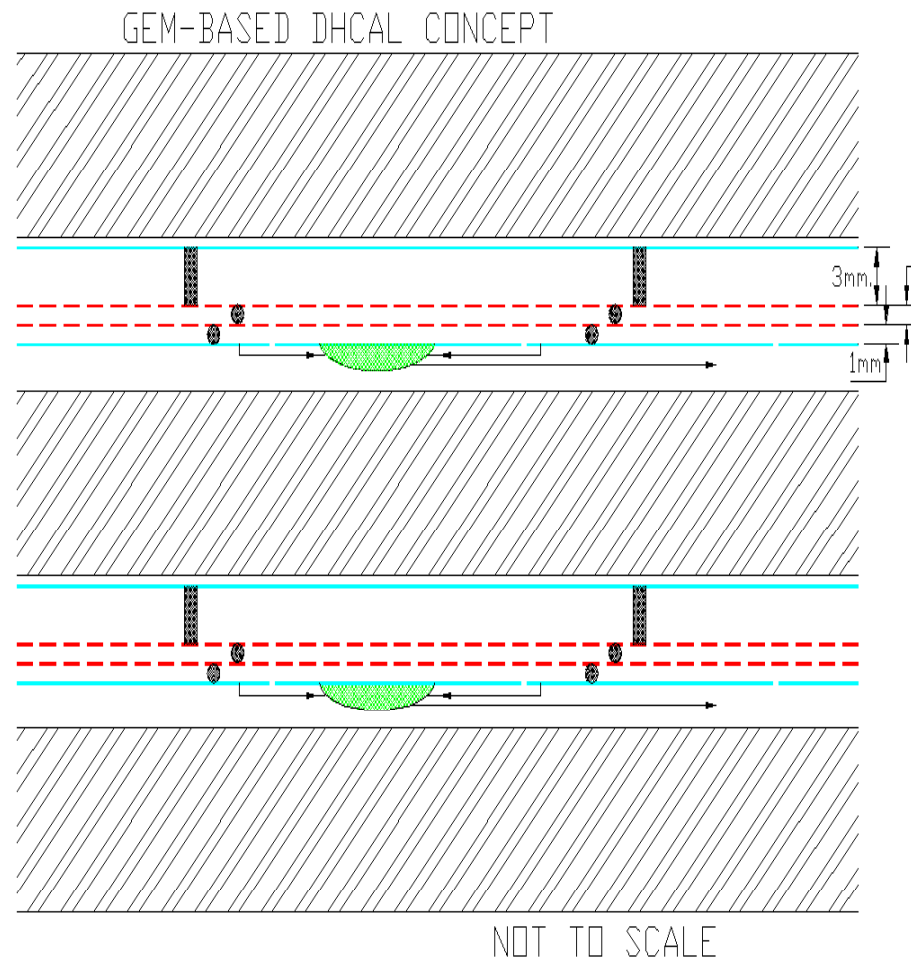

Redesigned chamber - all fishing line spacer

- KPiX anode board with extra electronics protection
- Better/more direct gas flow through ionization gap
- No large dielectric spacer(s)

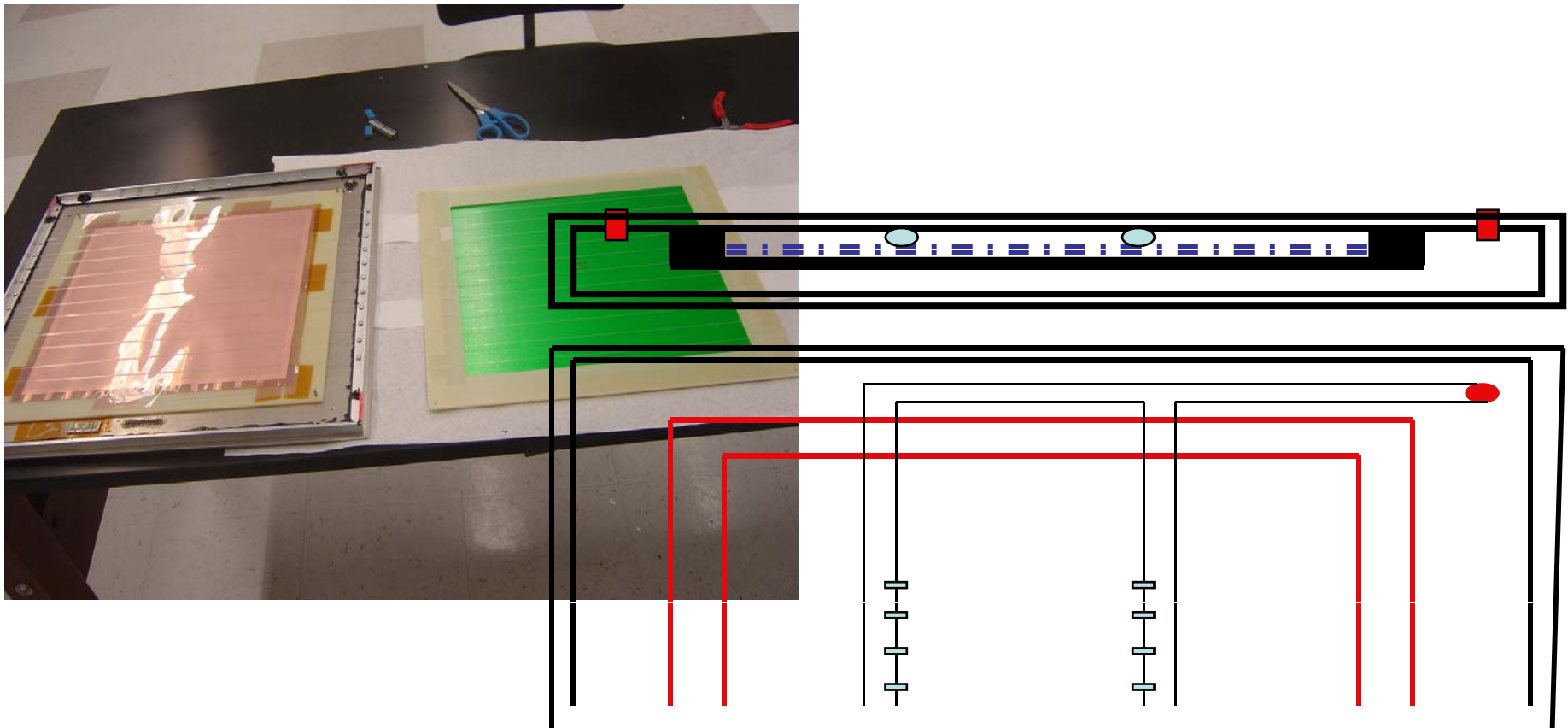

KPiX/GEM/DHCAL

KPiX chip

One channel of 1024

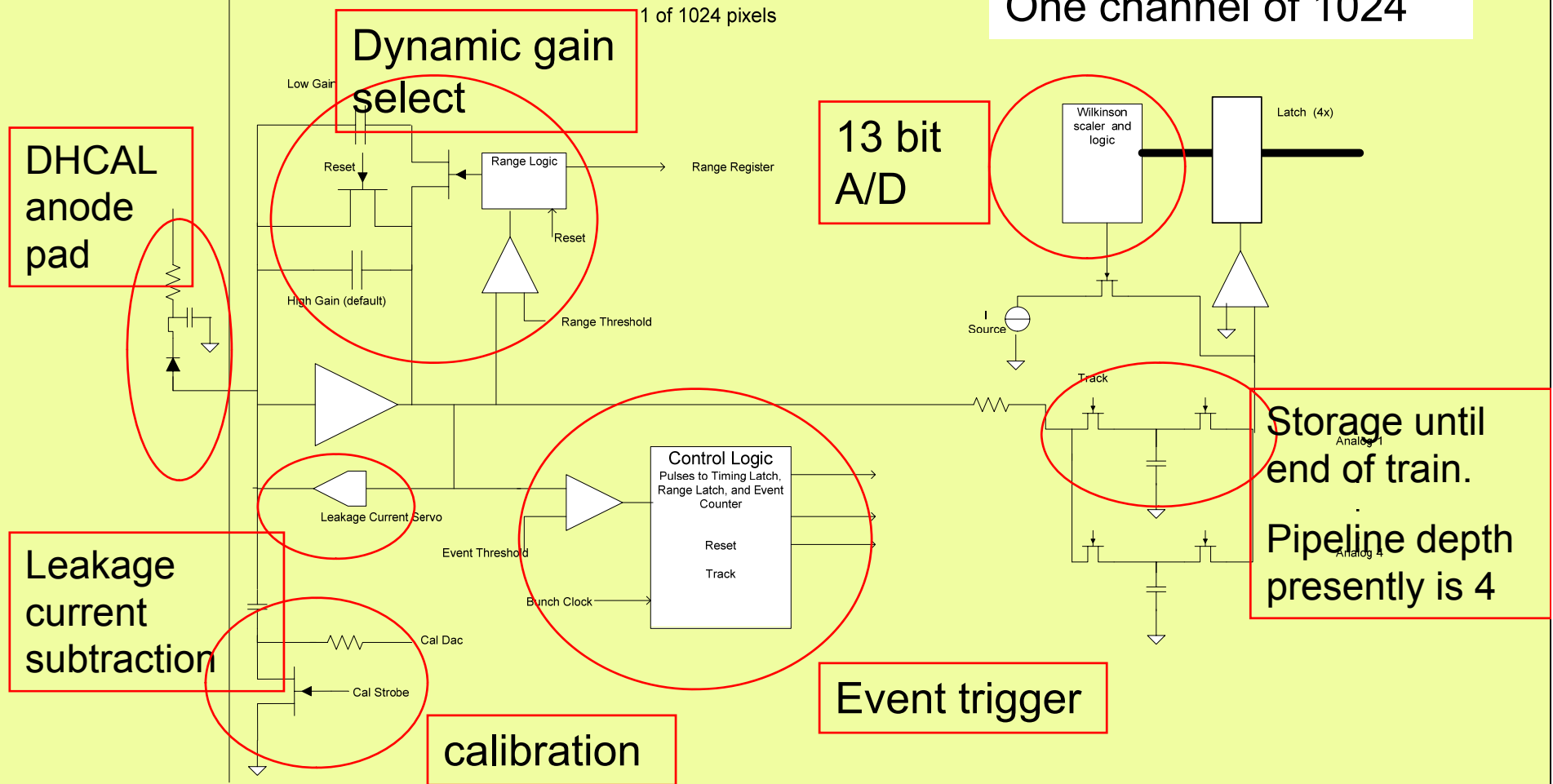

Simplified Timing:

There are ~ 3000 bunches separated by ~300 ns in a train, and trains are separated by ~200 ms.

Say a signal above event threshold happens at bunch n and time T_0 .

The Event discriminator triggers in ~100 ns and removes resets and strobes the Timing Latch (12 bit), range latch (1 bit) and Event Counter (5 bits).

The Range discriminator triggers in ~100 ns if the signal exceeds the Range Threshold.

When the glitch from the Range switch has had time to settle, Track connects the sample capacitor to the amplifier output. (~150 ns)

The Track signal opens the switch isolating the sample capacitor at $T_0 + 1$ micro s. At this time, the amplitude of the signal at T_0 is held on the Sample Capacitor.

Reset is asserted (synced to the bunch clock). Note that the second capacitor is reset at startup and following an event, while the high gain (small) capacitor is reset each bunch crossing (except while processing an event)

The system is ready for another signal in ~1.2 microsec.

After the bunch train, the capacitor charge is measured by a Wilkinson converter.

GEM chamber with KPiX v4 - early 2008

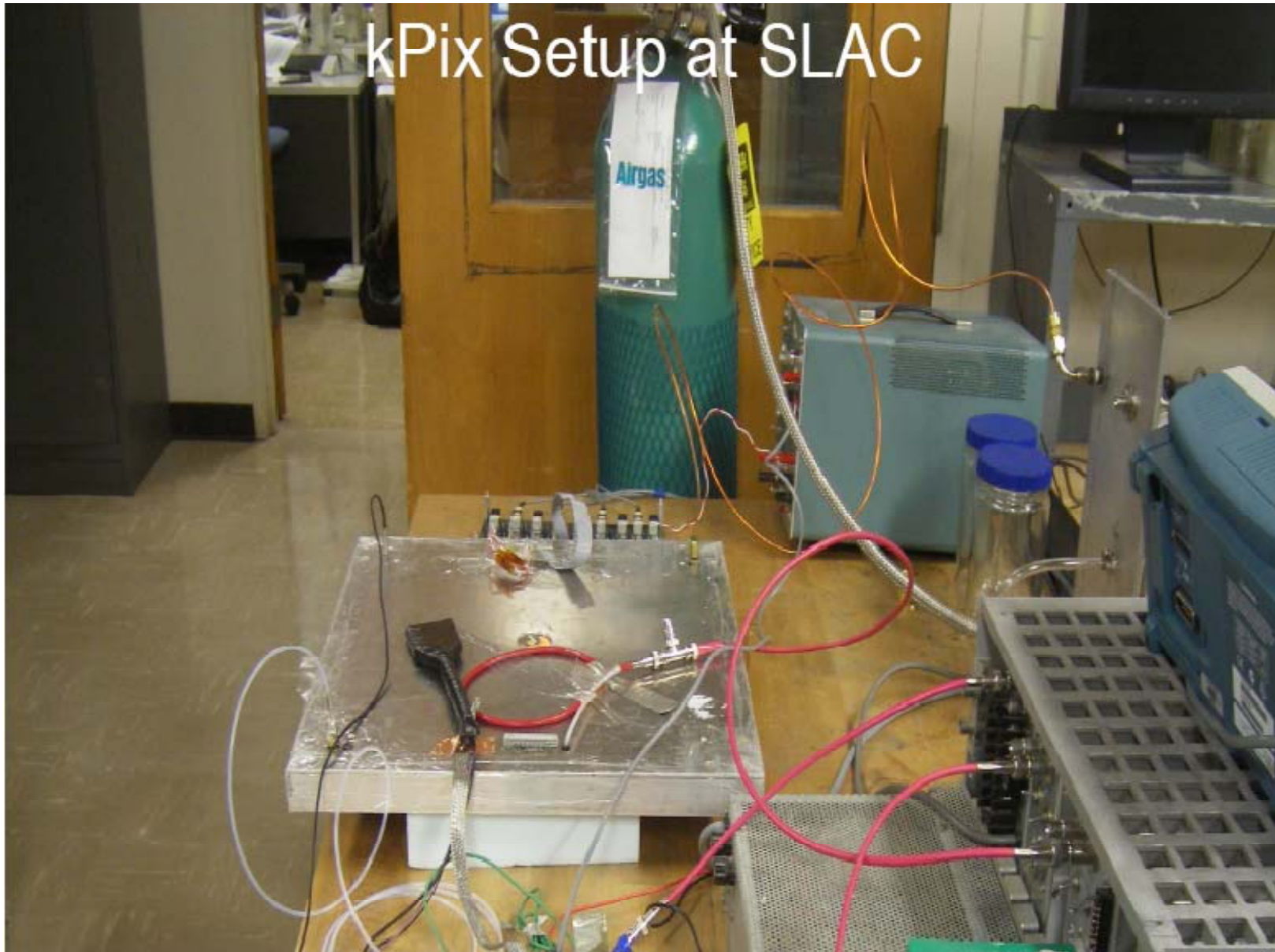

GEM + KPiX long source run at SLAC

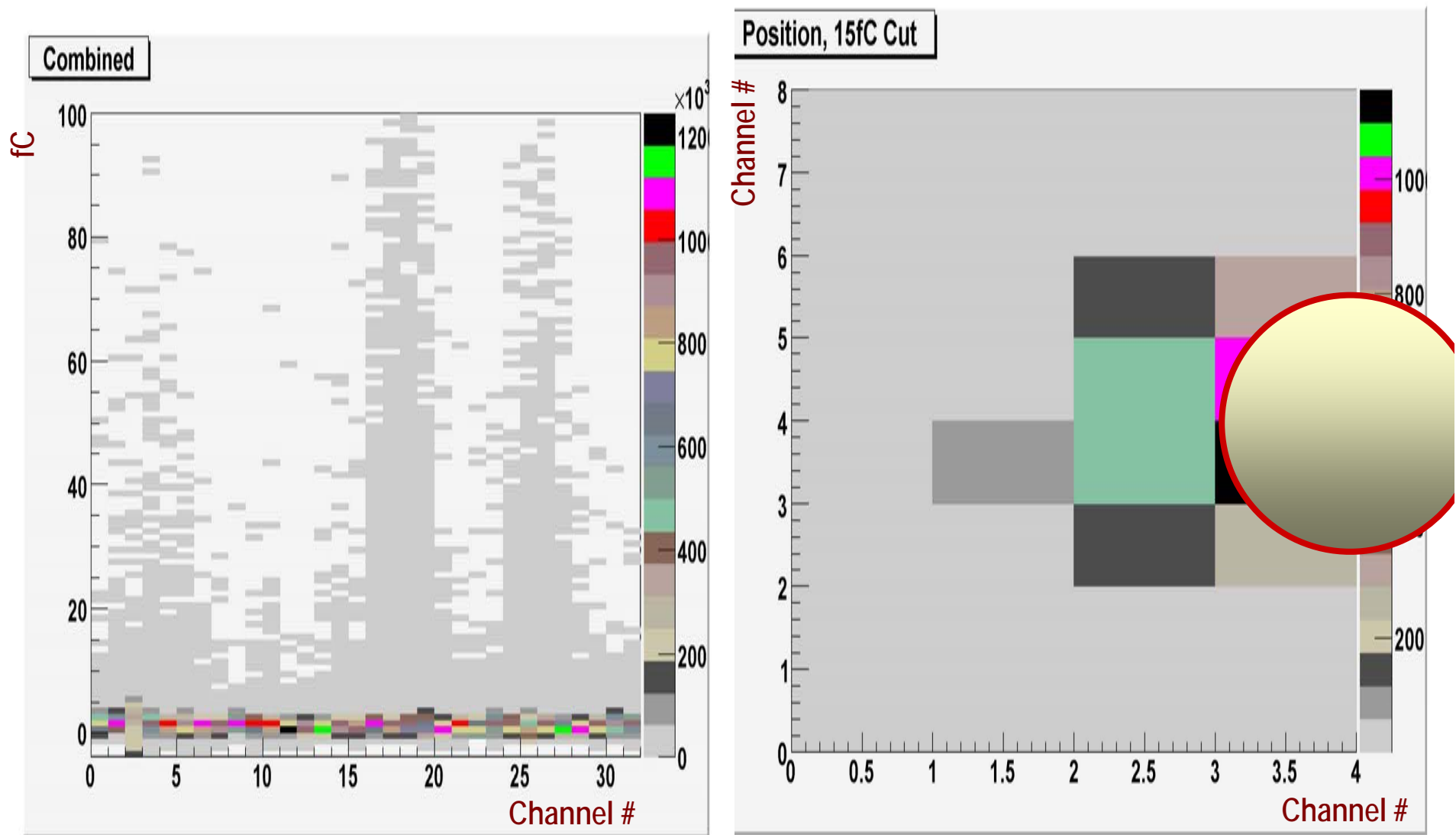

GEM + KPIX response in lab at SLAC

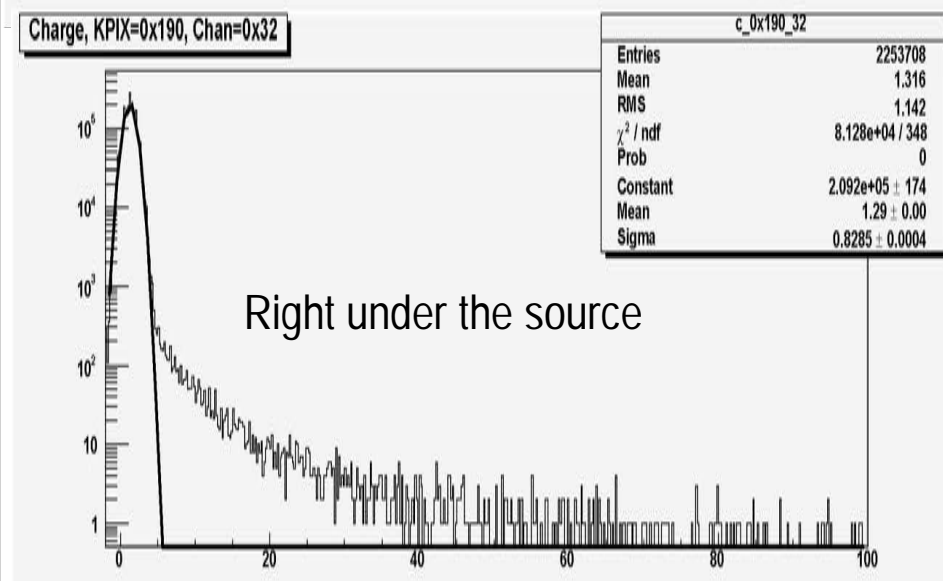
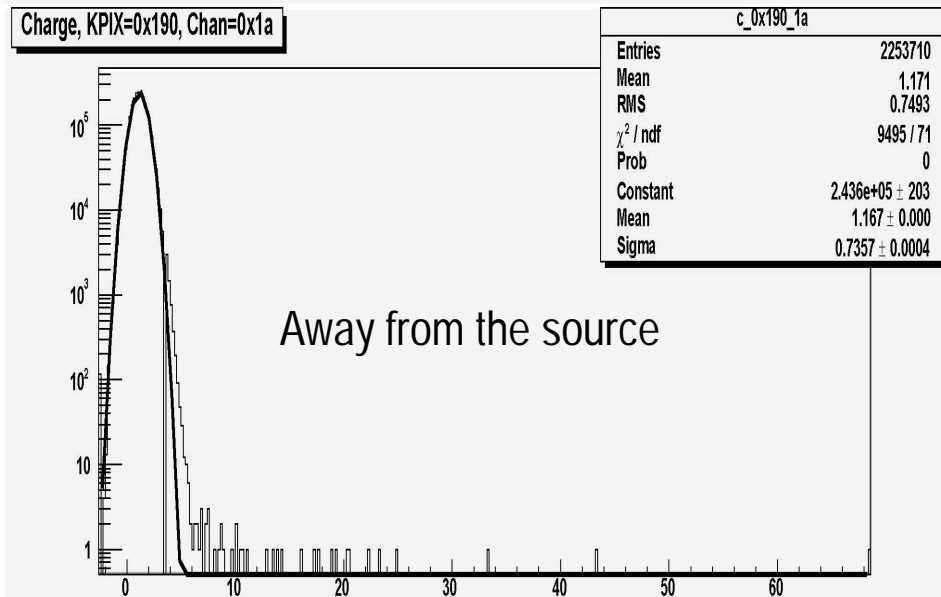
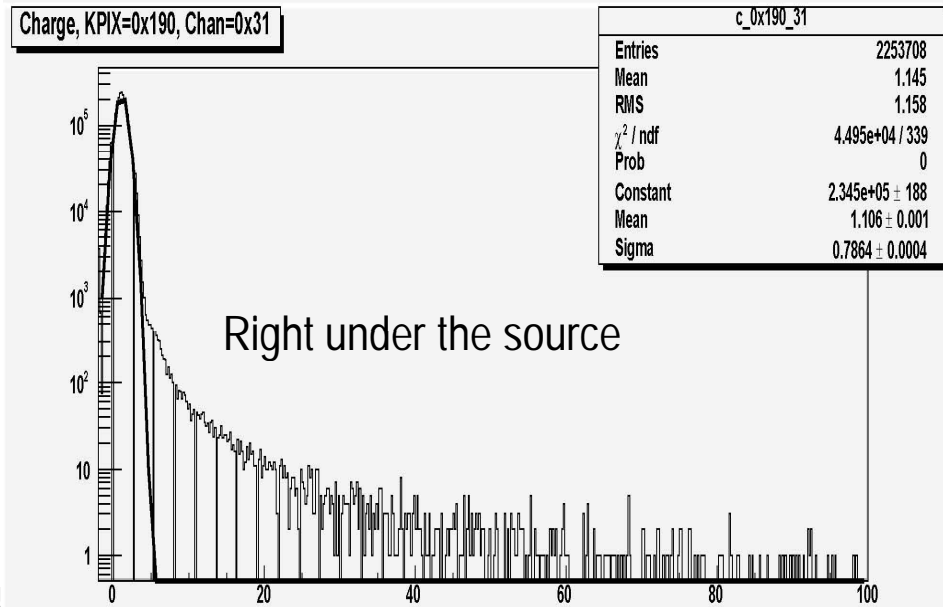
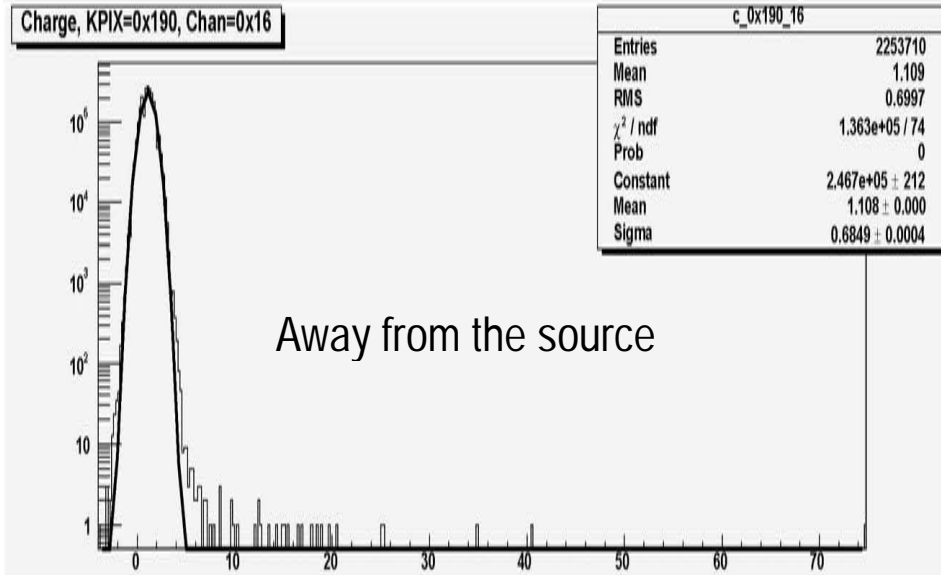

KPiX injected charge calibration

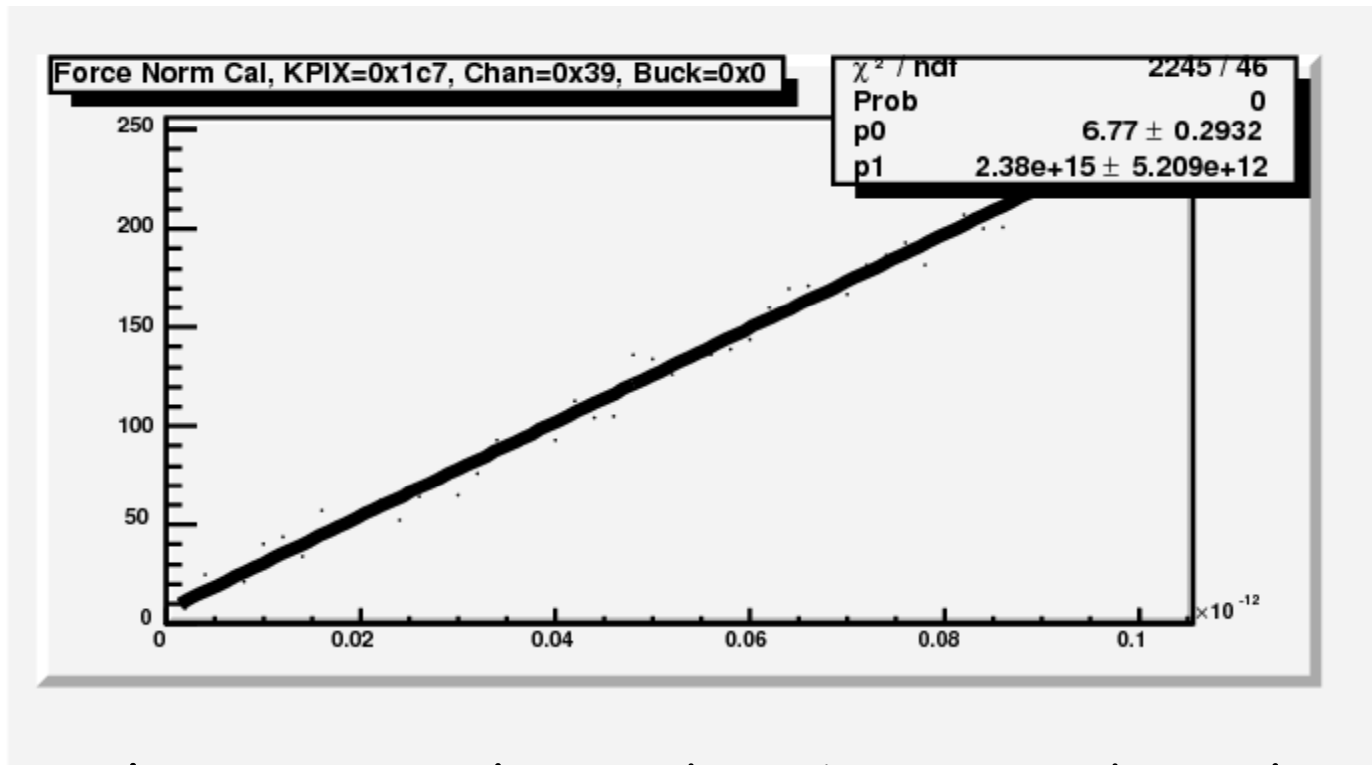

Internal capacitor charged via DAC, readout through data path

-> measure gain from slope

-> measure "zero-injected charge" response, "Y-int"

GEM/KPiX source data taking

- Issue with KPiX v4 triggering mode:
- "forced trigger" (software) mode was used - no fixed time relation between arrival of electron from source and internal timing of KPiX.
- we suspect that a reset is responsible for incomplete integration of the charge
- this would distort MIP (Landau) distribution by lowering ADC values

- also noise peak wider with data than for pedestal runs
-> working on understanding this effect.

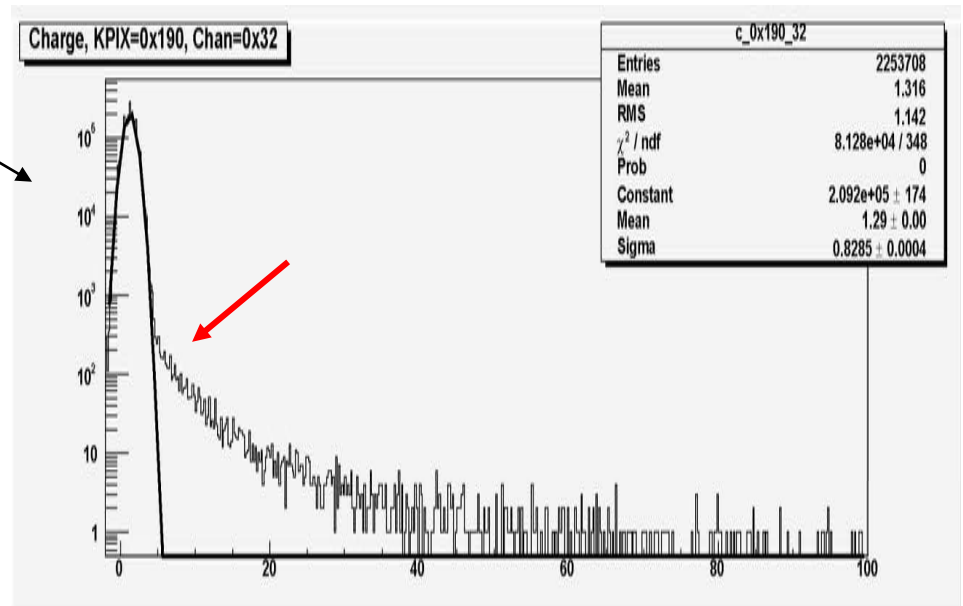

KPiX v7 chamber plans

- New v7 chamber works well - stable (no trips) over several weeks so far.
- Operate v7 with new GEM chamber (in progress)
- Complete calibration/understand behavior with v7
- Take beam data at MTBF, CERN(?)

GEM/DHCAL future development

- Plans for 1m x 33cm GEM chamber using CERN foils
- Investigating Thick GEM and RETGEM alternatives
- Build 1m² planes as part of 1m³ stack

Towards an IRL for the Scint. HCAL

Vishnu Zutshi
for
NIU/NICADD



HCAL 'Wedge'

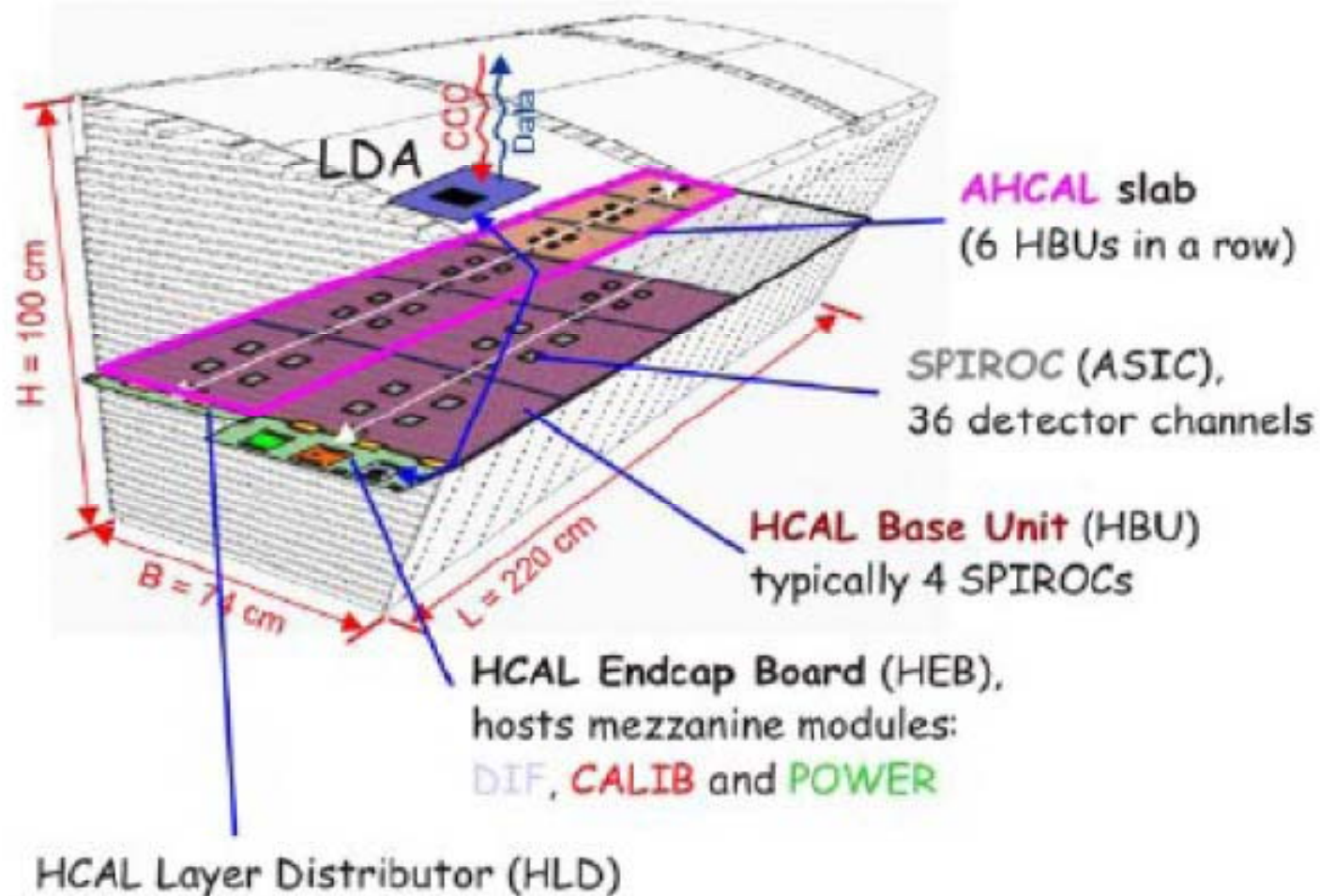

Direct Coupling



Adequate
Uniformity

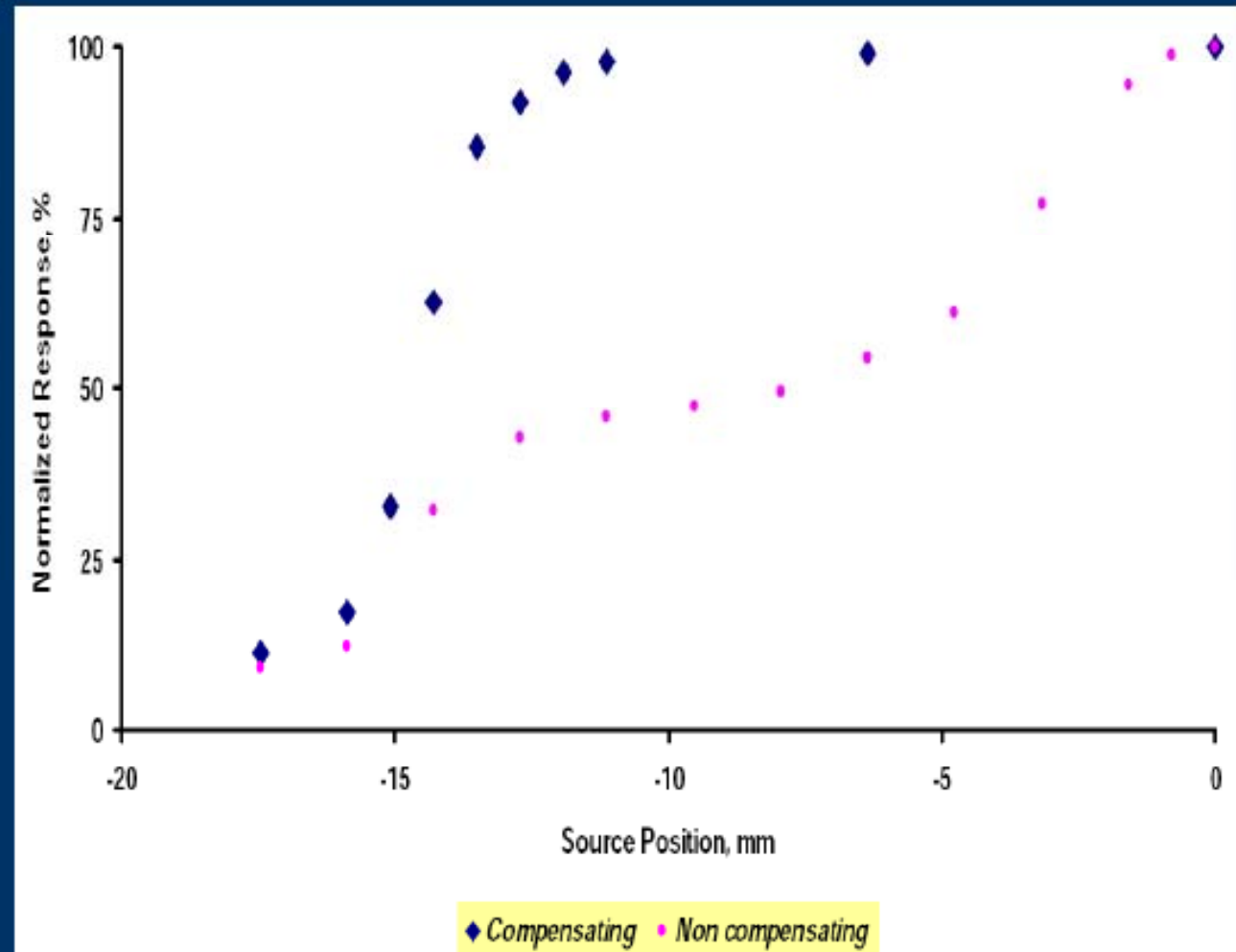

HCal planning for the LOI

1. Definition of subsystem/subgroup
 - 1.1 Name of the subsystem
 - 1.2 Contact person(s) for LOI writing (!very important !)
 - 1.3 Geometrical definition: Where it is located. Dimensions
 - 1.4 Function
 - 1.5 Requirements/specifications
 - Typical physics benchmark(s) that your system is most relevant.

2. Description of the subsystem
 - 2.1 Concept
 - 2.2 Baseline design
 - 2.3 Expected performance
 - 2.4 Illustrations/Drawings that you *definitely* want to include in LOI
 - 2.5 Options

3. R&D roadmap
 - 3.1 Issues
 - 3.2 Milestones (Before 2012, and after 2012)
 - 3.3 Resources needed

4. Cost estimation

5. Q&A : anticipated questions from IDAG and answers to them.

Additional Questions from IDAG (Draft)

June 22, 2008

IDAG wishes the proponents of the 3 LOI's to address the following points in their LOI document:

- Sensitivity of different detector components to **machine background** as characterized in the MDI panel.
- **Calibration and alignment schemes.**
- **Status of an engineering model** describing the support structures and the dead zones in the detector simulation
- Plans for getting the necessary R&D results to transform the design concept into a well-defined detector proposal.
- Push-pull ability with respect to technical aspects (assembly areas needed, detector transport and connections) and maintaining the detector performance for a stable and time-efficient operation.
- A short statement about the **energy coverage**, identifying the deterioration of the performances when going to energies higher than 500 GeV and the considered possible detector upgrades.
- **How was the detector optimized:** for example the identification of the major parameters which drive the total detector cost and its sensitivity to variations of these parameters.

Subsystem issues

- Definition of subsystem/subgroup
Hadron calorimeter, barrel and endcaps
- Name of subsystem: HCal
- Contact persons for LOI writing:
 - Overall: Andy White, Harry Weerts
 - Technologies:
 - Jose Repond(RPC),
 - Yannis Karyotakis(Micromegas),
 - Andy White(GEM),
 - Vishnu Zutshi(Scint/SiPM)??,
 - Adam Para(Dual readout calorimetry)??
- Geometrical definition
 - Table of (r,z) values, XML file(s)

Subsystem issues

Requirements - Overall:

- It must **efficiently allow tracking of charged particles** through its volume.
- It must have **sufficient depth** such that any energy loss in the coil, and/or energy measured with degraded resolution (relative to the HCal) in the outer detectors (such as a TCMT) does not significantly impact jet energy resolutions at all jet energies.
- It must have a **sufficiently small cell size** to allow true separation and association of closely spaced energy clusters with the correct tracks - at a level that does not significantly degrade the jet energy resolution.
- It must have a **sufficient sampling** so as not to significantly degrade the jet energy resolution via the sampling term.
- Its outer radius must **limit the cost of the solenoid and muon system** to reasonable levels - requiring the radial size of each active layer to be as small as possible.
- It must have **sufficient rate capability** so as not to lose information, particularly in the forward directions - using a change of technology, if necessary.

Subsystem issues

Performance requirements, pointers to physics benchmarks

Single $e^\pm, \mu^\pm, \pi^\pm, \pi^0, K^\pm, K_s^0, \gamma, W, Z; 0 < |\cos\theta| < 1, 0 < p < 500$ GeV

$e^+e^- \rightarrow Zh, h \rightarrow b\bar{b}, c\bar{c}, gg, \tau^+\tau^-, WW^*, \gamma\gamma, \mu^+\mu^-, m_h = 120$ GeV at $\sqrt{s}=0.25$ TeV;

$e^+e^- \rightarrow \tilde{\chi}_1^+ \tilde{\chi}_1^- / \tilde{\chi}_2^0 \tilde{\chi}_2^0$ at Point 5 at $\sqrt{s}=0.5$ TeV;

ttbar

Description of the subsystem

Concept:

Highly segmented (longitudinally and transversely) digital(?) calorimeter system providing tracking/cluster determination for use with PFA, and of sufficient depth to contain high energy hadron showers.

Baseline design:

Gas-based (RPC) with steel plates.

Expected performance:

-> give a) standalone calorimeter performance on single particles (charged and neutral)/jets, b) PFA jet energy, di-jet mass resolution, + what we expect for the LOI benchmark processes.

-> Hard to talk about HCal in isolation - need to coordinate LOI sections with other subsystems in the PFA context.

Description of the subsystem

Illustrations/drawings:

- > overall location of HCal in Sid
- > r-phi view of the simulation version of HCal
- > non-projective crack engineering design option(s)

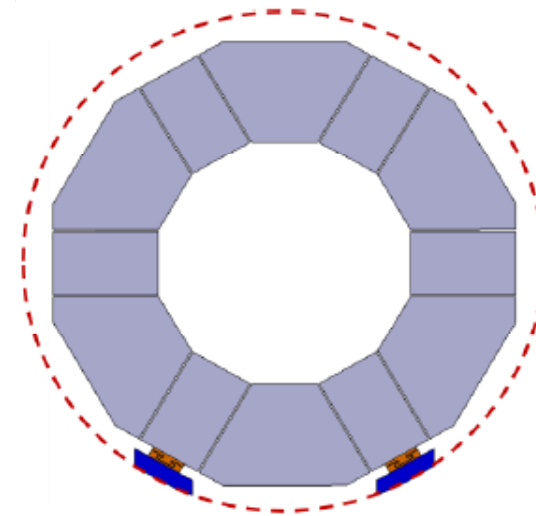
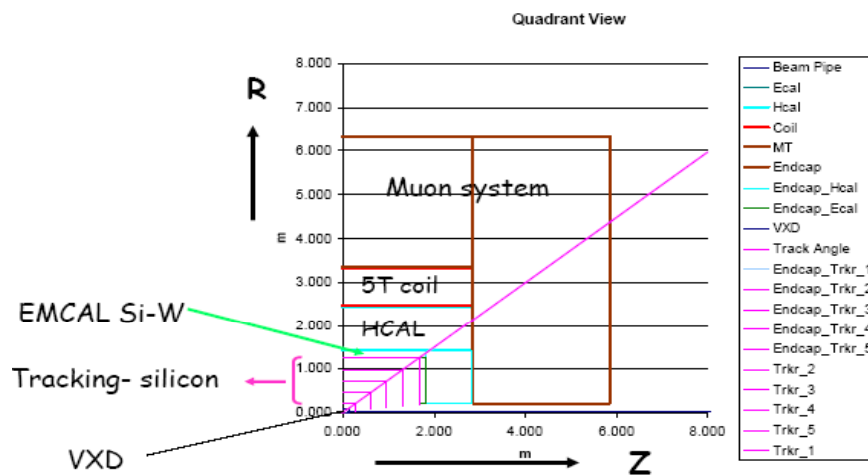

Options:

subsections on GEM, micromegas, Scint/SiPM, Compensating cal.
with descriptions of strengths, plus/minus,...

Subsystem issues

Performance criteria:

- 1) MIP Efficiency/pad
- 2) Hit multiplicity/MIP
- 3) Uniformity of response across active layers
- 4) Need for or ease of calibration
- 5) Recovery time after hit(s)
- 6) Recovery time after a "significant beam event"
- 7) Rate of discharges (gas)
- 8) Track-cluster separability
- 9) PFA jet resolution at a) Z-pole, b) 250, 500, 1000 GeV
- 10) Magnetic field issues - signal location offsets in barrel and endcaps (gas)
- 11) Response to neutrons



Need to discuss physics benchmarks that are "most relevant" for the HCal.

Subsystem issues

Technology issues:

- 1) Maturity and previous history
- 2) Reliability
- 3) Availability of components (in quantity)
- 4) Active layer thickness
- 5) Smallest readout unit size
- 6) Technical risk of approach
- 7) Ease of assembly/testing/installation/commissioning (often referred to as "scalability").
- 8) Effects of aging on performance

->> We will use a standard layout for the technology baseline and options sections.

R&D roadmap

Issues:

need a subsection for each technology option discussing what needs to be understood, developed, tested etc. with respect

Milestones:

a) Before 2012: "Advance critical R&D": large plane development and testing for all technologies, 1m³ construction and testing,

b) After 2012: Technical prototypes for SiD (as opposed to detector prototypes)

Resources needed:

Funding, people, test beams, lab space, ...

Estimated construction schedule

- > Time table - all technology choices are consistent with a 6-year construction schedule.
- > Required human resources - from Marty's WBS structure

Cost

Cost:

- 1) Overall HCal cost
- 2) Active layer cost as a percentage of total cost
- 3) System development costs
- 4) Costs for assembly and tests

Organization of the HCal subsystem

Overall: Andy White, Harry Weerts

Technologies:

Jose Repond(RPC),

Yannis Karyotakis(Micromegas),

Andy White(GEM),

Vishnu Zutshi(Scint/SiPM)??

Adam Para(Dual readout calorimetry)??