

CLIC detector, difference with the ILC case

Lucie Linssen
CERN

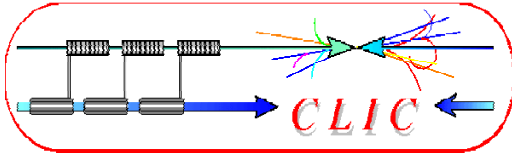

Outline and useful links



Outline:

- The CLIC accelerator
- CLIC detector issues \leq difference with ILC case
 - CLIC machine background conditions and detector consequences
 - Requirements for calorimetry
 - Requirements for tracking
- Outlook

Useful links:

- CLIC website:
 - <http://clic-study.web.cern.ch/CLIC-Study/>
- CLIC07 workshop, October 2007
 - <http://cern.ch/CLIC07Workshop>
- **CLIC08 workshop, October 14-17 2008**
 - <http://project-clic08-workshop.web.cern.ch/project-clic08-workshop/>

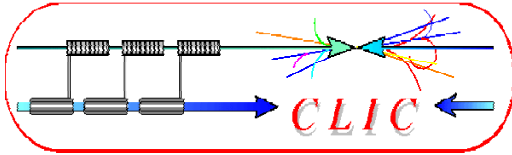

A bit of history



1985: **CLIC = CERN Linear Collider**

CLIC Note 1: “Some implications for future accelerators” by J.D. Lawson => first CLIC Note

1995: **CLIC = Compact Linear Collider**

=> 6 Linear colliders studies (TESLA, SBLC, JLC, NLC, VLEPP, CLIC)

2004: **International Technology recommendation panel selects the Superconducting RF technology**

CERN council supports CLIC R&D to demonstrate the key feasibility before 2010

=> 2 Linear colliders studies (ILC and CLIC)

2006: **CERN council Strategy group (Lisbon July 2006) => “... a coordinated programme should be intensified to develop the CLIC technology ...”**

2007: **Major parameters changes: 30 GHz => 12 GHz and 150 MV/m => 100 MV/m**
First CLIC workshop in October

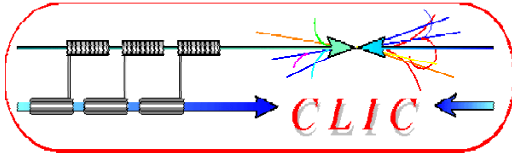

CLIC base-line



CLIC = **C**ompact **L**inear **C**ollider
(length < 50 km)

Electron-Positron Collider

- Centre-of-mass-energy: 0.5 - 3 TeV

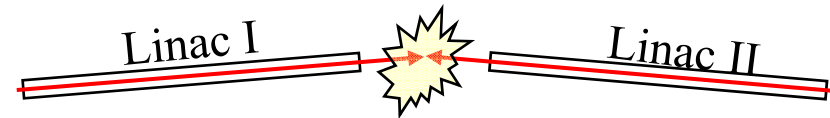

Present R&D proceeds with following requirements:

- *Luminosity* $L >$ few $10^{34} \text{ cm}^{-2} \text{ s}^{-1}$ with acceptable background and energy spread
- Design should be compatible with a maximum *length* ~ **50 km**
- Total power consumption < **500 MW**
(cf LEP@100 GeV => 237 MW)
- Affordable (CHF, €, \$,.....)

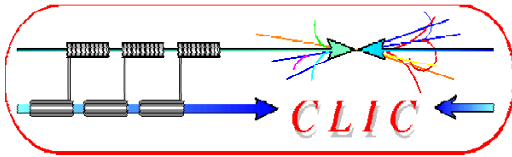

Major parameters for Linear Collider



Energy reach

$$E_{cm} = 2 F_{fill} L_{linac} G_{RF}$$

Labels: Filling factor, Linac length, Gradient

Luminosity

$$L = \frac{k_b N_b^2 f_{rep}}{4 \pi \sigma_x^* \sigma_y^*} \alpha \frac{\delta_B^{1/2} P_{AC} \eta_{beam}^{AC}}{E_{cm} \epsilon_{ny}^{1/2}}$$

Labels: Energy lost by beamstrahlung, Wall-plug power, Wall-plug to beam efficiency, Beam size at interaction point, Center-of-mass energy, Vertical emittance

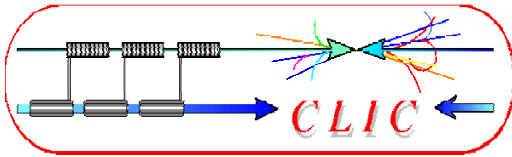

The CLIC Two Beam Scheme



Two Beam Scheme:

Drive Beam supplies RF power

- 12 GHz bunch structure
- low energy (2.4 GeV - 240 MeV)
- high current (100A)

Main beam for physics

- high energy (9 GeV – 1.5 TeV)
- current 1.2 A

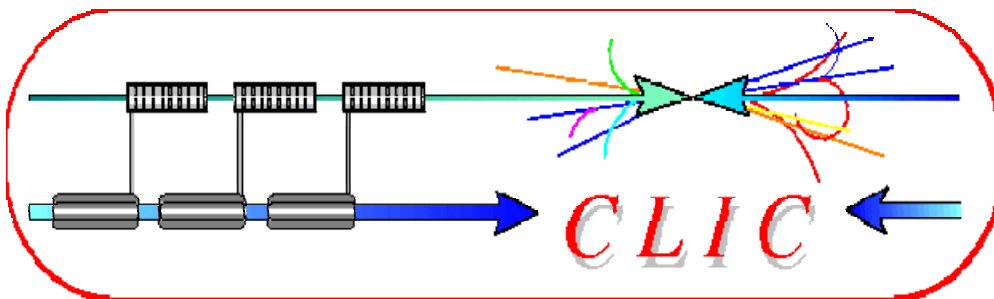
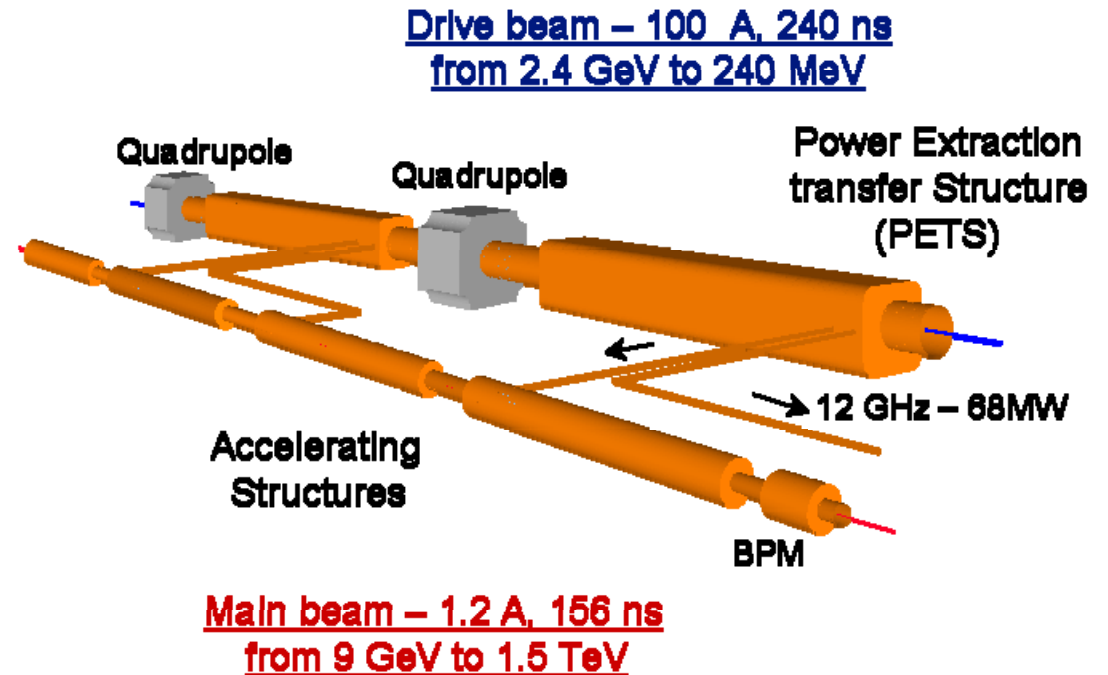

No individual RF power sources

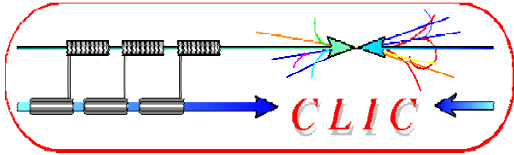

CLIC acceleration system



CLIC parameters:

Accelerating gradient: 100 MV/m

RF frequency: 12 GHz

Basic accelerating structure
of 0.233m active length

total active length for 1.5 TeV: **15'000 m**

Pulse length 240 ns, 50 Hz

Acceleration in travelling wave structures:

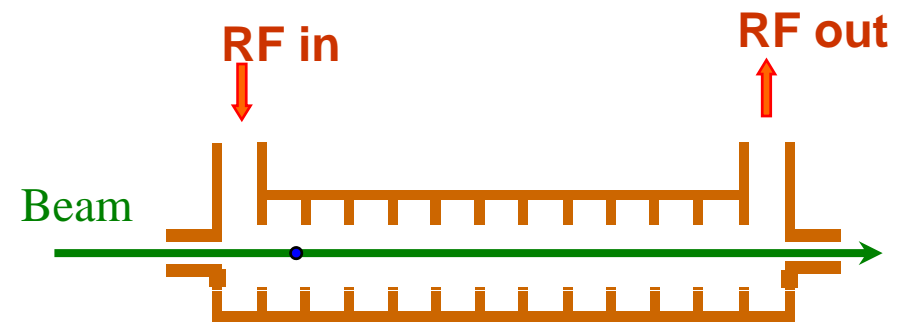

Efficient RF power production !

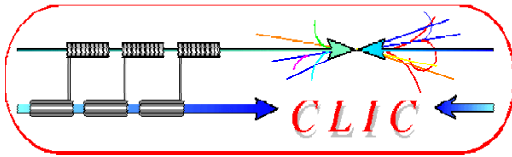

The full CLIC scheme

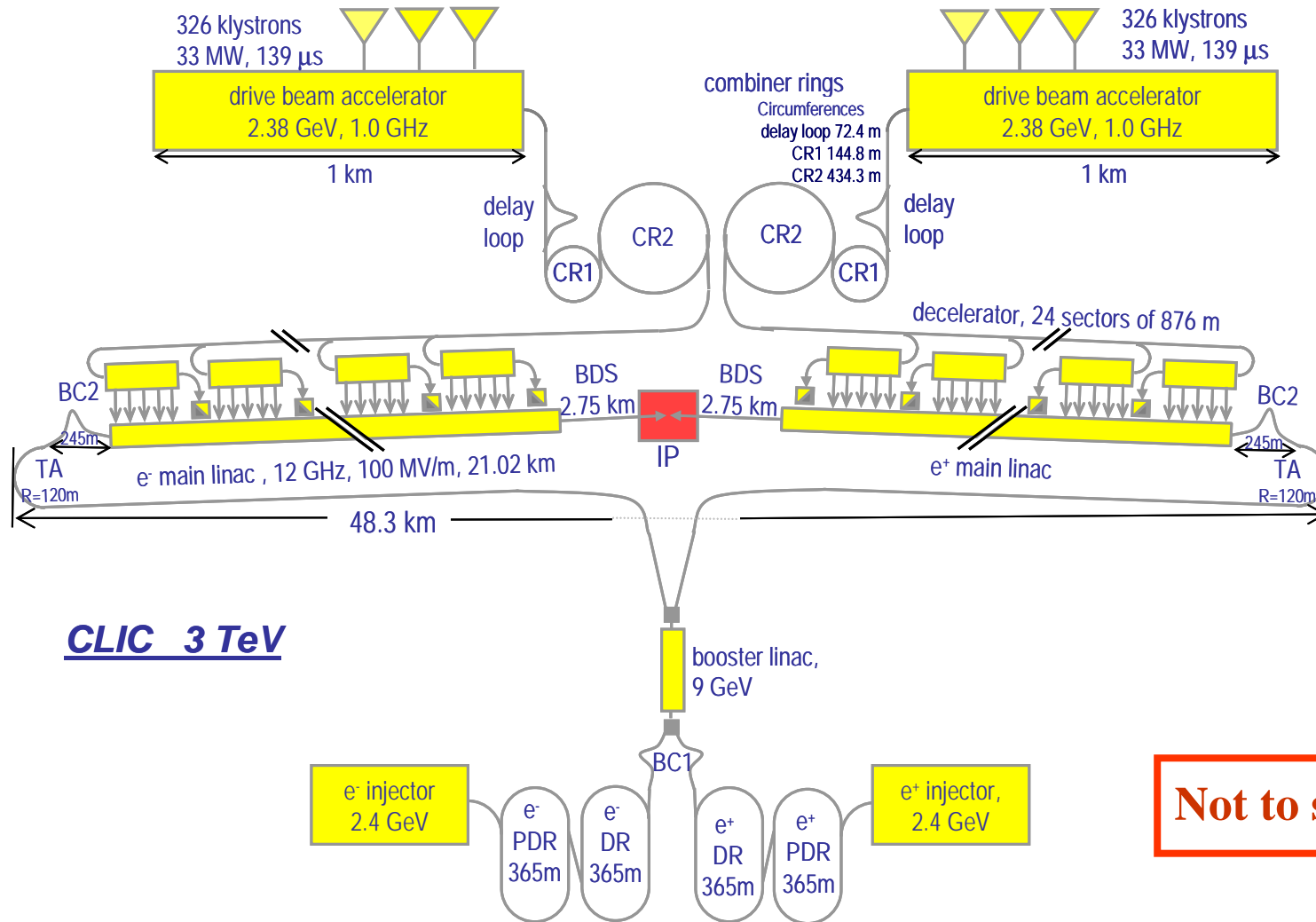

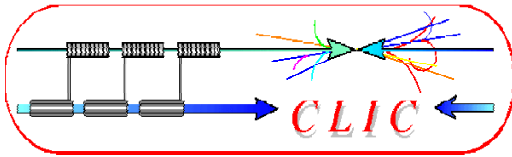

RF power source



Drive Beam Accelerator

efficient acceleration in fully loaded linac



Delay loop $\times 2$

gap creation, pulse
compression & frequency
multiplication

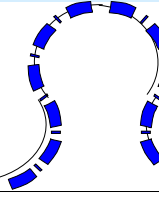

Transverse RF
Deflectors

Combiner ring $\times 3$

pulse compression &
frequency multiplication

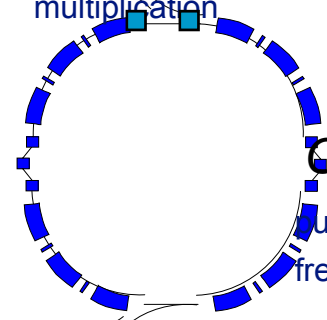

Combiner ring $\times 4$

pulse compression &
frequency multiplication

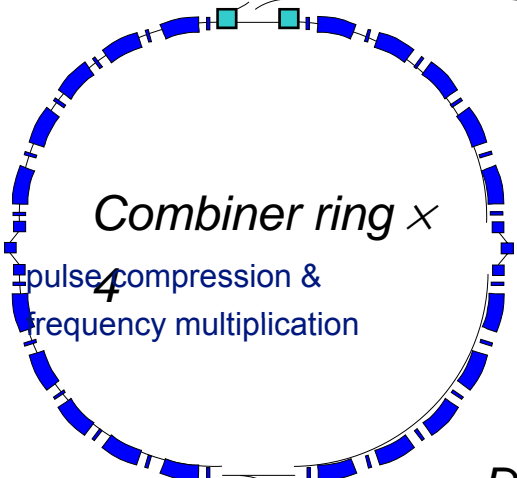

Drive Beam Decelerator Sector (24 in total)

Power Extraction

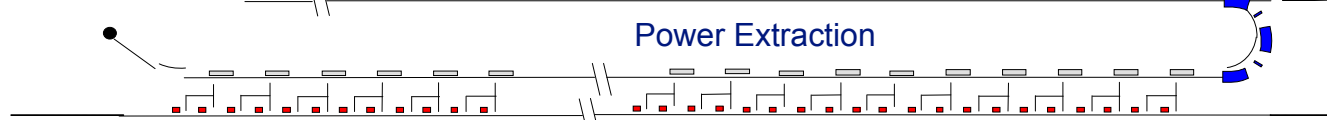

Drive beam time structure - initial

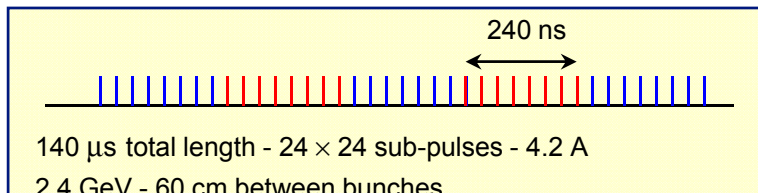

Drive beam time structure - final

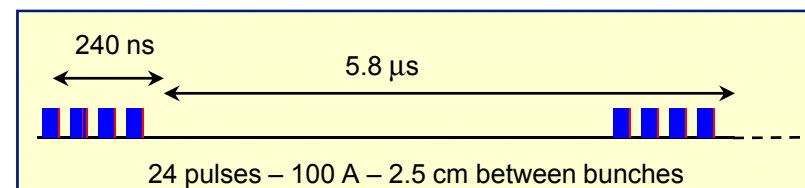

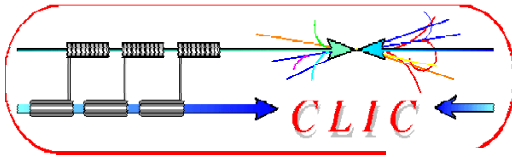

CLIC two-beam module

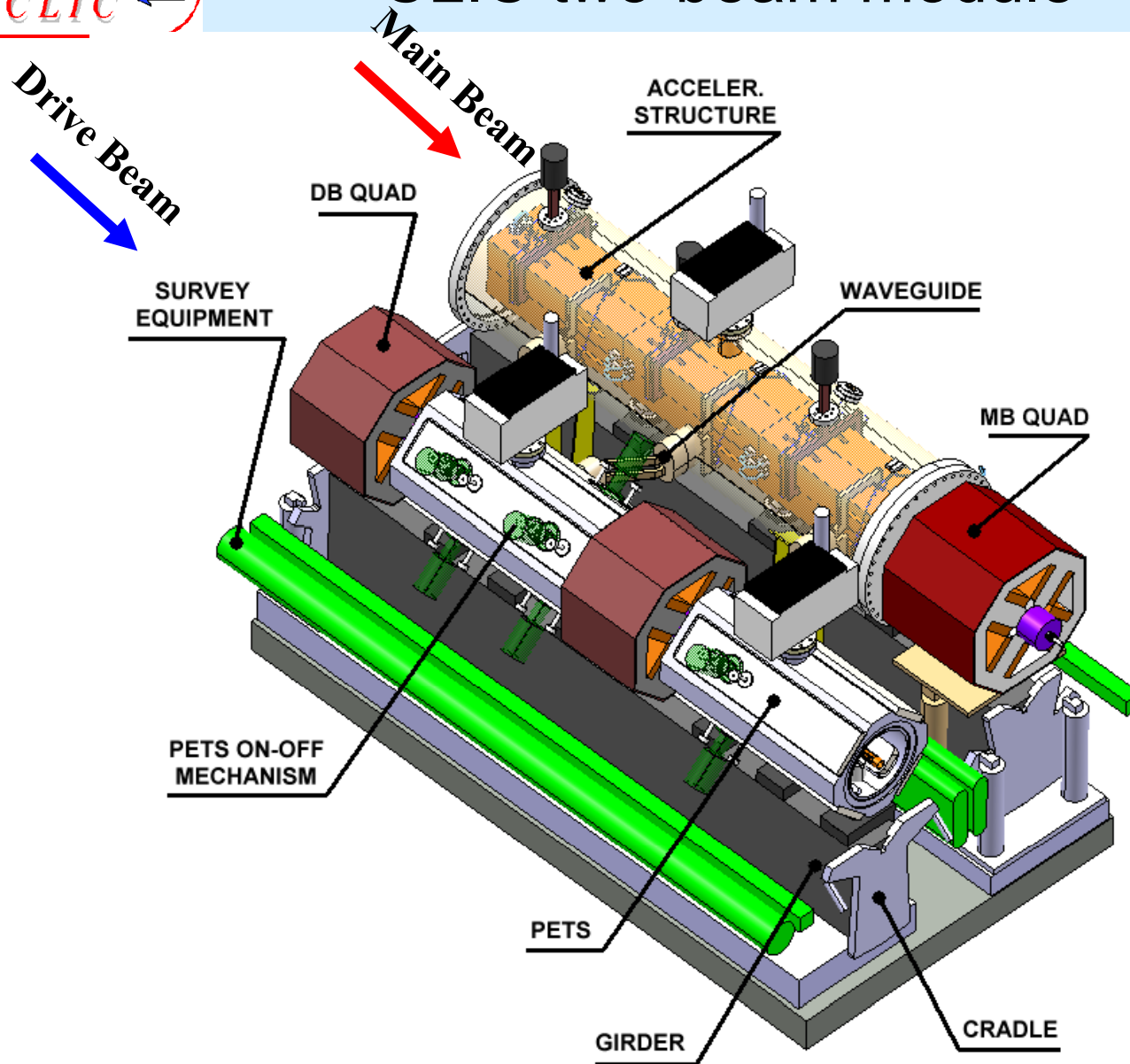

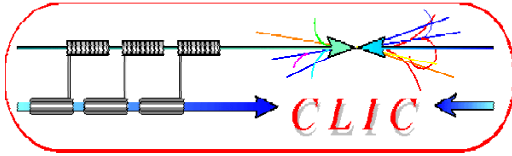

Main beam accelerating structures



Objective:

- Withstand of 100 MV/m without damage
- breakdown rate $< 10^{-7}$
- Strong damping of HOMs

Technologies:

Brazed disks - milled quadrants

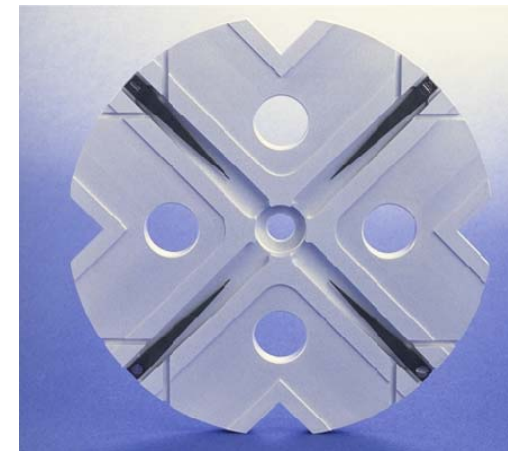
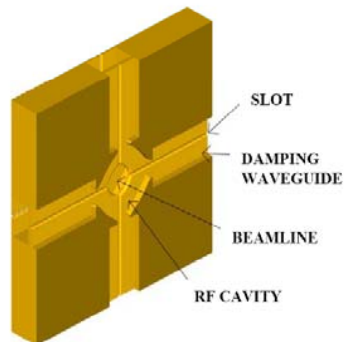
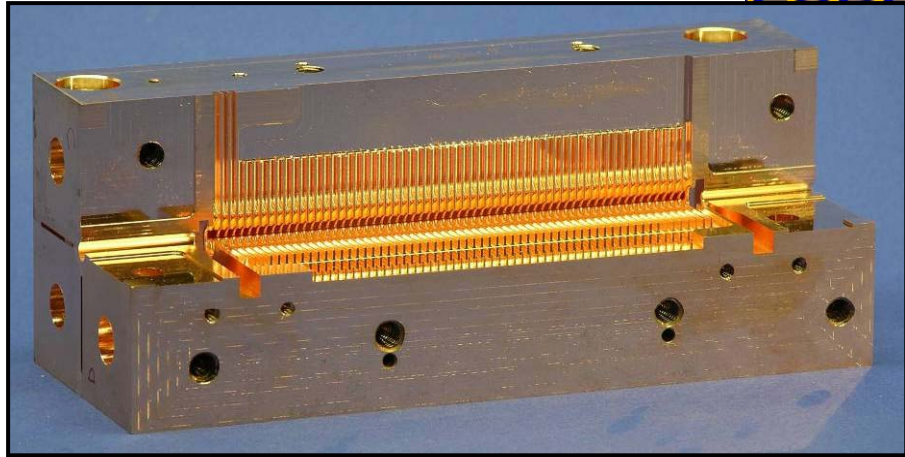

Collaboration: CERN, KEK, SLAC

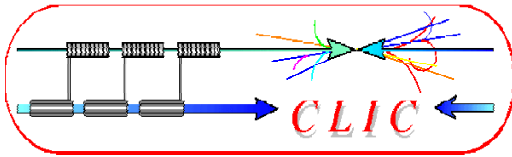

Best result so far



High Power test of T18_VG2.4_disk

- Designed at CERN,
- Machined by KEK,
- Brazed and tested at SLAC

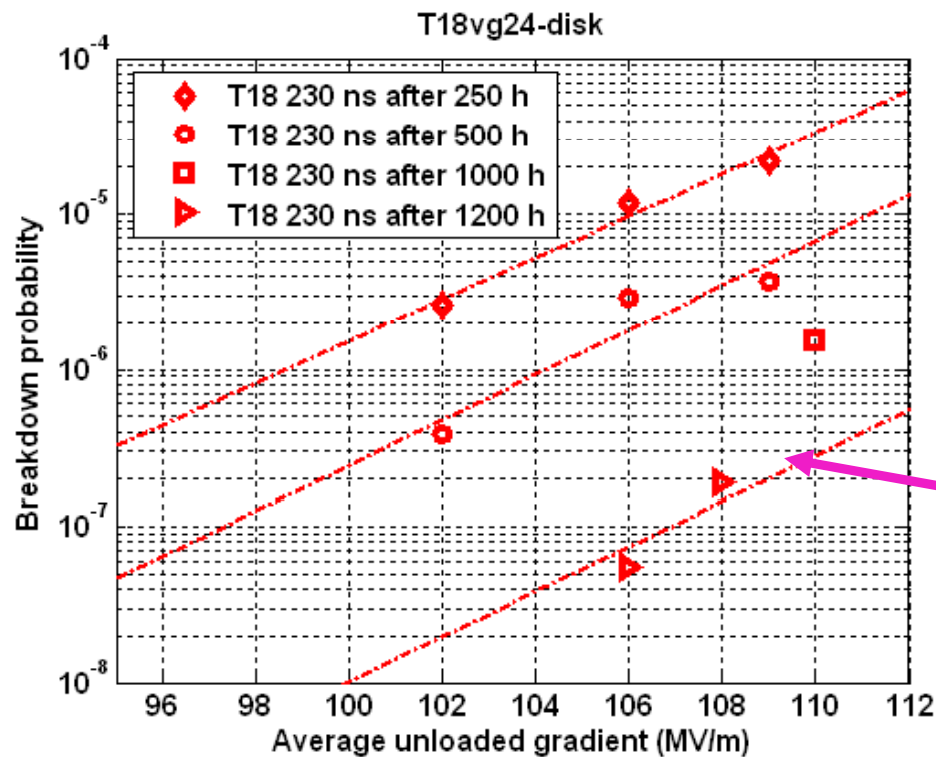

Improvement by
RF conditioning

CLIC
target

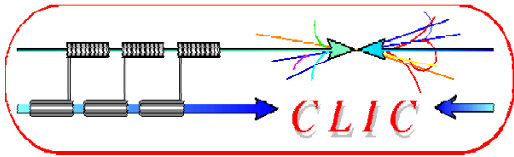

CLIC test facility



CTF3 building blocks

Infrastructure from LEP

PULSE COMPRESSION
FREQUENCY MULTIPLICATION

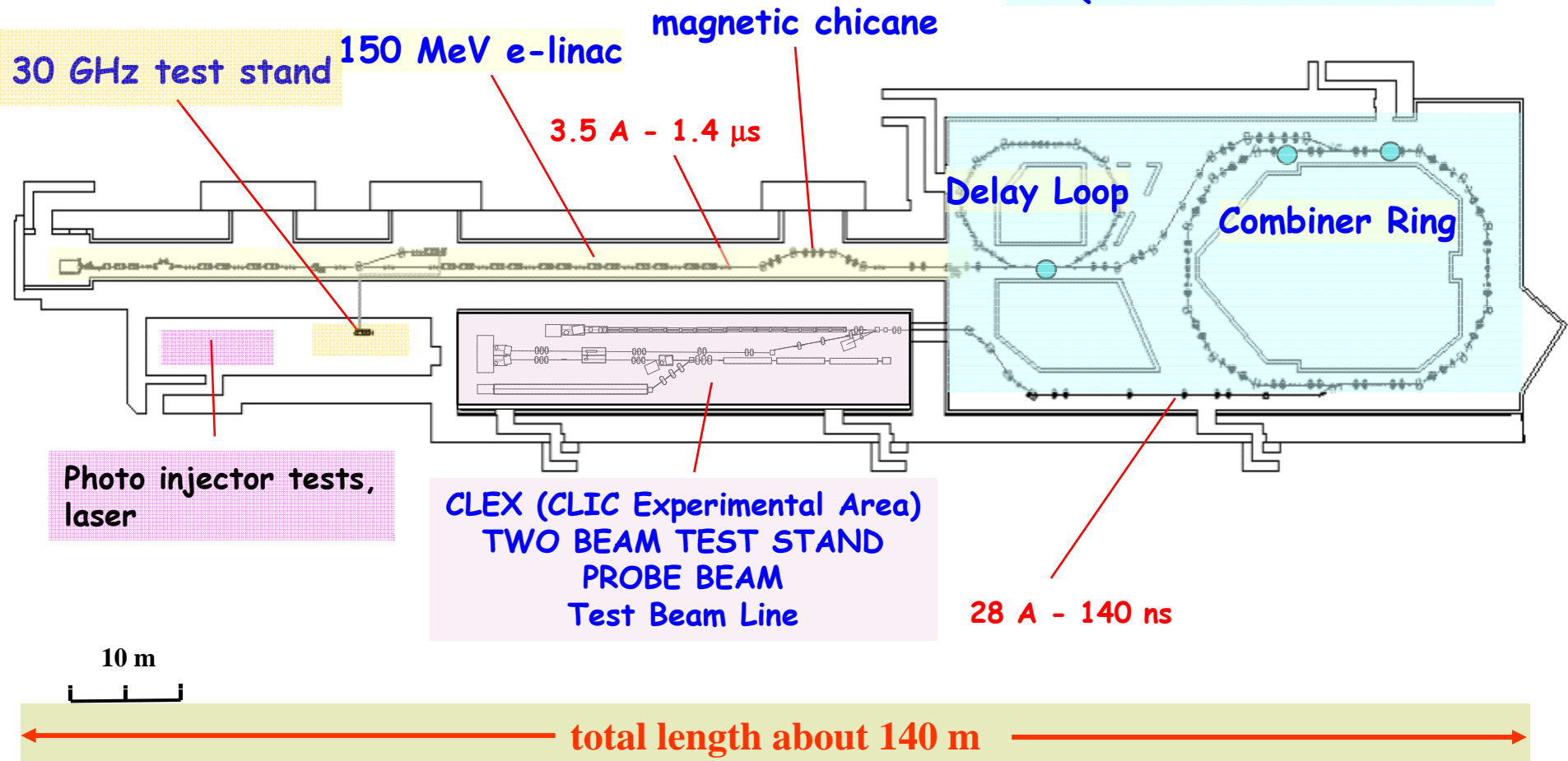

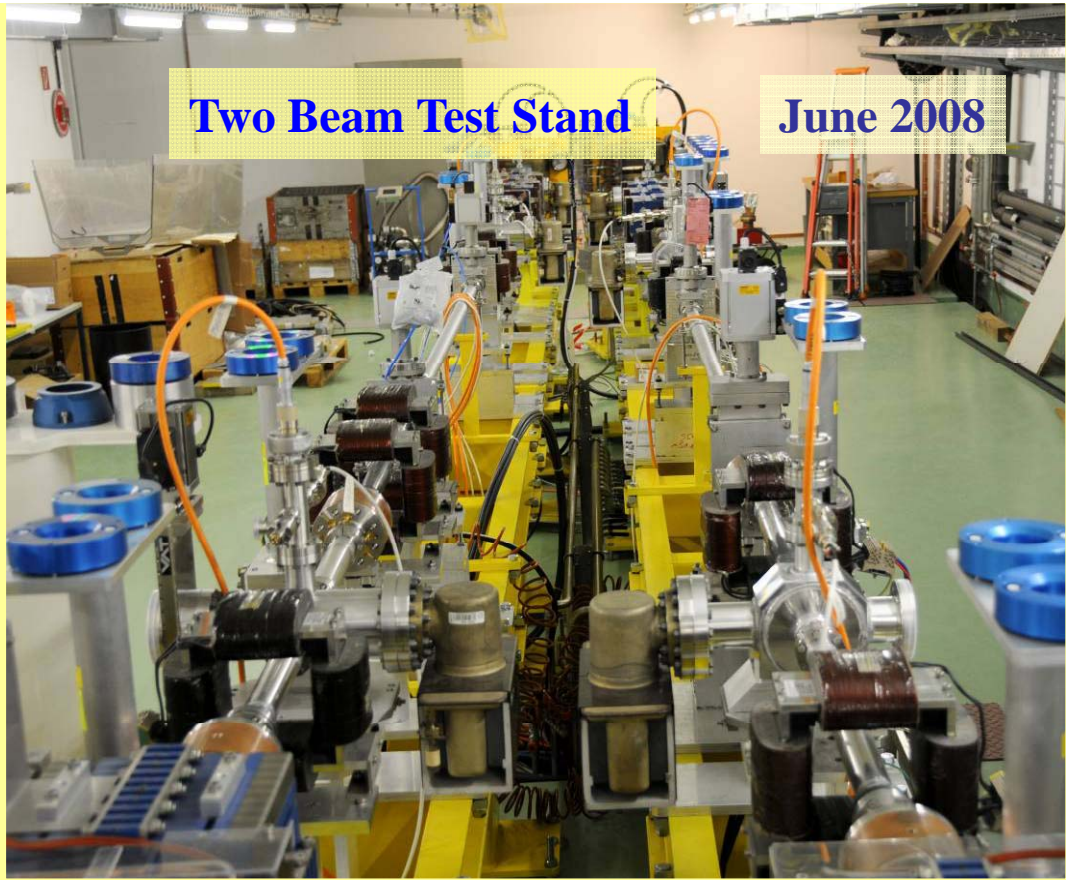

Two Beam Test Stand

June 2008

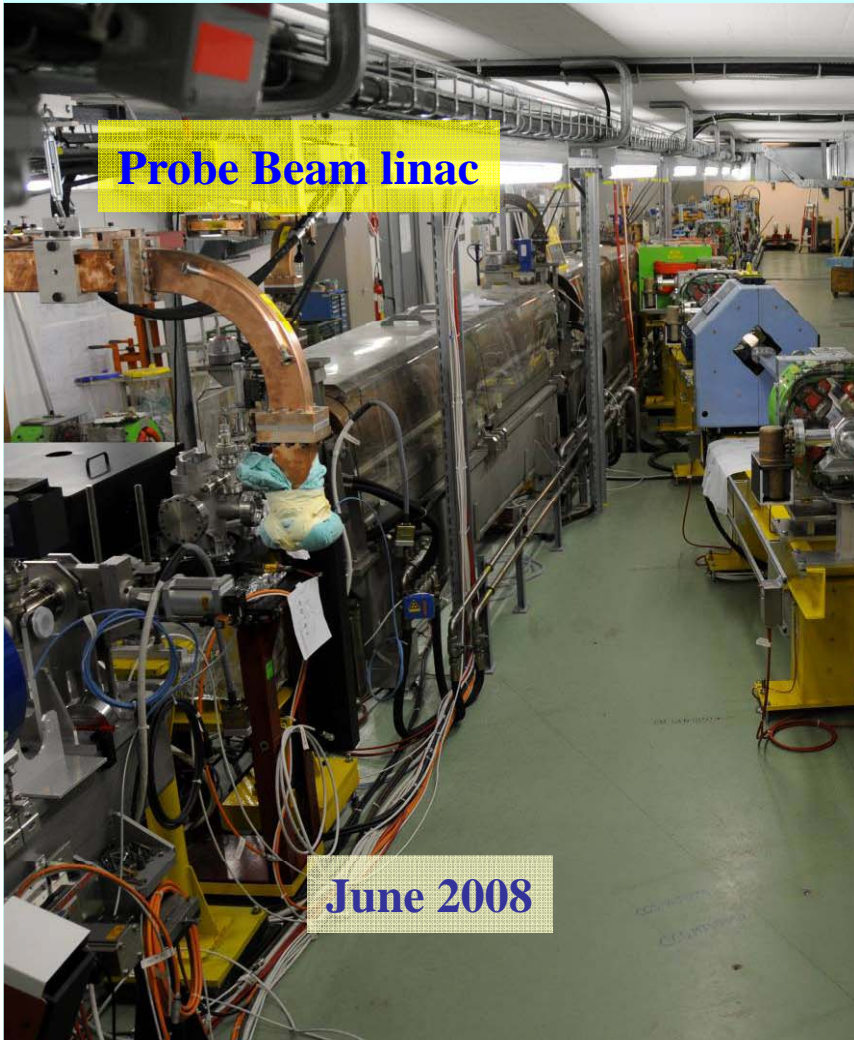

Probe Beam linac

June 2008



Jan 2008

CLIC / CTF3 collaboration

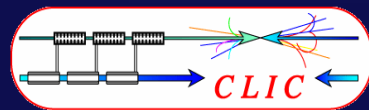

24 collaborating institutes

Ankara University (Turkey)
 Berlin Tech. Univ. (Germany)
 BINP (Russia)
 CERN
 CIEMAT (Spain)
 Finnish Industry (Finland)
 Gazi Universities (Turkey)

IRFU/Saclay (France)
 Helsinki Institute of Physics (Finland)
 IAP (Russia)
 IAP NASU (Ukraine)
 Instituto de Fisica Corpuscular (Spain)
 INFN / LNF (Italy)
 J.Adams Institute, (UK)

JASRI (Japan)
 JINR (Russia)
 JLAB (USA)
 KEK (Japan)
 LAL/Orsay (France)
 LAPP/ESIA (France)
 LLBL/LBL (USA)
 NCP (Pakistan)
 North-West. Univ. Illinois (USA)

Oslo University
 PSI (Switzerland),
 Polytech. University of Catalonia (Spain)
 RAL (England)
 RRCAT-Indore (India)
 Royal Holloway, Univ. London, (UK)
 SLAC (USA)
 Svedberg Laboratory (Sweden)
 Uppsala University (Sweden)

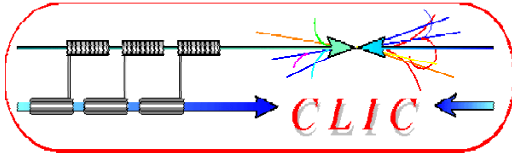

Collaboration between ILC and CLIC



Since February 2008: official collaboration between ILC and CLIC

http://clic-study.web.cern.ch/CLIC-Study/CLIC_ILC_Collab_Mtg/Index.htm

ILC-CLIC working groups	
Topic	Conveners
Civil Engineering and Conventional Facilities (CFS)	Claude Hauviller (CERN), John Osborne (CERN), Vic Kuchler (FNAL)
Beam Delivery Systems and Machine Detector Interface	Brett Parker (BNL), Daniel Schulte (CERN) , Andrei Seryi (SLAC), Emmanuel Tsesmelis (CERN)
Detectors	Lucie Linssen (CERN), Francois Richard (LAL), Dieter Schlatter (CERN), Sakue Yamada (KEK)
Cost & Schedule	John Carwardine (ANL), Katy Foraz (CERN), Peter Garbincius (FNAL), Tetsuo Shidara (KEK), Sylvain Weisz (CERN)
Beam Dynamics	Andrea Latina (FNAL), Kiyoshi Kubo (KEK), Daniel Schulte (CERN), Nick Walker (DESY)

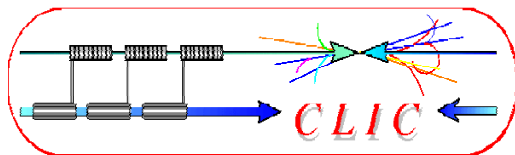

CLIC parameters



Center-of-mass energy	3 TeV
Peak Luminosity	$6 \cdot 10^{34} \text{ cm}^{-2} \text{ s}^{-1}$
Peak luminosity (in 1% of energy)	$2 \cdot 10^{34} \text{ cm}^{-2} \text{ s}^{-1}$
Repetition rate	50 Hz
Loaded accelerating gradient	100 MV/m
Main linac RF frequency	12 GHz
Overall two-linac length	42 km
Bunch charge	$3.72 \cdot 10^9$
Bunch separation	0.5 ns
Beam pulse duration	156 ns
Beam power/beam	14 MWatts
Hor./vert. normalized emittance	660 / 20 nm rad
Hor./vert. IP beam size bef. pinch	40 / ~1 nm
Total site length	48 km
Total power consumption	322 MW

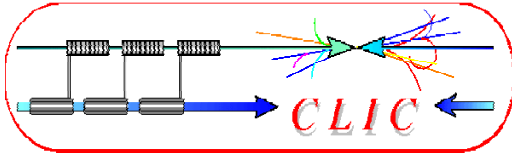

CLIC schedule



Tentative long-term CLIC scenario

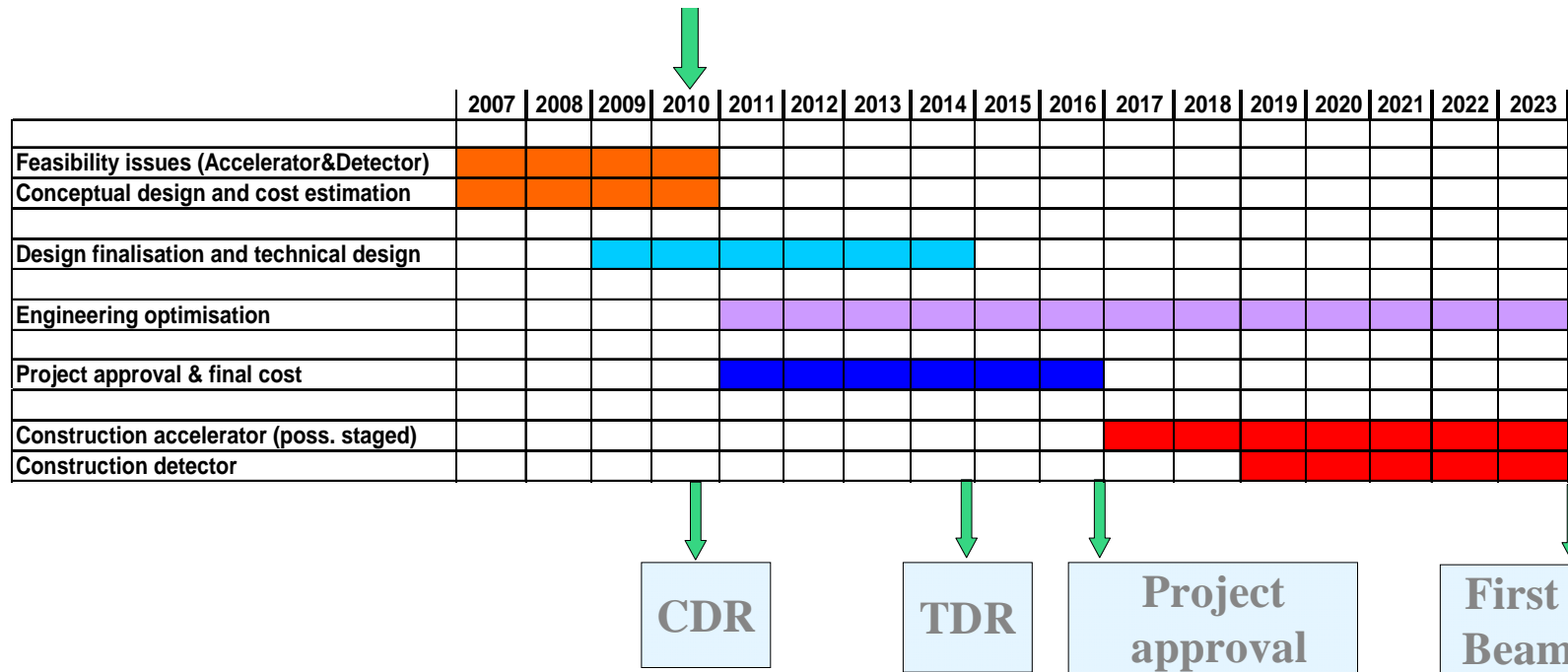

CLIC CDR foreseen for 2010

CLIC TDR foreseen for 2014

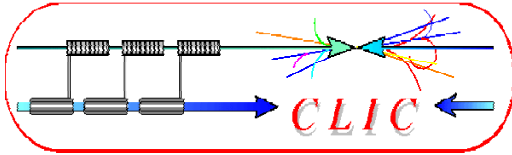

CLIC detector issues

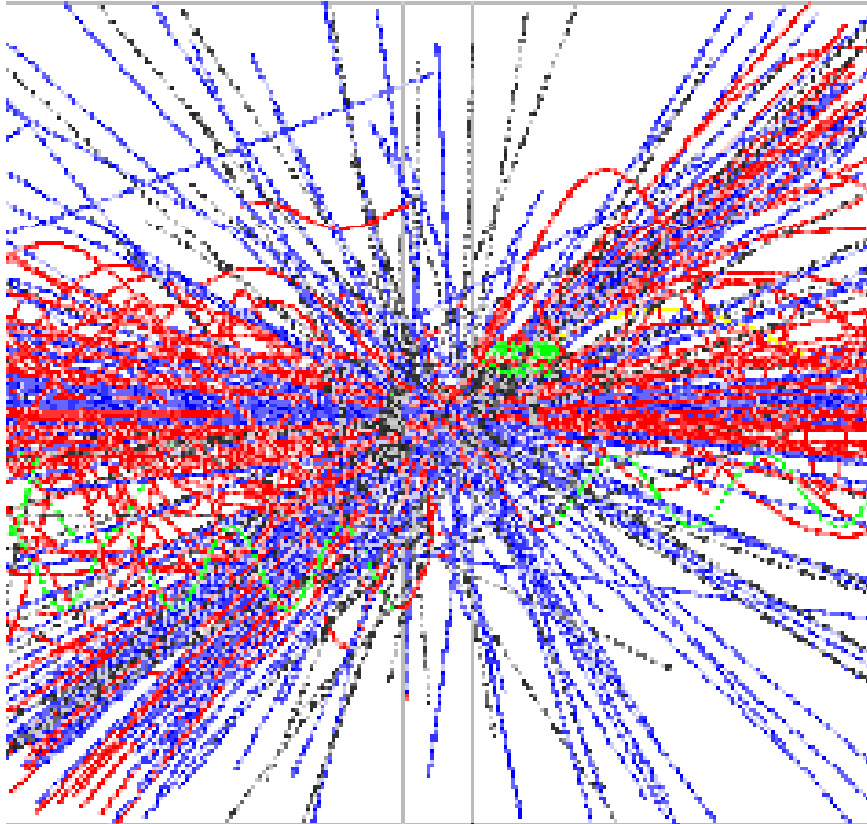

2 main differences with ILC:

- Energy 500 GeV => 3 TeV
- Time structure of the accelerator

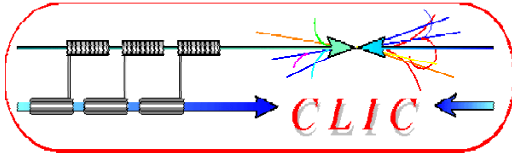

CLIC time structure



Train repetition rate 50 Hz

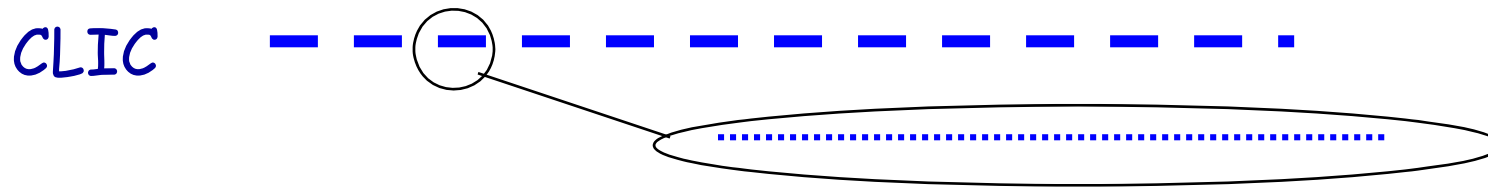

CLIC:	1 train = 312 bunches	0.5 ns apart	50 Hz
ILC:	1 train = 2820 bunches	337 ns apart	5 Hz

Consequences for CLIC detector:

- Need detection layers for time-stamping
 - Innermost tracker layer with sub-ns resolution
 - Possibly another time-stamping layer in calorimeter/muon region
- Readout electronics and DAQ will be completely different
- Power pulsing?

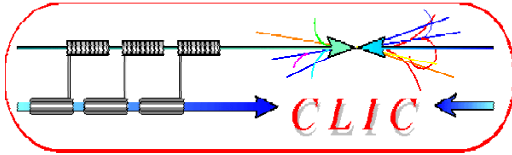

3 TeV centre-of-mass



In a snapshot.....

Differences between CLIC and ILC due to higher energy (3 TeV)

(details in following slides)

- Much increased background conditions (beamstrahlung and muons)
 - With several consequences for detector design
- Need for deeper calorimetry
- Is PFA a good option for the higher CLIC energies?
- Cope with higher tracker occupancy; 2-track resolution
- Solenoid size/strength expected to become an issue

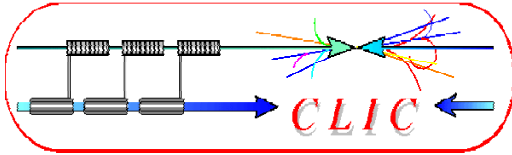

Beam-induced background



Background sources: CLIC and ILC similar CLIC

Due to the higher beam energy and small bunch sizes they are much more severe at CLIC.

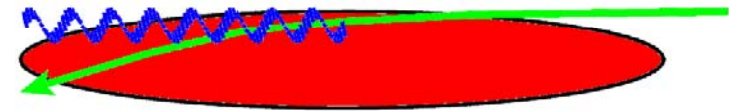

- CLIC 3TeV beamstrahlung $\Delta E/E = 29\%$ ($10 \times ILC_{value}$)
 - Coherent pairs (3.8×10^8 per bunch crossing) \Leftarrow disappear in beam pipe
 - Incoherent pairs (3.0×10^5 per bunch crossing) \Leftarrow suppress by strong B-field
 - $\gamma\gamma$ interactions \Rightarrow hadrons
- Muon background from upstream linac
 - More difficult to stop due to higher CLIC energy (active muon shield)
- Synchrotron radiation

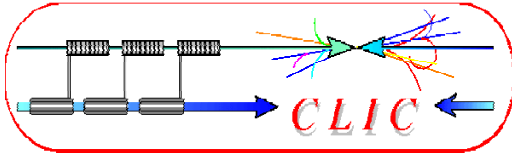

CLIC CM energy spectrum

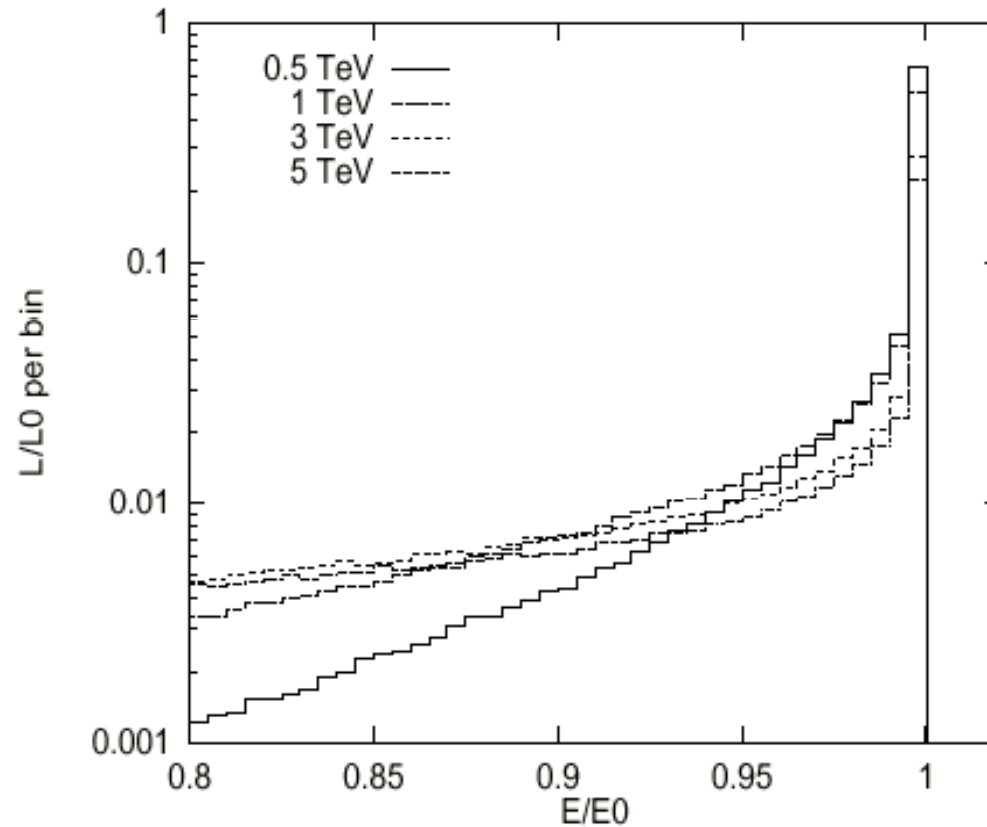

At 3 TeV, only 1/3 of the luminosity is in the top 1% Centre-of-mass energy bin

=> Many events with large forward or backward boost

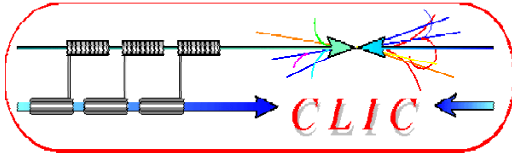

Beamstrahlung

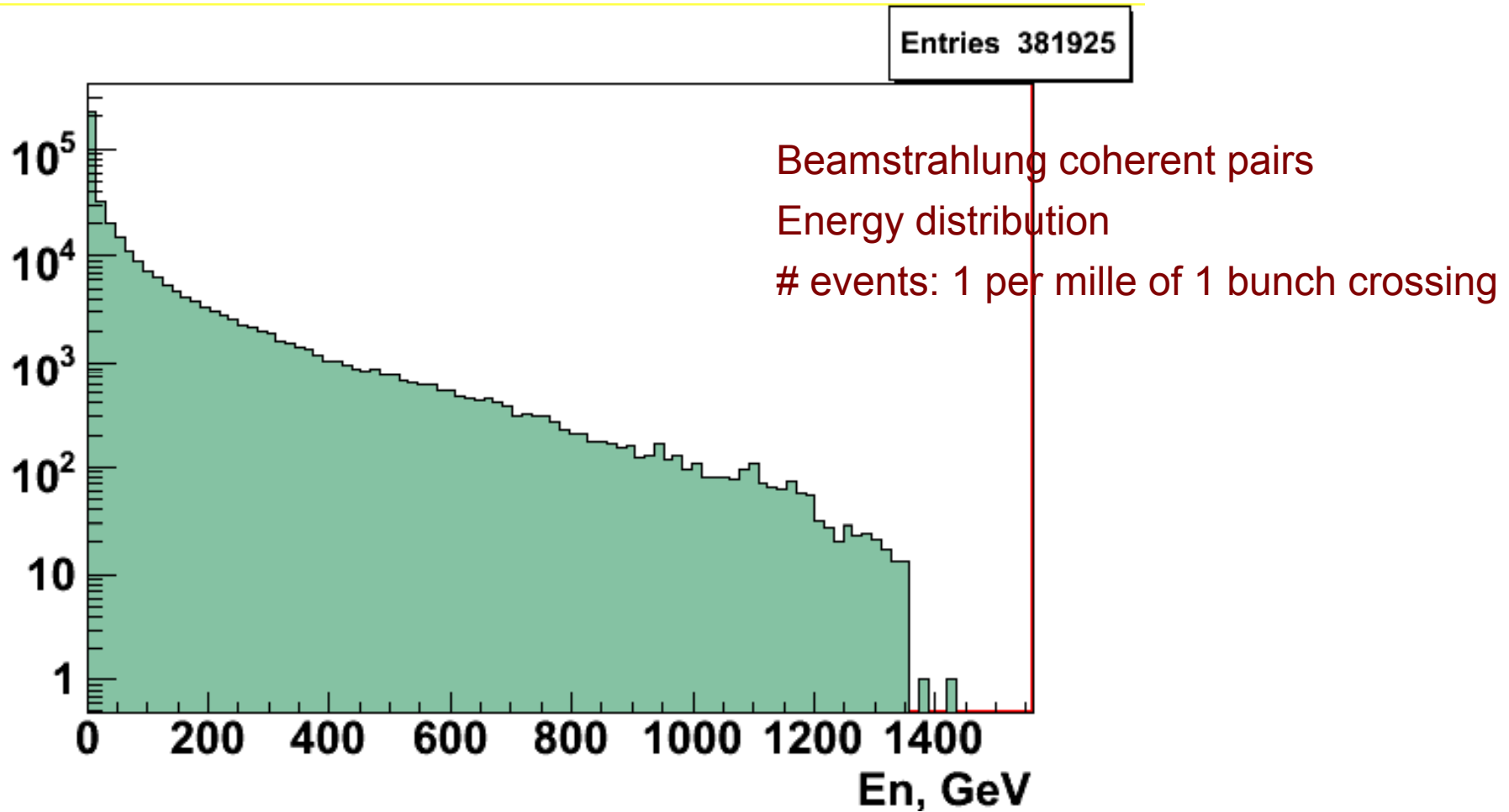

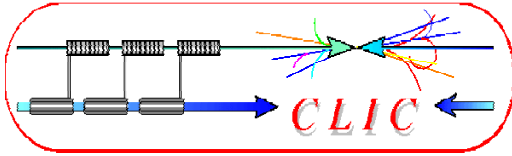

Beamstrahlung, continued.....



At 3 TeV many events have a large forward or backward boost and many back-scattered photons/neutrons

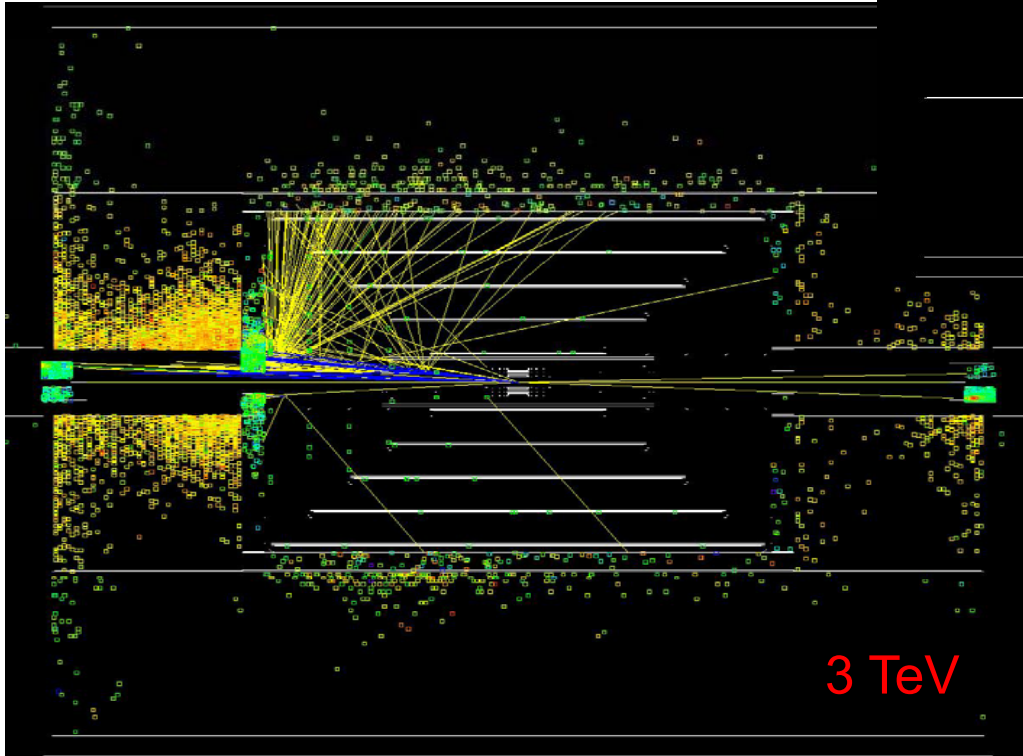
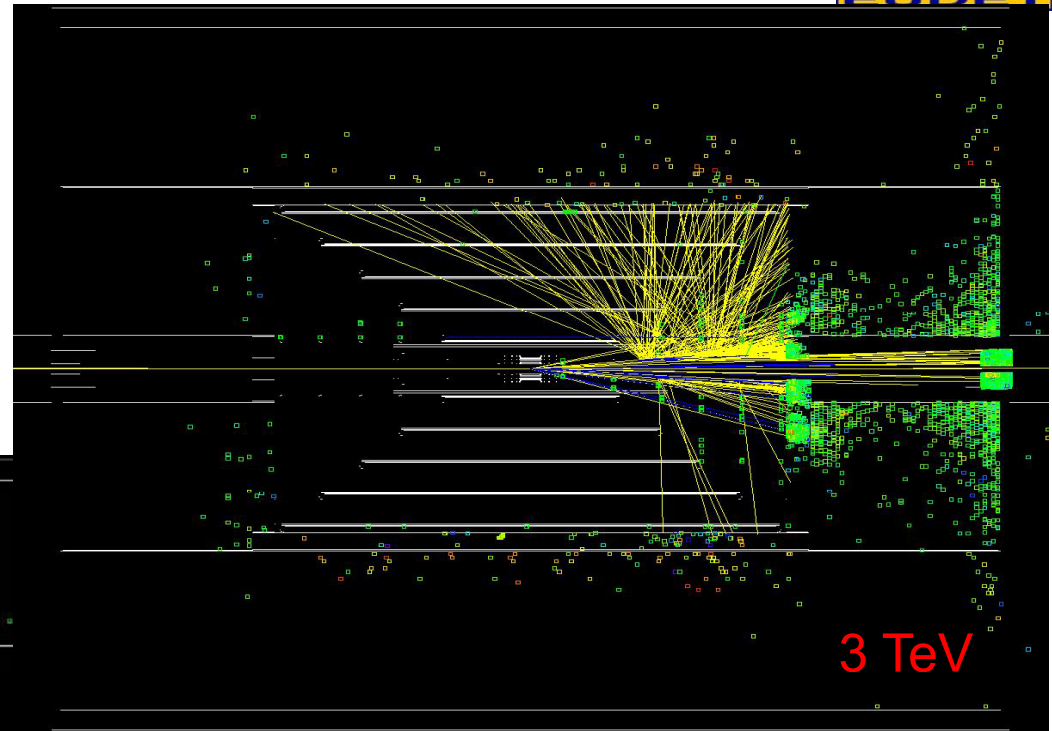

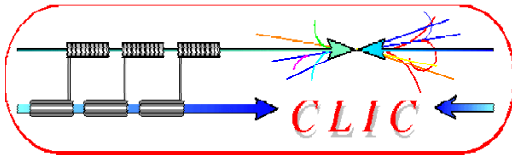

Opening angle forward region

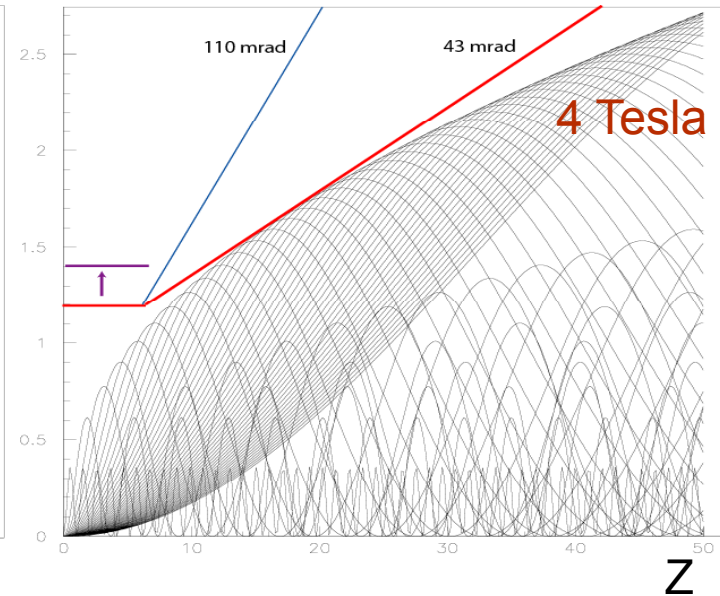
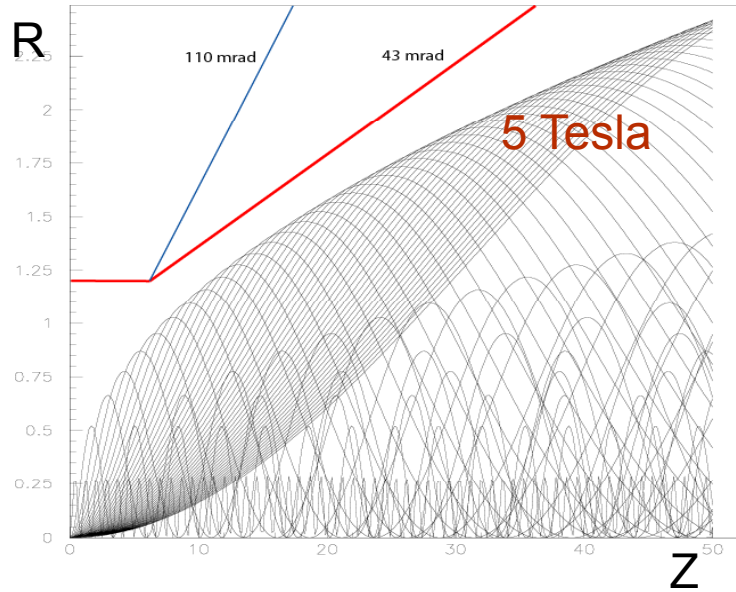

SiD plots
500 GeV

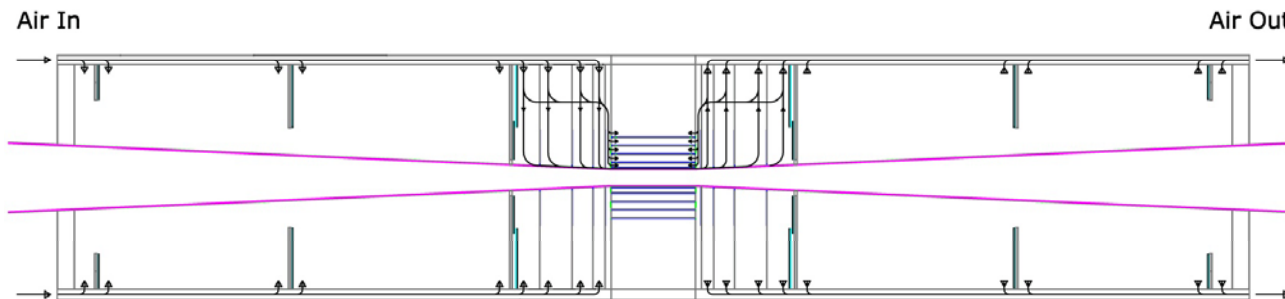

Consequences of machine-induced background for CLIC detector:

Need: **higher magnetic field** and **larger tracking/vertex opening angle** and **larger crossing angle (20 mrad)** and **mask in forward region**

Lucie Linssen, EUDET Amsterdam 7/10/2008

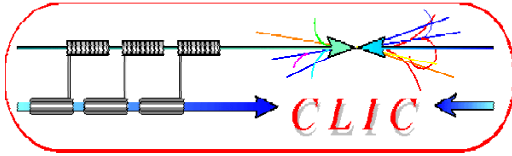

Forward region



- Tungsten **Mask** with polyethylene coating to absorb low-energy backscattered relics (e, γ ,n) from beamstrahlung. Containing **Lumical** and **BeamCal**

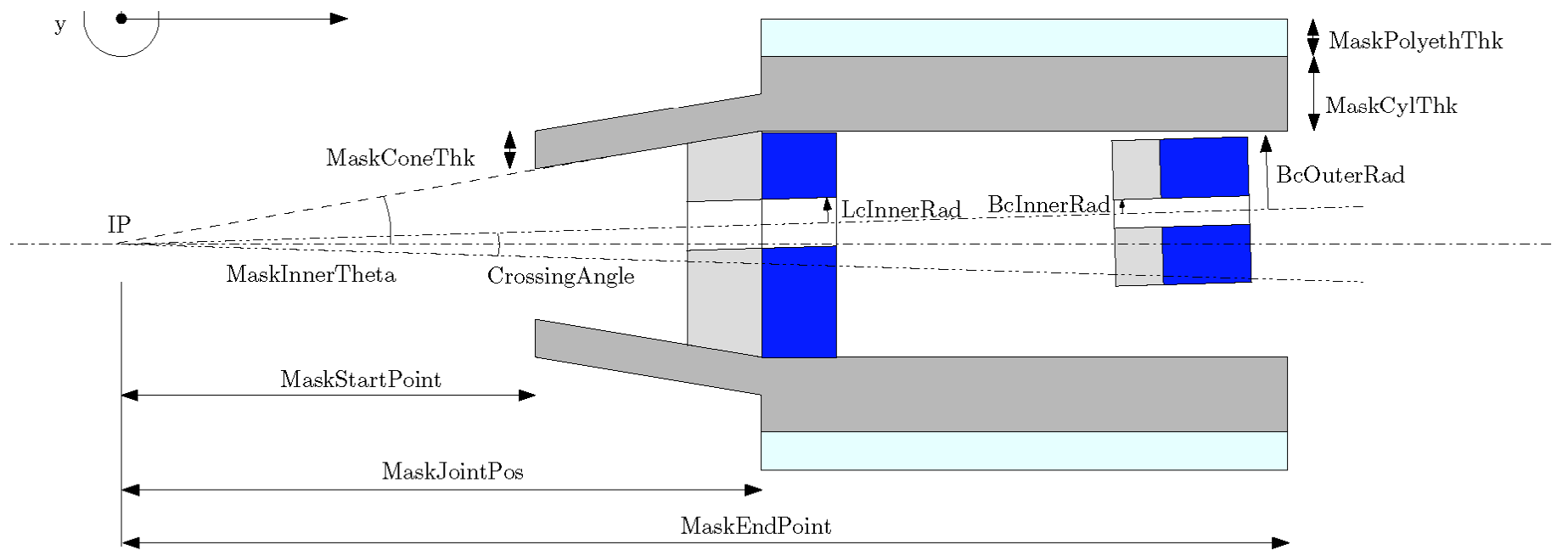

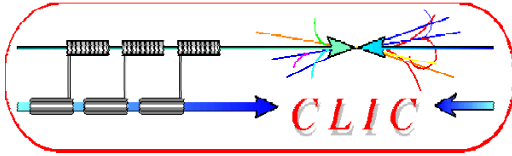

CLIC Calorimetry



Need deep HCAL (7λ to 9λ , tbc)

Cannot increase coil radius too much => need heavy absorber

Which HCAL material to use?

- Tungsten has too short X_0 , not good for hadron calorimetry

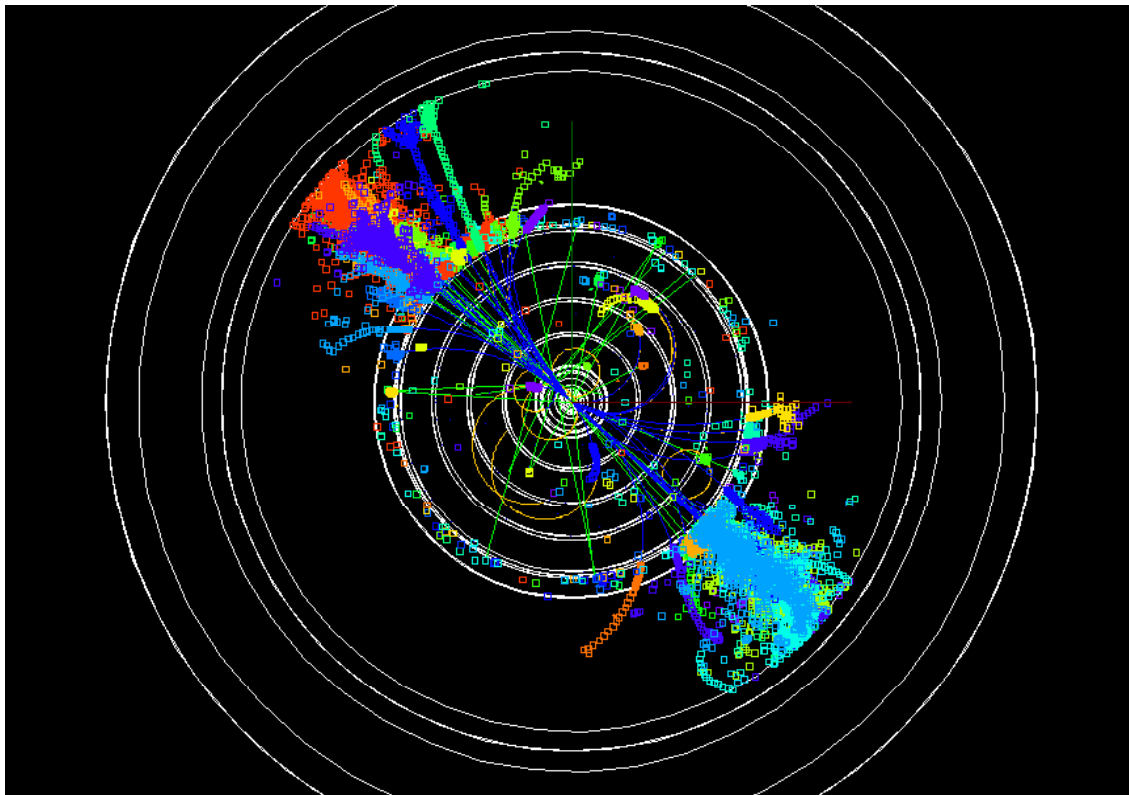

3 TeV e^+e^- event on
SiD detector layout,
illustrating the need
for deeper
calorimetry

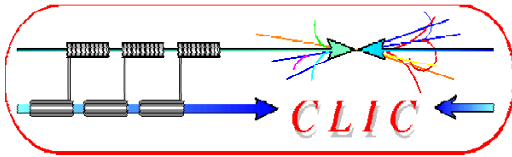

Calorimeter depth

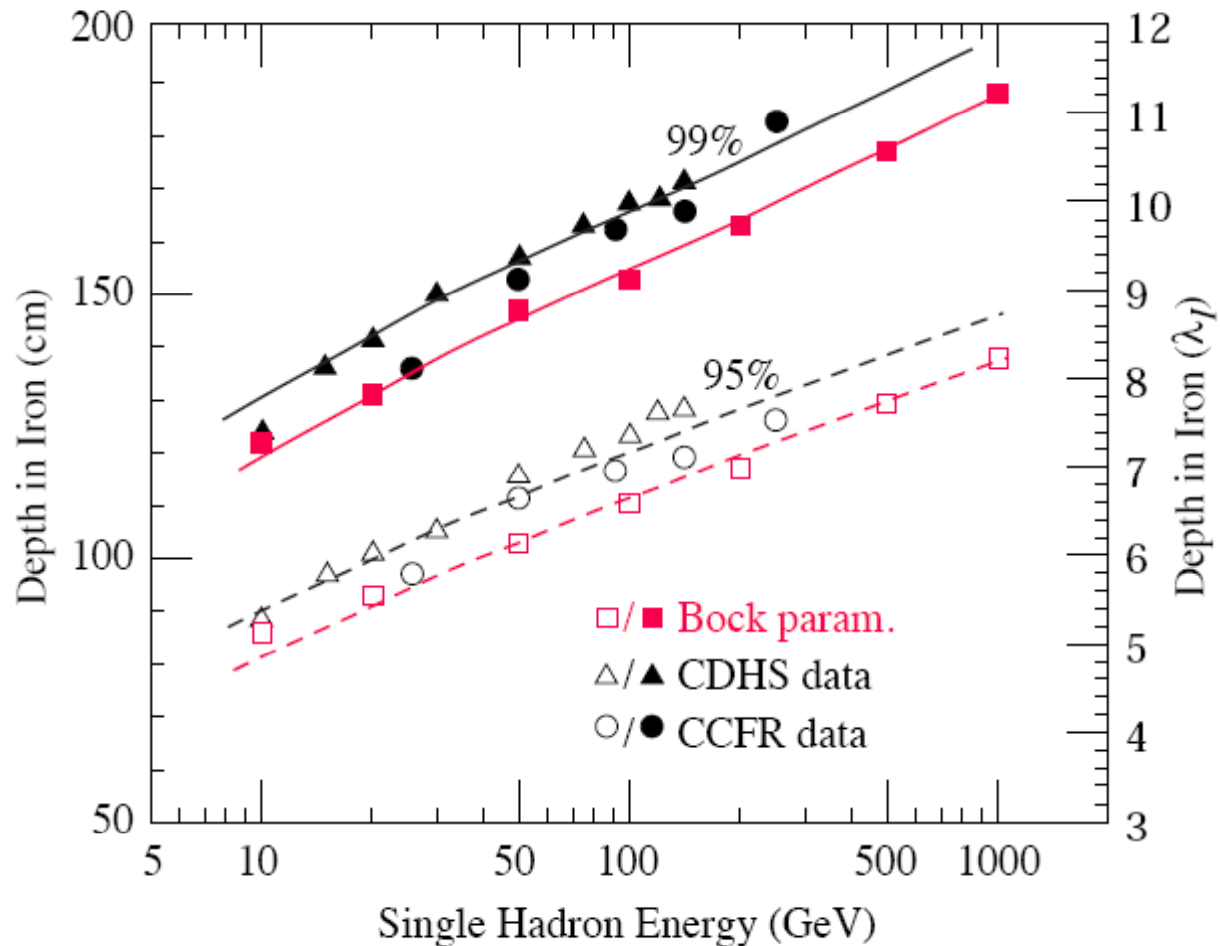
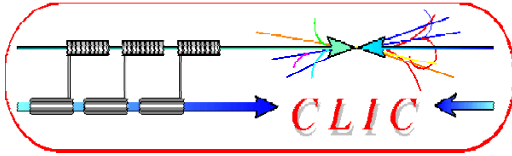

Figure 28.22: Required calorimeter thickness for 95% and 99% hadronic cascade containment in iron, on the basis of data from two large neutrino detectors and Bock's parameterization [143].



Which calorimetry at CLIC energies?



To overcome known shortfalls from LEP/LHC experience, new concepts/technologies are chosen for ILC:

•Based on Particle Flow Algorithm

- Highly segmented (13-25 mm²) ECAL (analog)
- Very highly segmented ECAL (digital)
- Highly segmented (1 cm²) HCAL (digital)
- Segmented HCAL (analog)

Method and Engineering difficult, but conventional

Limited in energy-range to a few hundred GeV

•Based on Dual (Triple) readout

- Sampling calorimeter
 - Plastic fibres
 - Crystal fibres (<= materials studies)
- Fully active calorimeter (EM part)
 - Crystal-based

Method and Engineering difficult and non-proven

Not limited in energy range

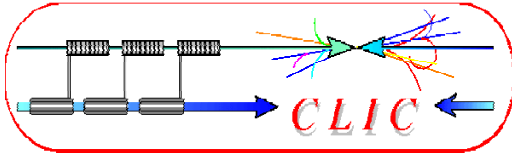

Tracking



Tracking issues:

- Due to beam-induced background and short time between bunches:
 - Inner radius of Vertex Detector has to move to 30 to 40 mm
 - High occupancy in the inner regions
- Narrow jets at high energy
 - 2-track separation is an issue for the tracker

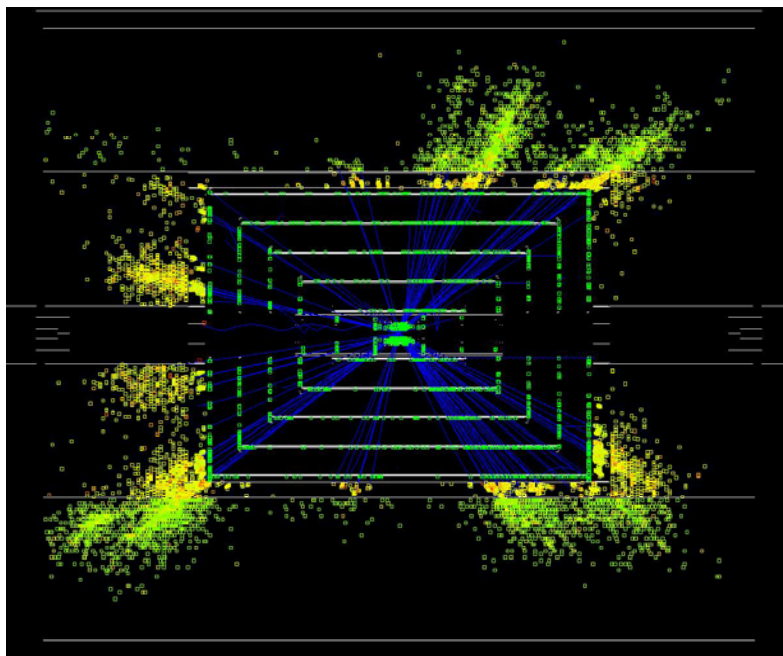

rdam 7/10/2008

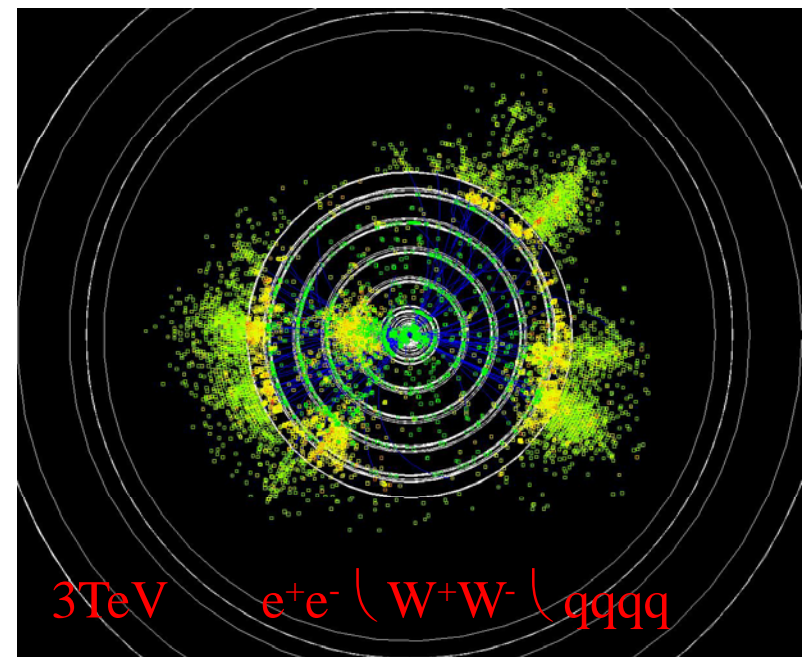

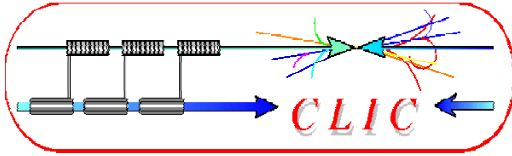

Conclusions



- CLIC detector at will have a lot of similarities with ILC detector
- **The basics of a CLIC detector concept can be based on the ILC work**
 - Basic concepts will be similar
 - Hardware developments (except timing aspect)
 - Software tools
- Work on the CLIC detector (and the physics) has re-started, based on concepts and tools from ILC
- A number of areas have been identified, where the CLIC detector at 3 TeV differs from the ILC concepts at 500 GeV
 - The CLIC concept studies will initially concentrate on these areas
- **Many thanks to ILC physics community, who helped to get the CLIC detector studies restarted in the framework of the recently established CLIC-ILC collaboration !**