

„Si-TPC“ with GEMs

Physikalisches Institut

Nußallee 12, 53115 Bonn



Hubert Blank, Christoph Brezina, Klaus Desch, Jochen Kaminski, Thorsten Krautscheid, Walter Ockenfels, Martin Ummenhofer, Peter Wienemann, Simone Zimmermann



Physikalisches Institut

Albert-Ludwigs-
Universität Freiburg



Andreas Bamberger, Uwe Renz, Andreas Zwerger

*renz@physik.uni-freiburg.de

Outline



- Spatial resolution and understanding of possible systematics
- Time resolution and time walk correction
- Software issues -> Pixelman PlugIns

TPC - basic operation and pixelated readout

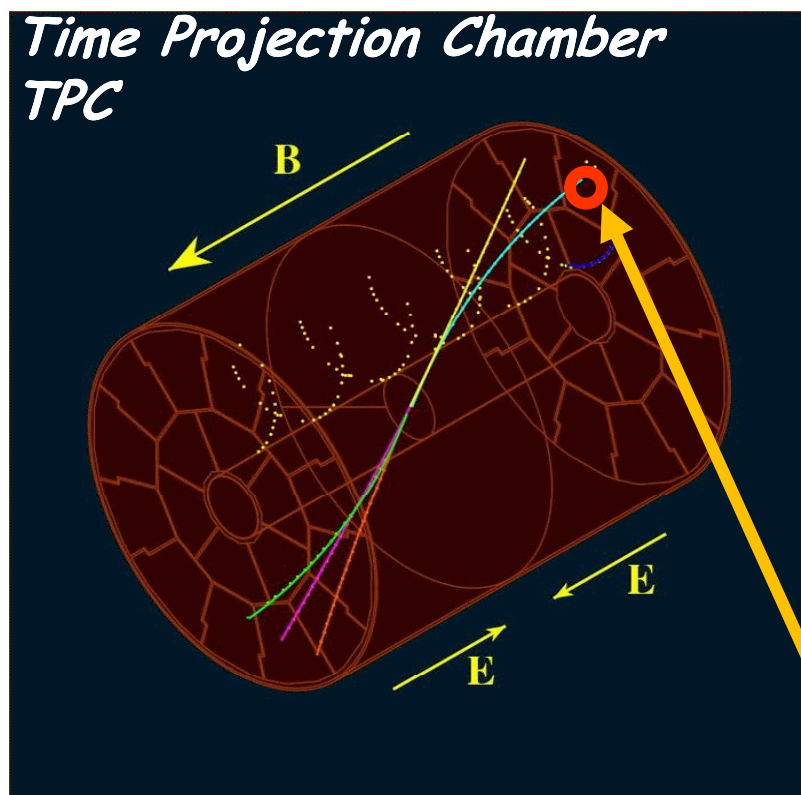

- Charged particle ionizes the chamber gas
- The primary charge drifts along the electric field E towards the end plates
- Magnetic field parallel to E reduces transverse diffusion and allows measurement of the particle momentum
- At the end plate the primary ionization is amplified
- Readout of the signal
- Micro Pattern Gas Detectors (MPGD):
 - high resolution readout and high rates
- Pixelated readout offers high resolution
- **Digital Bubble Chamber**
- A **TPC** at the **ILC** needs excellent momentum resolution \Rightarrow GEM-TimePix for end plate readout

region of interest for this talk

GEM - Gas Electron Multiplier

F. Sauli, Nucl. Instrum. Methods A386(1997)531

F. Sauli, <http://www.cern.ch/GDD>

*Thin, metal coated polymer foil.
Very high density of chemical
pierced holes*



Principle:

- 2 layers Cu each $5\mu\text{m}$ thick, separated from each other by $50\mu\text{m}$ Kapton.
- Conical etched *holes* largest $\varnothing 70\mu\text{m}$, diagonal *distance of holes* $140\mu\text{m}$.

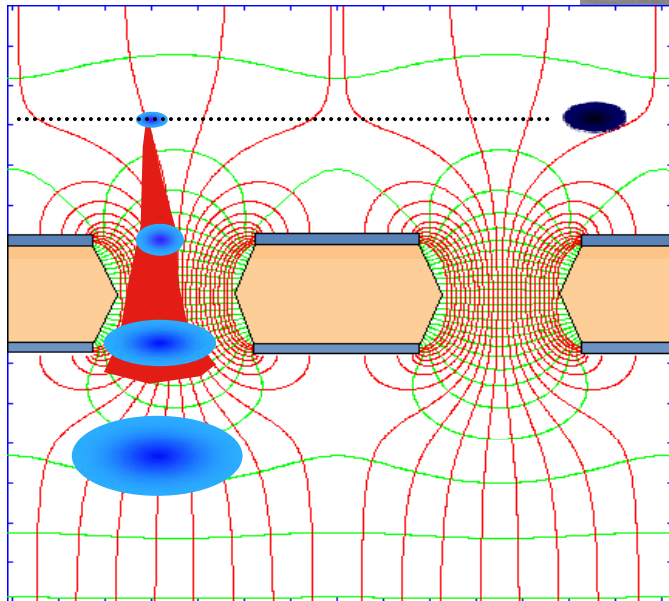
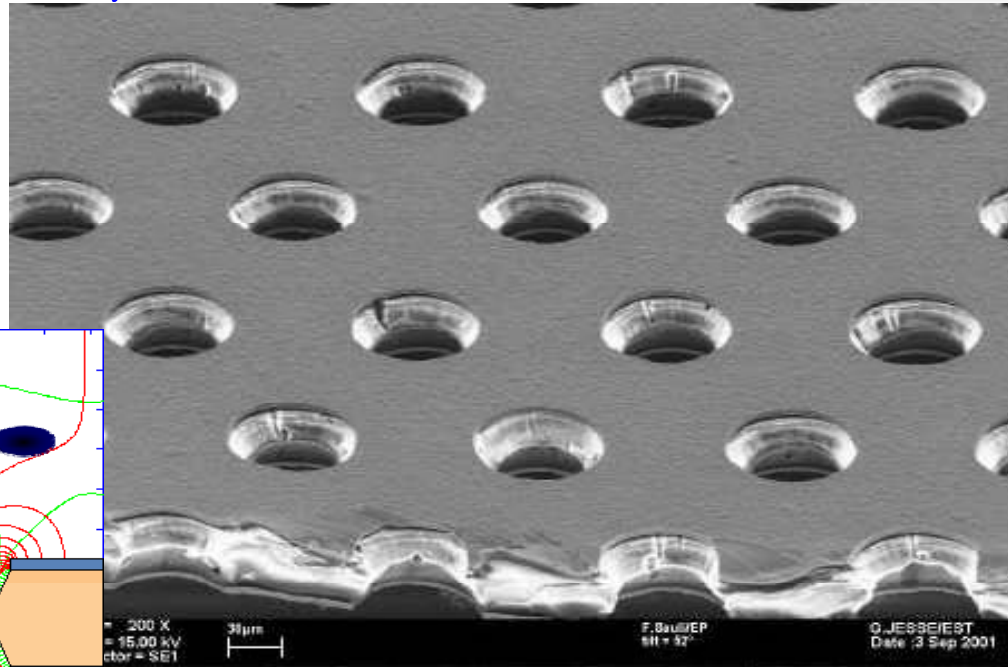

Advantages of Triple-GEM-setup

- *Gas gain up to 10^5 in ArCO₂ easily achievable*
- *Minimizing the back drift of positive ions into the drift volume ($O(10^{-2})$)*
- *Encapsulated region of amplification*

TimePix properties

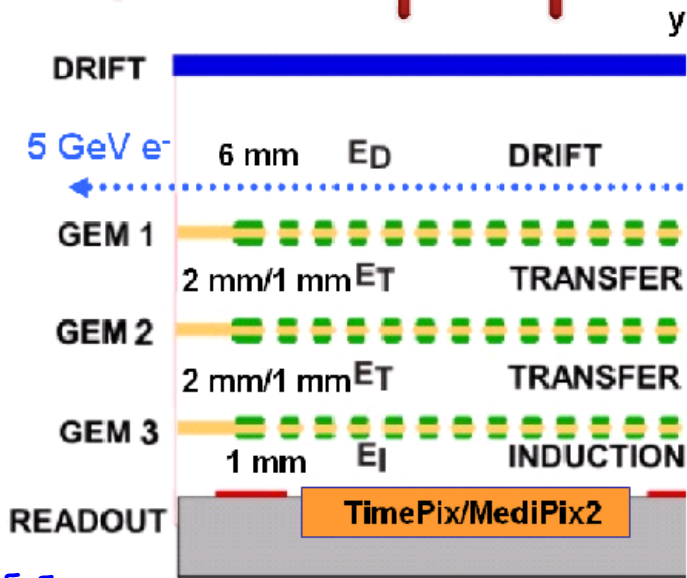

TimePix properties inherited from MediPix

Pixel size $55\mu\text{m}$ in a 256×256 Matrix

dimensions of the *sensitive area*: $1,4 \times 1,4 \text{ cm}^2$

lower threshold of $\approx 700 e^-$

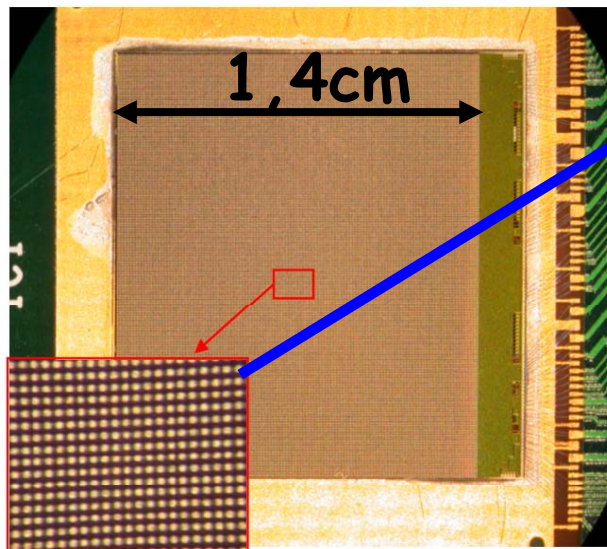
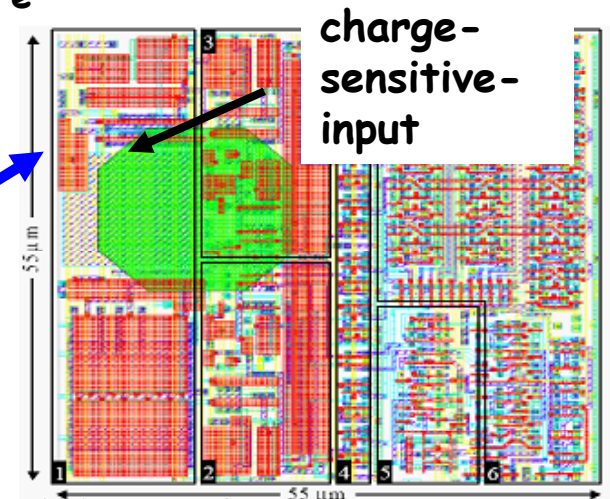

TimePix

- Based on improved design of MediPix2 MXR
- *Time information on each pixel*, due to an adjustable clock up to $\approx 100\text{MHz}$, distributed to all pixels
- *The 2 different modes* out of four available modes are used: *Time over threshold TOT- (amplitude reconstruction)* and *TIME-mode*
- *modes individually selectable* for each pixel
- Mixed Mode important feature for walk correction

X. Llopart Cudie, "Design And Characterization Of 64-K Pixels Chips Working In Single Photon Processing Mode", CERN-THESIS-2007-062

DESY Test Beam June 2007



Failure-free and stable operation of TimePix-GEM-setup

e⁻ beam DESY II

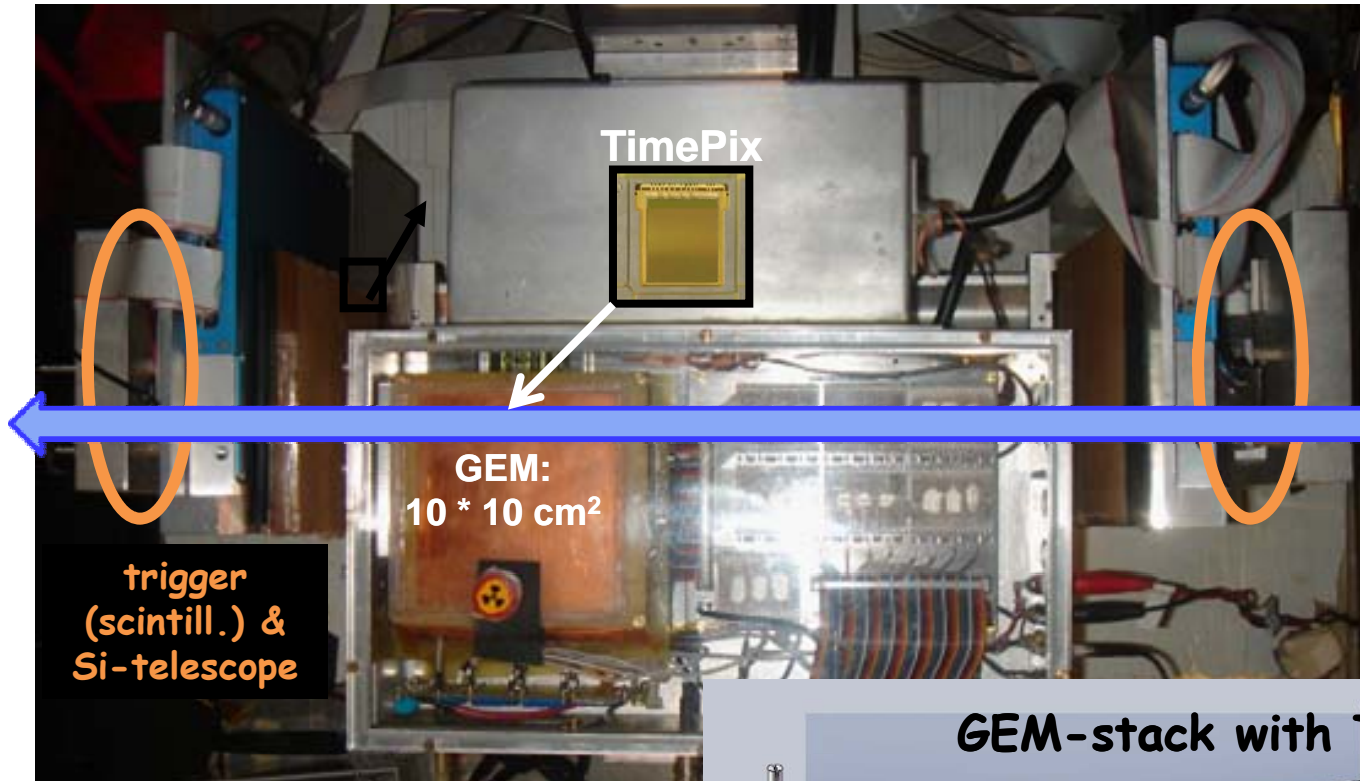

Two different types of GEMs tested:

- Standard 100x100mm² GEMs mit 140μm hole pitch
- small GEMs 24x28mm² with a fine pitch of 50μm

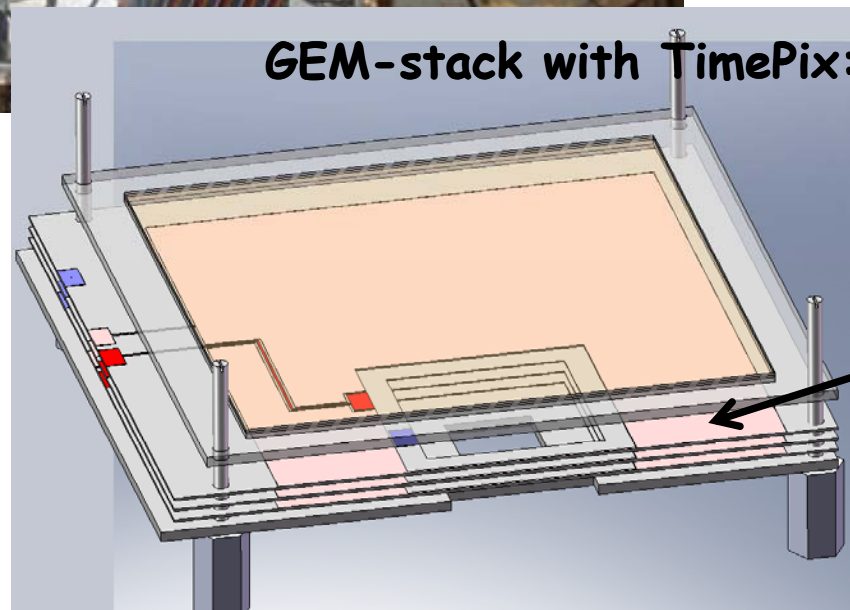

- Shown for fine pitched (small) GEMs
- 6mm drift volume
- ≈ 1.8mm distance between transfer and induction gaps

Data taking properties and reconstruction



- Two independent data streams: TimePix data (Windows based readout) and SiTel.
- Si-Tel allows the determination of the drift distance with $\sim 50\mu\text{m}$ precision
- Cleaning up of multiple tracks by
 - double hits in the SiTel
 - in projection along the track: secondary maximum signals another track
- Every other pixel in a row is set to the TOT property, and TIME property in between
- All over the surface ordered in a checker board fashion
- Reconstruction is done by mapping $\frac{1}{2}$ of all pixels onto 256x256 matrix. Missing neighbors in TOT or TIME data are thereby interpolated

TOT	TIME	TOT
TIME	TOT	TIME
TOT	TIME	TOT

Typical events

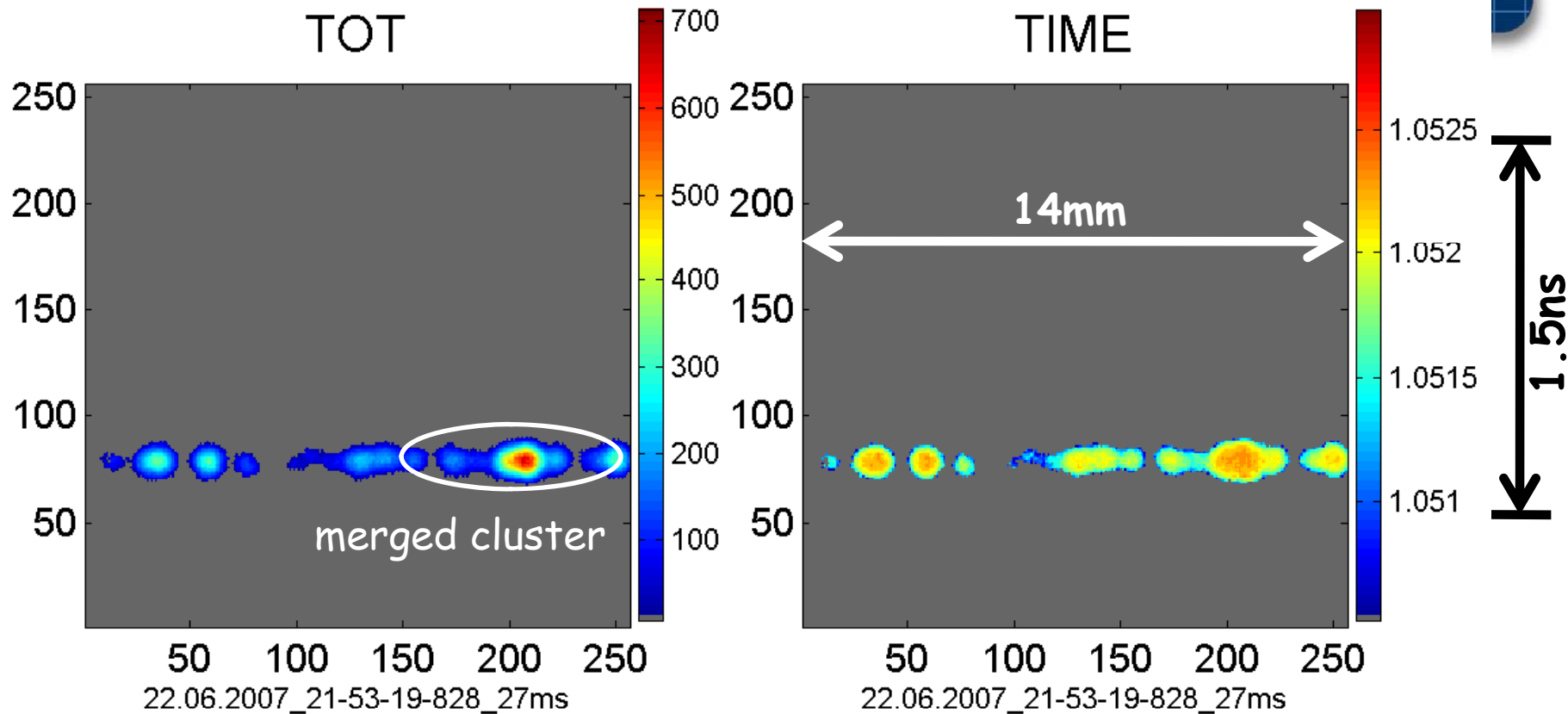
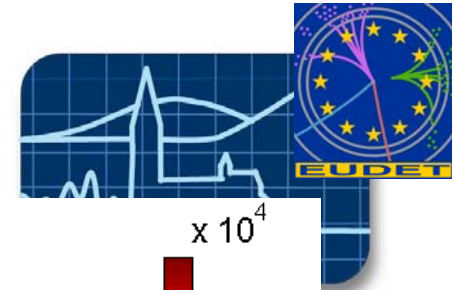

1. Search contiguous areas for cluster reconstruction
2. Use TOT-information to separate merged clusters
⇒ BUT diffusion smears our information of individual primary e^- from distinct clusters. These electrons overlap and appear to belong to the same (single) cluster.

Spatial properties of cluster position due to the discrete structure of GEMs



3 length scales: charge radius R_{charge} , d_{hole} , transv. diffusion $R_{\text{diff}}(z)$

1. hole of the first GEM is "perfectly mapped onto the detector. The centroid of the e^- avalanche remains stable.
2. for large drift distances $R_{\text{diff}} \gg R_{\text{charge}}$, then centroid determination is perfect, even for multi electron clusters
3. for small drift distances is $R_{\text{diff}} \ll R_{\text{charge}}$ and $R_{\text{diff}} < d_{\text{hole}}$ there is also a perfect mapping for isolated clusters (single or multi electron clusters)
4. for intermediate drift distances $R_{\text{diff}} \ll R_{\text{charge}}$ and $R_{\text{diff}} > d_{\text{hole}}$ then its not any more perfect for multi-electron clusters

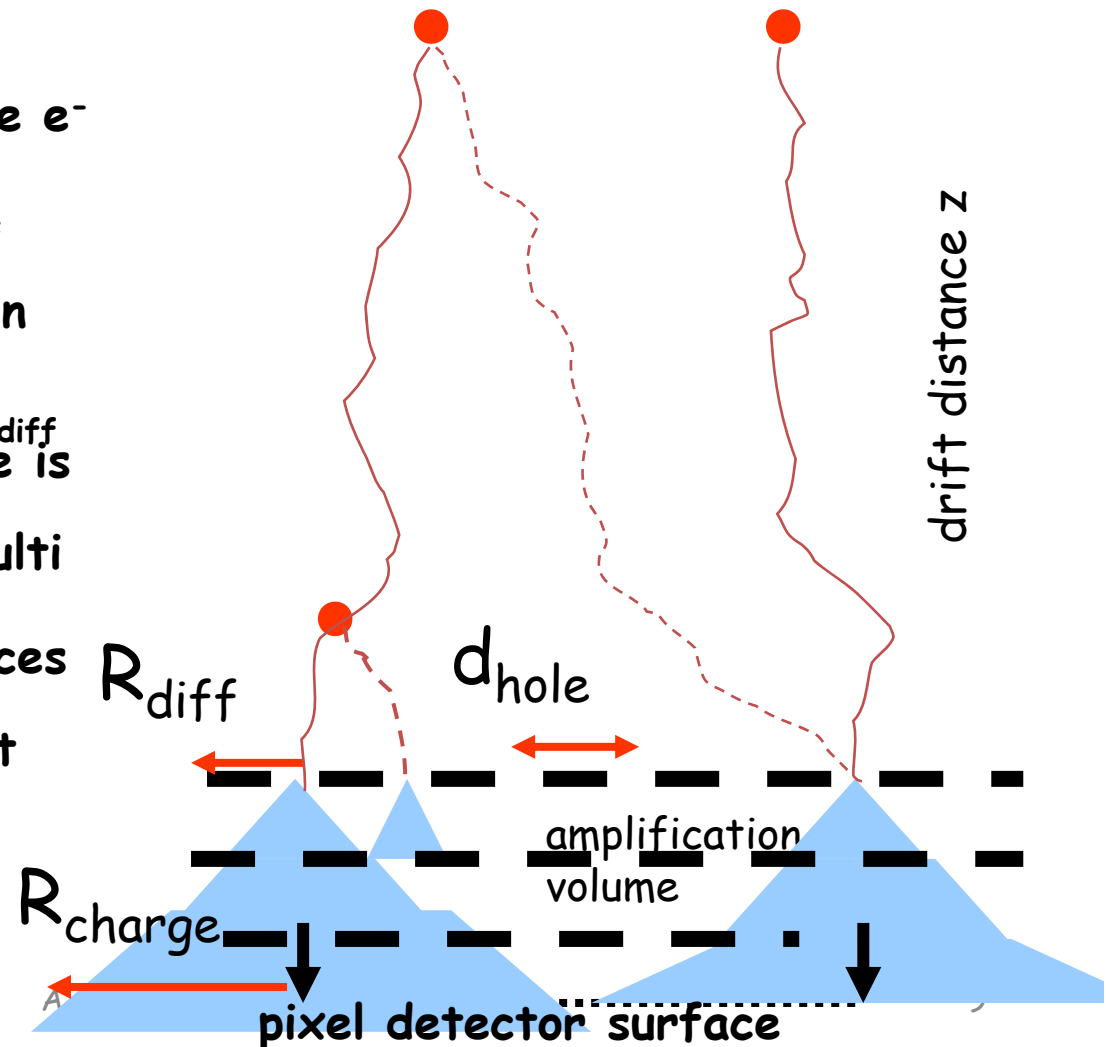

Special case for tracks close to the first GEM

- The clusters are arranged in a line along the track and produce **overlapping** charges
- It depends on the direction considered for the precise mapping: rectangular to the track it may stay precise and reveal the hole structure
- the position of the centroids along the track is not necessarily mapping the cluster position because of overlapping charge distributions

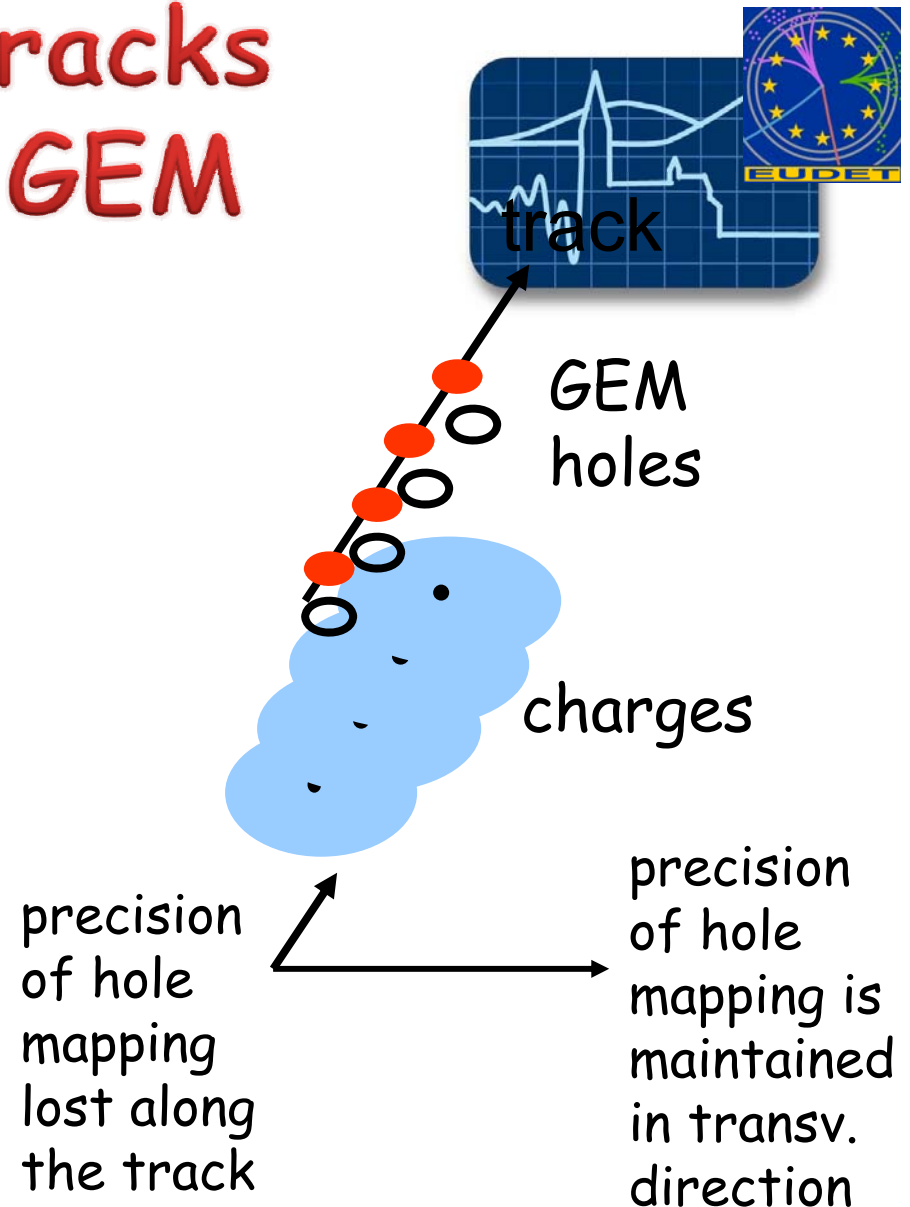

Orientation of GEM



“old” orientation

“new” orientation

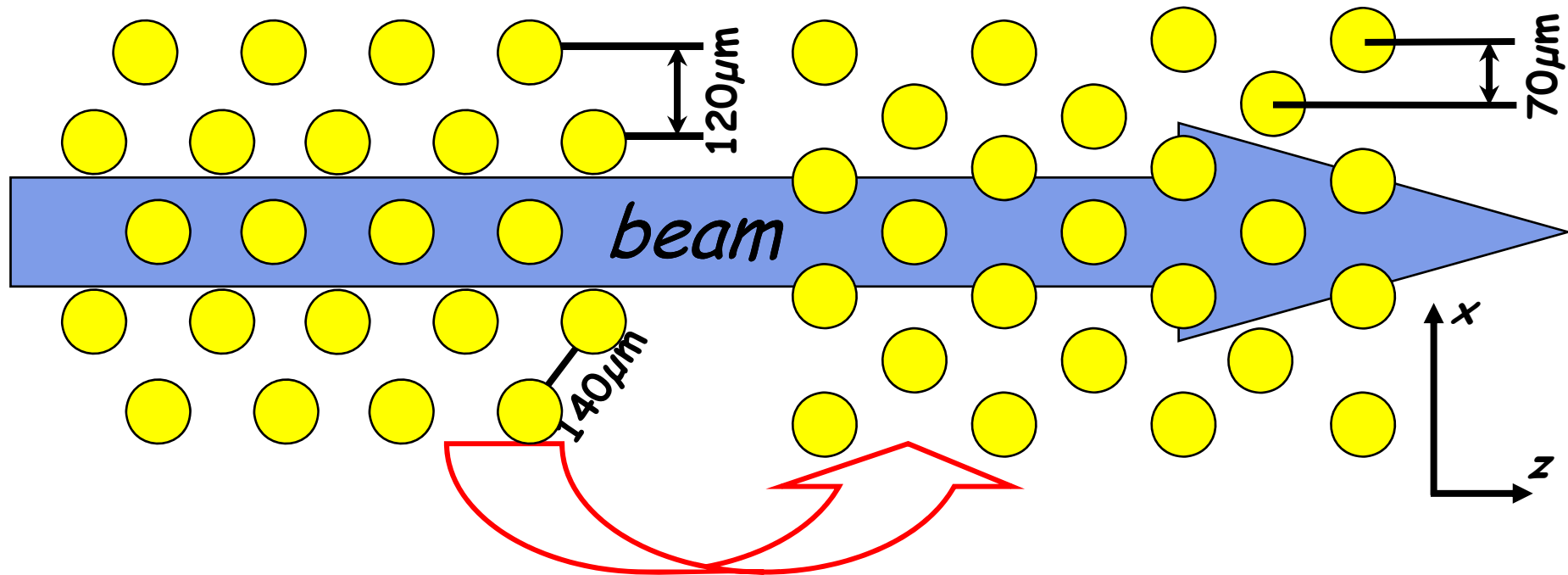

As structure of $120\mu\text{m}$ visible in FFT
Rotate GEM by 90°
Now $70\mu\text{m}$ projected hole pitch

GEM Struktur

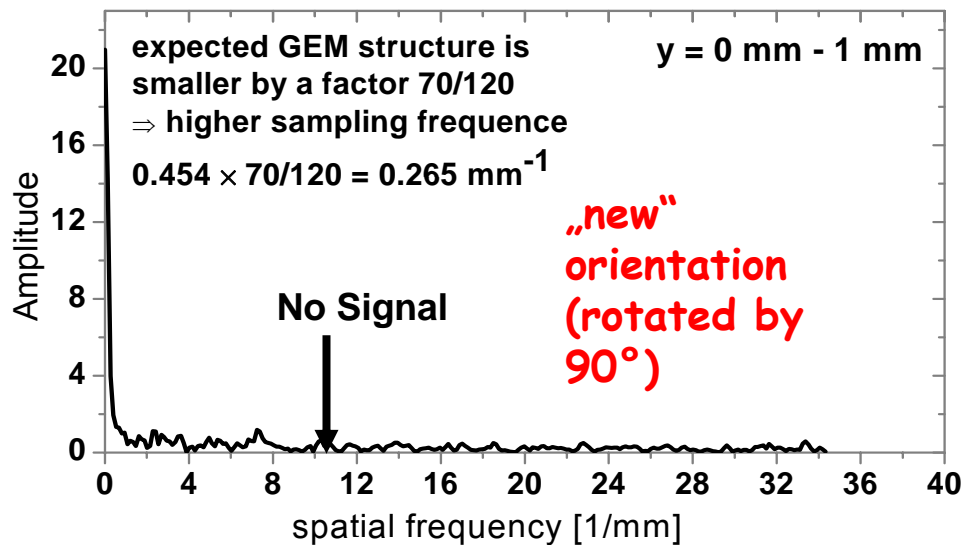
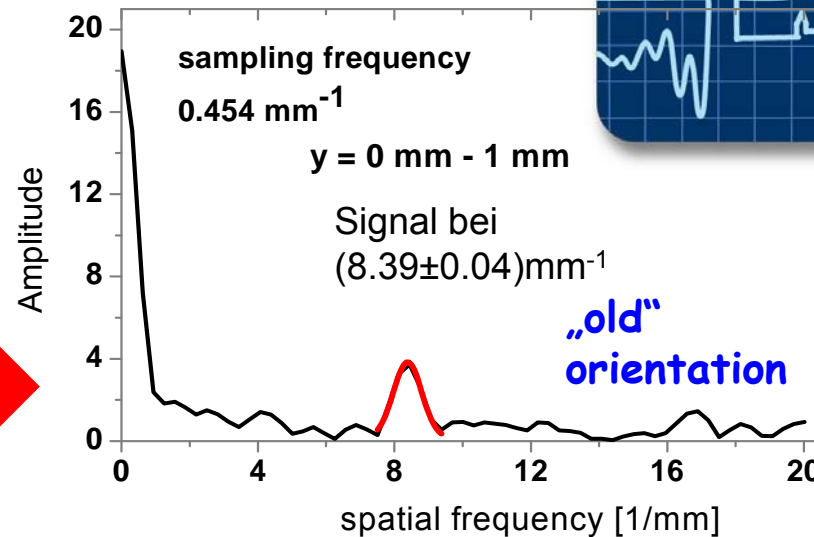
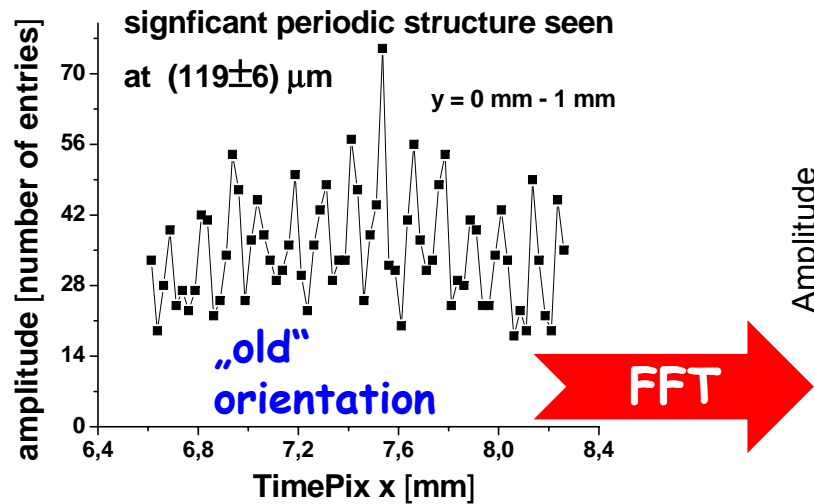

- Use **Fast Fourier Transformation** (FFT) \Rightarrow periodic structure at $1/8.39 \text{ mm}$ corresponds $119 \mu\text{m}$, independent of sampling rate (number of supporting points of the FFT).
- No such structure seen for drift distances $> 1 \text{ mm}$ seen. This structure is smeared by transverse diffusion
- **After rotation by 90° : signal in FFT vanishes**
- **Signal amplitude depends on orientation Chip vs. GEM**

Check the angular dependance of the structured signal



signal disappears with

- rotation of the coordinate system with respect to the TimePix frame $\alpha < -9$ and $\alpha > 9$ mrad
- "fortuitous" peak at α near zero (GEM almost coincides with the chip's orientation)
- the signal strongly depends on the drift distance z

Reason: the disappearance is due to the fact that the transverse diffusion smears out the structure $R_{diff} > d_{hole}$

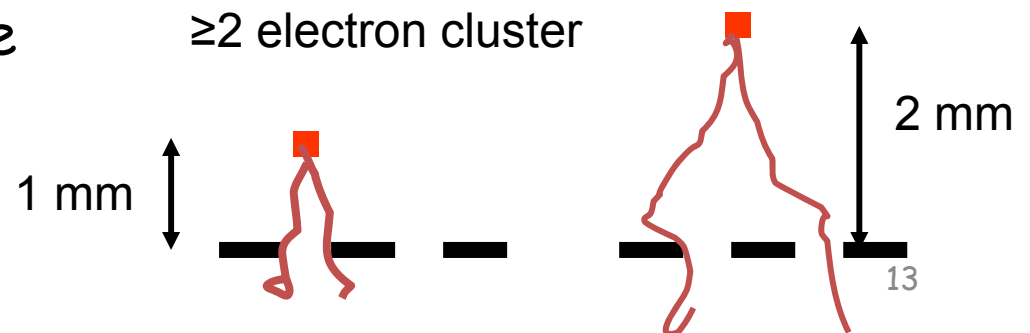
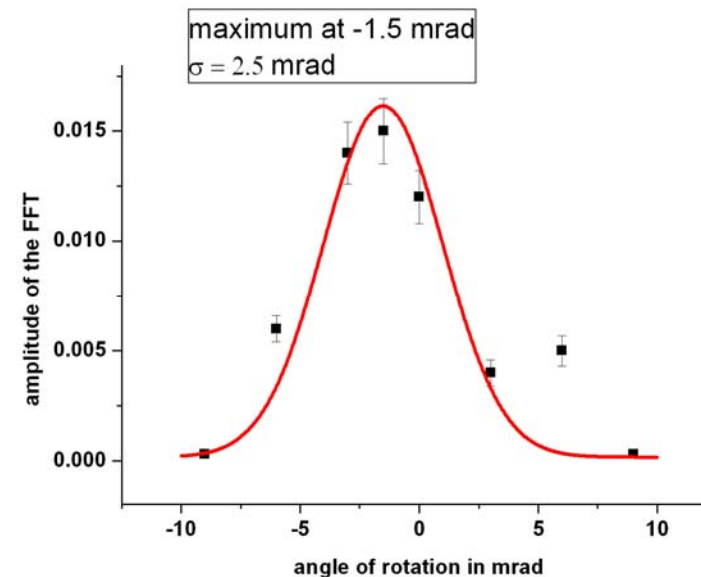

Discussion of a possible bias for the determination of the point resolution



- does the orientation of the track matter with respect GEM for the point resolution given by the centroids of the clusters?
- Eventually yes, if most of the tracks would run parallel to the holes
- however most tracks are inclined $\alpha_{\text{track}} \sim (22 \pm 6)$ mrad i.e. far from zero

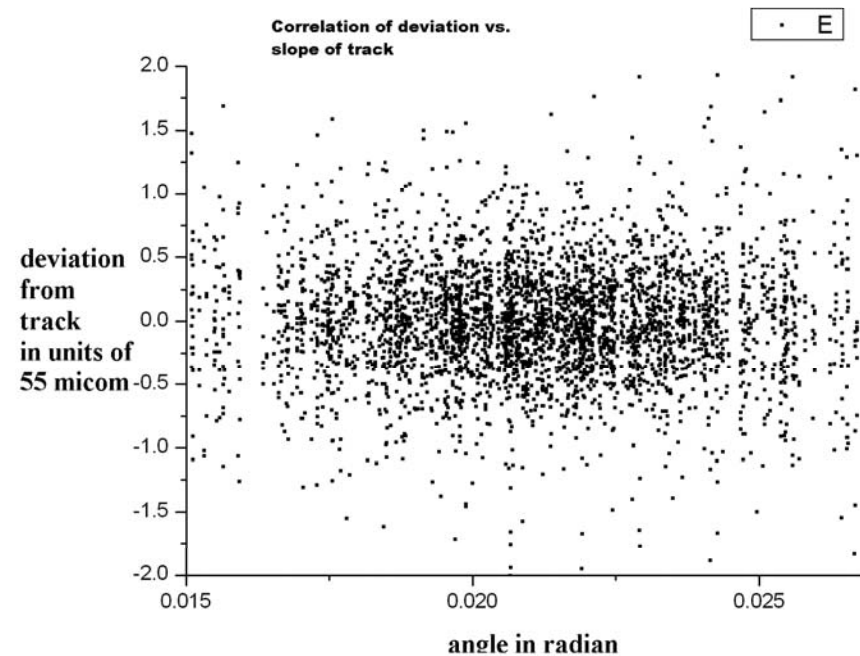

Resolution of standard GEMs

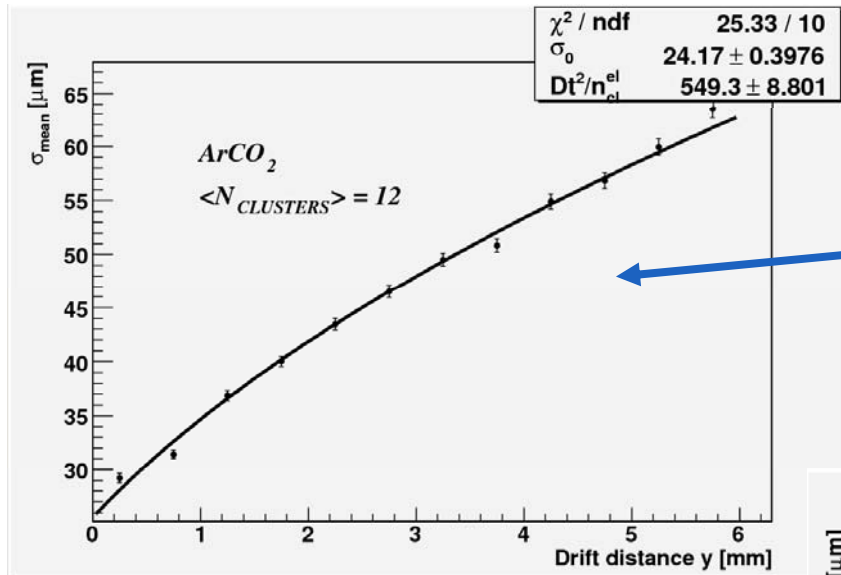

old GEM configuration with 120 μm projected z-pitch

new GEM configuration with 70 μm projected z-pitch

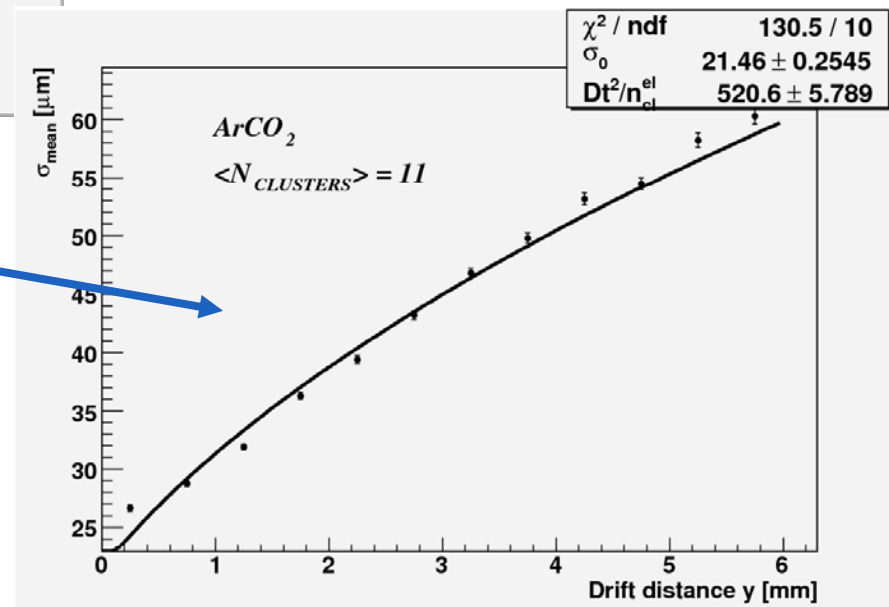

$\approx 2 \mu\text{m}$ improvement for σ_0 only through rotating the first GEM by 90°

small GEMs

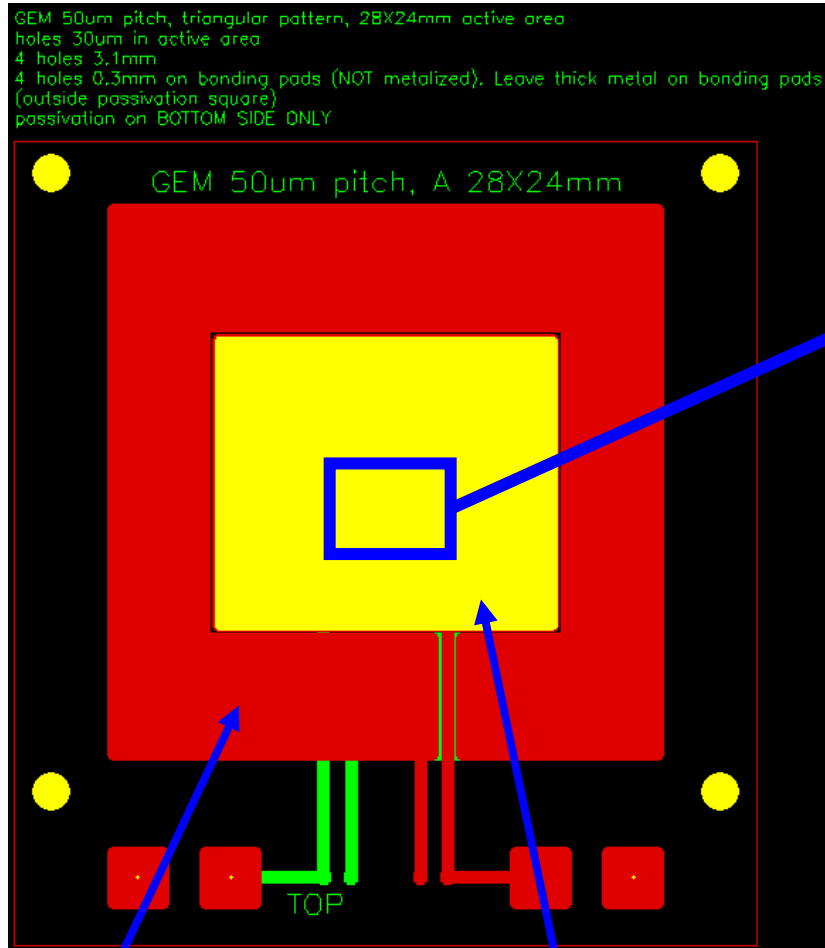

Guard rings on both sides

Active surface 28x24mm²

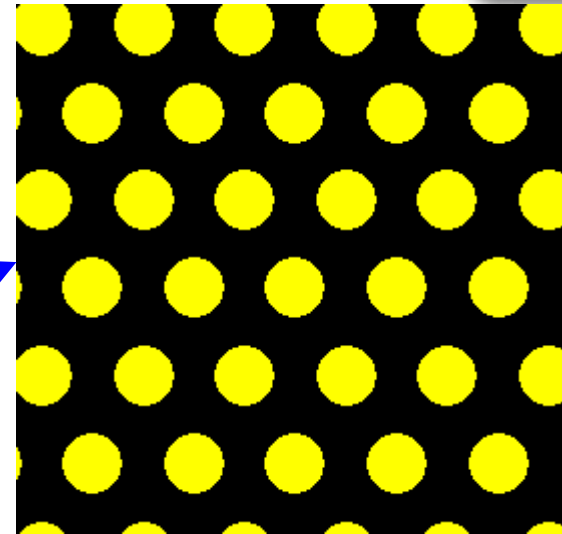

- Referenced outer hole diameter in copper 30 μ m.
- Inner hole diameter in the Kapton between 17 μ m-21 μ m.
- **Diagonal hole pitch 50 μ m**
 - Projected in x \approx 43 μ m
 - Projected in z \approx 25 μ m

Resolution of small GEMs

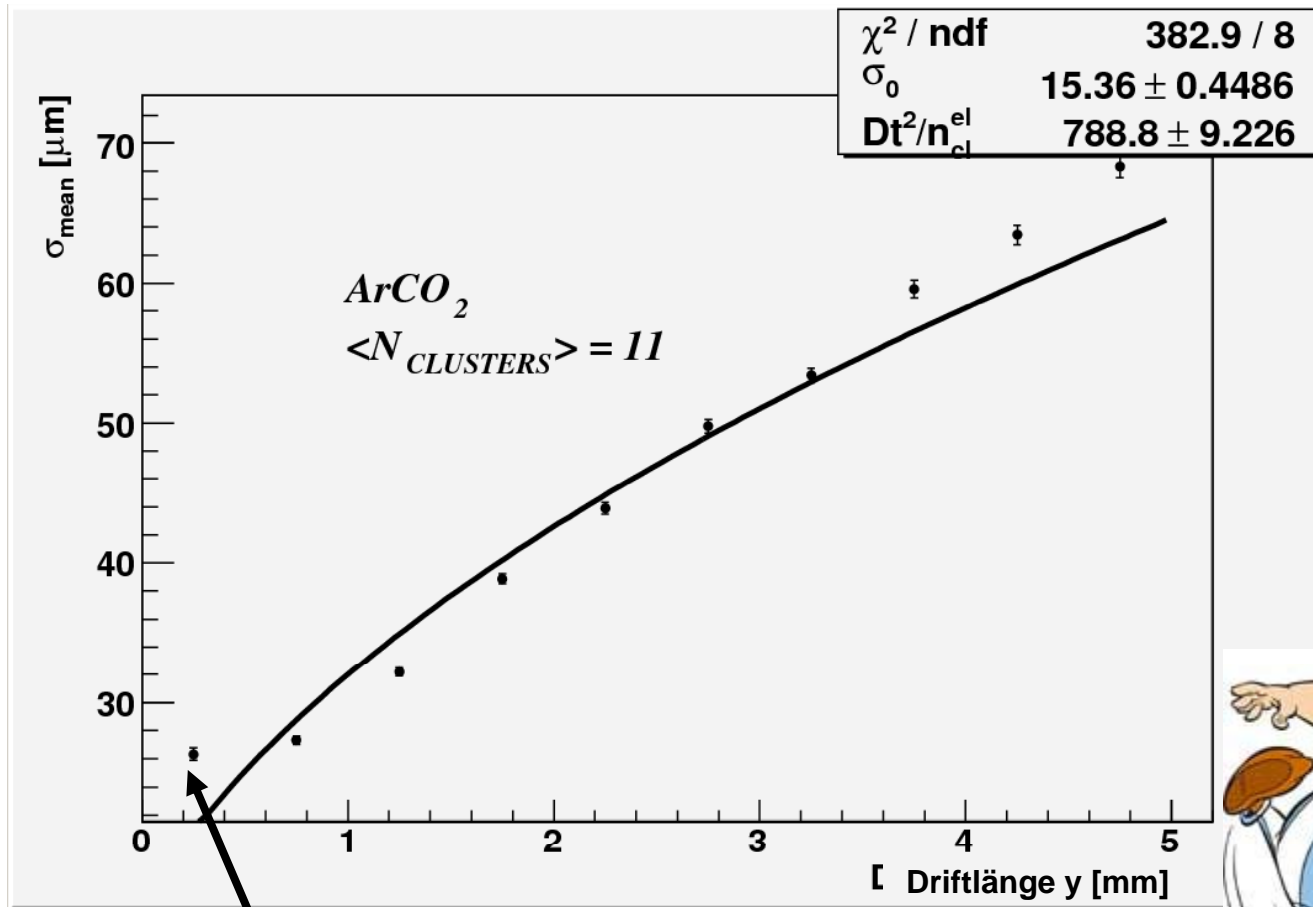

Small GEMs
improve σ_0 by
 $\approx 5\mu\text{m}$.

Still possible systematics ?
it is a delicate range since the fit function has an
infinite slope here
...there are events below the drift region...



Data processing for time walk correction



original data for central column

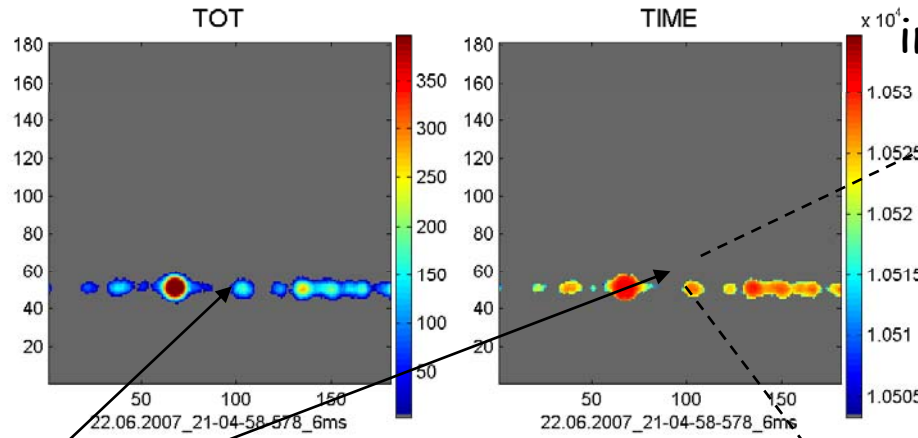

0
10522
93
10526
139
10526
167
10527
186
10527
170
10526
118
10522
35
0

- interpolation of TOT and TIME produces 2 sets of data on each pixel
- for any pixels the time walk can be large
- take maximum in TIME and TOT for the correction. In this case at TOT = 180 the correction amounts to +2.7 counts to be close to the asymptote, where all clusters should lie.

selected cluster

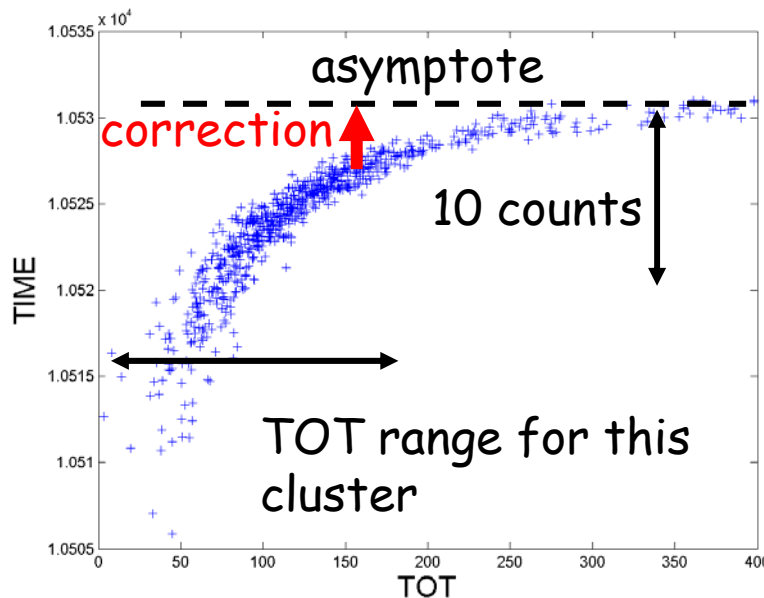

Treatment of time walk correction

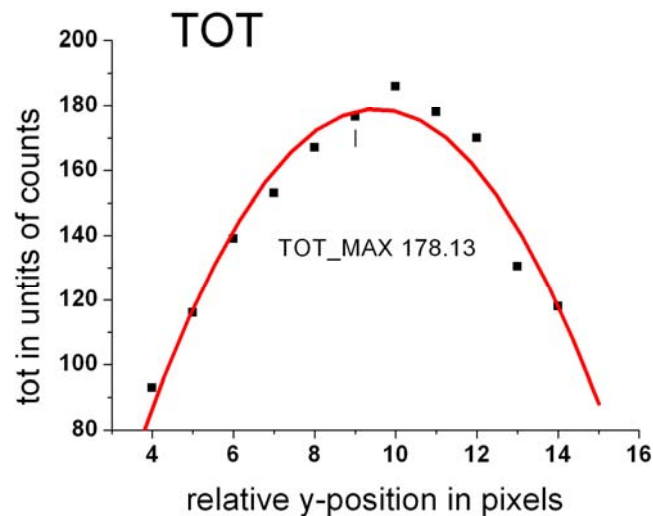
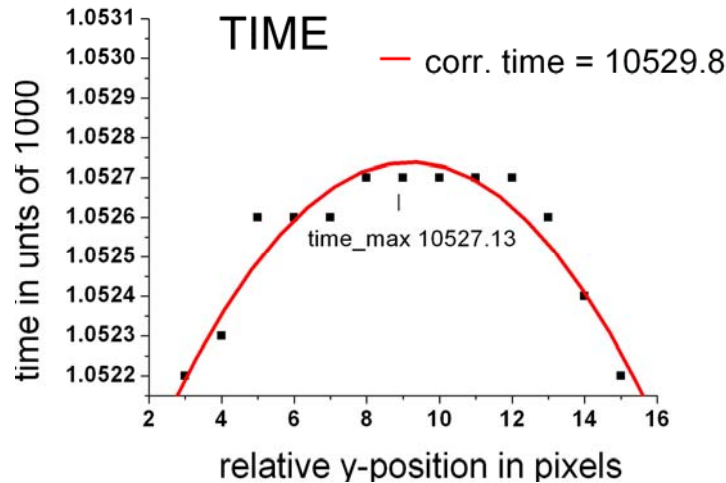

- Select a column near the centroid of the cluster
- Fit 2nd order polynomials to the TIME and TOT distributions, look for maxima
- Time walk correction done only by the maxima of fits
- Time correction with an exponential function

$$t_{corr} = TIME_{max} + Ae^{-tot_{max}/B}$$

for this run A = 24, B = 81

After correction of time walk for a 100 MHz clock

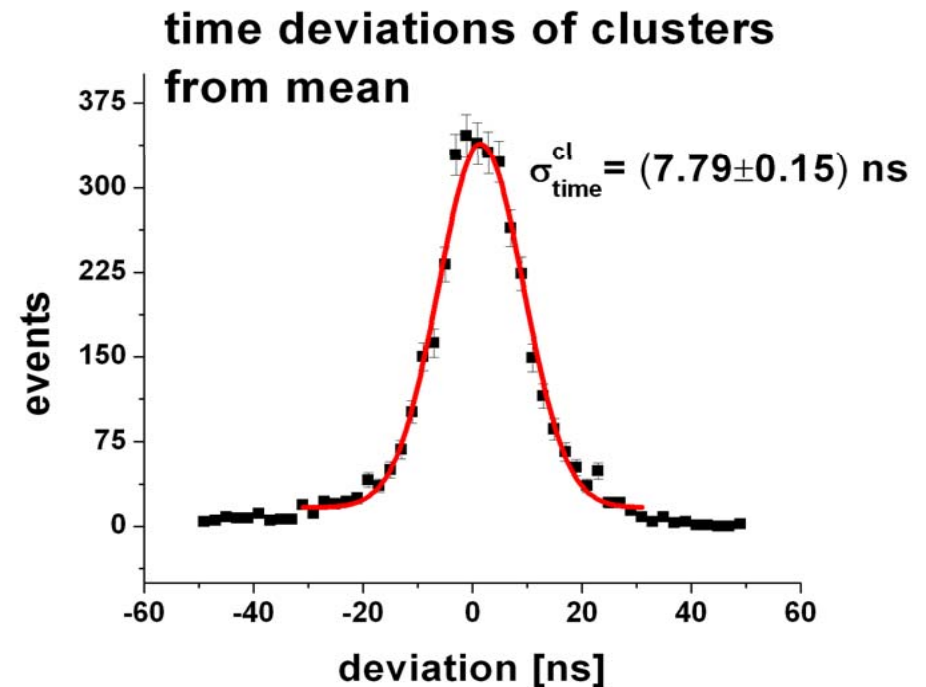
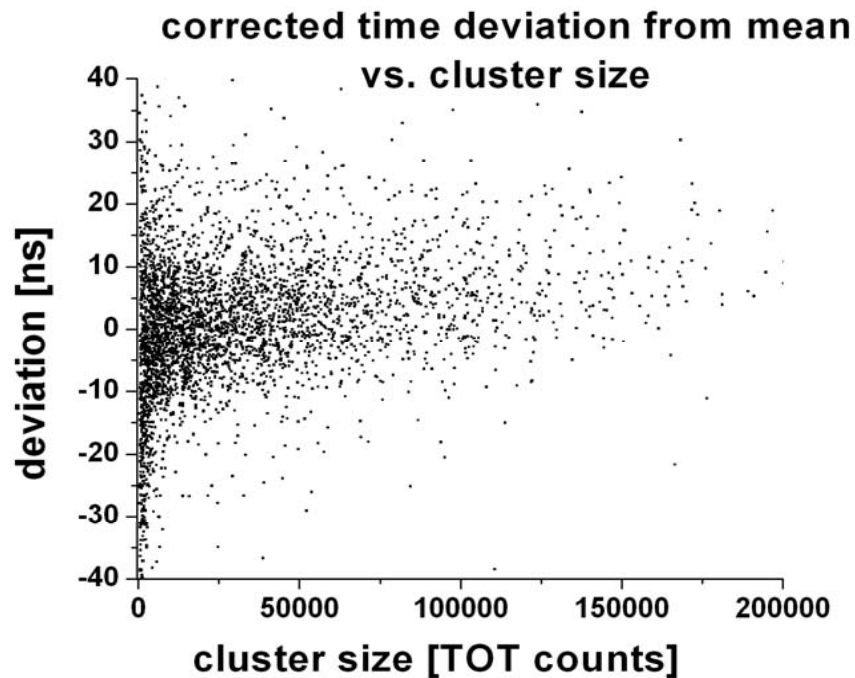

Similar results from the 48 MHz data (2006)
operation: σ_{time} about 12 ns

Measurements with laser



Installation of a laser test bench for measurements with a small number of (primary) electrons.

Detector with metallized drift cathode.
The laser releases single photo-electrons
⇒ creation of well defined and separated clusters

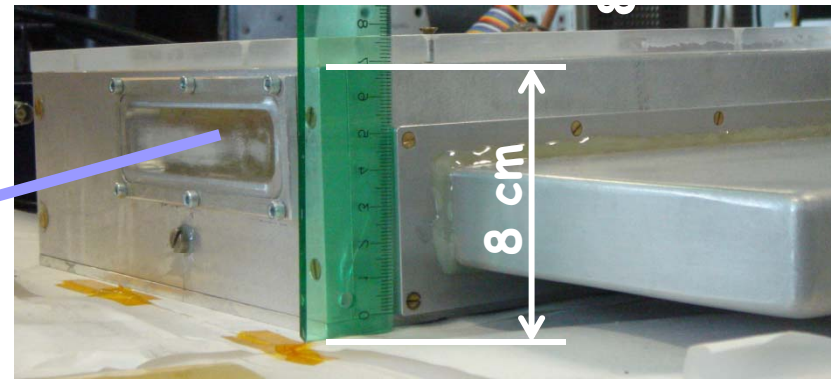
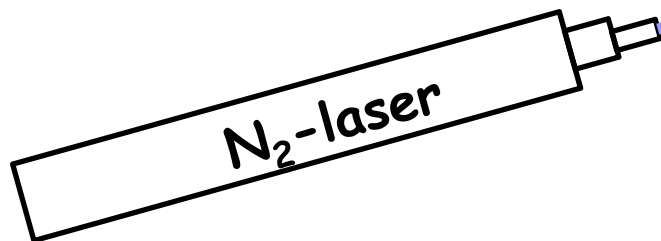

- Study single electron clusters
- Investigate influence from number of primary electrons on single point resolution.
- Possibly study ion backdrift properties

Chip Post-Processing

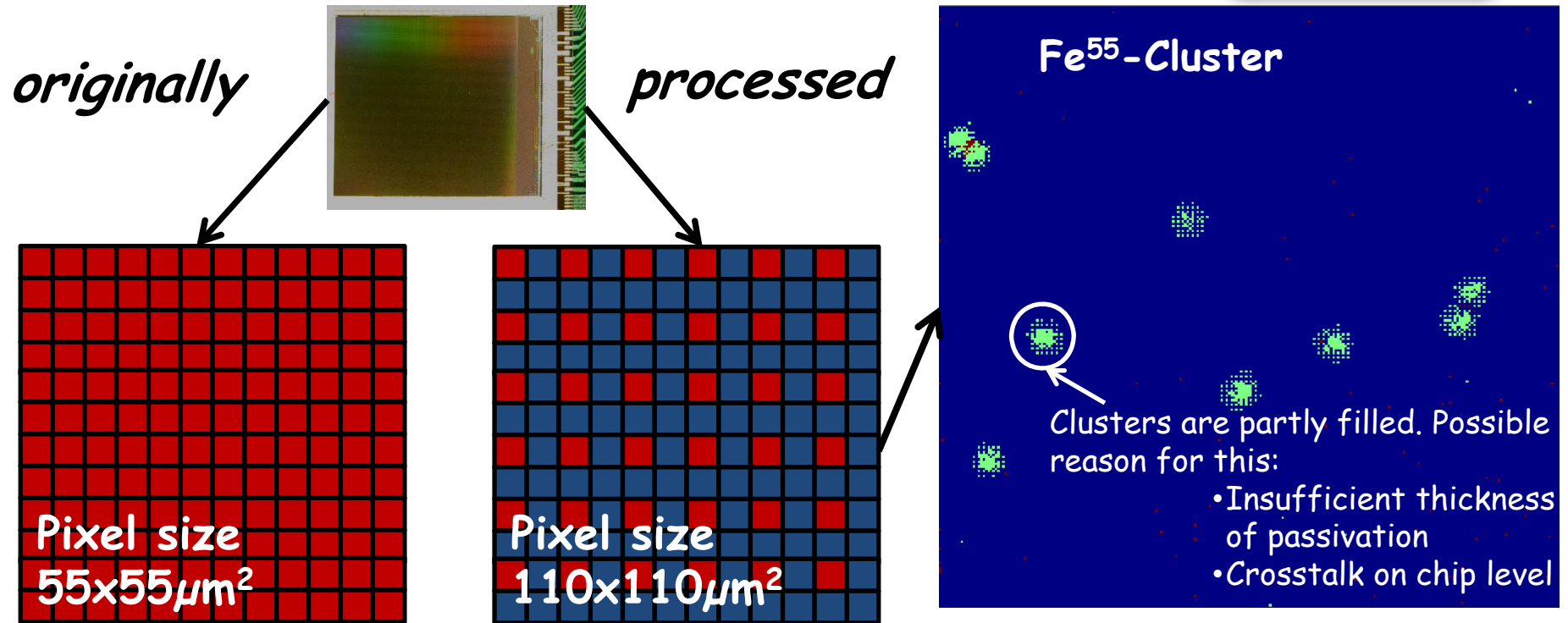

- Pixel active
- Pixel passivated

- Work on technologies for post processing chips
- Optimization of readout granularity

Pixelman Design



Pixelman architecture

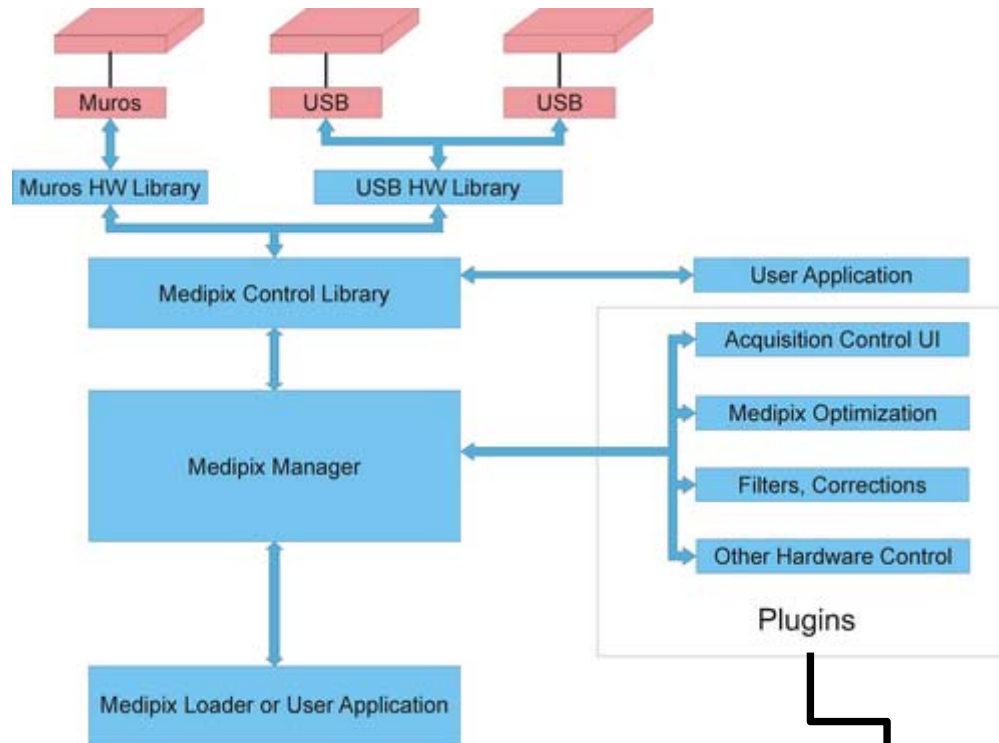

<http://aladdin.utef.cvut.cz/ofat/others/Pixelman/img/arch.png>

All basic functions of the Pixelman Software are hardcoded and cannot be changed by the user. The source code is not available.

Interface Pixelman through a dynamically linked library (DLL)

Pixelman Interface DLL



- Pixelman is Windows based
- Pixelman is written in C++
 - one is obliged to use the Microsoft Foundation Classes (MFC) which wrap the Windows® Application Interface (API) into a more user-friendly class architecture
- However today's Windows developer use the .NET framework (CLR). This is „incompatible“ with Pixelman.
 - MFC is already a kind of old fashioned

First Plugins



The screenshot displays the MpxServer software interface. It includes a main window with a red background and the text 'EUDET'. There are several smaller windows: a 'Test Pulse' dialog box (circled in red), a 'Motor Controls' dialog box (with a blue arrow pointing to it), and an 'About' dialog box. The 'About' dialog box contains the text: 'MpxServer Version 1.0 Copyright (C) 2006 Socket Server Plug-In, written by L. Tlustos'. The background of the software interface shows a red car on a rocky surface.

More „mature“ Plug-In for step motor control

First plug-in was a kind of „toy“ plug-in to gain experience. But be warned - as it turns out it is not so straight forward to implement a Graphical User Interface (GUI) into a DLL. But the Prague people from IEAP were a great help, special thanks to M. Jakubek.

Next steps...



Can Linux and Windows be „friends“?

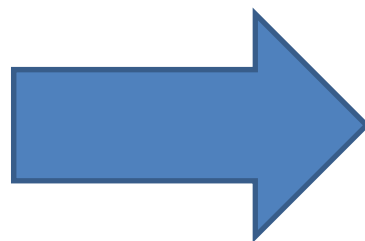

...or the question how can we manage on a reasonable (short) time scale to have a Linux based DAQ steering at least basic Pixelman functions, e.g. Start/stop???

Next steps...



Solution → use network tools

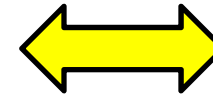
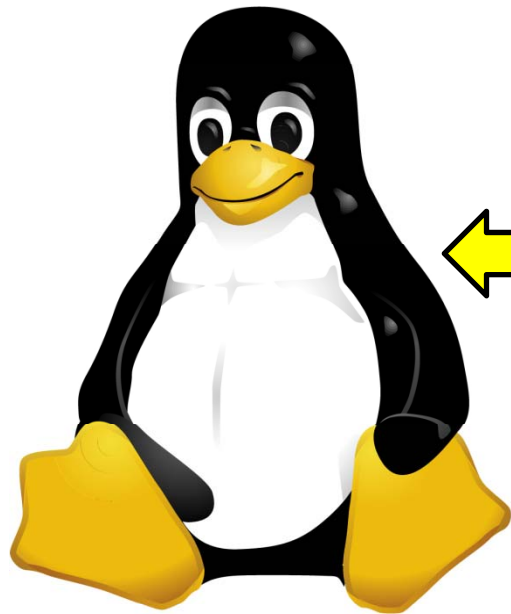

Program a plug-in that uses standard network connections and TCP/IP, so that Pixelman software can be operated by a Linux DAQ-system, e.g. EUDAQ

Next steps...



A socket is a software interface between two programs for interprocess communication. The programs can be running on the same machine or on different machines connected via network.

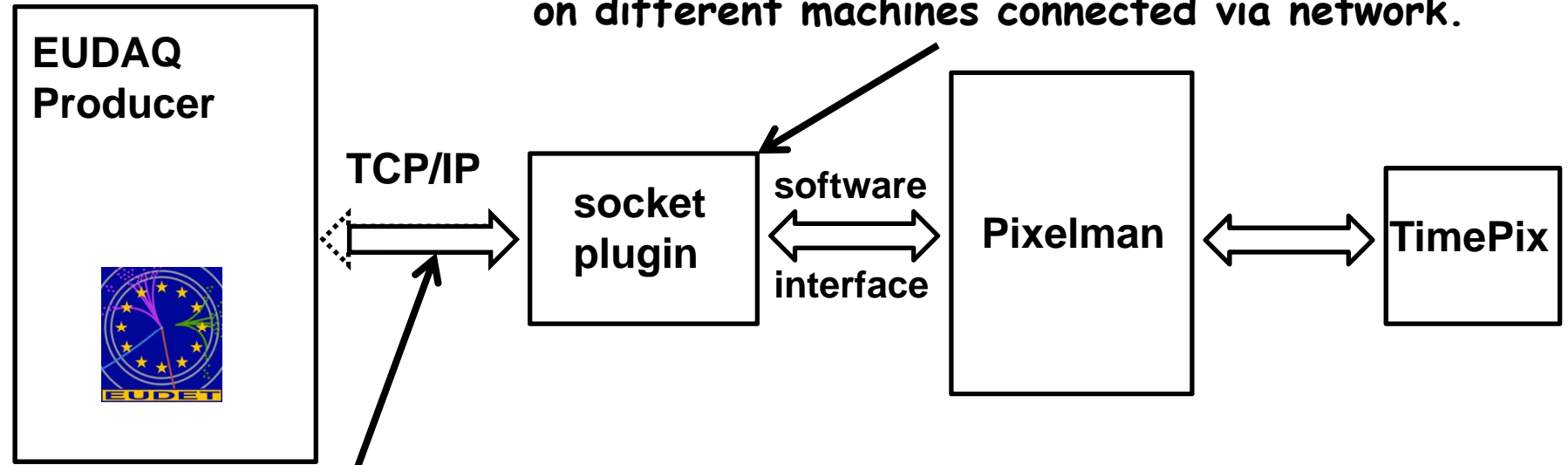

As an option Pixelman can also send commands to the DAQ via the socket plug-in

Details will be discussed this late afternoon Room H331, 6 p.m.

Summary



- Superb spatial resolution of 20-24 μm
- Time resolution of 8ns after corrections for time walk
- -> z resolution of $\sim 0.5\text{mm}$ in typical TPC gases
- First successful test of pixel with enlarged pixels of $110 \times 110 \mu\text{m}^2$
- Reliable operation of TimePix/GEM setup without any special „protective“ „add-ons“

Outlook



- Finalizing setup of laser test-bench, which could be interesting also for other EURECA partners
- Developing software tools for integration with other DAQ systems and slow control
- BUT everybody is looking forward to a first test beam at DESY -> so focus man power and give a good show 😊

Rotated GEM structure (2007)

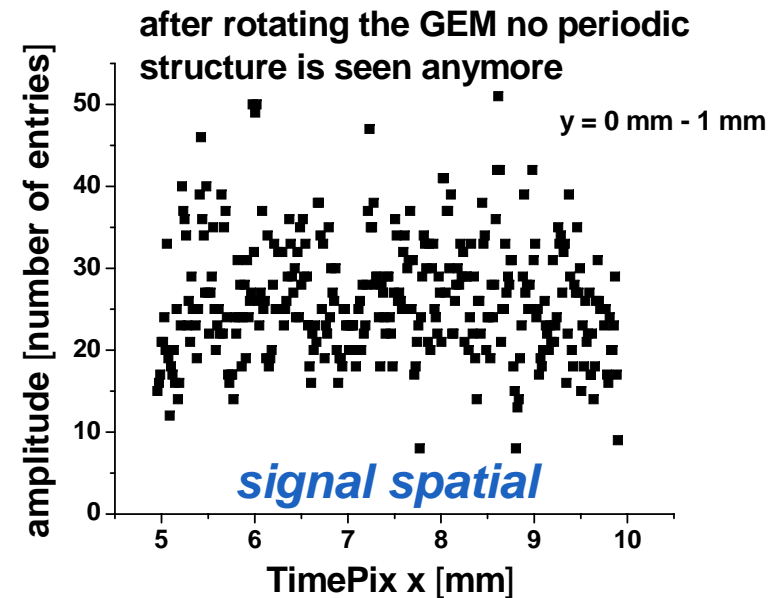
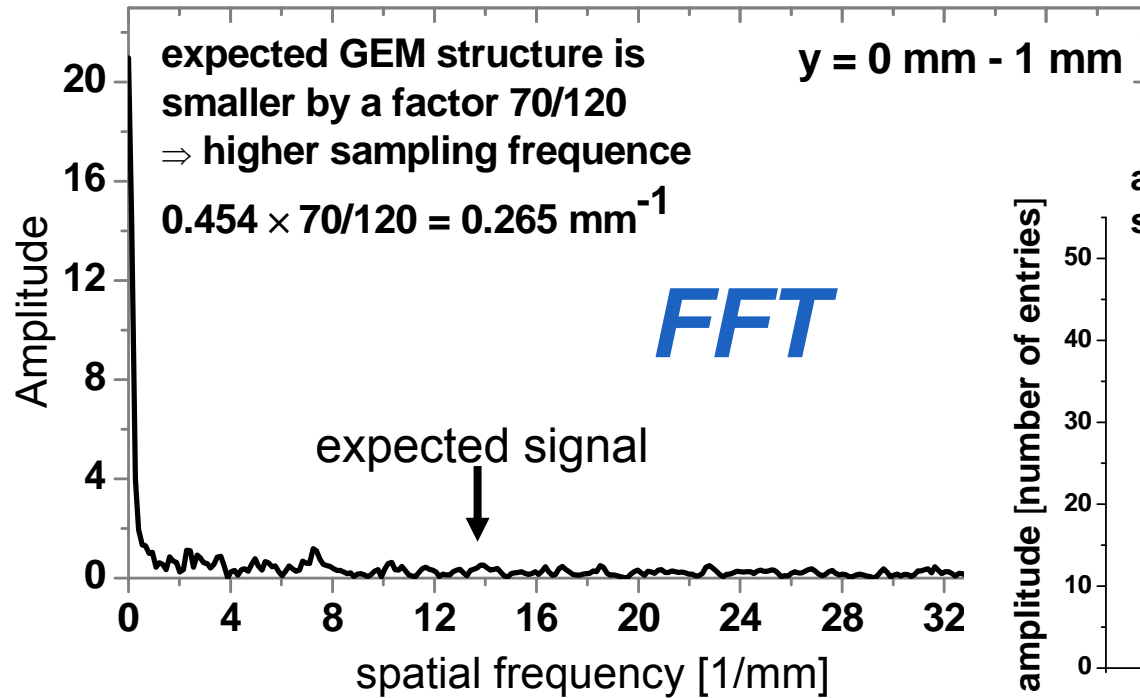

- after rotation by 90° the observed spatial signal from the GEM pitch vanishes
- effect on the resolution is an improvement of $\sim 2 \mu\text{m}$

Simulation studies: *Inverse TPC*

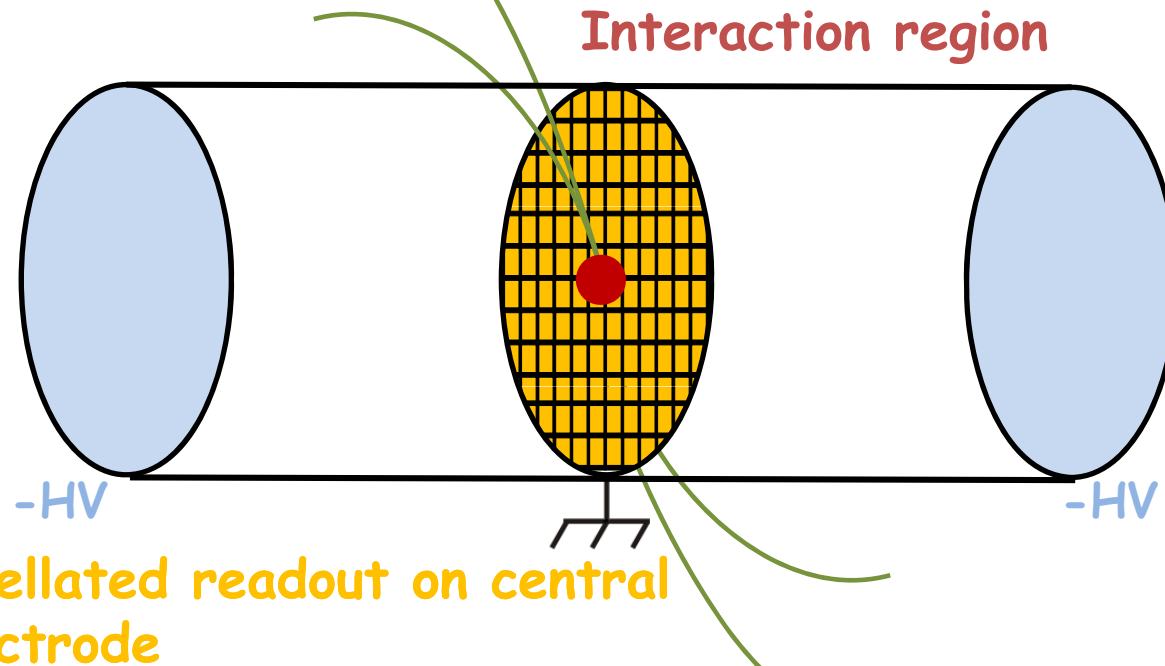

- Investigate optimal pixel size as function of:
 1. Drift distance
 2. Magnetic field
- Studies on technical feasibility, e.g. cooling
⇒ expertise on design integration in Freiburg available

First results with pro-cessed chip

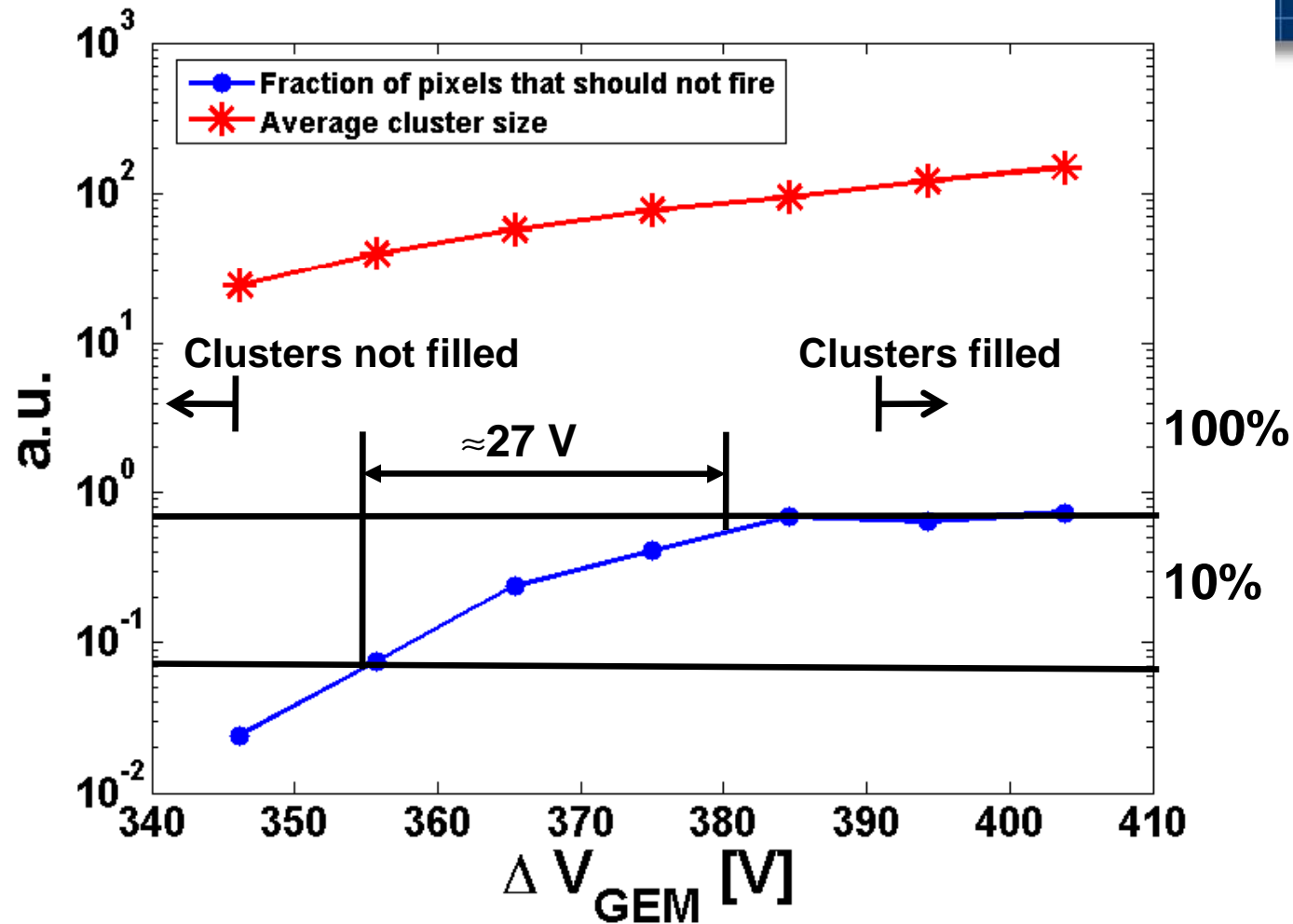

$\approx 27\text{V}$ correspond to a factor 5 in gain.
Ongoing investigation of the cross talk behavior