



# Positron Target Prototype – Current Status

Leo Jenner

Jim Clarke, Ian Bailey

Ken Davies, Andy Gallagher, Lei Zang



# Overview

- Then
- Now
- Simulations
- First torque data
- Thermal Calibration
- Project plan
- Outstanding Issues



Thu Oct 30

ILC Positron Workshop, DL

3



Thu Oct 30

ILC Positron Workshop, DL

4



- Magnetic simulations at DL
- Opera (Vector Fields) with Elektra rotation solver
- Magnet modelled as two coils
- **Eddy current power losses and reactive forces are calculated**
- Superseded by work at RAL...

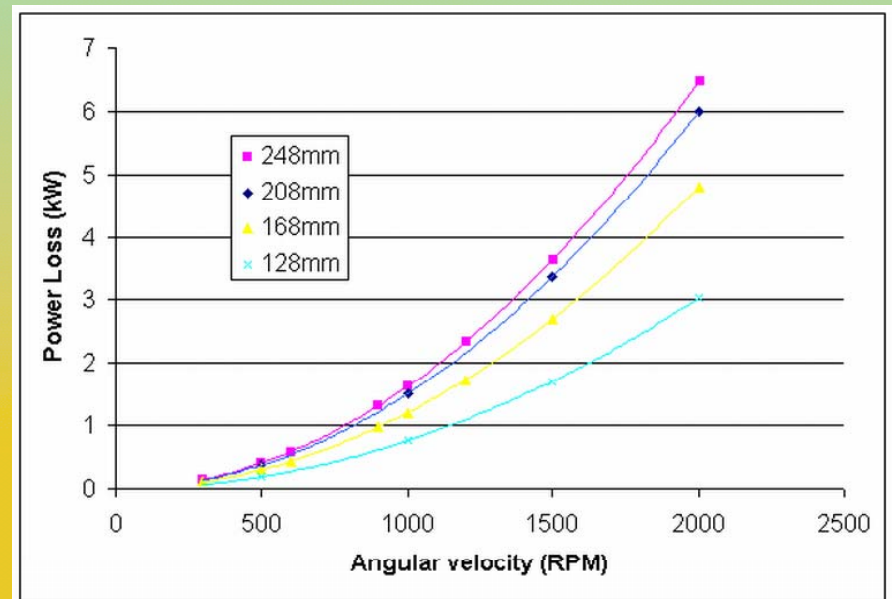
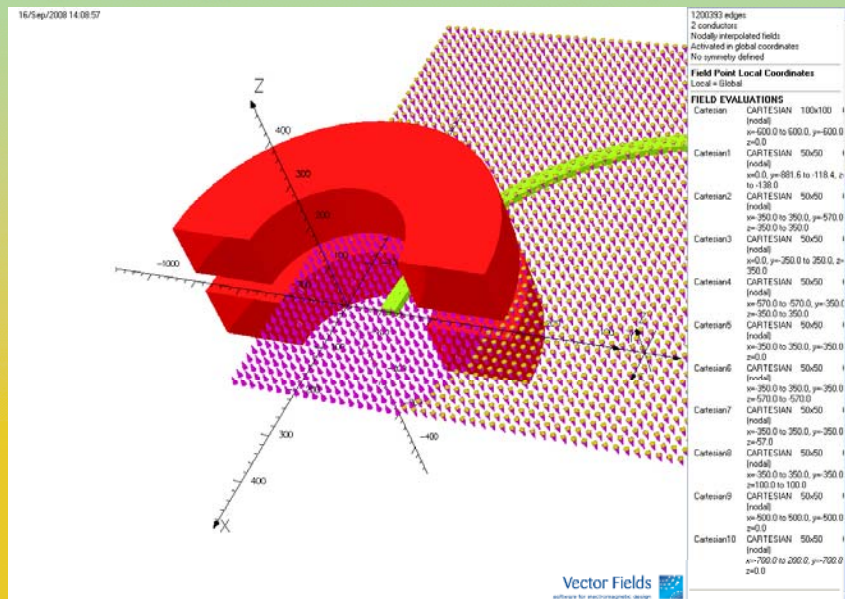
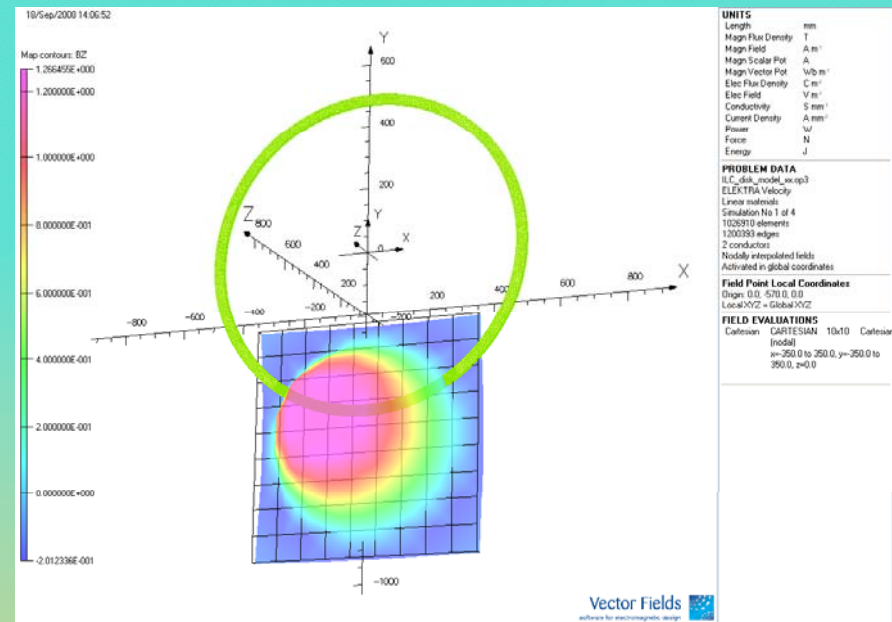



# Eddy current modelling summary

## •Introduction

- From previous modelling
- High confidence in VF Elektra solutions
- Good agreement with spinning disk models

**J. Rochford**

## •Goal

- Determine the effects of the spokes on the stability of the target wheel

## •Next steps

- Use Elektra solutions to benchmark Carmen model
- Work in progress...
- When confident the Carmen solution is realistic will add spokes to wheel model



# Validation of Carmen model

J. Rochford

- Currently
- Working to validate the Carmen models of simple wheel rim
- Models mesh successfully
- A few full solutions calculated
- Strange results
- Initial results not in agreement with Elektra
- Under investigation...
- Carmen is a full transient solver
- Need correct time steps and rotational conditions to get a meaningful comparison

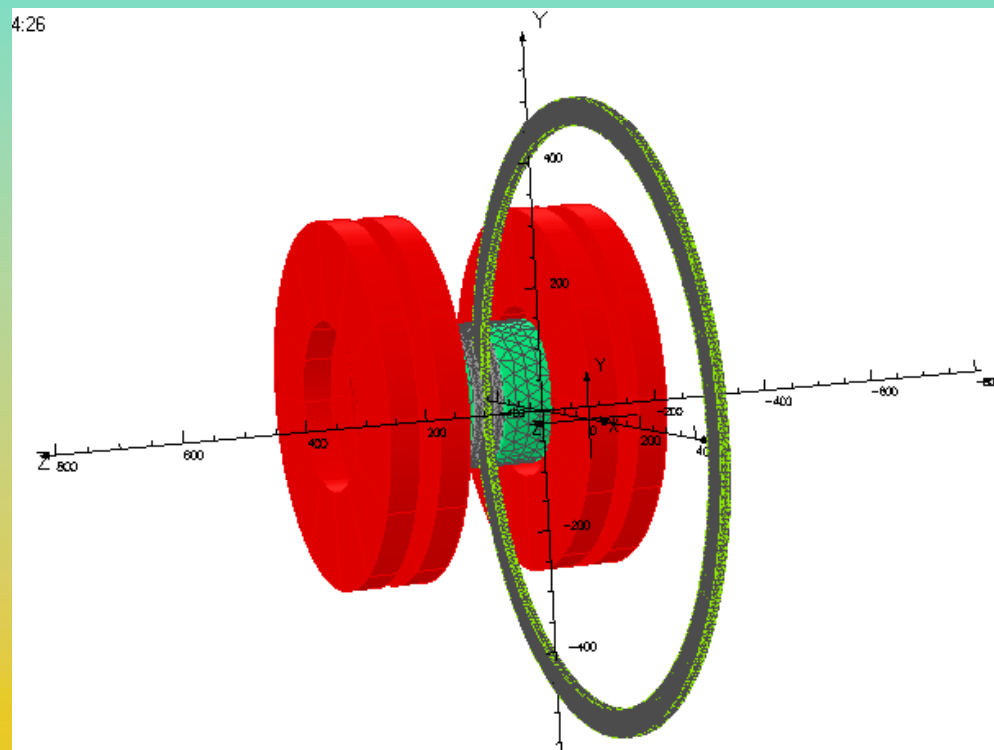



# Final Carmen models

- Next step
- Complete Carmen models of entire wheel constructed
- Initial meshing of problem successful
- Yet to try to run a full solution
- Little sense to attempt this until simpler Carmen wheel rim model validated
- Then run full wheel models
- The effect of the spokes should then be evident

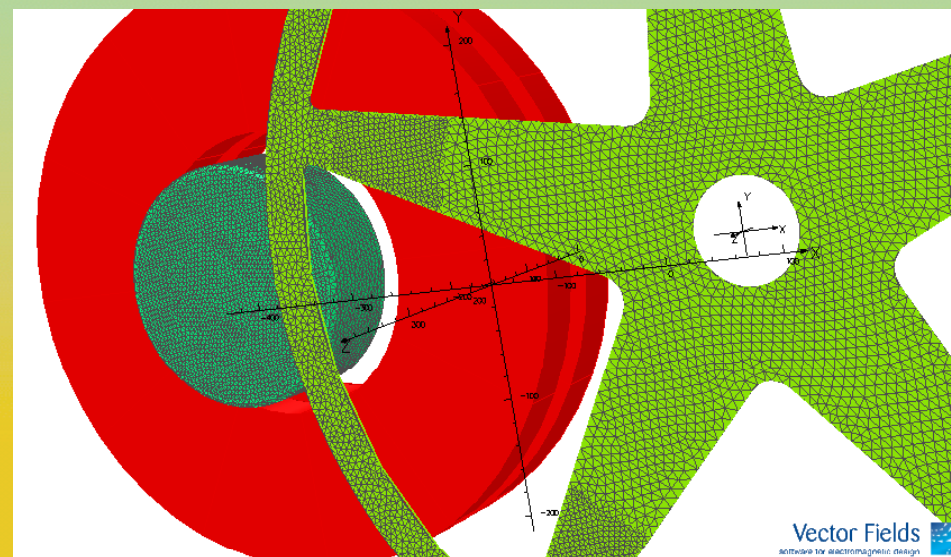
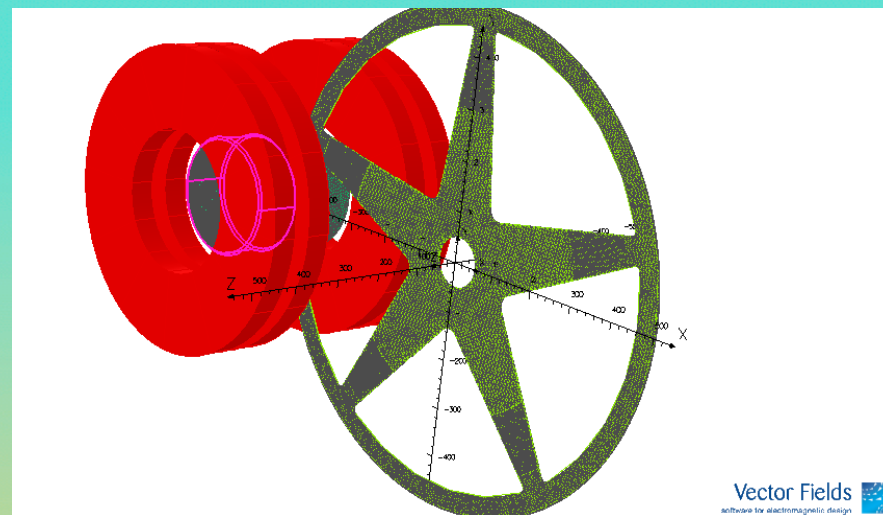





# The plan is still the same...

- Sweep in parameter space of B-Field, Rotation Speed and Immersion (1 T, 2000 rpm, 50 mm)
- Observation of kicks as spokes traverse field
- Measurement of eddy currents by torque and direct heating ( Lei )
- Study of rotor-dynamics (LLNL: accelerometers)



Motor Control: Blue – requested rpm, Green – encoder

Torque transducer: Red – rpm, Black – torque (Nm)

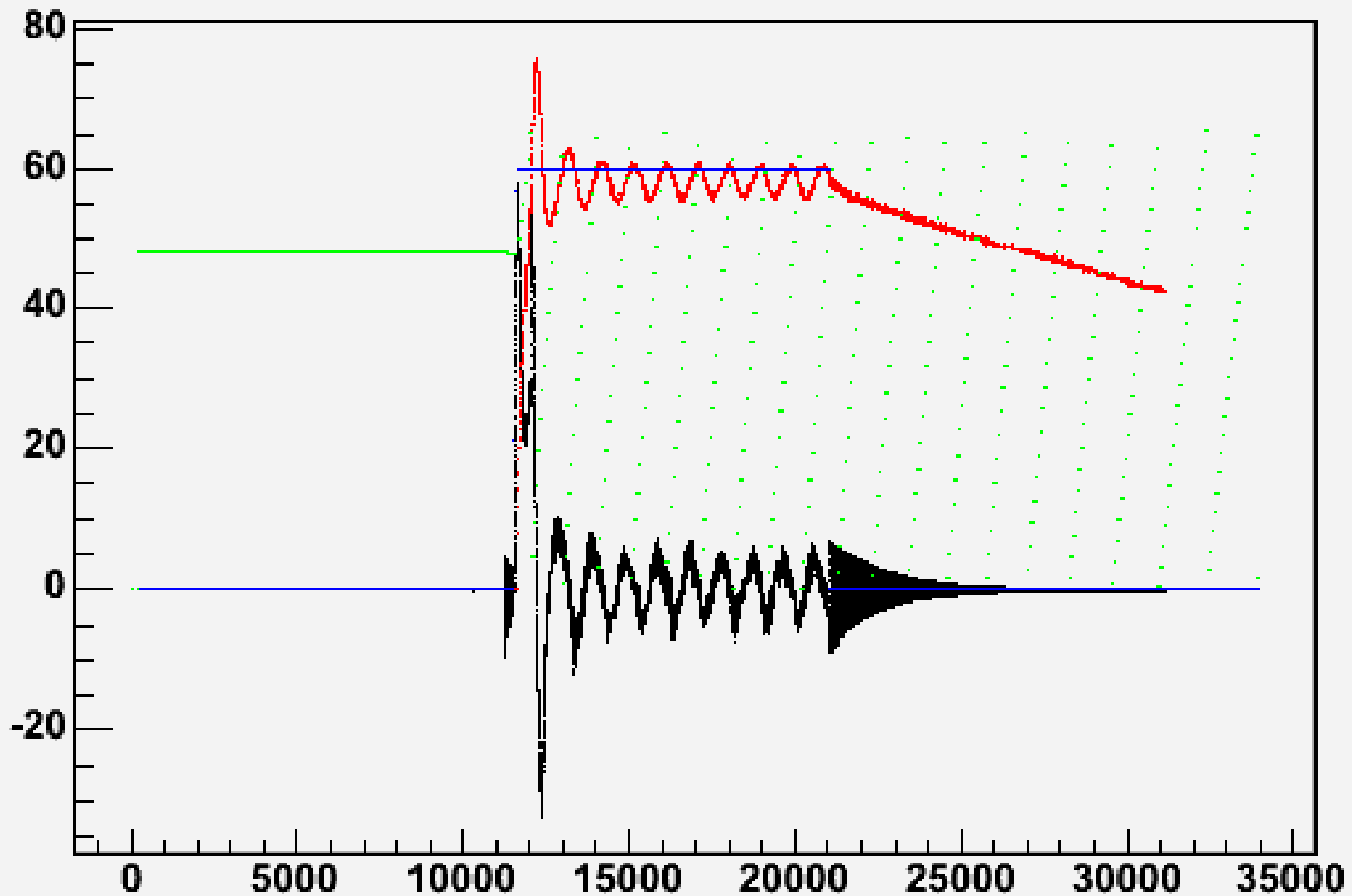

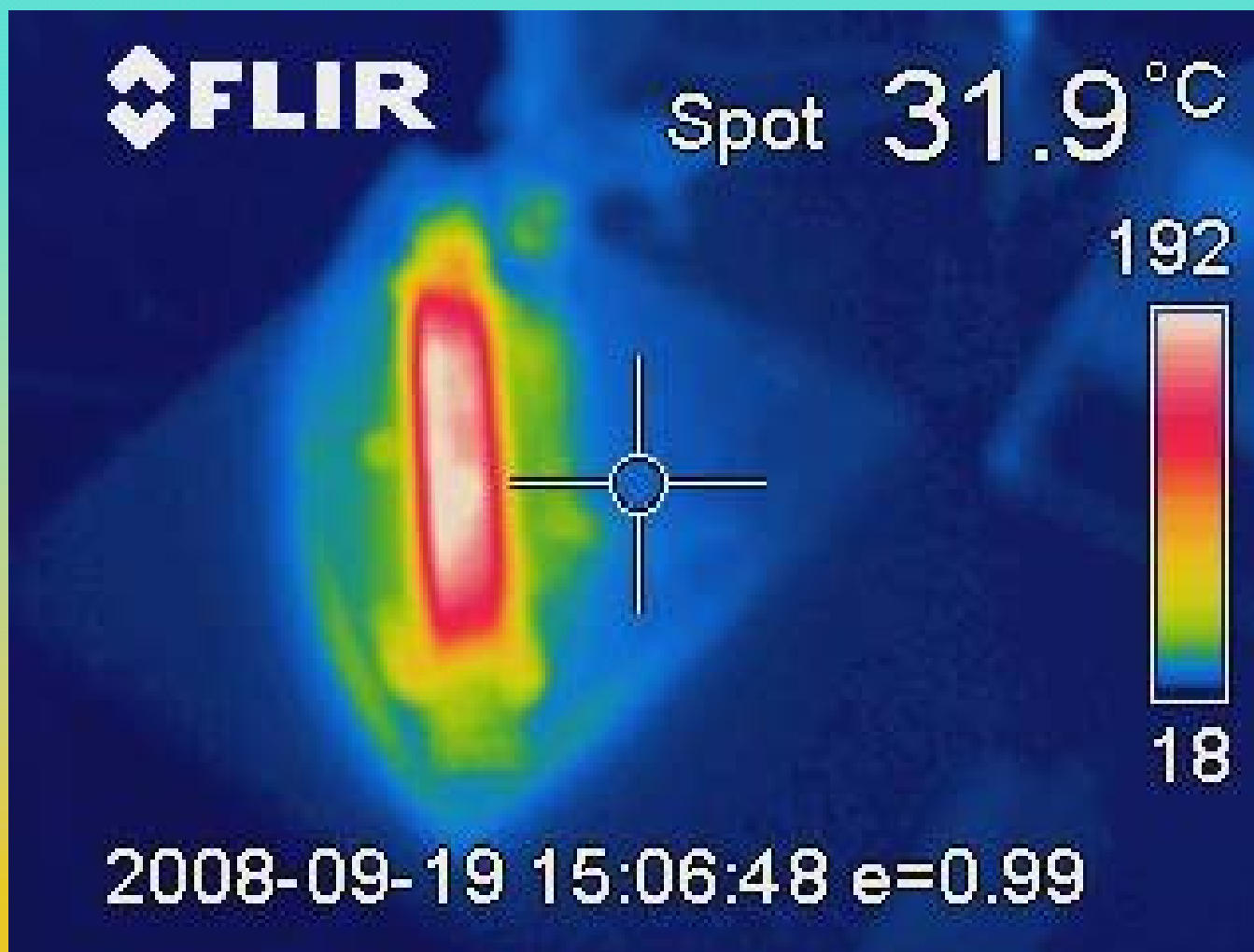



# Just waiting on:

- **Final safety sign-off**
- ...Immersion calibration
- ...Water and power re-connection to magnet
- ...Cooling nozzle design and implementation
- I've still got one month...



Data taking begins shortly !  
...hopefully...

(I look forward to showing you around  
tomorrow!)



**...ACTION!**



Torque drives speed change (matched but slightly ahead in time)

$T_{osc} = 1 \text{ sec @ } 60 \text{ rpm} = 1 \text{ rev per sec}$  ( x-scale = milliseconds )

Speed and Torque overlaid only for shape comparison purposes (not same scales)

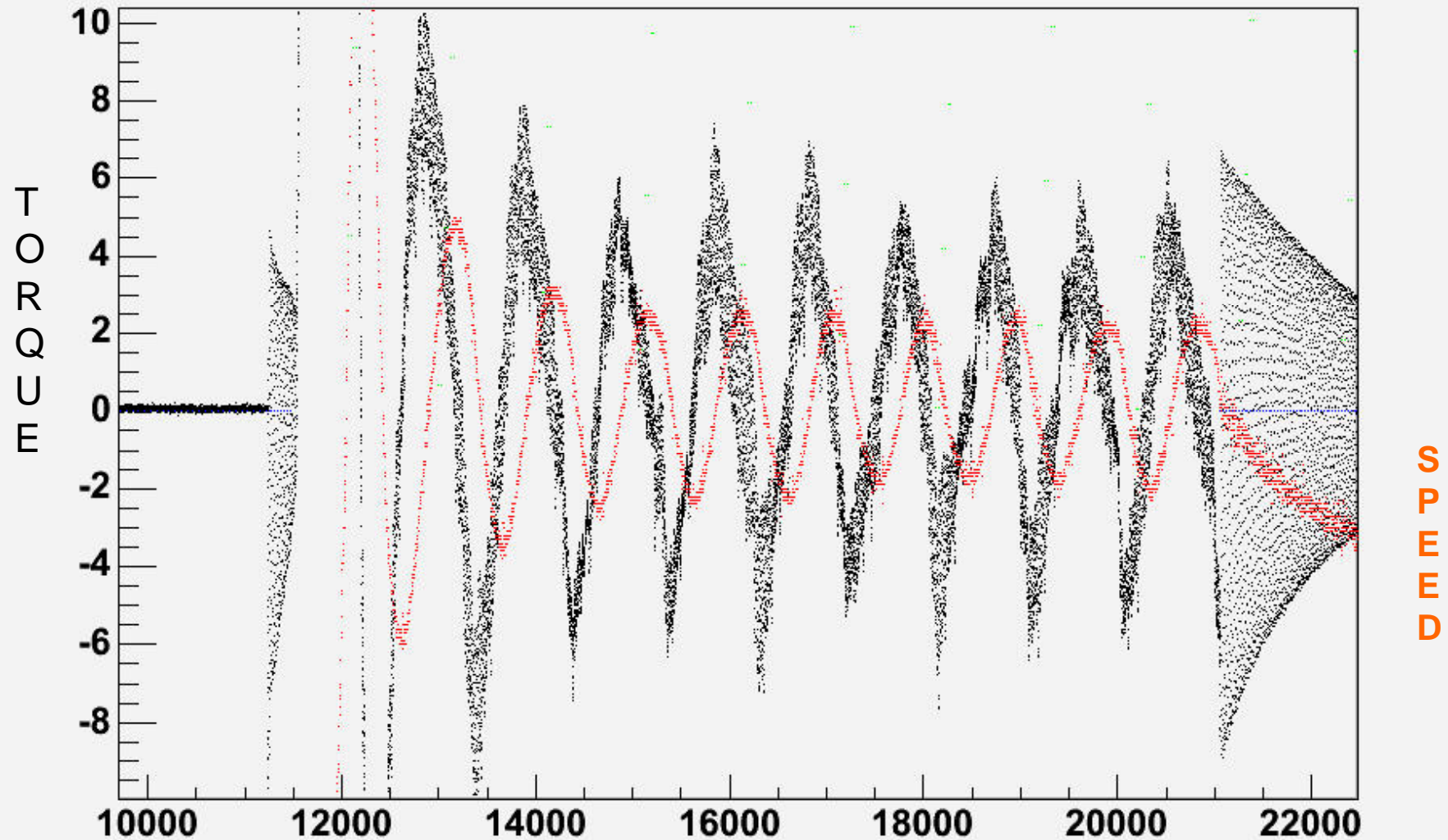



- Speed = 30 rpm
- Oscillatory structure far less clear
- Not obviously 2Hz as expected
- Speed well short of 30 rpm
- Too slow for torque transducer?
- Calibration?

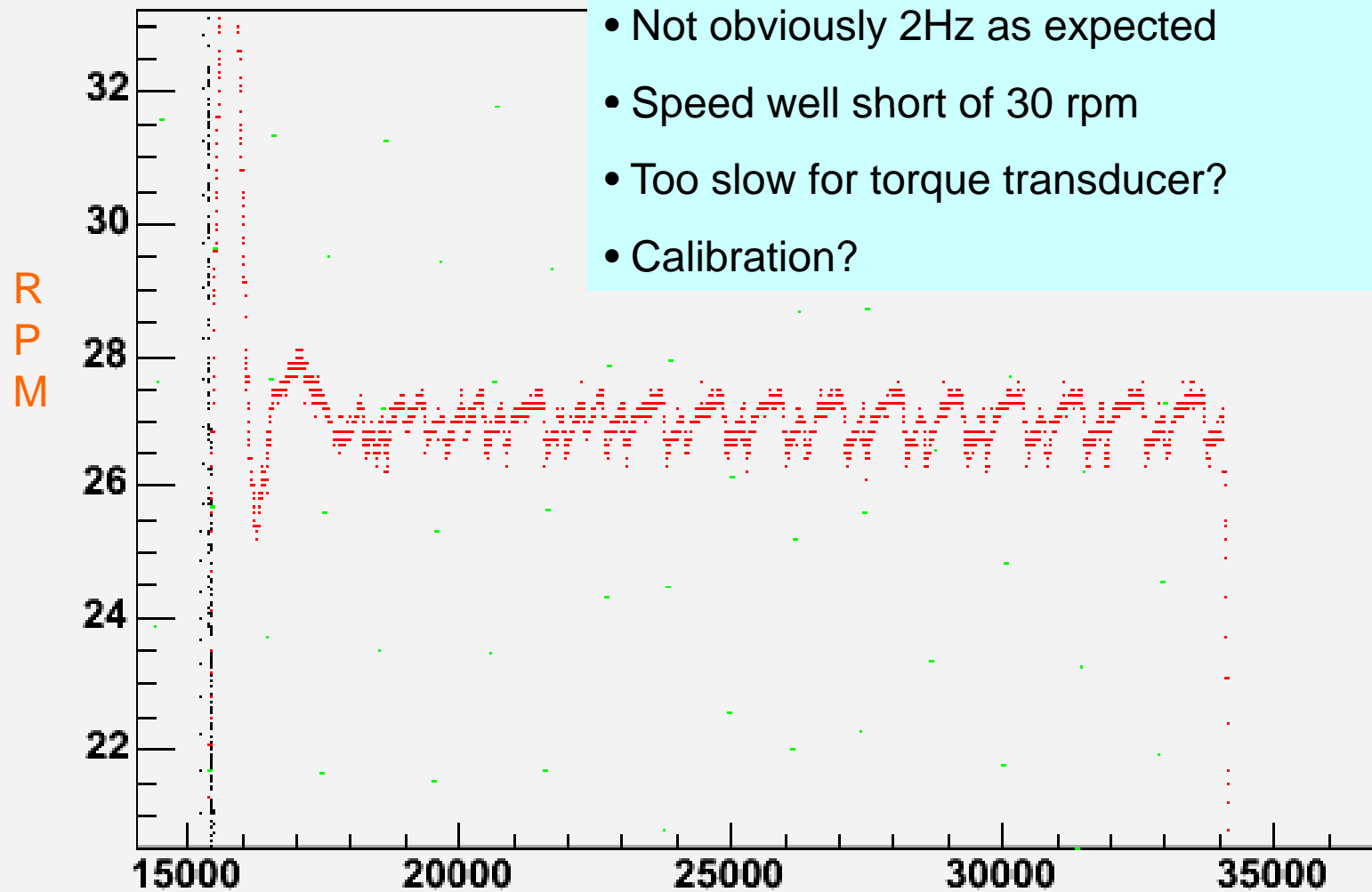





Hi Leo

The models use the Electra VL solver (not normal electra solver) the normal electra module solves for time varying electro magnetic fields the VL version models the effects of motion induced eddy currents, it does this by assigning an a velocity vector to the conducting material, it is assumed that the driving fields are stationary and the eddy are induced in the moving component, It also assumes that the geometry does not change with time,(for the wheel problem this means we cannot model the spokes). The CARMEN solver is a full transient solver it allows parts on the mesh to rotate it solves for eddy currents induced in a conducting media by time varying fields and by motion. The solution makes no assumptions about the problem symmetry.

hope this helps

cheers jim

**James Rochford**

Science & Technology Facilities Council  
Cryogenics Group, Technology  
Rutherford Appleton Laboratory  
Harwell Science and Innovation Campus  
Building R65 G08

Chilton, Didcot  
OXON  
OX11 0QX