

ATF Plans for Emittance Tuning

S.Kuroda(KEK)

- What's New in ATF Operation
- DR Emittance
 - Emittance tuning and measurement
 - Measured emittance
 - Data for check and comparison
- Summary and Discussion

ALCPG09/GDE meeting, Albuquerque, 2009

DR Emittance

- We have measured ε_y of 5-10pm in 1999. But since then we hardly measured such low emittance because the other R&D have been majority of the ATF study.
- Typical emittance measured in 2008 was 20-30pm.
- These days, some experiments require low emittance in DR.
 - For ATF2 $\sigma_y^*=70\text{nm}$, $\varepsilon_y=24\text{pm}$ is needed.
 - For ATF2 $\sigma_y^*=35\text{nm}$, $\varepsilon_y=12\text{pm}$ is needed.
 - For study of fast ion instability, $\varepsilon_y<10\text{pm}$ is needed.
 - For ILC DR study, goal emittance is $\varepsilon_y=2\text{pm}$.
- Goal of DR Study Group: to reproduce as small emittance as 5-10pm, and then challenge to lower emittance such as 2pm.

What's New in ATF Operation

- Start with 'design optics' and optics correction(β beat correction)
- DR re-alignment in summer 2008
- Introduction of electric load for DR main bend.
- New QM7R.1 with larger bore radius
- ...
- Off course, the biggest issue is the new ATF2 FF and EXT line.

DR Optics

Optics mismatching ?

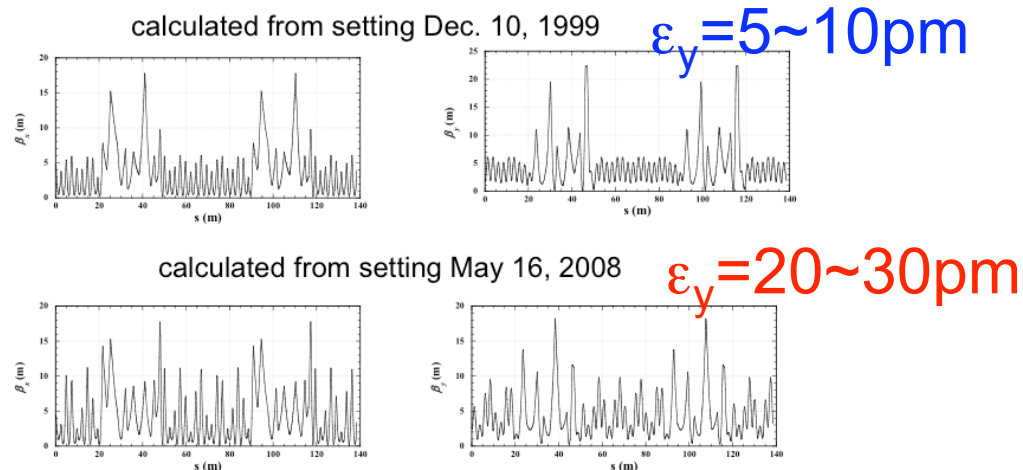

Kubo pointed out that the optics distortion is the one of the source of large emittance in DR.

Kubo, Special ATF2 Project Meeting, KNU, 2008

- ‘design optics’ was made in 2007
 - Re-matching
 - Tune adjustment to measured tune
- DR commissioning has started with ‘design optics’ in Nov. 2008.

DR Re-Alignment in Summer Shutdown 2008

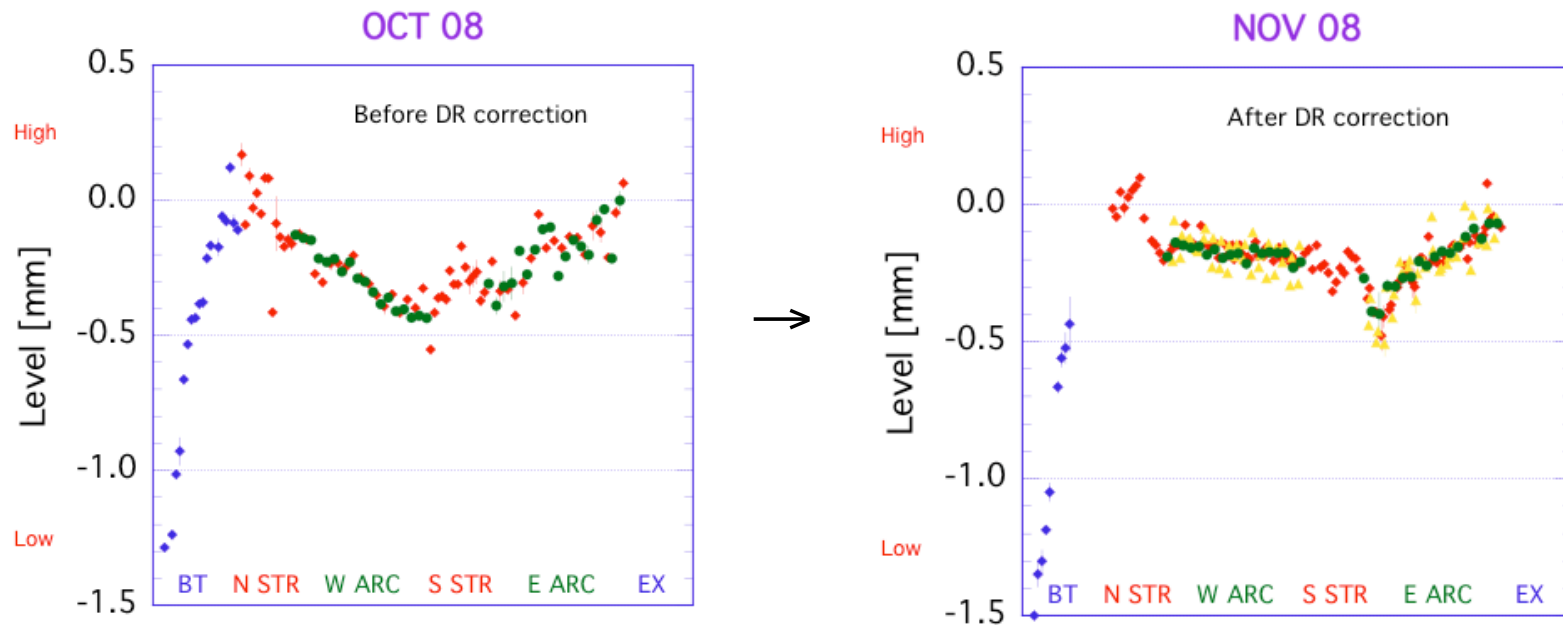

M.Takano

Alignment done for

V position: All around the ring

H position: Straight section

Electric Load for DR Main Bend

- 36 B magnets in DR
- 6 of them were productions of different maker from the others, and the field characteristics is slightly different.
- Correction has been done by trim coil, but it does not seem enough. The trim current $< 8A$ due to heat-up of the coil(the coil is air-cooled).
- Introduction of electric load is expected to improve the DR orbit, ...
- $I_{EL} < 13A$, by power dissipation.

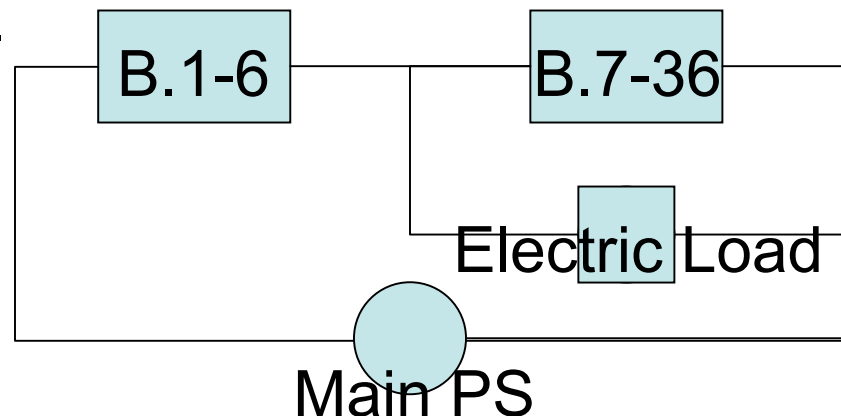

DR Emittance Tuning

- β beat correction
 - Using QM trim, new QM7, IHEP Q trim and QF1&2(for tune adjustment)
- Orbit correction
 - Using correctors for several settings of the Bend trim and electric load
- Dispersion correction
 - η_x in straight section is corrected by QM trim
 - η_y is corrected by correctors
- Coupling correction
 - ONLINE correction: Correction of vertical leakage of the horizontal kicks by a couple of horizontal correctors.
 - OFFLINE correction: The same as ONLINE correction but using data by all the horizontal corrector in the arc.
 - Correction is done by Skew Q winding trim coil of SX.

DR Emittance Measurement

- Beam size measurement
 - SR Interferometer
 - Quick measurement, 5ms
 - Minimum beam size can be measured is ~5-6 μ m
 - Suffering from mechanical vibration
 - XSR monitor
 - Quick measurement, 20ms \rightarrow 50Hz oscillation?
 - Minimum beam size can be measured is ~5-6 μ m
 - Less mechanical vibration but still.
 - Laser wire
 - A few ten minutes requires for measurement
 - ‘design’ laser waist size is 6.5 μ m \rightarrow going to higher mode, beam size of 1 μ m can be measured.
- Beta function measurement
 - Fitting β of Qs nearby which were obtained from tune slope.

Measured DR Emittance

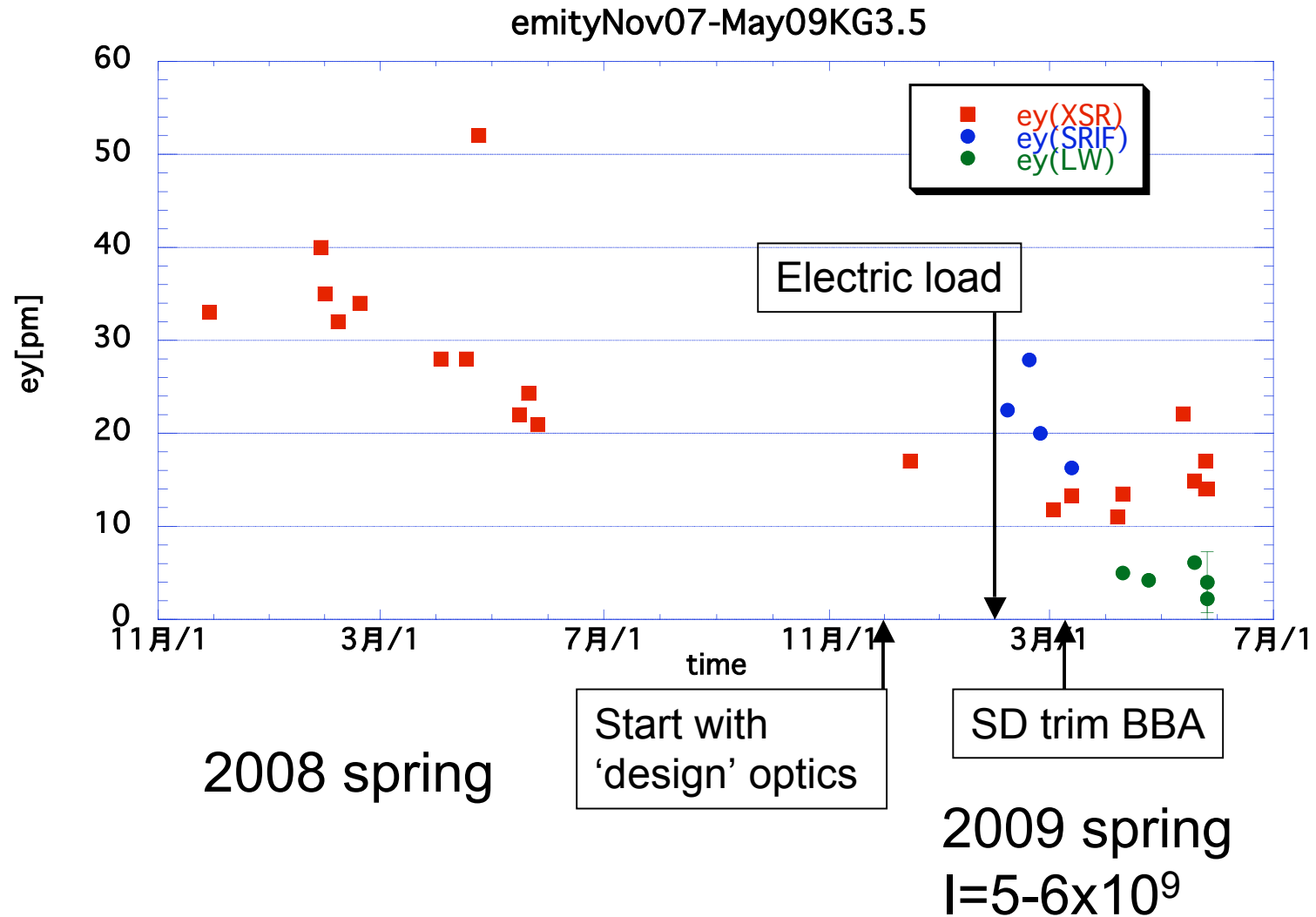

Laser Wire Measurement

H. Shimizu

y = m1+m2*exp(-(m0-m3)^ 2/2/...		
	値	エラー
m1	-20.595	15.994
m2	700.77	42.571
m3	-3.8824	0.00058967
m4	0.0084625	0.0006329
力積乗	21435	NA
R	0.98464	NA

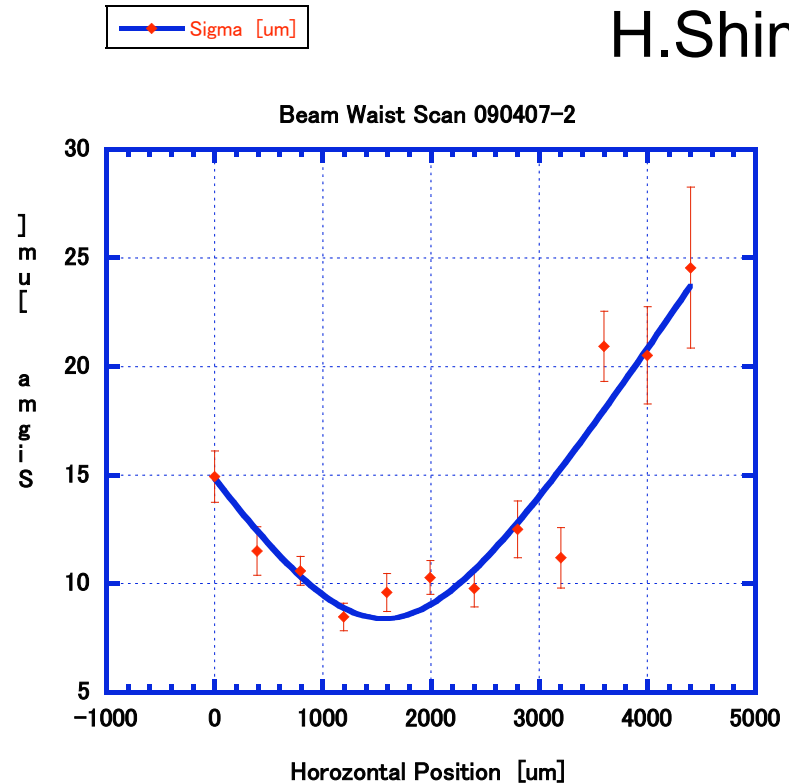
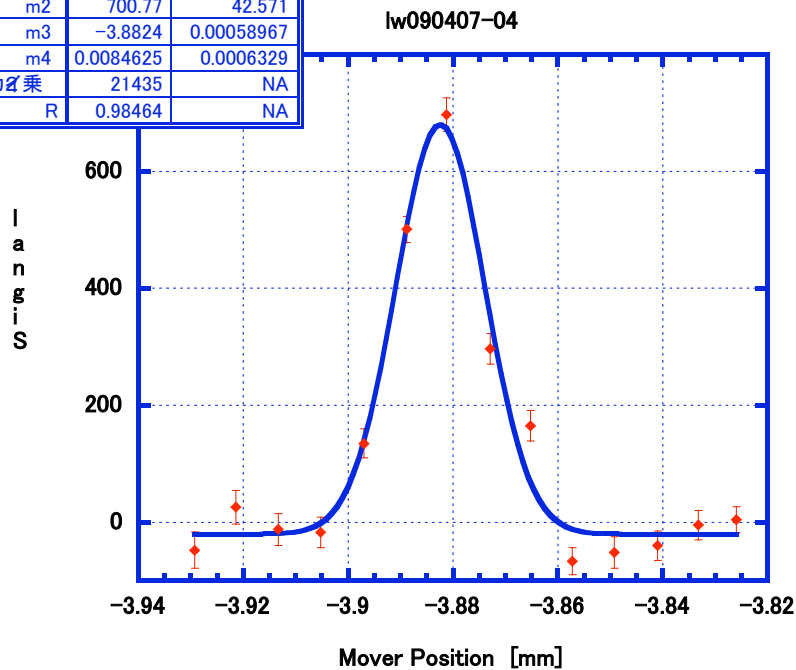

Minimum size measured=8.46um
 Measured Laser waist=5.96um
 → e beam size=~6um

Scanning in horizontal position

Fitting with
$$\sigma_{\text{Obs.}}^2 = \sigma_e^2 + \sigma_{\text{LW}}^2$$

$$= \sigma_e^2 + \frac{\lambda}{4\pi} z_0 \left\{ 1 + \frac{(z-c)^2}{z_0^2} \right\}$$

e beam size=6.41±1.07um

Assuming $\beta_y \sim 5\text{m}$, $\varepsilon_y \sim 7\text{pm}$

Beam Current Dependence of DR Emittance

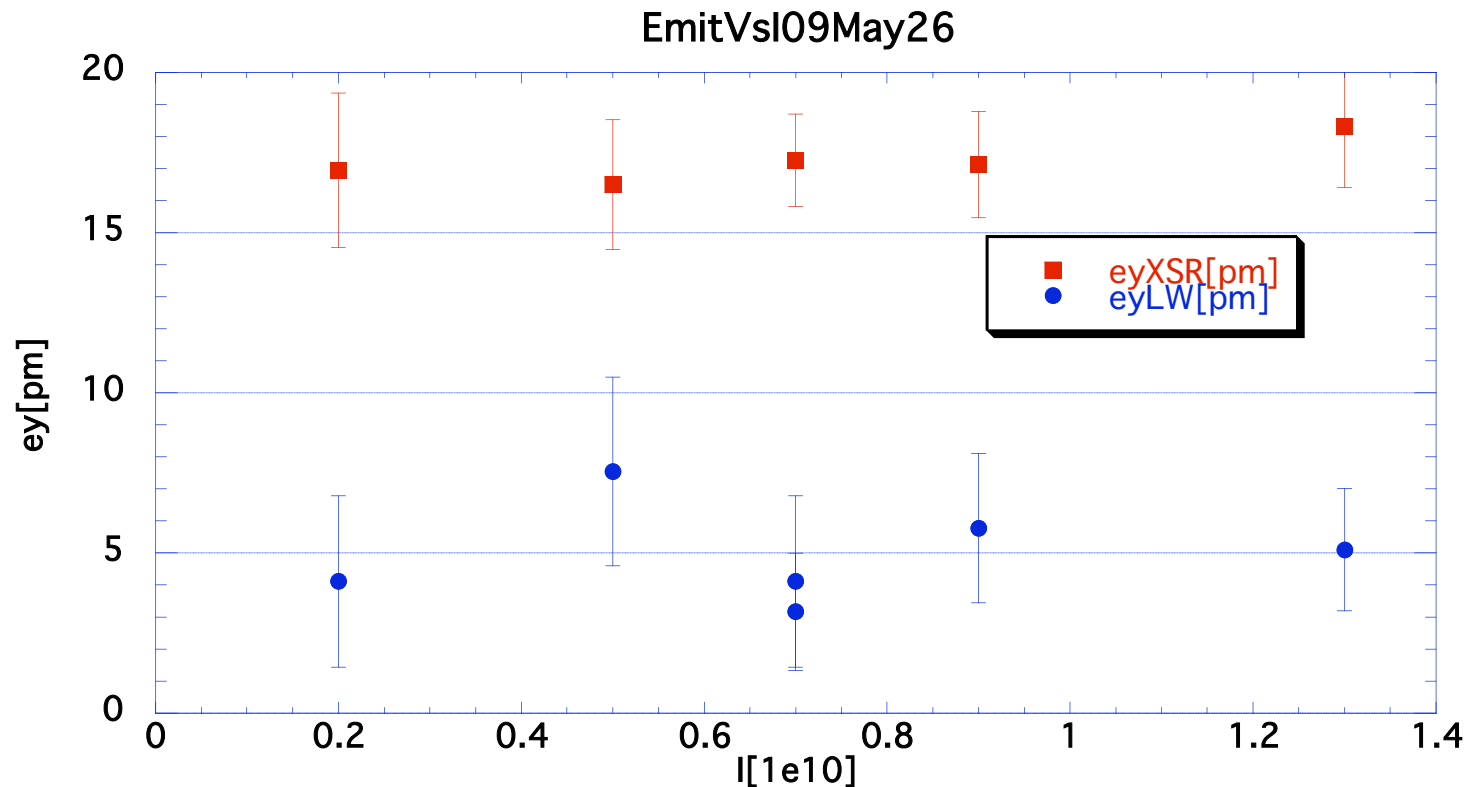

No significant current dependence could be seen.
There must be intra-beam scattering effect
→ emittance already smaller than measurement limit?

Measurement Method Comparison in Big Emittance Case

Emittance 20090611

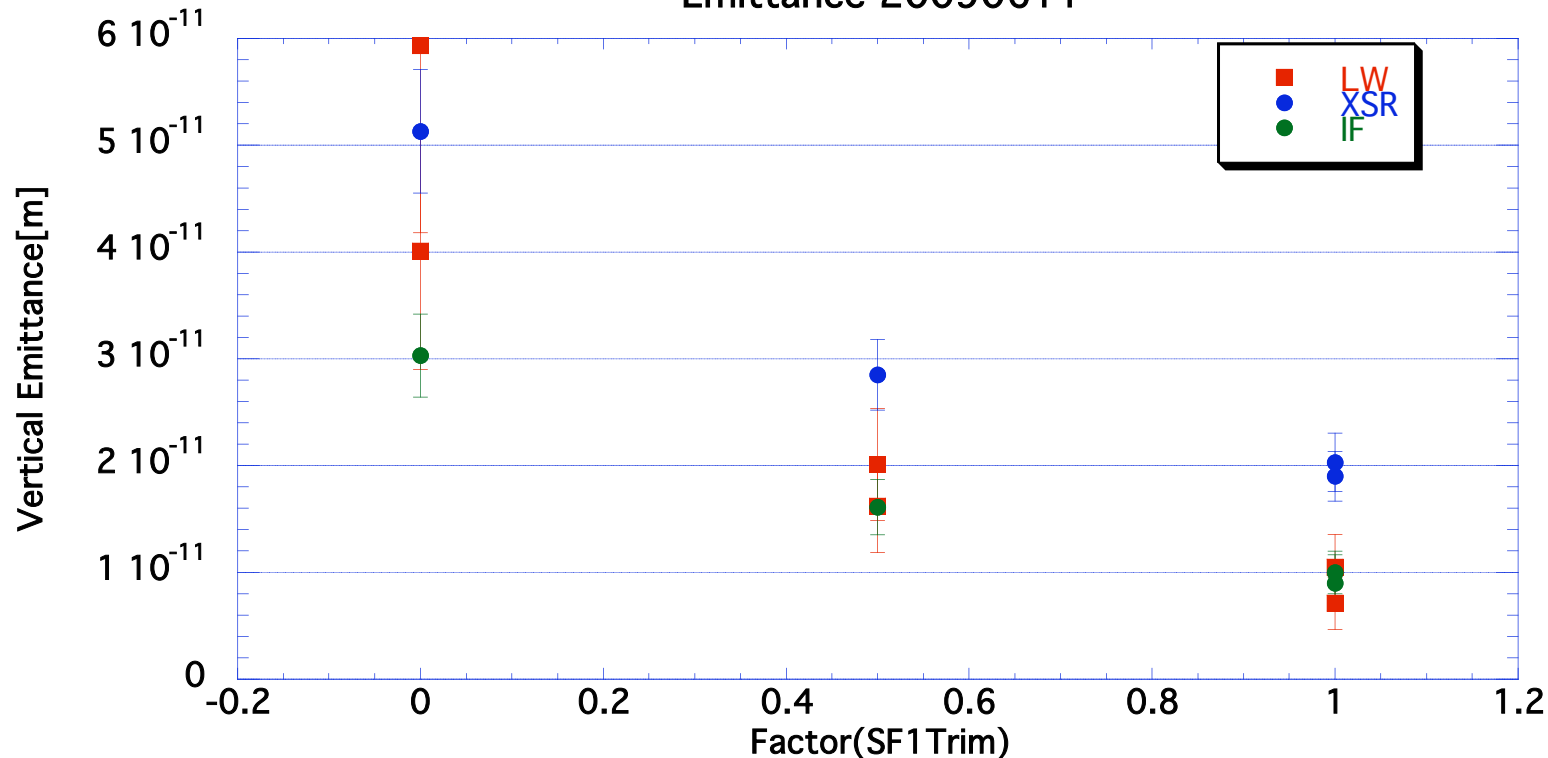

- Change skew Q strength(Factor=1(normal correction) \leftrightarrow Factor=0(no correction))
- Discrepancy seems to begin at Factor>0.5. When $\varepsilon_y=20\text{pm}$ measured by XSR, $\sigma_y=7.7\mu\text{m}$ with $\beta_y=3\text{m}$. $\sigma_y=7.7\mu\text{m}$ is already beyond the XSR measurement limit?
- At Factor=0, all the measurement agree within error bars, but the error bar is very big.
- IF measurement result is very close to LW one. IF setup was tuned up well by an expert(T.Mitsubishi) before the measurement.

Summary and Discussion

- DR emittance
 - The vertical emittance of ATFDR is $\sim 12\text{pm}$ (by XSR monitor).
 - Measurement errors
 - 10% for both of beam size(by XSR) and β measurement statistically. Then the error of measured emittance is $\sim 14\%$.
 - Need to check minimum σ_y measurable by XSR.
 - When we measured $\varepsilon_y = 12\text{pm}$, $\sigma_y = \sim 6\mu\text{m}$ and $\beta_y = \sim 3\text{m}$. If the 50Hz oscillation is $\sigma_{50\text{Hz}} = \sim 4\mu\text{m}$ which was observed in 2007, $\varepsilon_y = \sim 6.6\text{pm}$?
 - Plans for much smaller emittance:
 - BPM upgrade
 - Full ORM analysis will improve the emittance?
 - Need reliable monitor(e.g. LW w higher order mode)