

# Main Linac Basics

D. Schulte

Beijing September 2009

# Introduction



# SLC

- The only linear collider so far

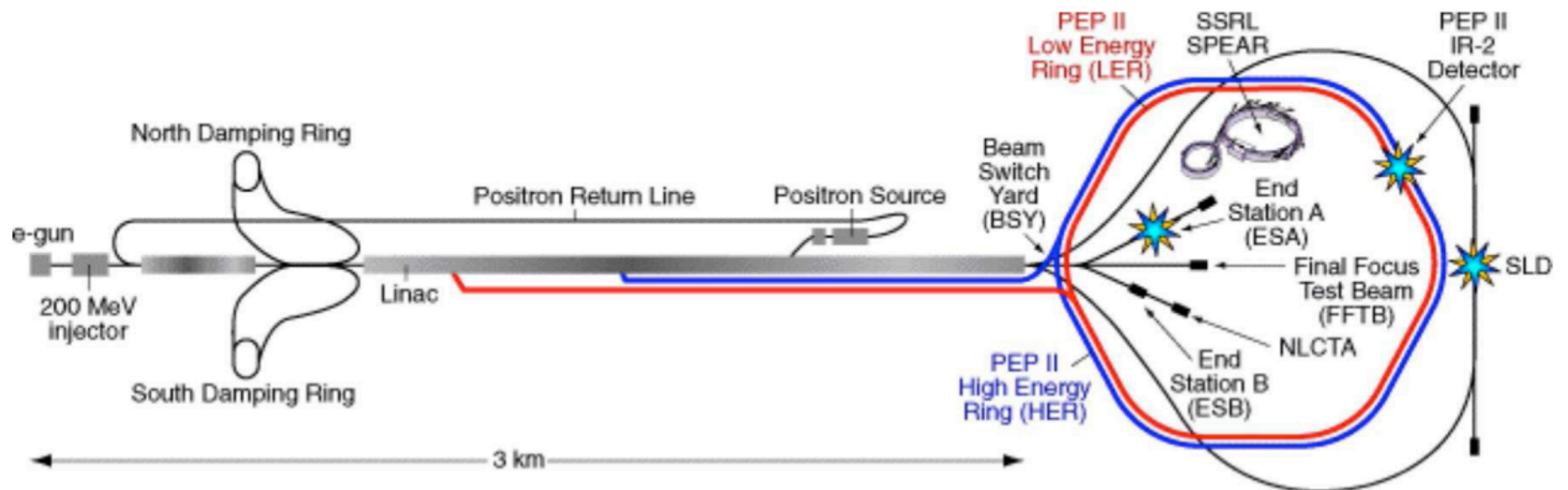

# Tunnel Layout (ILC)

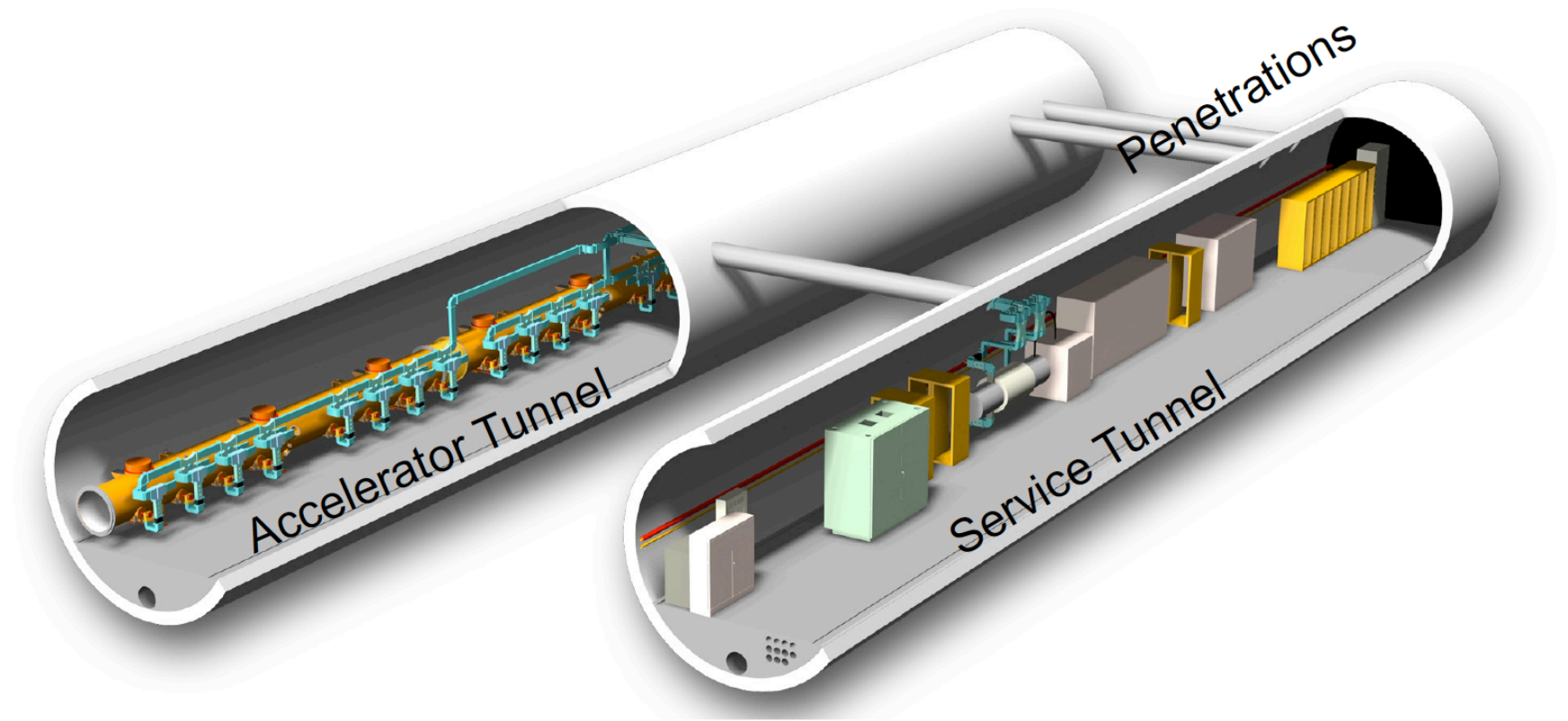

## Module Design (ILC)



# RF Unit Design (ILC)

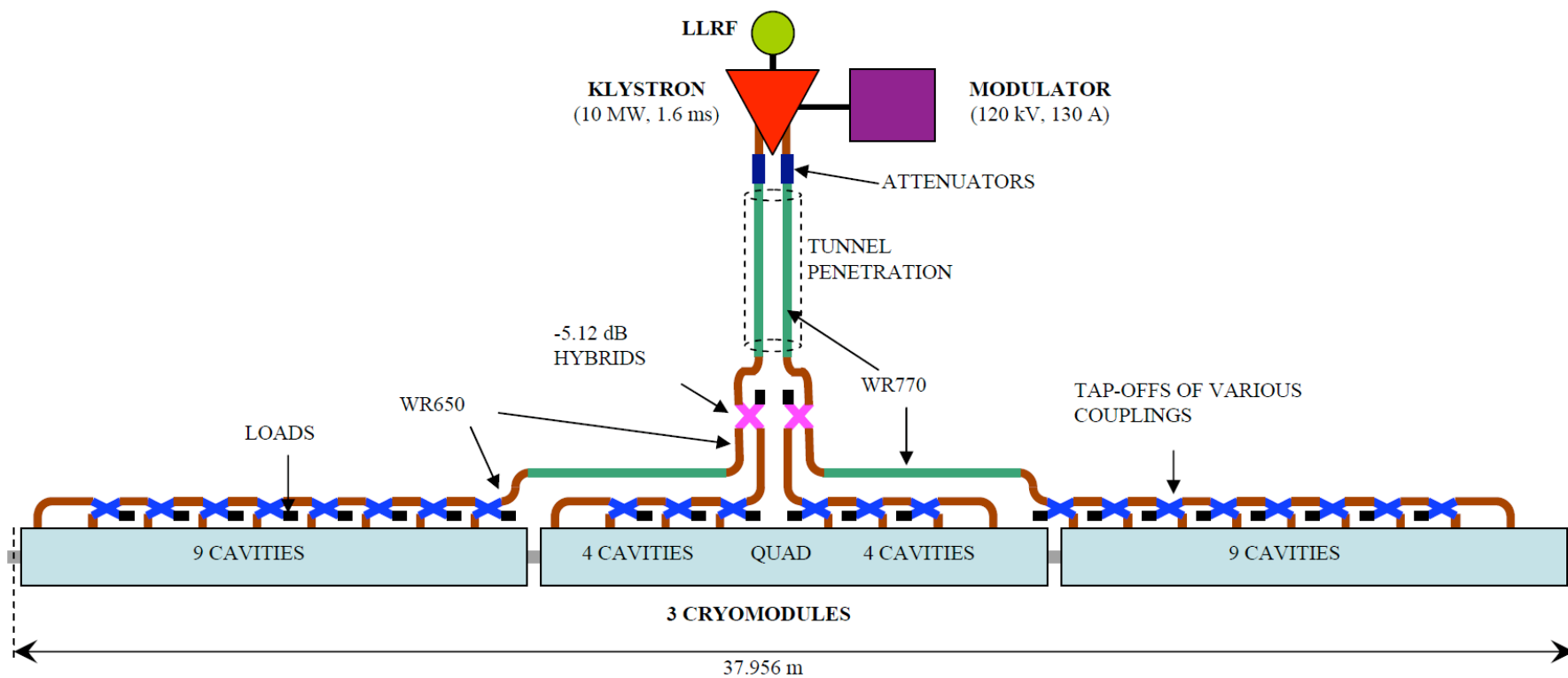

# Module Design (CLIC)

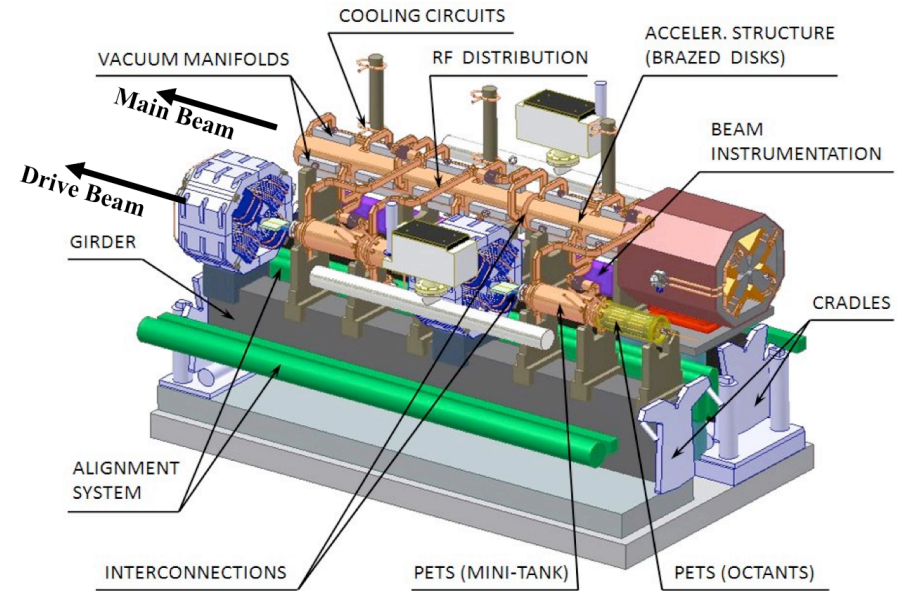
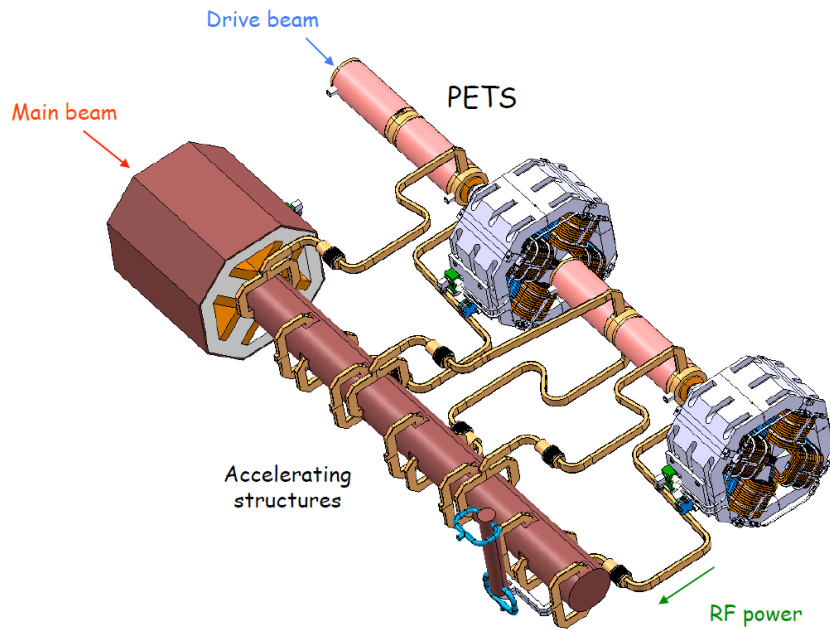

- Five types of main linac modules
- Drive beam module is regular
- Most relevant components are
  - accelerating structures
  - quadrupoles
  - beam position monitors (BPMs) and correctors

# Why is the Main Linac Important?

- The two main parameters are important for the physics experiments
  - collision energy
  - luminosity, a measure for the rate of events at the interaction point
- The main linac is the main component to accelerate the beam
  - ⇒ it is responsible for the beam energy
  - the main relevant parameter is the accelerating gradient
- The main linac is the main consumer of power
  - ⇒ it is an important limitation for the beam current
  - the luminosity depends on the beam current
- The main linac is one of the main sources of emittance growth
  - ⇒ the emittance is a parameter that affects the luminosity
- There is a third parameter which the main linac affects very much, the cost
  - is the society willing to pay for it?



# Cost Impact

- The long tunnel is expensive
  - and important for the schedule (tunnel boring machines)
- The installed components are expensive
- The linac drives other machine components
  - large damping rings in ILC to be able to store the full bunch train
  - drive beam complex in CLIC



# CLIC Feasibility Issues

Structures	<u>Main Beam Acceleration Structures:</u> Demonstrate high-power operation of nominal CLIC structures with damping features at the design gradient, with design pulse length and breakdown rate .	Average loaded gradient 100 MV/m total/flat-top pulse length 240/160 ns breakdown probability/pulse < 3·10 <sup>-7</sup> /m average $a/\lambda > 0.11$ Long range wakefield < 6V/(pC·m·mm )	CTF2&3 (2005-2010) Test Stand (2009-10) SLAC/NLCTA SLAC/ASTA KEK/NEXTEF
	<u>RF Power production structures:</u> Demonstrate high-power operation of nominal PETS with damping features at the design power, with design pulse length, breakdown rate and on/off capability	Generated power 132 MW total/flat-top pulse length 240/160 ns breakdown probability/pulse < 1·10 <sup>-7</sup> /m Wakefield < 9 V/(pC·m·mm ) On/Off/adjust capability	CTF3 (2005-2010) CTF3/TBTS (2008-10) CTF3/TBL (2009-10) SLAC/ASTA
Two Beam	<u>Two Beam Acceleration and module integration:</u> Demonstrate two-beam acceleration and operation in a prototype module equipped with all critical subsystems	Two Beam Acceleration at nominal parameters as given above for individual components Pulse shape accuracy < 0.1%	CTF2&3/TBTS (2004-10)
Drive Beam	<u>Drive Beam Production</u> - Beam generation and combination - phase and energy matching - Potential feedbacks	100 A peak current- 590 $\mu$ C total charge 12 GHz bunch repetition frequency, 1 mm rms bunch length 0.2 degrees phase stability at 12 GHz 7.5 10 <sup>-4</sup> intensity stability	CTF3 (2005-2010) CTF3/TBL (2009-10) Simulations X-FEL LCLS
	<u>RF power generation by Drive Beam</u> - Rf power extration - Beam stability	90% extraction efficiency Large momentum spread	CTF3/TBL Simulations
Beam Physics	<u>Generation and Preservation of Low Emittances</u> Damping Rings, RTML and Main Linacs	Emittances(nm): H= 600, V=5 Absolute blow-up(nm): H=160, V=15	ATF, SLS, NSLSII Simulations LCLS, SCSS
Stabilization	<u>Main Linac and BDS Stabilization</u>	Main Linac : 1 nm vert. above 1 Hz; BDS: 0.15 to 1 nm above 4 Hz depending on final doublet girder implementation	CESRTA ATF2
Operation and reliability	<u>Operation and Machine Protection</u> Staging of commissioning and construction Machine protection with high beam power	drive beam power of 72 MW @ 2.4 GeV main beam power of 13 MW @ 1.5 TeV MTBF, MTRR	CTF3 Simulations
Detector	<u>Conditions for the experiments</u> Detector design and shielding compatible with short bunch interval and breakdown generated by beam beam effects during collisions at high energy	Time stamping: 0.5 nsec bunch interval Beam-Beam background: 3.8 10 <sup>8</sup> coherent/1e5 incoherent e+/e- pairs, Hadrons, High muon flux	Simulations

# ILC Feasibility Issues

- None
- Cost is an important issue

# Some Fundamental Parameters

parameter	symbol	ILC	CLIC
centre of mass energy	$E_{cm}$	500 GeV	3000 GeV
luminosity	$\mathcal{L}$	$2 \cdot 10^{34} \text{ cm}^{-2}\text{s}^{-1}$	$6.5 \cdot 10^{34} \text{ cm}^{-2}\text{s}^{-1}$
luminosity in peak	$\mathcal{L}_{0.01}$	$1.4 \cdot 10^{34} \text{ cm}^{-2}\text{s}^{-1}$	$2 \cdot 10^{34} \text{ cm}^{-2}\text{s}^{-1}$
gradient	$G$	31.5 MV/m	100 MV/m
charge per bunch	$N$	$2 \cdot 10^{10}$	$3.72 \cdot 10^9$
bunch length	$\sigma_z$	300 $\mu\text{m}$	44 $\mu\text{m}$
horizontal emittance	$\epsilon_x$	8400 nm	600 nm
vertical emittance	$\epsilon_y$	24 nm	10 nm
bunches per pulse	$n_b$	2625	312
distance between bunches	$n_b$	369 ns	0.5 ns
repetition frequency	$f_r$	5 Hz	50 Hz

⇒ Beam Parameters are very different

- in particular time structure
- this also affects the experiments

- We will see that this is driven by the main linac

## Accelerating Structure (ILC)

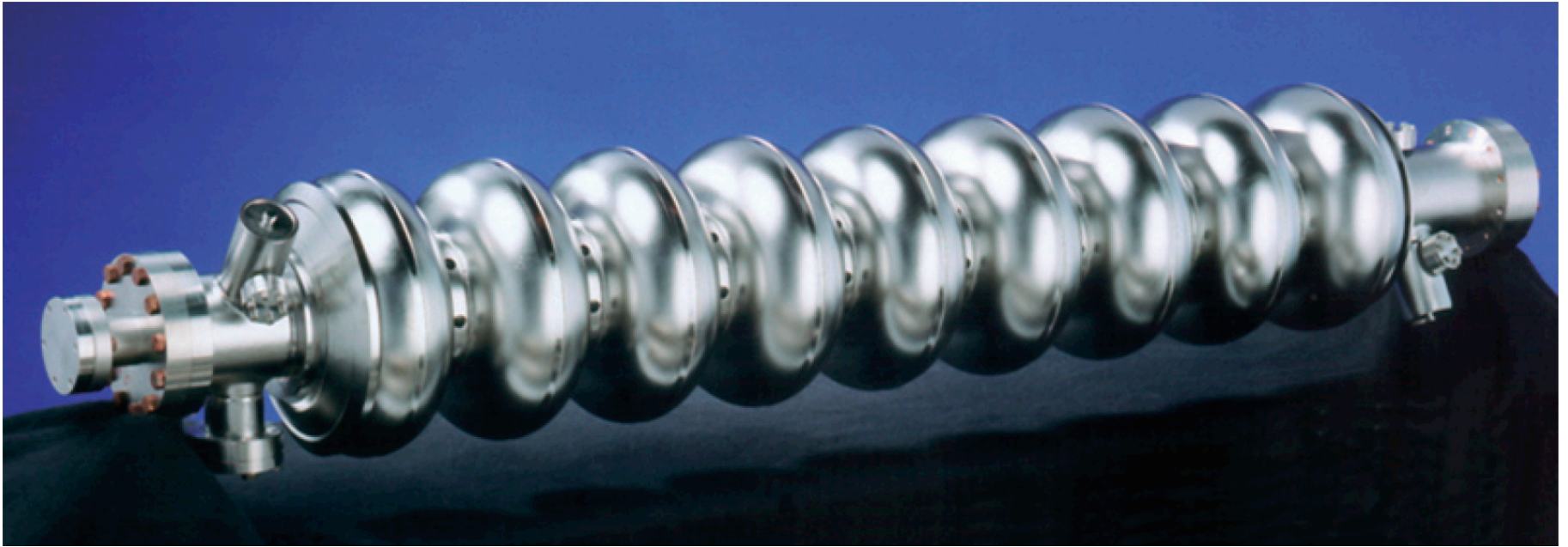

- About 1 m long, super-conducting, 1.3 GHz, standing wave, constant impedance, 31.5 MV/m

# Accelerating Structure (CLIC)

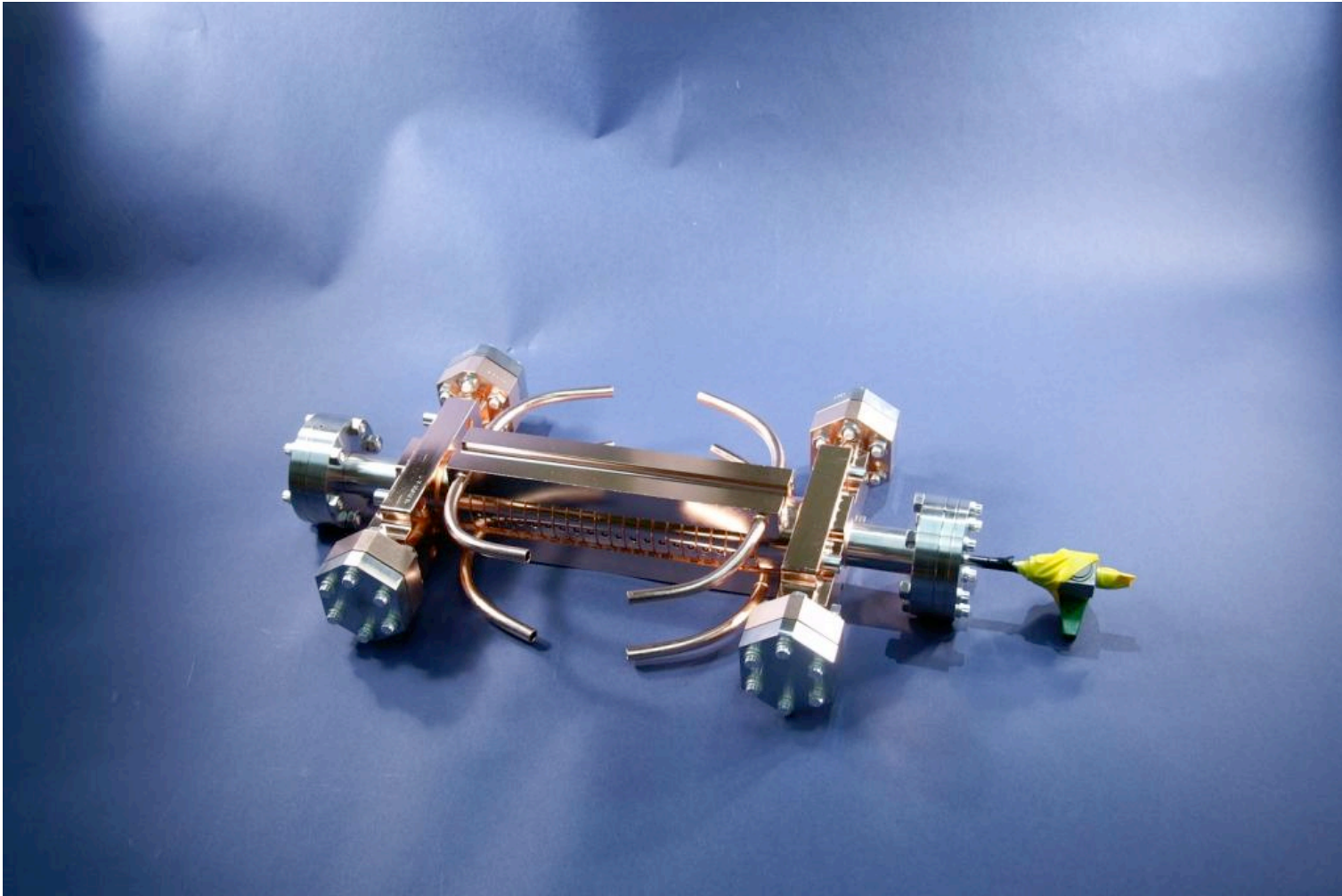

- About 23 cm long, normal-conducting, 12 GHz, travelling wave, constant gradient (almost), 100 MV/m

# Types of Structures

- Accelerating structures can be normal-conducting or super-conducting
  - in a super-conducting structure very little power is lost in the walls
  - in a normal conducting structure a significant power is lost in the walls (in most cases)
- They can be standing wave or travelling wave structures
  - in standing wave the energy is trapped and the RF wave is reflected at the ends creating the standing wave
  - in a travelling wave structure power is coupled into one end and extracted at the other
- They can be constant impedance structures or constant gradient structures (or something else)
  - all cells can be the same design or the design differs along the structure

# Choice of Material

- The material is the most fundamental design choice
- Super-conducting structures
  - allow a small beam current
  - ⇒ low background per unit time in IP
  - ⇒ intra-pulse feedback is possible everywhere
- Normal conducting structures
  - allow for high gradient
  - ⇒ high centre-of-mass energy
  - need high beam current
  - ⇒ significant wakefield effects
  - use short pulses
  - ⇒ smaller damping ring



# Standing Wave Structures

- The power is feed into one end
  - the power is reflected at the coupler
  - as the power in the cavity is increasing, the reflection is reduced
- there is a level when there is no reflection
  - ⇒ now switch on the beam

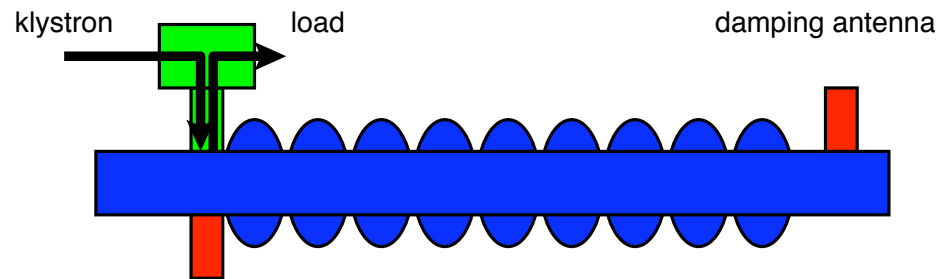

# Travelling Wave Structures

- The power is feed into one end
  - no reflection if designed properly
- It slowly moves through the structure
  - group velocity is typically a few percent of the speed of light

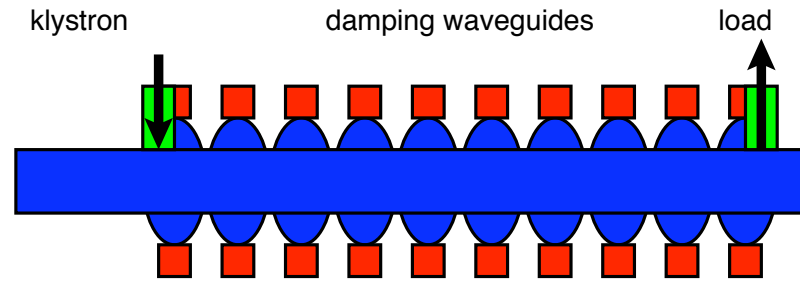

# Choice of Structure Design

- In a super-conducting structure the beam current is small
  - little power is extracted but over long times
  - natural choice is standing wave structures, to avoid all the power draining out at the end
  - no need to compensate extraction of energy along the structure
- For a normal conducting structure all four options (constant impedance/constant gradient and standing/travelling wave) could be used
  - for CLIC travelling wave, constant gradient structures have been chosen
  - travelling wave structures avoid recirculators to keep the energy in the structures
  - constant gradient allows to reach higher effective gradients

# Choice of Frequency

- Obviously the frequency choice differs
  - CLIC: 12 GHz
  - ILC: 1.3 GHz
- So what drives the choice?
- ILC uses super-conducting structures
  - high frequencies lead to higher surface resistance
  - high frequencies lead to higher wakefields  $W_L \propto f^2$ ,  $W_{\perp} \propto f^3$
  - a very low frequency makes the structures expensive (dimension  $\propto \lambda$ )

⇒ so a frequency with existing power sources has been picked
- CLIC uses normal-conducting structures
  - higher frequencies help in reaching high gradients
  - but also lead to higher wakefields

⇒ full optimisation of the design has been performed to achieve the lowest cost for a fixed energy and luminosity target

# Coordinate Systems

- We use two frames, the laboratory frame and the beam frame
- The nominal direction of motion of the beam is called  $s$  in the laboratory frame, the beam moves toward increasing  $s$
- The same direction is called  $z$  in the beam frame, with smaller  $z$  moving ahead of particles with larger  $z$
- A particle preserves its longitudinal position within the beam
- The transverse dimensions are  $x$  in the horizontal and  $y$  in the vertical plane, in both coordinate systems
- People use different systems so find out what they talk about

# Power Consumption

- Power consumption of the main linac is a concern
  - electricity cost
  - equipment cost
- Examples of total beam power

- ILC

$$P_{beam} = 2n_b f_r N E \approx 22 \text{ MW}$$

- CLIC

$$P_{beam} \approx 28 \text{ MW}$$

- Wall plug power can be transformed into RF power with limited efficiency
- The efficiency of transforming RF power into beam power depends on
  - structure design
  - the gradient
  - the beam parameters
- The structures need to be cooled (especially in a super-conducting machine)

# RF to Beam Power Efficiency

- Efficiency is

$$\eta_{RF \rightarrow beam} = \frac{\tau_{beam}}{\tau_{beam} + \tau_{fill}} \cdot \frac{P_{beam}}{P_{beam} + P_{loss} + P_{out}}$$

- RF pulse needs to be longer than beam pulse in order to fill the structures with energy before the beam arrives
- In a super-conducting cavity
  - little RF power is lost in the walls during the pulse
  - but the cooling requires some significant overhead
  - some cooling is also needed against heating from the environment
- In normal conducting structures
  - A significant fraction of the RF power is lost into the walls
  - some power will be draining out of the travelling wave structure (usually)

# RF Pulse Length

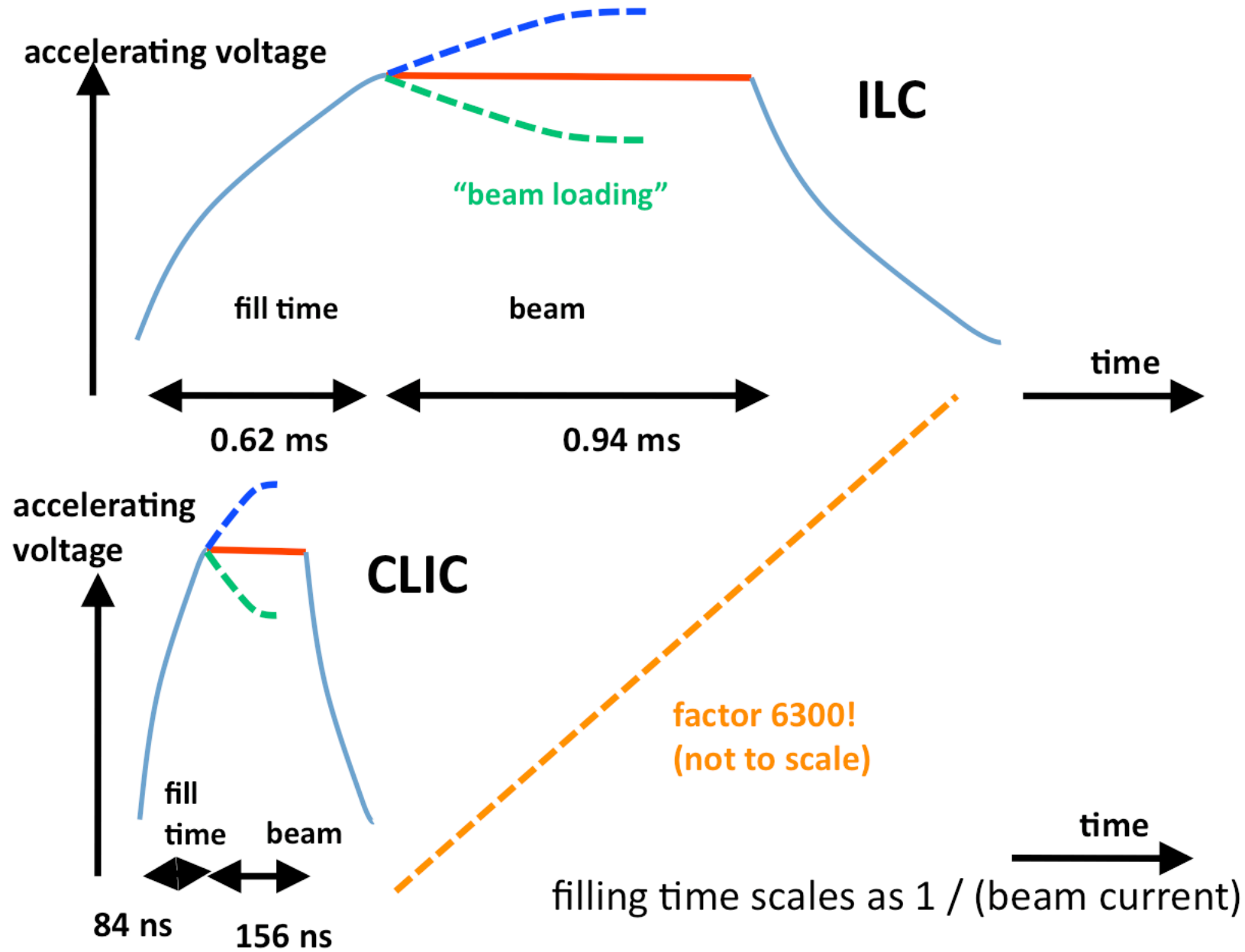



# Passage of a Particle

- A particle in the structure will

⇒ extract energy (depending on energy in structure)

- induce electromagnetic wakefields

⇒ cosine-like longitudinal (monopole) and sine-like transverse (dipole) modes

⇒ the wakefield does not depend on the energy in the structure

- Analytic longitudinal wake

$$W_L(z \rightarrow 0) = \frac{Z_0 c}{\pi a^2}$$

- For larger distances one has to perform simulations

- Analytic transverse wake

$$W_{\perp}(z \rightarrow 0) = \frac{4Z_0 c}{\pi a^4} z$$

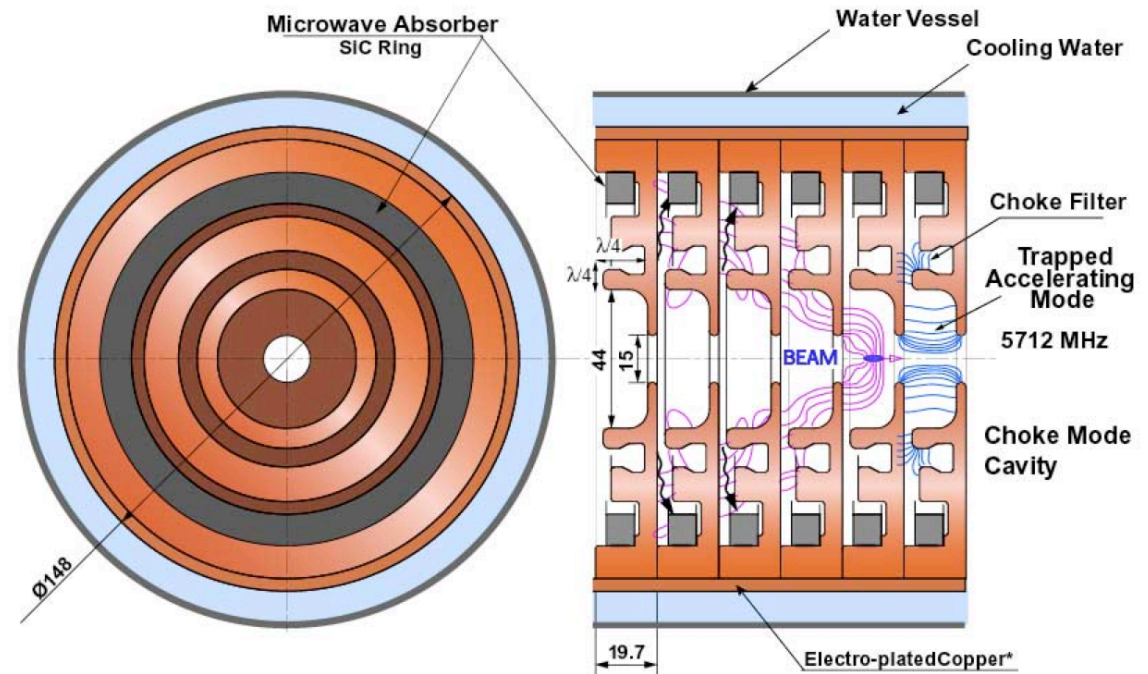

# Stored Energy in a Structure (Fundamental Mode)

- Want to show
  - wakefield and extracted energy picture are consistent
  - ratio of power lost in the walls to sent to beam
- First, we want to have a variable that allows us to calculate the stored energy in a cavity

$$a = \frac{\text{energy per unit length}}{\text{accelerating gradient}^2} = \frac{E'}{G^2}$$

- The proper value for  $a$  is used by the RF experts

$$a = \frac{1}{(R/Q)\omega}$$

- Why do they not come up with a single variable but use a combination of  $R$ ,  $Q$ ,  $\omega$ ?

# The solution to the Puzzle

- The RF experts had defined a variable  $R'$ , the shunt impedance per unit length, as

$$R' = \frac{\text{effective gradient}^2}{\text{ohmic power loss per unit length}} = \frac{G^2}{P}$$

this allows to easily determine the power lost in the walls of a structure of length  $L$  as a function of the acceleration

$$P'(s) = \frac{G^2(s)}{R'(s)}$$

- They had also defined another variable  $Q$

$$Q = \frac{\text{stored energy}}{\text{ohmic power loss per radian of RF circle}} = \frac{E'}{P'}\omega$$

this allows to easily write the decay of the energy due to ohmic losses

$$E'(t) = E'_0 \exp(-\omega t/Q)$$

- From these decent units they constructed

$$(R'/Q) = \frac{G^2}{E'\omega}$$

so one can calculate

$$E' = \frac{G^2}{(R'/Q)\omega}$$

# Wakefield and Power Extraction

- The energy stored per unit length in the accelerating structure is

$$E' = \frac{G^2}{(R/Q)\omega}$$

- The reduction of accelerating field due to the passing charge  $q$  is  $-\Delta G$
- This yields for the energy lost by the structure

$$\begin{aligned}\Delta E'_{lost} &= \frac{G^2 - (G - \Delta G)^2}{(R/Q)\omega} \\ \Rightarrow \Delta E'_{lost} &= \frac{-2G\Delta G + (\Delta G)^2}{(R/Q)\omega}\end{aligned}$$

- The beam extracts an energy

$$\Delta E'_{beam} = q \left( G - \frac{1}{2}\Delta G \right)$$

hence

$$\begin{aligned}q \left( G - \frac{1}{2}\Delta G \right) &= -\frac{2G\Delta G - (\Delta G)^2}{(R/Q)\omega} \\ \Rightarrow \Delta G &= \frac{(R/Q)\omega}{2}q\end{aligned}$$

$\Rightarrow$  Field and power picture agree, as expected

- Note: I simplified a bit (sorry, but this is easier with cheating)

# Constant Impedance vs. Constant Gradient

- In a travelling wave structure, the beam extracts energy during its passage
  - ⇒ the gradient will be lower at the end of the structure
- This can be avoided by reducing the iris radius along the structure (tapering)
  - the smaller irises produce more gradient per power flowing through them
- An additional difference exists for the long-range transverse wakefields
  - in a constant impedance structure one strong wakefield mode exists
  - in a tapered structure many small modes exist which reduces the effective wakefield

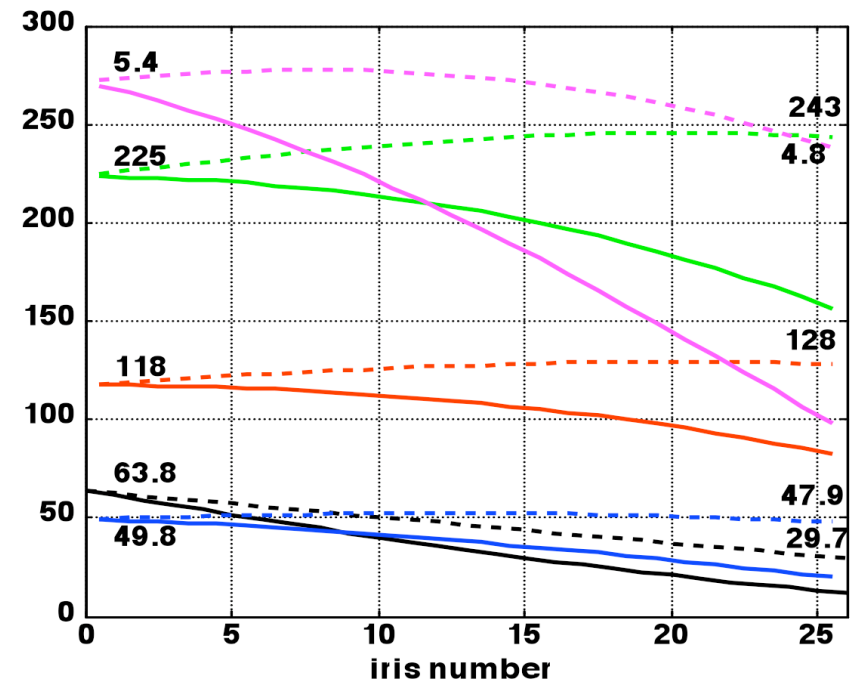

# Beam Loading in Travelling Wave Structure

- Consider constant impedance
- Field induced by passing bunch is moving forward
  - as is external RF
- ⇒ beam loading fields build up along the structure
- The RF loses power in the wall
- ⇒ The gradient decreases along the structure

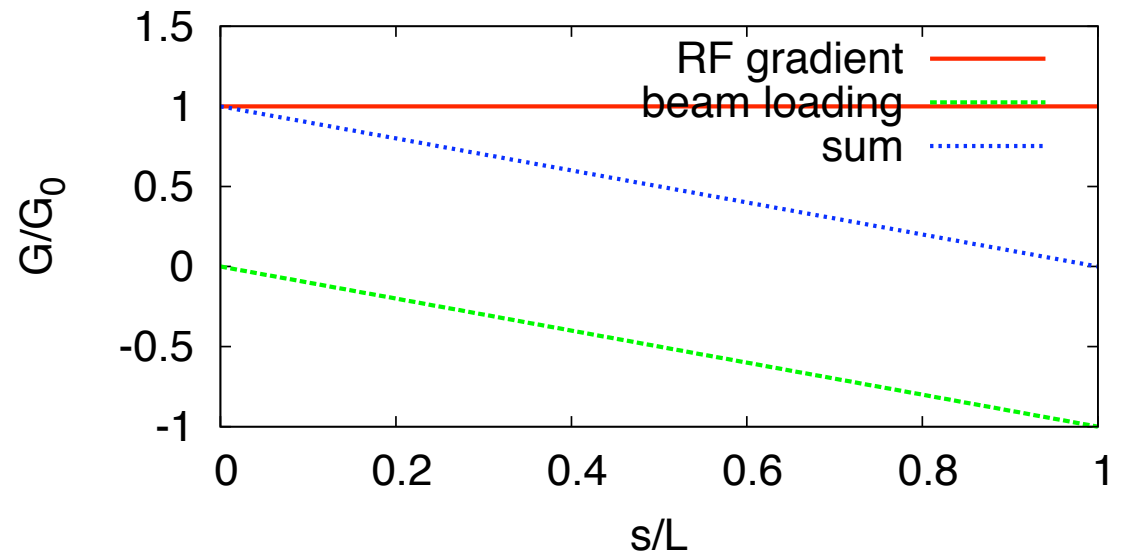
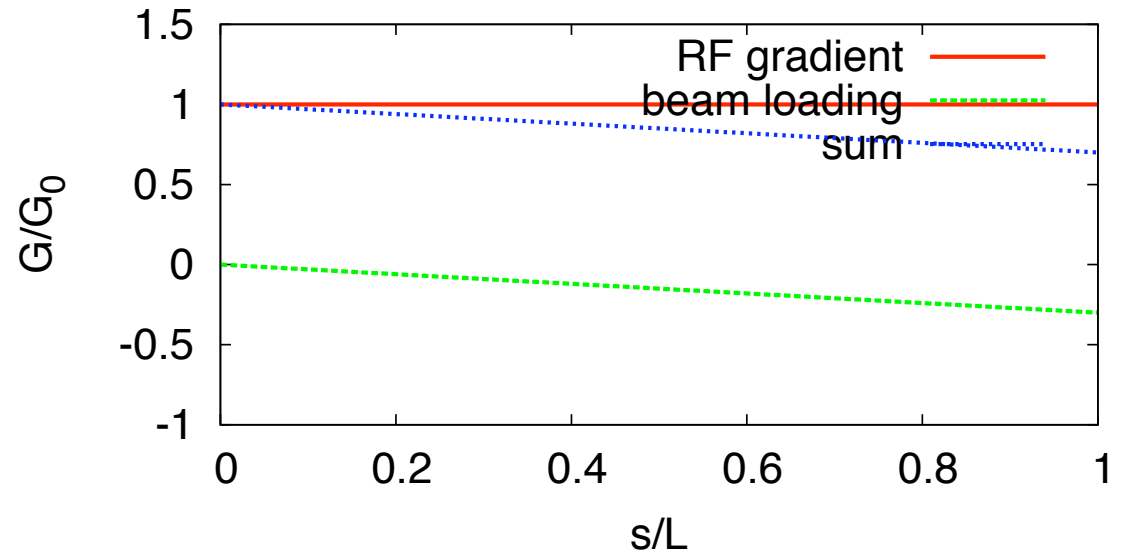
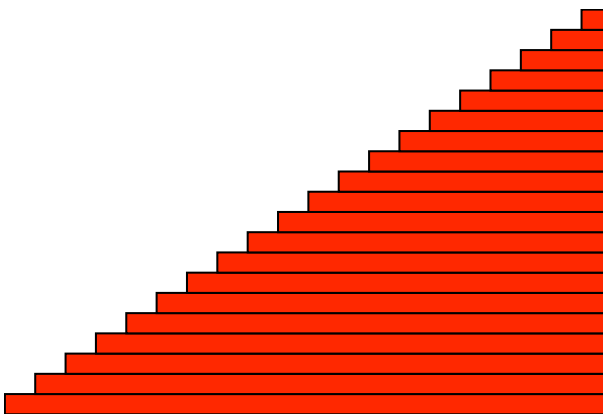

# Structure Tapering

- By decreasing the along the structure iris radius the local  $R/Q$  increases
- ⇒ The unloaded gradient increases along the structure
- ⇒ The loaded gradient remains constant
- In practice we have to ensure that the RF constraints are fulfilled in each cell
- Note: beam loading could reduce breakdown rate

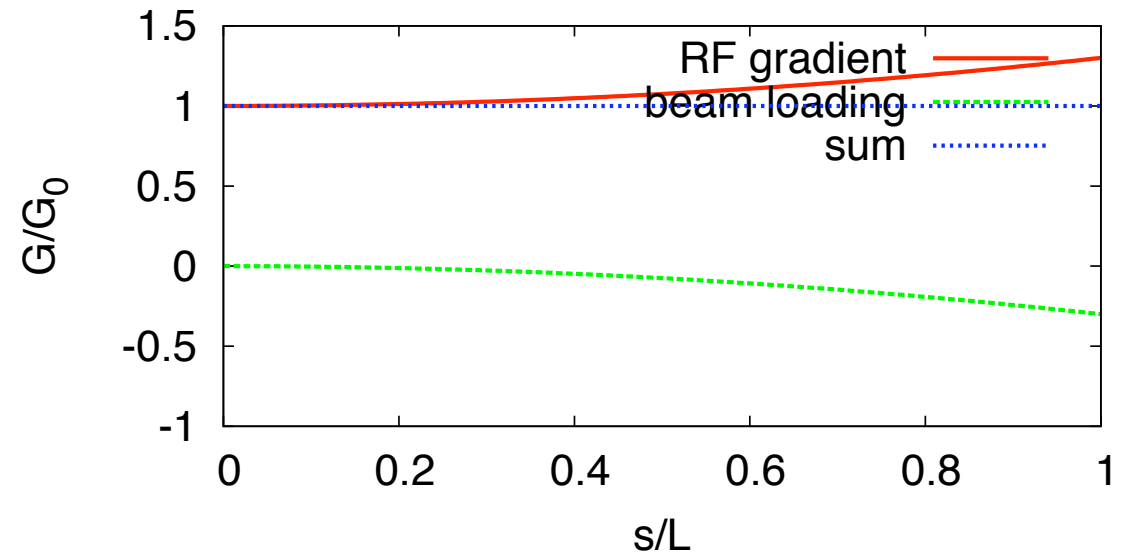

- Note: in CLIC about 20% of the RF power are lost in the loads during the flat top

# Beam Loading Compensation

- Constant impedance example with losses into the walls
  - The first bunch sees no beam loading
- ⇒ We need to shape the RF pulse accordingly

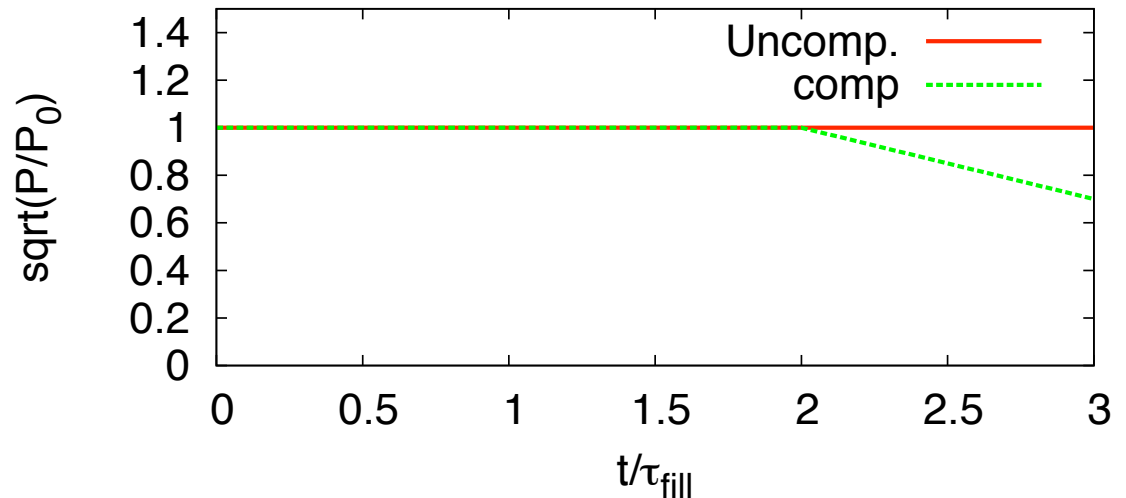
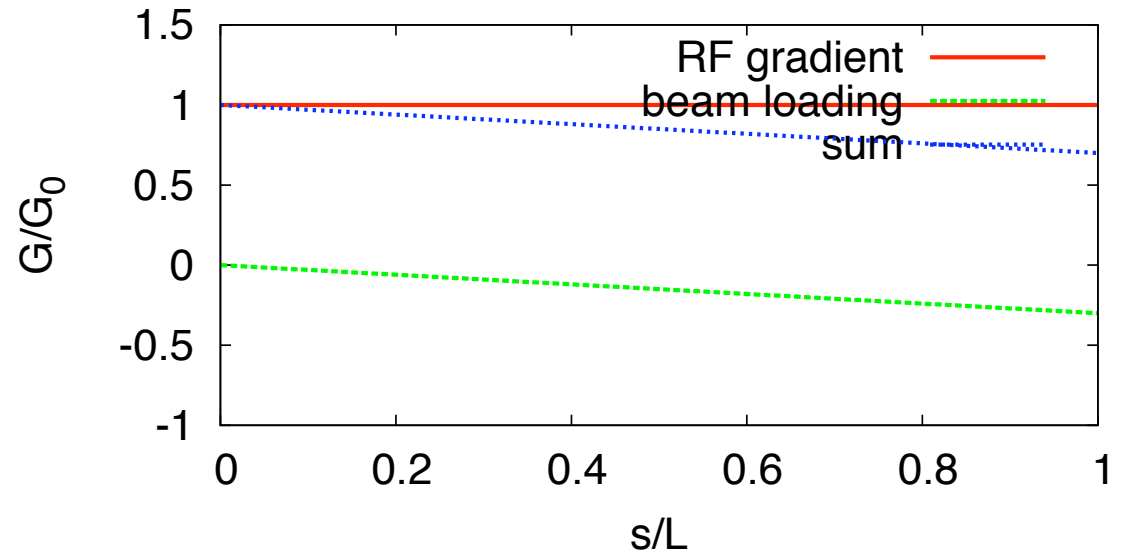



# RF to Beam Efficiency

- In a normal conducting structure the stored energy is quickly lost into the walls  
⇒ extract energy quickly with the beam
- Power lost in the walls

$$P'_{wall} = \frac{\omega}{Q} E' = \frac{\omega}{Q} \frac{G^2}{(R'/Q)\omega} = \frac{G^2}{R'}$$

power given to the beam

$$P'_{beam} = IG$$

The ratio is

$$\frac{P'_{beam}(s)}{P'_{wall}(s)} = \frac{R'(s)I}{G(s)}$$

⇒ higher efficiency at lower gradient  $G$

⇒ higher efficiency at higher current  $I$

⇒ higher efficiency at higher shunt impedance  $R'$

# Culprits for the Parameters

- The structure design provides

$$\left(\frac{R}{Q}\right)$$

if we scale all dimensions of a structure this parameters does not change  
Energy in the structure (same gradient)

$$E \propto \lambda^3$$

the stored energy per structure is reduced as  $\lambda^3/\lambda_0^3$   
the energy gain is reduced due to the shorter cell structure  $L$

$$\begin{aligned}\frac{R}{Q}\omega &= \frac{E}{(LG)^2} \\ \Rightarrow \frac{R}{Q} &= \frac{(LG)^2}{E} \frac{1}{\omega} \propto \frac{\lambda^2}{\lambda^3} \frac{\lambda}{1}\end{aligned}$$

one finds

$$(R/Q) = \text{const}$$

- The material, the frequency and to some extent the design can impact  $Q$

# RF to Beam Power Efficiency

parameter	ILC	CLIC
$R'/Q$	$\approx 11 \text{ k}\Omega$	$1.036 \text{ k}\Omega$
$Q$	$\approx 6000$	$\approx 10^{10}$
$R'$	$\approx 66 \text{ M}\Omega$	$\approx 10^7 \text{ M}\Omega$

• ILC:  $I \approx 8.7 \mu\text{A}$

$\Rightarrow$

$$\frac{P'_{beam}}{P'_{wall}} \approx 2500$$

• CLIC:  $I \approx 1.2 \text{ A}$

$\Rightarrow$

$$\frac{P'_{beam}}{P'_{wall}} \approx 0.8$$

• Efficiency is

$$\eta = \frac{\tau_{beam}}{\tau_{beam} + \tau_{fill}} \frac{P_{beam}}{P_{beam} + P_{loss} + P_{out}}$$

• Plugging in numbers for ILC

$$\eta = \frac{940 \mu\text{s}}{940 \mu\text{s} + 620 \mu\text{s}} \approx 0.6$$

• Plugging in numbers for CLIC

$$\eta = \frac{156 \mu\text{s}}{156 \mu\text{s} + 83 \mu\text{s}} \cdot \frac{27 \text{ MW}}{27 \text{ MW} + 25 \text{ MW} + 12 \text{ MW}} \approx 0.65 \cdot 0.42 \approx 0.277$$

# ILC Limiting Factors for Efficiency

- The transfer of RF to the beam is almost perfect during the pulse
- The main power consumption is for the cooling
  - to cool 1W at 2K requires about 700 W

remember Carnot process, in best case

$$\frac{P_{cool}}{P_{source}} \geq \frac{T_2 - T_1}{T_1}$$

- Additionally a number of other sources exist
  - higher order modes induced by the beam
  - static losses through the cryostat

⇒ Cooling power is about twice the beam power (35 kW)

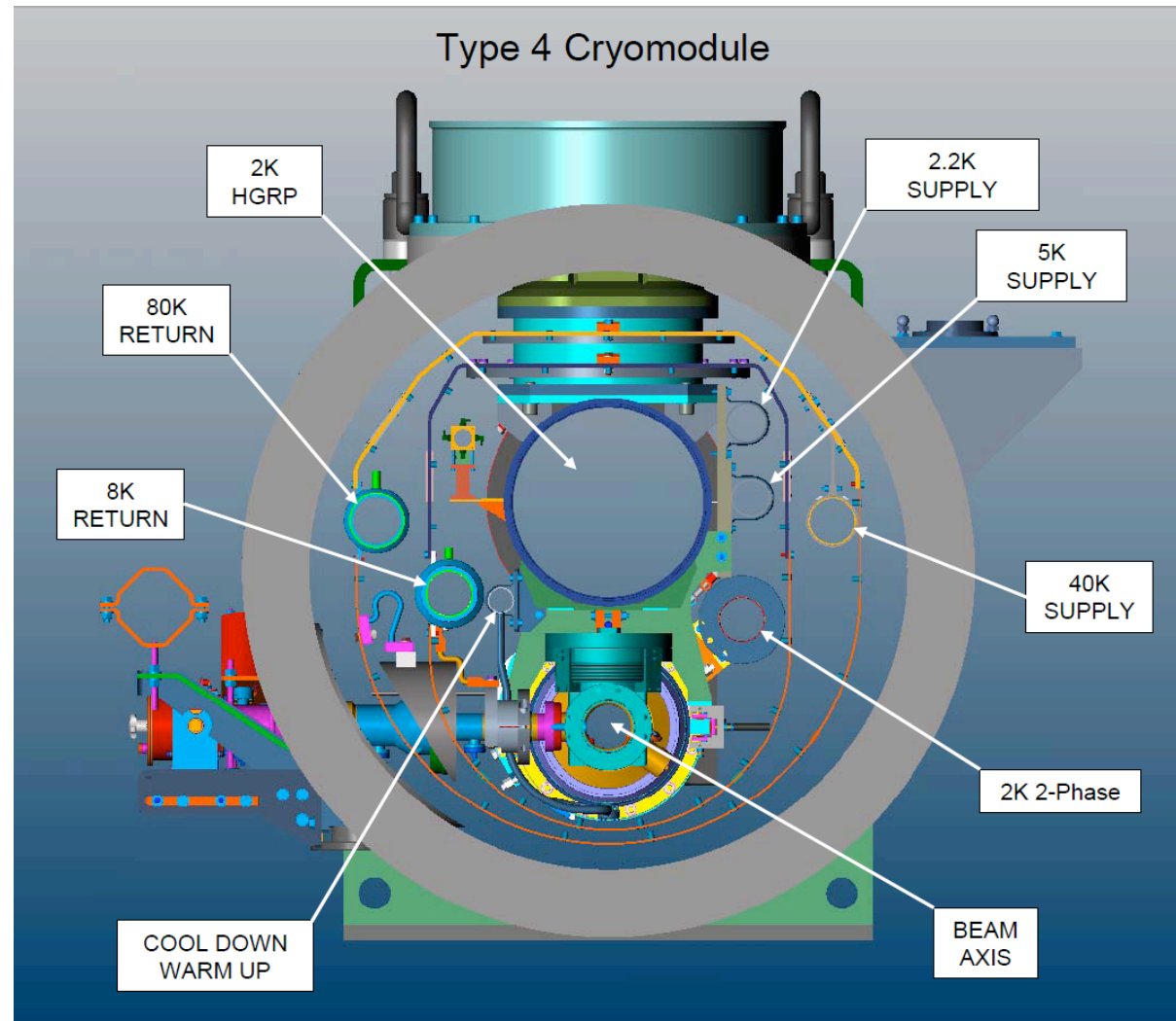

	40–80 K		5–8 K		2 K		Total
	Static	Dynamic	Static	Dynamic	Static	Dynamic	
Heat load (W)	177.6	270.3	31.7	12.5	5.1	29.0	
Installed power (kW)	4.4	6.2	9.6	3.5	8.1	28.5	60.4

# CLIC Limiting Factors for the Efficiency

- A lower gradient  $G$ 
  - leads to a longer main linac hence to higher cost
- A higher shunt impedance  $R'$ 
  - leads usually to larger wakefields also in the transverse hence to a less stable beam
- A higher beam current  $I$ 
  - leads to a less stable beam
- An optimisation can be performed of the whole machine
  - varying  $G$  and  $R'$  and adjusting the current to the highest possible value
  - selecting the best combination taking into account luminosity and cost
- This optimisation has indeed been performed for CLIC
  - ⇒ let us see which is the highest current for a given structure and gradient

# Beam Loading and Bunch Length

- Aim for shortest possible bunch (wakefields)
- Energy spread into the beam delivery system should be limited to about 1% full width or 0.35% rms
- Multi-bunch beam loading compensated by RF
- Single bunch longitudinal wakefield needs to be compensated  
⇒ accelerate off-crest

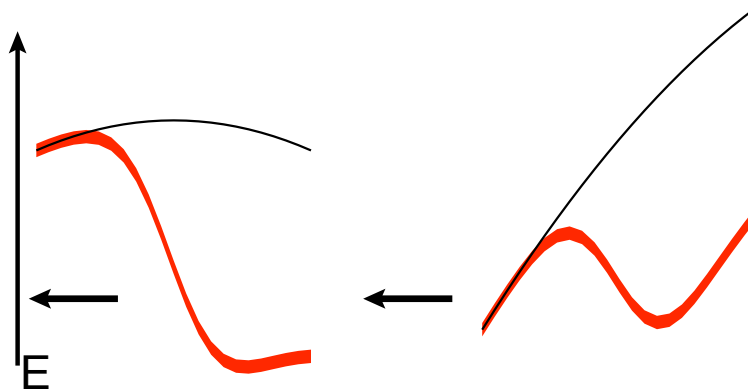

- Limit around average  $\Delta\Phi \leq 12^\circ$   
⇒  $\sigma_z = 44 \mu\text{m}$  for  $N = 3.72 \times 10$

# Specific Wakefields

- Longitudinal wakefields contain more than the fundamental mode

- We will use wakefields based on fits derived by Karl Bane

$l$  length of the cell

$a$  radius of the iris aperture

$g$  length between irises

$$z_0 = 0.41a^{1.8}g^{1.6} \left(\frac{1}{l}\right)^{2.4}$$

$$W_L(z) = \frac{Z_0 c}{\pi a^2} \exp\left(-\sqrt{\frac{z}{z_0}}\right)$$

- Use CLIC structure parameters

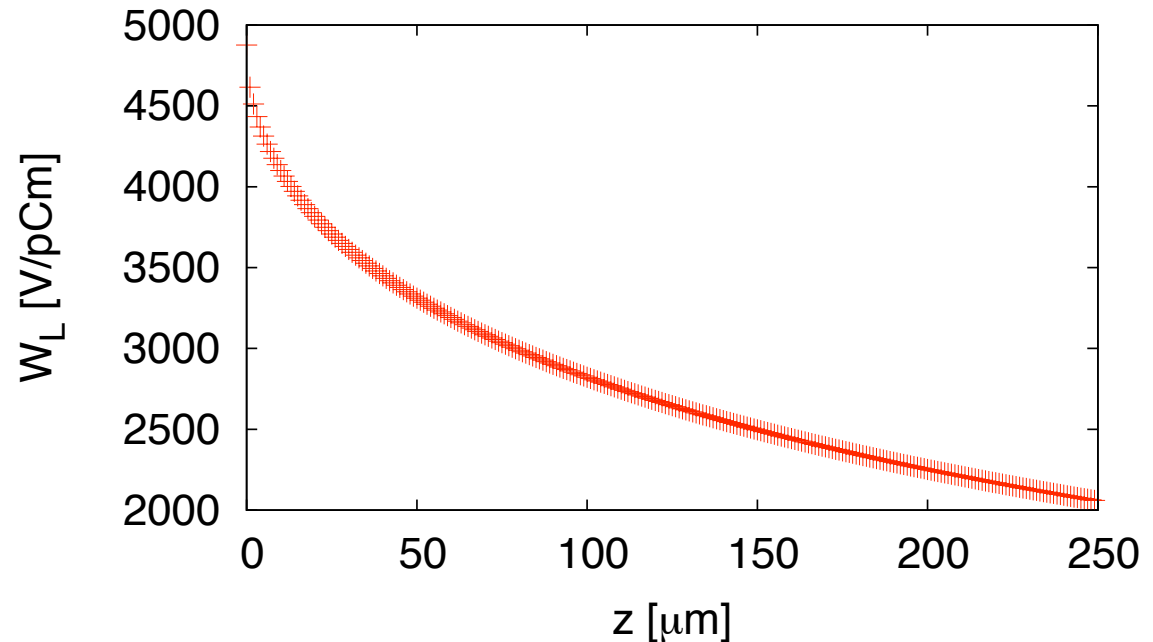

- Summation of an infinite number of cosine-like modes
  - calculation in time domain or approximations for high frequency modes

# Energy Spread at End of Linac

- We use a constant RF phase along the linac

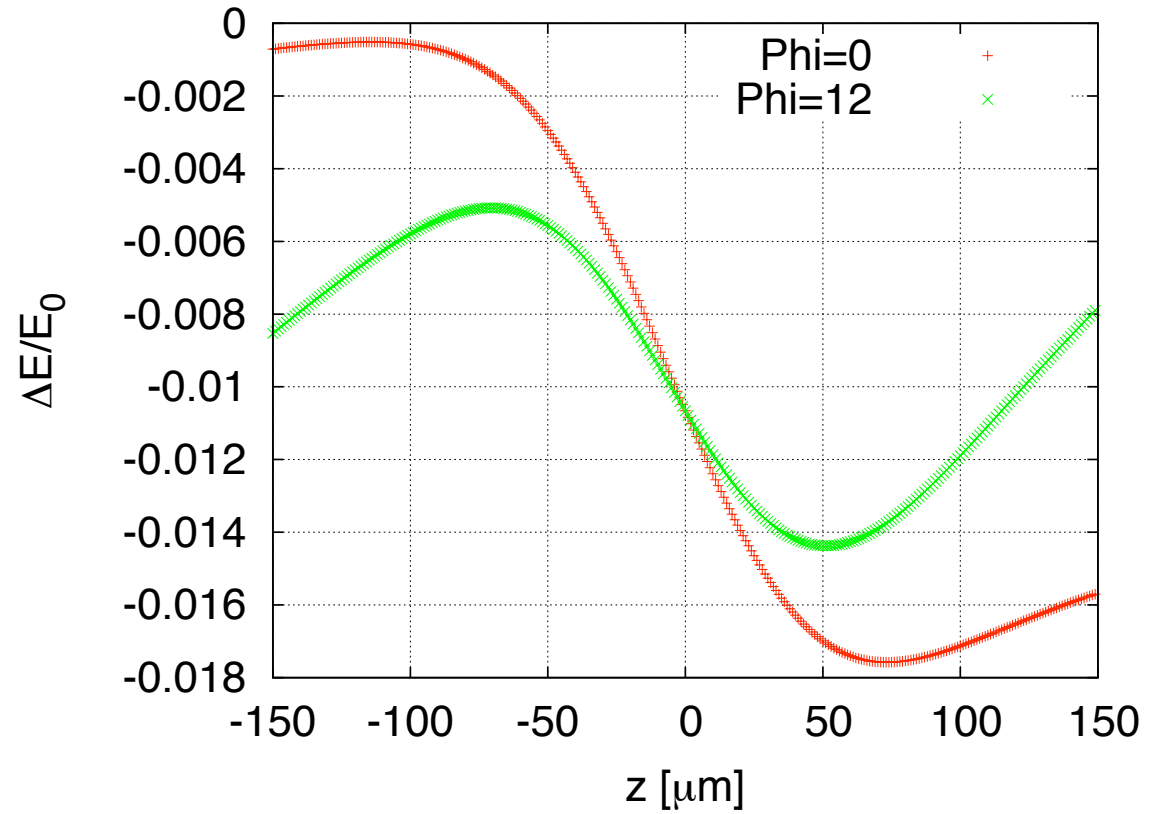



# Recipe for Choosing the Bunch Parameters

- Decide on the average RF phase
  - OK, we fix  $12^\circ$
  - smaller values give less bunch charge, larger values give more sensitivity to phase jitter
- Decide on an acceptable energy spread at the end of the linac
  - OK, we choose  $0.35\%$
  - mainly from BDS and physics requirements
- Determine  $\sigma_z(N)$ 
  - choose a bunch charge
  - vary the bunch length until the final energy spread is acceptable
  - choose next charge
- Determine which bunch charge (and corresponding bunch length) can be transported stably

# Dependence of Energy Spread on Bunch Length

- For a given charge and phase the bunch length is varied

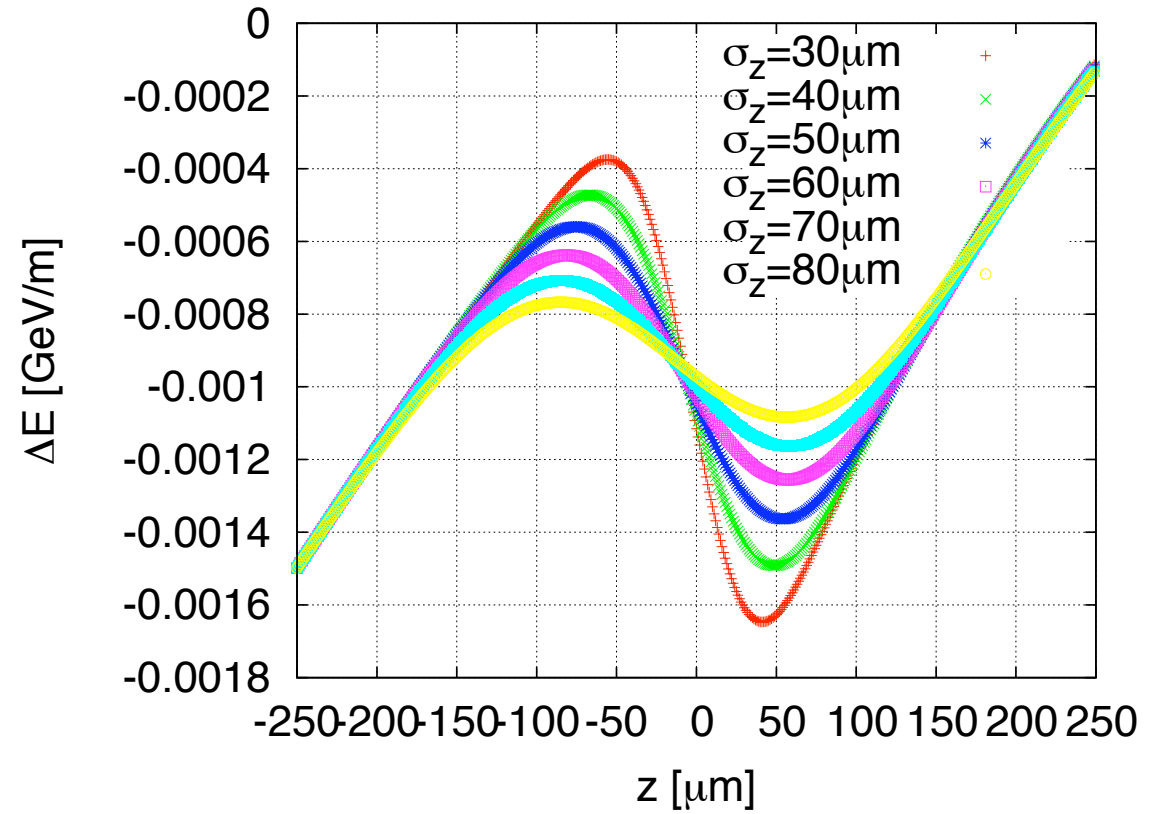

# Energy Spread

- Three regions
  - generate
  - maintain
  - compress
- Configurations are named according to RF phase in section 2
- Trade-off in fixed lattice
  - large energy spread is more stable
  - small energy spread is better for alignment

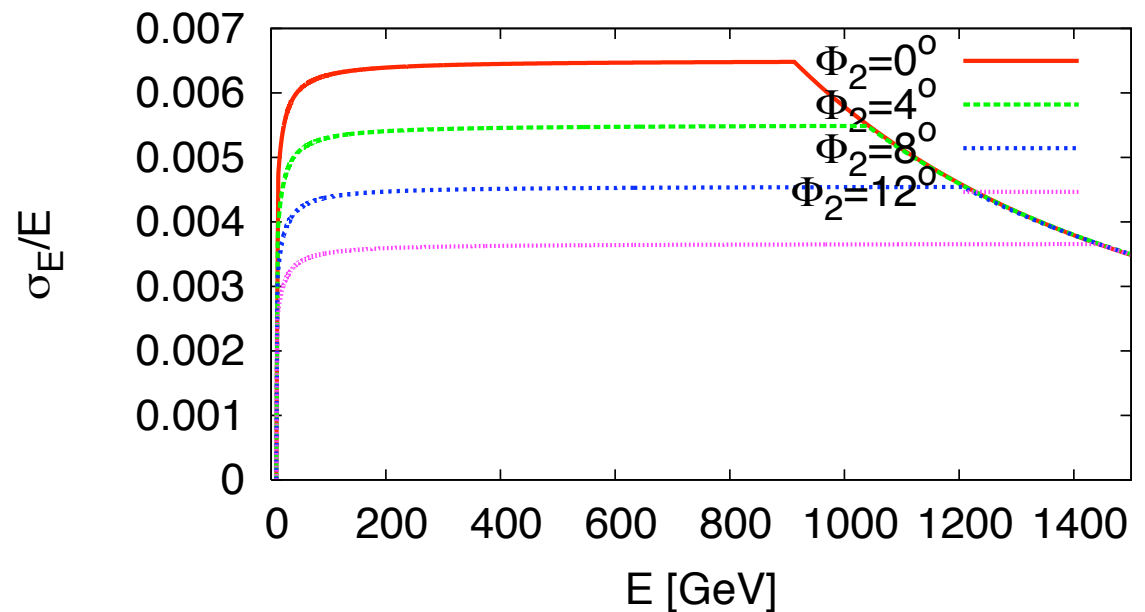
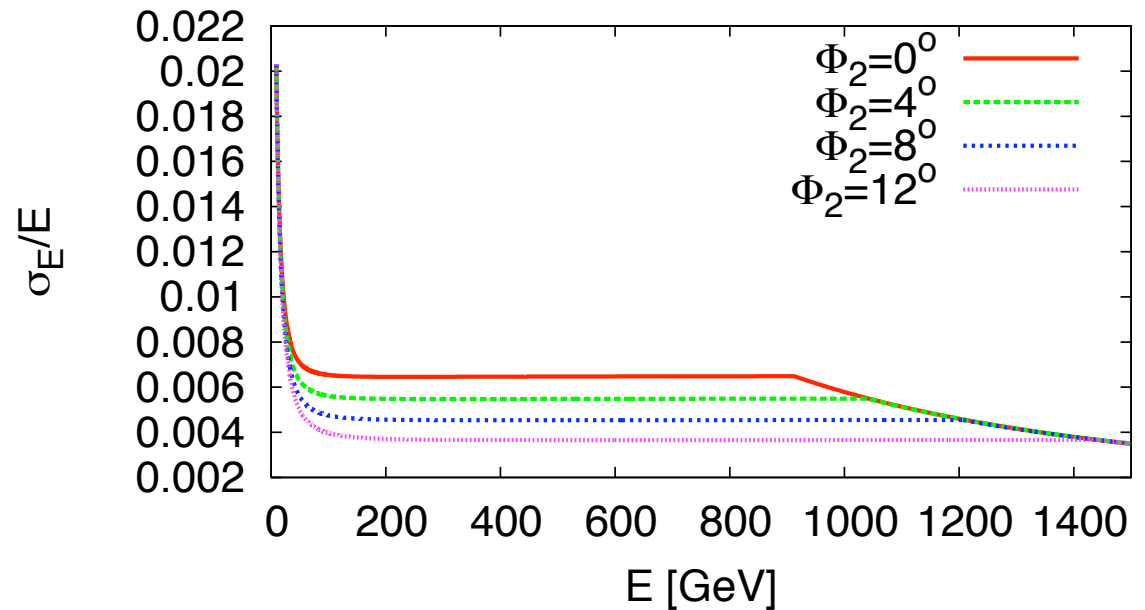

# Beam Stability and Emittance

Know  $\sigma_z(N)$  but current limit will depend on wakefields, important problem



# Emittance

- The beam particles do not have identical coordinates
  - they occupy some phase space
- According to Liouville theorem (from the Liouville equation)

$$\frac{d\rho}{dt} = \frac{\partial\rho}{\partial t} + \sum_{i=1}^N \left[ \frac{\partial\rho}{\partial q_i} \dot{q}_i + \frac{\partial\rho}{\partial p_i} \dot{p}_i \right] = 0$$

the density in phase space around a trajectory remains constant in an unperturbed system

- For some reason particles are conventionally not described by  $(x, y, z, p_x, p_y, p_z)$  but by  $(x, y, z, x', y', E)$ 
  - $\Rightarrow$  in this representation the “phase space” changes
- We use the emittance to describe the phase space volume
  - geometric emittance is the actual size in  $x x'$  and changes with acceleration
  - the normalised emittance is size in  $x x'$  for  $\gamma = 1$  and is constant

# Why is the Emittance Important?

- The luminosity can be written as

$$\mathcal{L} = H_D \frac{N^2 n_b f_r}{4\pi \sigma_x^* \sigma_y^*}$$

$H_D$  a factor usually between 1 and 2, due to the beam-beam forces

$N$  the number of particles per bunch

$n_b$  the number of bunches per beam pulse (train)

$f_r$  the frequency of trains

$\sigma_x^*$  and  $\sigma_y^*$  the transverse dimensions at the interaction point

- We will see that  $\sigma_{x,y}$  can be written as the function of two parameters

$$\sigma_{x,y} = \sqrt{\frac{\beta_{x,y} \epsilon_{x,y}}{\gamma}}$$

$\epsilon_{x,y}$  is the normalised emittance, a beam property

$\beta_{x,y}$  is the beta-function, a lattice property

# Main Linac Emittance Growth

- The vertical emittance is most important since it is much smaller than the horizontal one (10 nm vs. 600 nm, 24 nm vs. 8400 nm)
- For a perfect implementation of the machine the main linac emittance growth would be negligible
- Two main sources of emittance growth exist
  - static imperfections
  - dynamic imperfections
- The emittance growth budget is 5 nm for static imperfections
  - i.e. 90% of the machines must be better
- For dynamic imperfections the budget is 5 nm
  - but short term fluctuation must be smaller to avoid problems with luminosity tuning

# Low Emittance Transport Challenges

- Static imperfections

errors of reference line, elements to reference line, elements. . .

excellent pre-alignment, lattice design, beam-based alignment, beam-based tuning

- Dynamic imperfections

element jitter, RF jitter, ground motion, beam jitter, electronic noise, . . .

lattice design, BNS damping, component stabilisation, feedback, re-tuning, re-alignment

- Combination of dynamic and static imperfections can be severe

- Lattice design needs to balance dynamic and static effects



# Guiding the Beams: Quadrupoles

- The focusing is provided by quadrupoles
- They focus in one plane but defocus in the other planes
  - octapoles would focus in  $x$  and  $y$  but defocus in the planes at  $45^\circ$
  - also their magnetic field is not linear

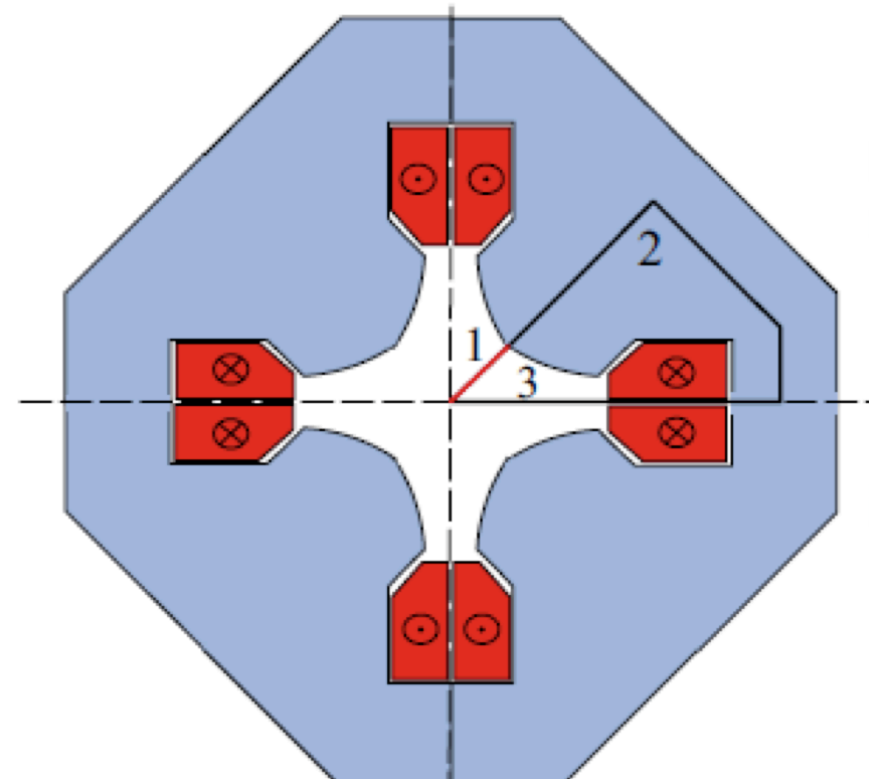
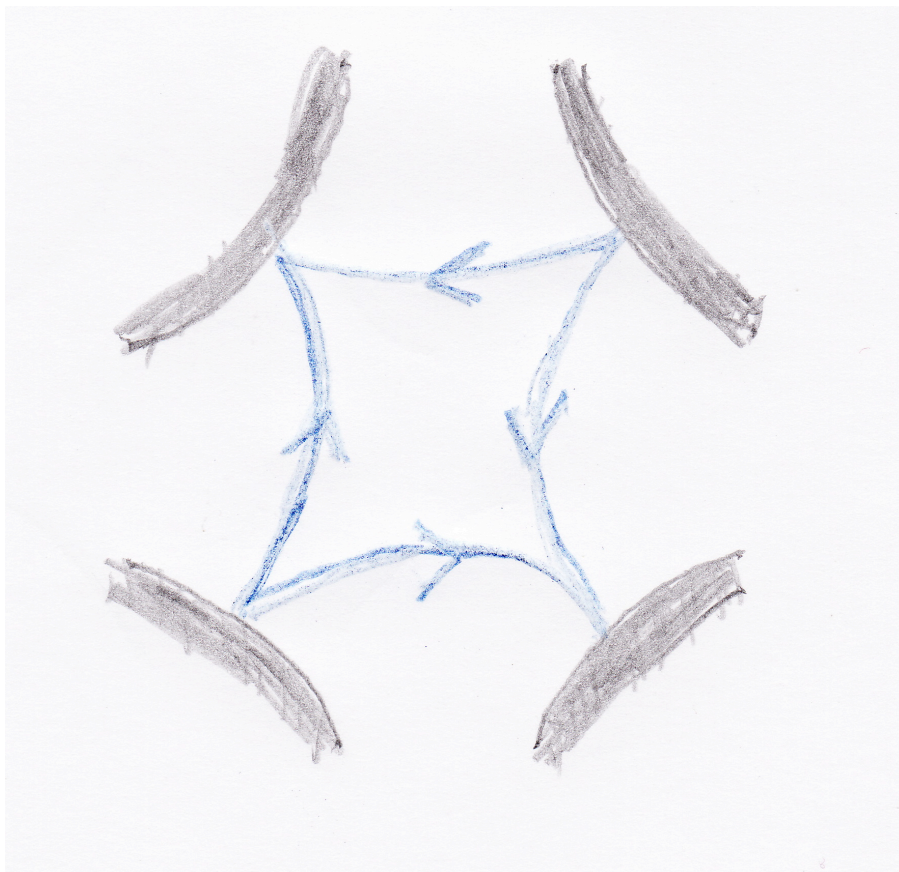
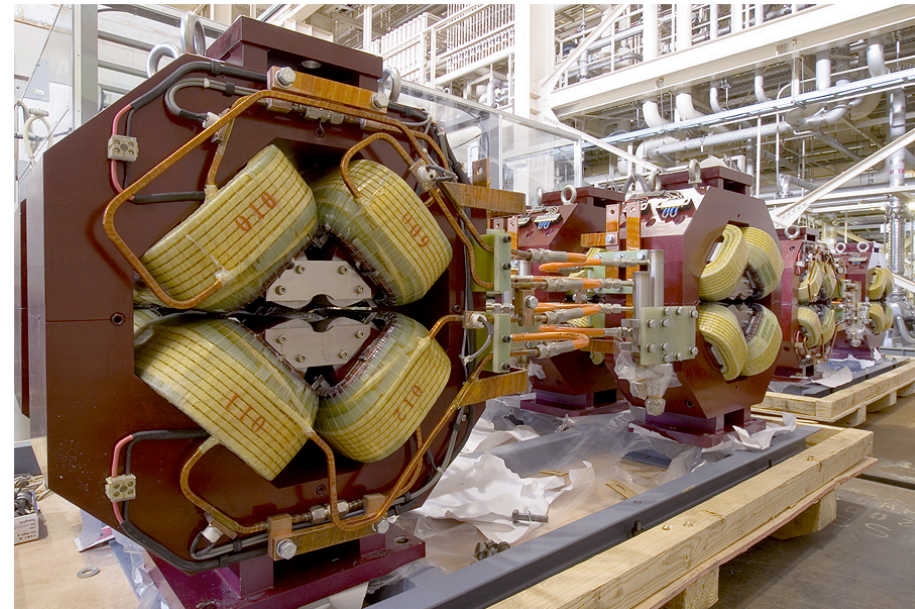

# FODO Lattice

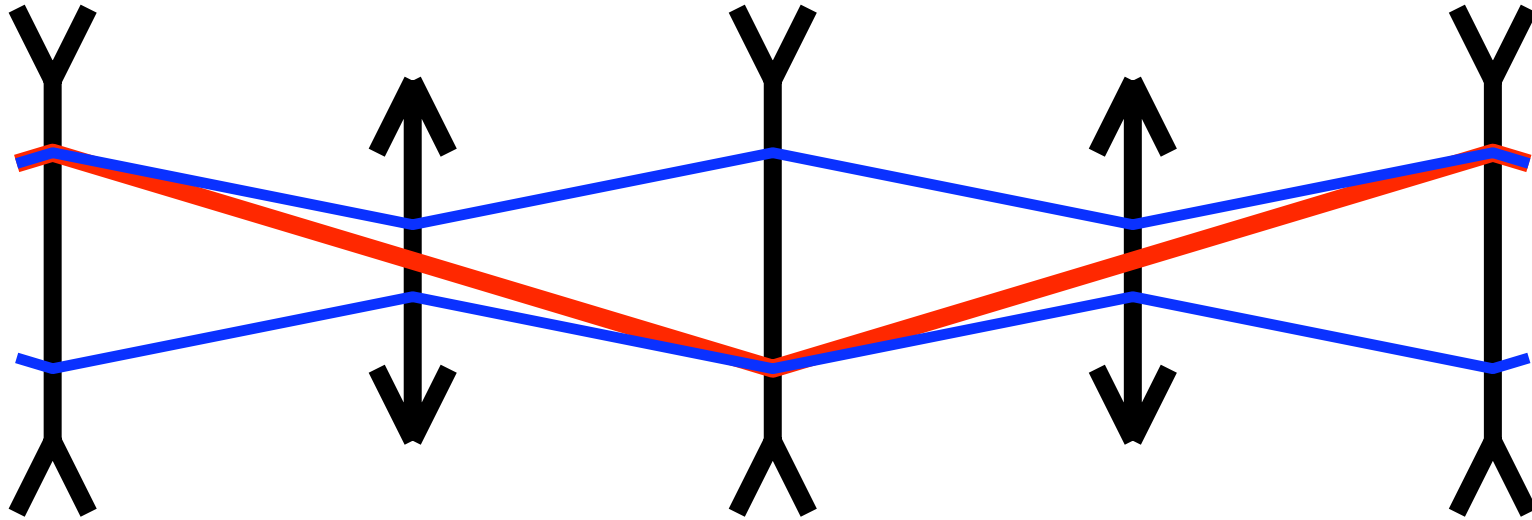

- Focusing is achieved by alternating focusing and defocusing quadrupoles

# CLIC Lattice Design

- Used  $\beta \propto \sqrt{E}$ ,  $\Delta\Phi = \text{const}$ 
  - balances wakes and dispersion
  - roughly constant fill factor
  - phase advance is chosen to balance between wakefield and ground motion effects
- Preliminary lattice
  - made for  $N = 3.7 \times 10^9$
  - quadrupole dimensions need to be confirmed
  - some optimisations remain to be done
- Total length 20867.6m
  - fill factor 78.6%

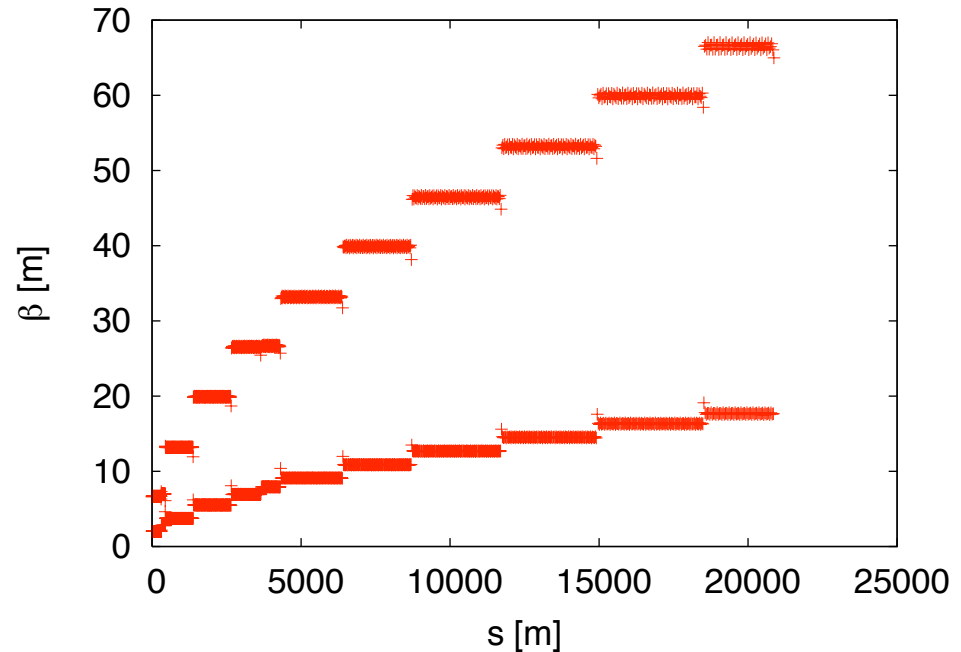

- 12 different sectors used
- Matching between sectors using 7 quadrupoles to allow for some energy bandwidth

# ILC Lattice

- In the ILC constant quadrupole spacing is chosen
- The phase advance per cell is constant
- The phase advance is different in the two planes
  - reduces some coupling effects between the two planes

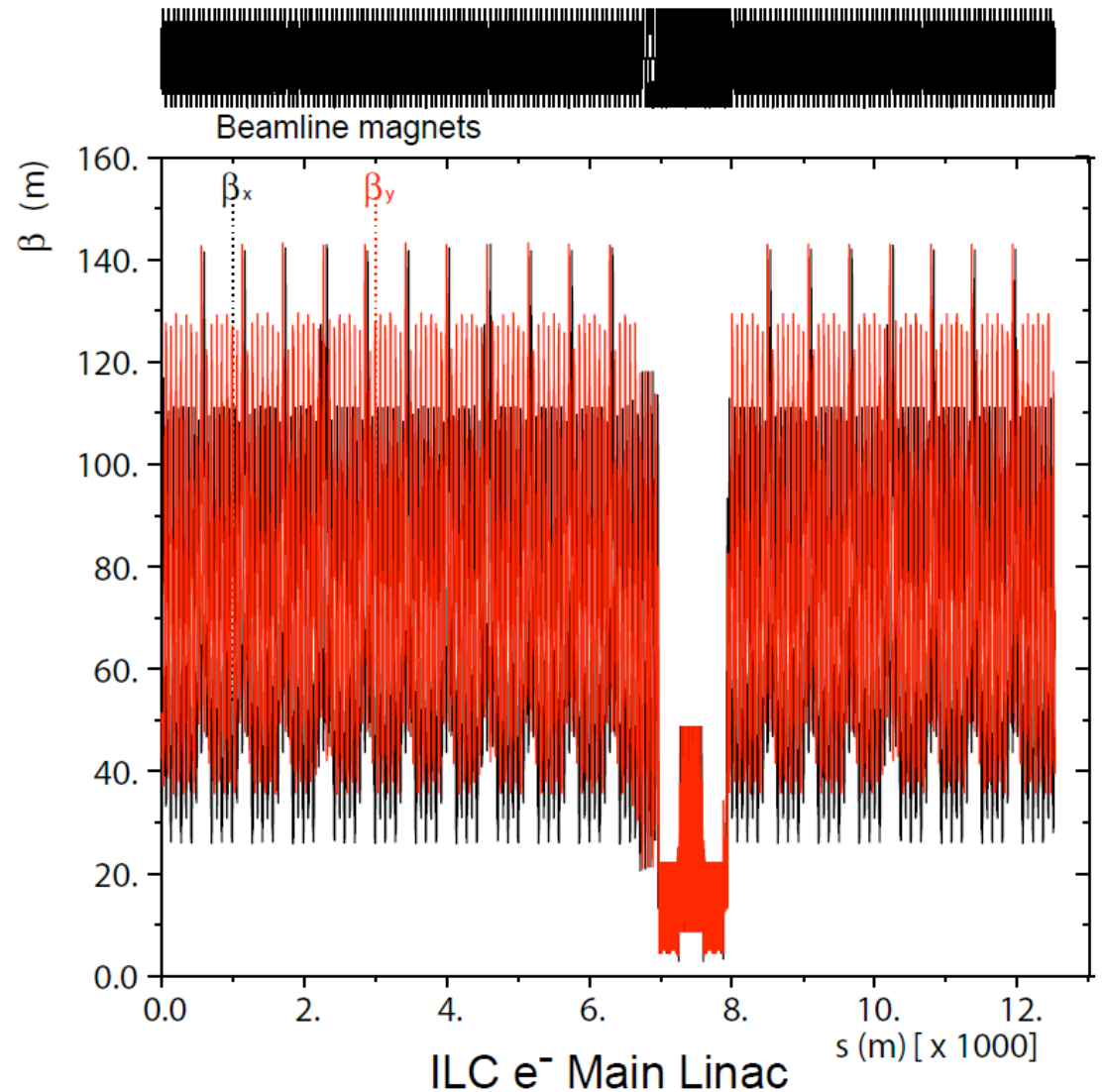
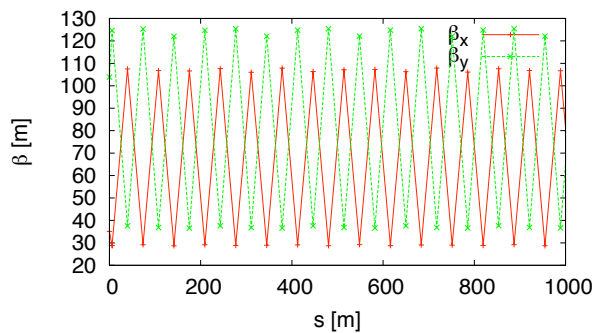

# Hill's Equation and Beta-Functions

- In many interesting cases the particle motion can be described by Hill's equation

$$x''(s) + K(s)x(s) = 0$$

The solutions for this equation can be formulated as

$$x(s) = \sqrt{\epsilon\beta(s)} \cos(\phi(s) + \phi_0)$$
$$x'(s) = \sqrt{\frac{\epsilon}{\beta(s)}} \left[ \frac{\beta'}{2} \cos(\phi(s) + \phi_0) - \sin(\phi(s) + \phi_0) \right]$$

where

$$\phi(s) = \int_0^s \frac{1}{\beta(s')} ds'$$

and  $\beta$  has to fulfill

$$\frac{\beta''\beta}{2} - \frac{\beta'^2}{4} + K\beta^2 = 1$$

- The solution can be easily verified
- It depends partially on the particle  $(\epsilon, \phi_0)$  and partially on the lattice  $(\beta)$

# Phase Space Representation

$$x(s) = \sqrt{\epsilon\beta(s)} \cos(\phi(s) + \phi_0) \quad \dot{x}$$

$$x'(s) = \sqrt{\frac{\epsilon}{\beta(s)}} \left[ \frac{\beta'}{2} \cos(\phi(s) + \phi_0) - \sin(\phi(s) + \phi_0) \right]$$

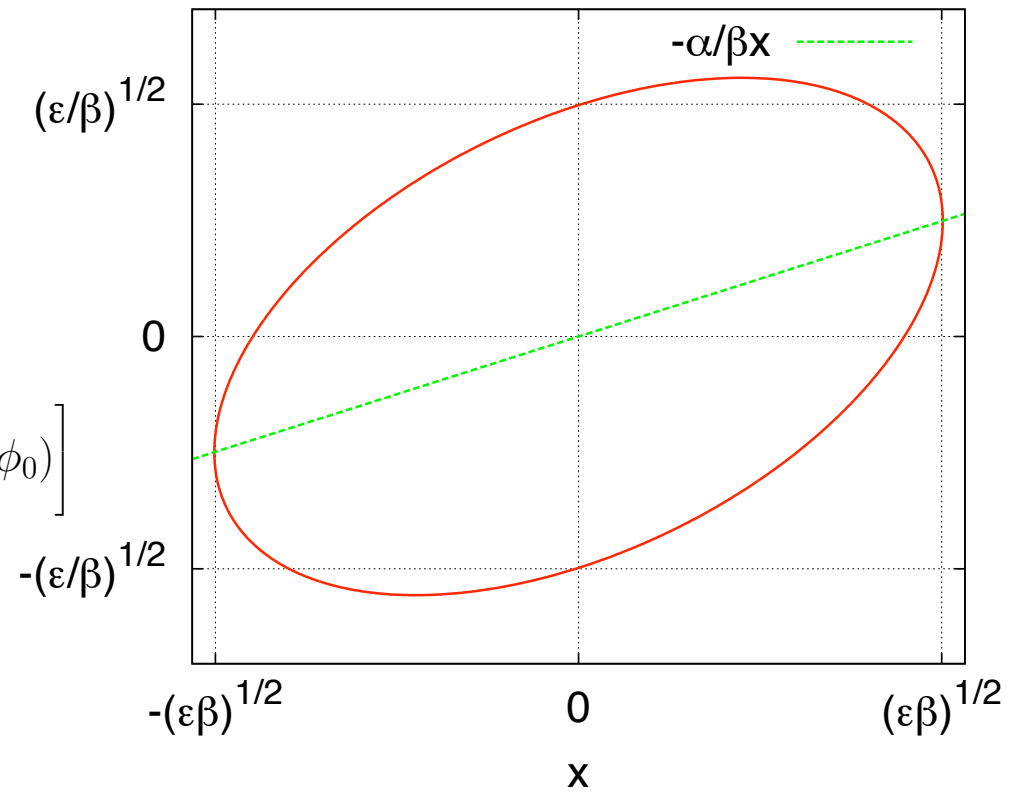

# Impact of Single Bunch Transverse Wakefields

# Example of a Transverse Wakefield (CLIC)

Fit obtained by K. Bane  
 For short distances the wake-  
 field rises linear  
 Summation of an infinite num-  
 ber of sine-like modes with dif-  
 ferent frequencies

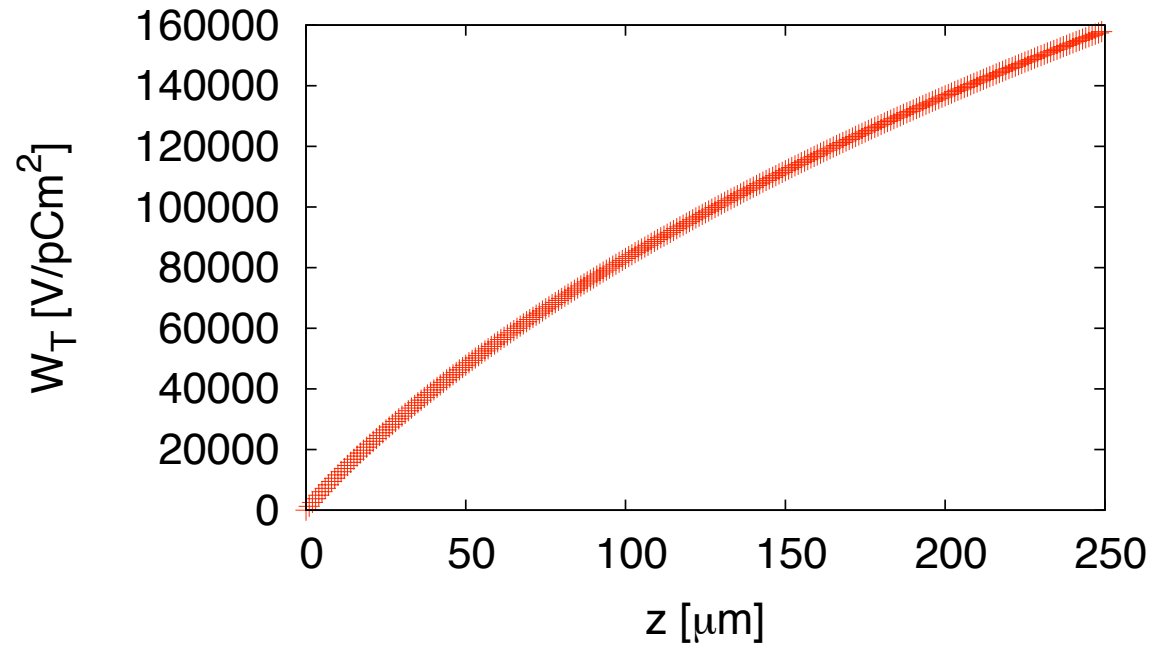

$$z_0 = 0.169a^{1.79}g^{0.38}\left(\frac{1}{l}\right)^{1.17}$$

$$W_{\perp}(z) = 4\frac{Z_0cz_0}{\pi a^4}\left[1 - \left(1 + \sqrt{\frac{z}{z_0}}\right)\exp\left(-\sqrt{\frac{z}{z_0}}\right)\right]$$

$$W_{\perp}(z \ll z_0) \approx 4\frac{Z_0cz}{\pi a^4}$$



# Beam Stability

- Transverse stability of a beam with initial offset of  $\sigma_y$ 
    - no energy spread assumed in the beam
    - emittance with respect to the beam axis is shown
- ⇒ acceptable for ILC (top)
- ⇒ intolerable for CLIC (bottom)

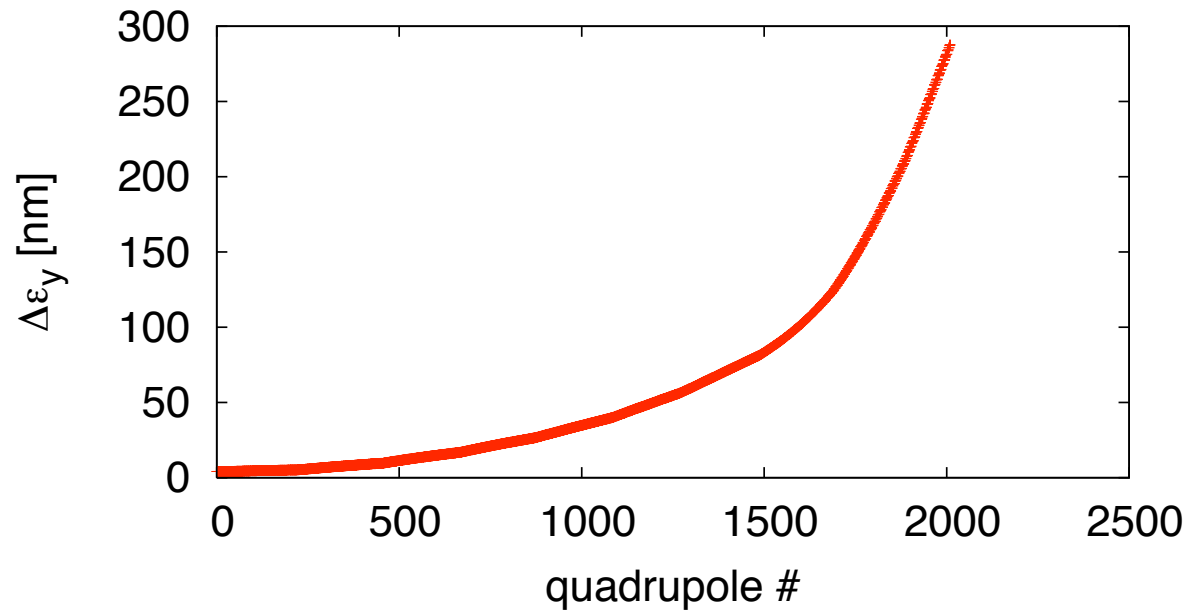
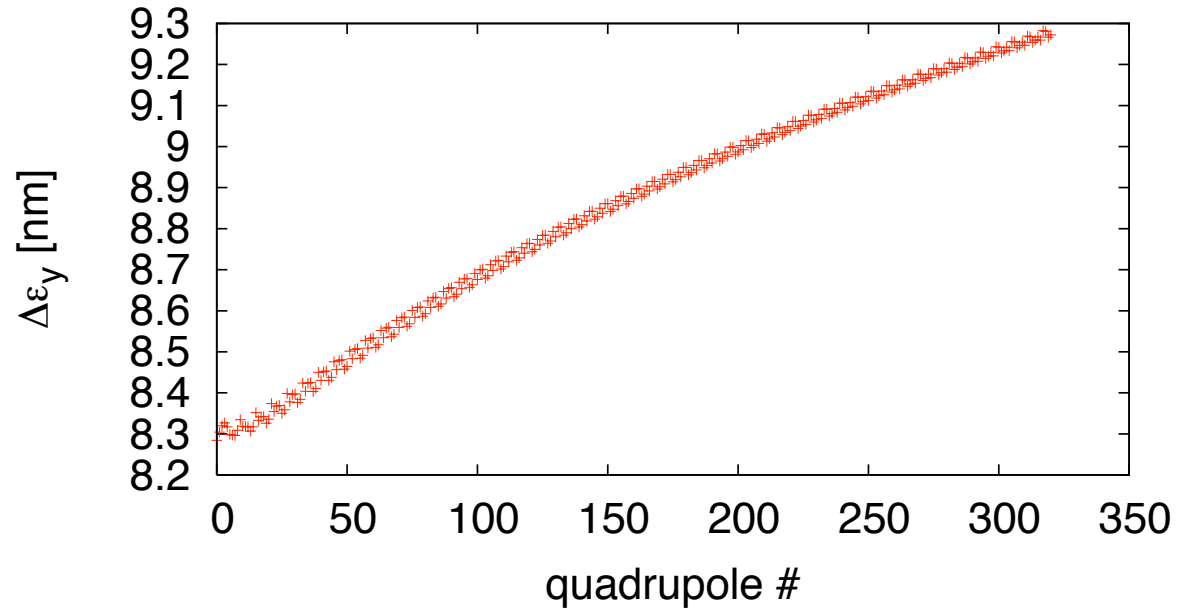

# Two-Particle Wakefield Model

- Assume bunch can be represented by two particles and constant  $K(s) = 1/\beta^2$ 
  - second particle is kicked by transverse wakefield
  - initial oscillation

$$x_1'' + \frac{1}{\beta^2}x_1 = 0 \quad x_2'' + \frac{1}{\beta^2}x_2 = \frac{Ne^2W_{\perp}}{P_Lc}x_1$$

$$x_1 = x_0 \cos\left(\frac{s}{\beta}\right)$$

$$x_2'' + \frac{1}{\beta^2}x_2 = x_0 \frac{Ne^2W_{\perp}}{P_Lc} \cos\left(\frac{s}{\beta}\right)$$

- Solution is simple with an ansatz

$$x_2 = x_0 \cos\left(\frac{s}{\beta}\right) + \left(\frac{x_0 Ne^2W_{\perp}\beta}{2E}s\right) \sin\left(\frac{s}{\beta}\right)$$

- ⇒ Amplitude of second particle oscillation is growing
- ⇒ The bunch charge and length matter as well as the lattice
- ⇒ Have a closer look into wakefields

# BNS Damping solution

- First particle performs a harmonic oscillation

$$x_1(s) = x_0 \cos\left(\frac{s}{\beta_1}\right)$$

- We want the second particle to perform the **same** oscillation
- Modify unperturbed oscillation frequency of second particle

$$x_2 = x_0 \cos\left(\frac{s}{\beta_2}\right)$$

- Leads to

$$x_2'' + \frac{1}{\beta_2^2}x_2 = x_0 \frac{Ne^2W_\perp}{P_Lc} \cos\left(\frac{s}{\beta_1}\right) = x_1 \frac{Ne^2W_\perp}{P_Lc}$$

- Assuming (can be achieved by changing energy of second particle)

$$\frac{1}{\beta_2^2} = \frac{1}{\beta_1^2} + \frac{Ne^2W_\perp}{P_Lc}$$

- Yields simple solution

$$x_2 = x_0 \cos\left(\frac{s}{\beta_1}\right) = x_1$$

⇒ No more wakefield effect

# Achieving Beam Stability

- Transverse wakes act as defocusing force on tail  
⇒ beam jitter is exponentially amplified
- BNS (Balakin, Novokhatsky, and Smirnov) damping prevents this growth
  - manipulate RF phases to have energy spread
  - take spread out at end

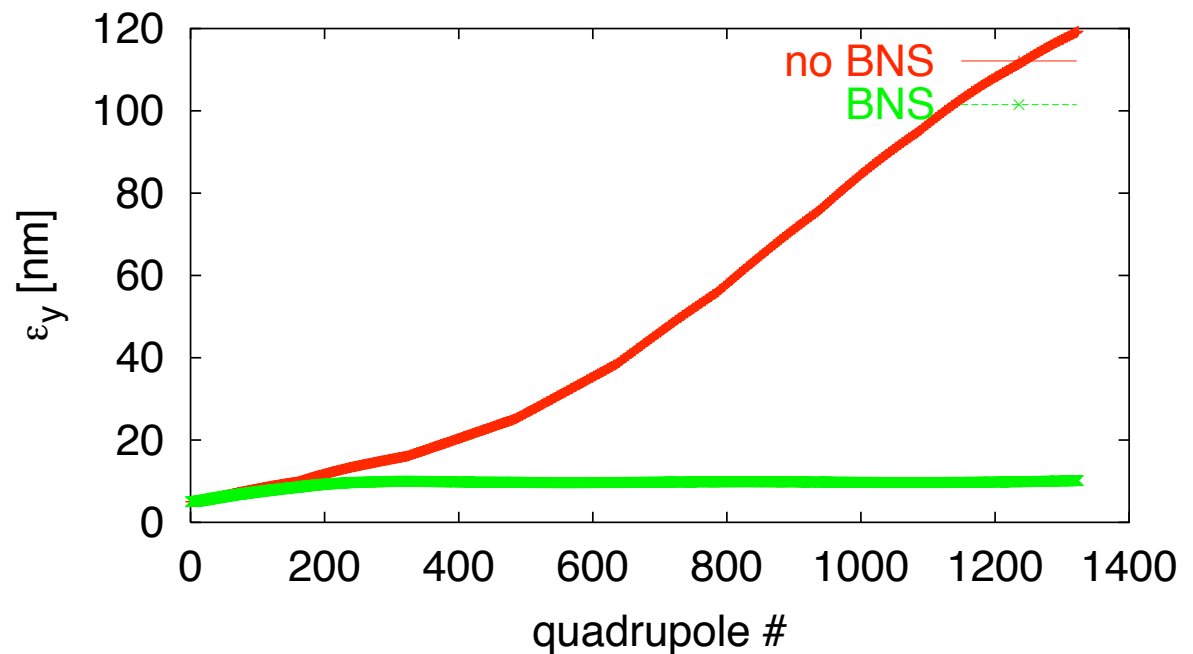
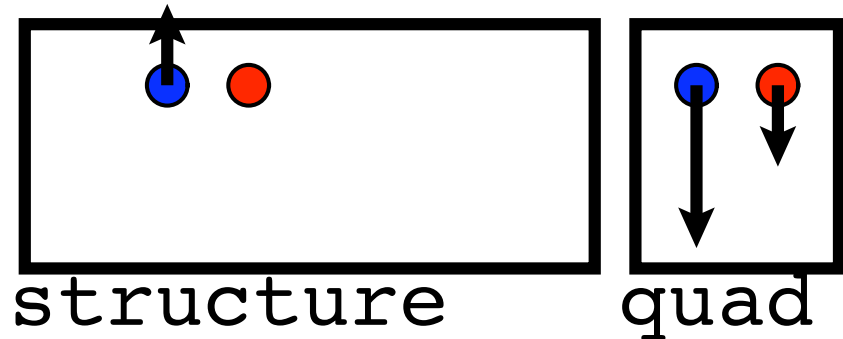

# Energy Spread and Beam Stability

- Trade-off in fixed lattice
  - large energy spread is more stable
  - small energy spread is better for alignment

⇒ Beam with  $N = 3.7 \times 10^9$  can be stable

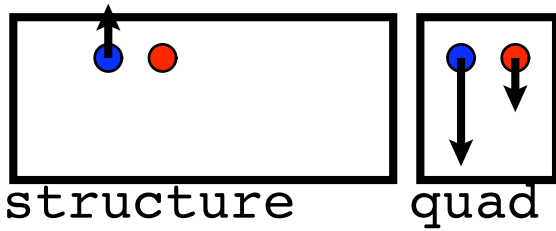

⇒ Tolerances are not a unique number

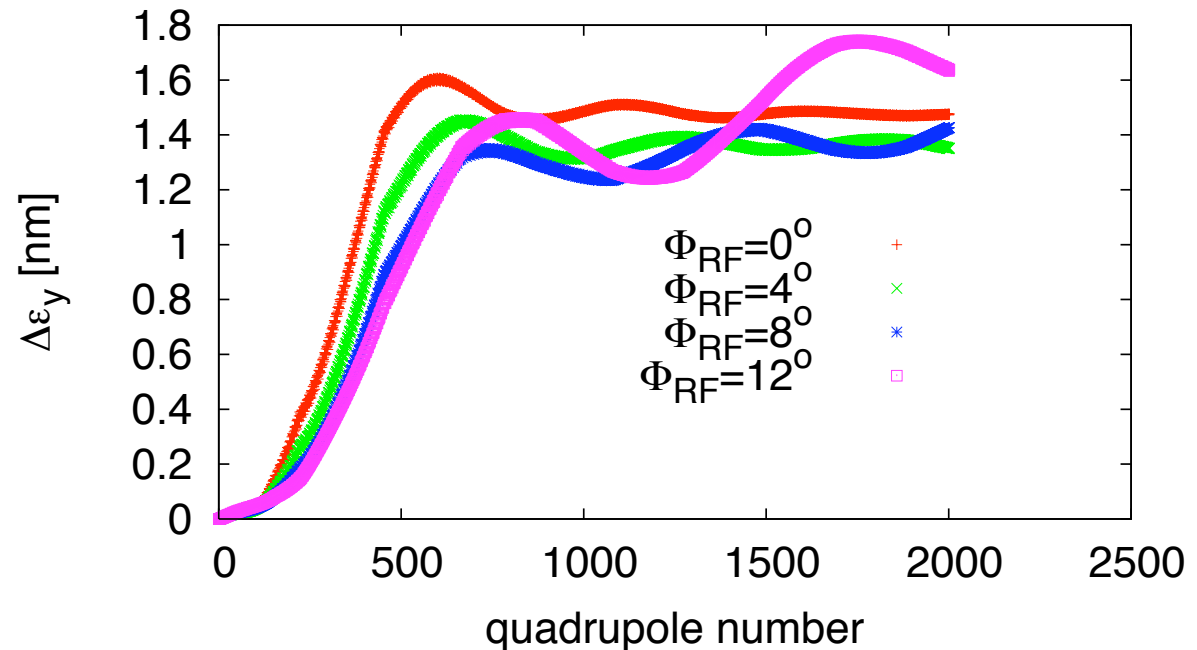
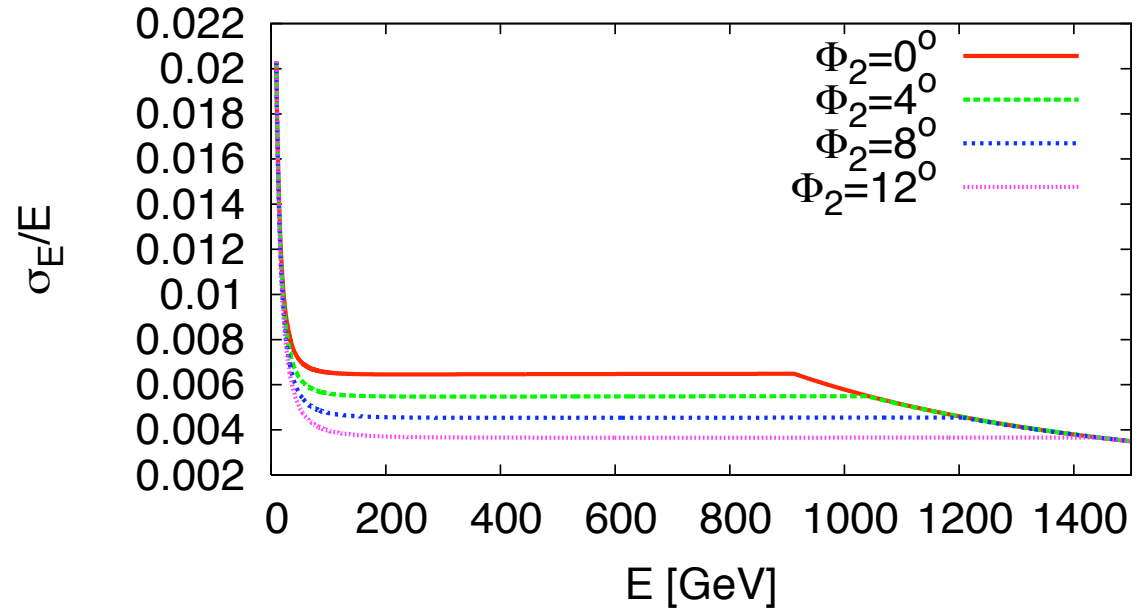

# Impact of Multi-Bunch Wakefields

# Multi-Bunch Wakefields

- Long-range transverse wakefields are sine-like
- They can be reduced by
  - damping
  - detuning

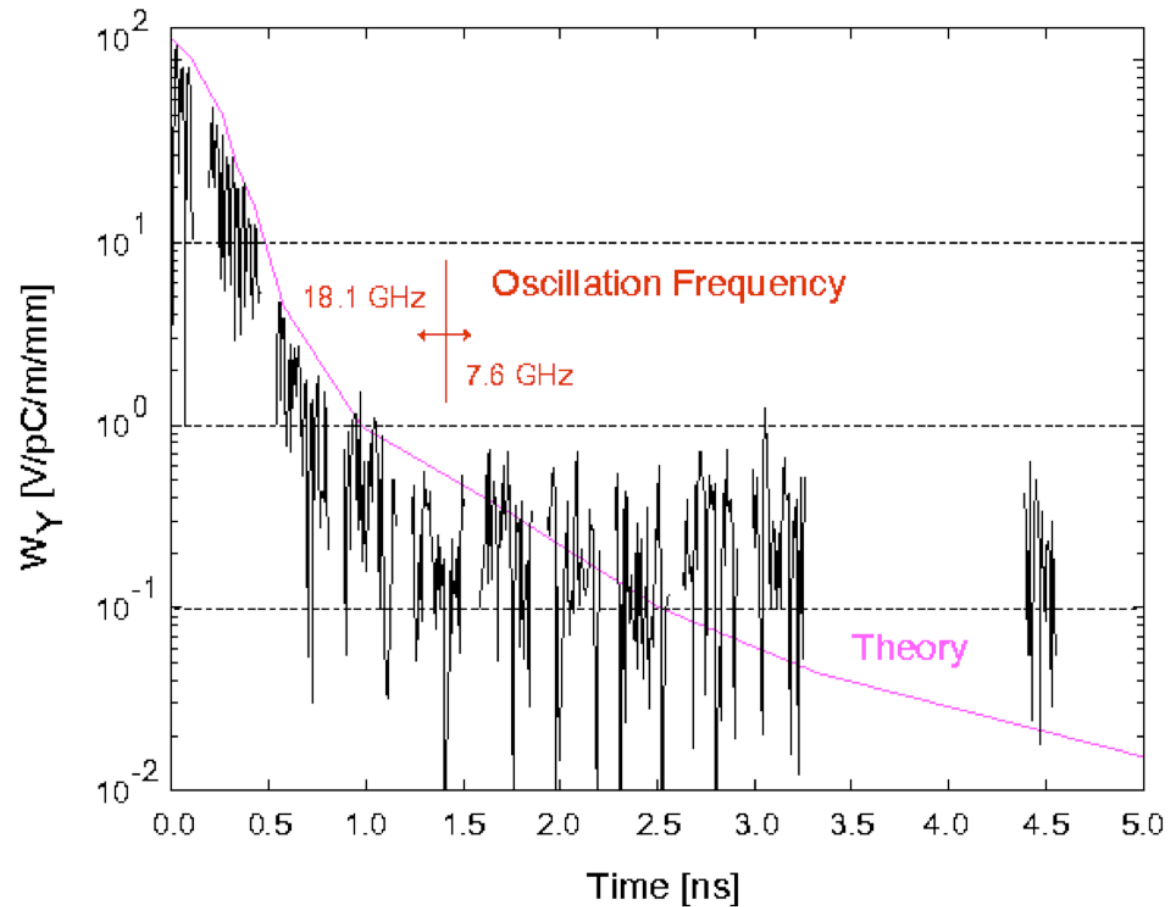

$$W_{\perp}(z) = \sum_i^{\infty} 2k_i \sin\left(2\pi \frac{z}{\lambda_i}\right) \exp\left(-\frac{\pi z}{\lambda_i Q_i}\right)$$

# Damping

- Damping can be achieved by extracting the power of transverse modes from the structure
- In CLIC each cell has waveguides for this purpose
  - the fundamental mode cannot escape
- ILC has antennas at the end
  - weaker damping but bunch distance is larger
- Note: the difference has since been understood

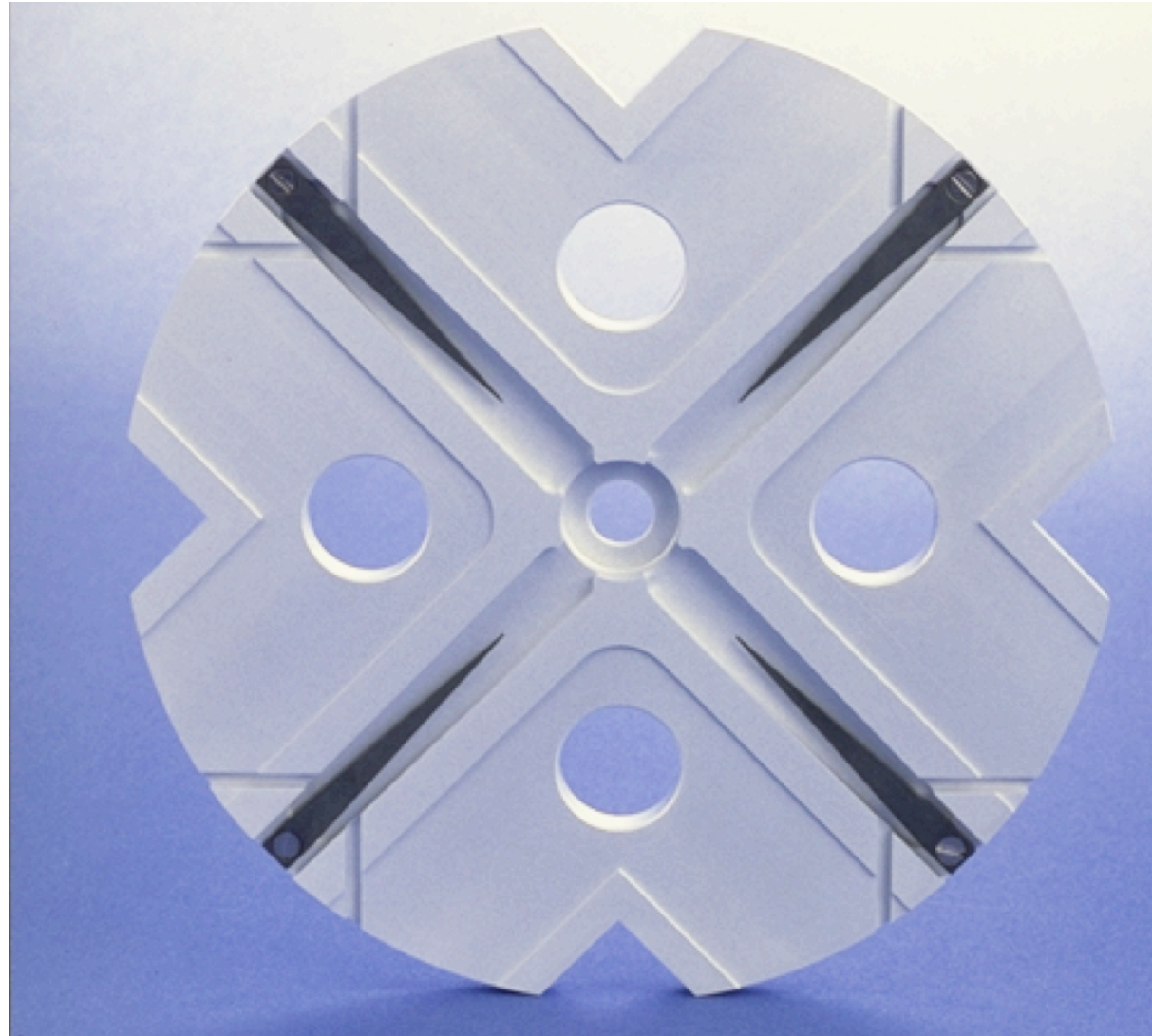



# Detuning

To make our life simple we neglect damping

We split the wakefield  $W(z) = a \sin(kz)$  into two modes

$$W(z) = W_0 \frac{\sin((k + \Delta)z) + \sin((k - \Delta)z)}{2}$$

the resulting amplitude is

$$W(z) = W_0 \sin(kz) \cos(\Delta z)$$

integrating over a Gaussian distribution yields

$$W(z) = W_0 \sin(kz) \int_0^\infty \frac{2}{\sqrt{2\pi}\sigma_\Delta} \exp\left(-\frac{\Delta^2}{2\sigma_\Delta^2}\right) \cos(\Delta z) d\Delta$$
$$\Rightarrow W(z) = W_0 \sin(kz) \exp\left(-\frac{(z\Delta)^2}{2}\right)$$

- For a limited number of modes, recoherence can occur  
 $\Rightarrow$  damping is also needed
- In ILC detuning is important

# Multi-Bunch Jitter Emittance Growth (CLIC)

- Multi-bunch effects can be calculated analytically for point-like bunches
  - an energy spread leads to a more stable case
- Simulations show
  - point-like bunches
  - bunches with energy spread due to bunch length
  - including also initial energy spread

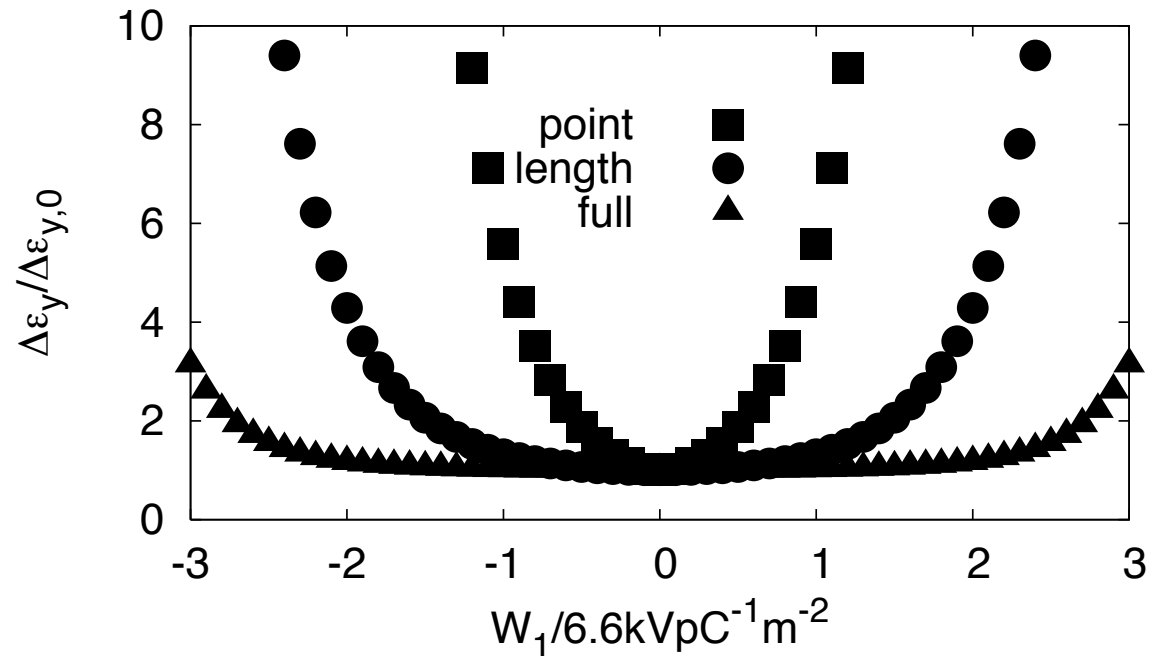

⇒ Point-like bunches is a pessimistic assumption for the dynamic effects

# Static Multi-Bunch Effects (ILC)

- Simulation of long-range transverse wakefield effects
  - with no detuning
  - with random detuning from cavity to cavity
- ⇒ Cavity detuning is essential
- ⇒ Need to ensure that this detuning is present
  - it does happen naturally
  - but also if you depend on it?

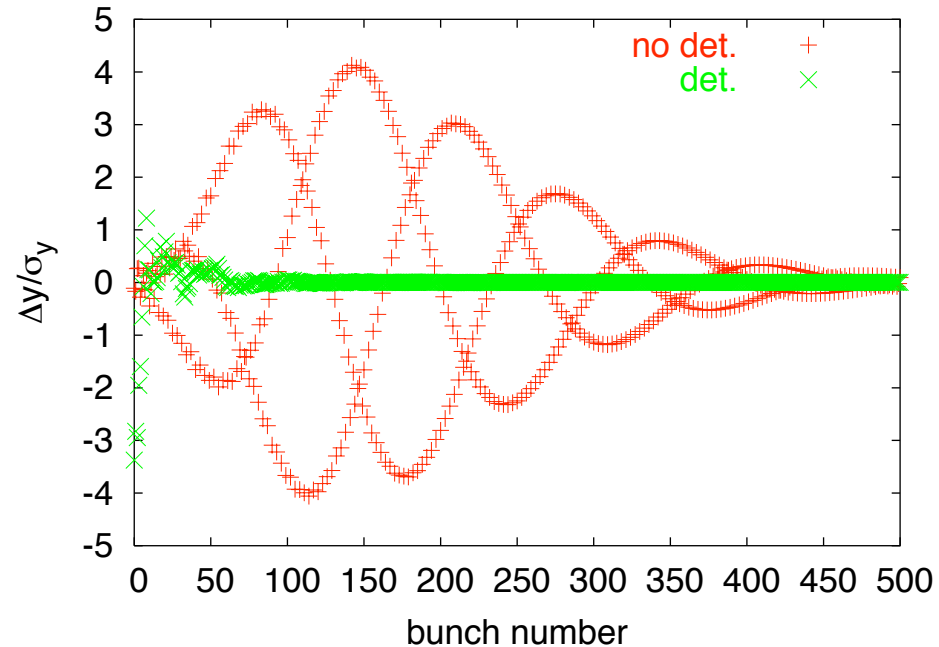

All main linac cavities are scattered by  $500 \mu\text{m}$

Long-range wakefields are represented by a number of RF modes

$$W_{\perp}(z) = \sum_{i=0}^n a_i \sin\left(\frac{2\pi z}{\lambda_i}\right) \exp\left(-\frac{\pi z}{\lambda_i Q_i}\right)$$

- Note results depend on exact frequency of transverse modes
  - some uncertainty in the prediction
  - but not a worry with detuning

# Beam Jitter (ILC)

- Perfect machines used
- 100 machines simulated
  - TESLA wakefields with 0.1% RMS frequency spread
  - beam set to an offset
  - 5% bunch-to-bunch charge variations in uncorrected test beam
  - additional relative emittance growth due to multi-bunch is determined

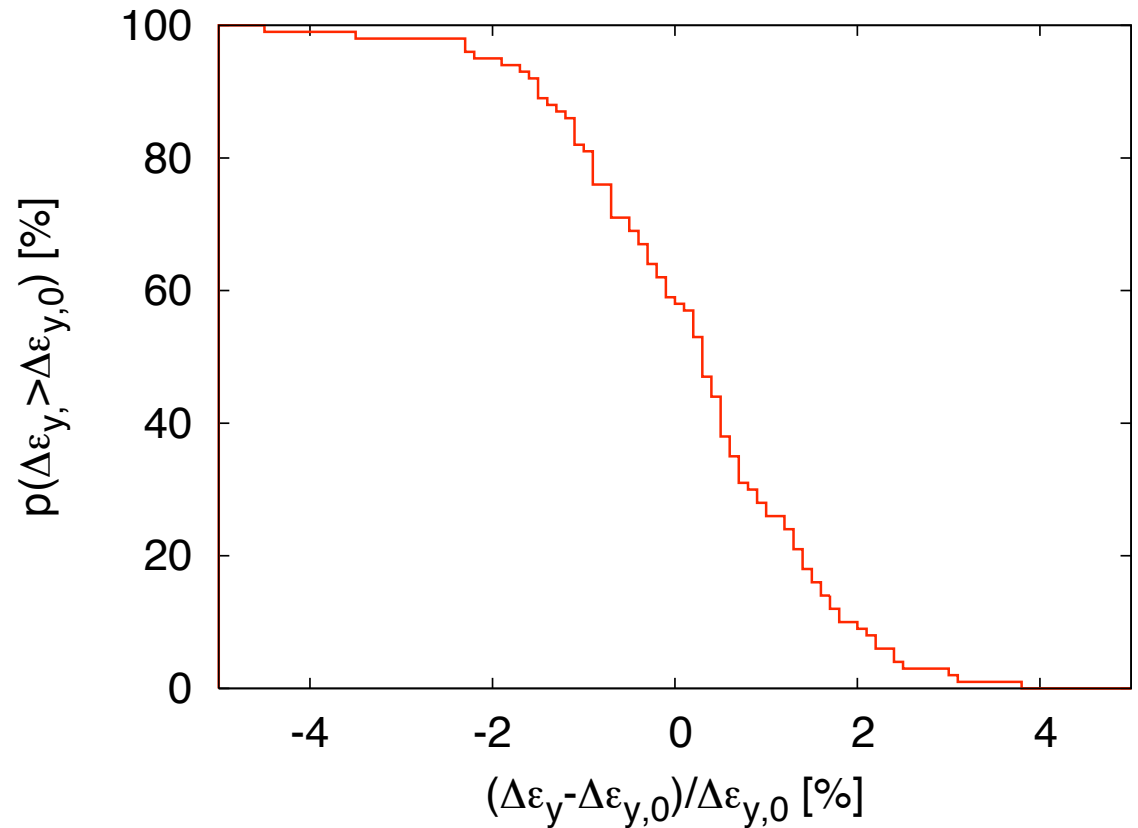

# Imperfections

# Introduction

- Have now been able to design a lattice that can transport the beam
- Need to determine how the imperfections in the machine affect the emittance preservation
- Will discuss the misalignment of elements
  - most important source of static emittance growth
- Have two ways to deal with tight tolerances for imperfections
  - work on the lattice to loosen tolerances
  - push R&D to satisfy tighter tolerances
  - e.g. in CLIC strong effort is ongoing to push imperfections down by about an order of magnitude

# Element Misalignments

- Pre-Alignment imperfections can be roughly categorised into **short-distance** and **long-distance** errors
  - To first order, the imperfections can be treated as independent
    - as long as a linear main linac model is sufficient
  - The short-distance misalignments give largest emittance contribution
    - misalignment of elements is largely independent
    - simulated by scattering elements around a straight line
    - or slightly more complex local model
  - The long-distance misalignments are dominated by the wire system
- ⇒ ignore short-distance misalignments and simulate wire errors only
- Combined studies are mainly for completeness

# Simulation Rational

- One can understand the effects qualitatively
    - some can be calculated analytically
    - some can be approximated analytically
    - but things soon become complex
- ⇒ Beam dynamics tracking code is used for studies (choose your favorite one)
- Implemented models are usually very flexible
    - e.g. linear and non-linear effects
  - Script language used to steer the simulation
  - The art is in using minimum model
    - as little as possible
    - as much as necessary
- ⇒ Cannot say what is in the code but rather what is in each individual study



# Main Linac Static Tolerances

Element	error	with respect to	tolerance	
			CLIC	ILC
Structure	offset	beam	$5.8 \mu\text{m}$	$\approx 700 \mu\text{m}$
Structure	tilt	beam	$220 \mu\text{radian}$	$\approx 1000 \mu\text{radian}$
Quadrupole	offset	straight line	—	—
Quadrupole	roll	axis	$240 \mu\text{radian}$	$190 \mu\text{radian}$
BPM	offset	straight line	$0.44 \mu\text{m}$	$15 \mu\text{m}$
BPM	resolution	BPM center	$0.44 \mu\text{m}$	$15 \mu\text{m}$

- All tolerances for 1nm growth after one-to-one steering
- Goal is to have 90% of the machines achieve an emittance growth due to static effects of less than 5 nm

# Assumed Survey Performance

Element	error	with respect to	alignment	
			ILC	CLIC
Structure	offset	girder	300 $\mu\text{m}$	5 $\mu\text{m}$
Structure	tilts	girder	300 $\mu\text{radian}$	200(*) $\mu\text{m}$
Girder	offset	survey line	200 $\mu\text{m}$	9.4 $\mu\text{m}$
Girder	tilt	survey line	20 $\mu\text{radian}$	9.4 $\mu\text{radian}$
Quadrupole	offset	girder/survey line	300 $\mu\text{m}$	17 $\mu\text{m}$
Quadrupole	roll	survey line	300 $\mu\text{radian}$	$\leq$ 100 $\mu\text{radian}$
BPM	offset	girder/survey line	300 $\mu\text{m}$	14 $\mu\text{m}$
BPM	resolution	BPM center	$\approx$ 1 $\mu\text{m}$	0.1 $\mu\text{m}$
Wakefield mon.	offset	wake center	—	5 $\mu\text{m}$

- In ILC specifications have much larger values than in CLIC
  - more difficult alignment in super-conducting environment
  - dedicated effort for CLIC needed
- Wakefield monitors are currently only foreseen in CLIC
  - but could be an option also in ILC

# Beam-Based Alignment and Tuning Strategy

- Make beam pass linac
  - one-to-one correction
- Remove dispersion, align BPMs and quadrupoles
  - dispersion free steering
  - ballistic alignment
  - kick minimisation
- Remove residual wakefield and dispersive effects
  - accelerating structure alignment (CLIC only)
  - emittance tuning bumps
- Tune luminosity
  - tuning knobs

# Dispersion Free Correction

- Basic idea: use different beam energies
- NLC: switch on/off different accelerating structures
- CLIC (ILC): accelerate beams with different gradient and initial energy
  - try to do this in a single pulse (time resolution)

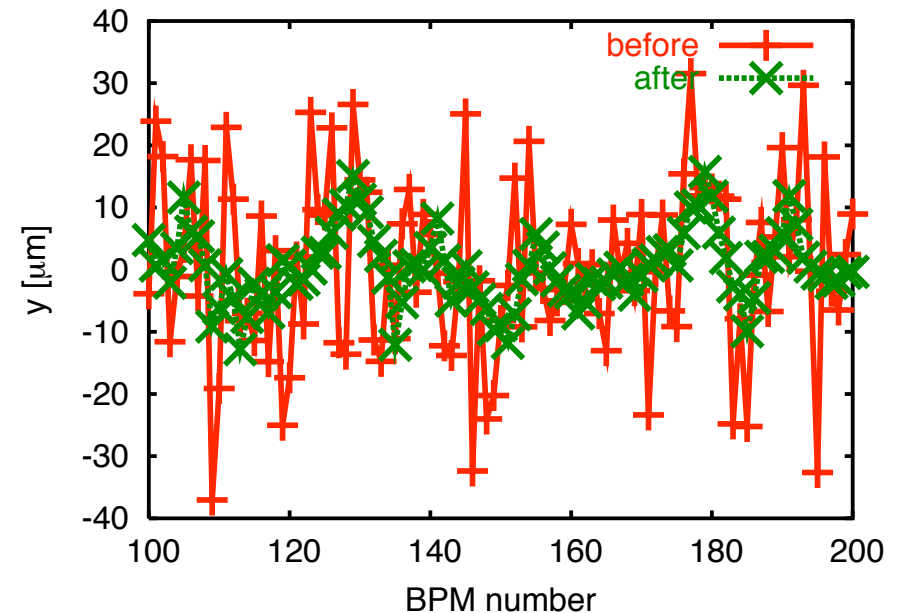

- Optimise trajectories for different energies together:

$$S = \sum_{i=1}^n \left( w_i (x_{i,1})^2 + \sum_{j=2}^m w_{i,j} (x_{i,1} - x_{i,j})^2 \right) + \sum_{k=1}^l w'_k (c_k)^2$$

- Last term is omitted
- Idea is to mimic energy differences that exist in the bunch with different beams

# Emittance Growth (ILC)

Error	with respect to	value	$\Delta\gamma\epsilon_y$ [nm]	$\Delta\gamma\epsilon_{y,121}$ [nm]	$\Delta\gamma\epsilon_{y,dfs}$ [nm]
Cavity offset	module	300 $\mu\text{m}$	3.5	0.2	0.2(0.2)
Cavity tilt	module	300 $\mu\text{radian}$	2600	< 0.1	1.8(8)
BPM offset	module	300 $\mu\text{m}$	0	360	4(2)
Quadrupole offset	module	300 $\mu\text{m}$	<b>700000</b>	0	0(0)
Quadrupole roll	module	300 $\mu\text{radian}$	<b>2.2</b>	2.2	2.2(2.2)
Module offset	perfect line	200 $\mu\text{m}$	<b>250000</b>	155	2(1.2)
Module tilt	perfect line	20 $\mu\text{radian}$	<b>880</b>	1.7	—

- The results of the reference DFS method is quoted, results of a different implementation in brackets
- Note in the simulations the correction the quadrupoles had been shifted, otherwise some residual effect of the quadrupole misalignment would exist

# Beam-Based Structure Alignment (CLIC)

- Each structure is equipped with a wake-field monitor (RMS position error  $5 \mu\text{m}$ )
  - Up to eight structures on one movable girders
- ⇒ Align structures to the beam
- Assume identical wake fields
    - the mean structure to wakefield monitor offset is most important
    - in upper figure monitors are perfect, mean offset structure to beam is zero after alignment
    - scatter around mean does not matter a lot
  - With scattered monitors
    - final mean offset is  $\sigma_{wm}/\sqrt{n}$
  - In the current simulation each structure is moved independently
  - A study has been performed to move the articulation points

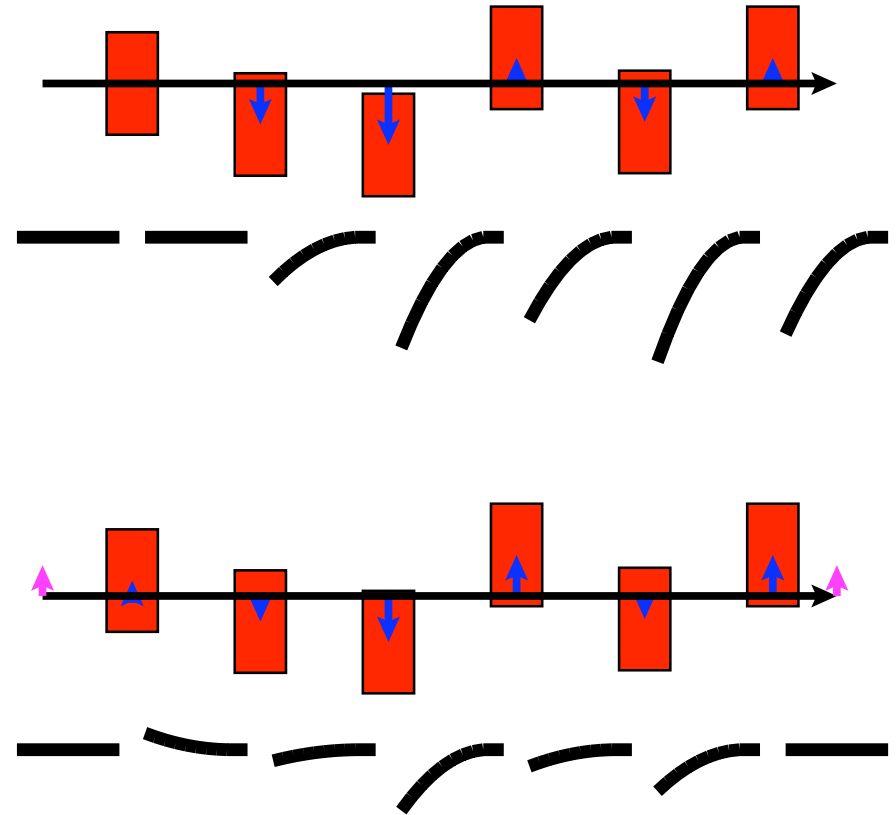

- For our tolerance  $\sigma_{wm} = 5 \mu\text{m}$  we find  $\Delta\epsilon_y \approx 0.5 \text{ nm}$ 
  - some dependence on alignment method

# Emittance Tuning Bumps

- Emittance (or luminosity) tuning bumps can further improve performance
  - globally correct wake-field by moving some structures
  - similar procedure for dispersion
- Need to monitor beam size
- Optimisation procedure
  - measure beam size for different bump settings
  - make a fit to determine optimum setting
  - apply optimum
  - iterate on next bump

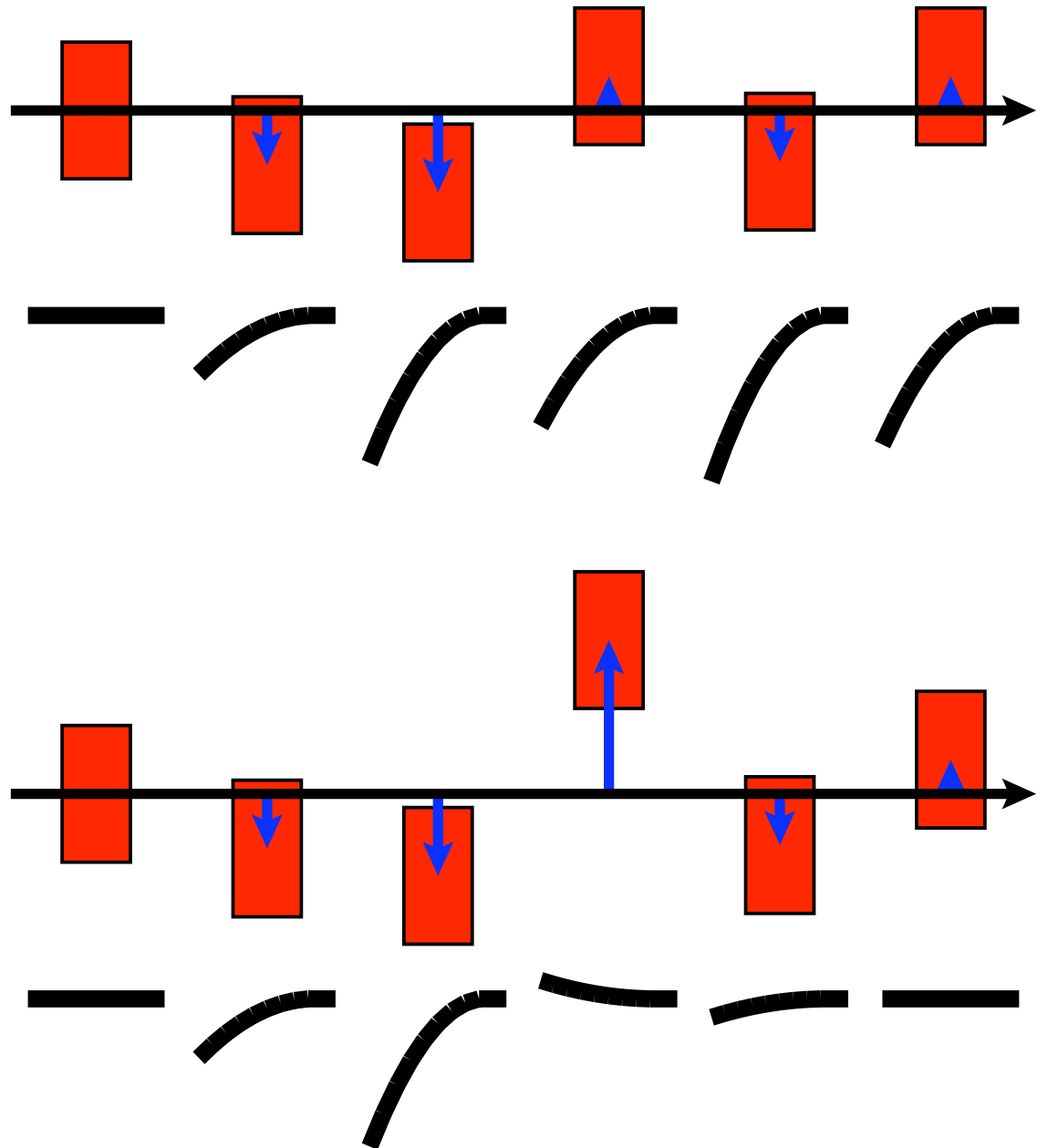

# Final Emittance Growth (CLIC)

imperfection	with respect to	symbol	value	emitt. growth
BPM offset	wire reference	$\sigma_{BPM}$	14 $\mu\text{m}$	0.367 nm
BPM resolution		$\sigma_{res}$	0.1 $\mu\text{m}$	0.04 nm
accelerating structure offset	girder axis	$\sigma_4$	10 $\mu\text{m}$	0.03 nm
accelerating structure tilt	girder axis	$\sigma_t$	200 $\mu\text{radian}$	0.38 nm
articulation point offset	wire reference	$\sigma_5$	12 $\mu\text{m}$	0.1 nm
girder end point	articulation point	$\sigma_6$	5 $\mu\text{m}$	0.02 nm
wake monitor	structure centre	$\sigma_7$	5 $\mu\text{m}$	0.54 nm
quadrupole roll	longitudinal axis	$\sigma_r$	100 $\mu\text{radian}$	$\approx 0.12$ nm

- Selected a good DFS implementation
  - trade-offs are possible
- Multi-bunch wakefield misalignments of 10  $\mu\text{m}$  lead to  $\Delta\epsilon_y \approx 0.13$  nm
- Performance of local pre-alignment is acceptable

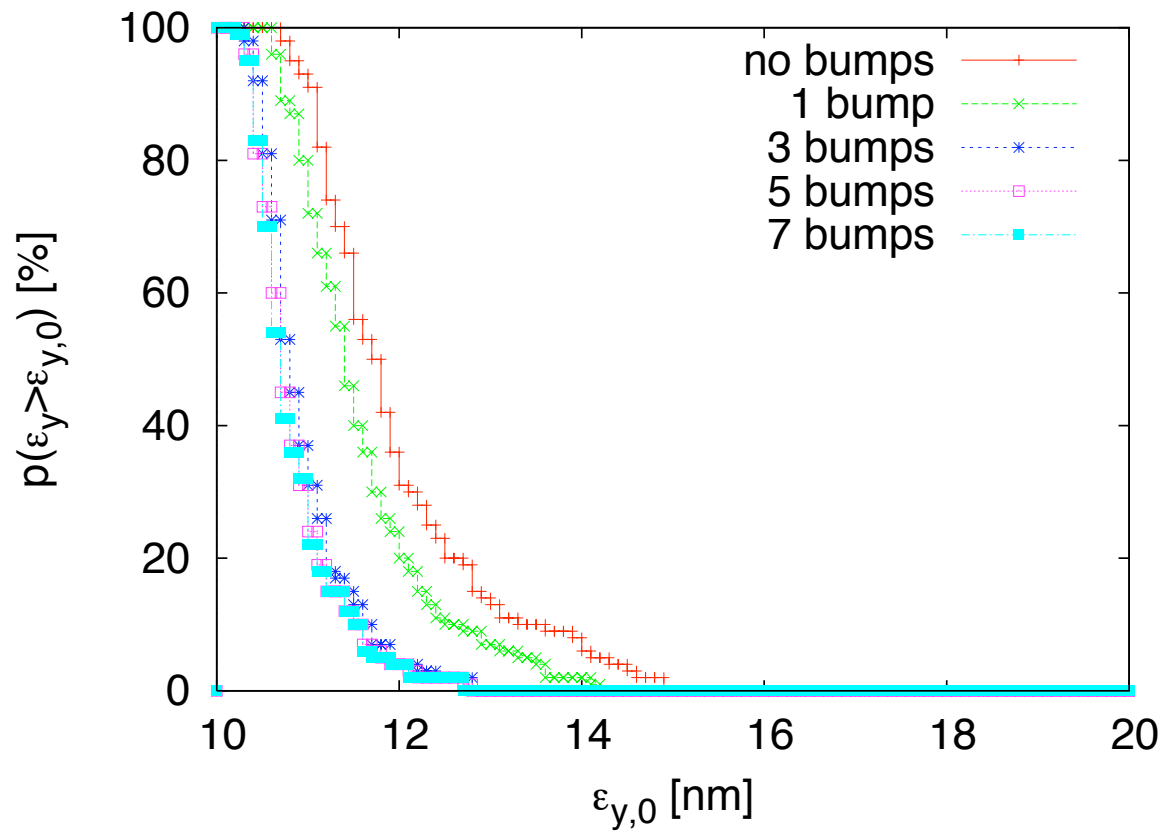



## Results (ILC)

- DFS brings us close to the required performance
  - Tuning of the dispersion helps a lot
  - Even wakefield tuning helps us
  - The remaining emittance growth is to a significant extent due to quadrupole roll
- ⇒ should add a tuning bump for this effect as well

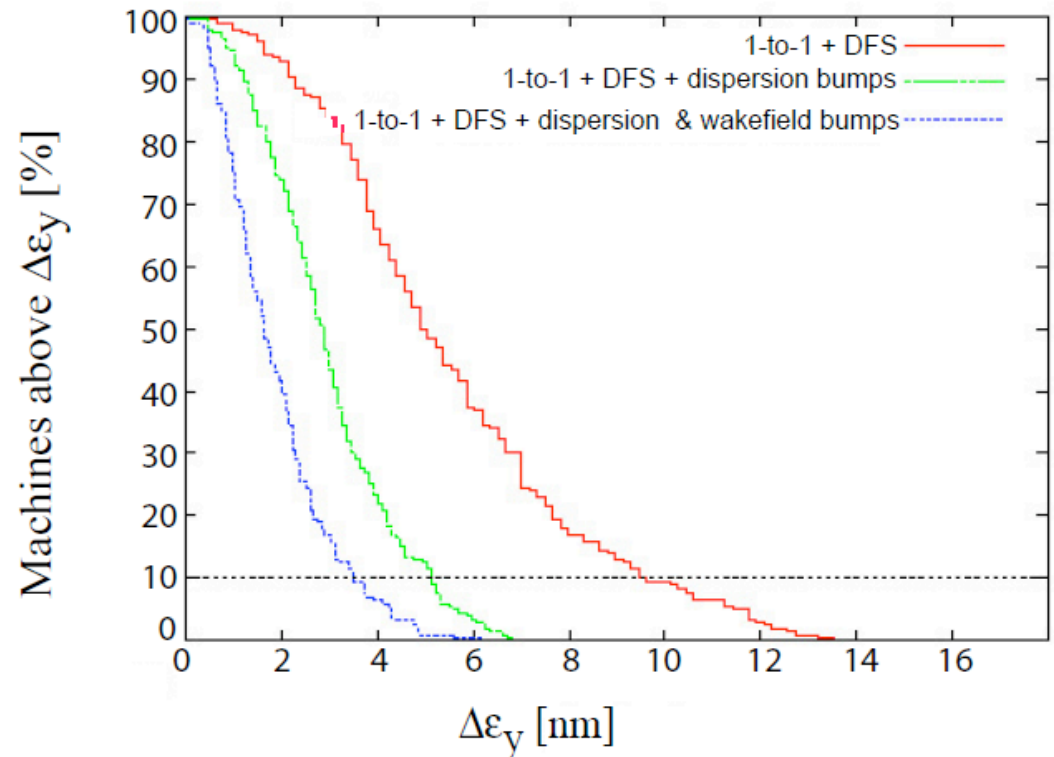

# Dependence on Weights (Old CLIC Parameters)

- For TRC parameters set
  - One test beam is used with a different gradient and a different incoming beam energy
- ⇒ BPM position errors are less important at large  $w_1$
- ⇒ BPM resolution is less important at small  $w_1$
- ⇒ Need to find a compromise
- ⇒ There is no such thing as “the” tolerance for one error source

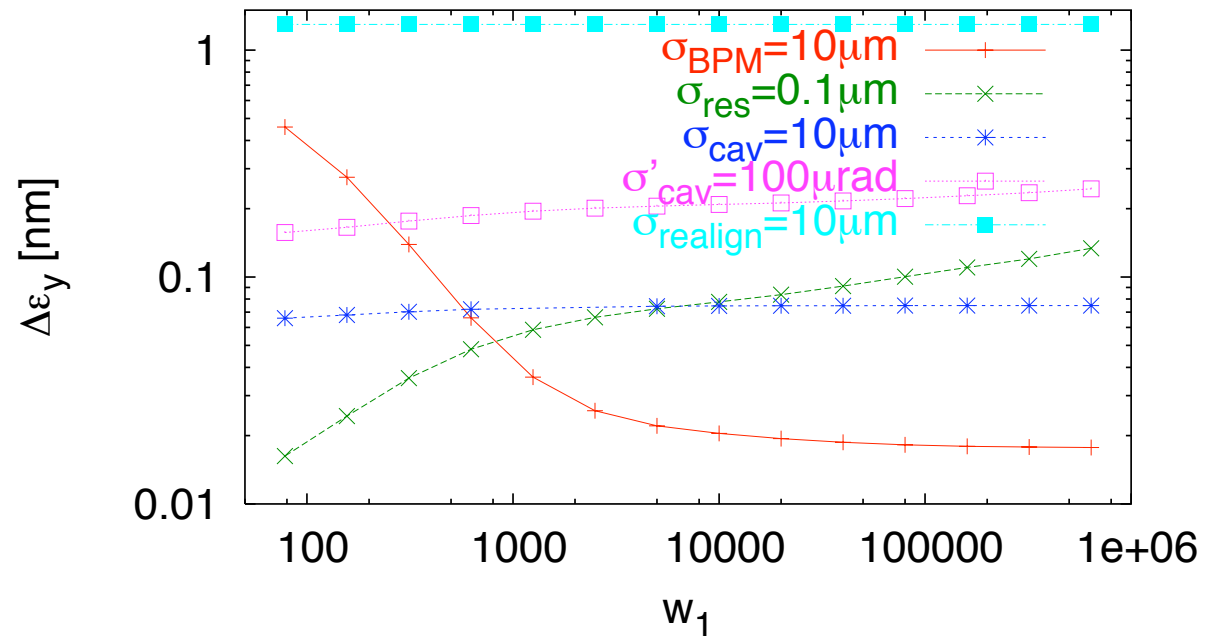

# Growth Along Main Linac (CLIC)

- Emittance growth along the main linac due to the different imperfections
- Growth is mainly constant per cell
  - follows from first principles applied during lattice design
- Exception is structure tilt
  - due to uncorrelated energy spread
  - flexible weight to be investigated
- Some difference for BPMs
  - due to secondary emittance growth

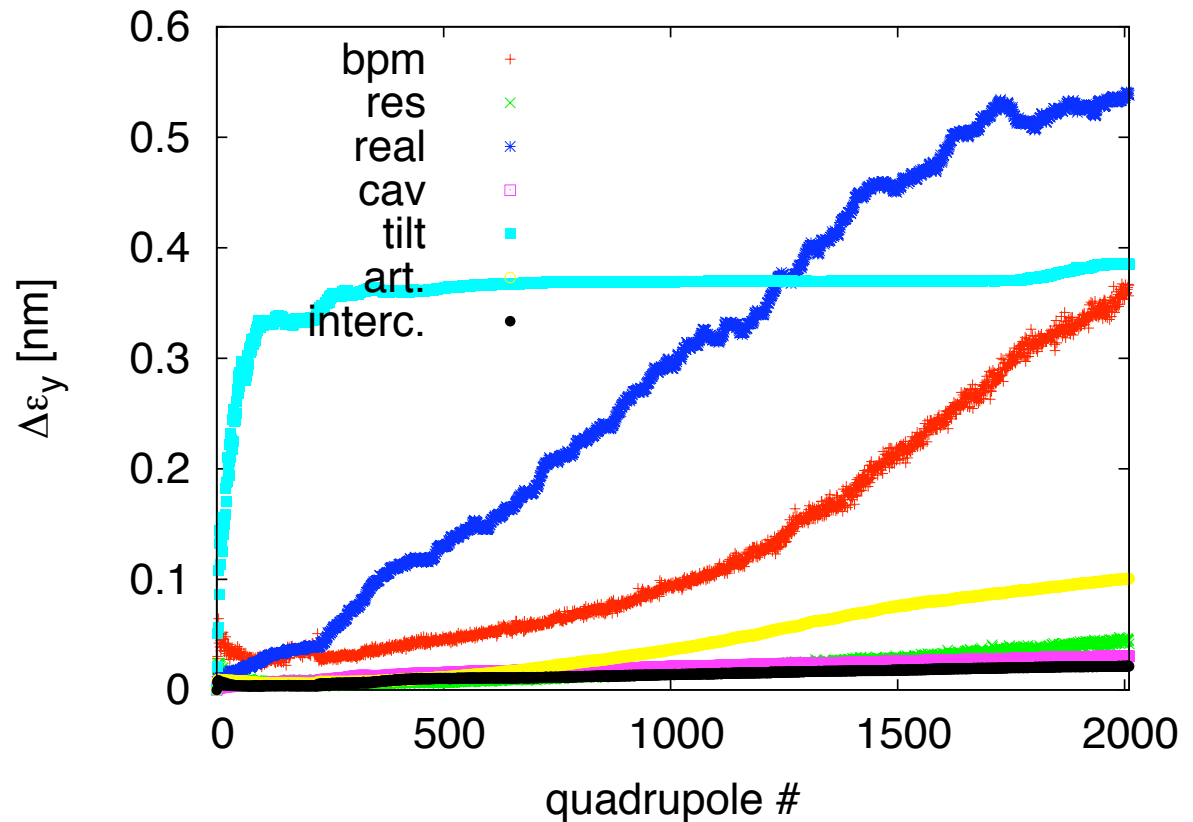

# Sensitivity to Survey Line Errors (CLIC)

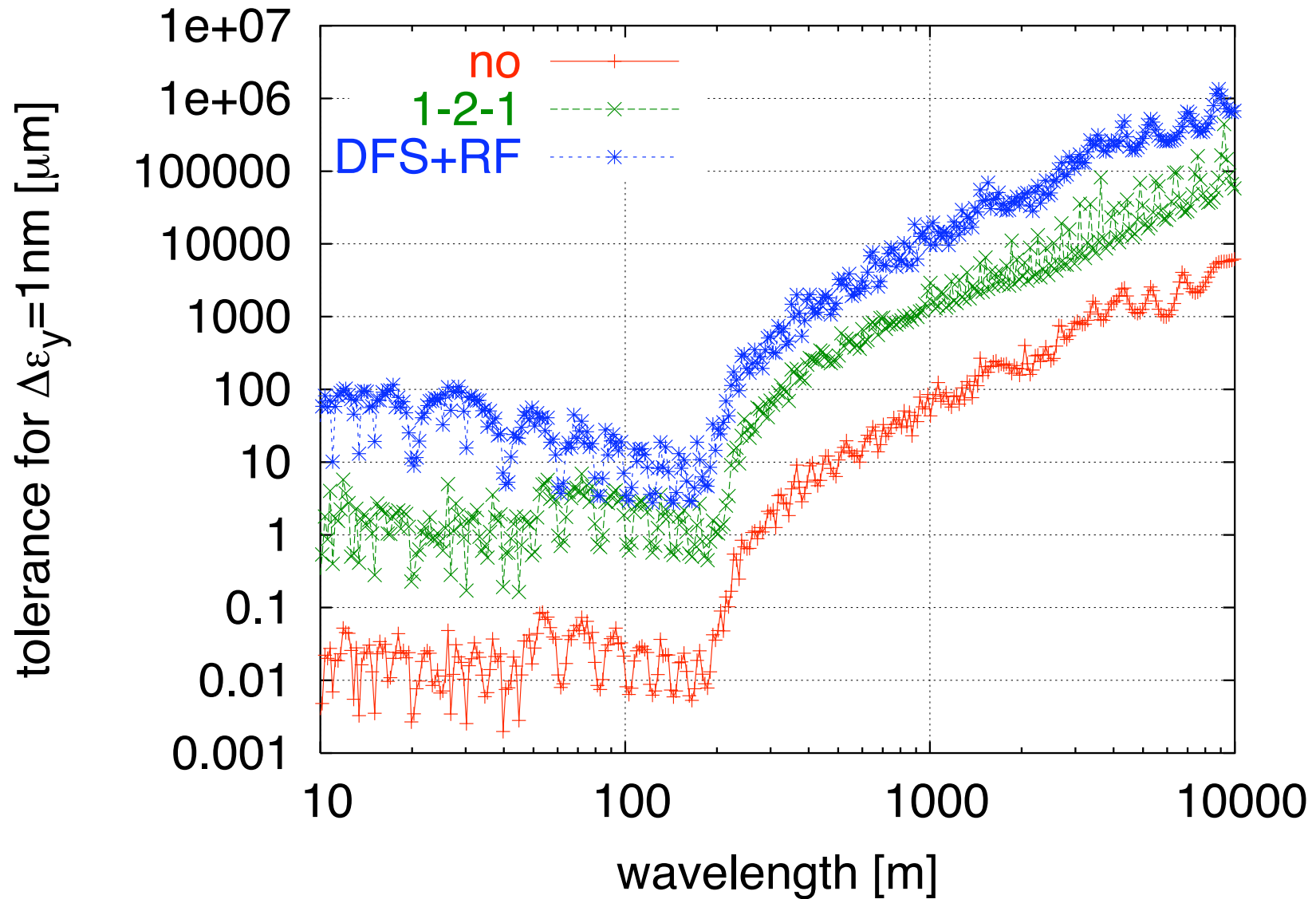

- Cosine-line misalignments, beta-functions clearly visible

# Structure Challenges

# Introduction

- You heard all about those, so just a short reminder
- Achieving the gradient is a challenge in both designs
- For ILC the  $Q$ -value is crucial
  - can only use structures with good value
  - some structure do not reach the gradient required
- In CLIC the breakdown rate is crucial
  - can kick the beam and prevent luminosity

# Super-conducting Cavity $Q_0$ -Values

- The  $Q_0$ -values of super-conducting cavities can strongly vary from one cavity to the next
  - material quality
- Challenge is to produce enough good cavities
  - fraction of good cavities is relevant for cost
- Too low  $Q_0$  means larger cooling power is required

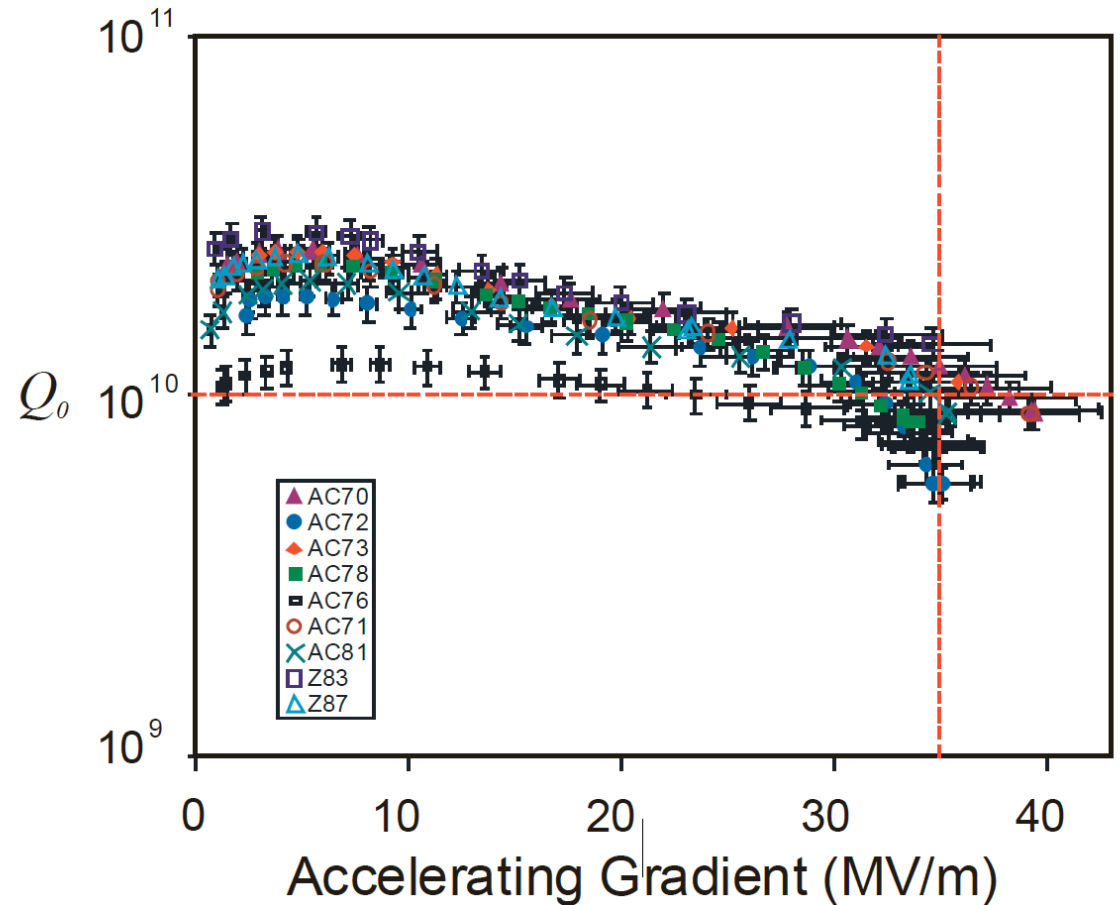

# Breakdown Rate (CLIC)

- Direct limit to breakdown rate
  - 1% luminosity loss budget
  - assuming that a pulse with breakdown leads to no luminosity
  - have  $7 \times 10^4$  structures per linac
- ⇒ breakdown rate  
 $0.01/14 \times 10^4 \approx 0.7 \times 10^{-7}$
- Assumed strategy is to switch off corresponding PETS and slowly go up to power again

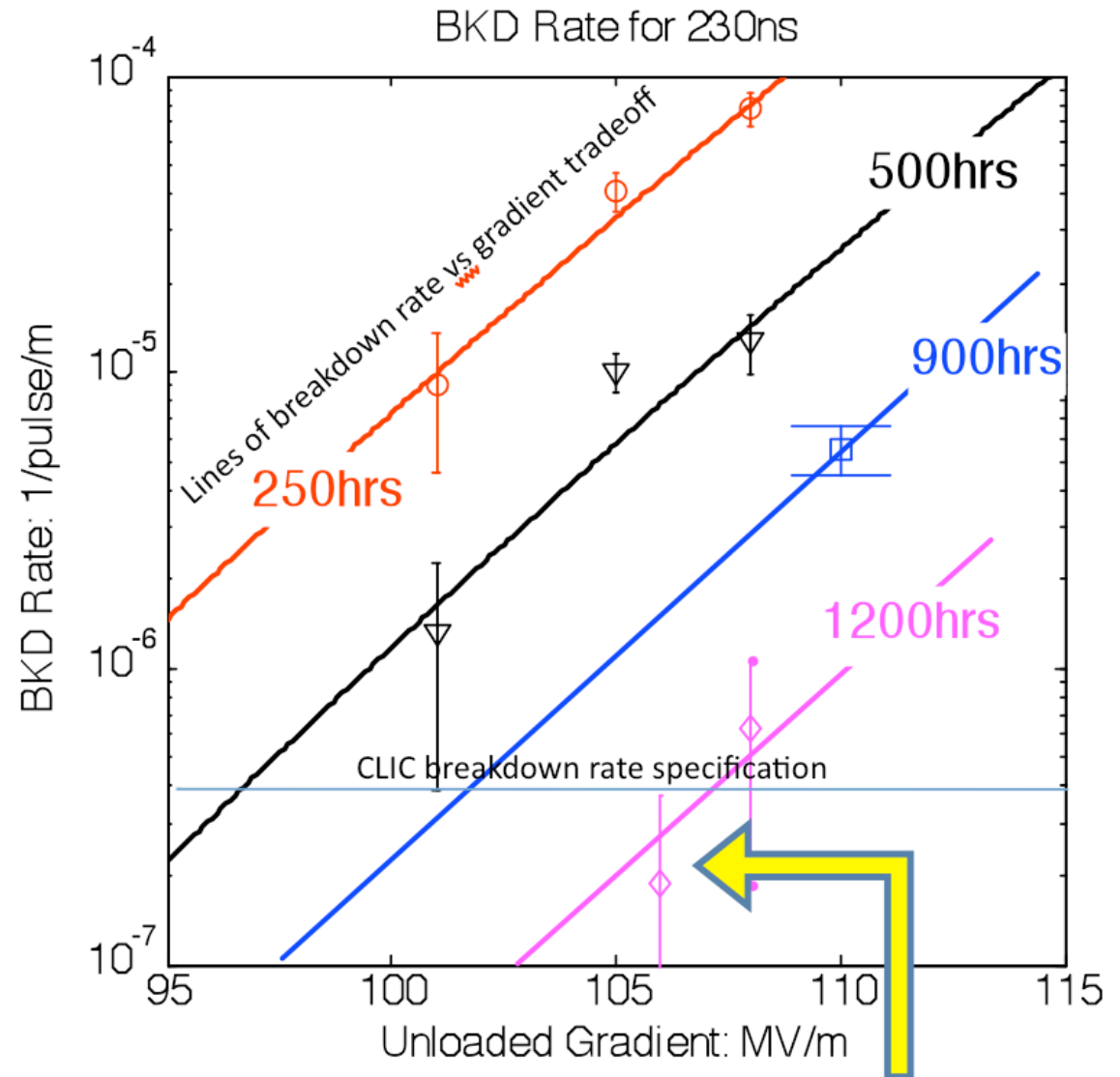



# Empirical RF Constraints

- To limit the breakdown rate and the severeness of the breakdowns
- The maximum surface field has to be limited

$$\hat{E} < 260 \text{ MV/m}$$

- The temperature rise at the surface needs to be limited

$$\Delta T < 56 \text{ T}$$

- The power flow needs to be limited
  - related to the badness of a breakdown

empirical parameter is

$$P/(2\pi a)\tau^{\frac{1}{3}} < 18 \frac{\text{MW}}{\text{mm}} \text{ns}^{\frac{1}{3}}$$

# Imperfections from the Structure (CLIC)

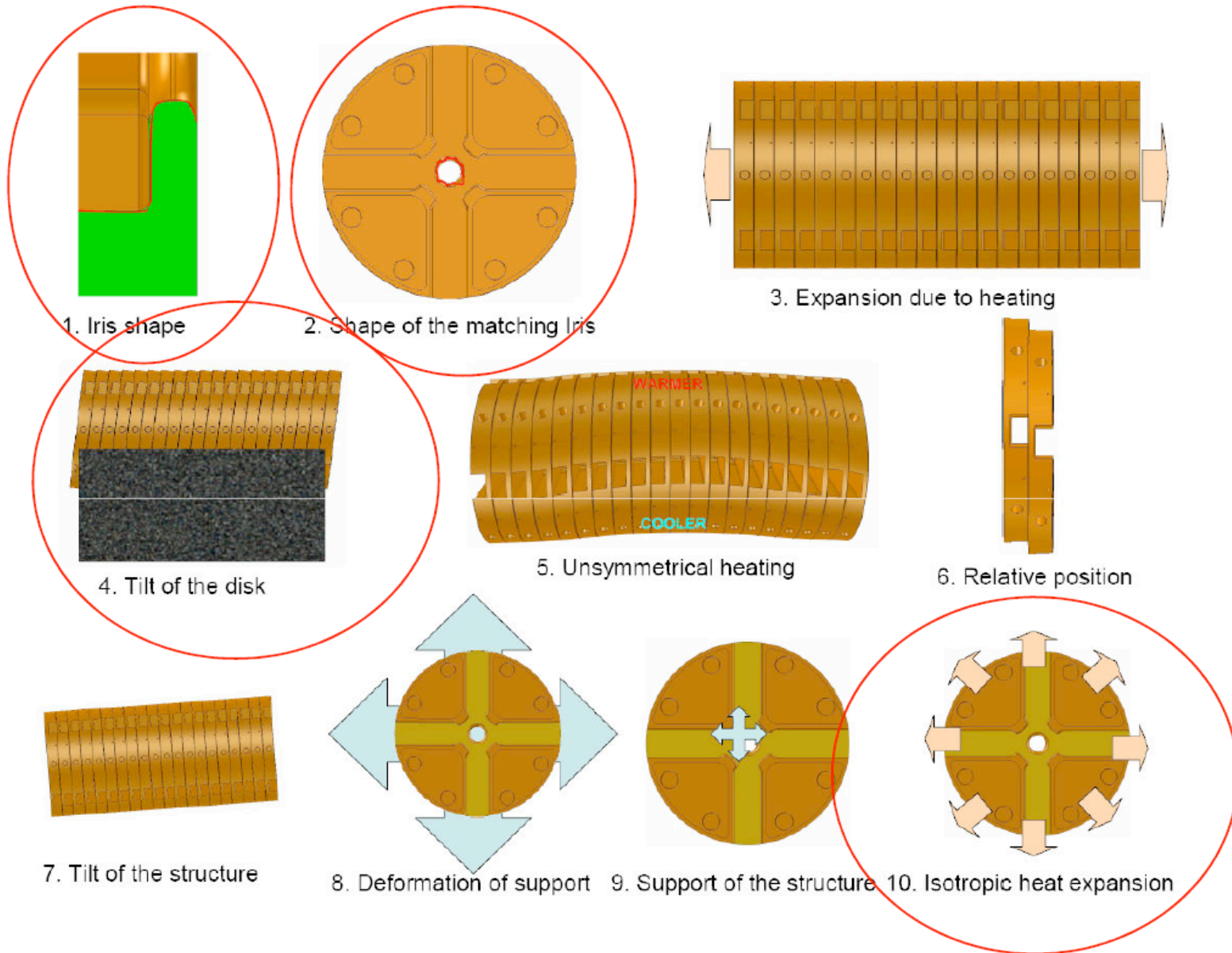

# Parameter Optimisation

A not so basic thing for linacs. . .

Done for CLIC only

# Luminosity

Simplified treatment and approximations used throughout

$$\mathcal{L} = H_D \frac{N^2 f_{rep} n_b}{4\pi \sigma_x \sigma_y}$$

$$\mathcal{L} \propto H_D \frac{N}{\sqrt{\beta_x \epsilon_x} \sqrt{\beta_y \epsilon_y}} \eta P$$

$$\epsilon_x = \epsilon_{x,DR} + \epsilon_{x,BC} + \epsilon_{x,BDS} + \dots$$

$$\epsilon_y = \epsilon_{y,DR} + \epsilon_{y,BC} + \epsilon_{y,linac} + \epsilon_{y,BDS} \\ + \epsilon_{y,growth} + \epsilon_{y,offset} \dots$$

$$\sigma_{x,y} \propto \sqrt{\beta_{x,y} \epsilon_{x,y} / \gamma}$$

$$N f_{rep} n_b \propto \eta P$$

typically  $\epsilon_x \gg \epsilon_y$ ,

$$\beta_x \gg \beta_y$$

Fundamental limitations from

- beam-beam:  $N / \sqrt{\beta_x \epsilon_x}$ ,  $N / \sqrt{\beta_x \epsilon_x \beta_y \epsilon_y}$
- emittance generation and preservation:  $\sqrt{\beta_x \epsilon_x}$ ,  $\sqrt{\beta_y \epsilon_y}$
- main linac RF:  $\eta$

# Potential Limitations

- Efficiency  $\eta$ :  
depends on beam current that can be transported  
Decrease bunch distance  $\Rightarrow$  long-range transverse wakefields in main linac  
Increase bunch charge  $\Rightarrow$  short-range transverse and longitudinal wakefields in main linac, other effects
- Horizontal beam size  $\sigma_x$   
beam-beam effects, final focus system, damping ring, bunch compressors
- vertical beam size  $\sigma_y$   
damping ring, main linac, beam delivery system, bunch compressor, need to collide beams, beam-beam effects
- Will try to show how to derive  $L_{bx}(f, a, \sigma_a, G)$

# Beam Size Limit at IP

- The vertical beam size had been  $\sigma_y = 1$  nm (BDS)  
 $\Rightarrow$  challenging enough, so keep it  $\Rightarrow \epsilon_y = 10$  nm
- Fundamental limit on horizontal beam size arises from beamstrahlung  
 Two regimes exist depending on beamstrahlung parameter

$$\Upsilon = \frac{2\hbar\omega_c}{3E_0} \propto \frac{N\gamma}{(\sigma_x + \sigma_y)\sigma_z}$$

$\Upsilon \ll 1$ : classical regime,  $\Upsilon \gg 1$ : quantum regime

At high energy and high luminosity  $\Upsilon \gg 1$

$$\mathcal{L} \propto \Upsilon\sigma_z/\gamma P\eta$$

$\Rightarrow$  partial suppression of beamstrahlung

$\Rightarrow$  coherent pair production

In CLIC  $\langle \Upsilon \rangle \approx 6$ ,  $N_{coh} \approx 0.1N$

$\Rightarrow$  somewhat in quantum regime

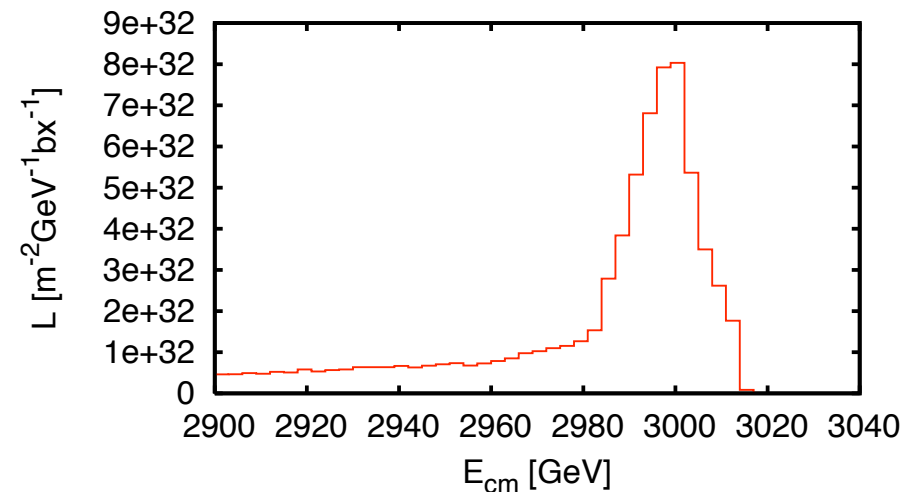
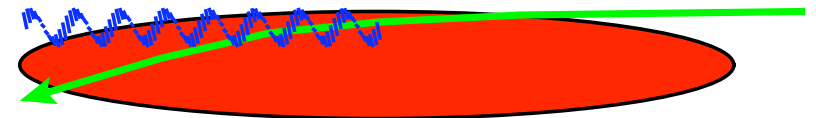

$\Rightarrow$  Use luminosity in peak as figure of merit

# Luminosity Optimisation at IP

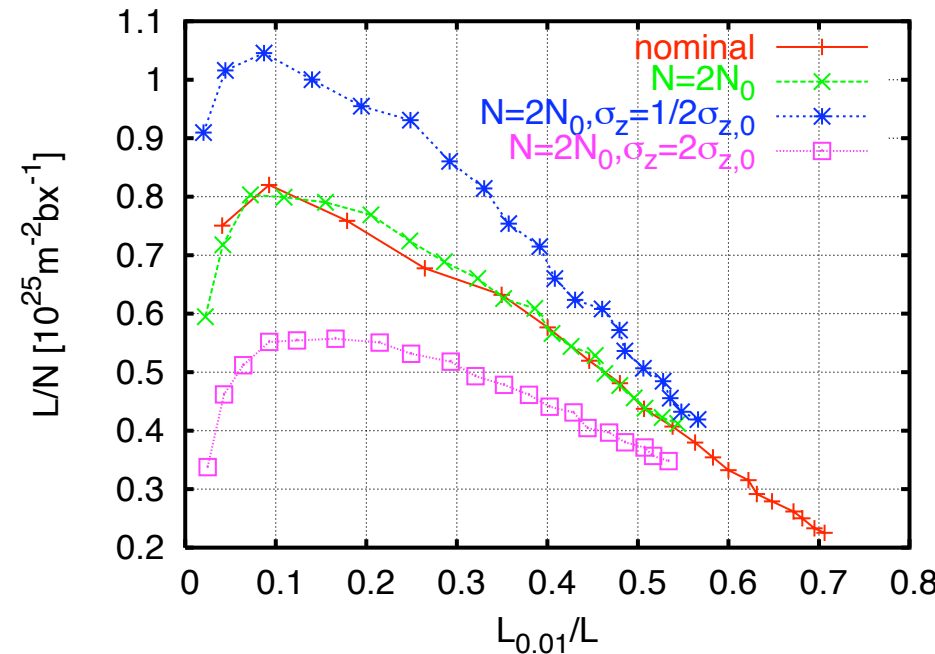
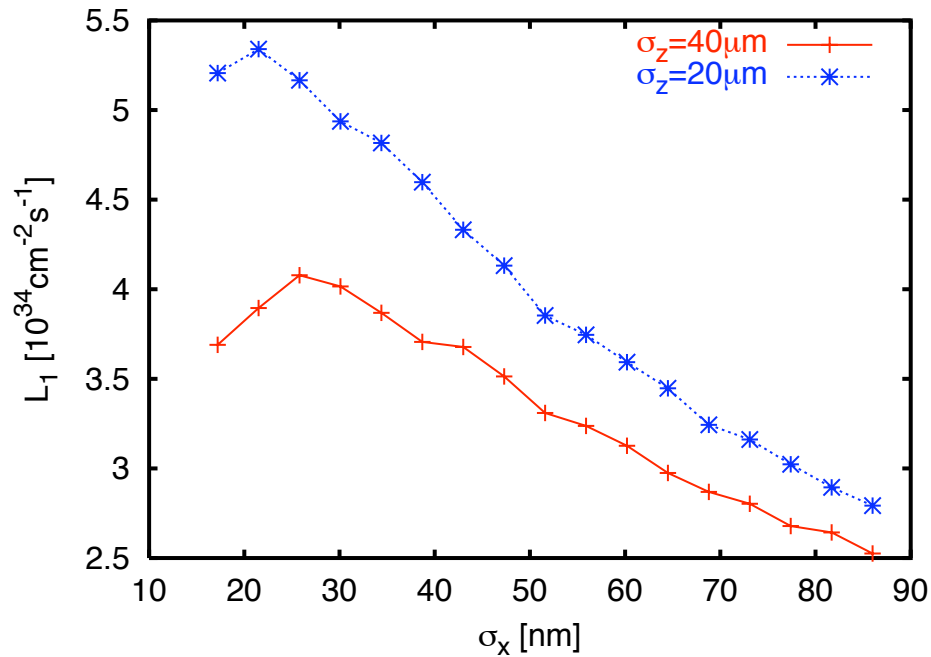

Total luminosity for  $\Upsilon \gg 1$

$$\mathcal{L} \propto \frac{N}{\sigma_x \sigma_y} \eta \propto \frac{n_\gamma^{3/2}}{\sqrt{\sigma_z}} \frac{\eta}{\sigma_y}$$

large  $n_\gamma \Rightarrow$  higher  $\mathcal{L} \Rightarrow$  degraded spectrum

chose  $n_\gamma$ , e.g. maximum  $L_{0.01}$  or  $L_{0.01}/L = 0.4$  or ...

$$\mathcal{L}_{0.01} \propto \frac{\eta}{\sqrt{\sigma_z} \sigma_y}$$

# Other Beam Size Limitations

- Final focus system squeezes beams to small sizes with main problems:
    - beam has energy spread (RMS of  $\approx 0.35\%$ )  $\Rightarrow$  avoid chromaticity
    - synchrotron radiation in bends  $\Rightarrow$  use weak bends  $\Rightarrow$  long system
    - radiation in final doublet (Oide Effect)
  - Large  $\beta_{x,y} \Rightarrow$  large nominal beam size
  - Small  $\beta_{x,y} \Rightarrow$  large distortions
  - Beam-beam simulation of nominal case: effective  $\sigma_x \approx 40$  nm,  $\sigma_y \approx 1$  nm
- $\Rightarrow$  lower limit of  $\sigma_x \Rightarrow$  for small  $N$  optimum  $n_\gamma$  cannot be reached
- new FFS reaches  $\sigma_x \approx 40$  nm,  $\sigma_y \approx 1$  nm
- Assume that the transverse emittances remain the same
    - not strictly true
    - emittance depends on charge in damping ring (e.g.  $\epsilon_x(N = 2 \times 10^9) = 450$  nm,  $\epsilon_x(N = 4 \times 10^9) = 550$  nm)



# Work Flow

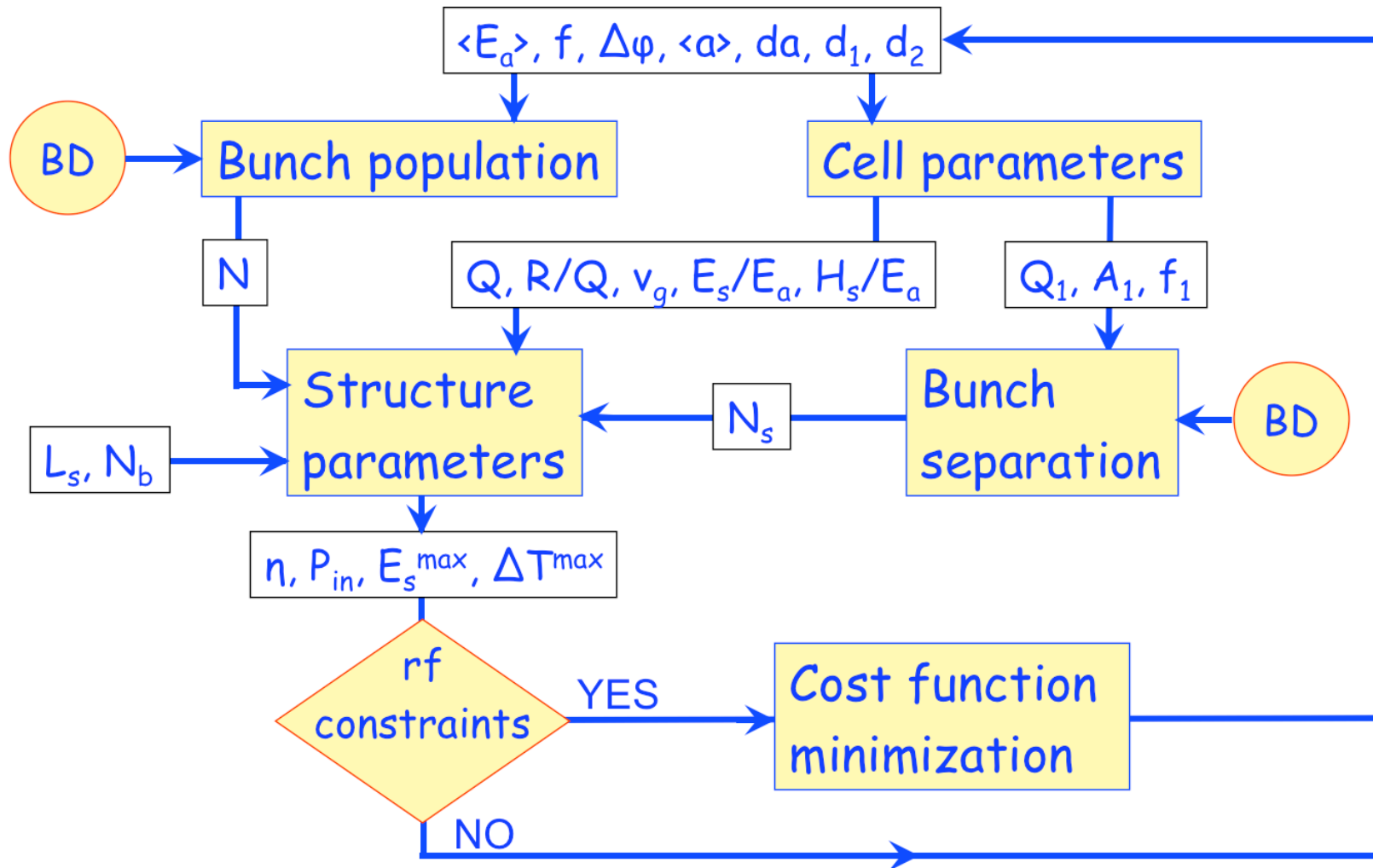

# Beam Dynamics Work Flow

- Optimisation keeping the main linac beam dynamics tolerances at the original level
  - do not change the lattice
- Minimum spot size at IP is dominated by BDS and damping ring
  - adjust  $N/\sigma_x$  for large bunch charges to respect beam-beam limit
- For each of the different values of  $f$  and  $a/\lambda$  find  $\sigma_z(N)$ 
  - respecting final RMS energy spread to be  $\sigma_E/E = 0.35\%$  and running  $12^\circ$  off-crest
  - chose  $N$  such that  $2NW_\perp(\sigma_z(N))$  is acceptable (i.e. old value)

# Results

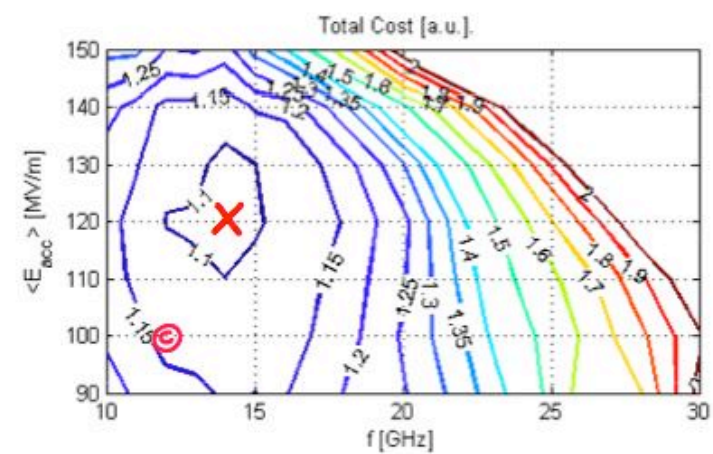
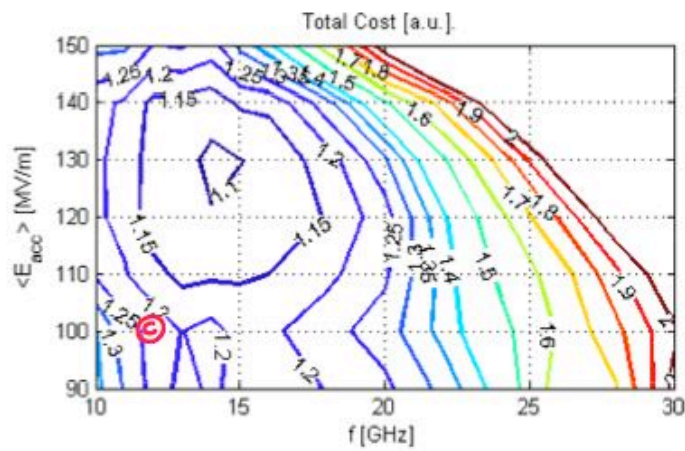
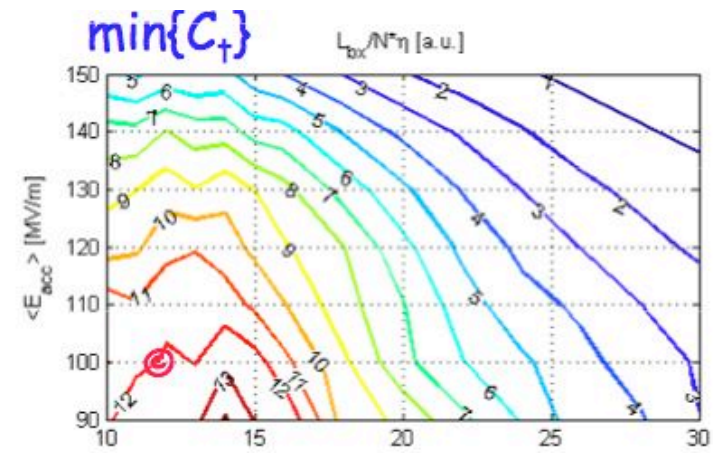
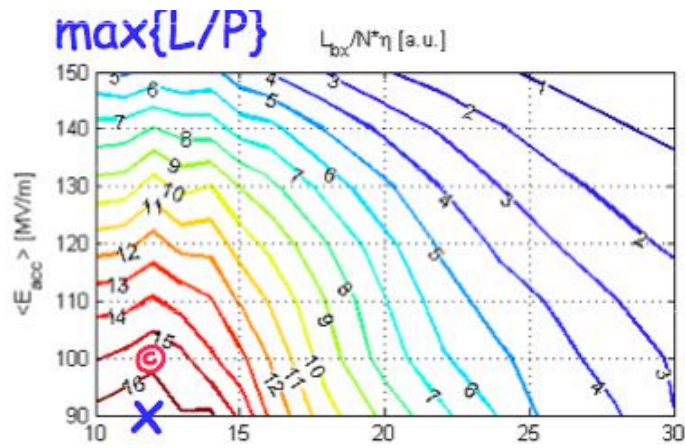

## Results 2

$$\text{FoM} = L_{bx}/N \cdot n$$

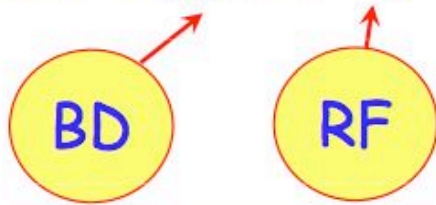

BD optimum aperture:  
 $\langle a \rangle = 2.6 \text{ mm}$

**Why X-band ?**  
 Crossing gives optimum frequency

RF optimum aperture:  
 $\langle a \rangle / \lambda = 0.1 \div 0.12$

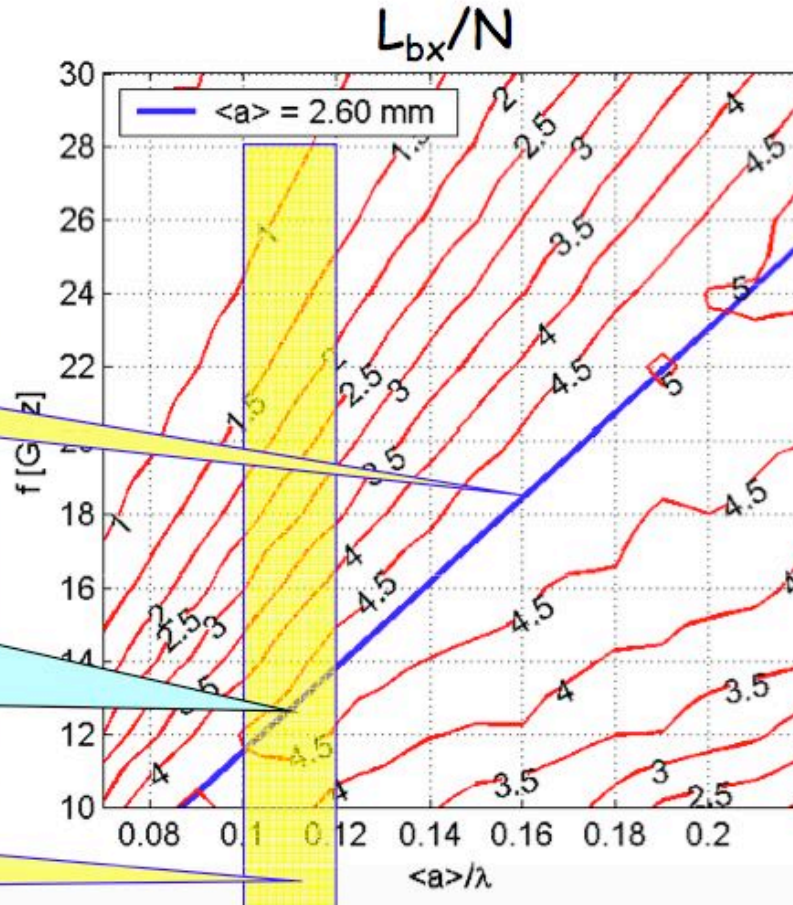

# Energy and Phase Stability

# Requirements

- The final energy needs to be accurately known for physics
  - measurement
- The final energy needs to be stable for physics
  - large energy variations would also cause luminosity loss due to limited BDS bandwidth
  - need to control final energy
- The emittance needs to be preserved in presence of static imperfections
  - differences between the actual and the assumed lattice can cause emittance growth
  - need to control energy profile
- The emittance needs to be preserved in presence dynamic imperfections
  - the energy profile needs to be stable
  - kicks due to cavity tilts need to be controlled
- Beam timing errors lead to luminosity loss
  - need to control bunch compressor RF stability

# Main Linac RF Noise Sources (ILC)

- Lorentz force detuning
  - systematic from pulse to pulse
  - is largely corrected using piezo tuners in feed-forward
- Microphonics
  - unpredictable
  - corrected by klystron-based (or piezo-based) feedback
- Klystron amplitude and phase jitter
  - corrected by klystron based feedback
- Beam current variation
  - measure beam current at damping ring and use feed-forward for klystrons
- Feedback noise
  - measurement noise
  - feedback amplifies at some frequencies
- Jitter of timing reference
  - impacts feedback systems

# Low Level RF Controls

- The low level RF control ties the RF phase to a timing reference and adjusts the gradient
- For each cavity one measures
  - field amplitude and phase
  - input power
  - reflected power
- As correctors are used
  - piezo tuners in each cavity
  - stepping motors
  - klystron amplitude and phase
- One needs a beam timing feedback
- The klystron-based feedback acts on the vector sum of all cavity gradients in a unit
- The sensors are calibrated measuring the field with and without beam
  - the field induced by the beam can be calculated
- Input and reflected power per cavity is measured
- Beam current is measured at damping ring and used for feed-forward



# Final Energy Static Error

- We can expect systematic errors in the acceleration along the main linac
  - coherent calibration errors of amplitude and phase measurement in all RF units
  - random calibration errors of amplitude and phase in each RF unit
- The beam energy will be measured with the spectrometer and the detector
  - very high precision ( $10^{-4}$ , actually it will be precisely the “relevant energy”)
  - can remove coherent calibration errors
- We are left with random calibration errors
  - ⇒ they can cause emittance growth
- Typical parameters are accuracies of 1% and  $1^\circ$ 
  - ⇒ should specify that this is acceptable (some work has been already done)
    - for 1.5% random acceleration error per unit, DFS still works
  - ⇒ should identify our limit

# Final Energy Stability

- This is fundamental physics requirement
  - ⇒ has to be achieved by the control system
  - ⇒ let us try to see if this is the tightest tolerance
- Aim for 0.07% energy stability (RDR)
  - but for four error sources, should be reviewed
- Tolerance for coherent errors along main linac are
  - $\sigma_\phi \approx 0.4^\circ$
  - $\sigma_G = 0.07\%$
- Tolerance for independent errors per RF unit along main linac are about 16-times larger
  - $\sigma_\phi = 5.6^\circ$
  - $\sigma_G = 1\%$
- Phase tolerances depend on average RF phase used
- We would expect to have better stability but let us check if we do need it
- Check requirement of single cavity

# CLIC RF Jitter Tolerance

- CLIC has similar limits for energy jitter than ILC
  - also luminosity loss is a concern
- Life is a bit more difficult since one drive beam complex powers the main linac
  - phase jitter coherent along each decelerator
  - component is coherent along the whole main linac
- Drive beam is produced at 1 GHz
  - ⇒ relative phase jitter is amplified by factor 12
- Mitigation strategy is to
  - stabilise drive beam accelerator current and RF
  - correct the phase at final turn-around

# CLIC Layout

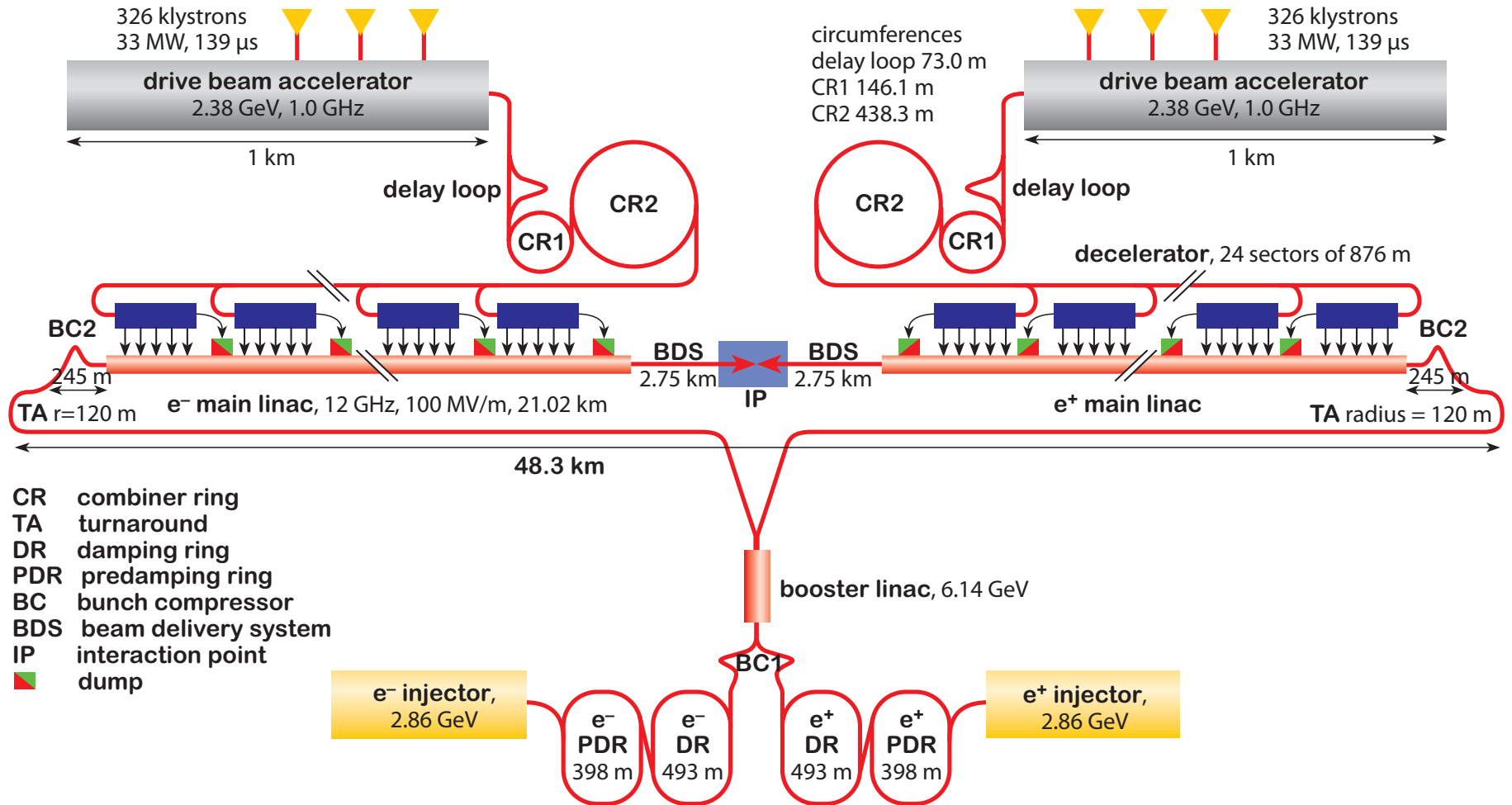

# Feed-forward at Final Turn-Around

- Final feed-forward shown
  - ultima ratio
    - requires timing reference (FP6)
    - phase measurement/prediction (FP7)
    - tuning chicane (FP7, PSI)
- Measure phase and change of phase at BC1
- Adjust BC2 with kicker to compensate error
- One could also measure phase and energy at BC1
- Missing will be kicker and amplifier

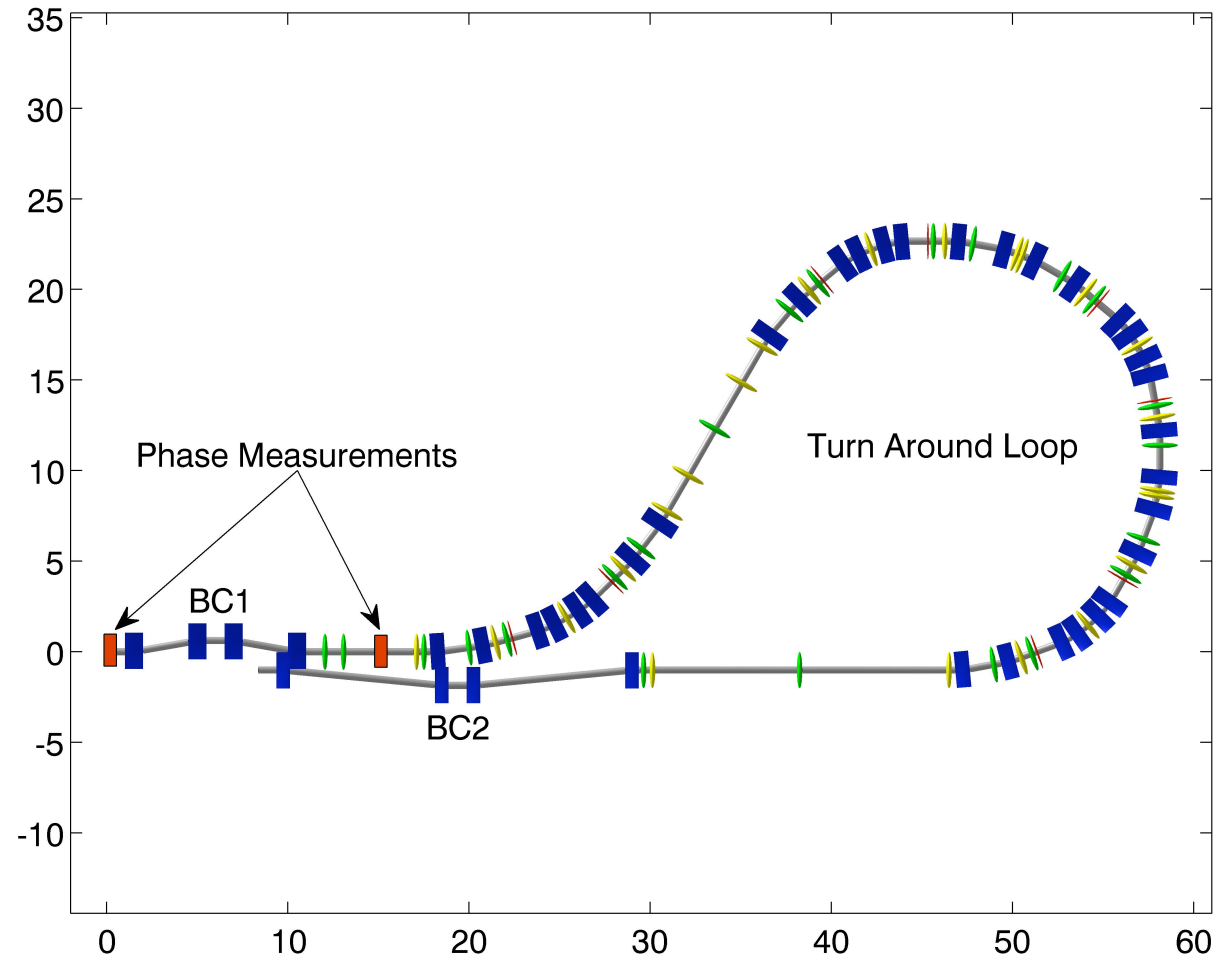

# RF Power Generation

# Klystron

- Usually the input RF power for the accelerating structures is provided by klystrons
- In ILC klystrons are used to directly power the main beam
- In CLIC they power the drive beam accelerator
  - would be difficult in main linac
- Klystrons tend to be more efficient at low frequencies and long pulses
  - perfect for ILC (1.3 GHz, 1.5 ms) and the CLIC drive beam accelerator (1 GHz and 140  $\mu$ s)

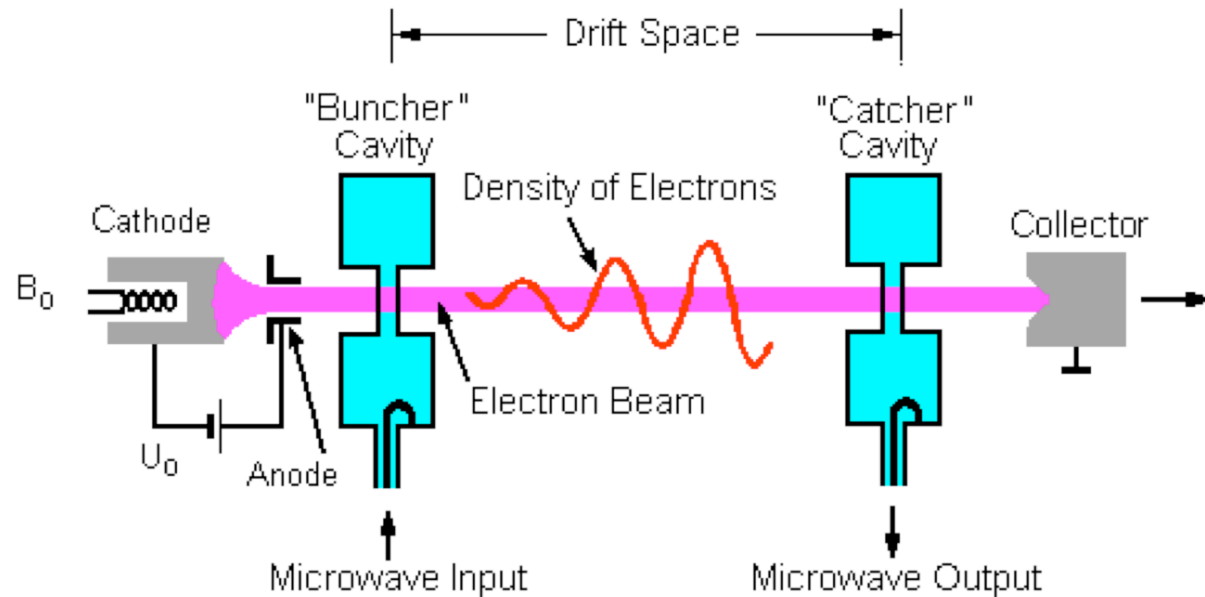

# Drive Beam (CLIC)

- In CLIC power is produced by a high current drive beam (100A)
  - decelerated in a low impedance structure
- Beam loading is used for acceleration

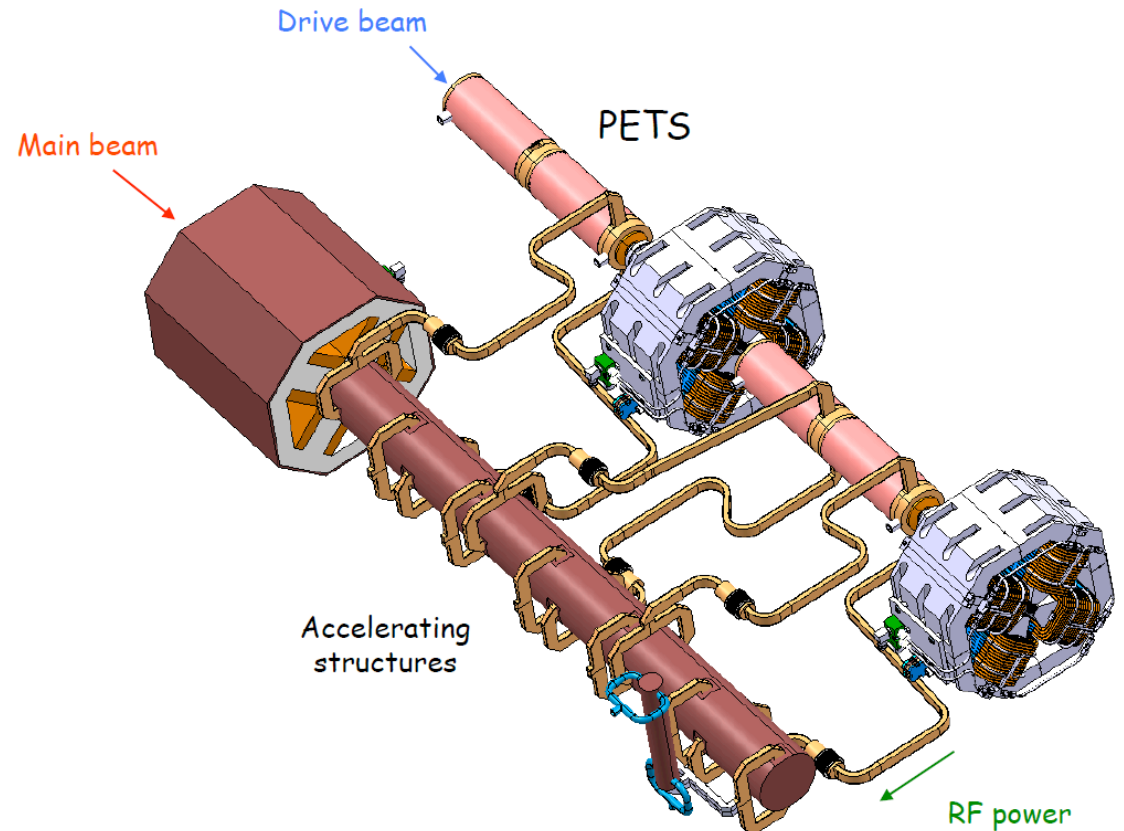



# PETS

Assembly of the eight PETS bars.

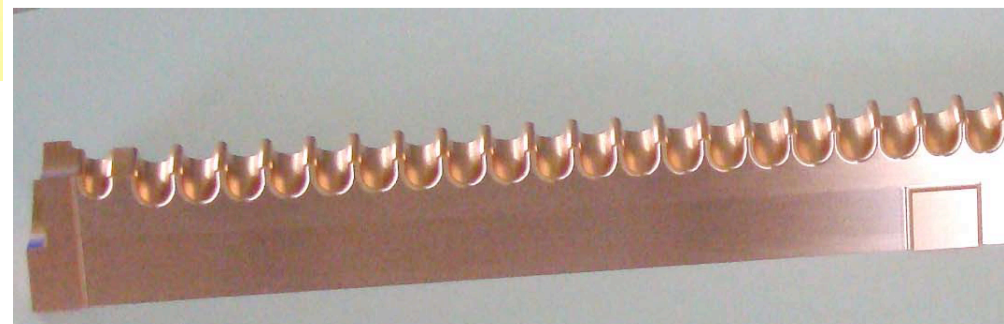
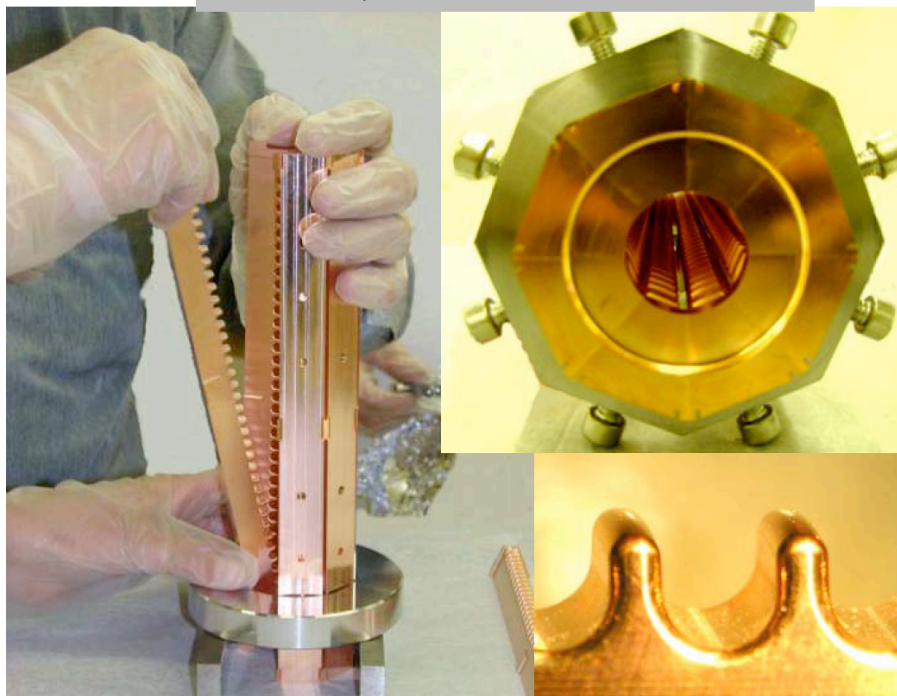

# Drive Beam Accelerator

- High current at low gradient allows high efficiency

$$\frac{P'_{beam}}{P'_{wall}} = \frac{R'I}{G}$$

- Acceleration at low frequency is efficient
  - $Q$  is high  $Q \propto 1/\omega$
  - klystrons are efficient
- In CLIC  $\eta \approx 97.5\%$  expected

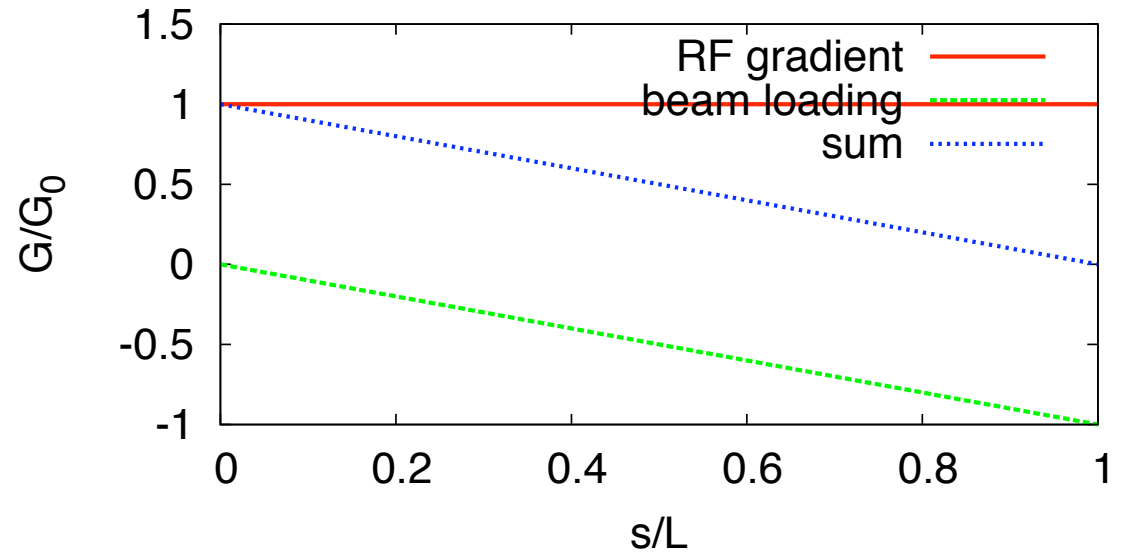

- Structure needs to be long enough not to have power leaking out

# Thanks



- Many thanks to you for listening and to the people who helped me to prepare this lecture
  - with advice
  - with plots

Erik Adli, Alexej Grudiev, Erk Jensen, Jochem Snuverink, Igor Syrathev, Rolf Wegner, Walter Wuensch, Riccardo Zennaro, Frank Zimmermann