

A 3D CAD model of a particle accelerator component, likely a beam pipe or undulator section. The model is rendered in a light gray color against a dark blue background. It features several cylindrical sections connected by curved transitions. A coordinate system is visible in the top right corner, with axes labeled x, y, and z. The z-axis is vertical, the x-axis is horizontal, and the y-axis is diagonal. A red dot is located at the origin of the coordinate system.

ILC CFS AD&I Daresbury Lab

Summary

J.Osborne / V.Kuchler / A.Enomoto

CFS AD&I MEETING AGENDA		<u>Revised August, 31, 2009</u>		
Daresbury Laboratory, UK				
September 3-4, 2009				
		September 3, 2009	September 4, 2009	
Regional Meeting Times	Topic	Area System Representatives	Topic	Area System Representatives
0100-0215 SLAC 0300-0415 FNAL	0900-1015 DL, UK 1700-1815 KEK	General Introduction	In-House Participants	Damping Ring S. Giuducci
0215-0230 SLAC 0415-0430 FNAL	1015-1030 DL, UK 1815-1830 KEK	Break		Break
0230-0400 SLAC 0430-0600 FNAL	1030-1200 DL, UK 1830-2000 KEK	e+ Source	J. Clarke N. Collomb	Beam Delivery System D. Angal-Kalinin
0400-0500 SLAC 0600-0700 FNAL	1200-1300 DL, UK 2000-2100 KEK	Lunch		Lunch
0500-0630 SLAC 0700-0830 FNAL	1300-1430 DL, UK 2100-2230 KEK	RTML	N. Solyak	General Review In-House Participants
0630-0700 SLAC 0830-0900 FNAL	1430-1500 DL, UK 2230-2300 KEK	Break		Break
0700-0800 SLAC 0900-1000 FNAL	1500-1600 DL, UK 2300-2400 KEK	e- Source	A. Brachman J. Shepard	Main Linacs C. Adophsen
0800-0900 SLAC 1000-1100 FNAL	1600-1700 DL, UK 0000-0100 KEK	Overview with E. Paterson	E. Paterson	Overview with E. Paterson E. Paterson

Material will be posted on Indico :

<http://ilcagenda.linearcollider.org/conferenceDisplay.py?confId=4146>

e- MAIN LINAC

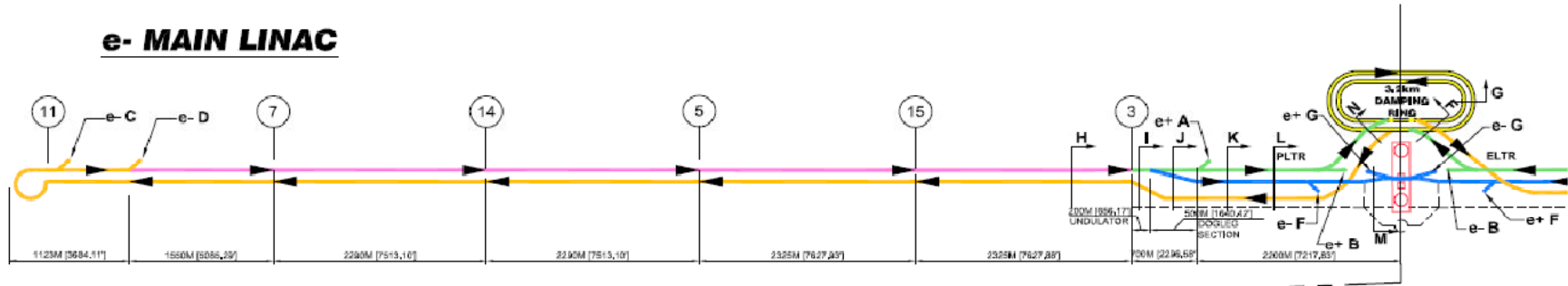

e+ MAIN LINAC

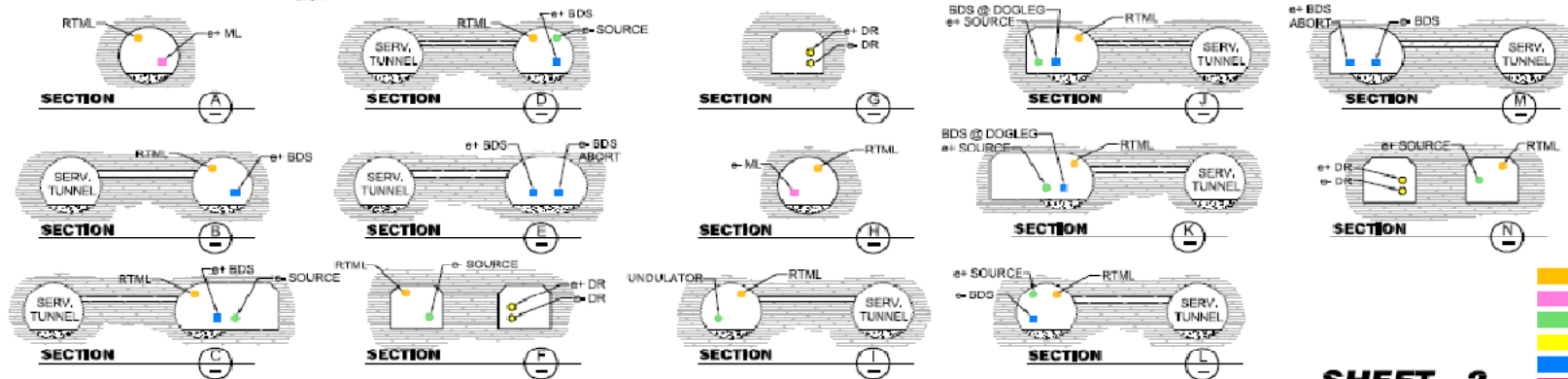
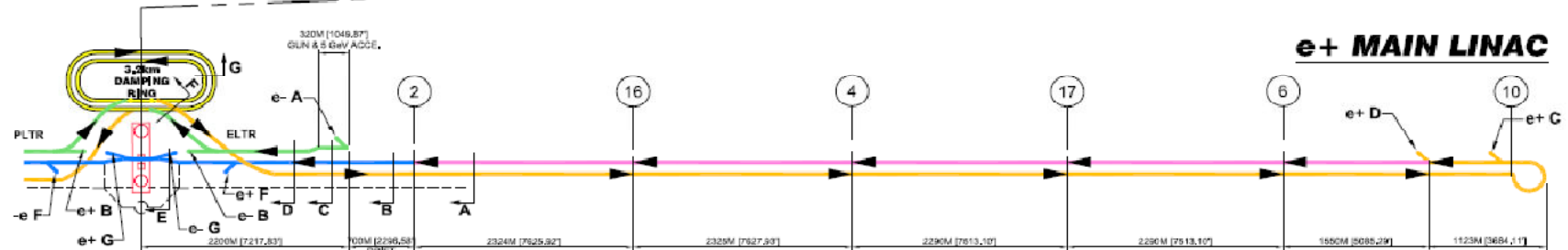

- LEGEND**
- RTML
 - ML
 - SOURCES
 - DR
 - BDS
 - DETECTOR AREA
 - SERVICE TUNNEL
 - BEAM DIRECTION

SHEET - 2
Draft 8 28 09

e- MAIN LINAC

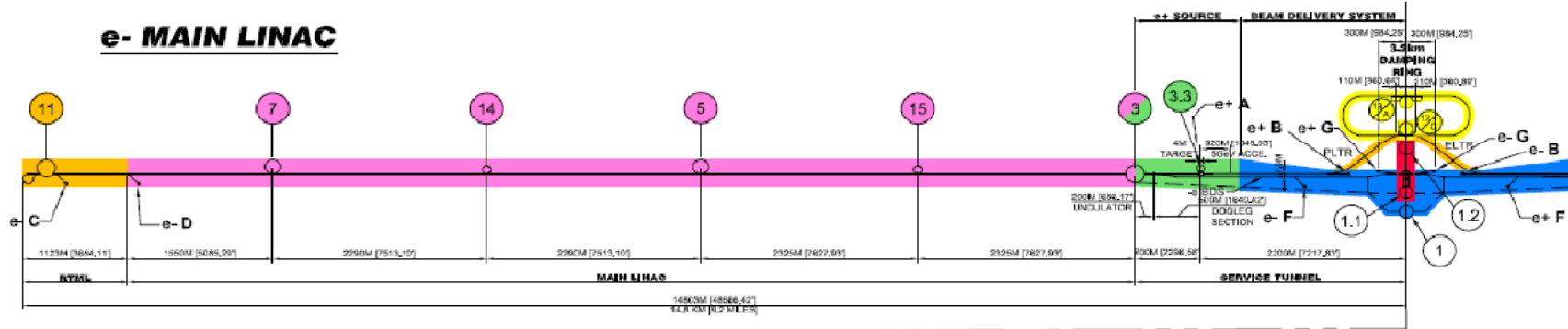

e+ MAIN LINAC

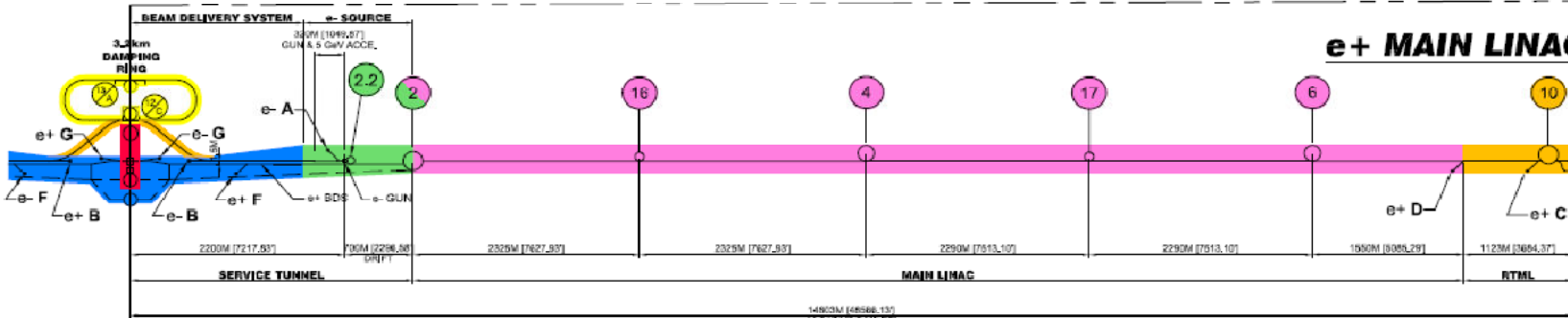

SITE / TUNNEL LENGTHS (M)

e- SIDE ML + RTML	e+ SIDE ML + RTML	B.D.S./SOURCES SERVICE/FTRL/PTRL	DAMPING RING	TOTAL
13233	13233	5800 + 5800 + 600	3238	41904

TUNNELS

AREA	e- INJECT. BDS & SERVICE	D.R.	R.T.M.L. BEAM	MAIN LINAC BEAM	e+ INJECT. BDS & SERVICE
w/dth M	8.0 + 5.2	4.5	5.2	5.2	8.0 + 5.2

SHAFT BASE CAVERNS

POINT	2, 3, 4, 5, 6, 7, 10, 11	14, 15, 16, 17
(L x W x H)m	52 x 10 x 5.3	3 x 3 x SHAFT

SHAFTS

POINT	1.0	1.1	1.2	2	2.2	3	3.3	4	5	6	7	10	11	12/C	13/A	14	15	16	17
Ø M	9	16	16	14	4	14	4	14	14	Ø	Ø	14	14	Ø	Ø	3	3	3	3

DETECTORS HALL

POINT	1.1, 1.2	1.0
(L x W x H)m	120 x 25 x 3.0	40 x 15 x 15

MUON WALL WIDENINGS

POINT	BDS e-G & e+G
(L x W x H)m	25 x 7 x 6 +15 x 7 x 6

LEGEND

- RTML
- ML
- SOURCES
- DR
- BDS
- DETECTOR AREA

SOURCES CAVERNS

POINT	e+ SOURCE
(L x W x H)m	40 x 40 x 8

DAMPING RING

POINT	12/C	13/A
(L x W x H)m	10 x 10 x 5	74 x 10 x 5

BEAM ABORT CAVERNS ()

POINT	SOURCES e-A & e+A	RTML e-C, e-D, e+C & e+D	BDS e-B, e-F, e-G, e+B, e-F & e+G
(L x W x H)m		5 x 4 x 4	20 x 9 x 15 +1 STORY

BEAM ABORT SERVICE HALLS ()

POINT	BDS e-B, e-G, e+B & e+G
(L x W x H)m	30 x 20 x 10

SHEET - 1
Draft 8 28 09

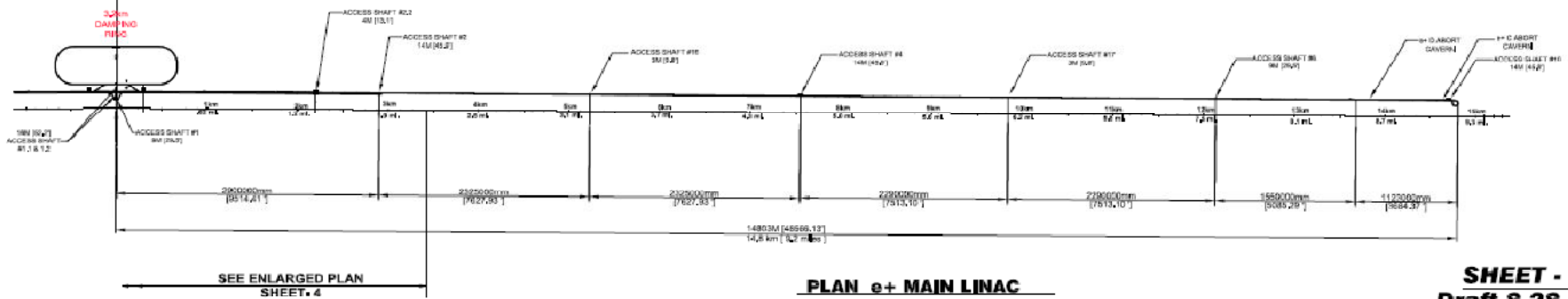
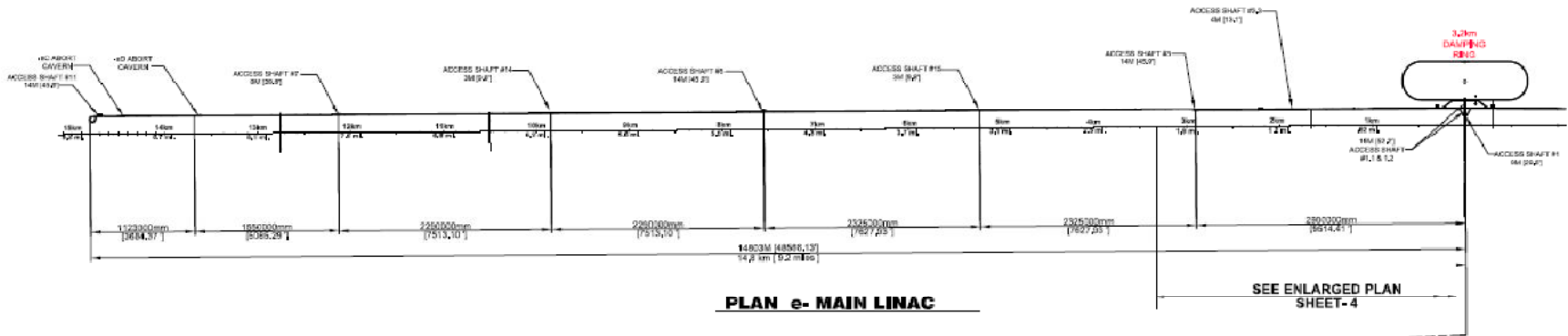

SHEET - 3
Draft 8 28 09

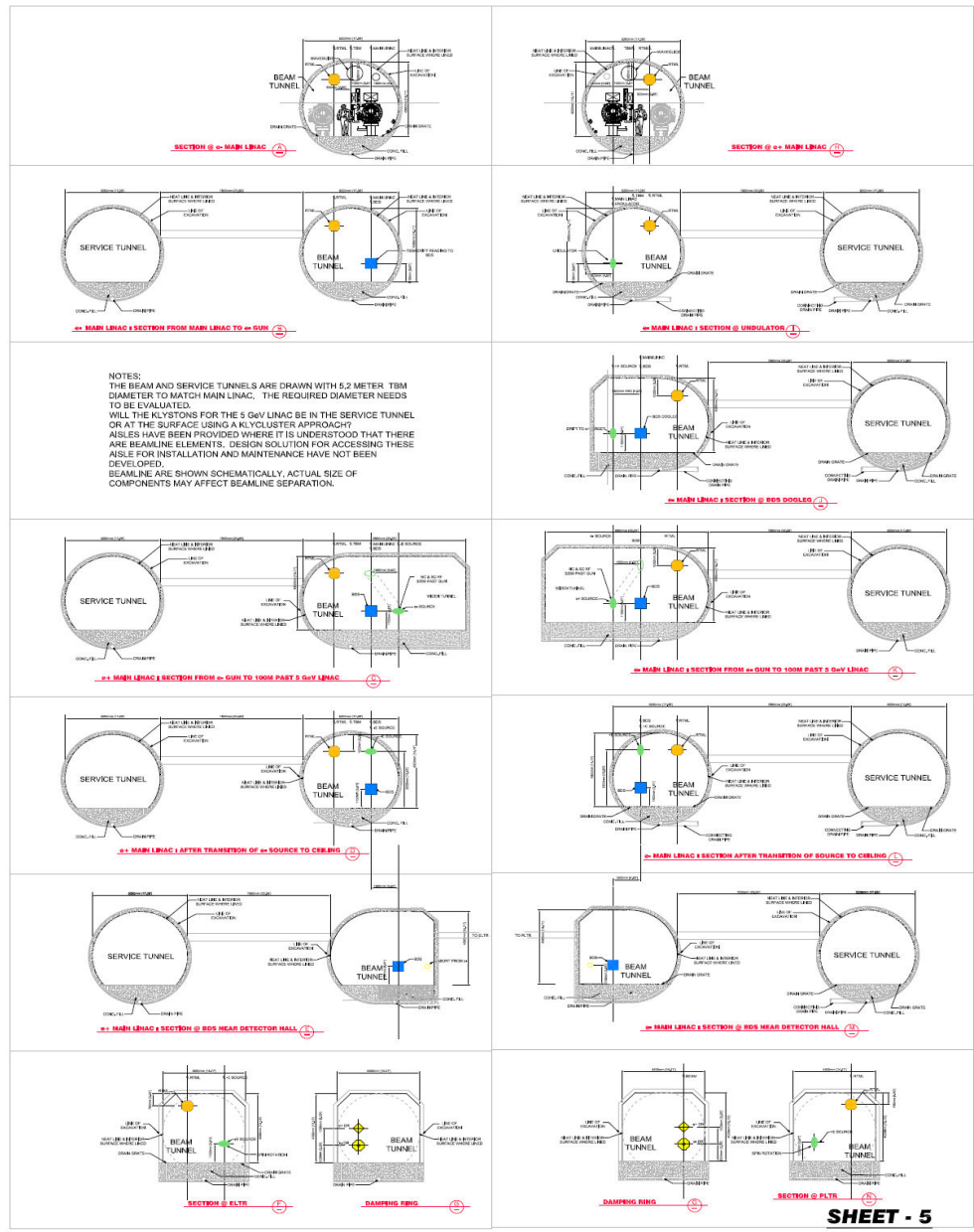

3.2km long 'racetrack' damping ring

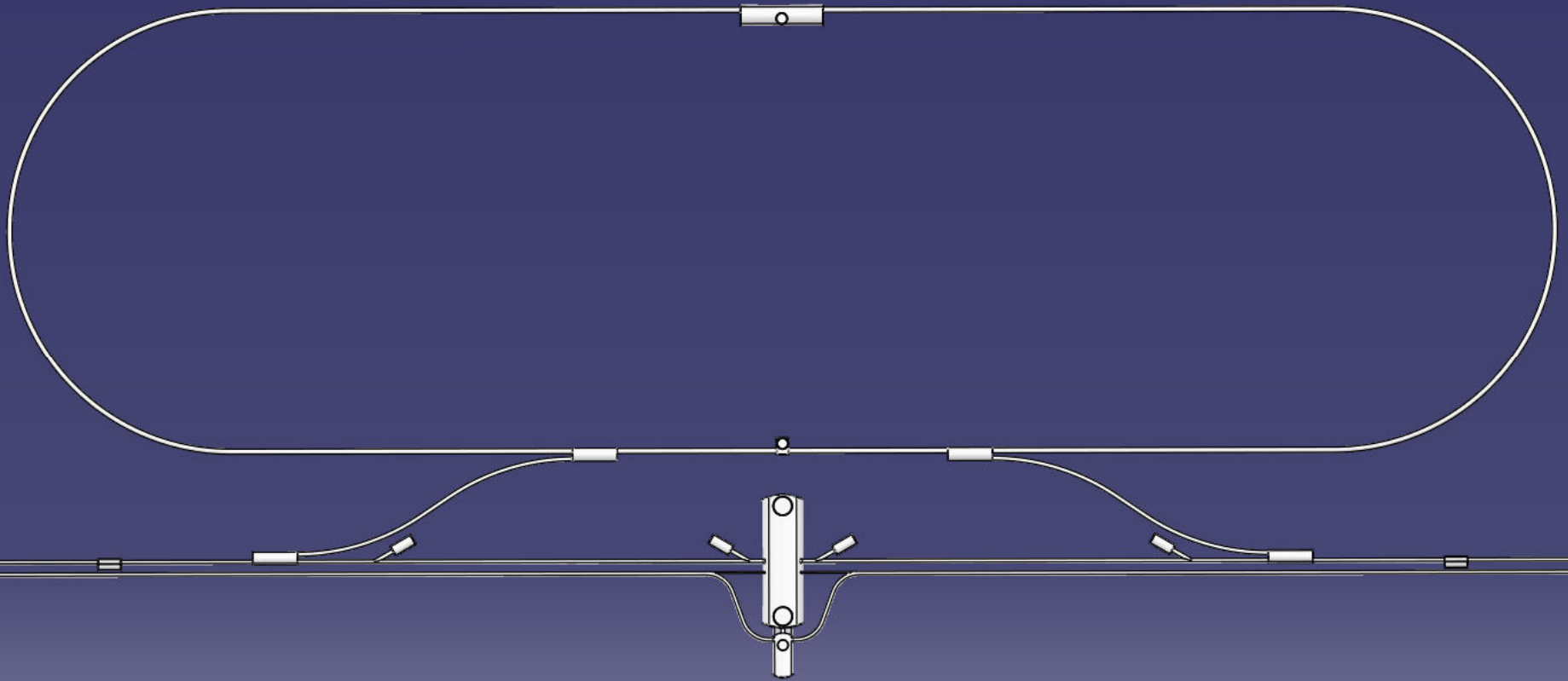
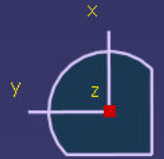

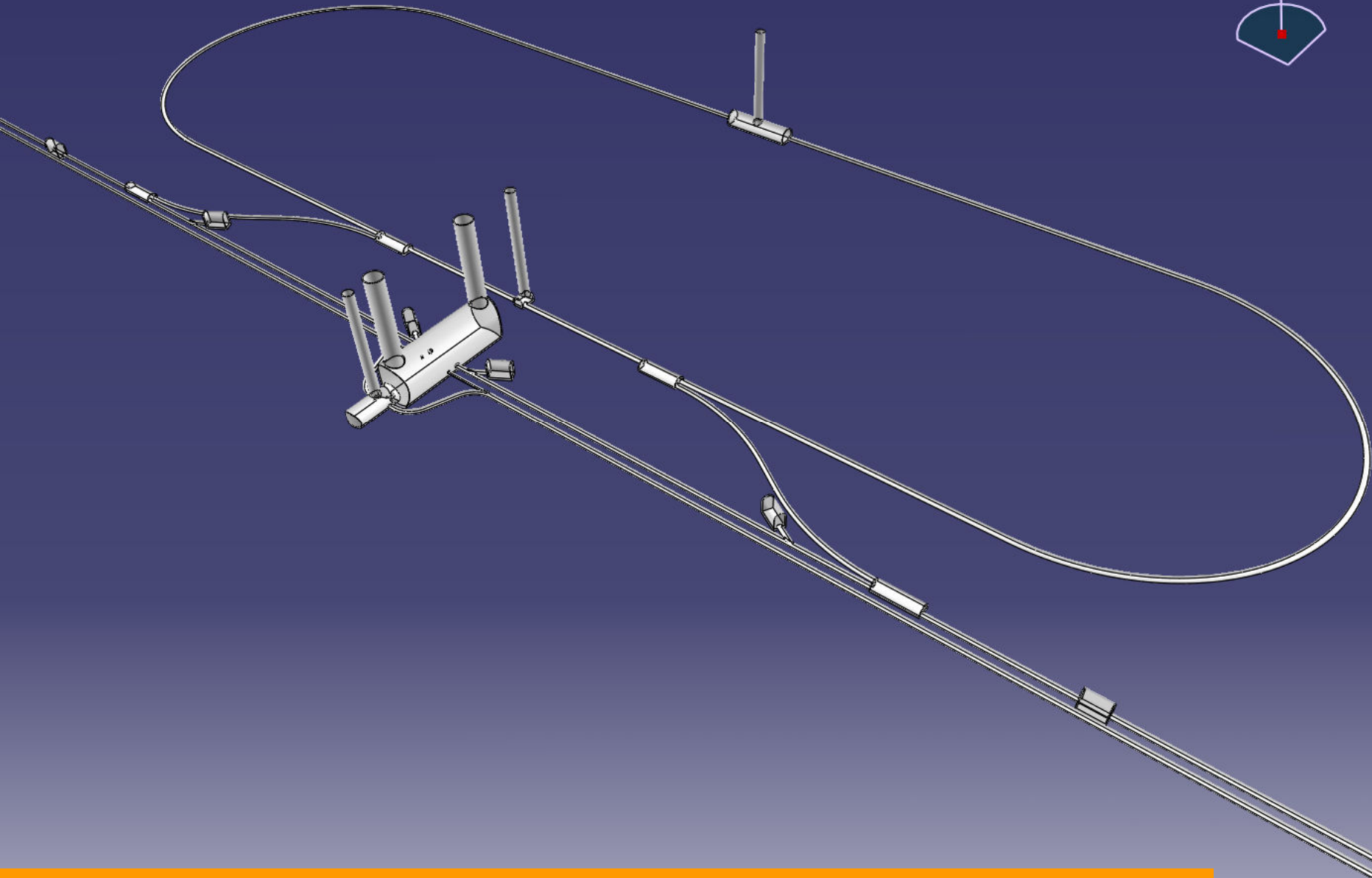
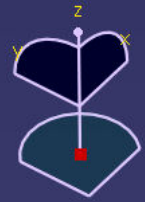

Beam dumps have been added (all cavern dimensions to be reviewed)



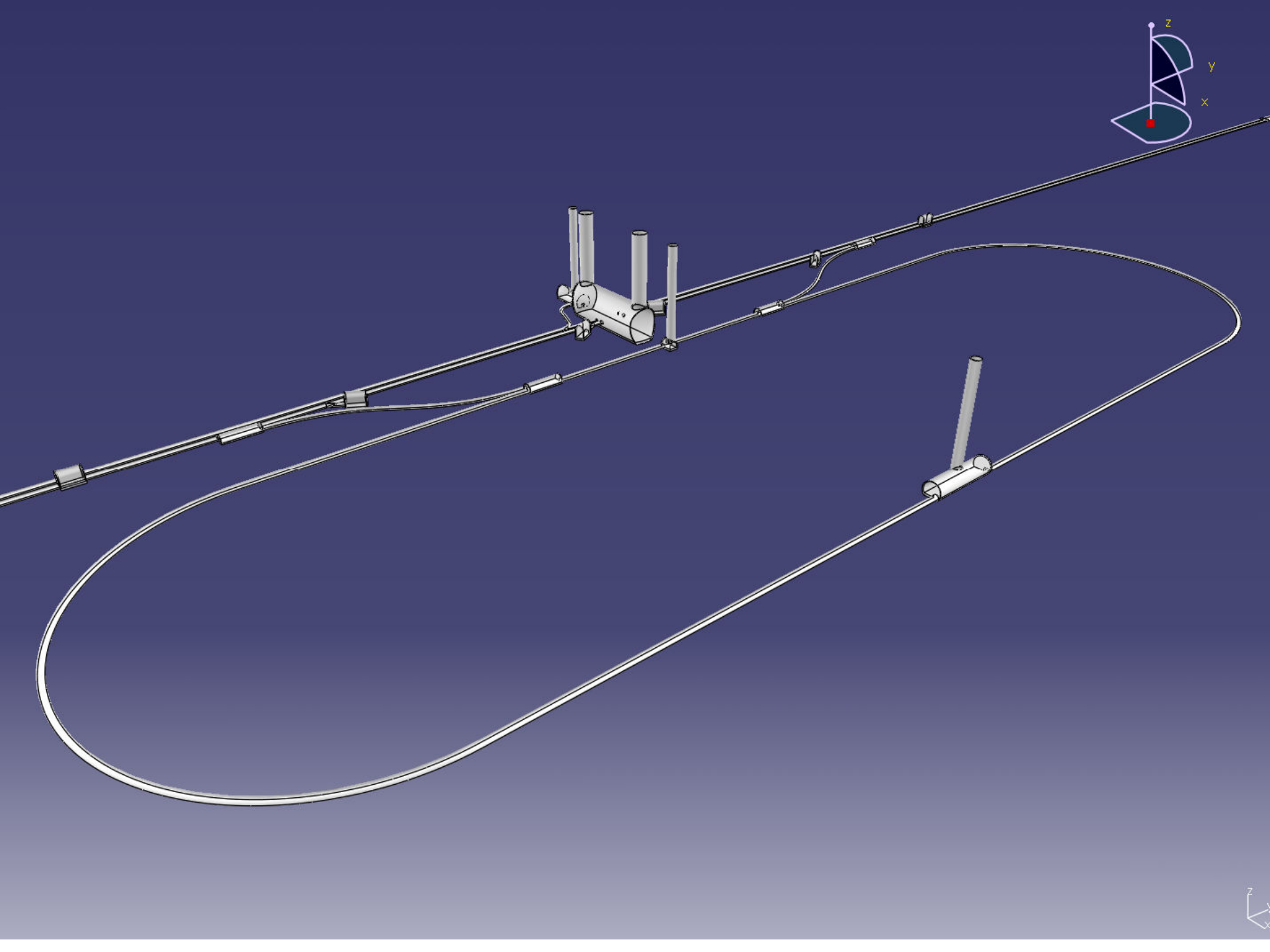

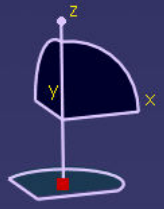
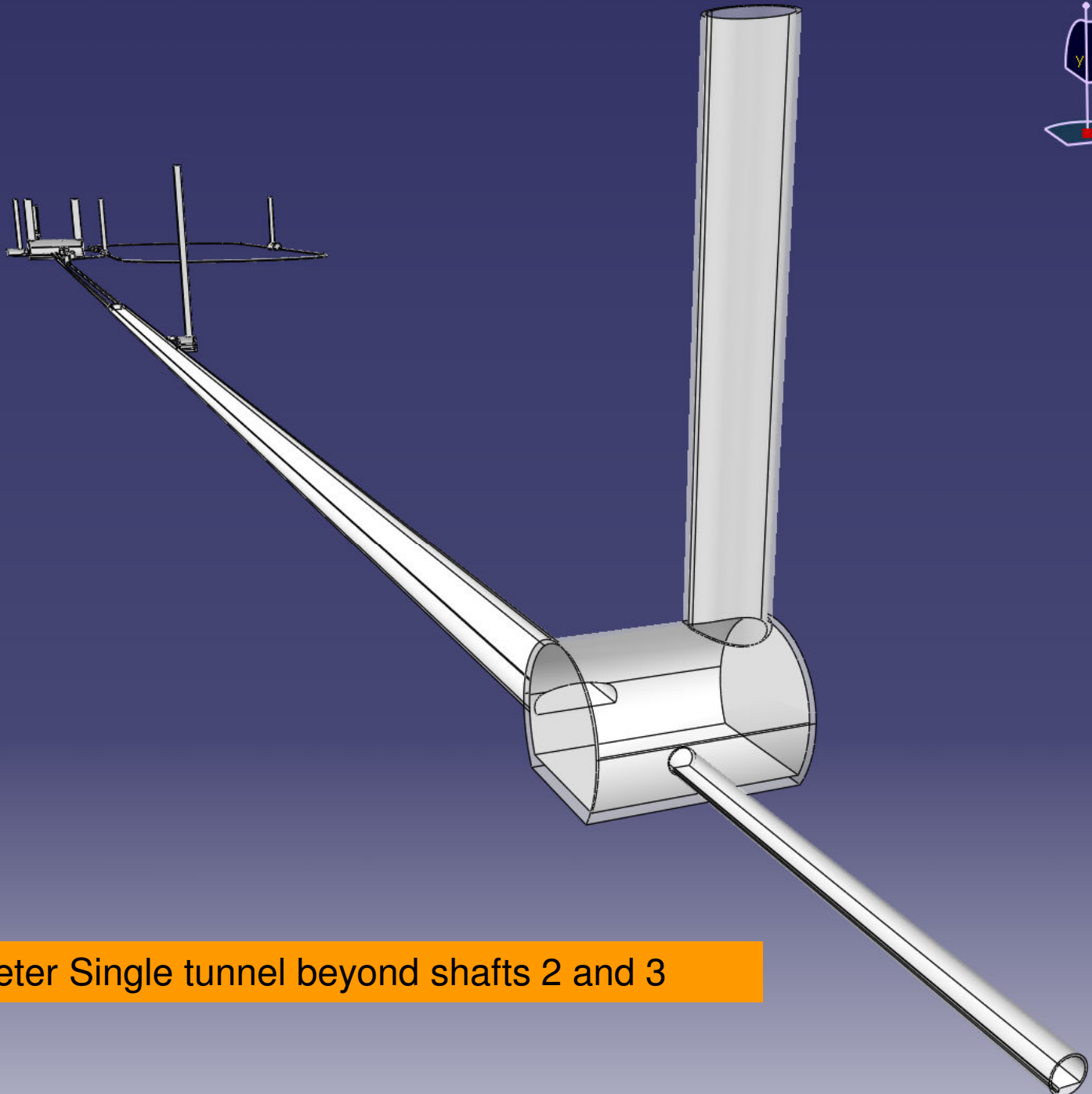

5.2m diameter Single tunnel beyond shafts 2 and 3



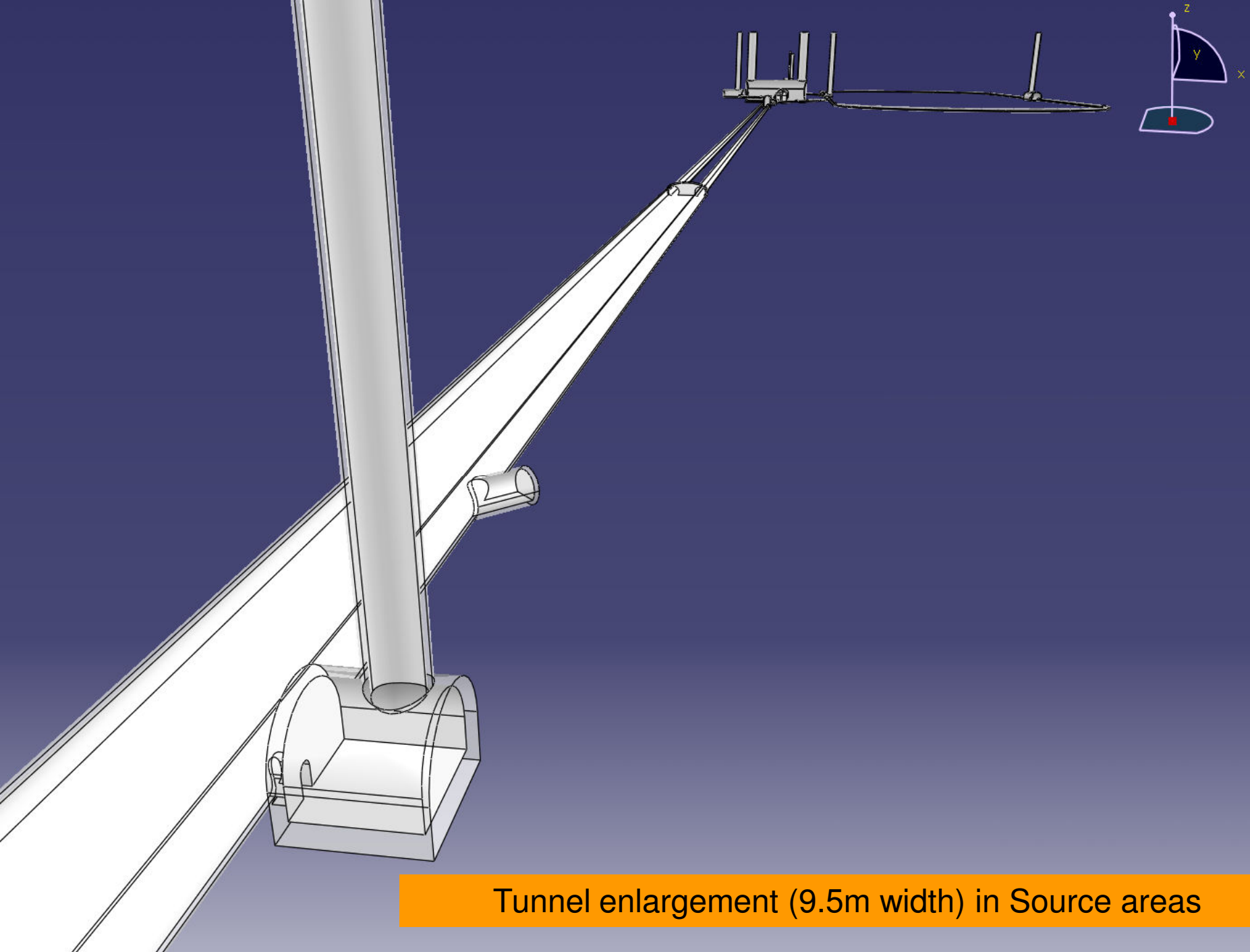

Tunnel enlargement (9.5m width) in Source areas

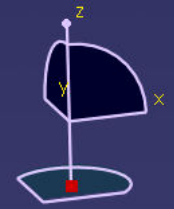
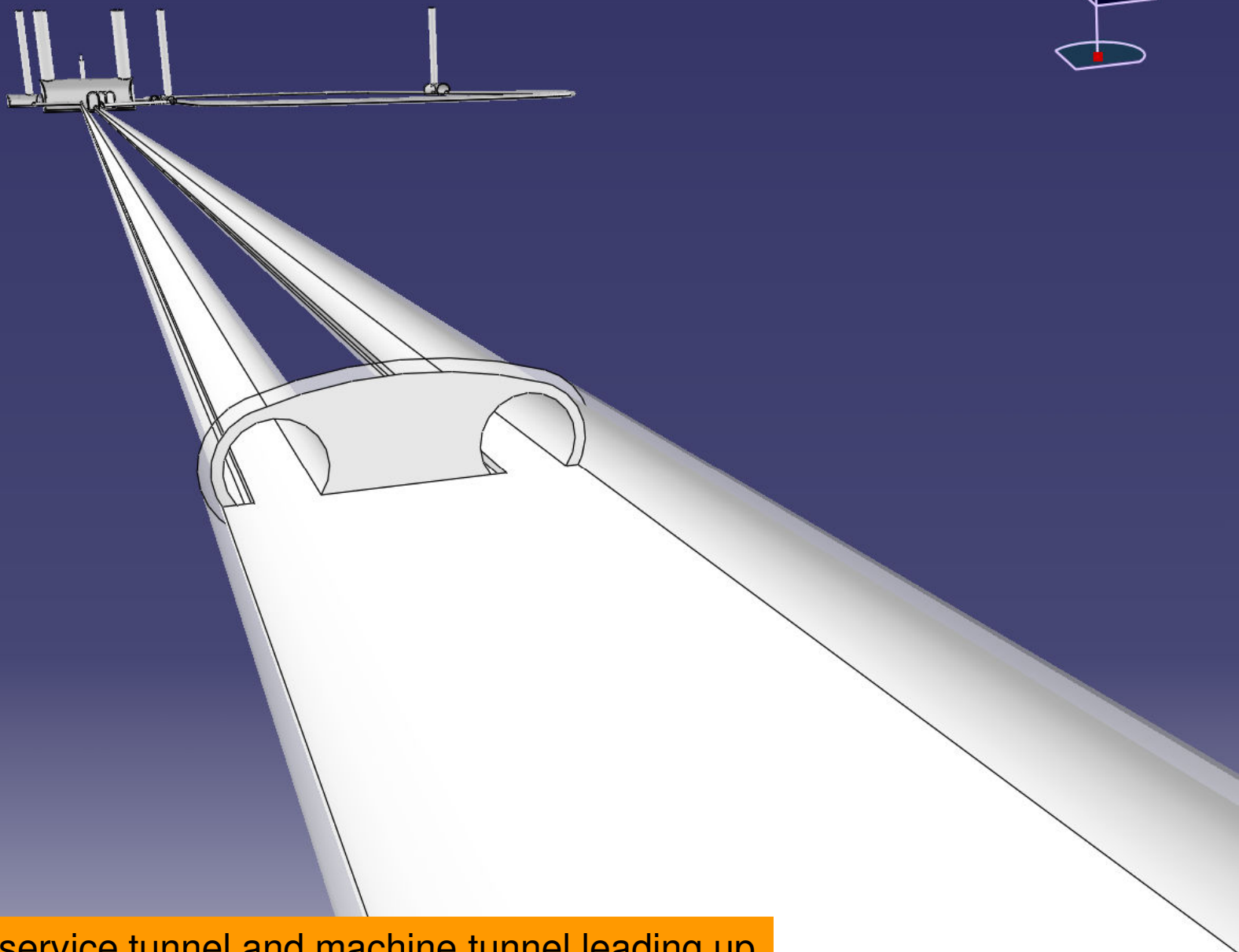

5.2m diameter service tunnel and machine tunnel leading up to experimental area

Interaction Region

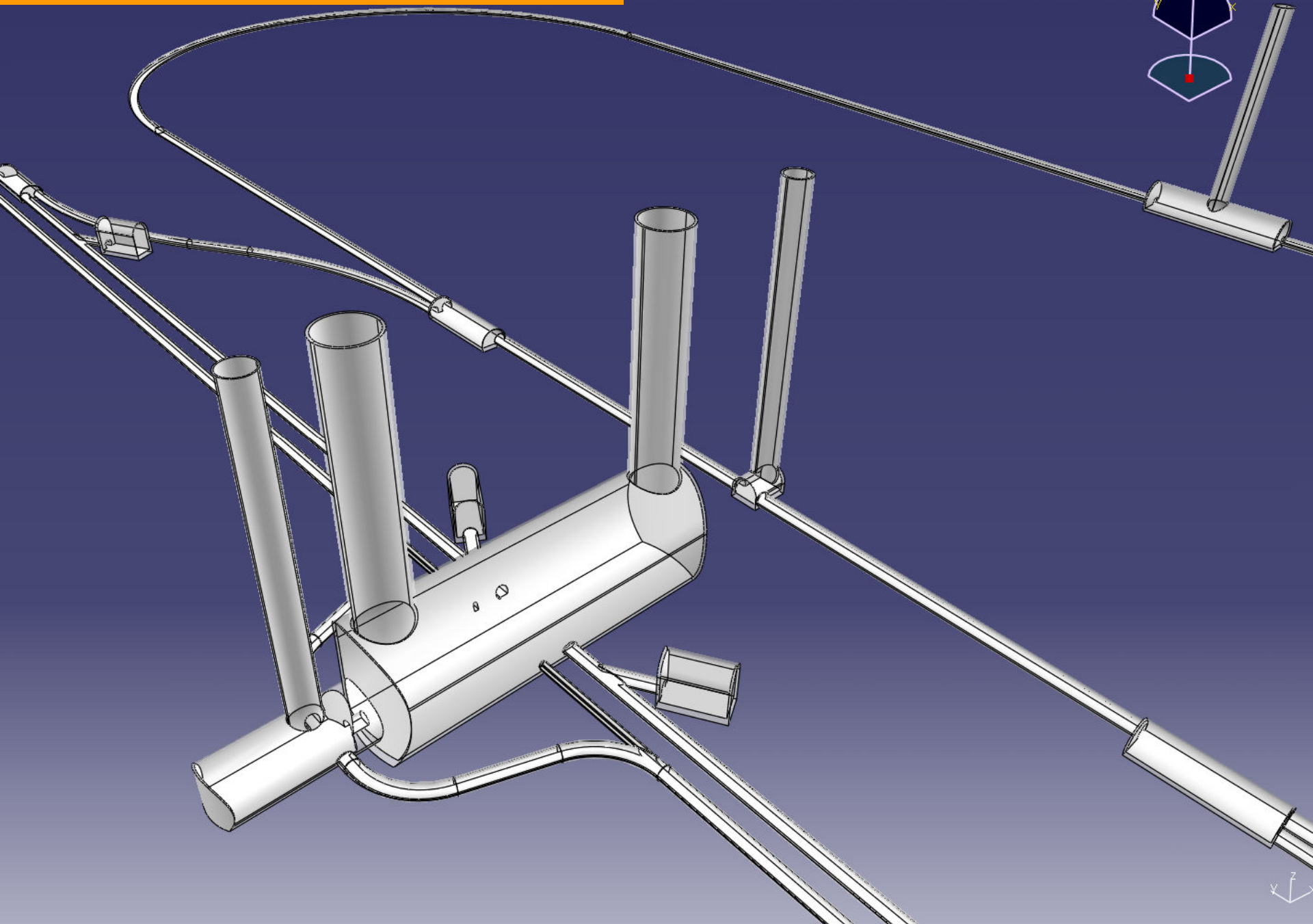

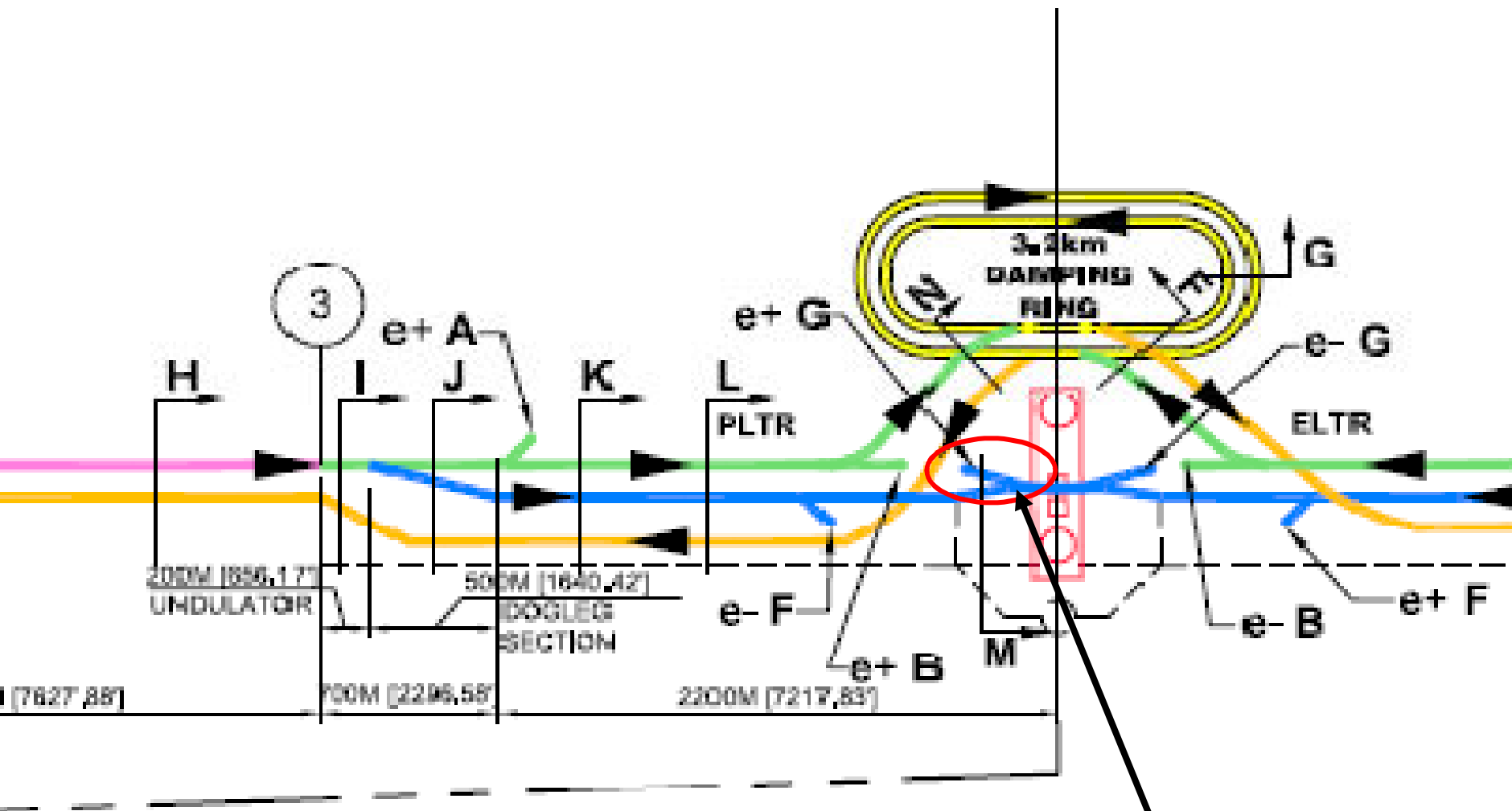

Main Beam dumps need to be moved to 'south side' i.e. opposite side of DR pointing downwards on this drawing.

This means, due to Muon radiation, level of service tunnel needs to be adjusted

Note : Some of these issues are refinements of the RDR rather than SB2009 !

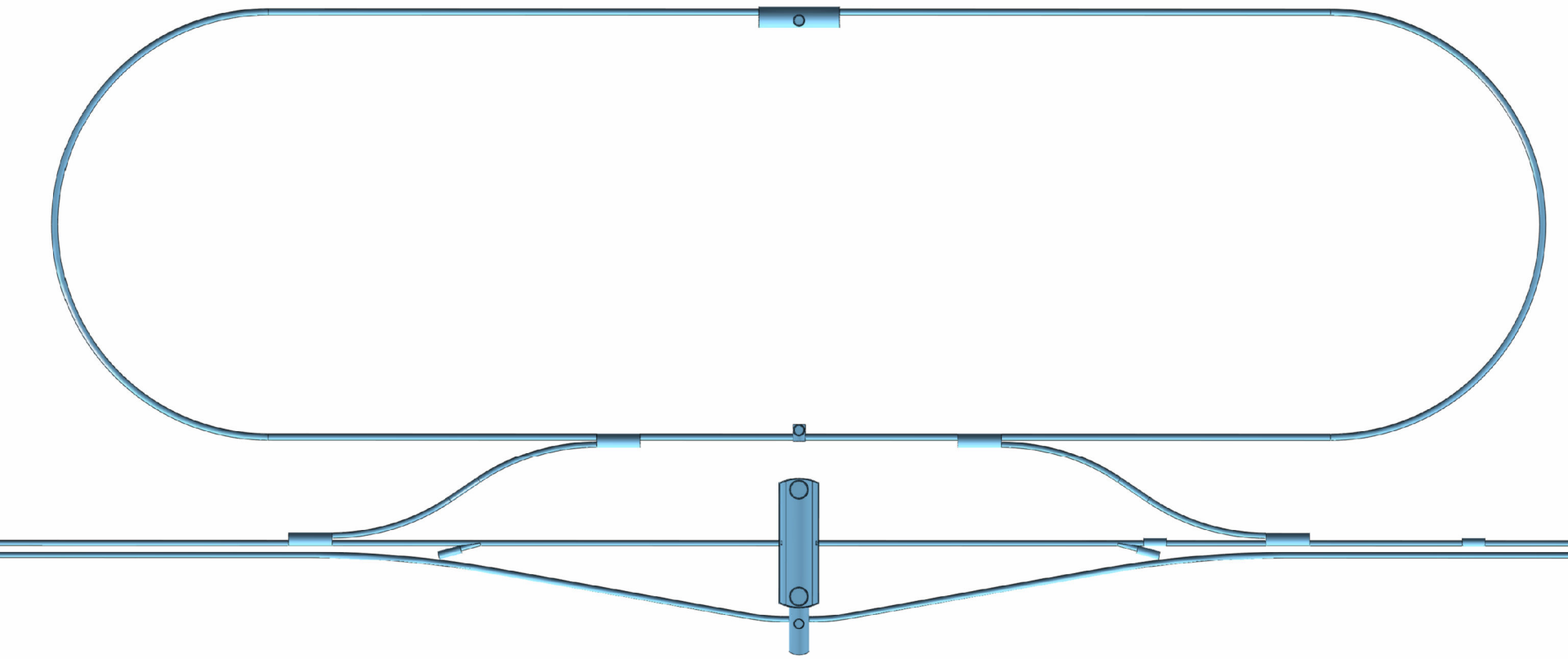

Service tunnel revised layout



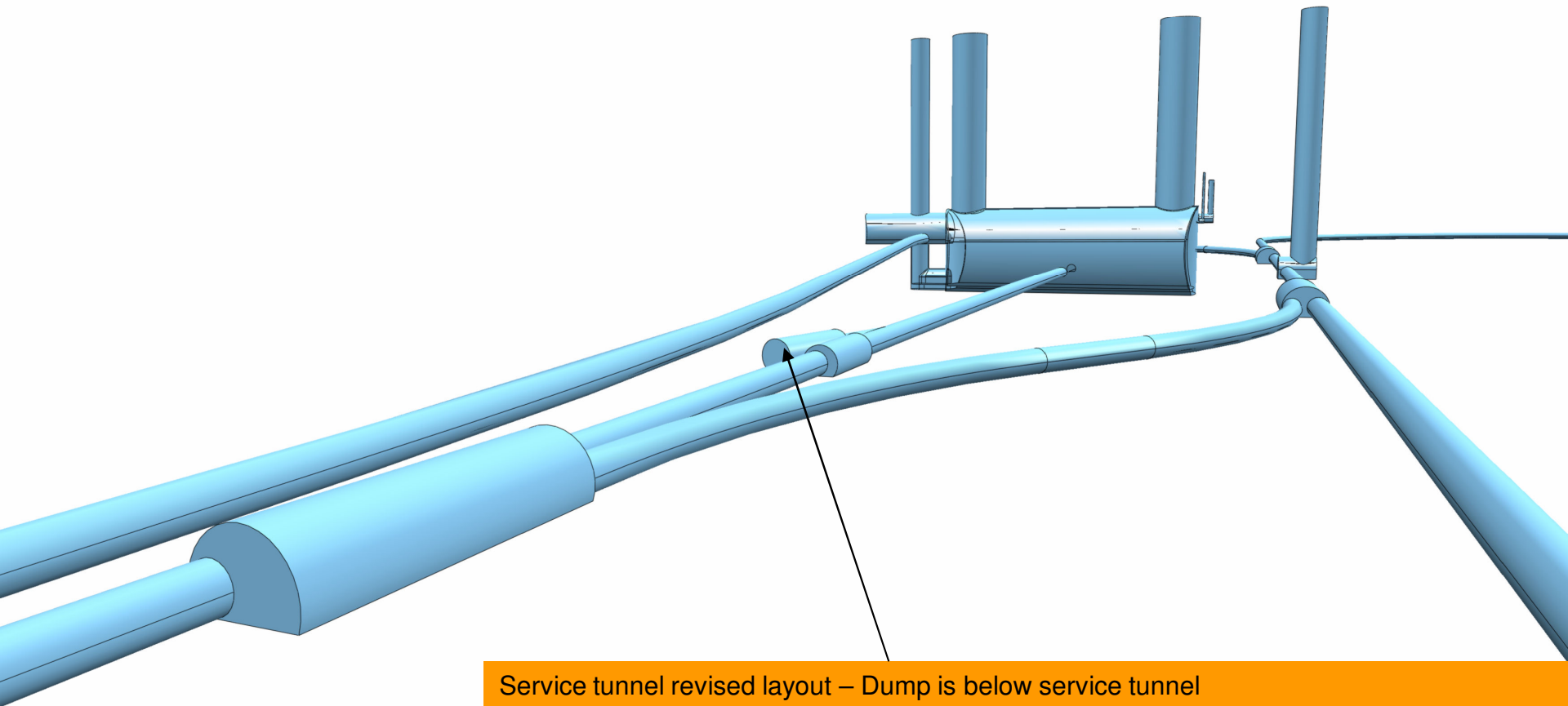

Service tunnel revised layout – Dump is below service tunnel

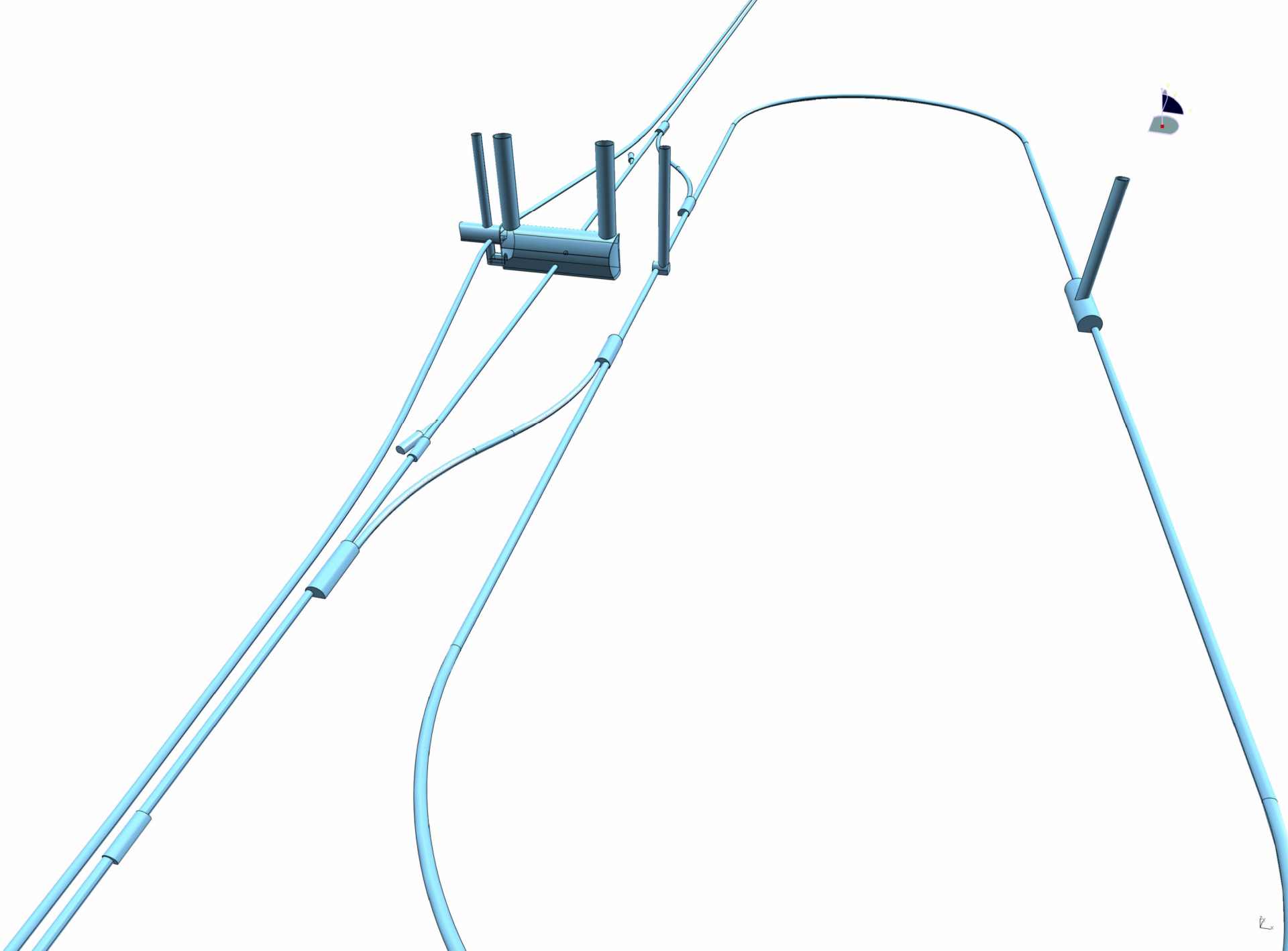

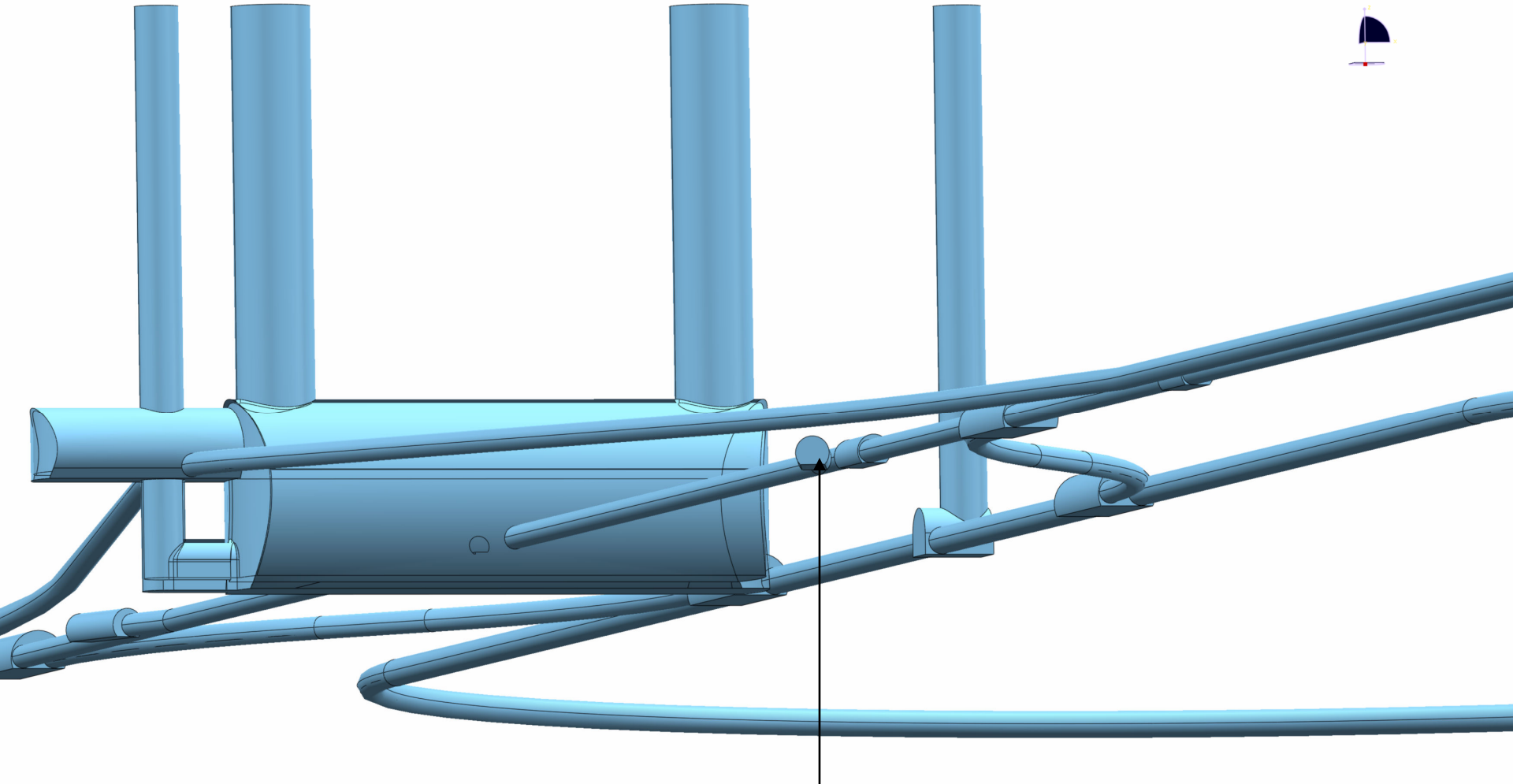

Service tunnel revised layout – Dump is below service tunnel

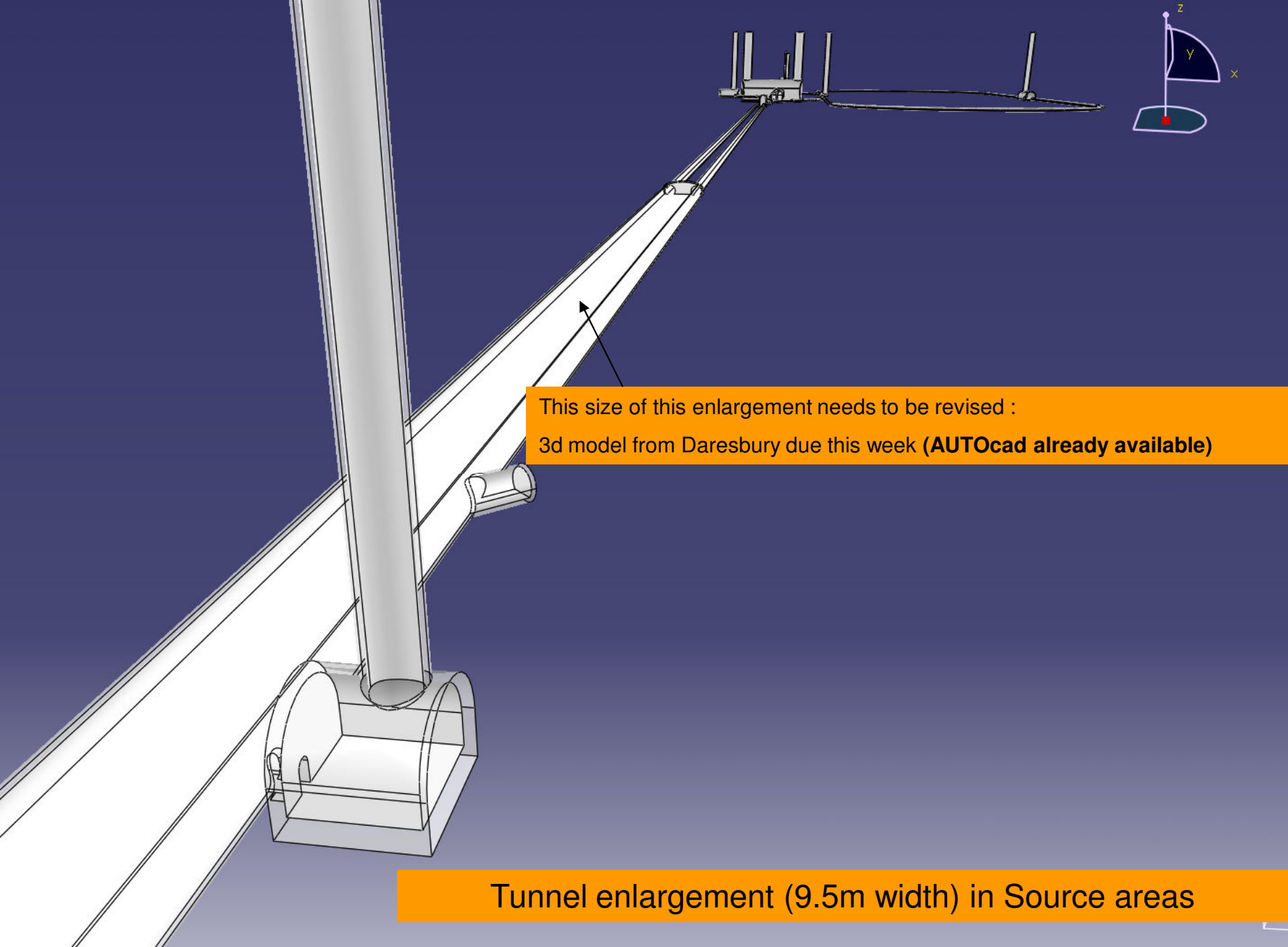

This size of this enlargement needs to be revised :
3d model from Daresbury due this week (**AUTOcad** already available)

Tunnel enlargement (9.5m width) in Source areas

e- MAIN LINAC

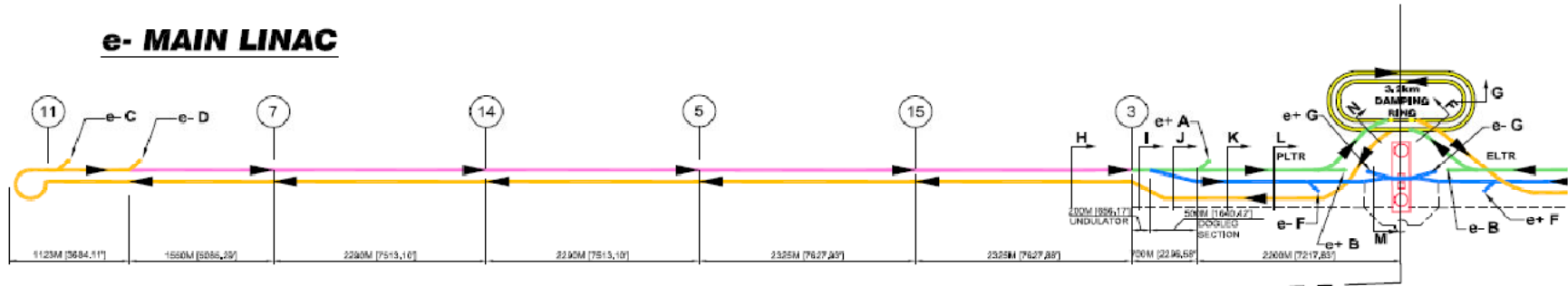

e+ MAIN LINAC

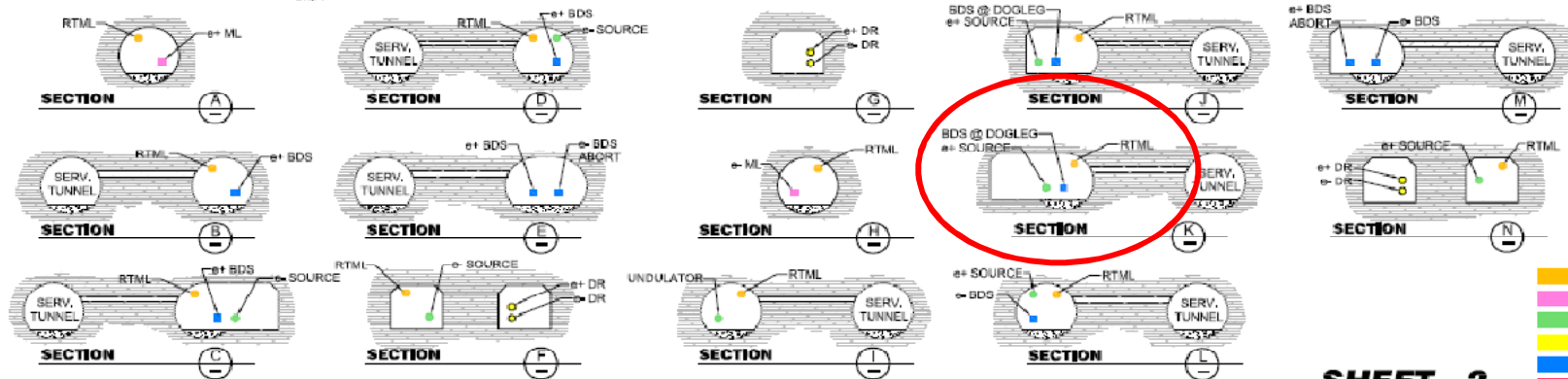
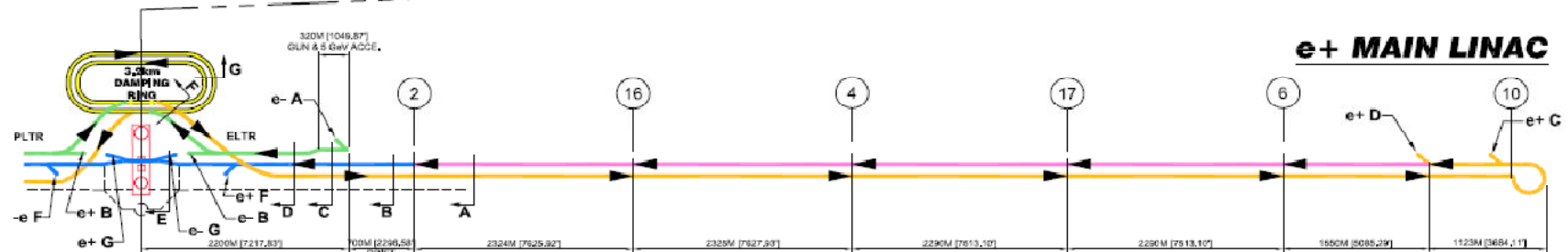

- LEGEND**
- RTML
 - ML
 - SOURCES
 - DR
 - BDS
 - DETECTOR AREA
 - SERVICE TUNNEL
 - BEAM DIRECTION

SHEET - 2
Draft 8 28 09

Tunnel enlargement (9.5m width) in Source areas needs to be reviewed (transport corridor on one side is acceptable?)

For both Klystron Cluster and DRFS we are assuming 5.2m single tunnel for main linac

Is cryo vent pipe required in standard tunnel cross section ?

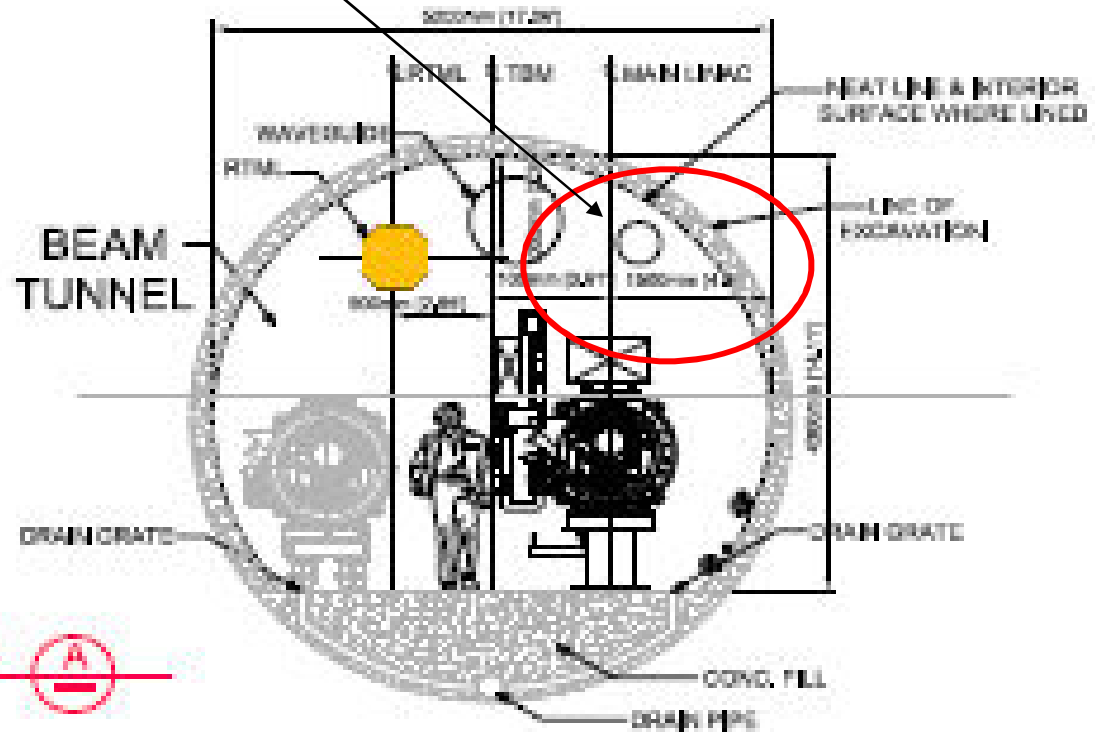

SECTION @ c- MAIN LINAC



- (2) Distributed RF System (Tunnel view)

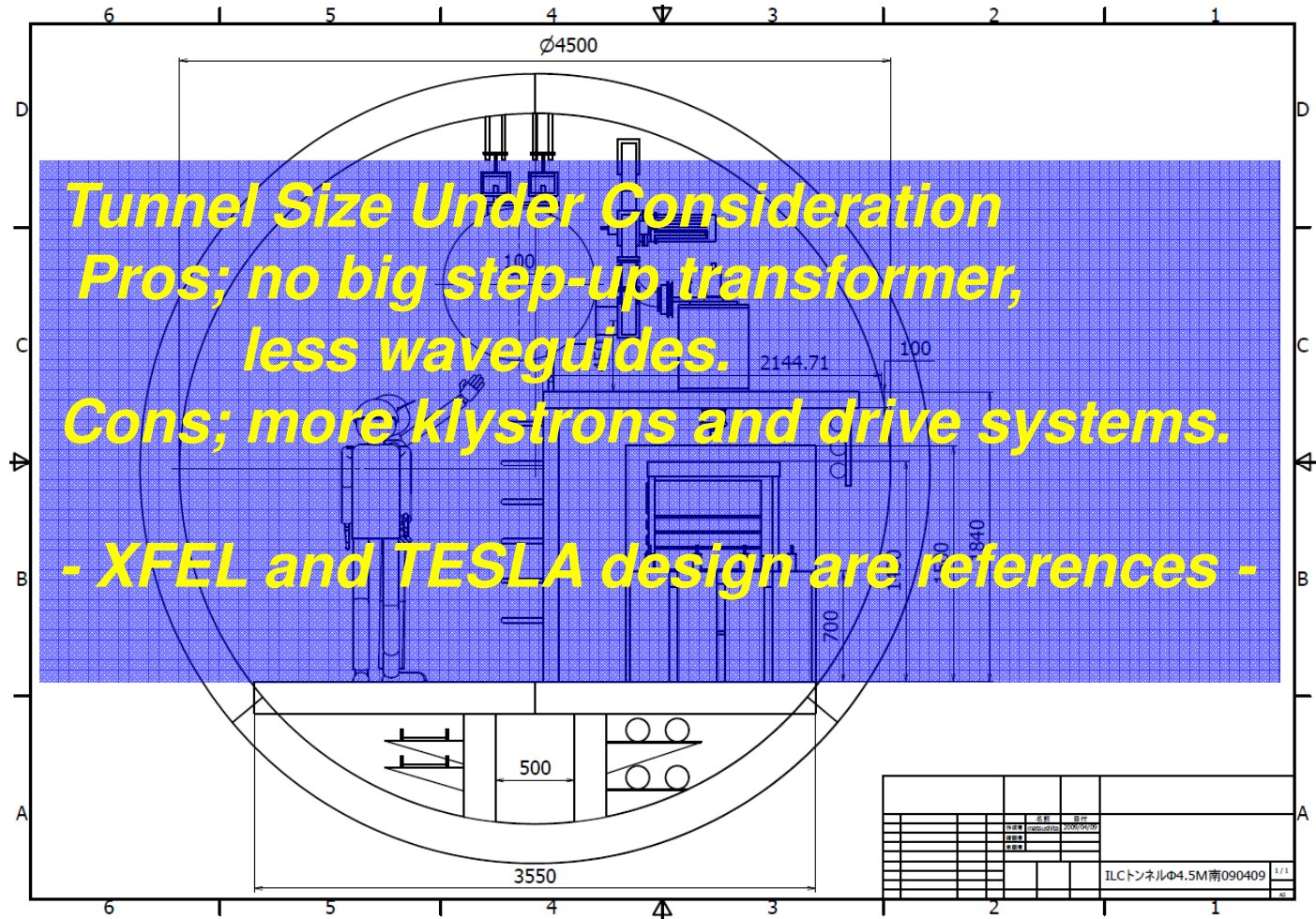

Main actions/conclusions from Daresbury

- 2d drawings to be updated and reviewed internally before release (FNAL)
- Updated machine 3d models by Norbert for positron source area (including BDS etc) awaited to allow sizing of the tunnel/alcoves
- Drawings will be different for each region.....
-
- Transport passage on one side of the machine ok
- DR relatively well understood remains on north side. Cavern sizes adjusted.
-
- RTML : one of the beam dumps can be deleted (On next 2d layout the beam dumps should be labelled 'main dump, 17KW dump etc to avoid confusion.)
-
- BDS : position and size of beam dumps unclear : 3d model by Norbert required....
-
- Main beam dumps need to be moved to other side of linac : may to put service tunnel at a higher level than beam tunnel due to muon beam radiation
-
- **2nd tunnel for safety** : Atsushi : Two possibilities:
 - 1. Fire shelters or compartments
 - 2. In Japan second tunnel option should not be excluded due to increase in safety requirements
- this will be presented at Albuquerque?
- do we need cryo vent pipe under pressure ?
-
- Muon walls questions, getting equipment either side ?
-
- Machine lines from main linac to DR transfer line is an issue
-
- beam dumps cross transport lines, extra shafts ?
-
- diameter of main linac 4.5 or 5.2m cost very similar = see cost curve from FNAL....
-
- services required for ML klystron electronics, instrumentation, shielding etc. needs better definition to update cross section
-
- heat loads mostly understood by CFS...Emil....(DRFS full power/ low power confirmed by KEK 9 Sept)
-
- For Albuquerque :
-
- 2d's updated
- Norbert to do 3ds for machine
- 3d civil updated
-
- Nick asked for cost estimate for this new layout with respect to RDR.....
-
- Next AD&I first week of December ?