

Test beam study of a large GEM-TPC prototype equipped with a GEM-gate device for the ILC

Katsumasa Ikematsu (KEK/IPNS)

International Linear Collider Workshop 2010

29/03/2010 @ Friendship Hotel, Beijing, China

Introduction

LC-TPC LP1 & Asian-GEM

- Purpose of the LC-TPC large prototype 1 (**LP1**)
 - Build and operate a large prototype (\O_{in} : 72cm, L_{drift} : 61cm) in conjunction with EUDET, which allows any MPGD technology, to test manufacturing techniques for MPGD endplates, field cage and electronics
 - Measurements using DESY testbeam & magnetic field (PCMAG) to confirm small prototype results with larger scale device in particular: spatial resolution, dE/dx , homogeneity of large MPGD surfaces, long term stability
 - Demonstrate measurement of 6GeV electron beam momentum over 70cm track length (~10k channels), including development of corrections procedure in the presence of inhomogeneous magnetic field
- Asian group brought GEM modules equipped with a GEM-gate device to LP1
 - Double amplification-GEMs + gate-GEM w/ ~10k ch ALTRO elec. (Lund U.) in preparation at DESY-II T24

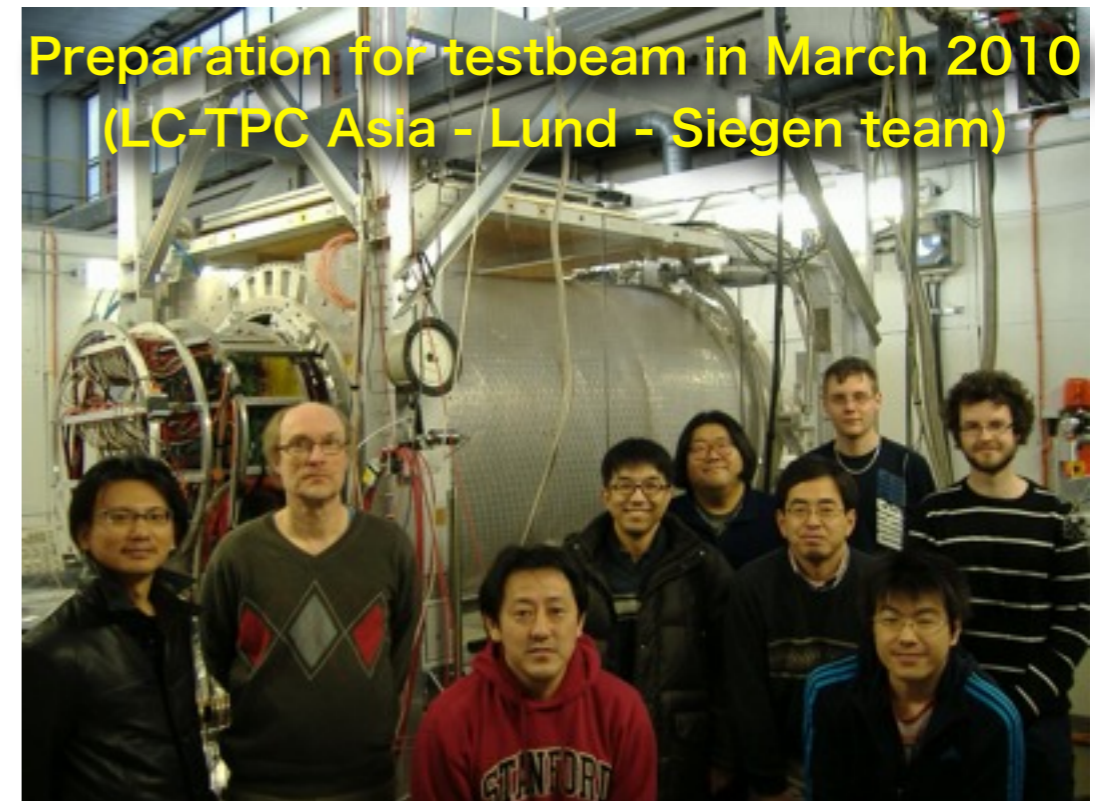
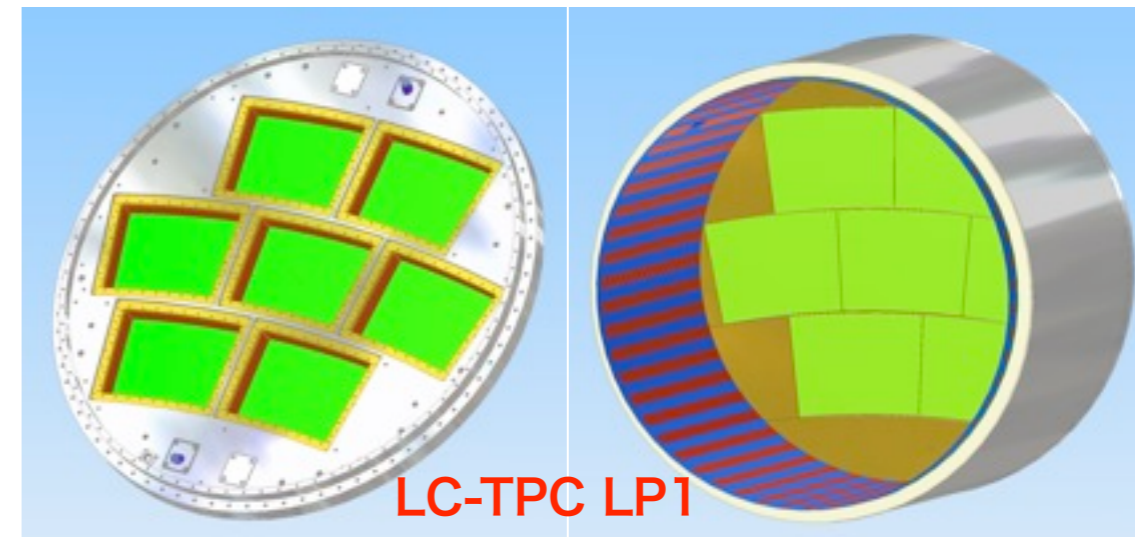
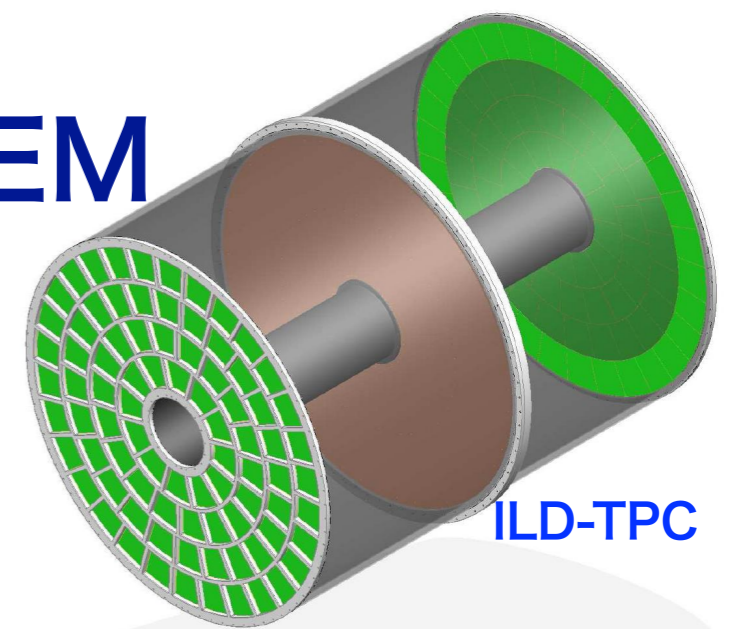

Concept of Asian-GEM module

- **Small pad** + **Thick double-GEM** + GEM-gate device + up-downside support frame

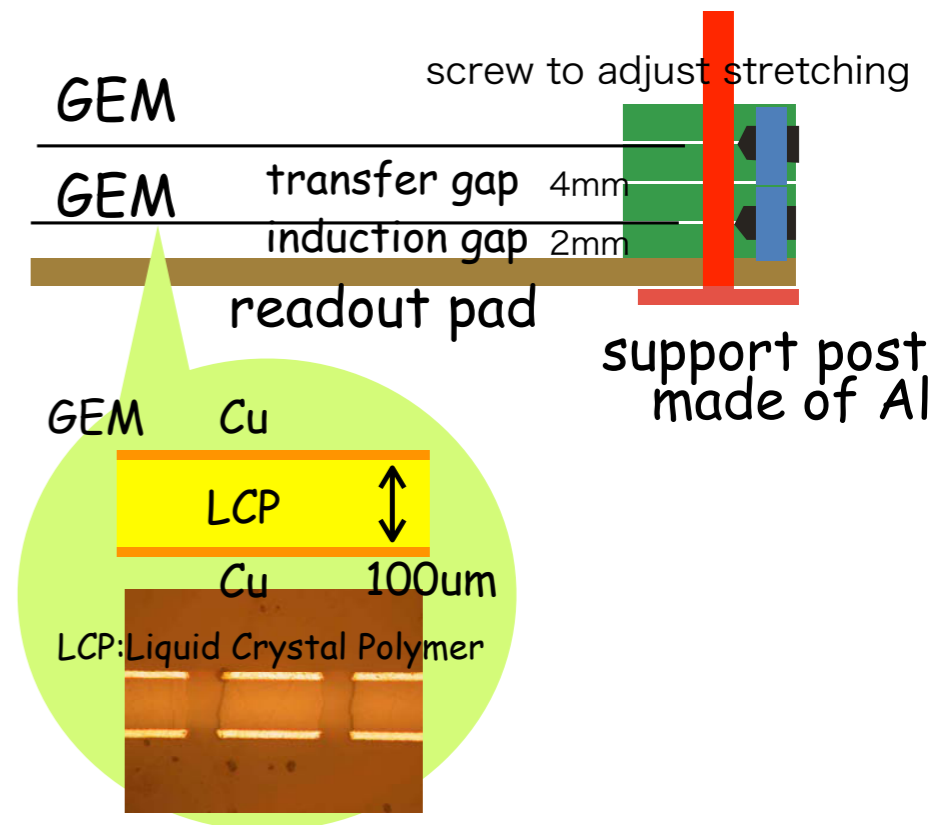
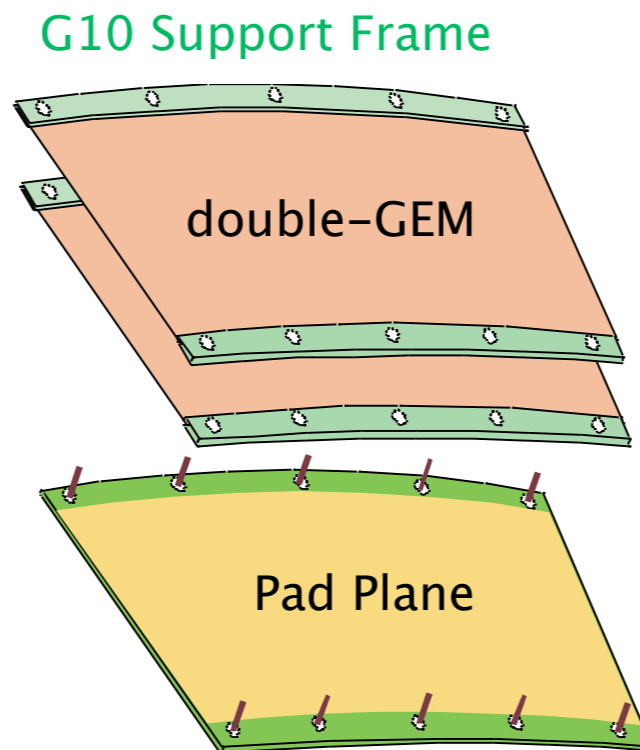
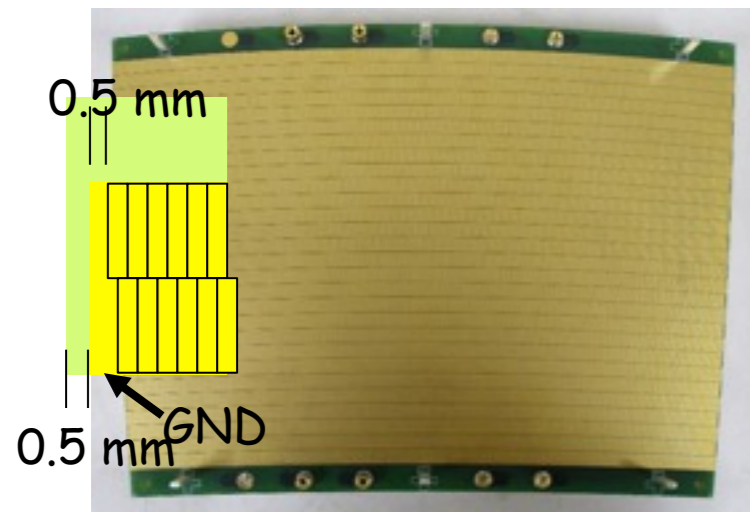

- **Pad plane**

- Designed and fabricated at Tsinghua Univ.
- 5152 pads / PCB (module)
- **28 layers**
- 192 pads at outer
- 176 pads at inner
- **1.15~1.25 mm width**
- 5.26mm height
- **Staggered layout**

- **Thick double-GEM for amplification**

- **100 μ m thick** LCP (Liquid Crystal Polymer)
- Hole: 70 μ m ϕ 、140 μ m pitch
- Produced by SciEnergy (Japanese company)
- Gas mixture: **Ar-CF4-isoC4H10 (95:3:2) = T2K gas**
- Gas Gain: ~3000 at **$V_{GEM} = 360V$**
- (Drift field: 230V/cm)

Concept of Asian-GEM module (cont'd)

- Small pads + Thick double-GEM + **GEM-gate device** + up-downside support frame

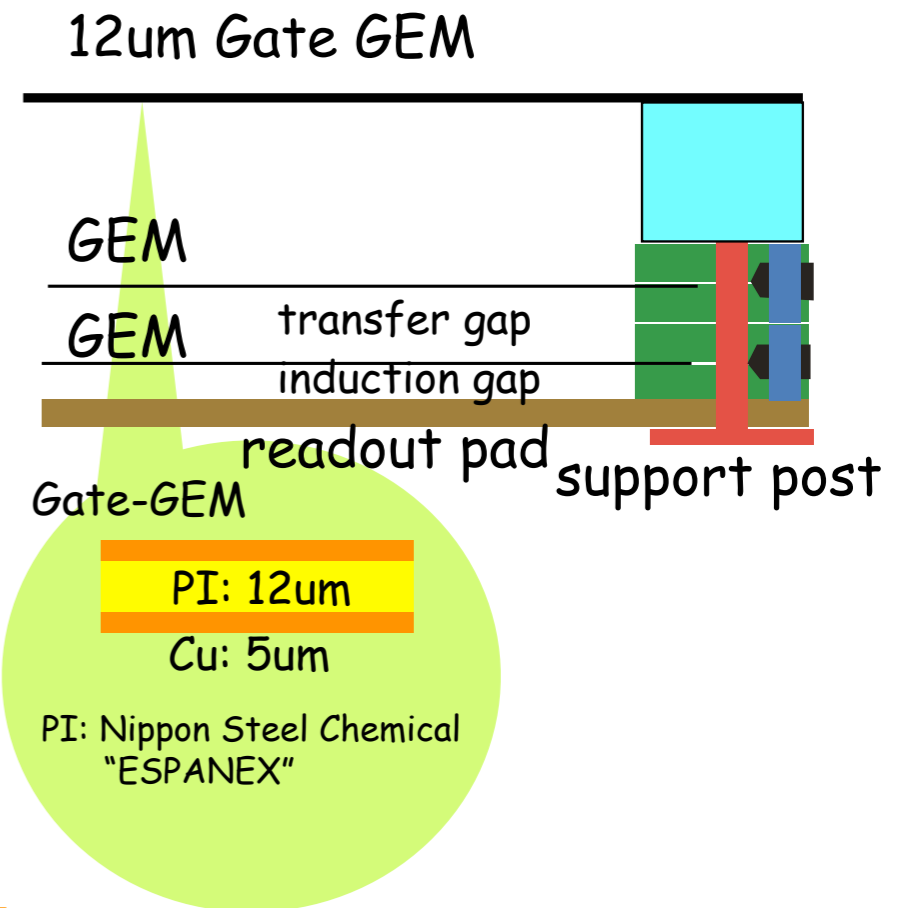
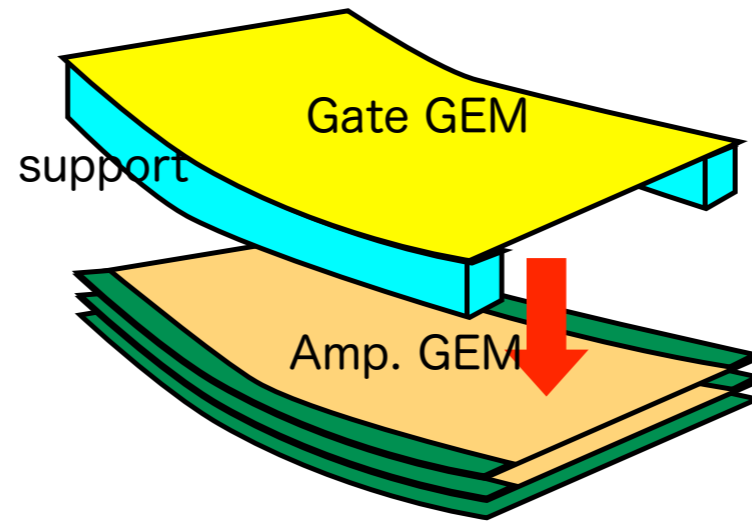
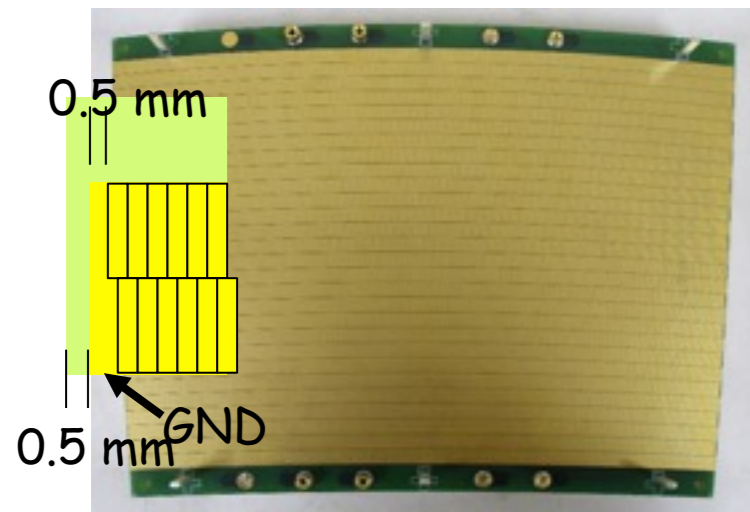

• Pad plane

- Designed and fabricated at Tsinghua Univ.
- 5152 pads / PCB (module)
- 28 layers
- 192 pads at outer
- 176 pads at inner
- 1.15~1.25 mm width
- 5.26mm height
- Staggered layout

• GEM-gate device

- 12 μm thick PI (Nippon Steel Chemical "ESPANEX")
- Hole: 90 μm ϕ , 140 μm pitch
- Produced by SciEnergy (Japanese company)
- Low voltage operation: good electron transmission, where no gas amplification occurs

Brief review of beam test in Spring '09

- **GEM-gate was not ready last year!**
 - Metal posts facing drift volume produced local distortion...
- **TPC moving stage was not available last year!**
 - Displacing TPC in PCMAG for z-scan introduced different B field for each drift...
- **Combination of 2 problems made our situation very complicated!!**

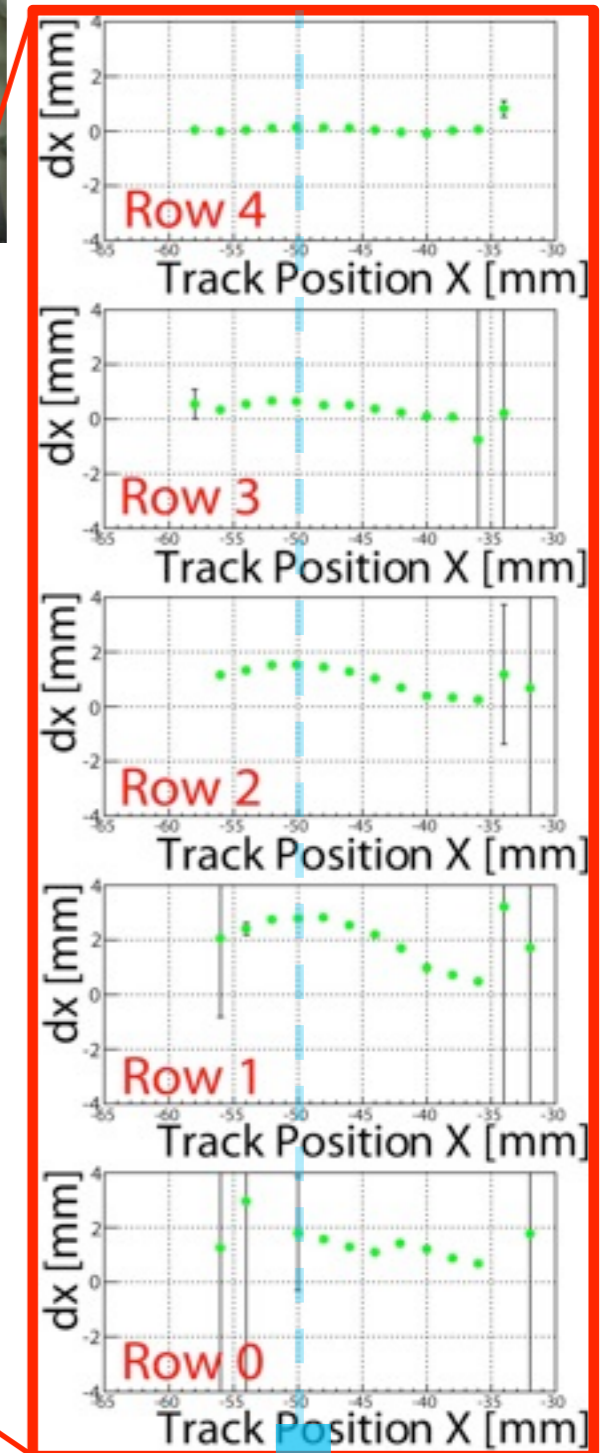
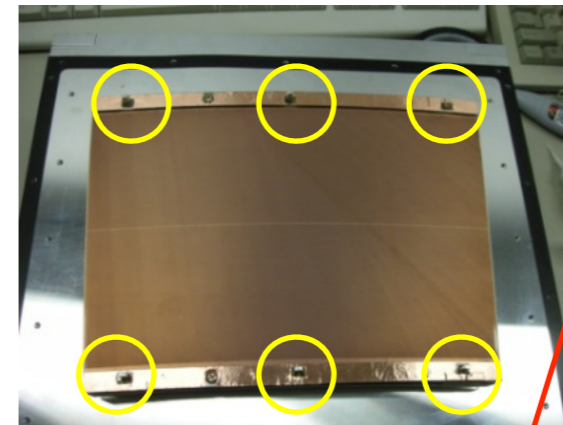
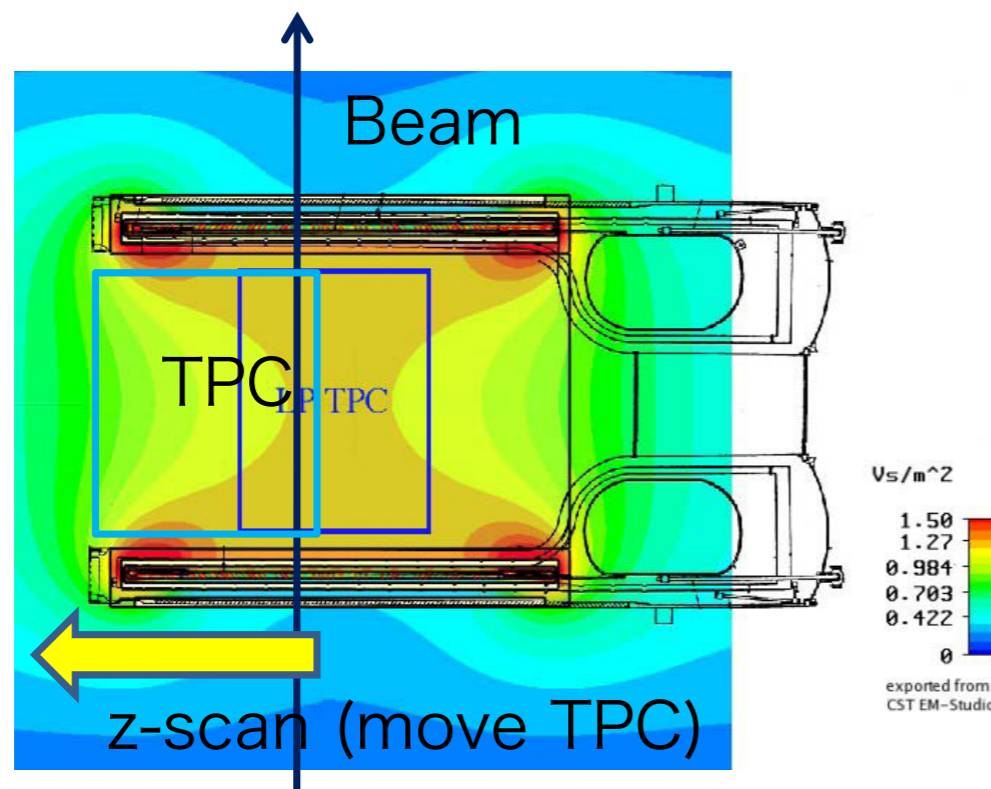

Location of post

Brief review of beam test in Spring '09

- **GEM-gate was not ready last year!**
 - Metal posts facing drift volume produced local distortion...
- **TPC moving stage was not available last year!**
 - Displacing TPC in PCMAG for z-scan introduced different B field for each drift...
- **Combination of 2 problems made our situation very complicated!!**

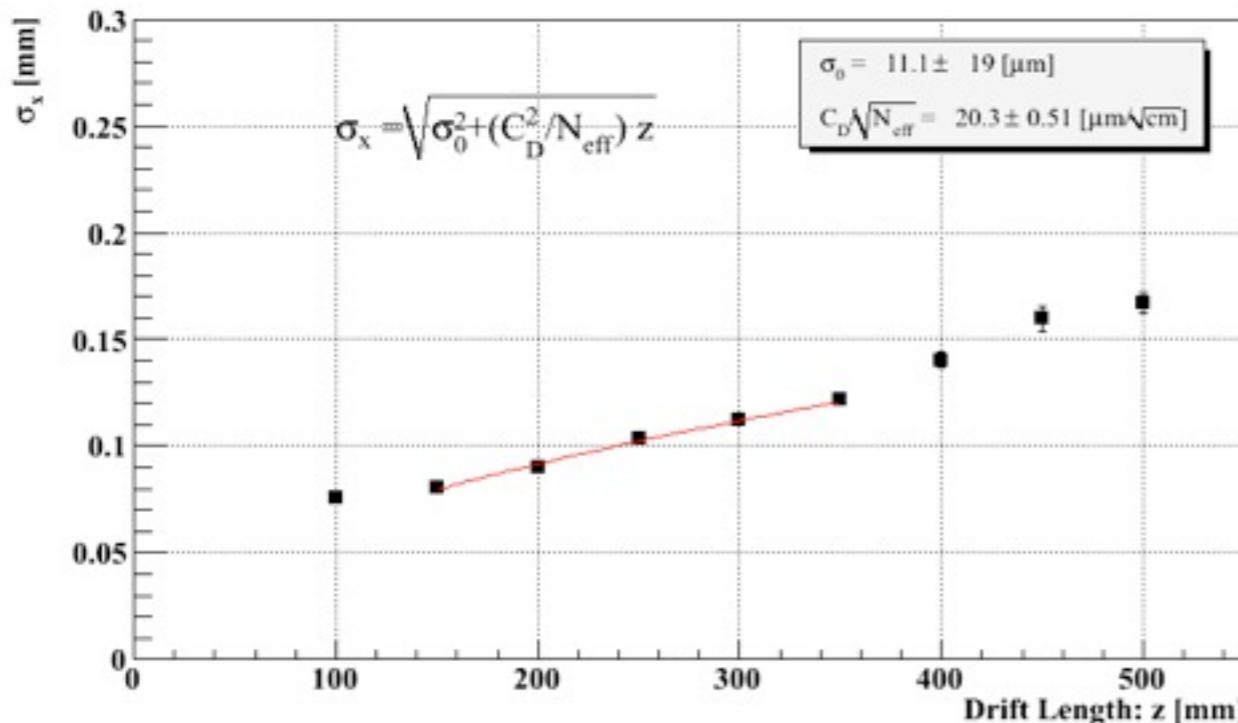
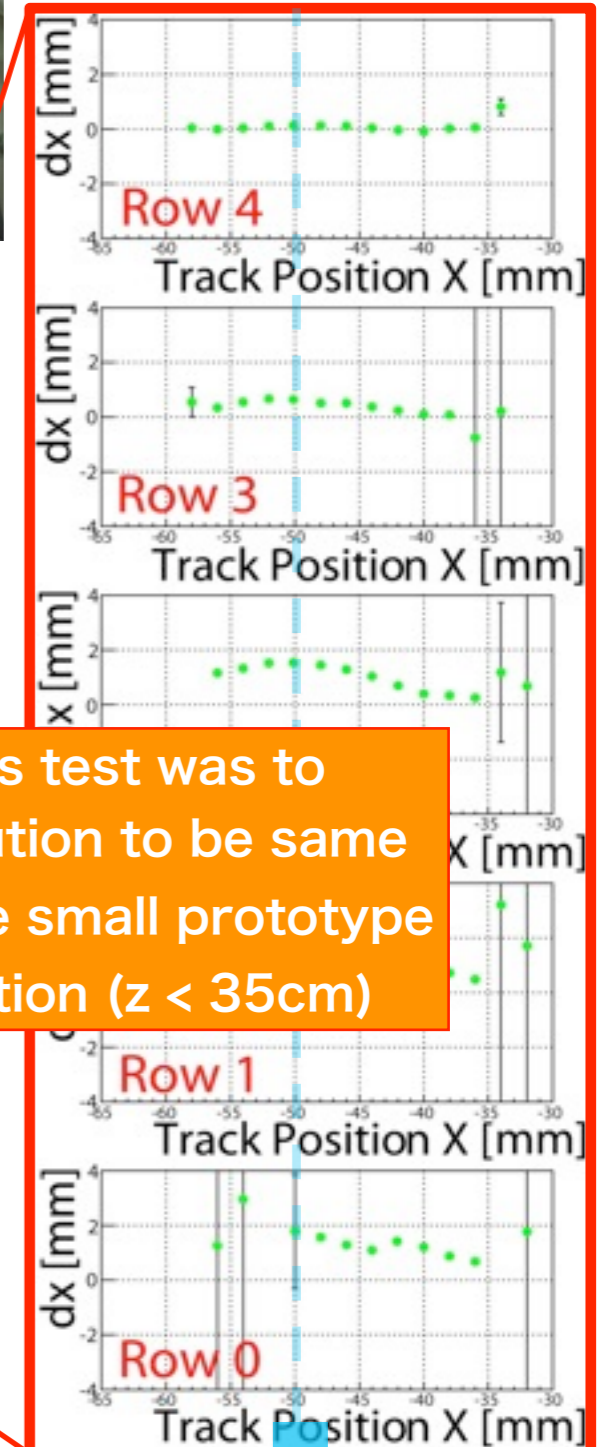
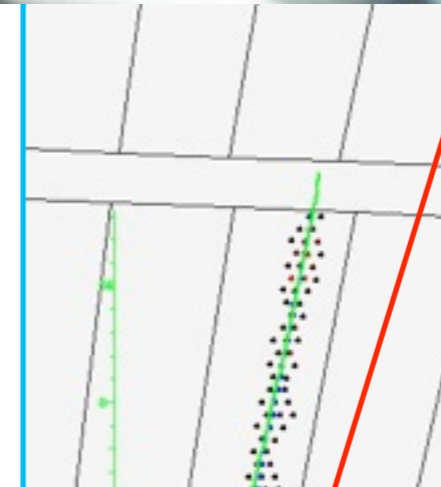
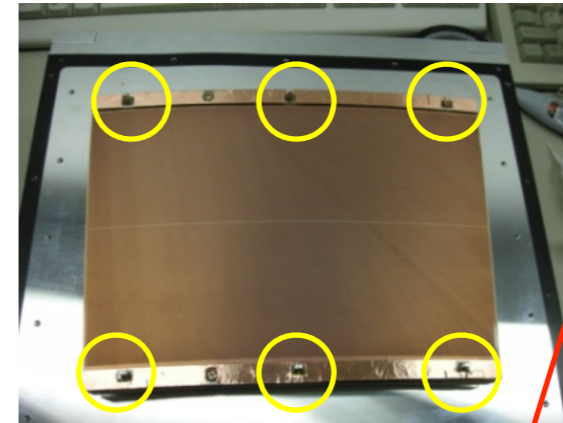

Goal of the last year's test was to establish position resolution to be same as one provided from the small prototype after distortion correction (z < 35cm)

E-field distortion
 × B-field
 = Local distortion

Location of post

Brief review of beam test in Spring '09

- **GEM-gate was not ready last year!**
 - Metal posts facing drift volume produced local distortion...
- **TPC moving stage was not available last year!**
 - Displacing TPC in PCMAG for z-scan introduced different B field for each drift...
- **Combination of 2 problems made our situation very complicated!!**

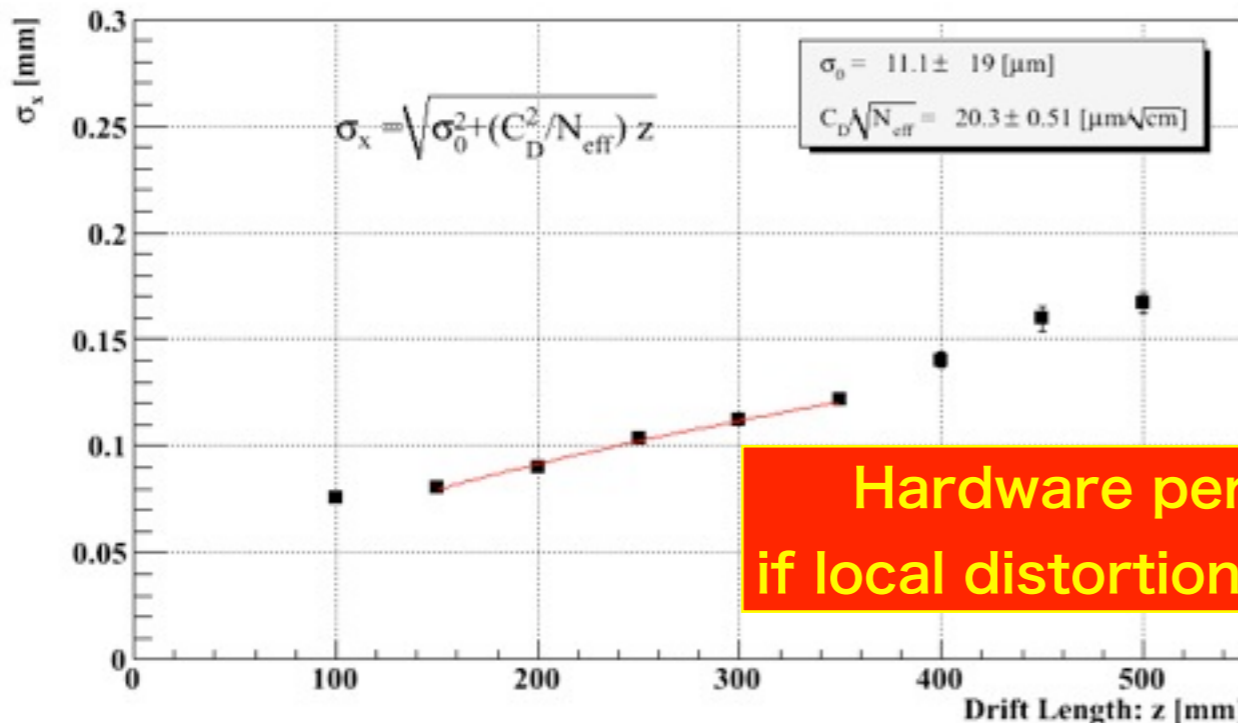
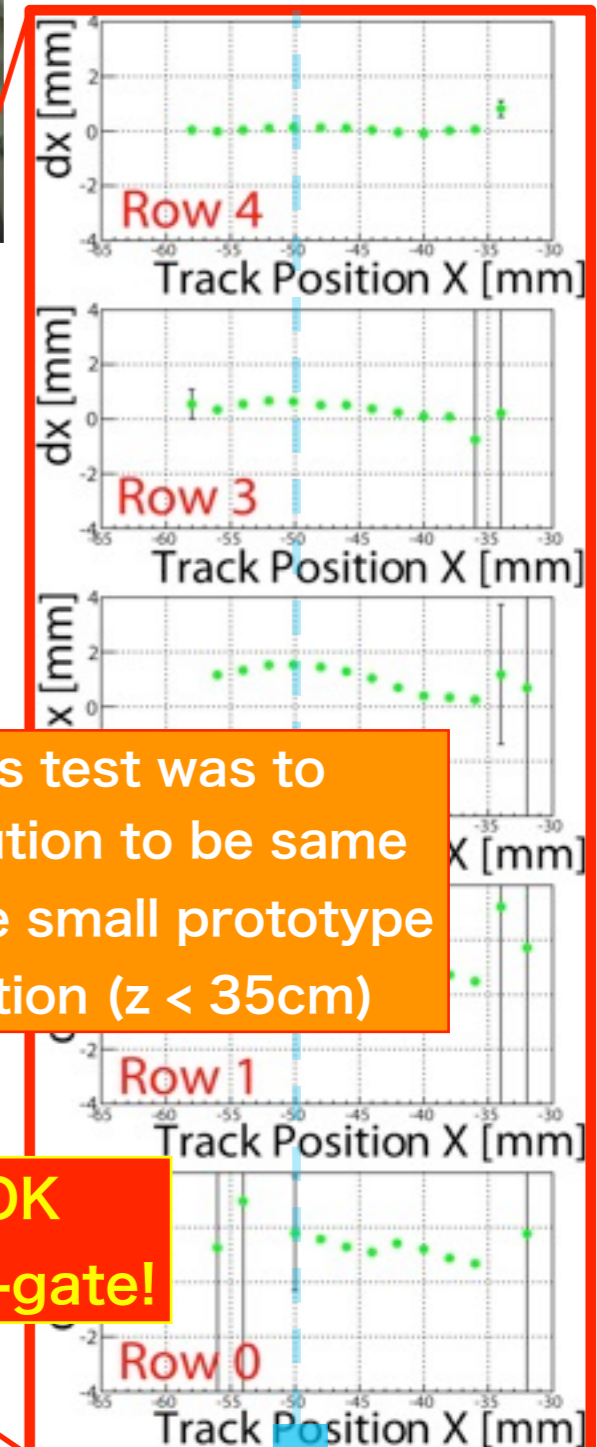
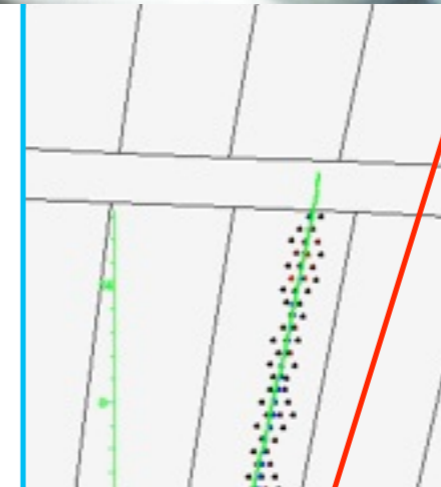
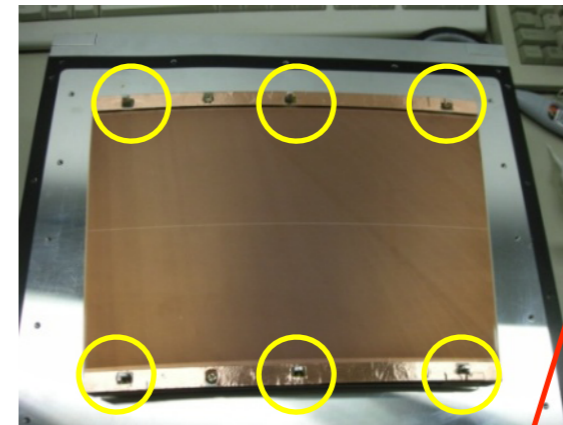

Goal of the last year's test was to establish position resolution to be same as one provided from the small prototype after distortion correction (z < 35cm)

Hardware performance seems to be OK if local distortion is fixed by putting GEM-gate!

E-field distortion
 × B-field
 = Local distortion

Location of post

Status of GEM-gating

GEM-gate device framing/assembly

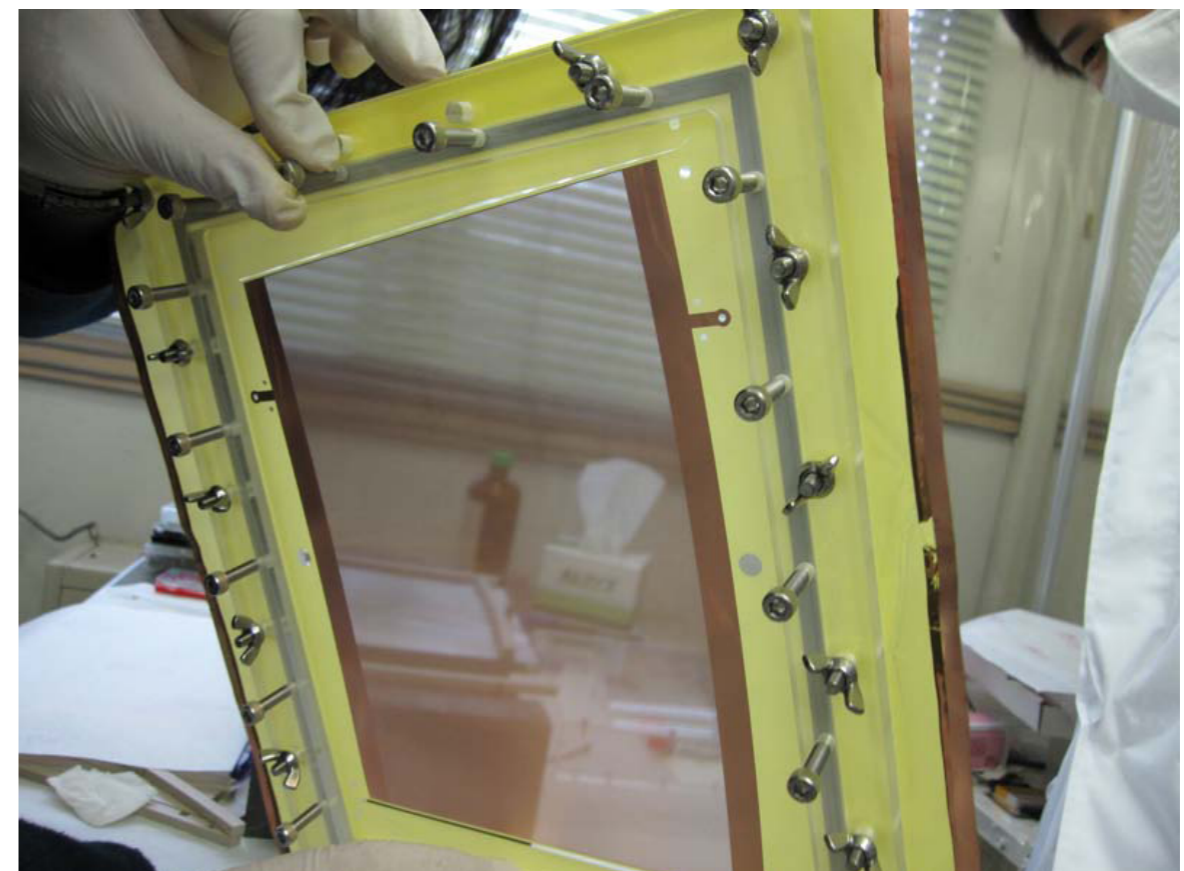
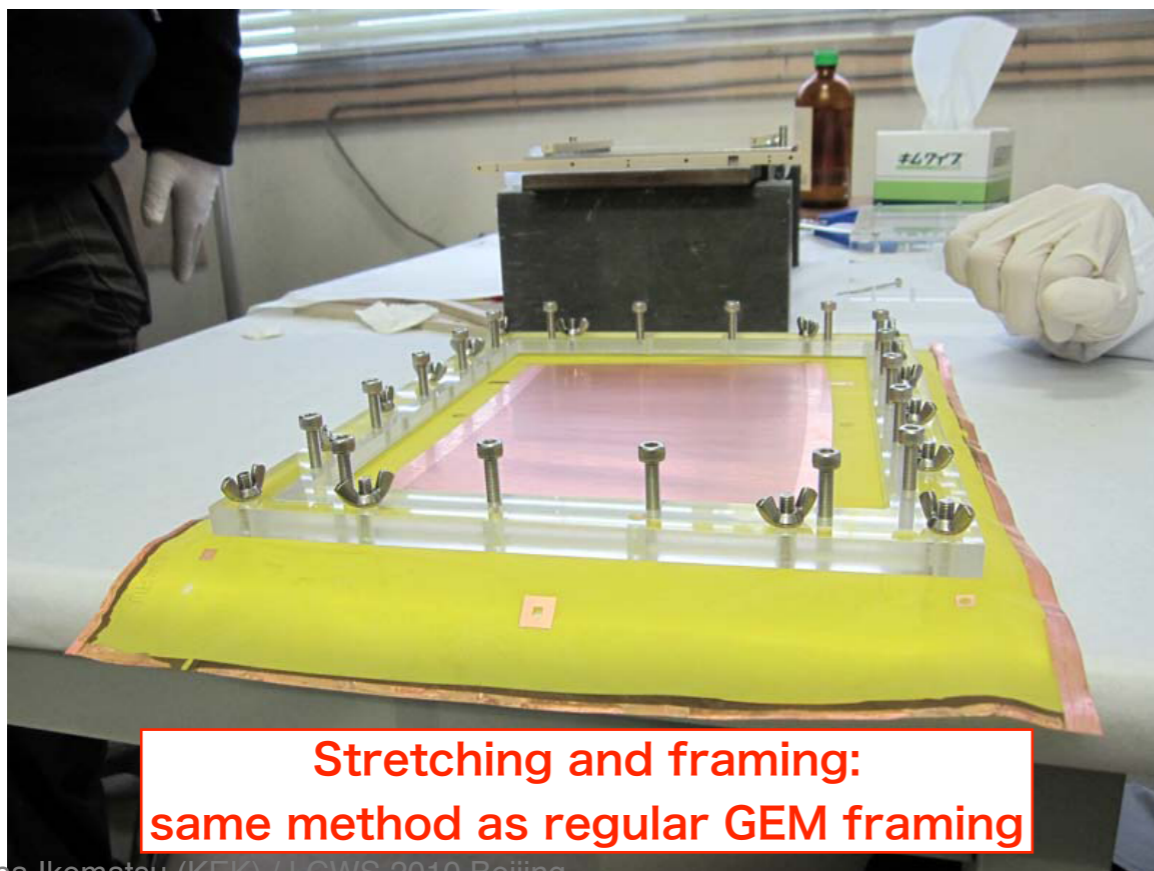
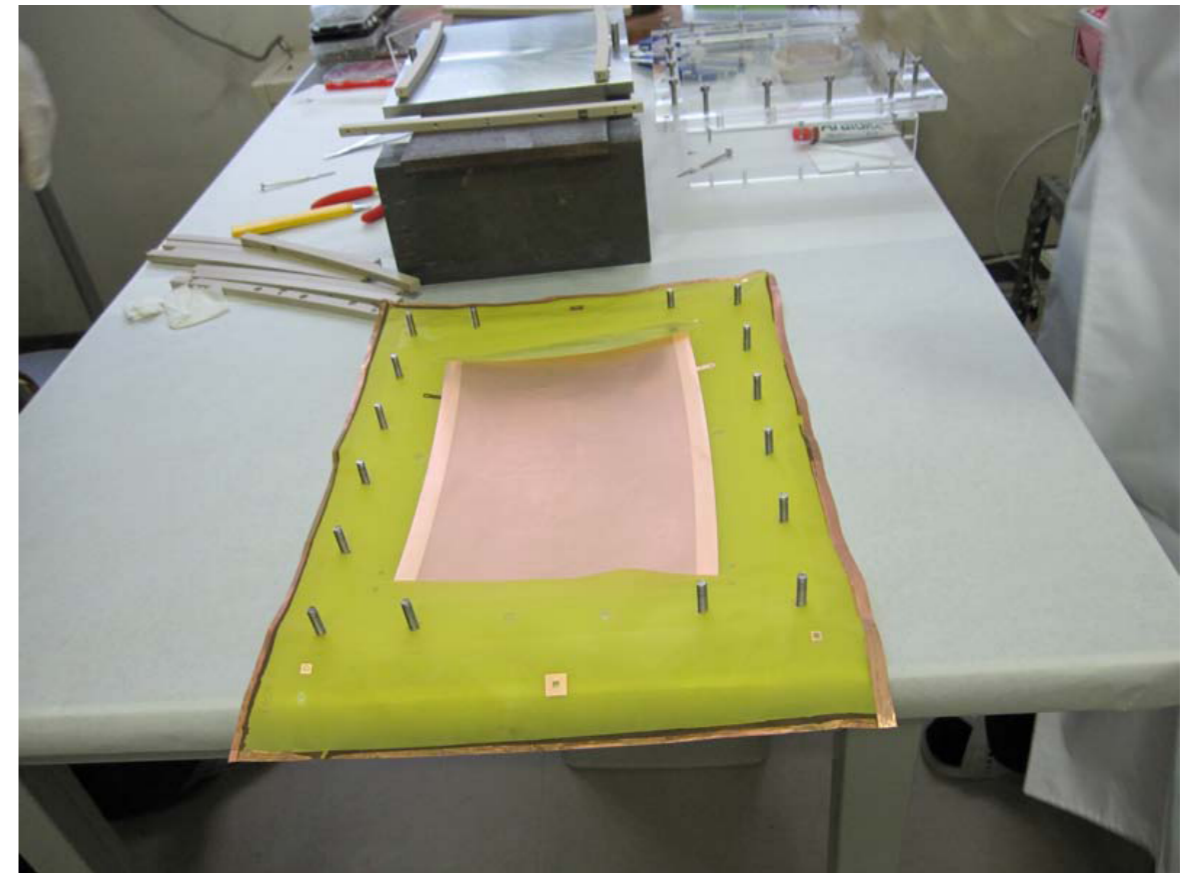
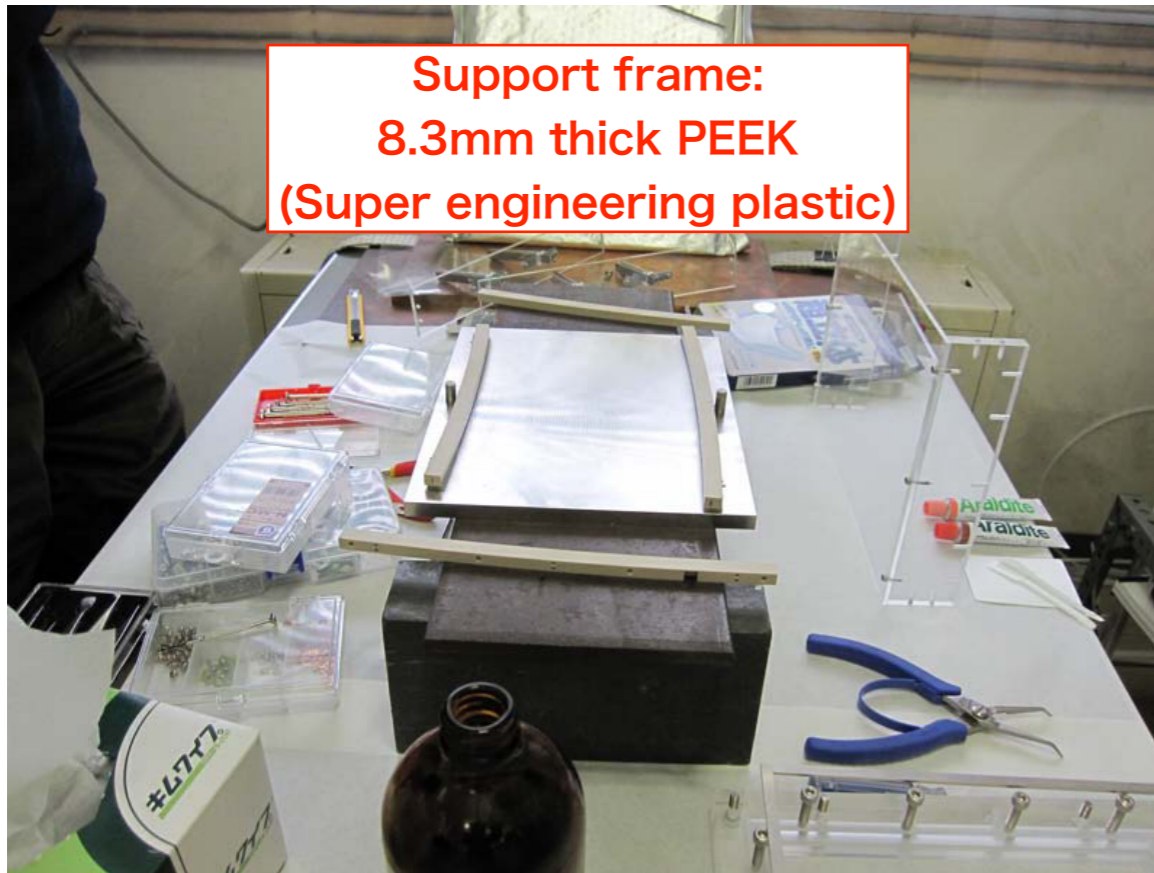

GEM-gate device holding/mounting

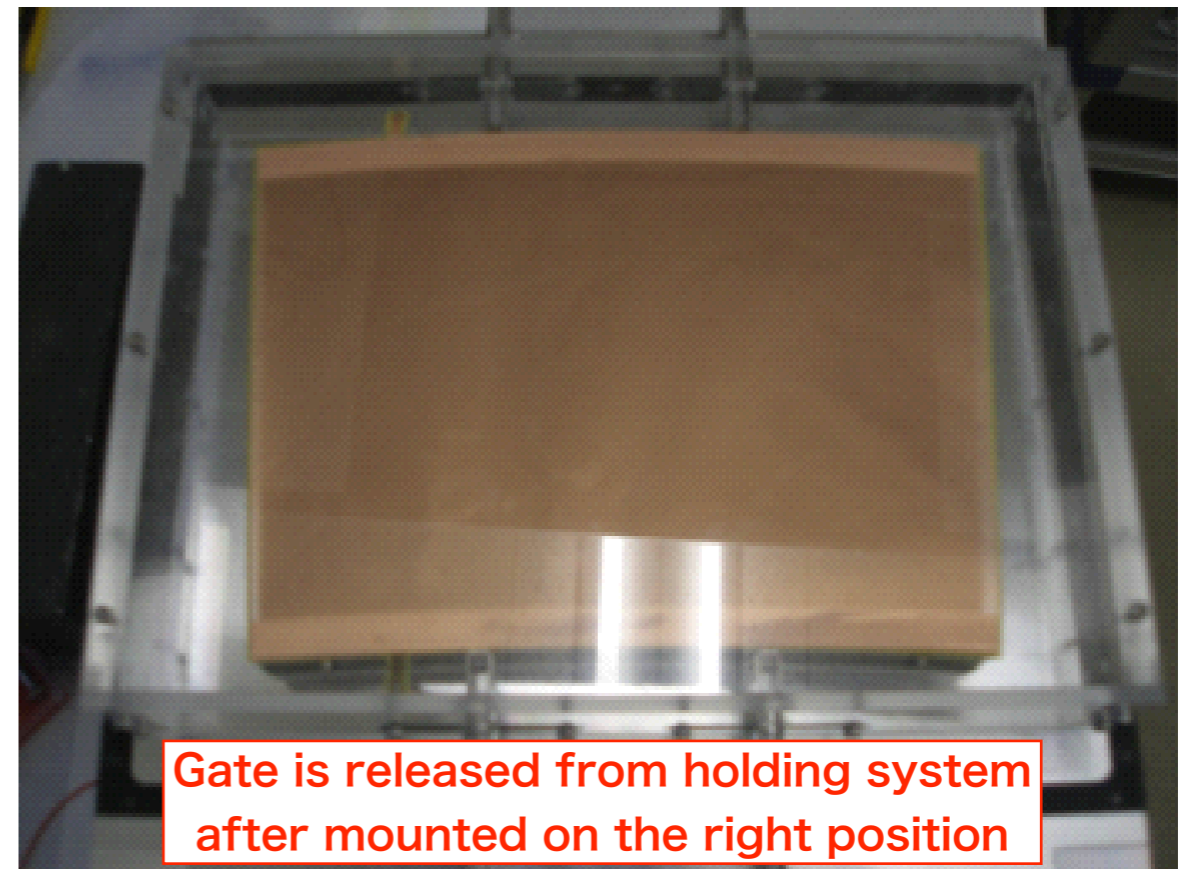
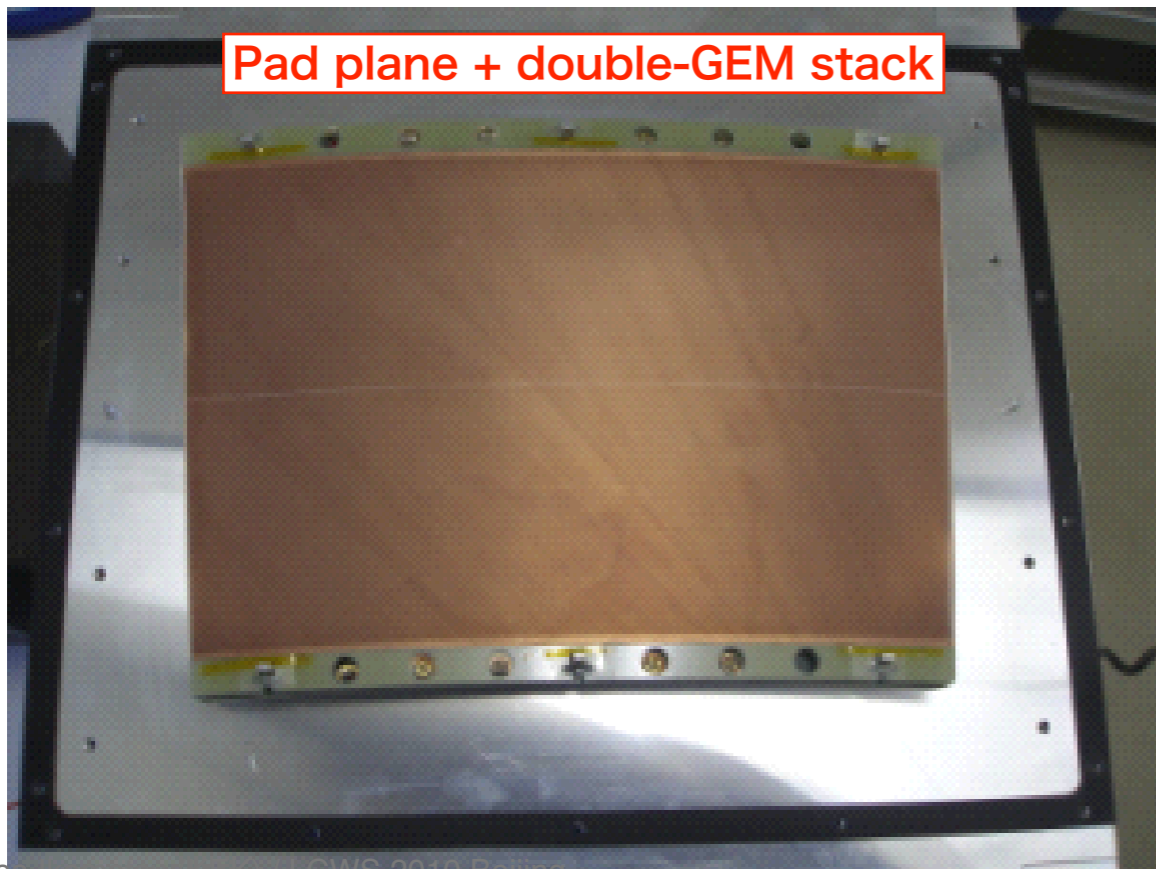
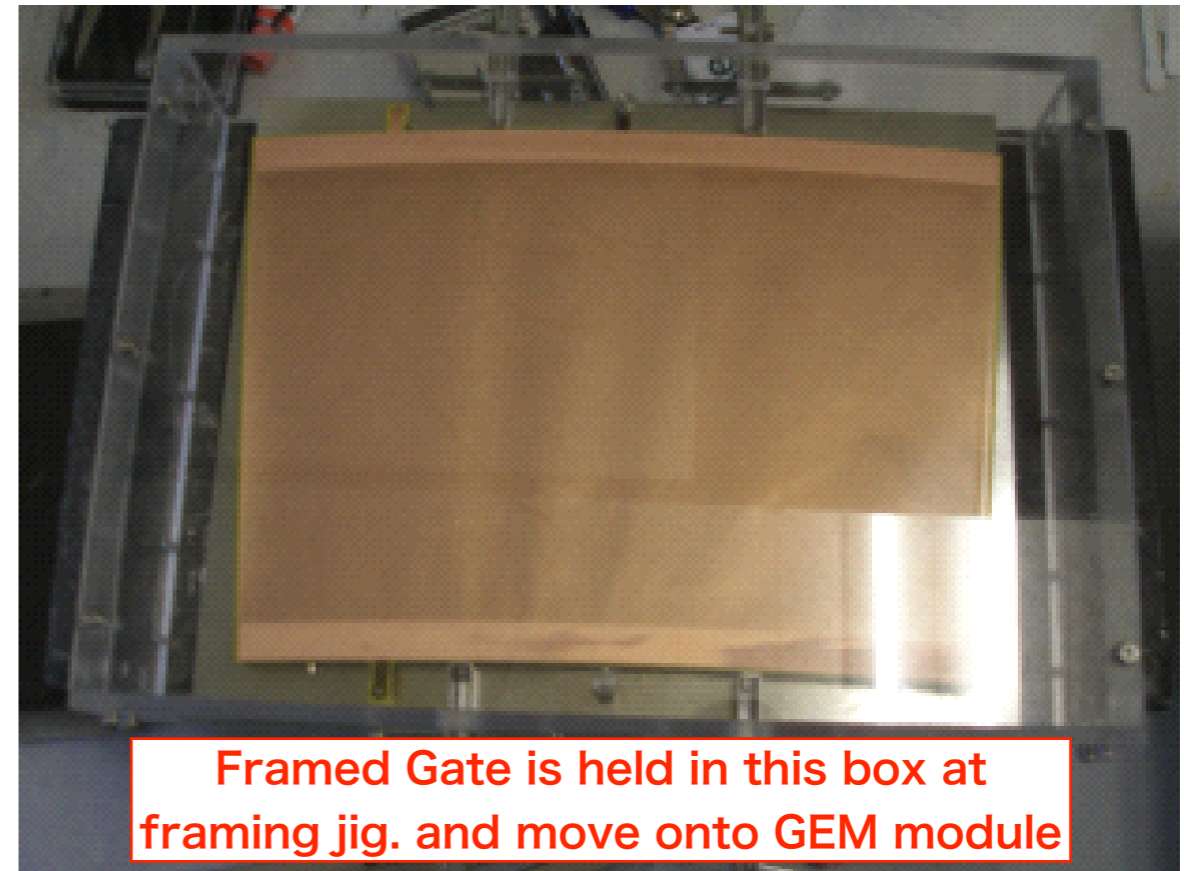

GEM-gate device holding/mounting



Gate GEM is so fragile, cannot stay without holding system

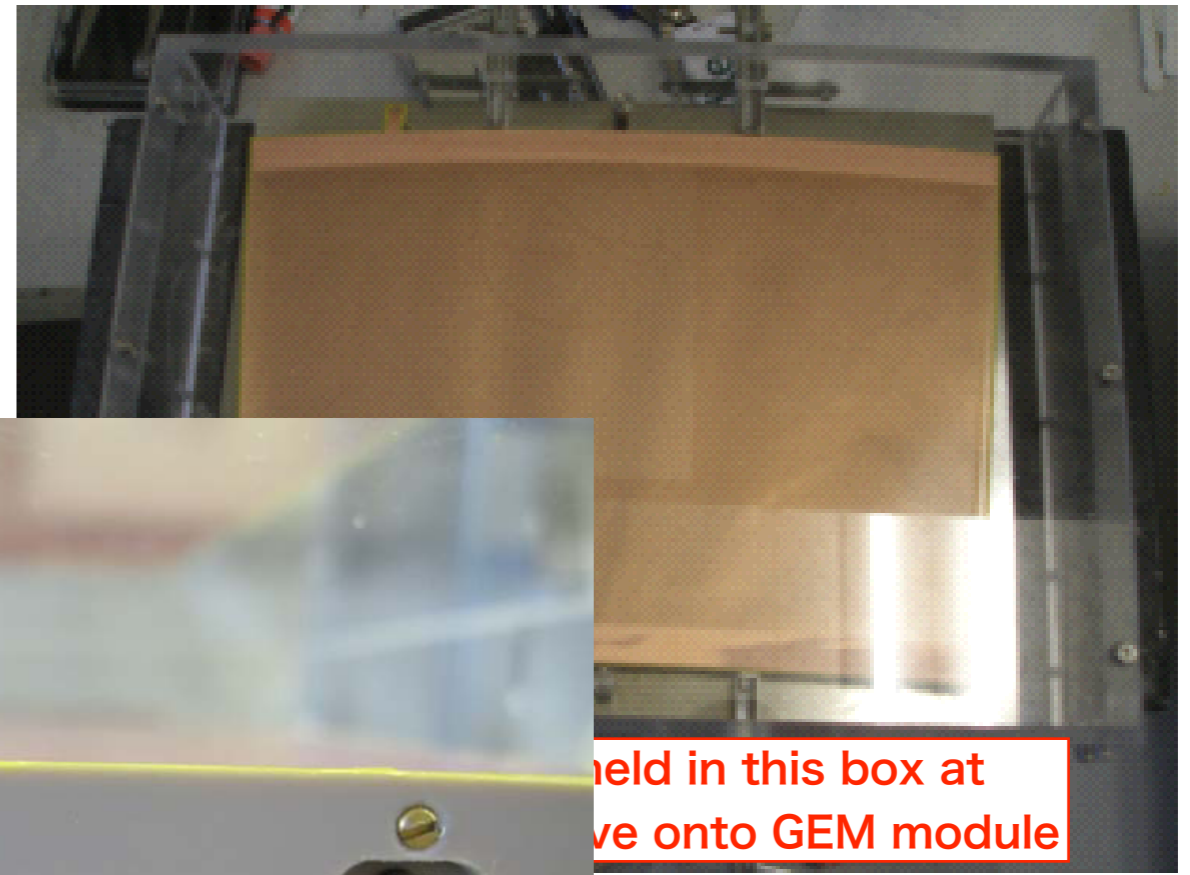

held in this box at
ve onto GEM module

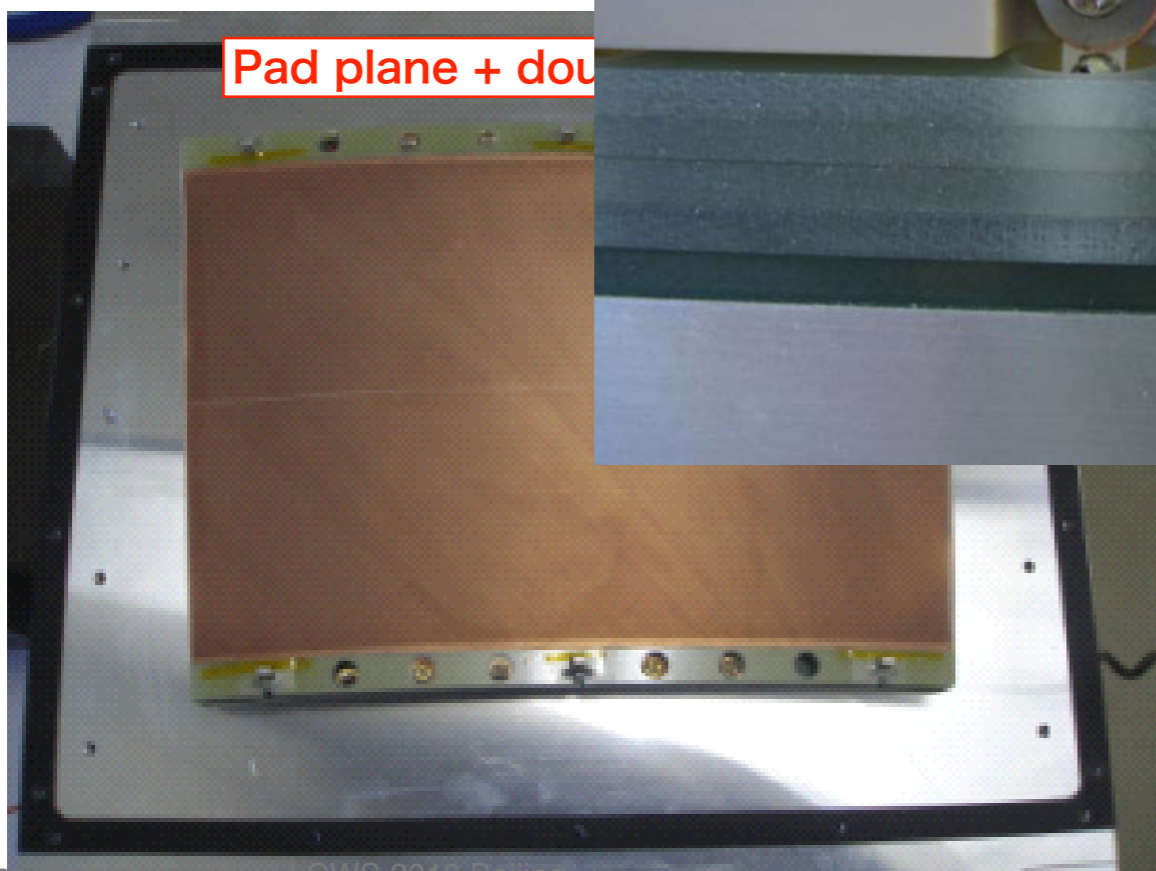

Pad plane + dou

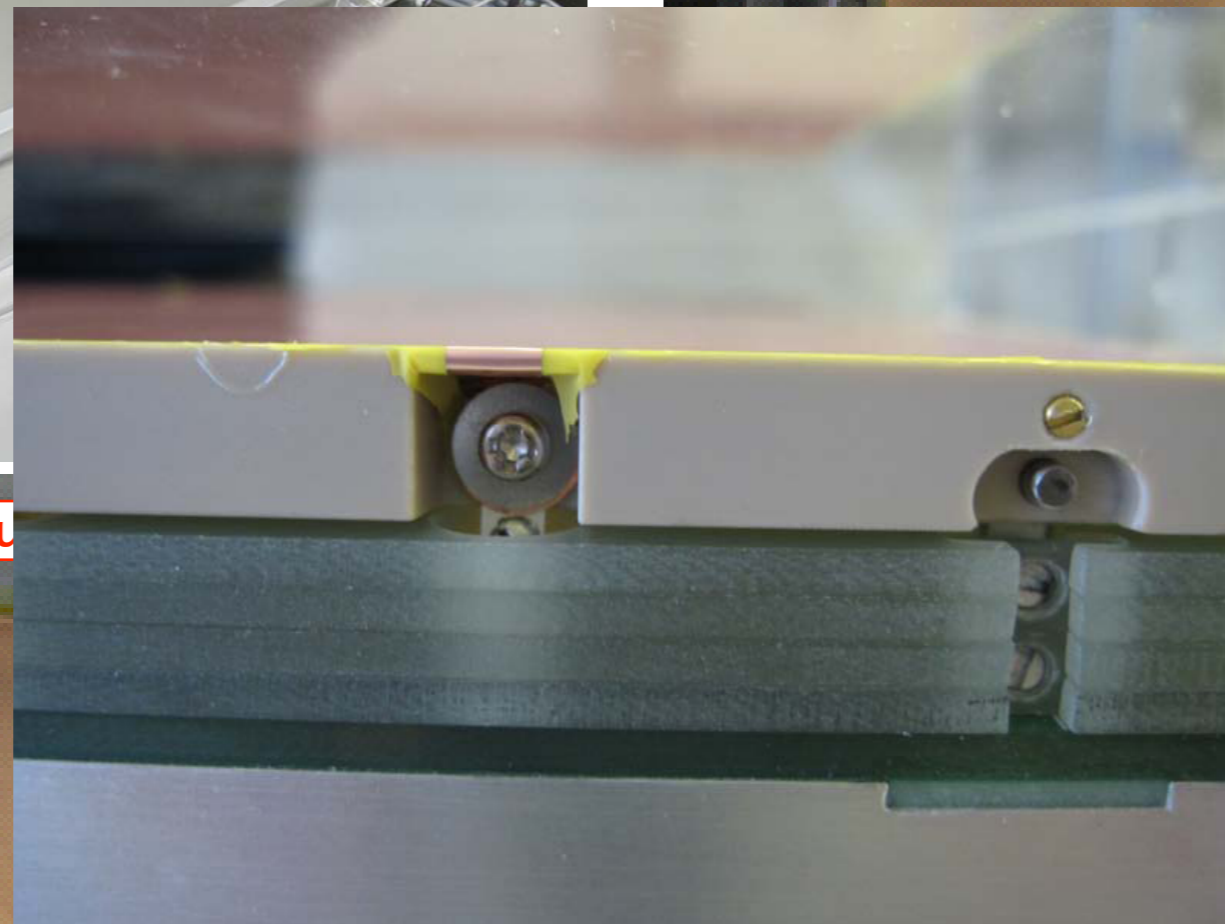

Gate is released from holding system
after mounted on the right position

GEM as a gating device

- Originally this idea comes from F. Sauli in 2006
 - Electron transmission had been measured as a function of V_{GEM} for different hole sizes
 - **Low voltage operation** may give us good electron transmission, where no gas amplification occurs
 - This result happen with only limited condition
 - It seems difficult to find good operation point under strong B field?
 - **hole ϕ should be $\sim O(100\mu\text{m})$**
 - Need proper structure to hold very thin-GEM
- **Electron transmission is in question**
 - Need to measure **under LC-TPC operation condition**
 - In our case: **ratio of hole $\sim 32\%$**

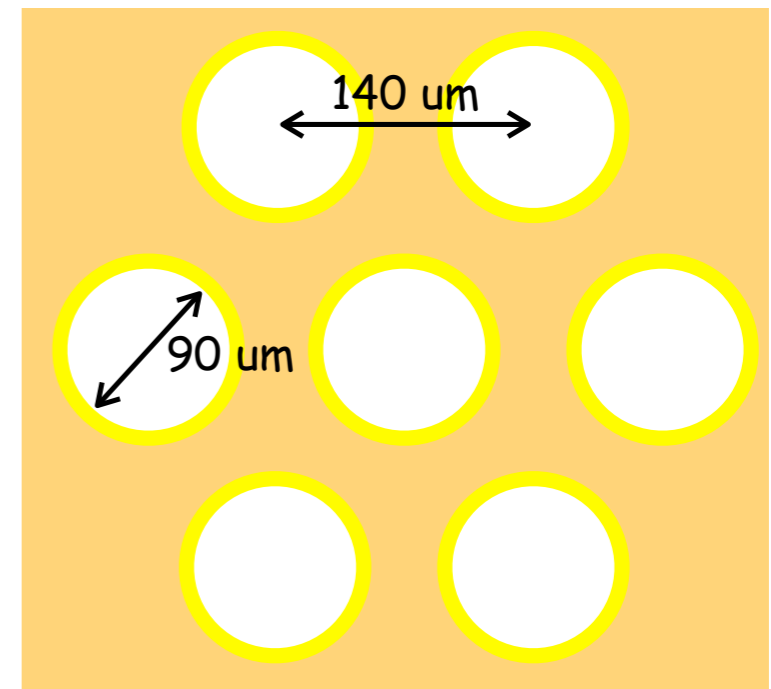
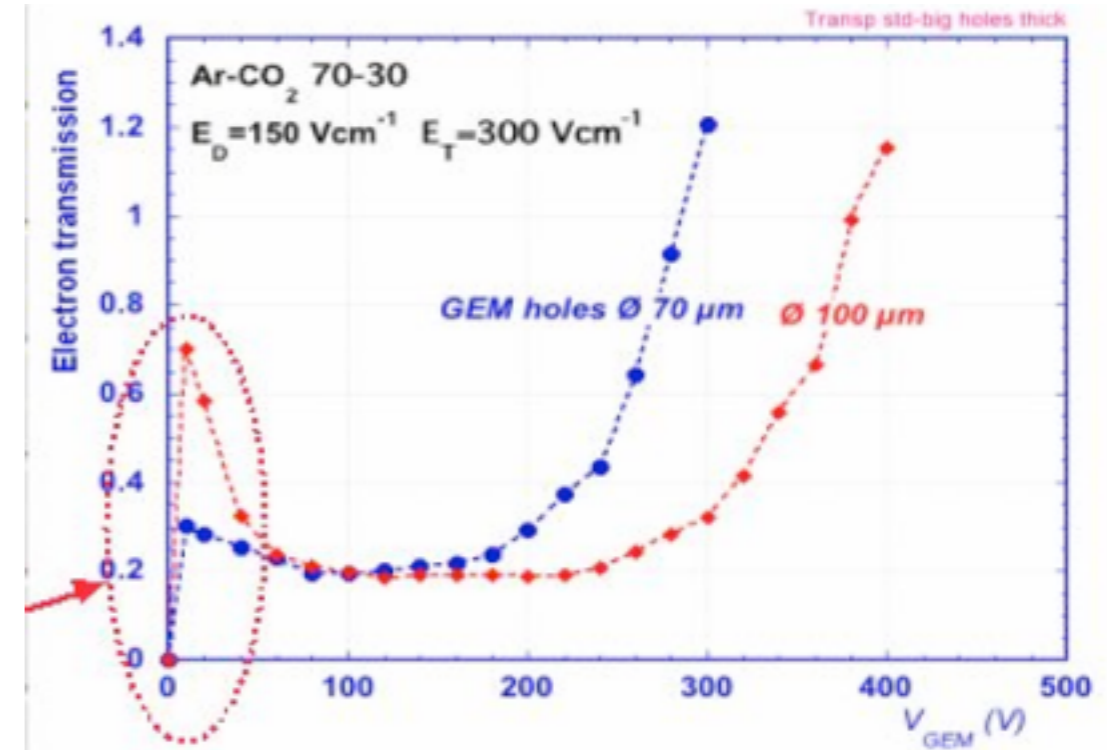

Electron transmission of GEM-gate

Method of Measurement

- Electron transmission efficiency
 - Ratio of ② to ①

② conversion at drift region

Electron loss by Gate

① conversion at transfer region

No effect by Gate
(ie. trans. eff. = 1)
 $E_D = 0 [V/cm]$

Low rate because
transfer region is
far from source

Signal
charge
spectrum
(log
scale)

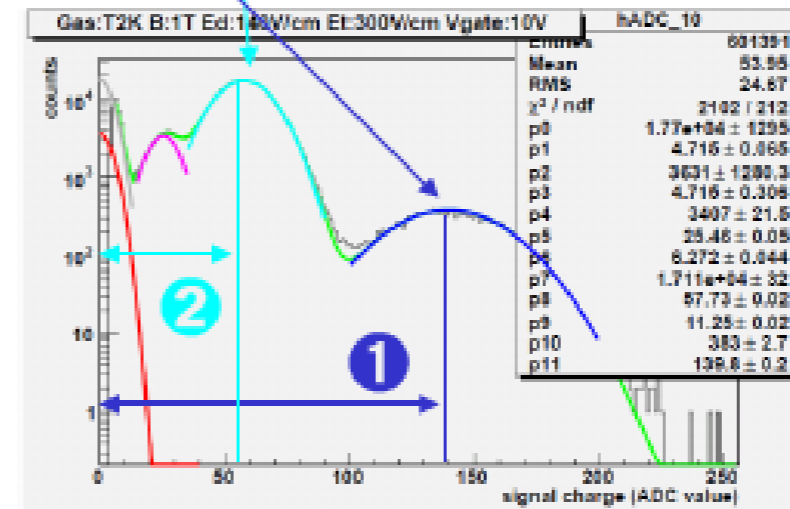
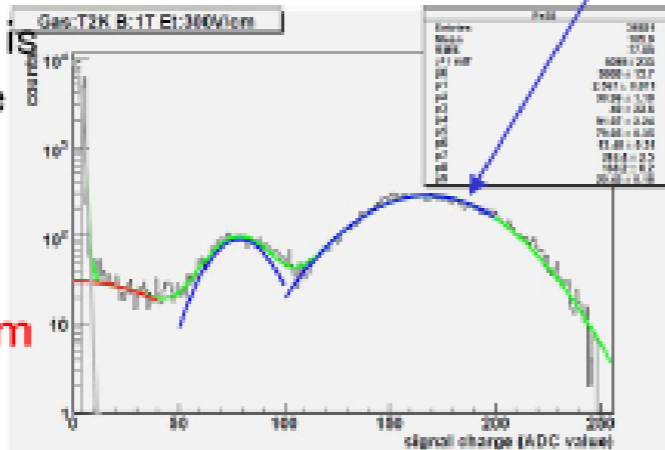

Peak
position
decided by
gaussian

6

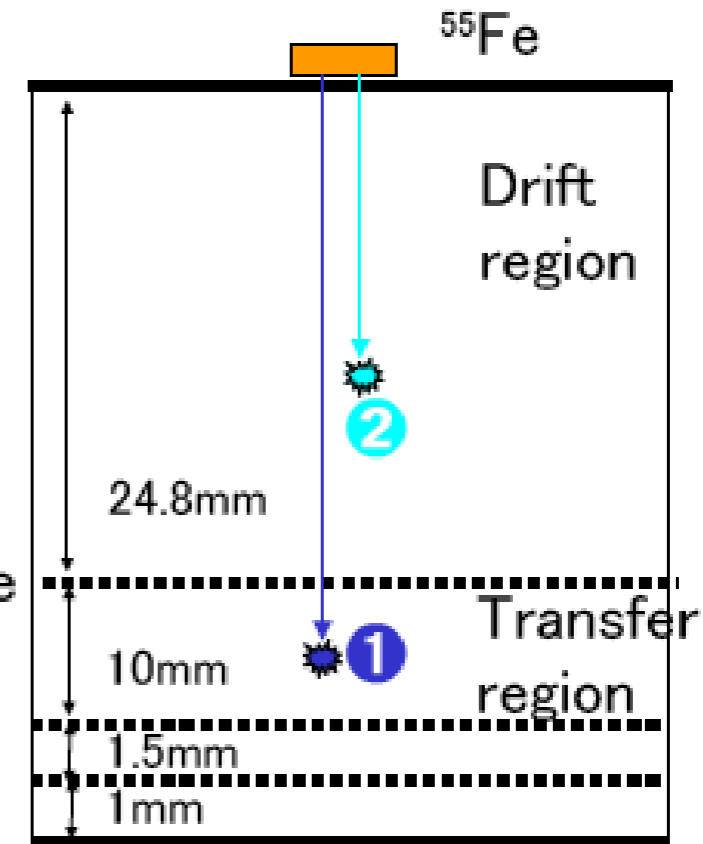

H. Kuroiwa (LCWA09)

Electron transmission of GEM-gate

$$E_D = 230 \text{ [V/cm]}$$

$$E_T = 300 \text{ [V/cm]}$$

Transmission

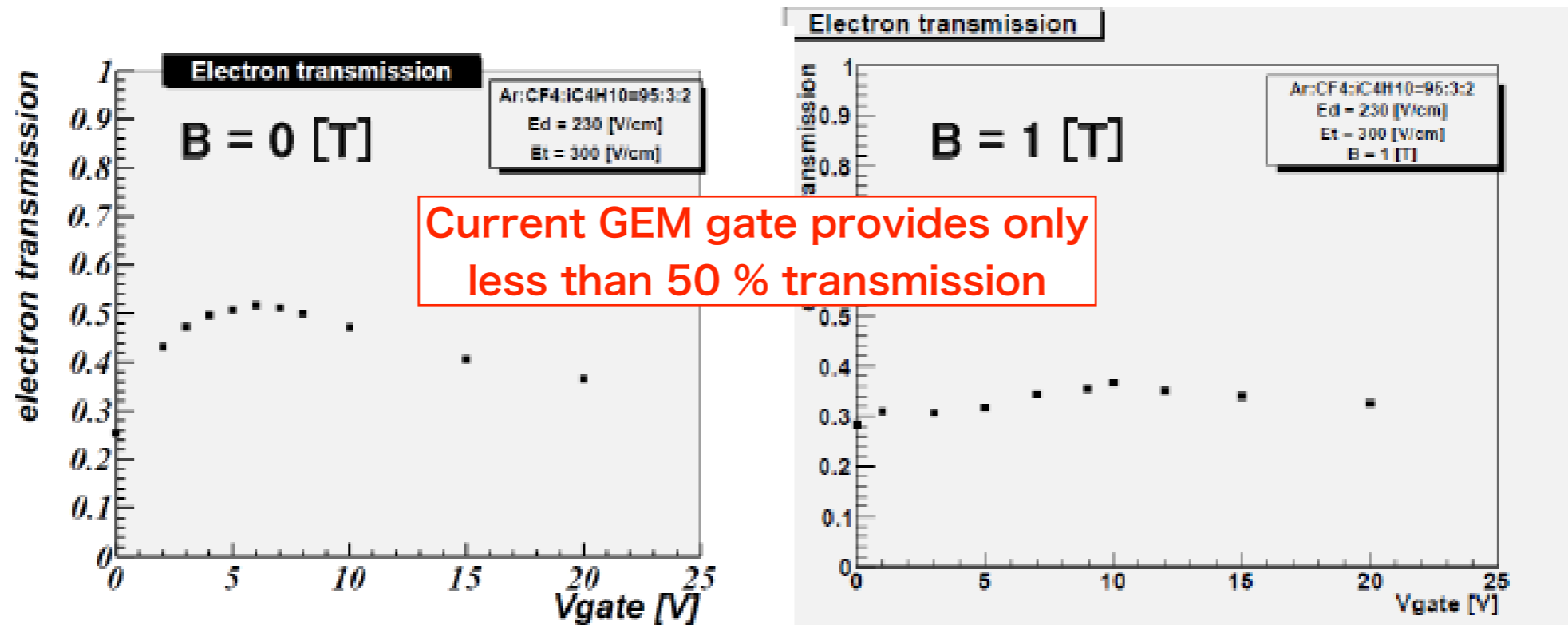

- B field dependency

High B field \Rightarrow Electrons move along B field due to lorentz angle, # of electrons into the hole decreases

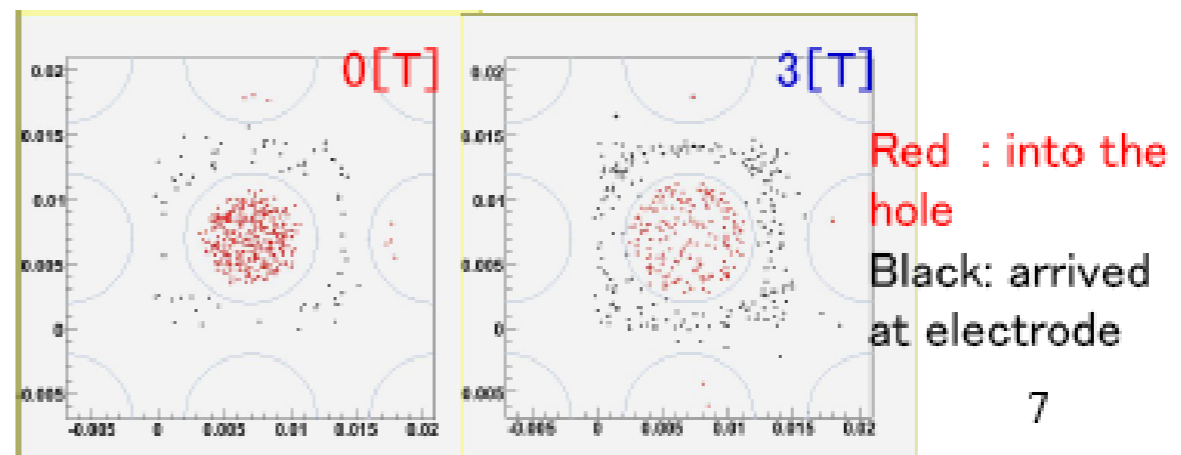

Under high B field electron may follow B field line rather than E!! -> this correspond to aperture?

H. Kuroiwa (LCWA09)

Remind: Ion feedback & gating device

- MPGDs (GEM, MicroMEGAS etc.) have potential for reducing ion-feedback by order of $10^{-2} \sim 10^{-3}$
 - In the case of Gain 10^3 , number of feedback ions is comparable that from primary ions
 - The same number of ions are condensed into a few mm disc instead of whole TPC volume from primary
 - It has been an **outstanding question** how this dense disc affect to drifting electron
- Anyway simulation study is critical for the LC-TPC conceptual/baseline design!
- In parallel with this, Asian group continues developing gating devices for the LC-TPC
 - Have studied GEM as gate since it may fit easily with our GEM module
 - Beneficial detachable GEM-gate devices even if the electron transmission is so low!?
 - Might be a solution under high-background environment (e.g. initial stage of the experiment)

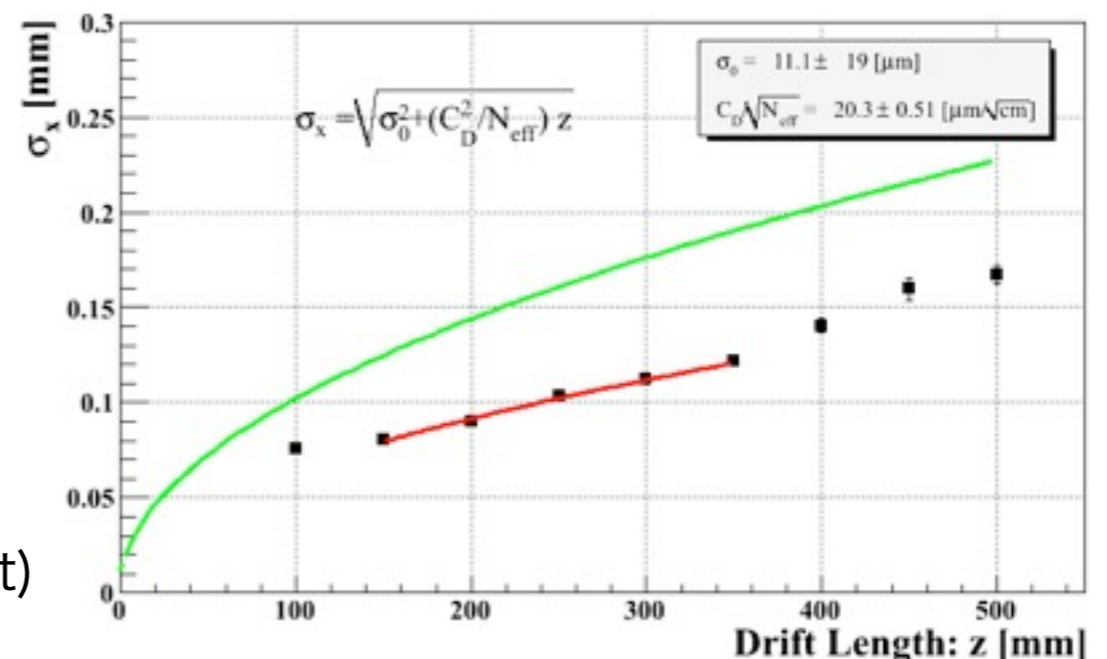

Status of readout electronics

The front end card (FEC)

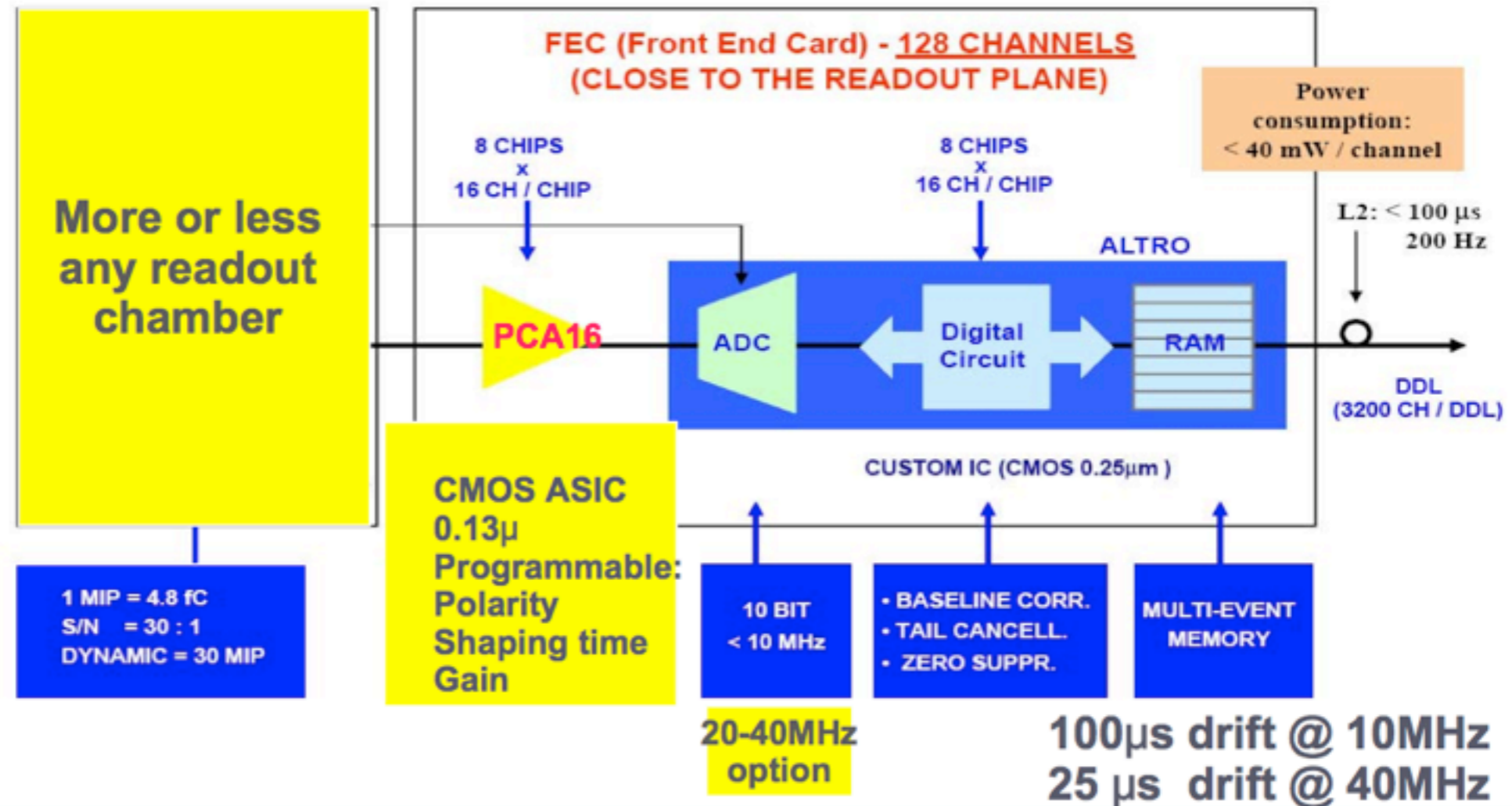
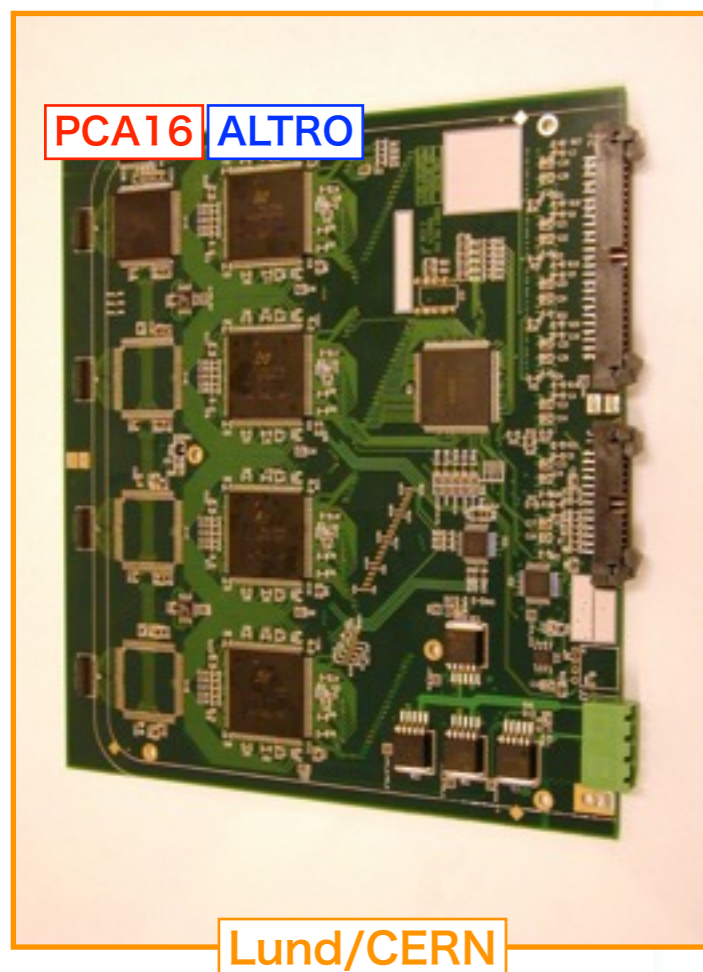

• PCA16

- Programmable charge sensitive amplifier
- Gain: 12, 15, 19, 27 mV/fC
- Shaping time: 30, 60, 90, 120 ns
- Can also be run in non-shaping mode with variable decay time

• ALTRO

- ADC digitizes the PCA16 analogue signal of 1.2 V to a 10 bit digital value
- Sampling frequency: 20 MHz (40 MHz)
- Buffers data while waiting for store/discard decision
- Perform pedestal subtraction and zero suppression

Pad \leftrightarrow FEC implementation in LP1

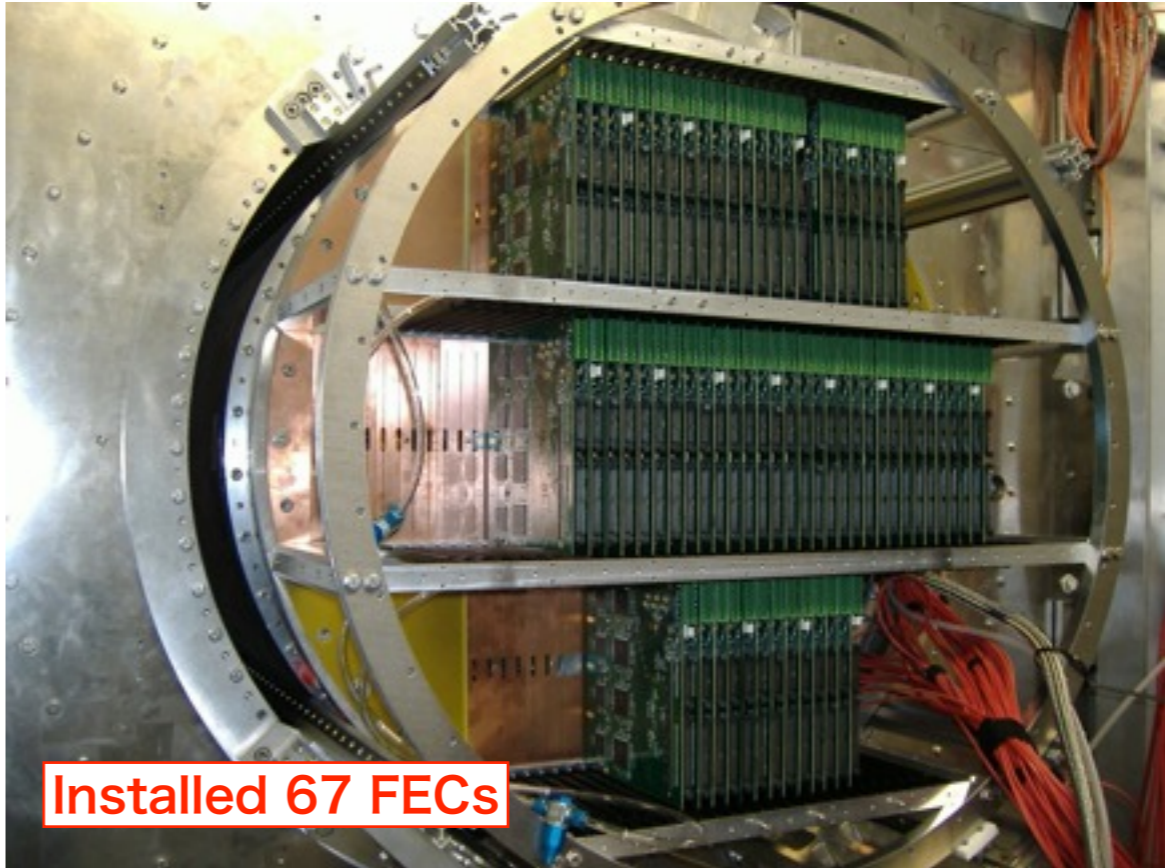
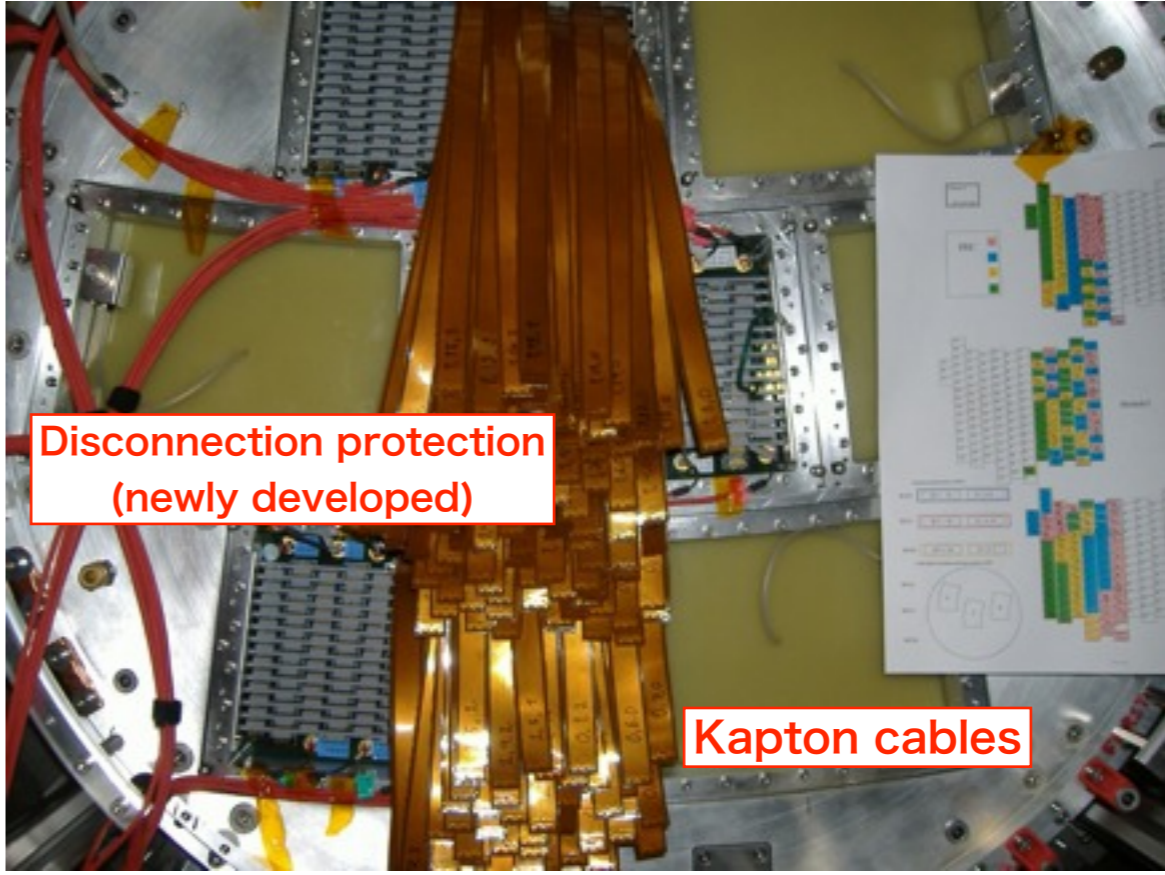
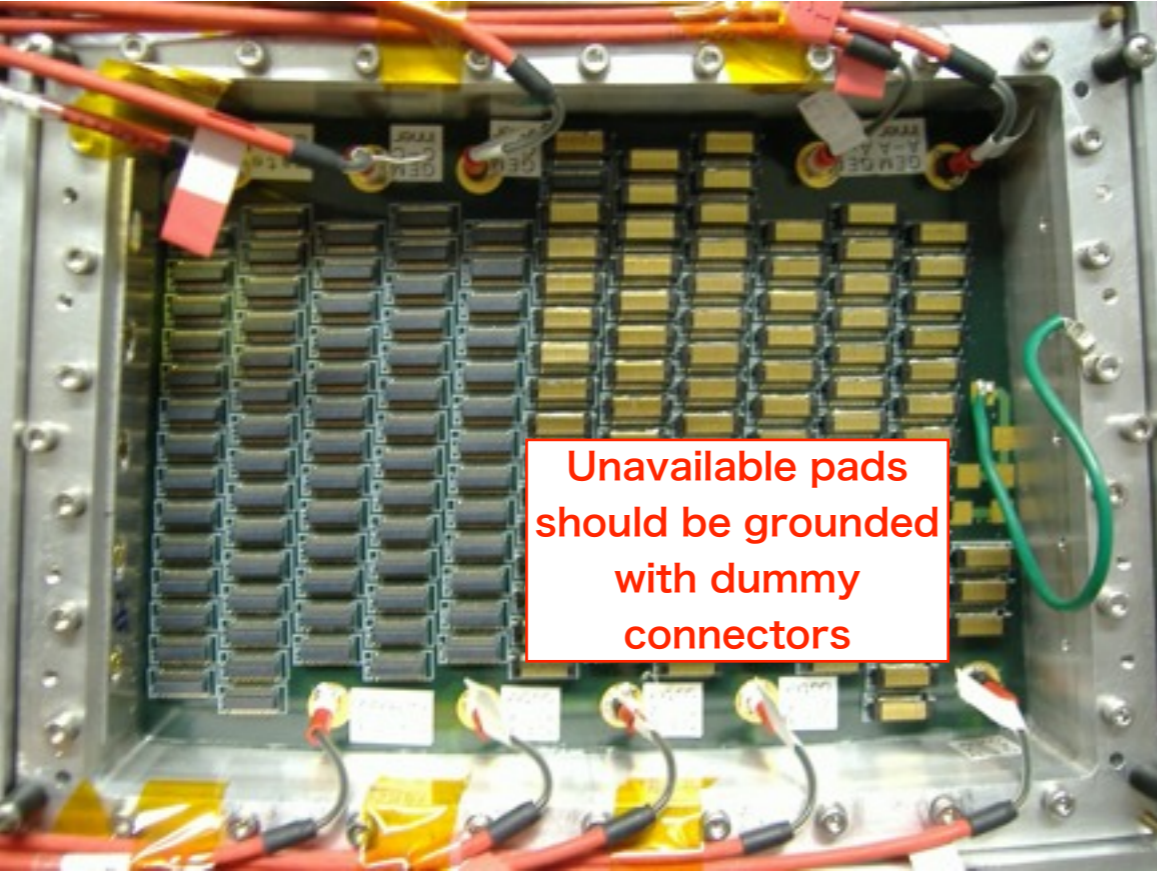

Integrated ~10k readout electronics

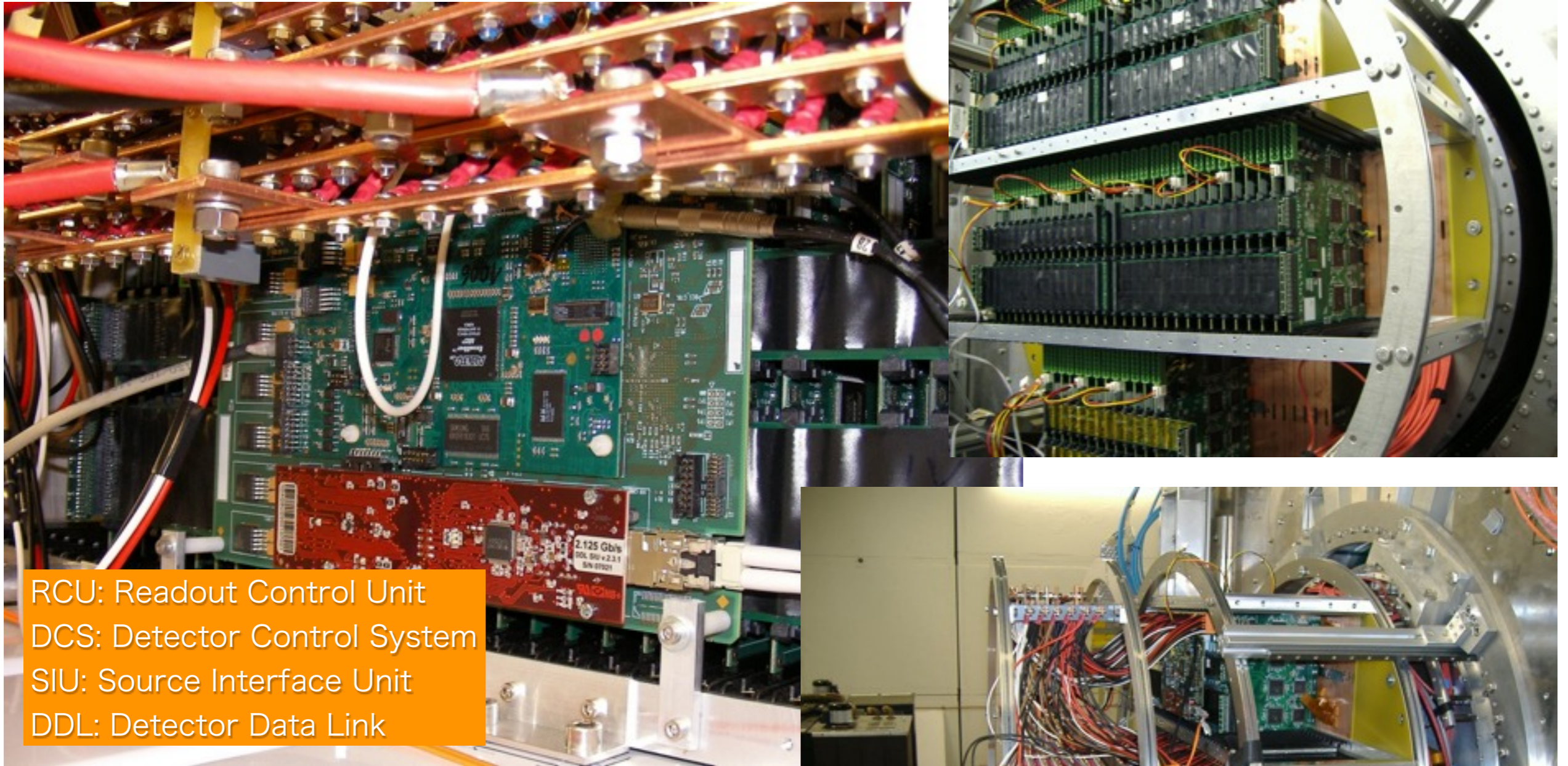

RCU: Readout Control Unit
DCS: Detector Control System
SIU: Source Interface Unit
DDL: Detector Data Link

- Every RCU can take 32 FECs (3 RCUs)
- Temperature sensors for the FECs have been developed
- A new cooling system was installed

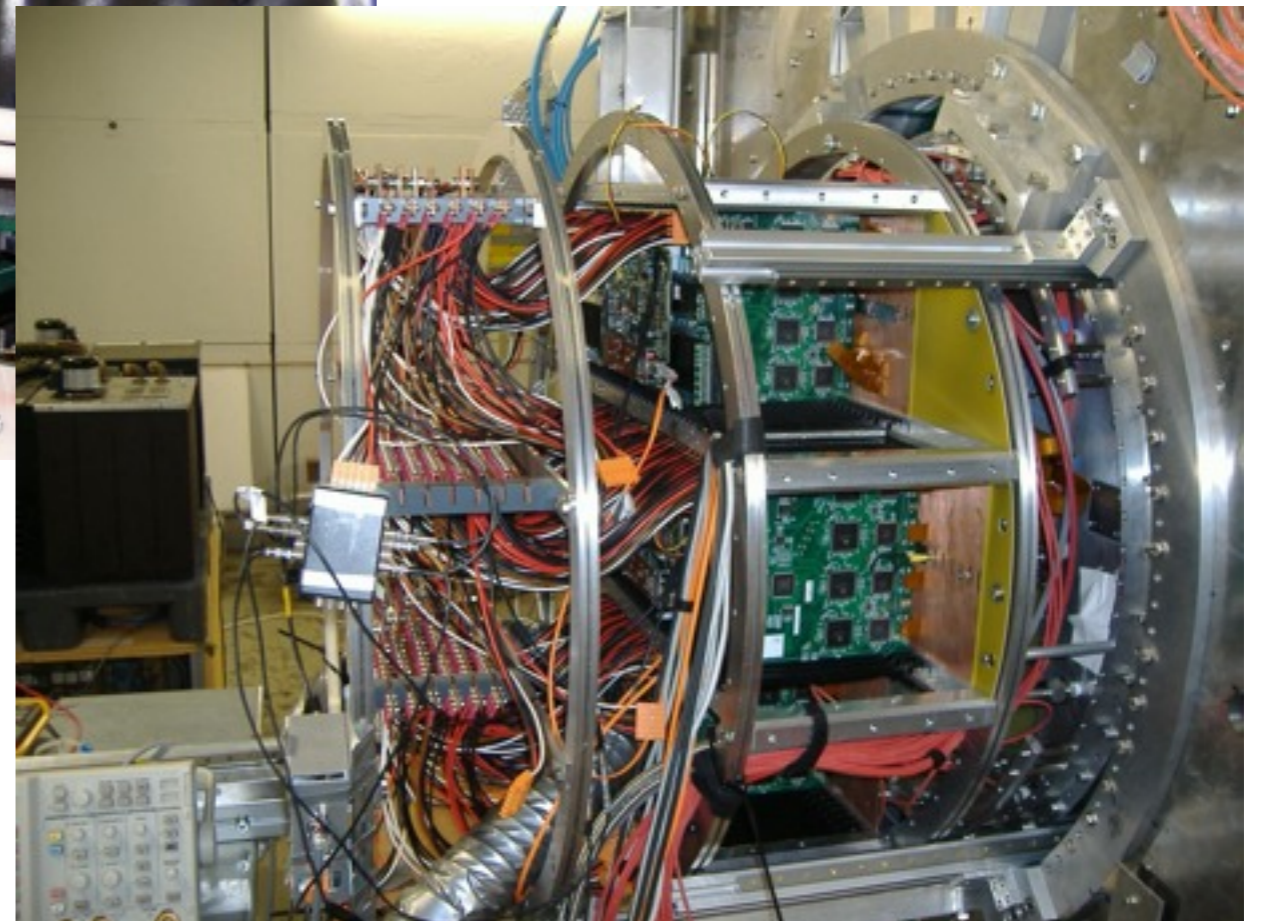

Integrated ~10k readout electronics

RCU: Readout Control
DCS: Detector Control
SIU: Source Interface
DDL: Detector Data Li

Run 7231 Event 0

View from Inside

Module5

Module3

Module0

- Every RCU can t
- Temperature sen
- have been developed
- A new cooling system was installed

Status of reconstruction software

Motivation for our software R&D

- LC-TPC LP1 testbeam data analyses
 - Multi-module tracking in the presence of significant distortion due to non-uniform B-field (PCMAG ~ Anit-DID field in the ILC environment); need to establish the correction procedure
 - Resultant momentum resolution to be consistent with our design goal when extrapolated to ILD-TPC
 - Effects of module boundaries
 - Gating in the multi-module environment
- Feed back to ILD-TPC design
- Feed back to ILD tracking software
 - For the moment, the ILD tracking code is FORTRAN (based on LEP2 tracking code). It is useful if we can replace it with the C++ code with higher functionalities imported from the LP1 software

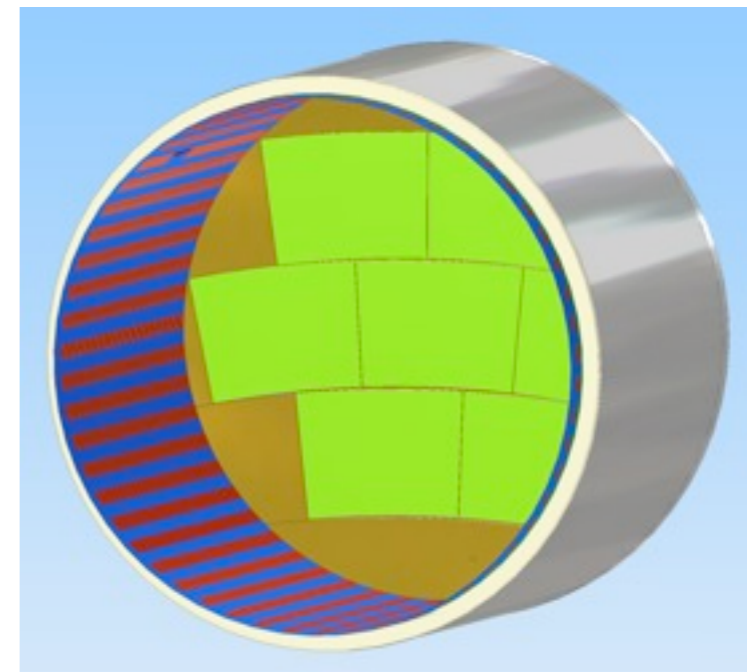

What is MarlinTPC ?

- Marlin based **simulation**, **digitisation**, **reconstruction** and **analysis** code for the TPC
- **Goal**: To get a **highly modular reconstruction and analysis framework** for ILC TPC R&D with standardized interfaces between its modules
 - This ensures that despite of the large diversity of readout structures, electronics, amplification system, etc. much **code can be shared among the groups** and that different algorithms developed by different people or data taken by different groups can be easily compared
- MarlinTPC is **an implementation of the TPC data model** (LCIO provides data class as the Event data model)

Data Class	Description
LCEvent	Contains collections of one event (bunch crossing)
LCCollection	Collection of data classes of a certain type e. g. TrackerRawData
MCParticle	Particle from the MC generator
SimTrackerHit	Charge deposition in the detector
TrackerRawData	ADC values from the TPC
TrackerData	Calibrated raw data
TrackerPulse	Charge and time of a pulse in one electronics channel
TrackerHit	3D hit with charge information
Track	Helix parametrisation of the fitted track
LCGenericObject	User defined data class

MarlinTPC reconstruction chain

- Highly modular and independent of specific detector

- Prototypes and large ILC detector TPCs
- MicroMEGAS, GEMs and Anode Wires

- Pad and Pixel (TimePix) readout
- ADC and TDC read-out electronics

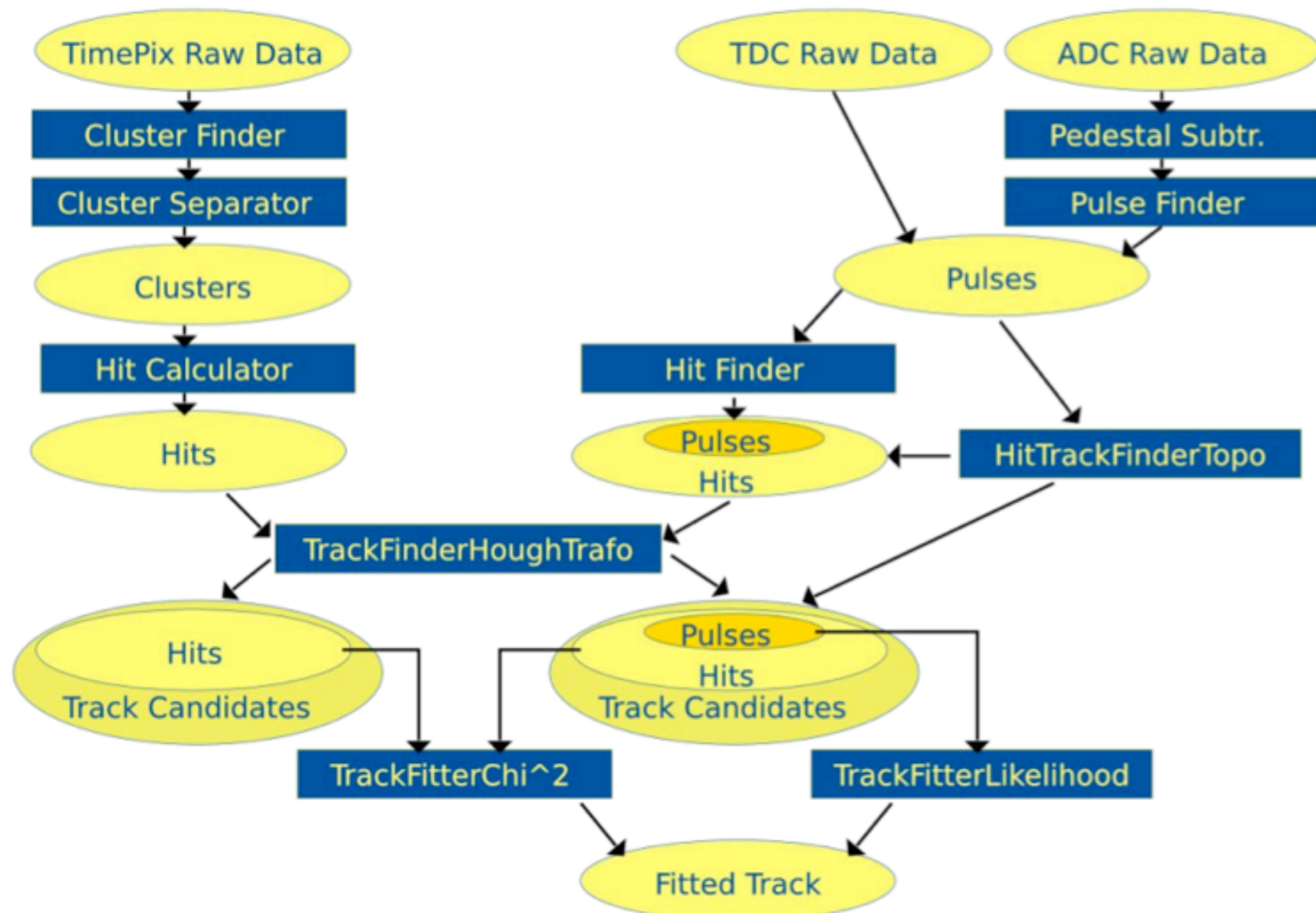

Reconstruction for Asian GEM module

- List of processors (needed for Asian GEM module data reconstruction)
 - ConditionsProcessor (TPCConditions, TPCPedestal & TPCChannelMapping)
 - ▶ Provides access to conditions data transparently from LCIO files or a databases, using LCCD
 - ▶ At the moment TPCChannelMapping only
 - TrackerRawDataToDataConverterProcessor
 - ▶ Converts the TrackerRawData to TrackerData without processing the values
 - ADCPulseConverterProcessor
 - ▶ Convert zero-suppressed ADC raw data to pulses
 - ChannelMapperProcessor
 - ▶ Changes cellID to map from hardware channel numbers to software/logical channel numbers

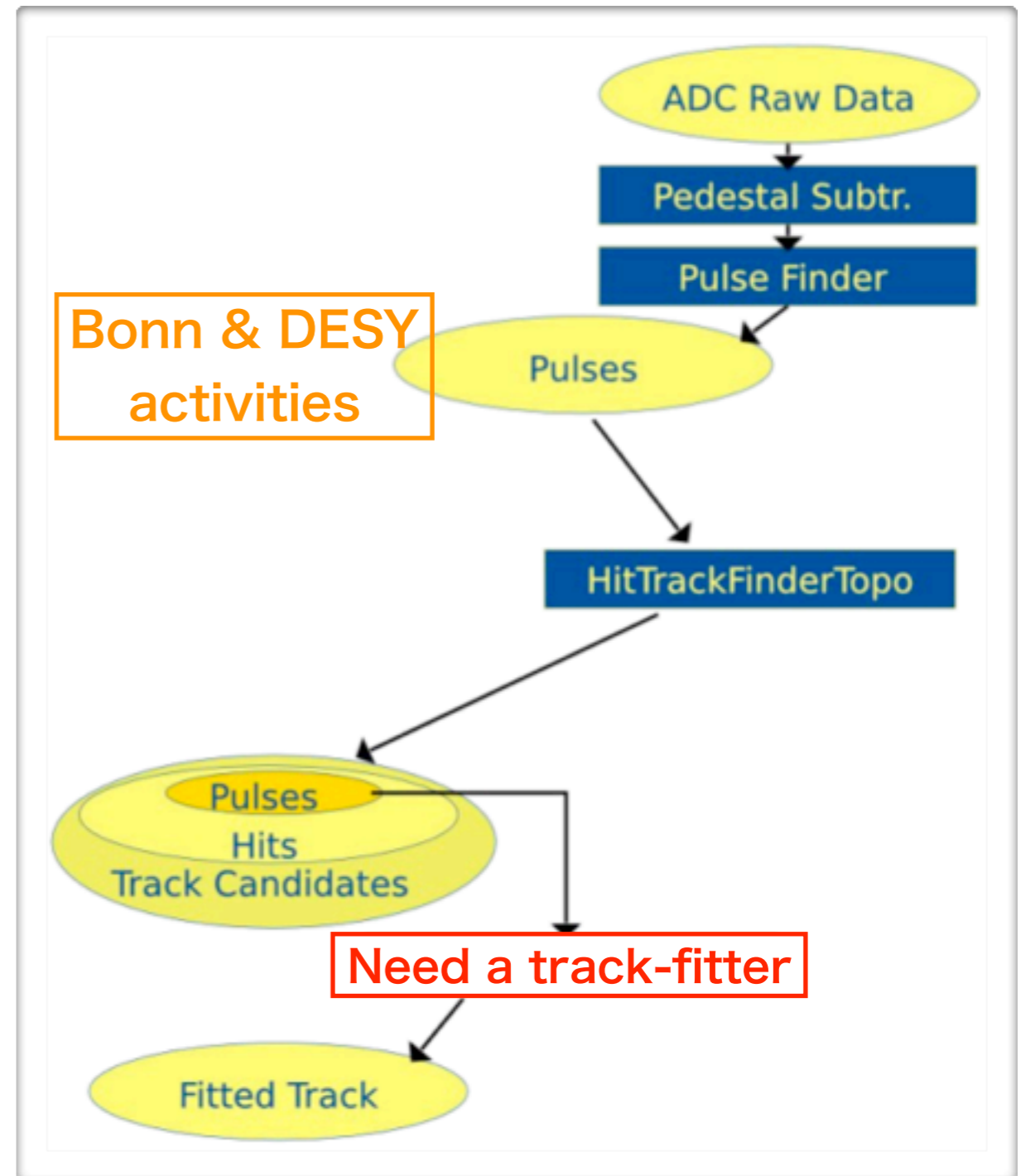

Reconstruction for Asian GEM module (cont)

- List of processors (needed for Asian GEM module data reconstruction)
 - HitTrackFinderTopoProcessor
 - ▶ Calculates TrackerHits from TrackerPulses
 - TrackSeederProcessor
 - ▶ Calculates seed track parameters from in the TrackerHits in the track candidates collection
 - **TrackFitterKalmanProcessor**
 - ▶ **Our work!!**
 - HepRepOutputProcessor
 - ▶ Generates a HepRep Output file for a HepRep based event display program
 - ▶ HepRep XML file which can be displayed e. g. with Wired/JAS3 or HepRApp (.jar)
 - LCIOOutputProcessor
 - ▶ Writes the current event to the specified LCIO output file
 - ▶ Needs to be the last Active Processor
 - ▶ Split output file if size in 1992294 kB exceeds

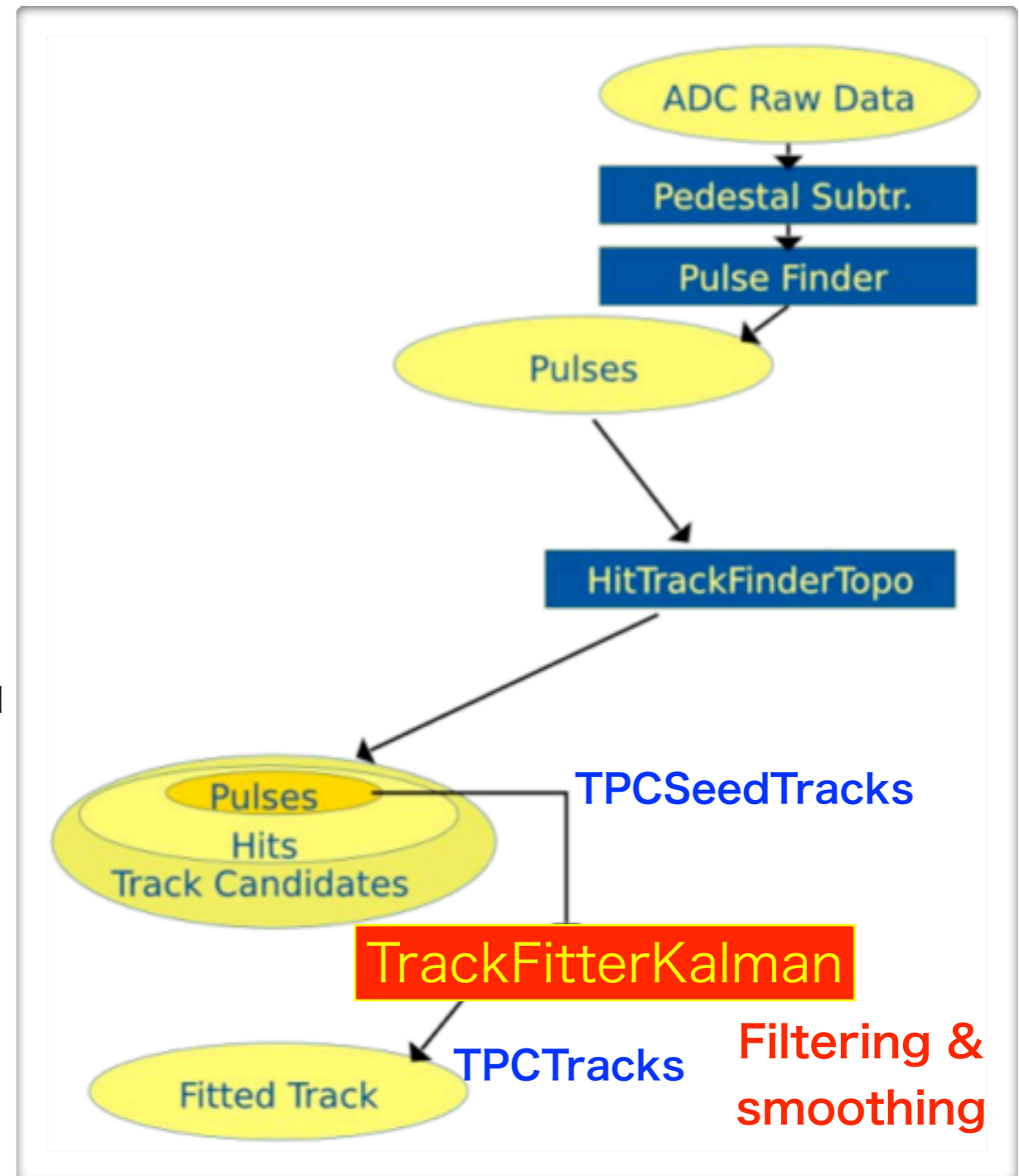

Reconstruction for Asian GEM module (cont)

- List of processors (needed for Asian GEM module data reconstruction)
 - **HitTrackFinderTopoProcessor**
 - ▶ **Trying to replace w/ combinatorial KF scheme**
 - TrackSeederProcessor
 - ▶ Calculates seed track parameters from in the TrackerHits in the track candidates collection
 - TrackFitterKalmanProcessor
 - ▶ Our work!!
 - HepRepOutputProcessor
 - ▶ Generates a HepRep Output file for a HepRep based event display program
 - ▶ HepRep XML file which can be displayed e. g. with Wired/JAS3 or HepRApp (.jar)
 - LCIOOutputProcessor
 - ▶ Writes the current event to the specified LCIO output file
 - ▶ Needs to be the last Active Processor
 - ▶ Split output file if size in 1992294 kB exceeds

Details: Bo Li's LCWS10 talk (on 29th March)

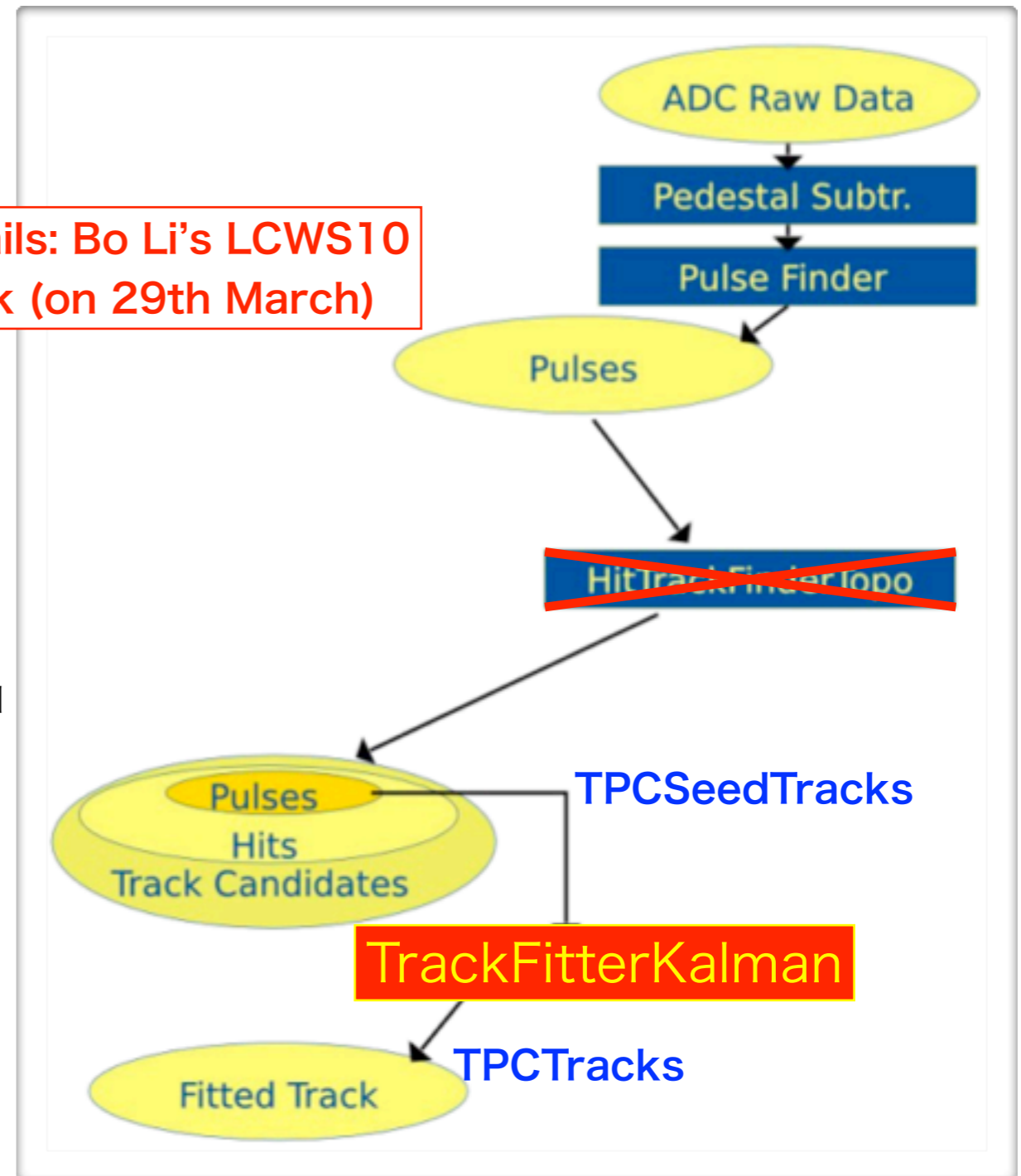

Summary / Plan

- Asian GEM module for LP1 (double thick-GEM + gate-GEM w/ ~10k ch ALTRO elec.) is in preparation at DESY-II T24
 - Commissioning work continues; expect complete data-taking in April - Summer 2010
- GEM-gating
 - Asian group has studied GEM as gate for LP1 modules and continues developing gating devices for the LC-TPC
 - Simulation study for ion feedback is critical for the LC-TPC conceptual/baseline design!
- Readout electronics
 - ~10k readout electronics are already installed by Lund U. and ready
- Data reconstruction software
 - Incorporated Kalman filter technique into MarlinTPC
 - Tested topological track-finder + Kalman filter based track fitter chain
 - Combinatorial Kalman filter under development (Bo Li's talk in LCWS10)
 - Handling inhomogeneous magnetic field as next important task

Backup slides

Longitudinal Diffusion
Drift Velocity

Transverse Diffusion 0T
Transverse Diffusion 1T
Transverse Diffusion 3T
Transverse Diffusion 4T

Ar-CF₄-iC₄H₁₀_95-3-2

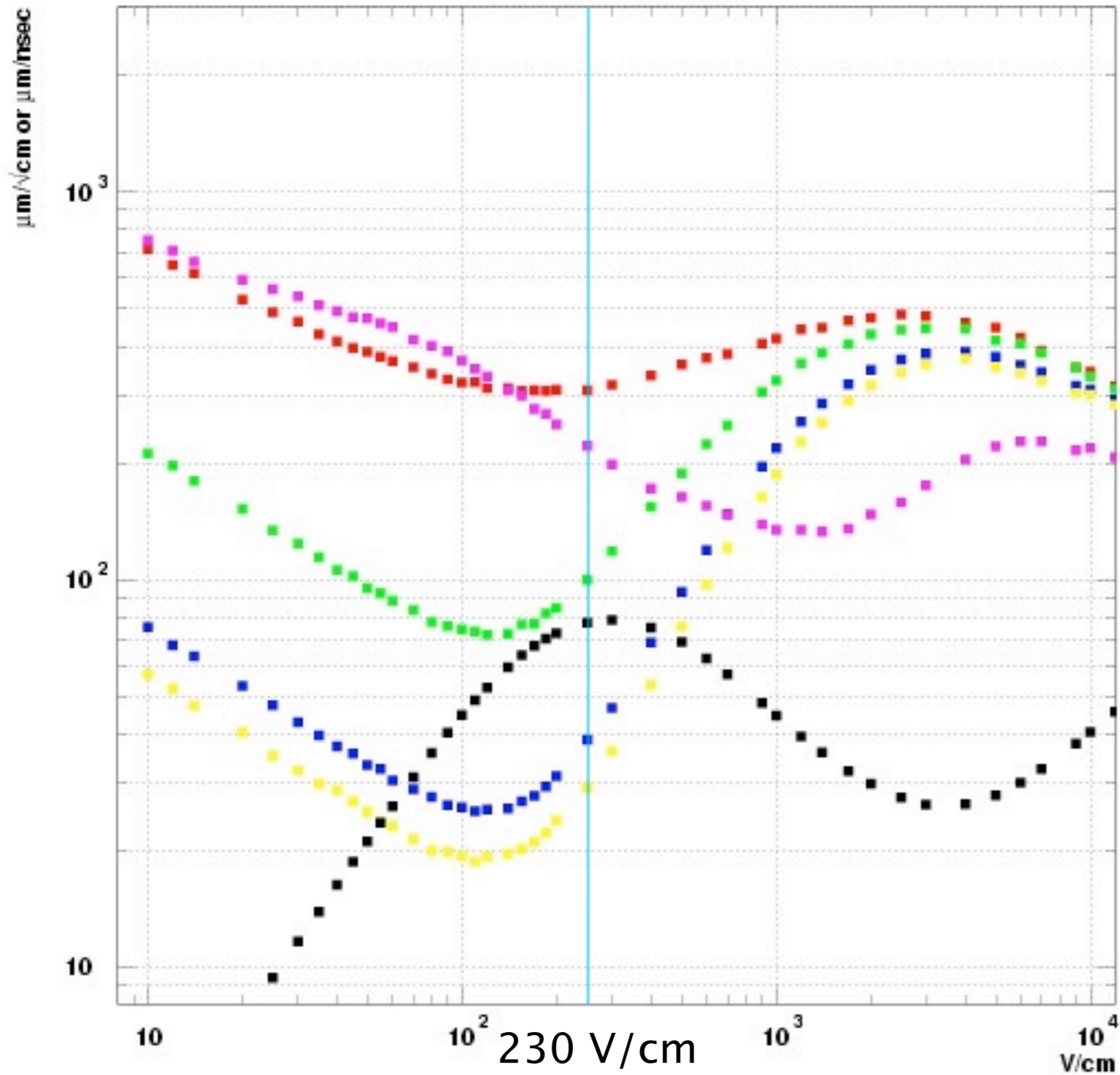

Drift Velocity
Transverse Diffusion 1T

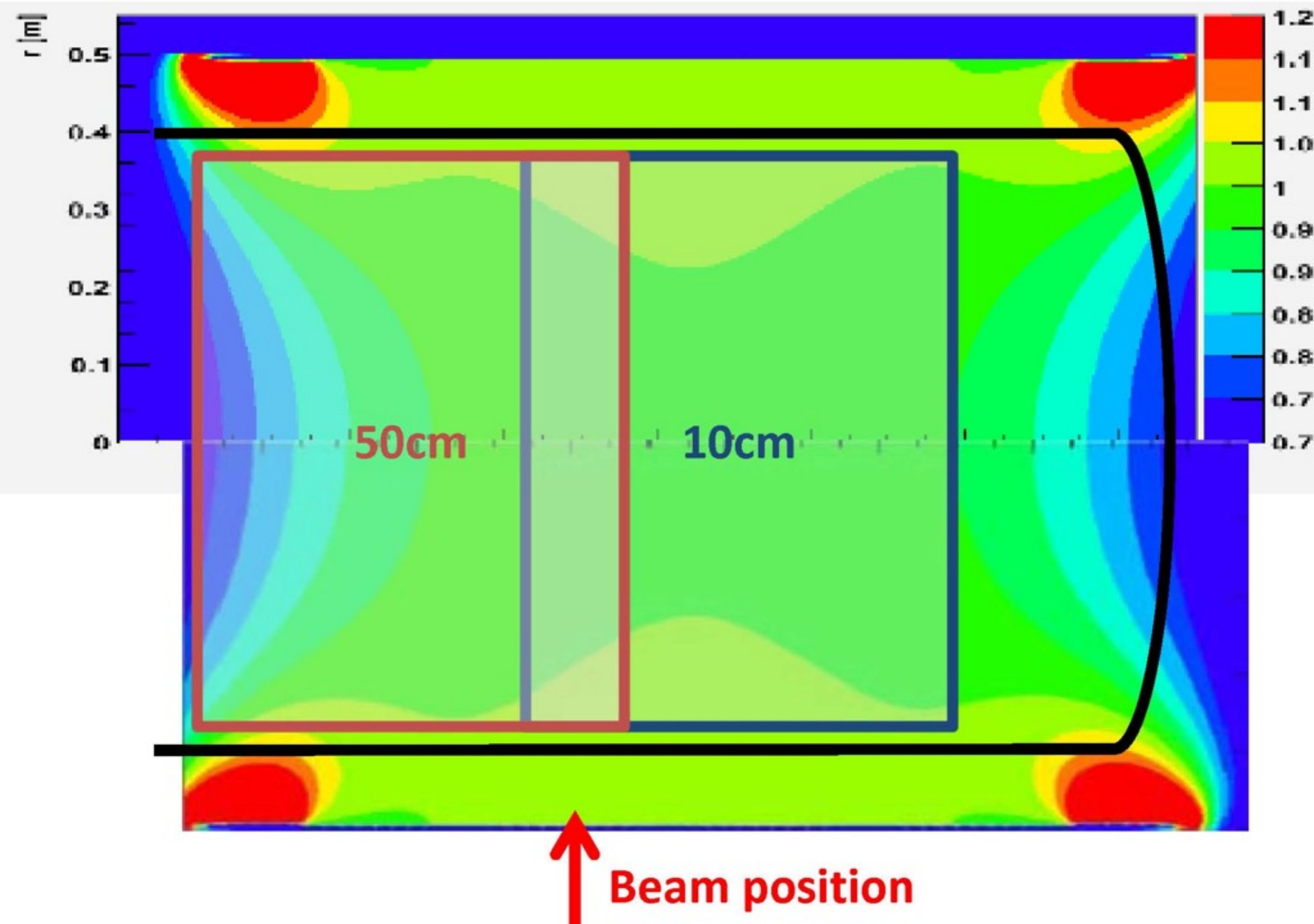

Lund standalone DAQ (ALTRO-FEC)

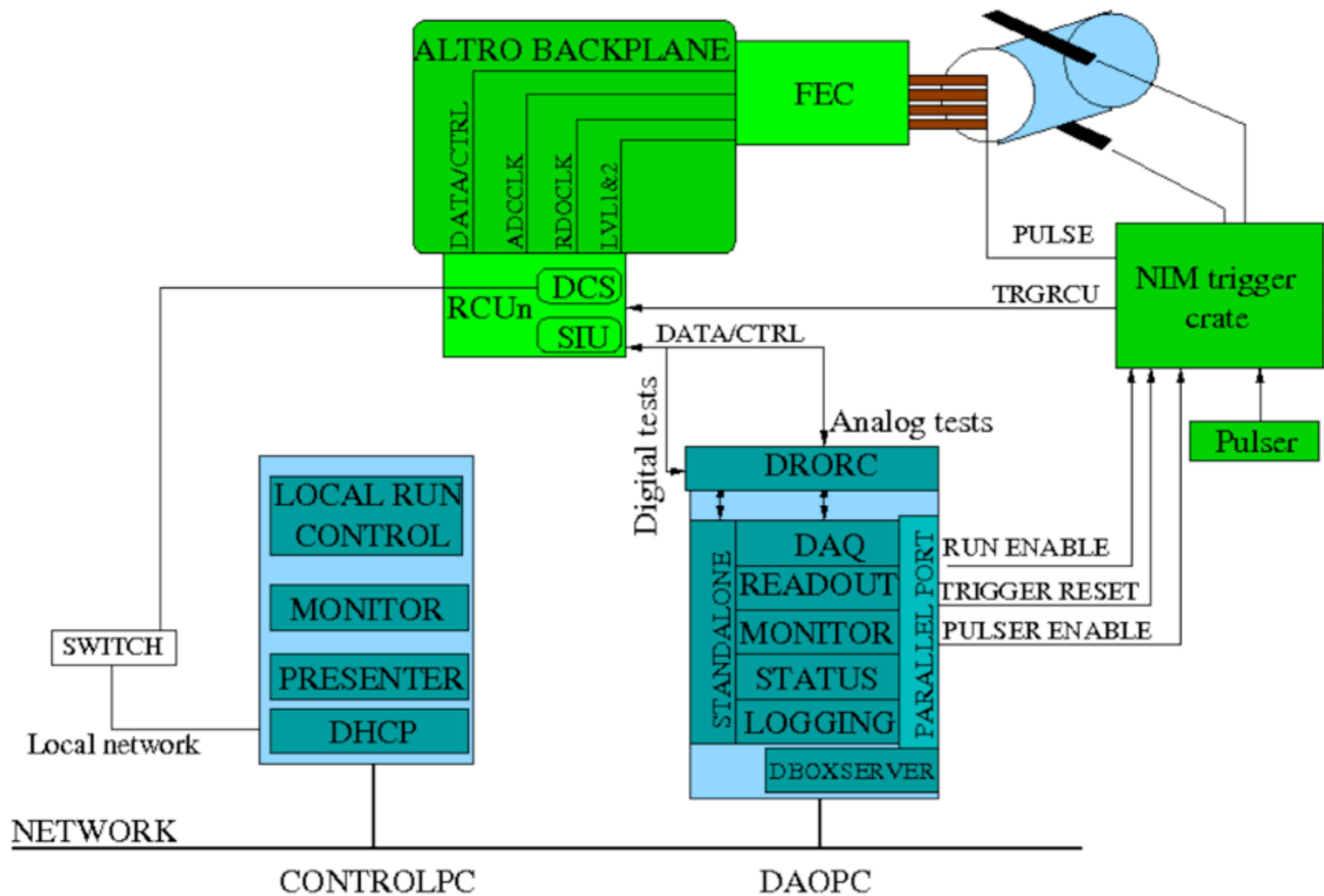

Why Kalman filter track-fitting ?

- Need to take into account the inhomogeneous field (not only the LP1 condition but also the ILC condition due to Anti-DID field)
 - Track model can change site to site which allows B-field variation along a particle trajectory!
- No need for calculation of Matrix inversion
 - In general the matrix inversion takes time under the space point measurements of ~ 200 sampling!
- Track connection between sub-detectors (multiple scattering and energy loss in the boundaries) can be considered
- Beneficial to calculate geometric mean resolution by using “Inverse Kalman filter” (in/out target row hit)

Typical Procedure for Tracking

outermost

innermost

$$(1) \rightarrow (2) \rightarrow \dots \rightarrow (k-1) \rightarrow (k) \rightarrow \dots \rightarrow (n)$$

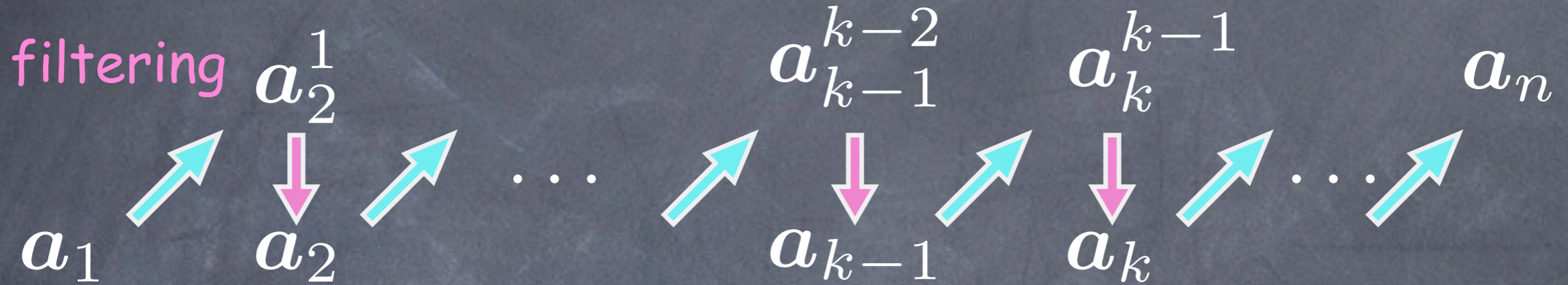

prediction

$$(1) \dots \leftarrow (k) \leftarrow (k+1) \leftarrow \dots \leftarrow (n-1) \leftarrow (n)$$

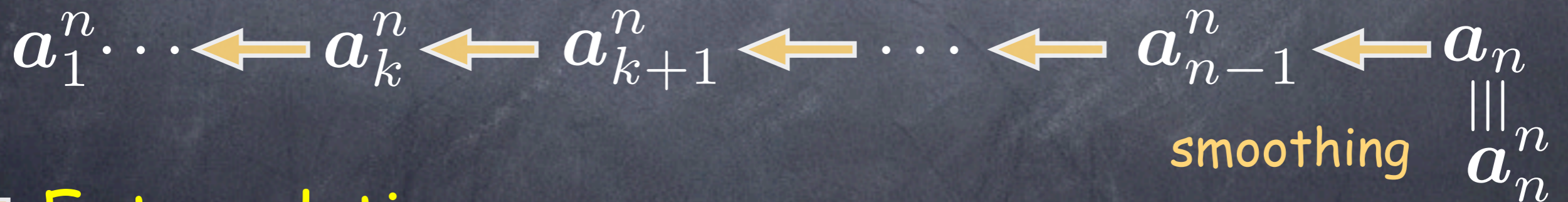

Extrapolation

$$a_n \rightarrow a_{n+1}^n = a_{IP}$$

prediction

$$a_0^n = a_{cal} \leftarrow a_1^n$$

prediction

■ Alignment, Resolution Study, etc.

Need to eliminate point (k)

(1) $\dots\dots\dots$ ($k - 1$) (k) ($k + 1$) $\dots\dots\dots$ (n)

↓ Inverse Kalman Filter

\mathbf{a}_k^{n*} Reference Track Param.



$\mathbf{h}_k(\mathbf{a}_k^{n*})$ Expected Hit Position



$\mathbf{r}_k^{n*} = \mathbf{m}_k - \mathbf{h}_k(\mathbf{a}_k^{n*})$ Residual to Look At