



Mechanics for ECAL W/Si

LPSC / LLR France

Julien Giraud (giraud@lpsc.in2p3.fr)



Julien Giraud – March 11th, 2010

Summary

END CAP structure: composite alveoli molding test

COOLING (Module => Global Cooling System)

LLR composite structure (EUDET)

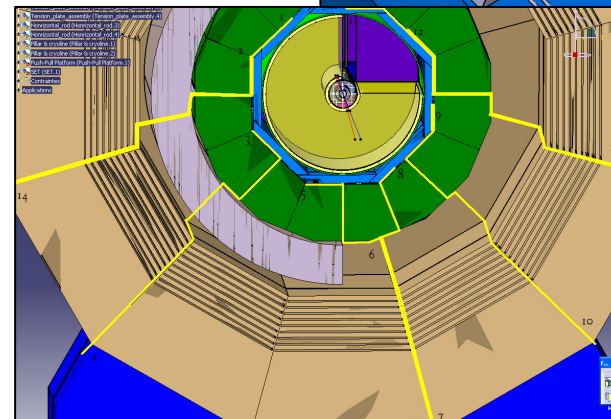
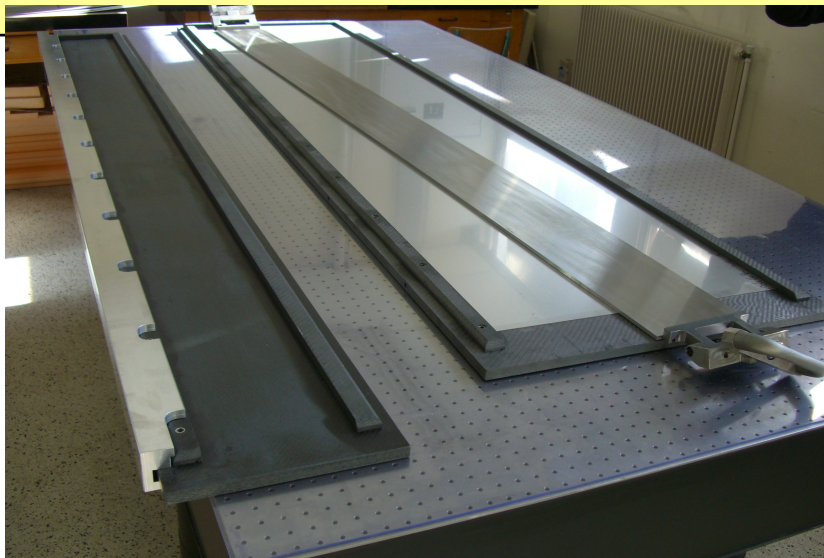
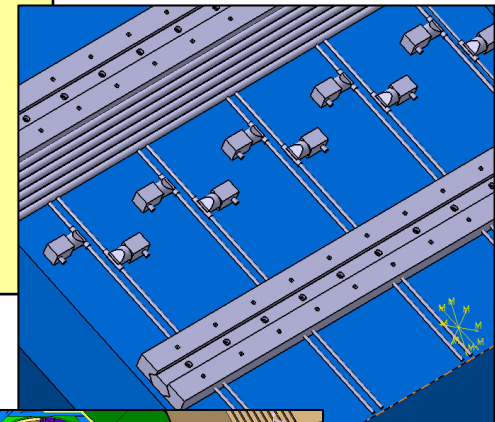
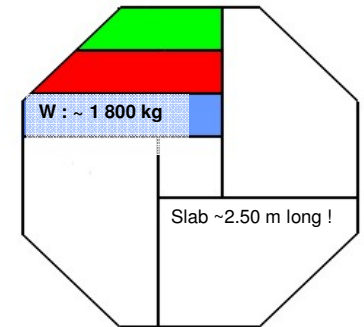

END CAP

- Today, with the barrel's demonstrator and EUDET, the process for composite structure has been validated, with a built layer module width based on 182.1 mm for EUDET, and 1,50 m long...

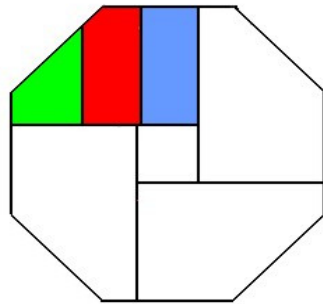

Design 1

(possibility of cracks)

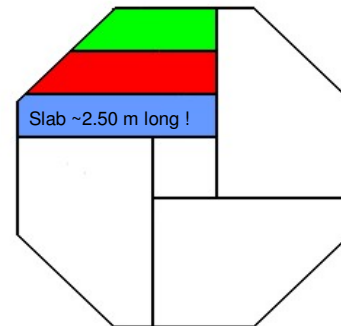
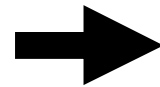

Design 2

(ok / cracks- but technology...)



Construction of 2.5 m long composite alveoli

End-cap structure : study and validation of most of **technological solutions** which could be used for the final detector (moulding process, cooling system, sizes of structures,...) taking into account **industrialization aspect** of process

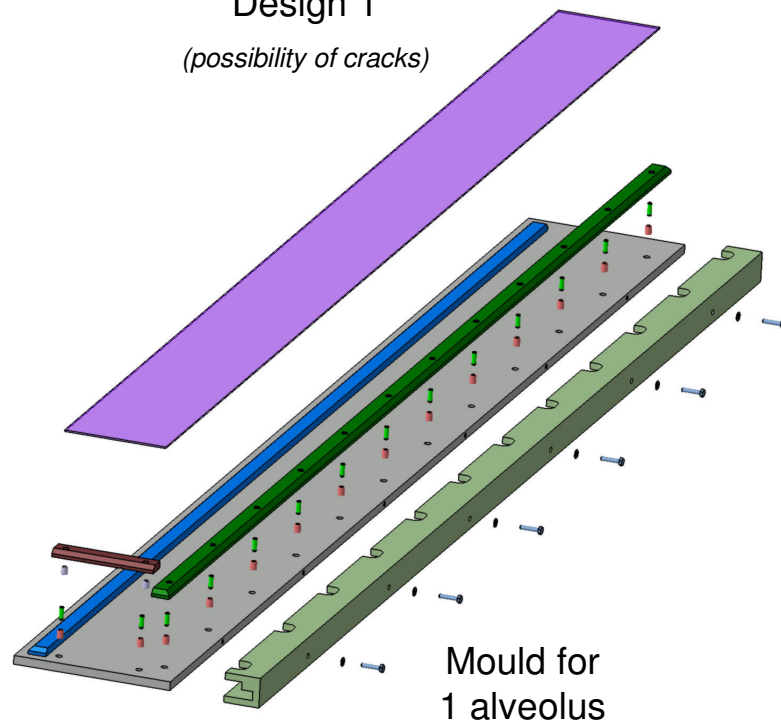

For End-caps (*design 2*) the goal is now to build 2,50 m long alveoli, and to demonstrate whether or not the main process steps (similar to barrel ones) can be adapted.

- **The end-cap layer test consisted of**
- **1 long alveolar layer of 3 cells**
(representative of the end-cap module longest layers)
- **Width of cells : 186.8 mm**
(Design2 - to fit LOI parameters (R~2090))
- **Thickness of cells : 6.5 mm**
- **Length : 2.492 m**

END CAP

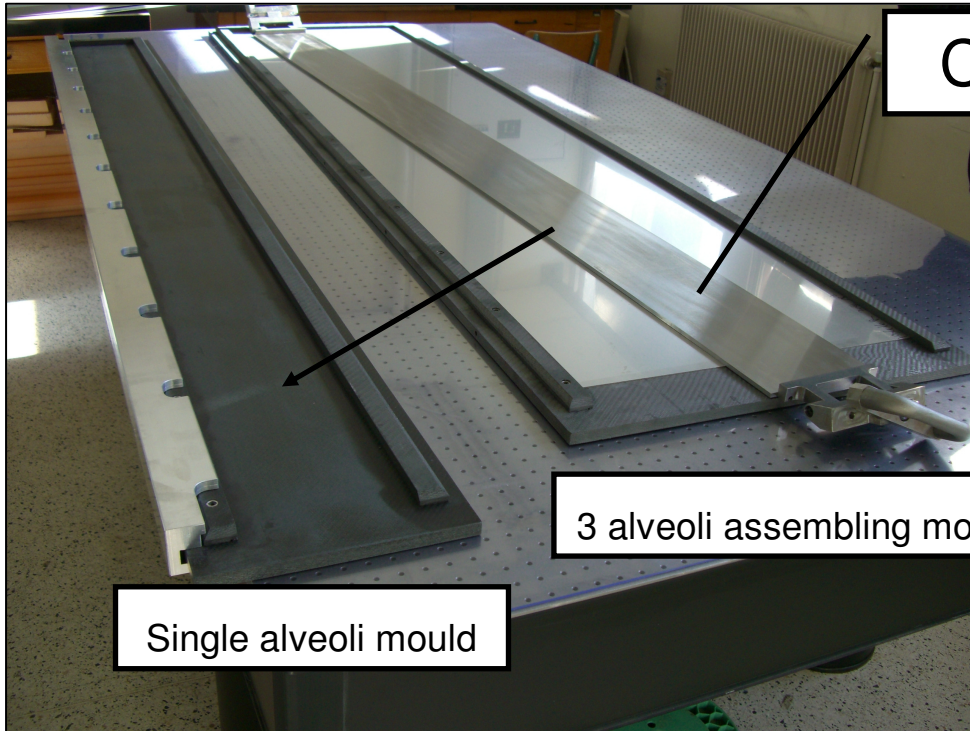

CORE

3 alveoli assembling mould

Single alveoli mould

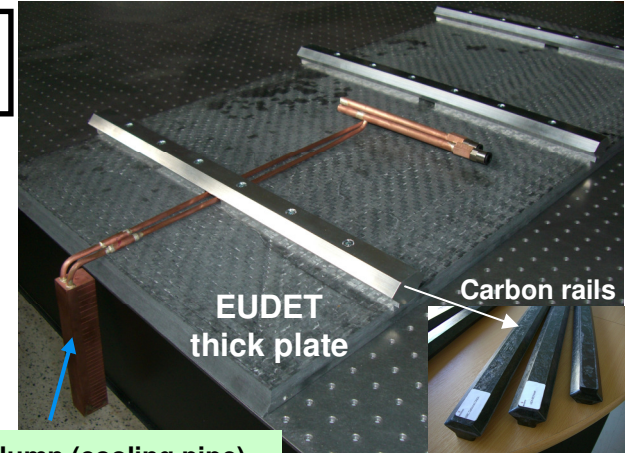

EUDET thick plate

Carbon rails

A column (cooling pipe),
(25 mm wide minimum)
to ensure quick thermal
system's connection

Compress bar

**2.5 m single and 3 alveoli
assembling mould**

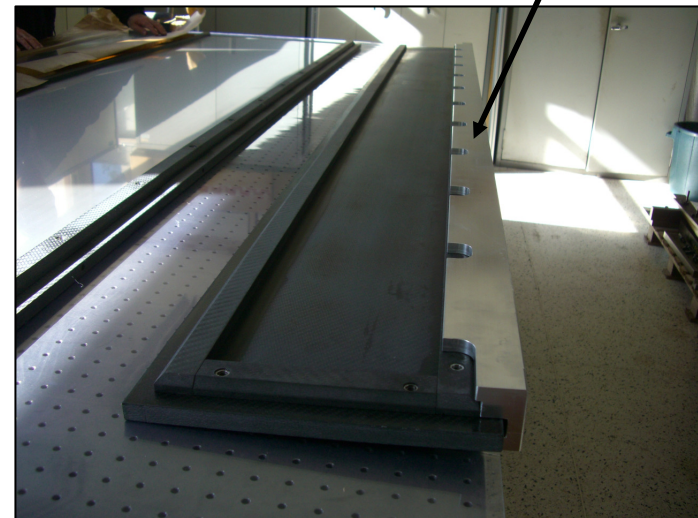

COOLING

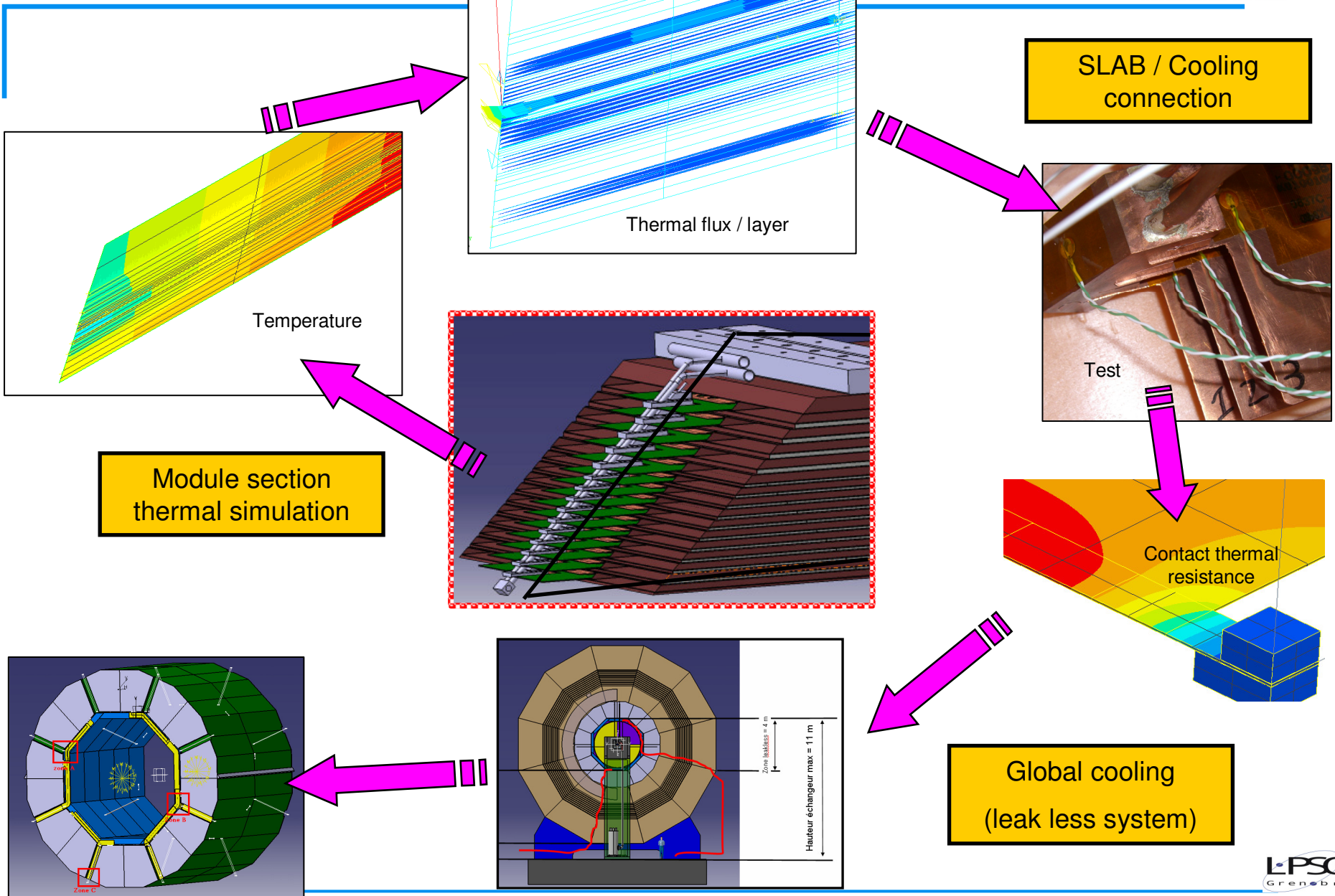

SLAB : Thermal simulation

First step : Correlate test with simulation

Autumn 2009 thermal test with the first alveolar structure

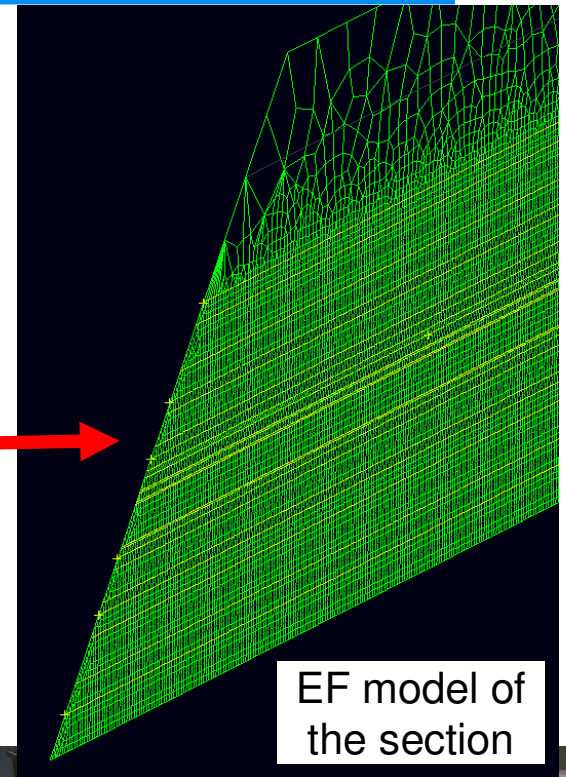
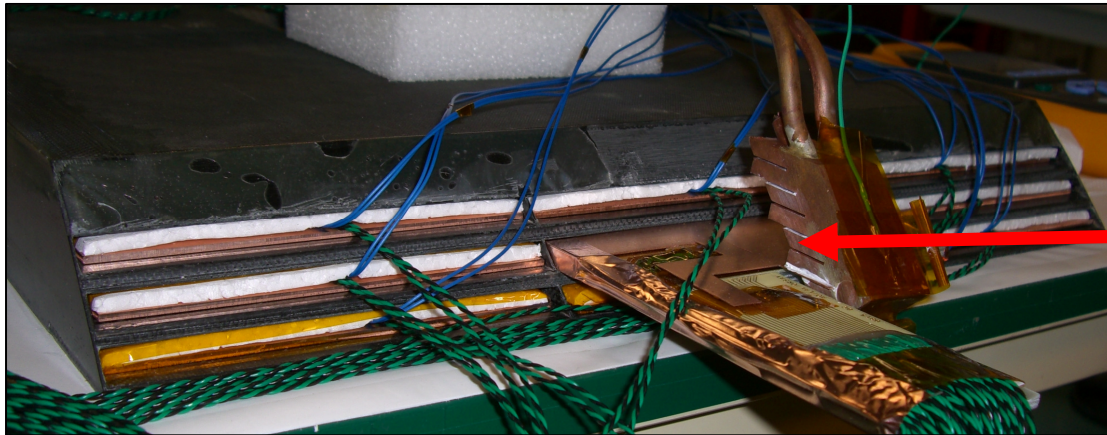

EF model of the section

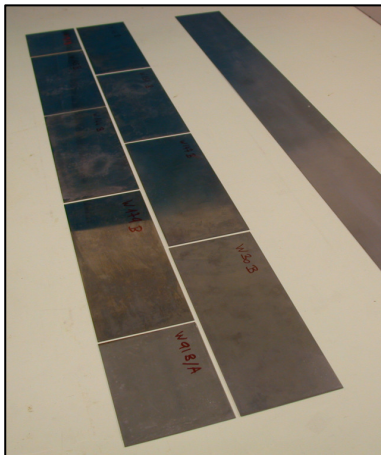

Integrate W break

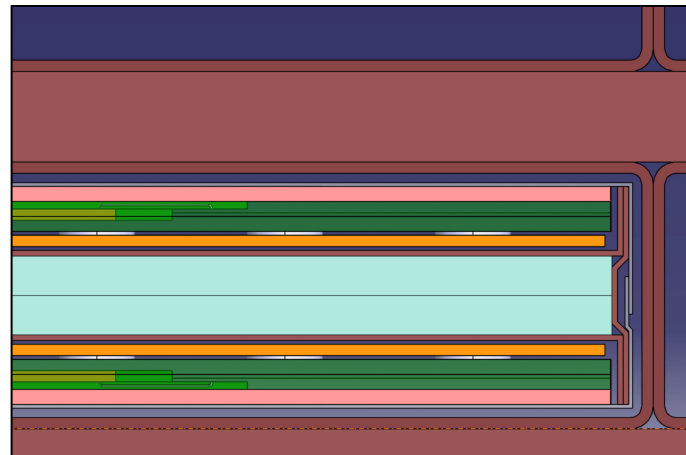

Integrate thermal contact resistance (air gap)

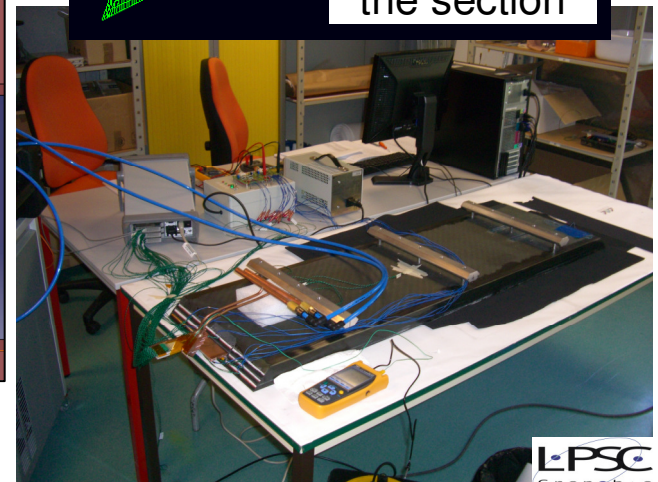

SLAB : Thermal simulation

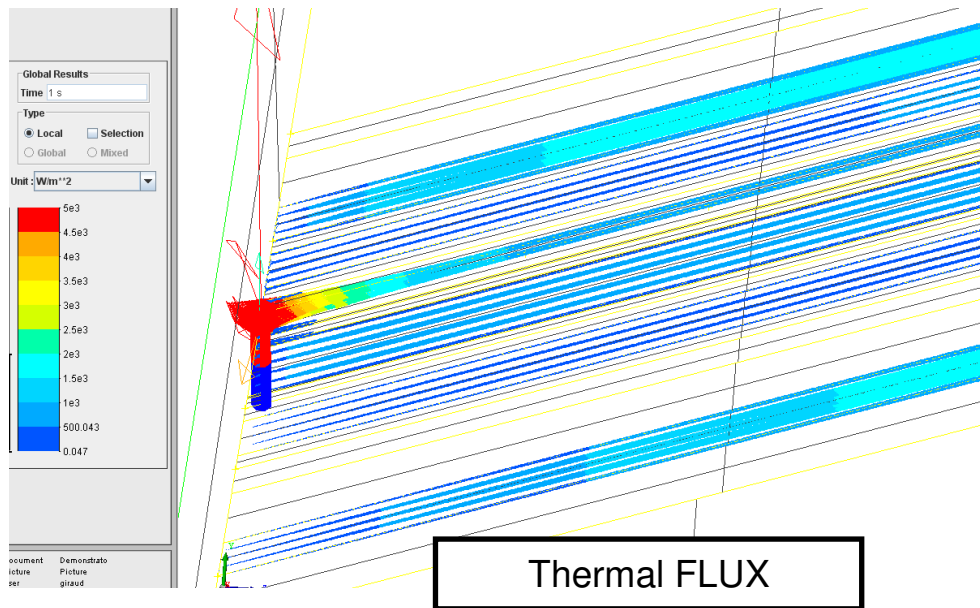
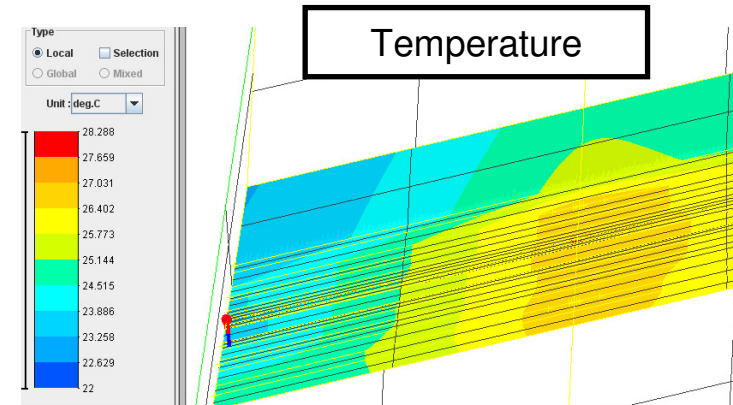
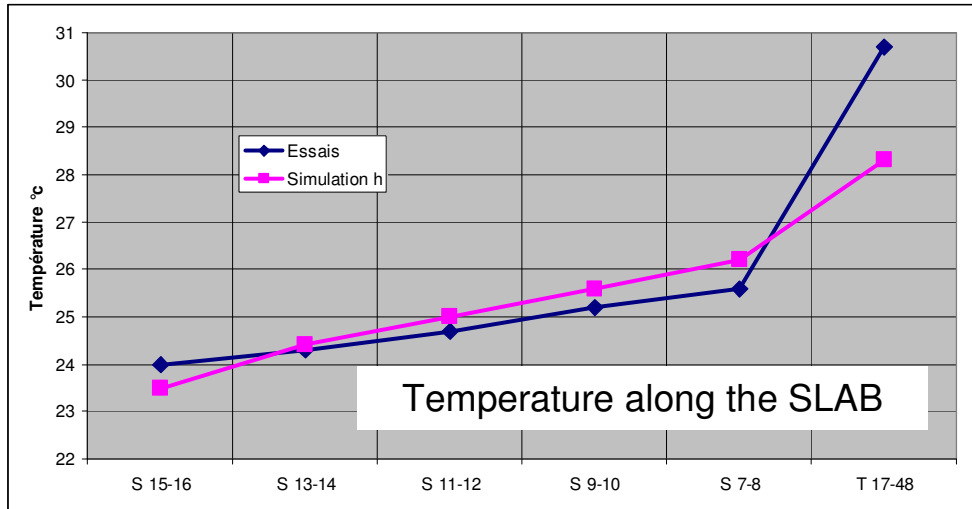

Simulation fit with test

- ⇒ Copper drain and tungsten are important for cooling
- ⇒ Next step Barrel and end cap global model

Front SLAB : thermal connection

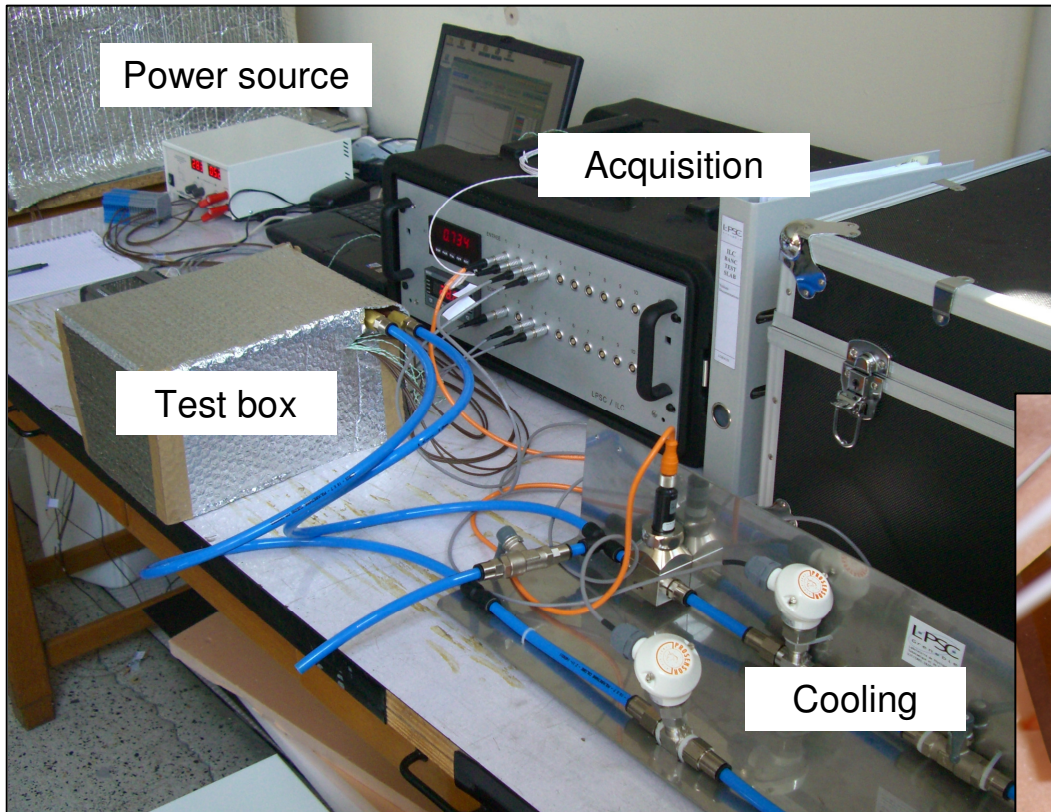

Global installation

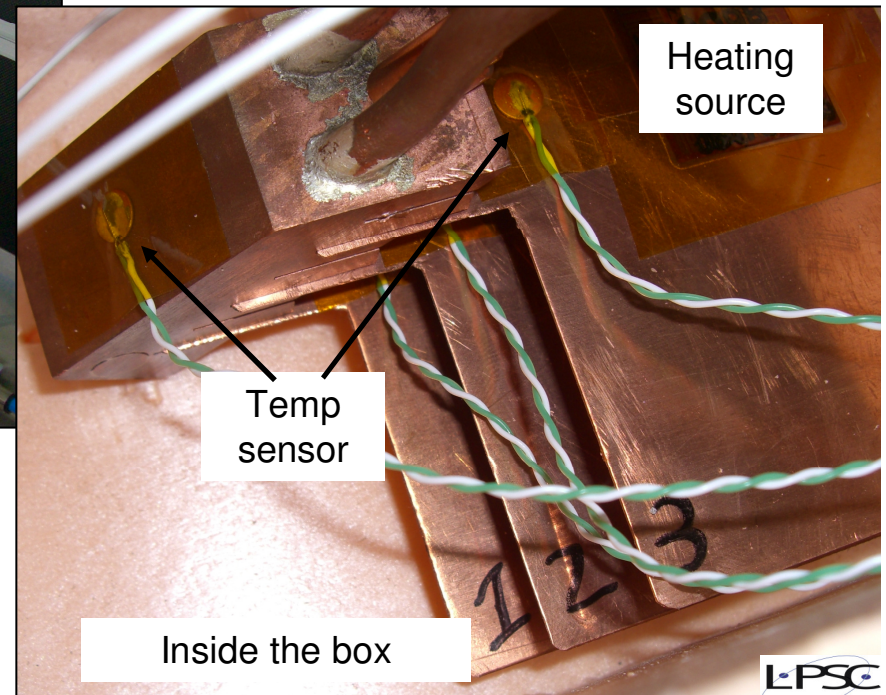

Front SLAB : thermal connection

Beginning of connection test on EUDET type cooling

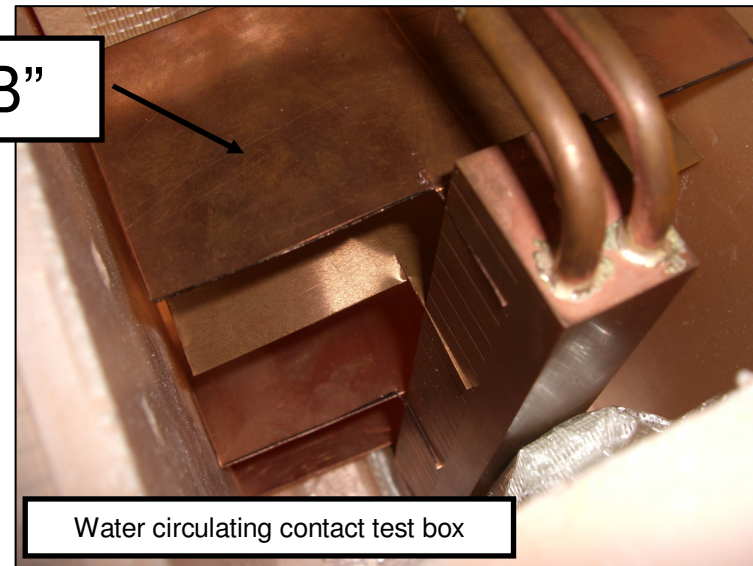
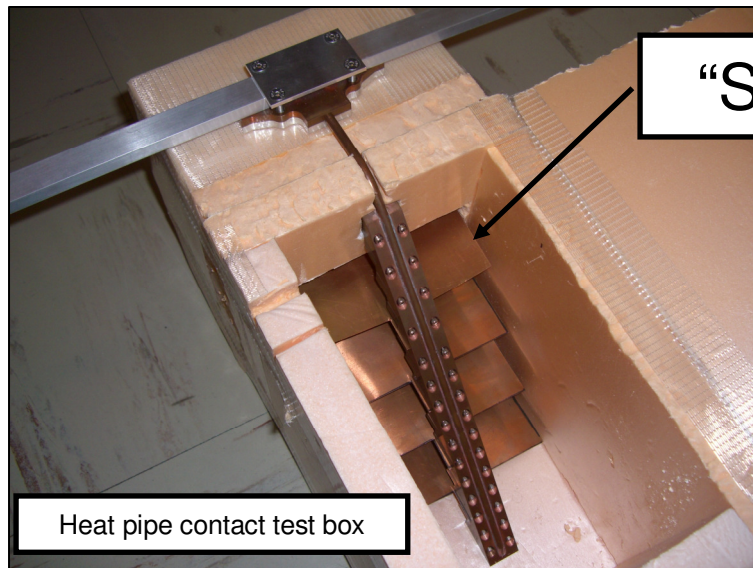

LPSC Leakless test

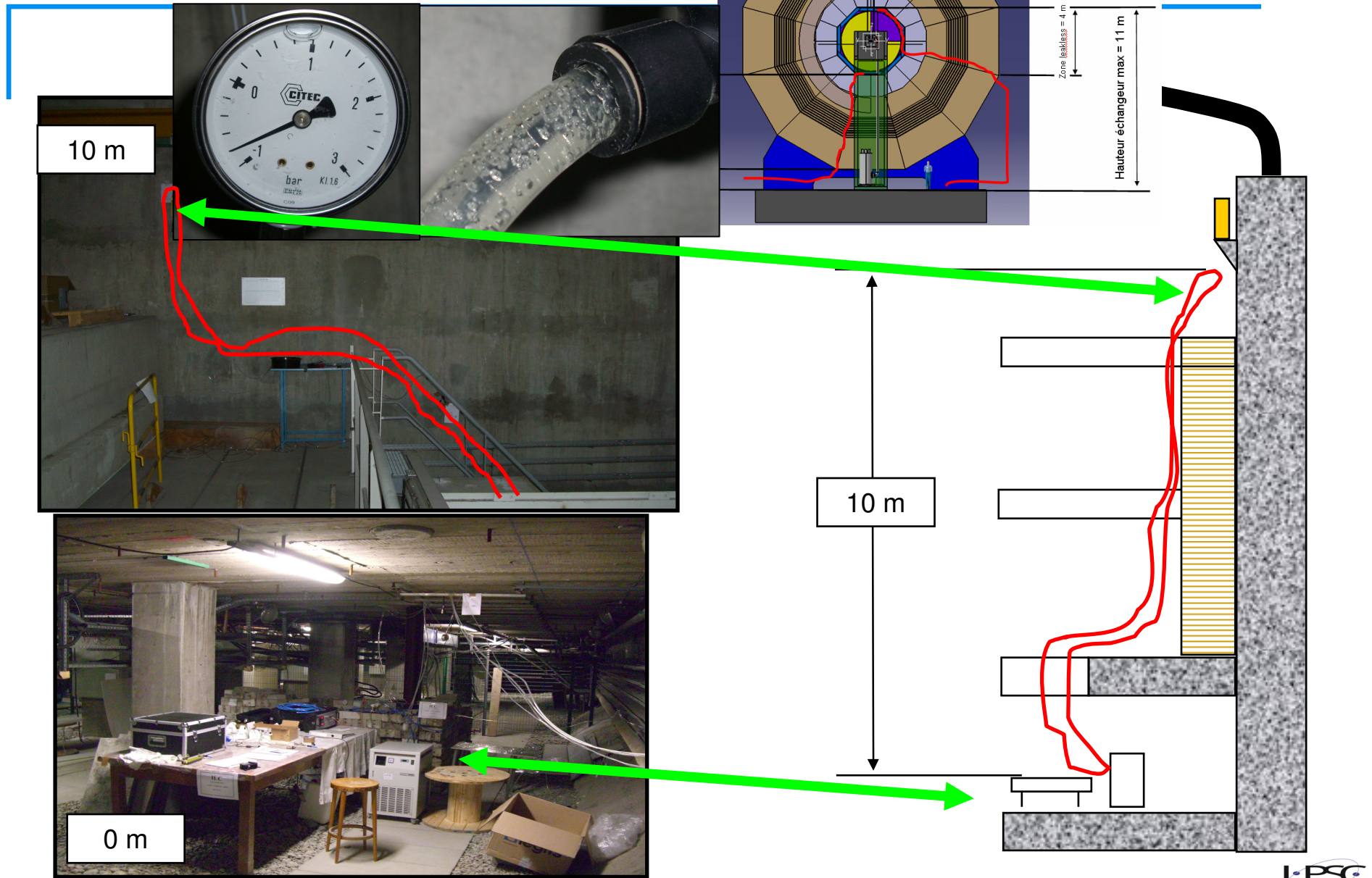

LPSC 3D pipe modeling

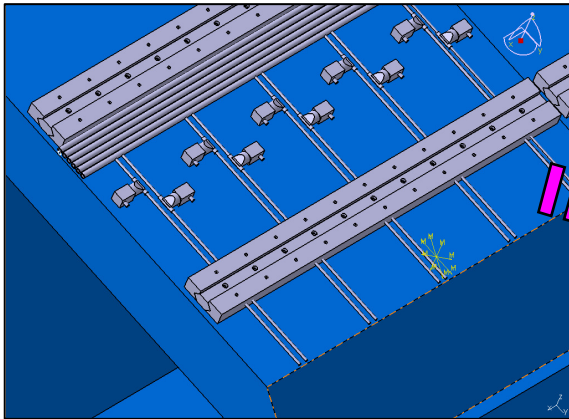

Water circulation on module

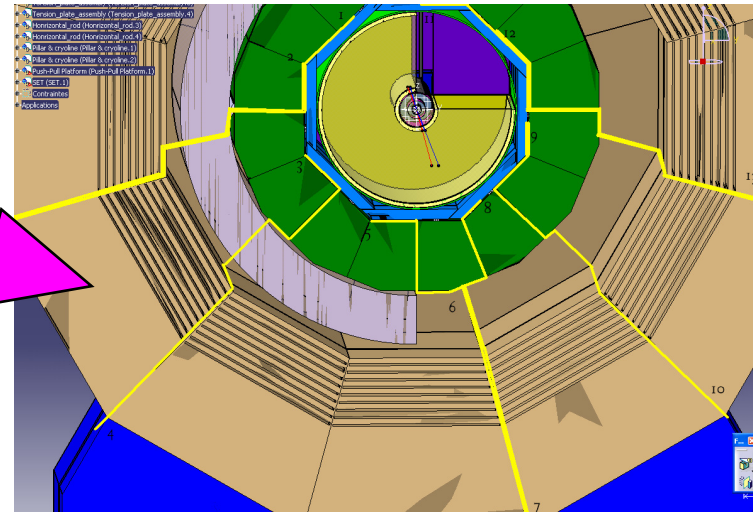

Leakless mode restriction
(leakless zone is at the top of the loop)

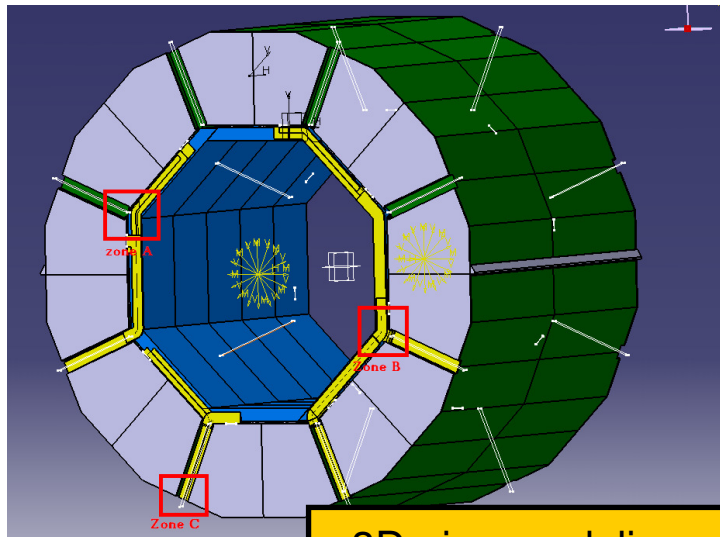

3D pipe modeling

Global design

- Leakless mode.
- One line / module.
- Inlet water temp: 18°C / Outlet water temp : 23°C
- Maximum power / column : 100 W.
- Pipe diameter : 13 mm.

Conclusion :

Long alveoli molding test



- “Alveolar cell & layer” moulds reception **Feb 10**
- Composite reception **Feb 10**
- 2.5 m alveoli molding test **March 10**
- 2.5 m layer molding test **Sept 10**

COOLING



- Barrel / End cap global section simulation **Spring 10**
- Slab / cooling system connection thermal test **Spring 10**
- Specific cooling system for EUDET (portable) **Sum 10**
- First Design: hydraulic safety, hardened components, cooling supervision... **Fall 10**
- Design & build a “true scale test loop” : cooling system « Leakless » (<1atm) **Fall 10**

Fabrication – tests - characterization



- Characterisation, tests & optimisation: composite elements and rails **Sum 10**

EUDET design LLR

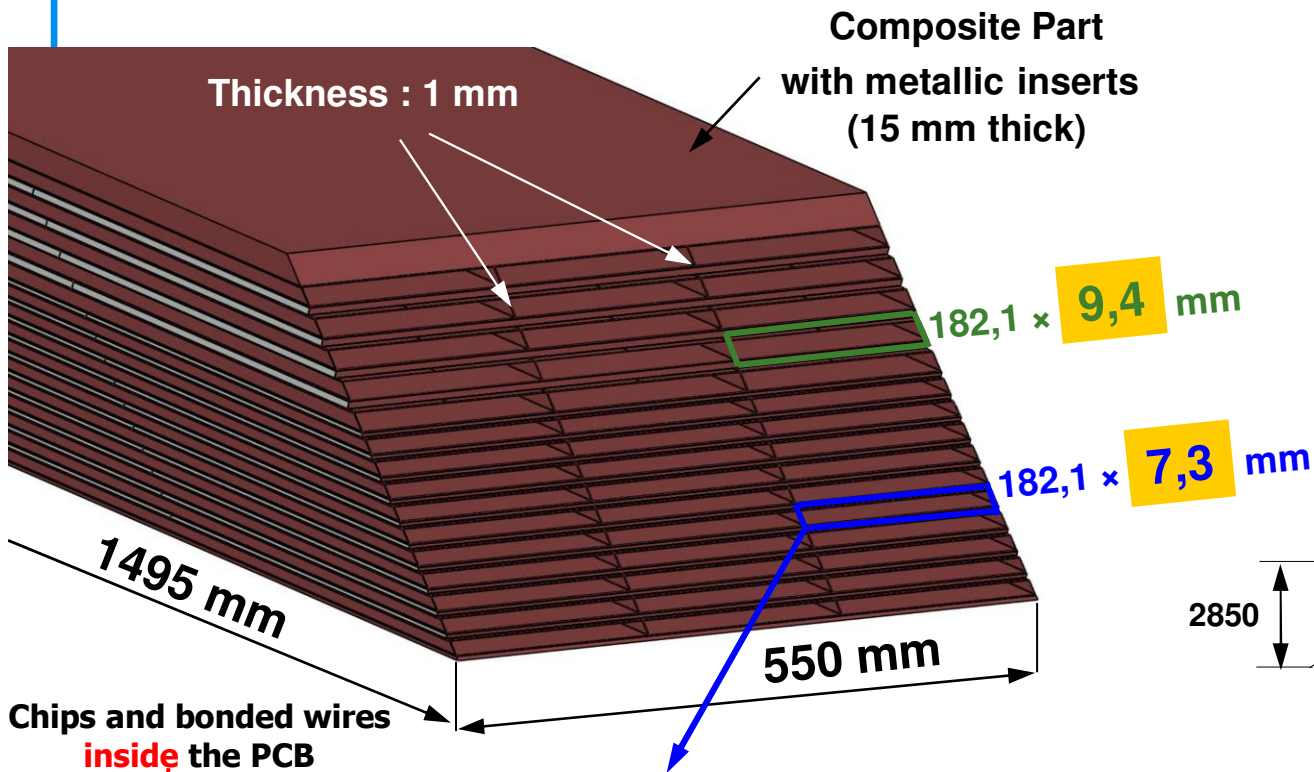

FEV7 CIP at the present time

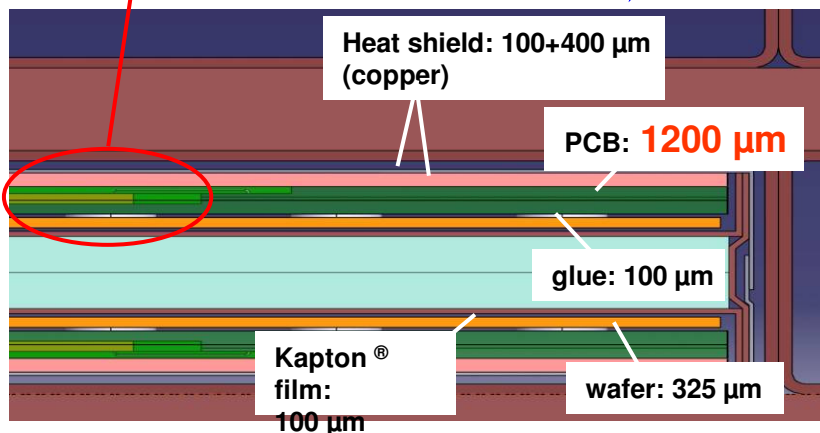
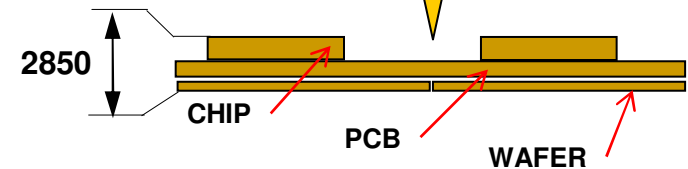
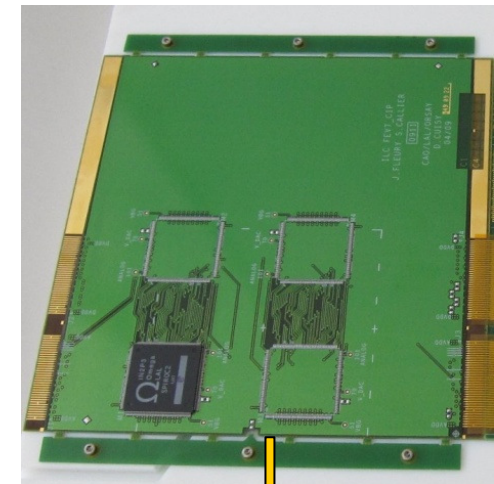

- ⇒ Clearance (slab integration) : 500 μm
- ⇒ Heat shield : 500 μm → Thermal demonstrator
- ⇒ PCB : 1200 μm → but 1100 μm used
- ⇒ Thickness of glue : 100 μm
- ⇒ Thickness of wafer : 325 μm
- ⇒ Kapton® film HV : 100 μm ? → tests
- ⇒ Thickness of W : 2100/4200 μm (± 80 μm)

Demonstrator design LLR

- Built a first demonstrator to understand all manufacturing processes
- Width is based on physics prototype (124 mm)
- Good precision (width, dead zone, cells thickness) (global tolerance +/- 0.01mm).
- Used for thermal PCB studies and cooling system analysis
- Used for the First test of slab integration (gluing, interconnection ...)

- It's consisted of
 - 3 alveolar layers + 2 Tungsten layers
 - 3 columns of cells : representative cells in the middle of the structure
- Used for Thermal studies support
- Width of cells : 126 mm
- Identical global length : 1.3m and shape (trapezoidal)
- Fastening system ECAL/HCAL
- weight : ~ 60 Kg

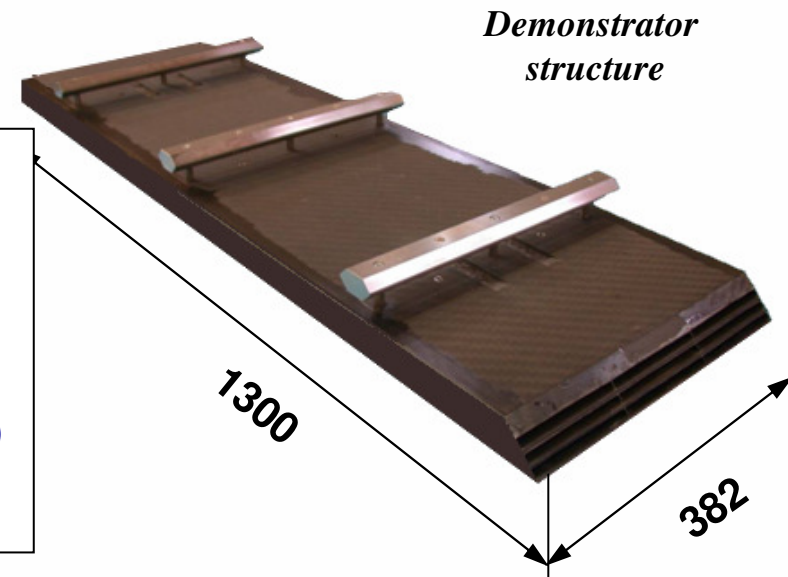

EUDET- Assembly Mould LLR

Now, here is the EUDET assembly mould With the first EUDET layer :

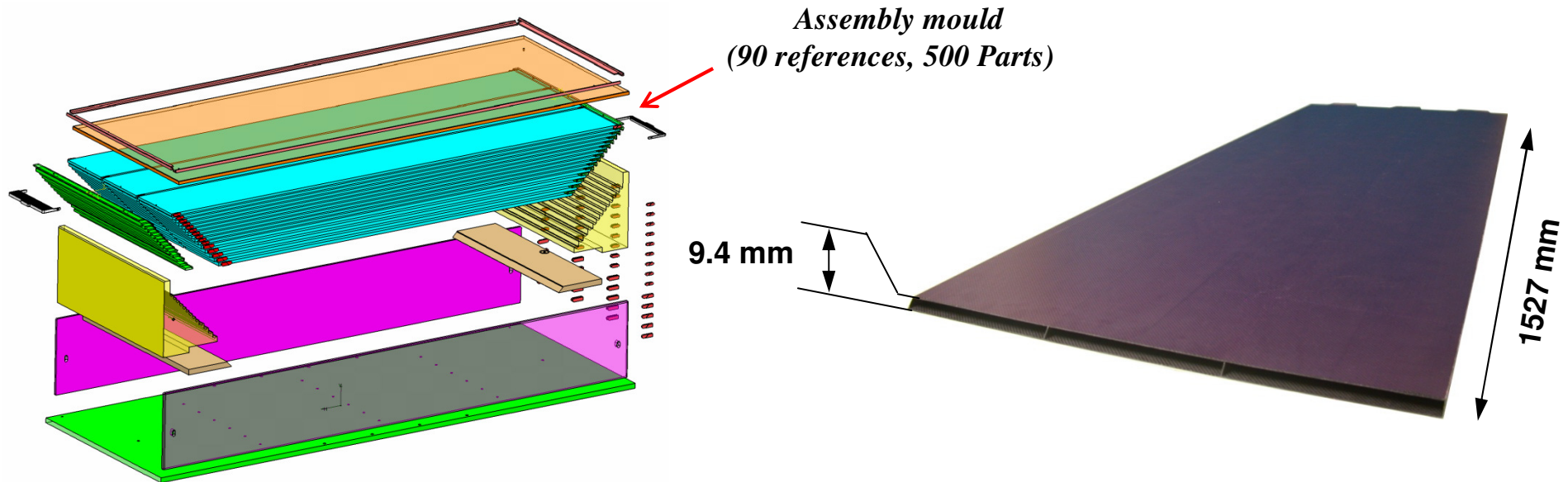

- ⇒ Global design : **OK**
- ⇒ W and Carbon Needs : **OK**
- ⇒ Detailed design description : **OK**
- ⇒ Technical drawing : **OK**
- ⇒ Ordered : **MARS 10**

- ⇒ Global design : **OK**
- ⇒ 1/15 "Alveolar EUDET layer" : **OK**
- ⇒ Cutting Layer operation: **OK**
- ⇒ The supplier for cutting layer : **OK**
- ⇒ Layers Production : **Mars 10**

EUDET H or U SLAB LLR

Study of one mould for whole slab structures:

- All slabs are made by several short but **precise plates**, assembled in 2 layers, in order to control the thickness and the flatness

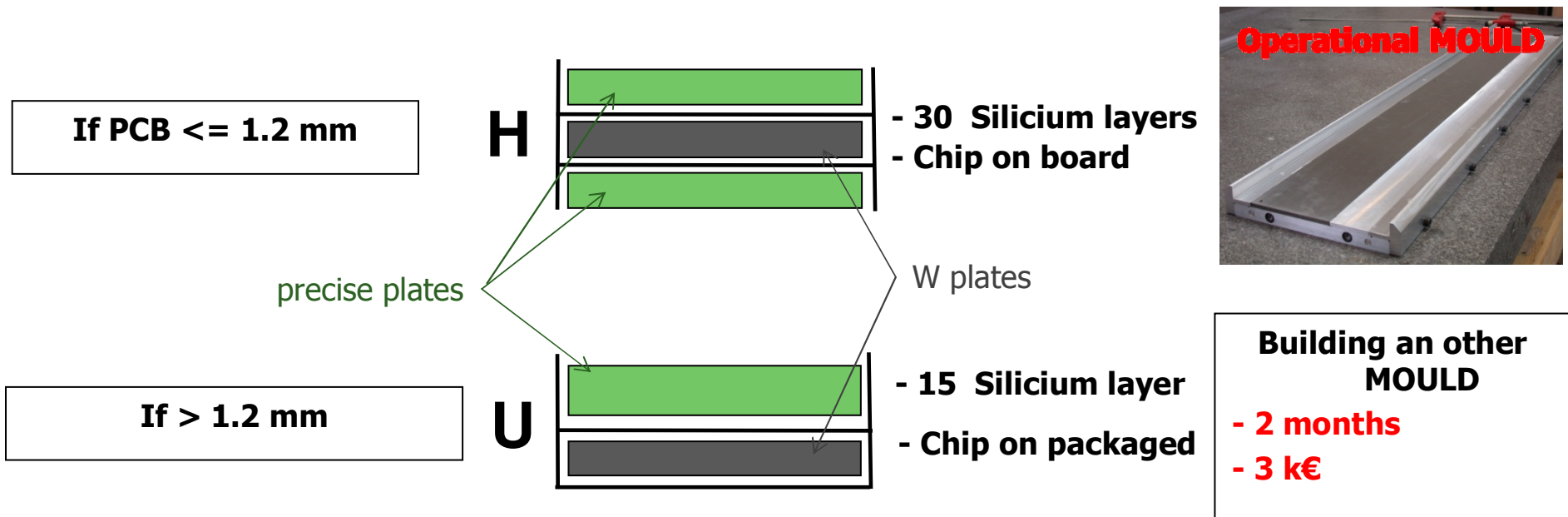

- ⇒ Design and Machining: **OK**
- ⇒ first H structure (1300×124): **OK**
- ⇒ EUDET short and long H SLAB: **second half-year 2010**
- ⇒ EUDET short and long U SLAB: **second half-year 2010**

Conclusion : schedule LLR

- For Eudet module :
 - Composite reception **realized in april (2008)**
 - "Alveolar layer" mould reception **realized in april (2008)**
 - Building one EUDET alveolar layer in **July (2009)**
 - We will plan:
 - "Assembly mould" design in **December (2009)**
 - 14 alveolar layers in **first half-year (2010)**
 - Eudet structure assembled in the **Second half-year (2010)**
 - "14" H or U Short structure in **second half-year (2010)**
 - "1" H or U long structure in **second half-year (2010)**