

Status of Hiroshima-KEK Compton Experiment at ATF

Tohru Takahashi
Hiroshima University

KEK – Hiroshima and close contact with Waseda University, Seikei University and LAL Orsay

- ▶ Introduction
- ▶ Status of the cavity R&D
 - for Two mirror cavity
 - for four mirror cavity

March 2011
ALCPG11, Oregon

Proposed telescopic, passive, resonant external cavity

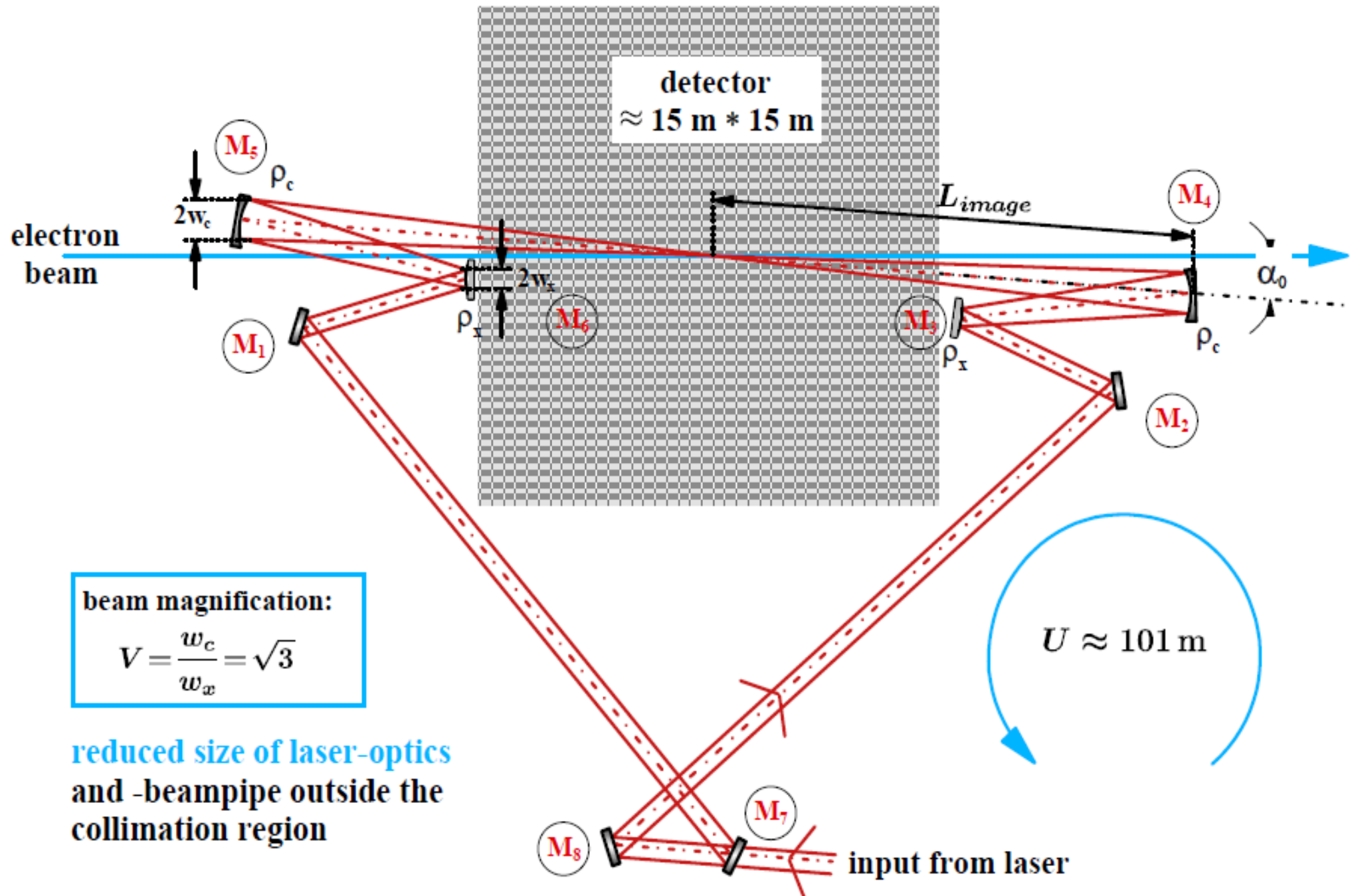

Two Prototype Cavities

2-mirror cavity (Hiroshima / Weseda /
Kyoto / IHEP / KEK)

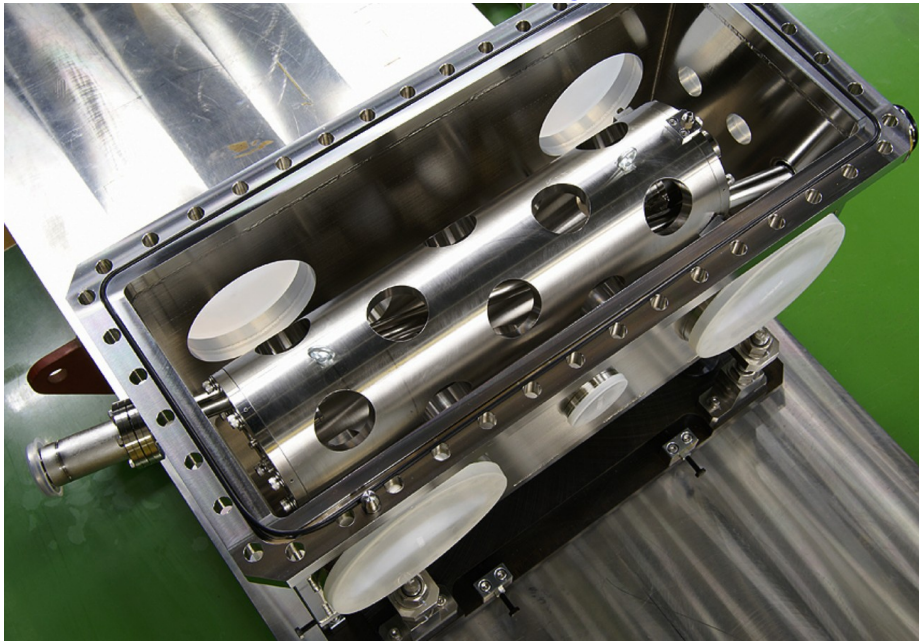

moderate enhancement
moderate spot size
simple control

demonstration of γ ray gen.
accum. exp. w/ cavity and acc.

4-mirror cavity

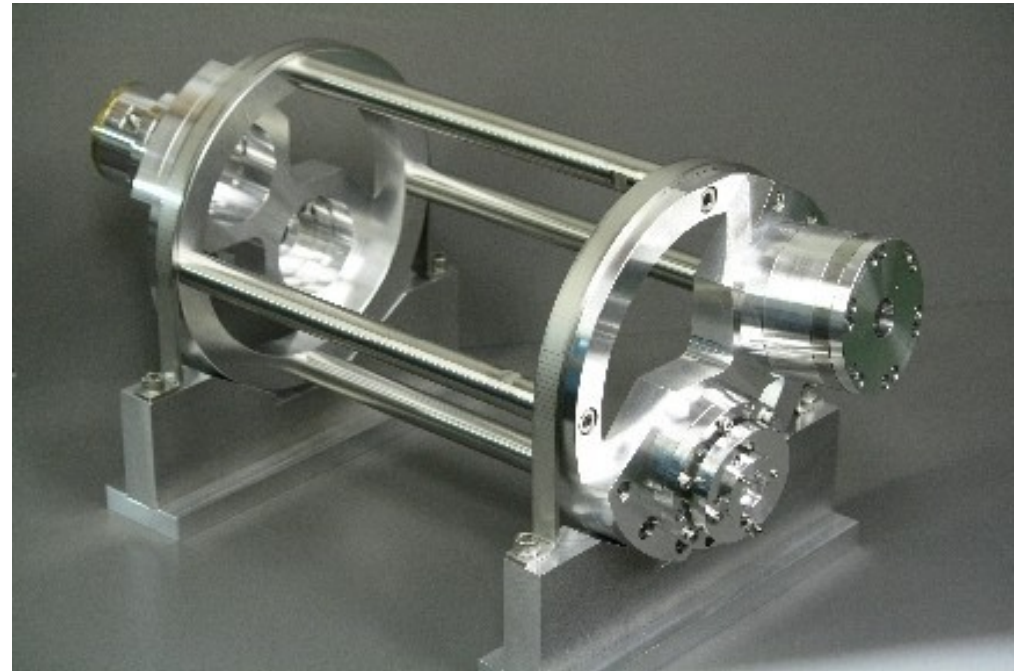

high enhancement
small spot size
complicated control

intense γ ray generation

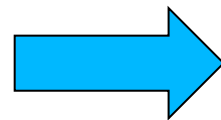

Experimental R/D in ATF

Hiroshima-Waseda-Kyoto-IHEP-KEK

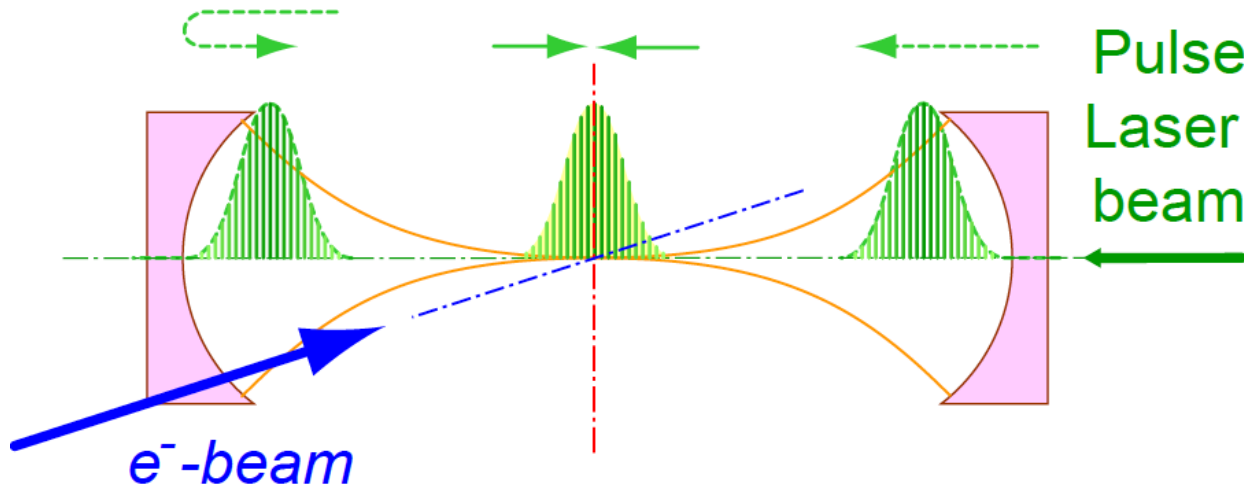

Make a fist prototype
2-mirror cavity

$$L_{\text{cav}} = 420 \text{ mm}$$

Put it in
ATF ring

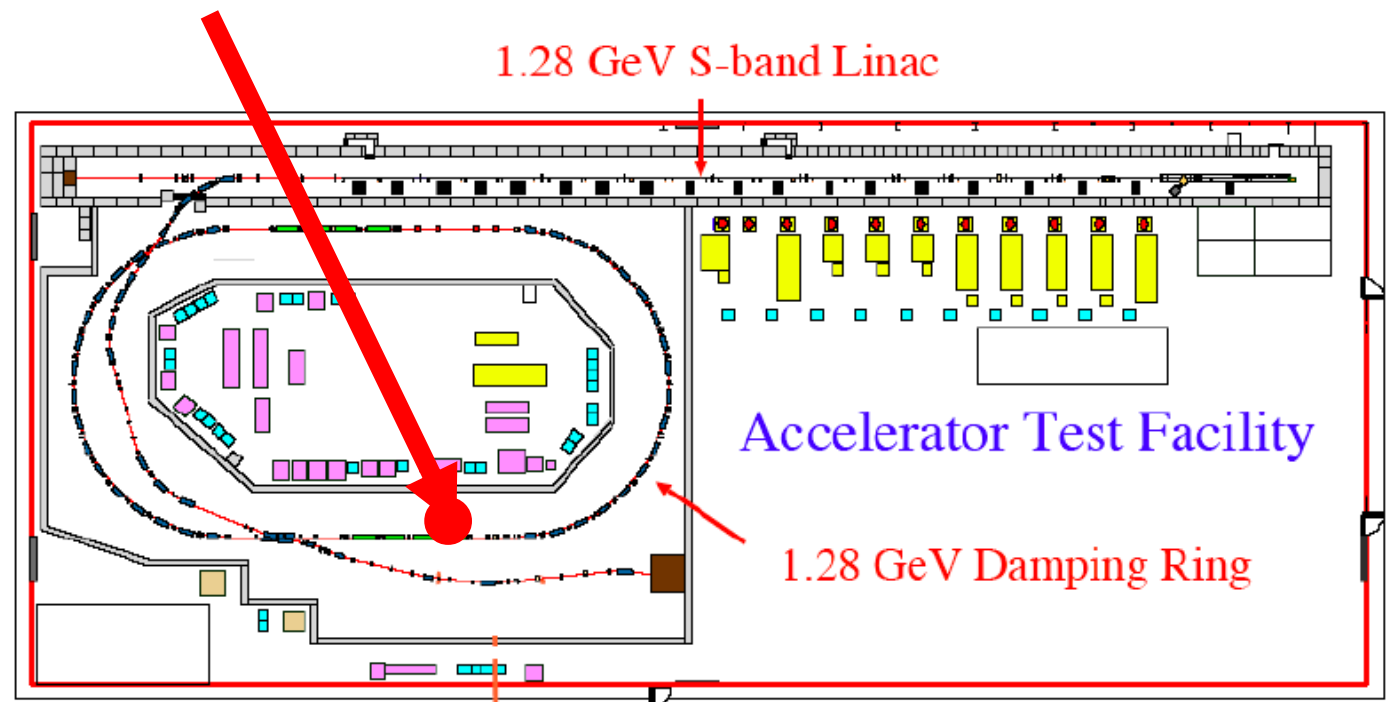

Progress of the 2M cavity

- ▶ 2007/2008 -- installed into the ATF
 - γ ray generation w/ 250 enhancement but not well synchronized w/ e-
- ▶ 2008/2009 --- synchronized w/ e-
 - 500W, γ ray generation
- ▶ 2008/2009 -- more encasement (750)
 - 2.5kW, γ ray generation

reported in previous meeting

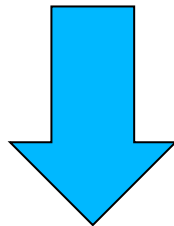

- ▶ 2010-
 - bunch by bunch measurement

in 2010 operation

► laser power

- enhancement 750
- stored 1.5kW

► γ rays

- 10 bunches
- 11 γ /10bunch in the detector

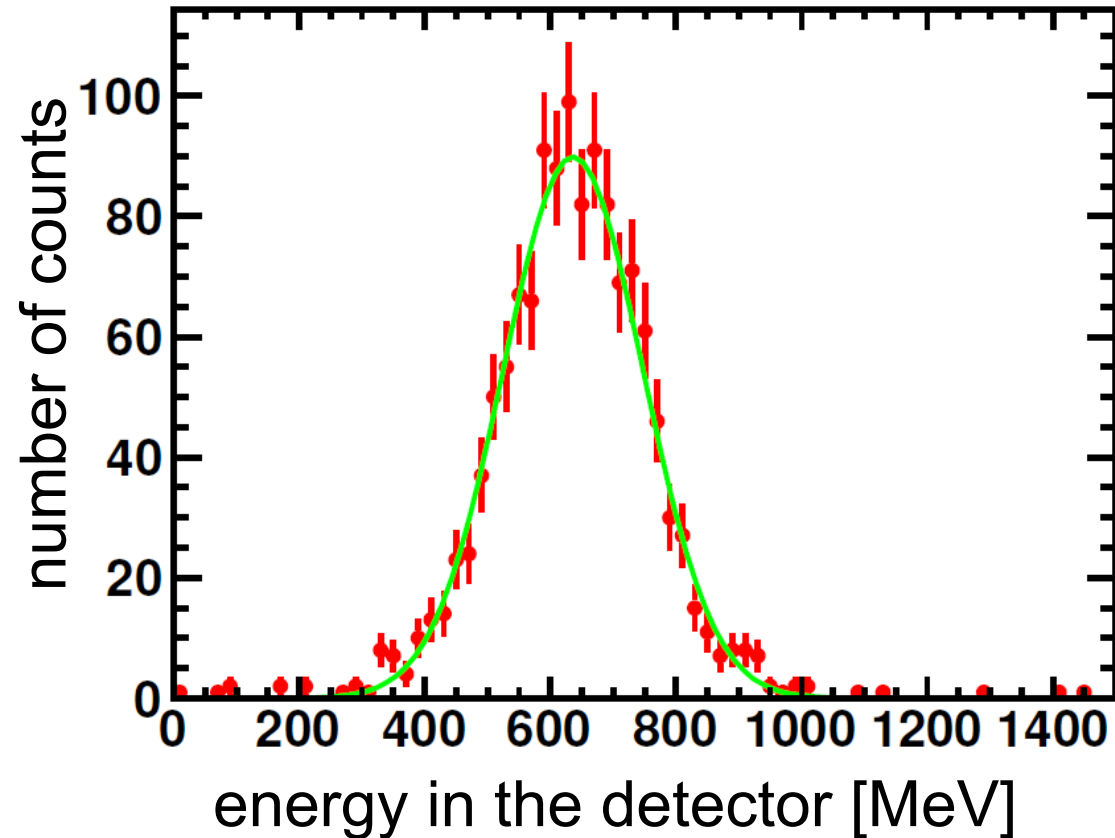

New Gamma-ray Detector

Miyoshi PosiPol2010



Result of simulation

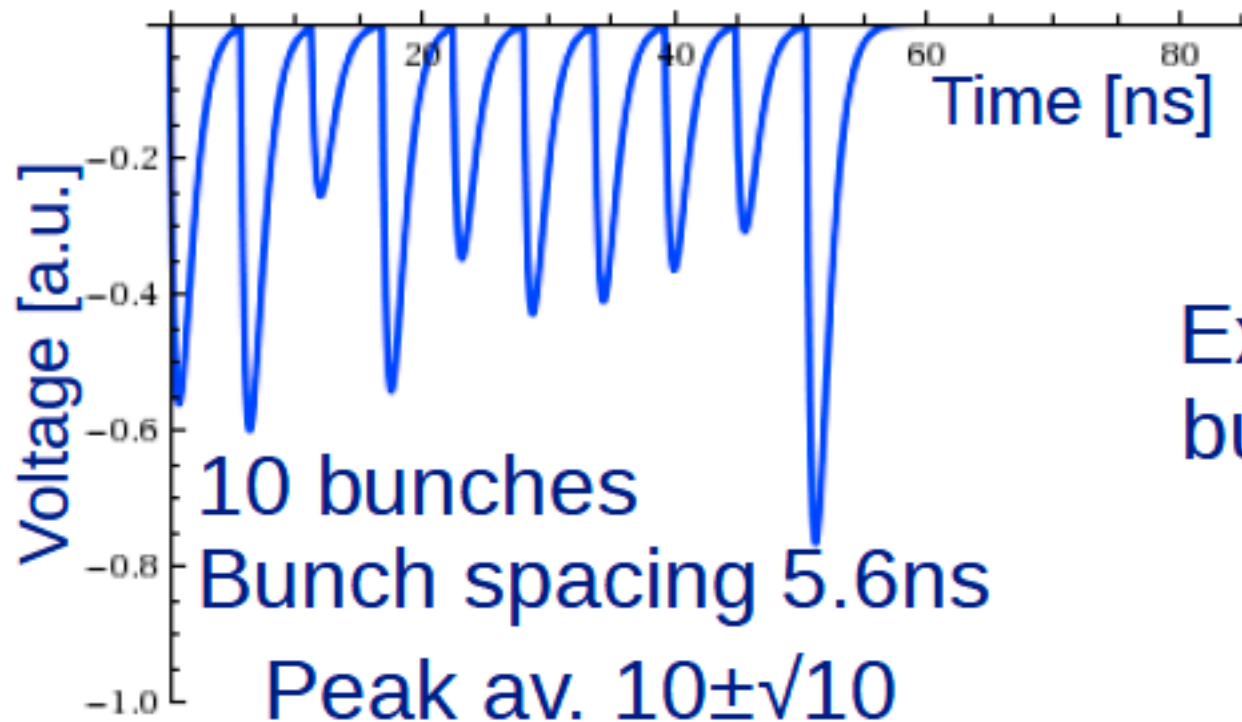

Expected to obtain
bunch information.

bunch by bunch γ rays

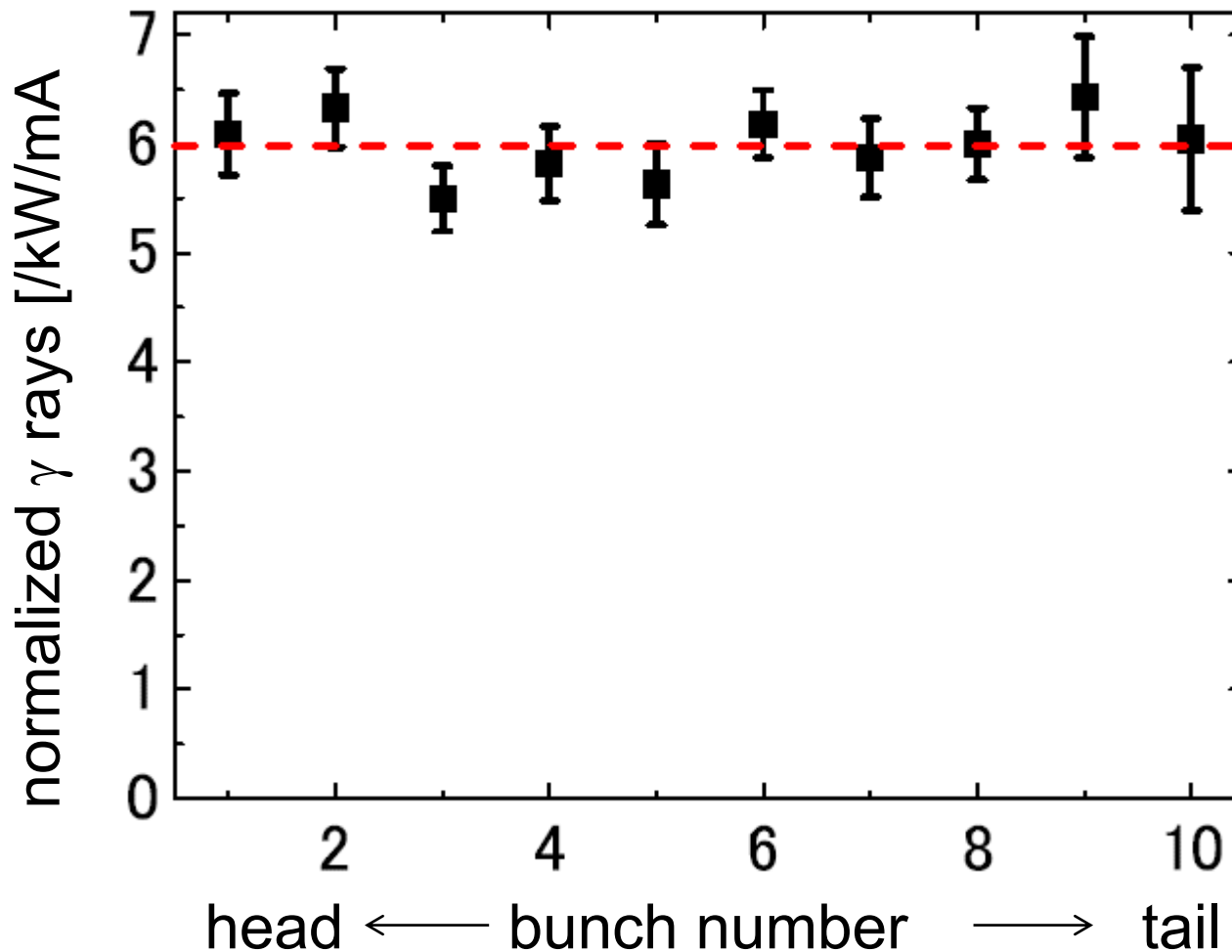

no bunch position dependence in a train
absolute # is consistent w/ estimation

We should go to 3D 4 mirror ring cavity to get small spot size

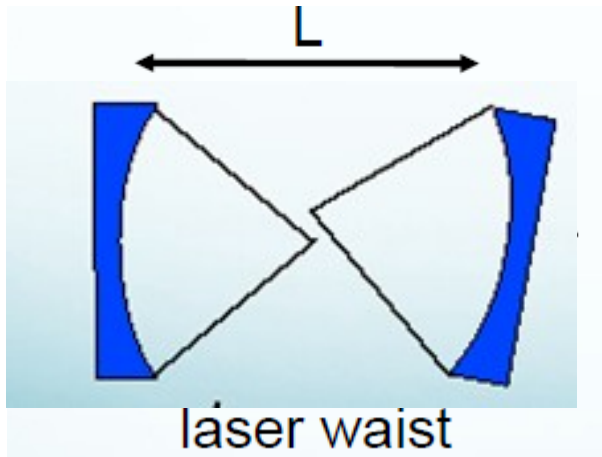

2 mirrors is not stable for small spot size

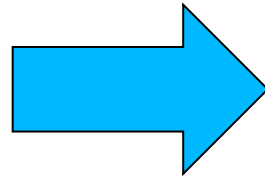

2d 4M has astigmatism

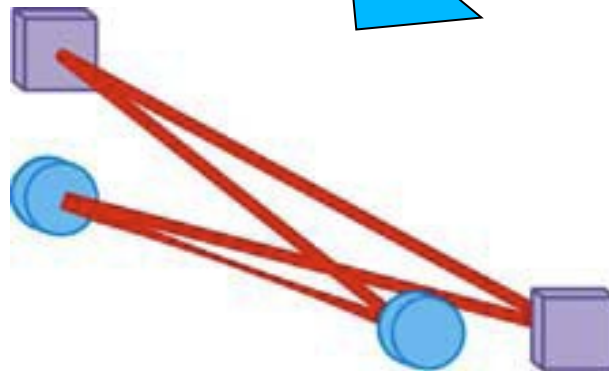
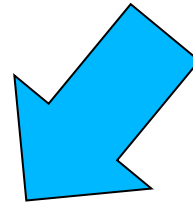

3D (or twisted)
4M ring cavity

Two 4 mirror cavities are installed at the ATF

KEK-Hiroshima
to be installed summer 2011

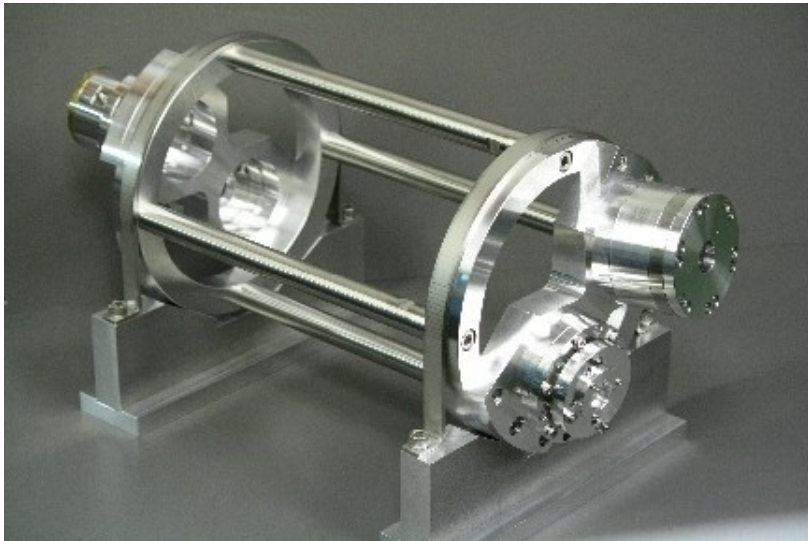

relatively simple control system
employ new feed back scheme
w/ exiting laser system

LAL-Orsay
installed summer 2010

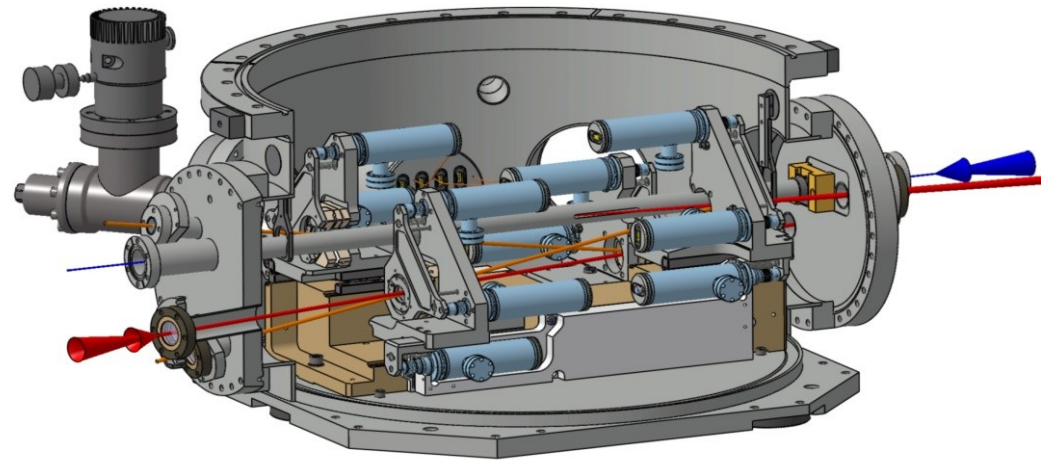

all mirrors are remotely controlled
sophisticated PDH feedback
high power accumulation
w/ fiber lasers

See Zommer's talk

4M cavity test bed at KEK

- ▶ in 4M ring cavity, photons travel twisted path.
 - got geometric phase
 - the cavity only resonate w/ L or R handed state
 - and more,...

need detail study by
the comparison of measurement s
and calculation.

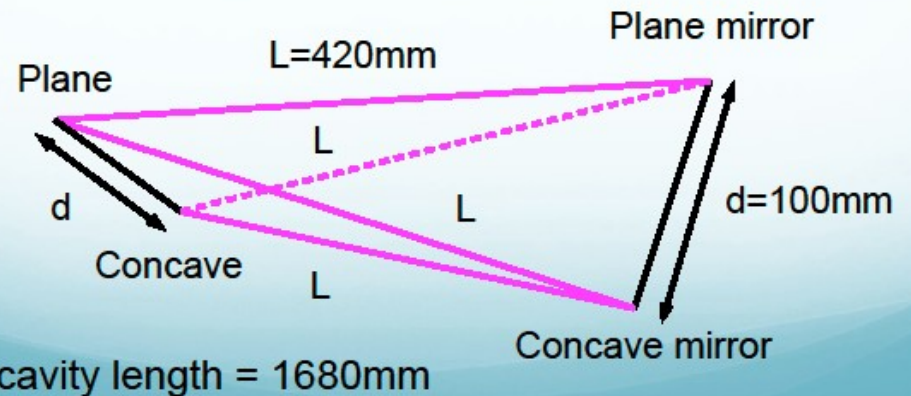
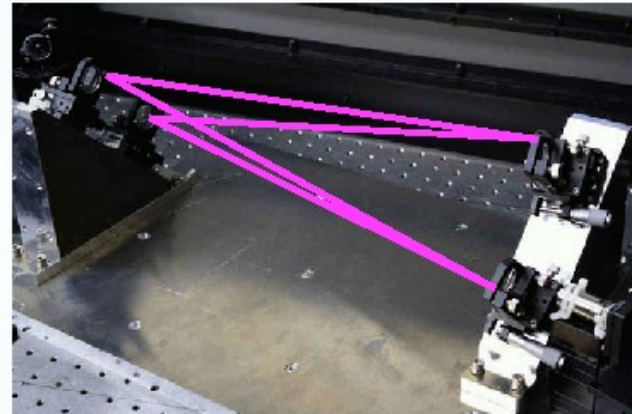

Configuration of test bed

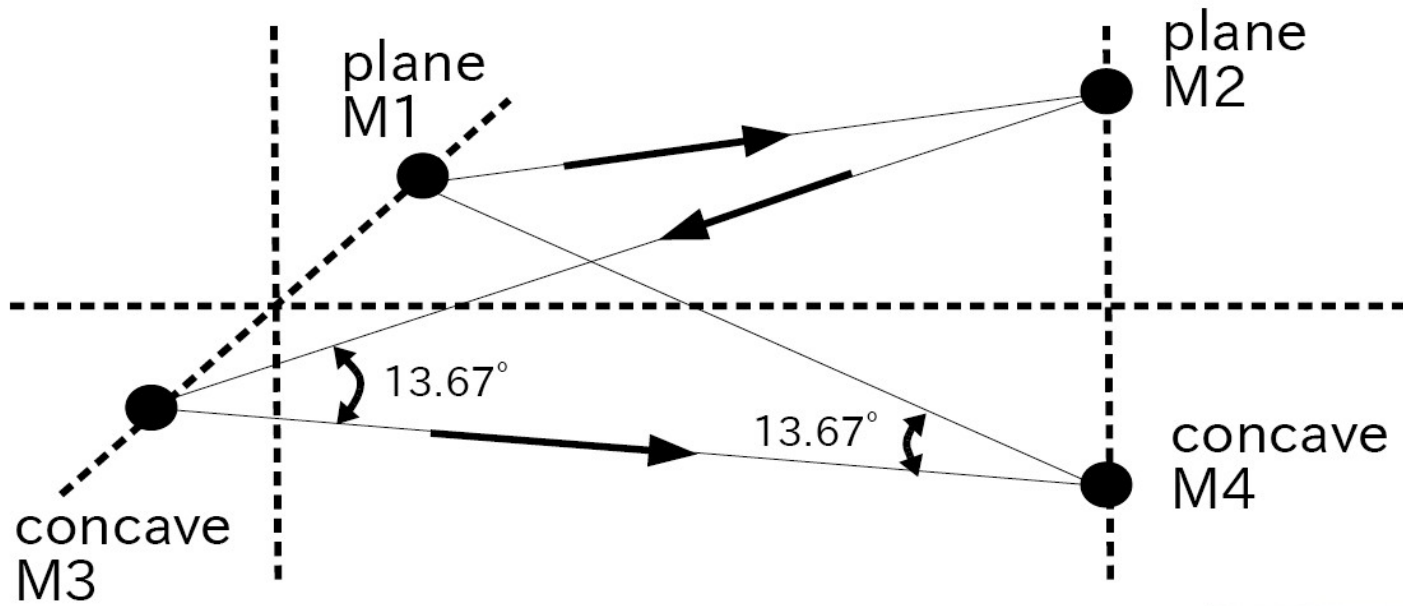

$L1 = M1 - M2 = 420\text{mm}$
 $L2 = M2 - M3 = 420\text{mm}$
 $L3 = M3 - M4 = 420\text{mm}$
 $L4 = M4 - M1 = 420\text{mm}$

$M2 - M4 = 100\text{mm}$
 $M1 - M3 = 100\text{mm}$

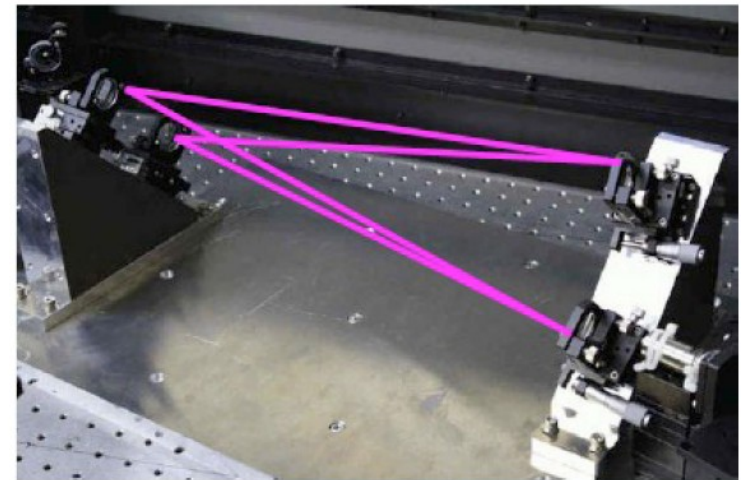

calculation of spot size w/ test bench geometry

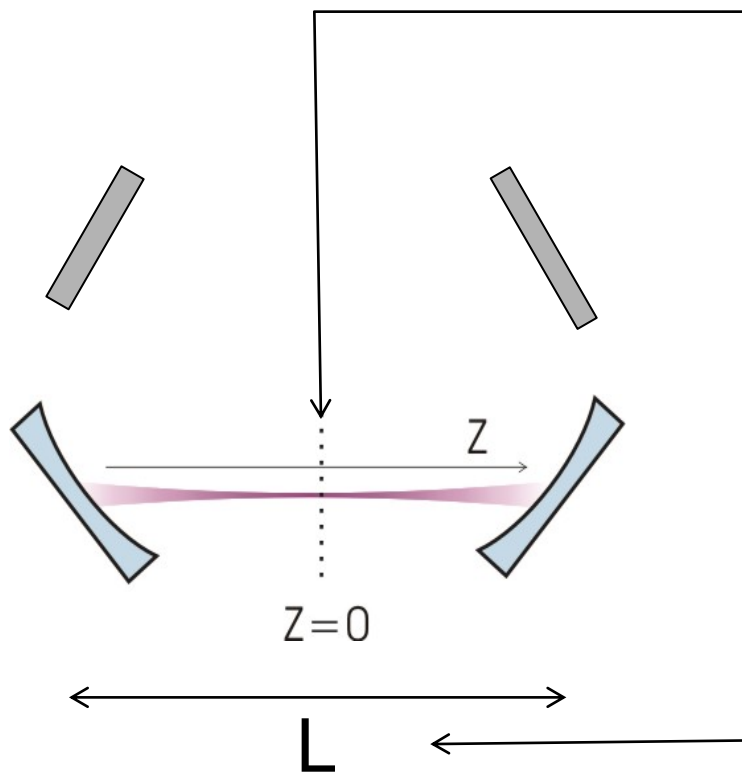
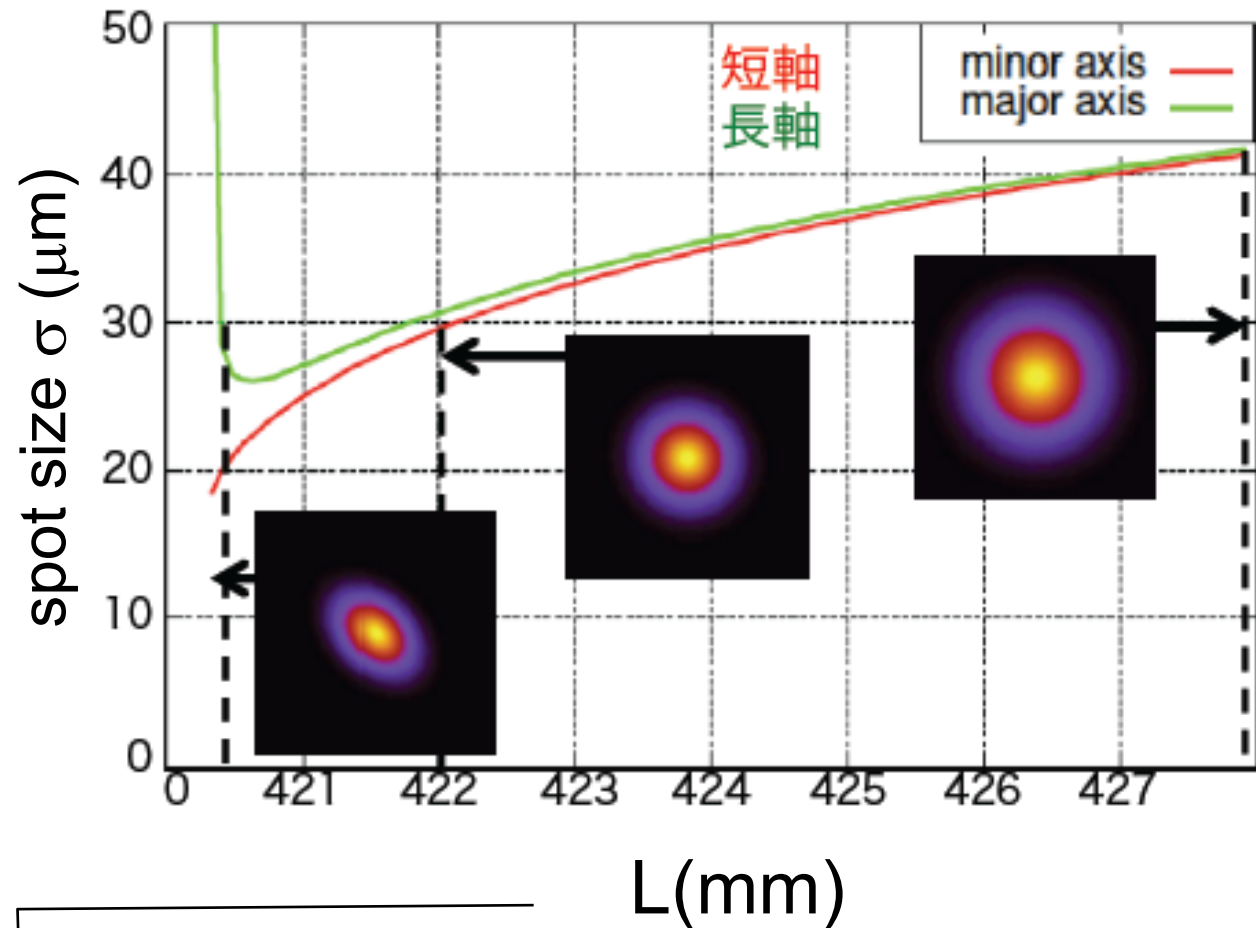
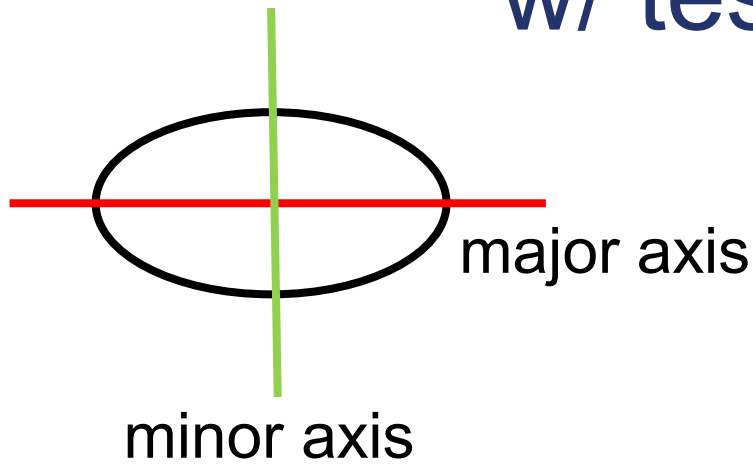

spot size is not sufficiently small
with test bench geometry

new geometry

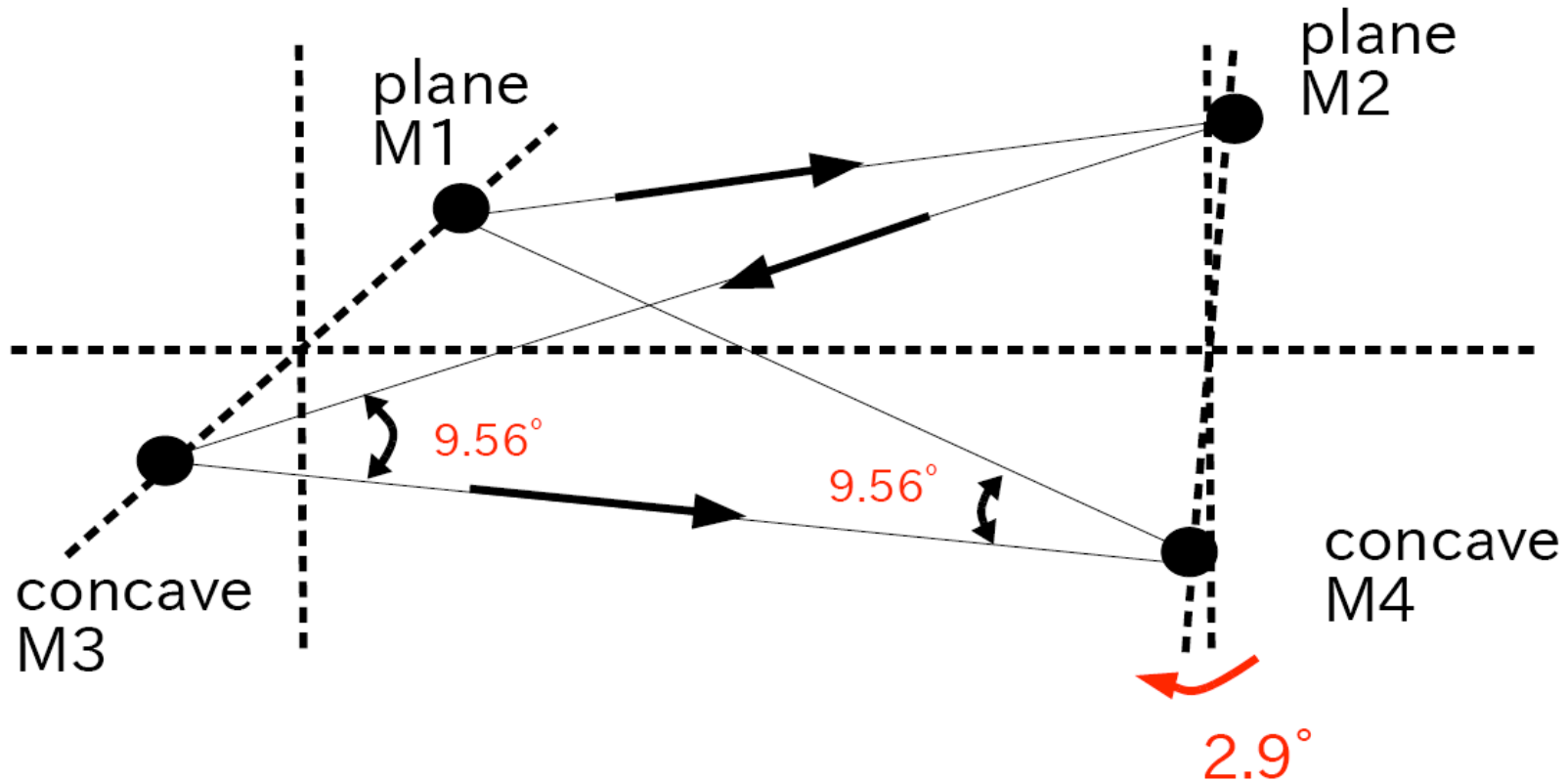

$$L1 = M1 - M2 = 420\text{mm}$$

$$L2 = M2 - M3 = 420\text{mm}$$

$$L3 = M3 - M4 = 420\text{mm}$$

$$L4 = M4 - M1 = 420\text{mm}$$

$$M2 - M4 = 70\text{mm}$$

$$M1 - M3 = 70\text{mm}$$

expected spot size w/ new geometry

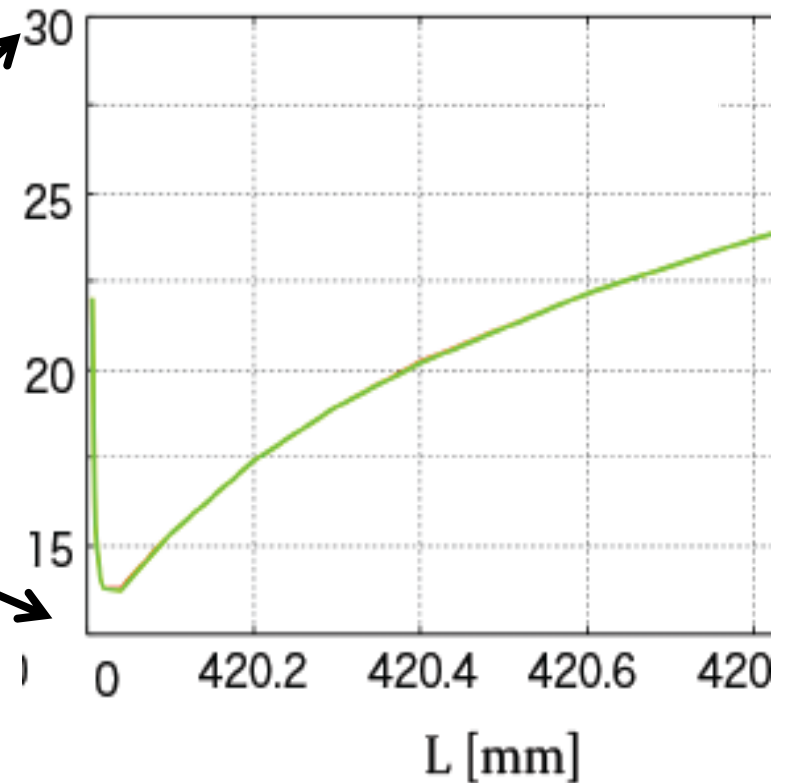
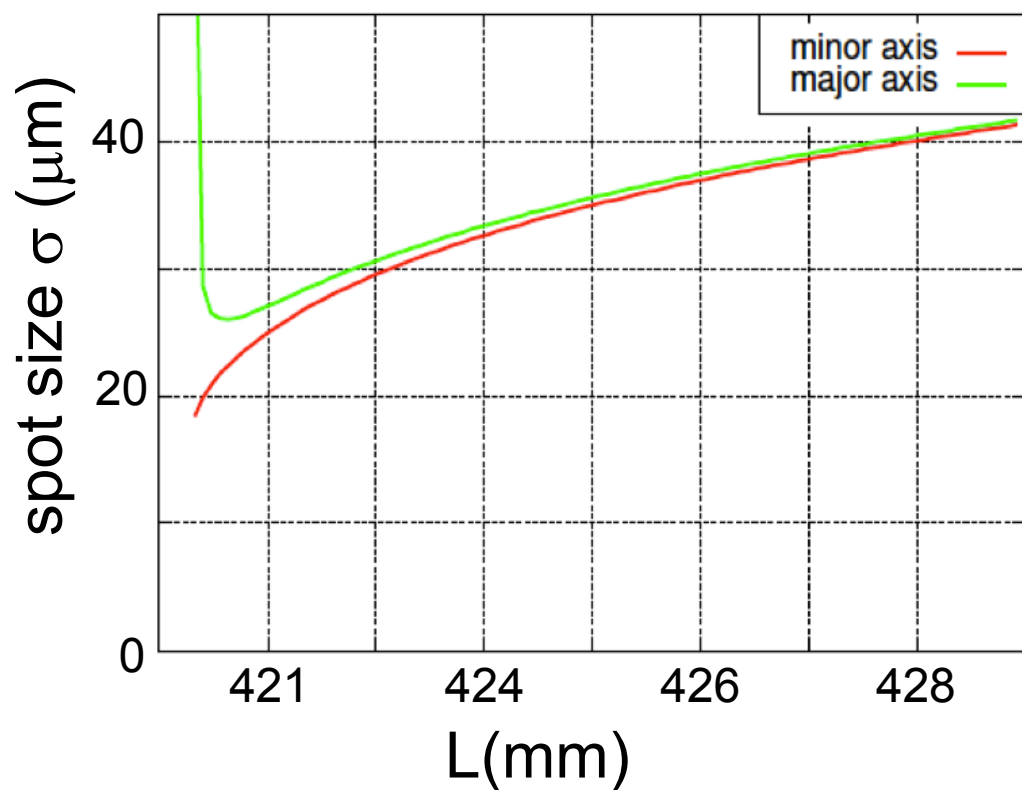

laser spot size of 15 μm is expected
with new geometry

new cavity

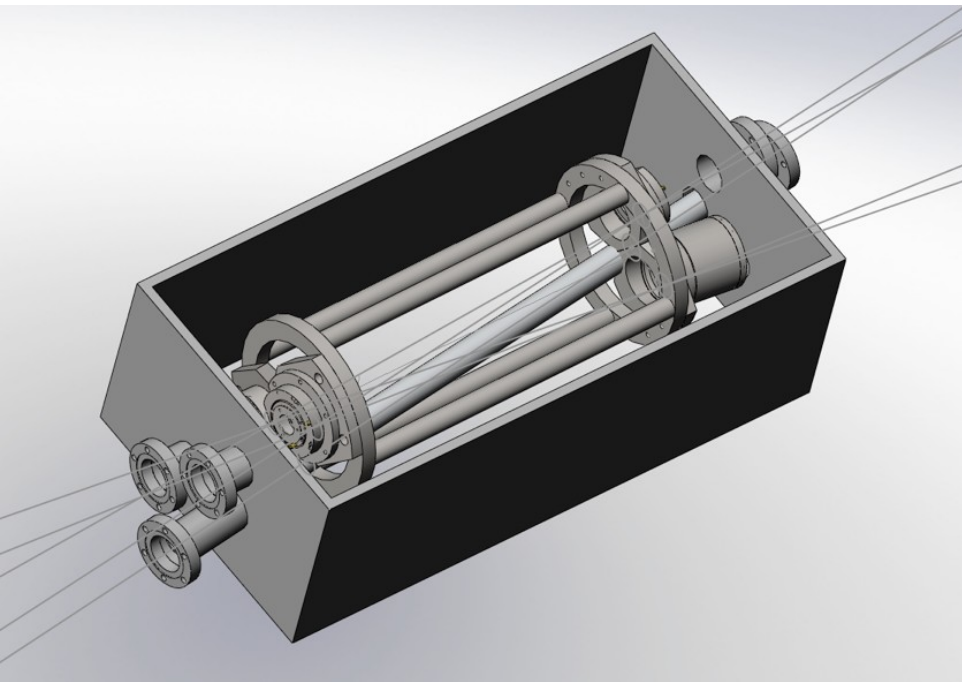
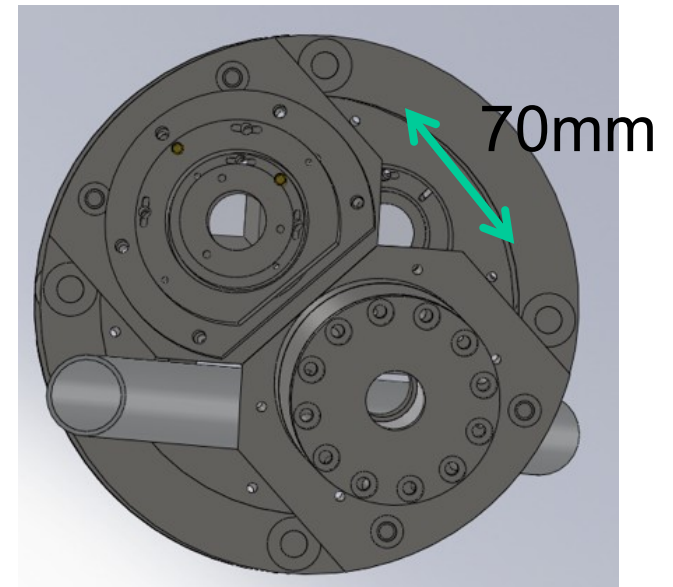
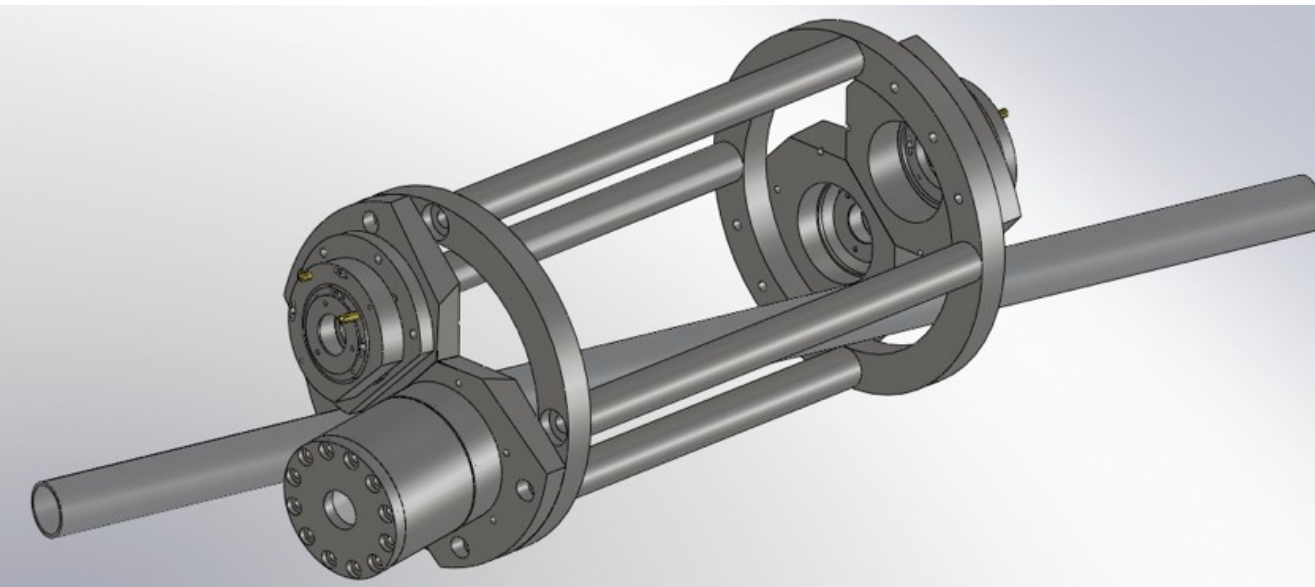

based on calculation for optimization

design being finalized
to be installed summer 2011

feedback with 3D feature

3D4M cavity resonate only with circularly polarized lasers

When the cavity is on resonance

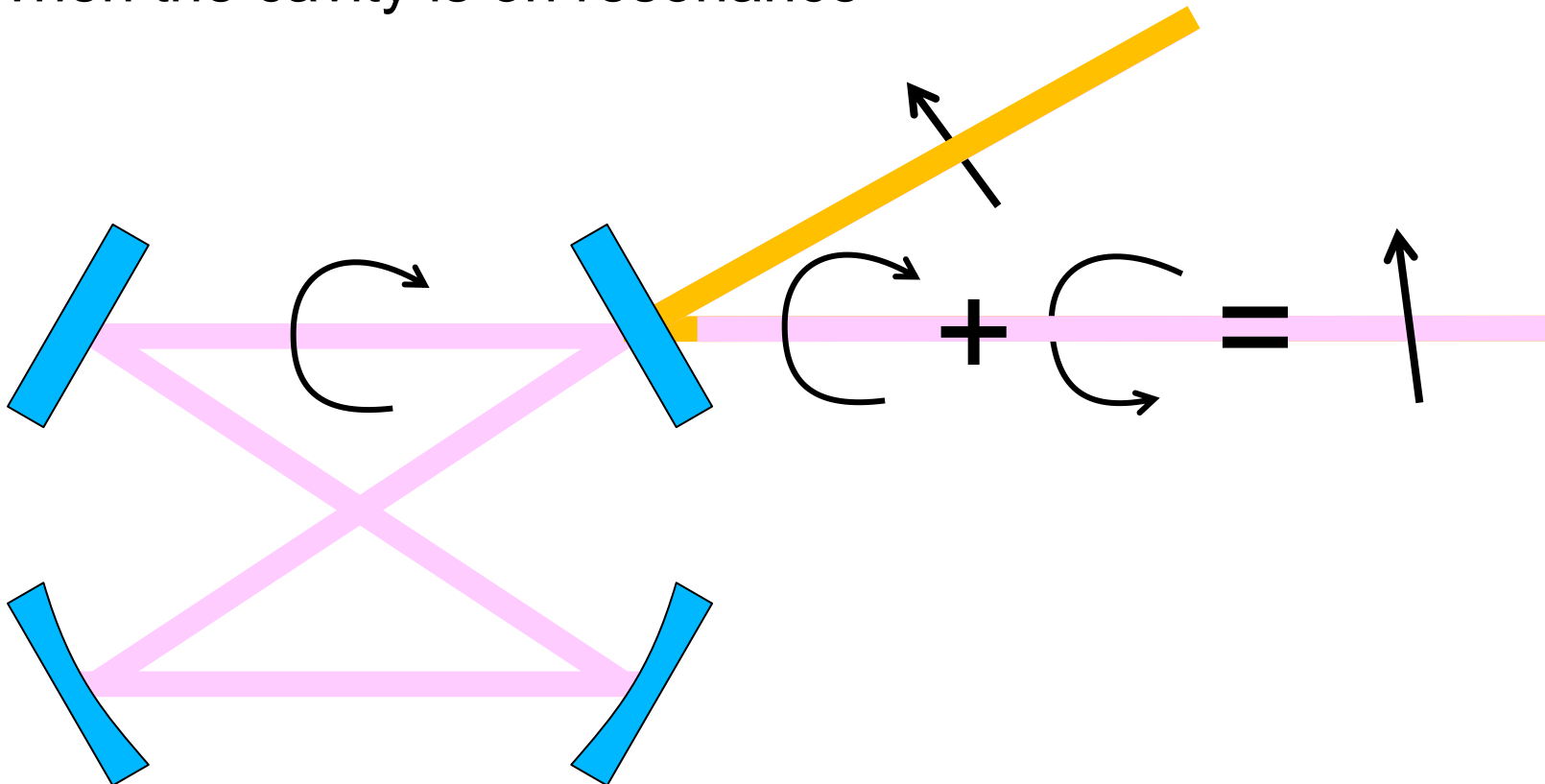

feedback with 3D feature

3D4M cavity resonate only with circularly polarized lasers

When the cavity is slightly off resonance

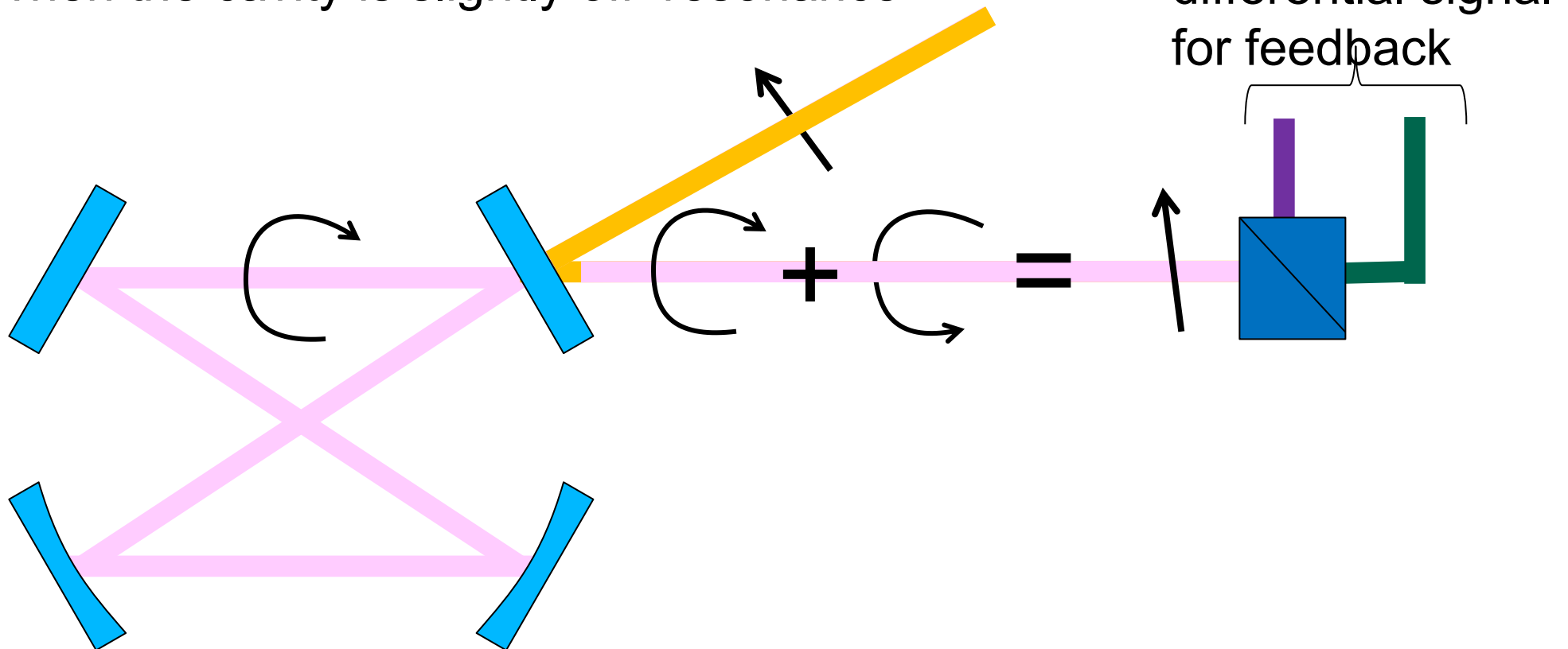

summary

- ▶ Compton experiments are on going
 - experience w/ two mirror cavity
 - 750 enhancement
 - multi-bunch measurement
 - new four mirror cavity is under construction
 - finalize design soon (Mar. 24)
 - hopefully installed summer 2011
 - new feedback scheme is understudy
- ▶ ATF will be back !