

# SLAC End Station A Test Beam

## ESTB

Carsten Hast  
SLAC National Accelerator Laboratory

ALCPG11 Eugene, Oregon  
March 22<sup>nd</sup>, 2011

# SLAC End Station A Test Beam (ESTB)

---

- Test beam activities have been interrupted by ending PEP II operation and start of LCLS
- ESTB will be a unique HEP resource
  - World's only high-energy primary electron beam for large scale Linear Collider MDI and beam instrumentation studies
  - Exceptionally clean and well-defined secondary electron beams for detector development
  - Huge experimental area, good existing conventional facilities, and historically broad user base
  - Secondary hadron beam available as an upgrade

# ESTB Proposal

---

R.Erickson, T.Fieguth, C.Hast, J.Jaros, D.MacFarlane, T.Maruyama, Y.Nosochkov, T.Raubenheimer, J.Sheppard, D.Walz, and M.Woods,

**“ESTB proposal” July 2009**

L.Keller, M.Pivi joined 2010

1<sup>st</sup> ESTB User Workshop on Thursday March 17<sup>th</sup> 2011

- 50 participants from 16 institutions and 5 countries
- 13 short presentations for proposed test beam uses
- 6 formal requests (already before the workshop)

**Underlines the broad  
community needs**



LCLS uses 1/3 of  
SLAC LINAC

An aerial photograph of the SLAC National Accelerator Laboratory. A long, narrow, light-colored structure, the SLAC LINAC, runs vertically through the center of the image. A white arrow points from a green text box to the lower portion of this structure. Below the LINAC, a large complex of buildings is visible. A white arrow points from another green text box to one of these buildings. The surrounding area consists of green fields, roads, and some trees.

End Station A



# LCLS and ESA

Use pulsed magnets in the beam switchyard to send beam in ESA.

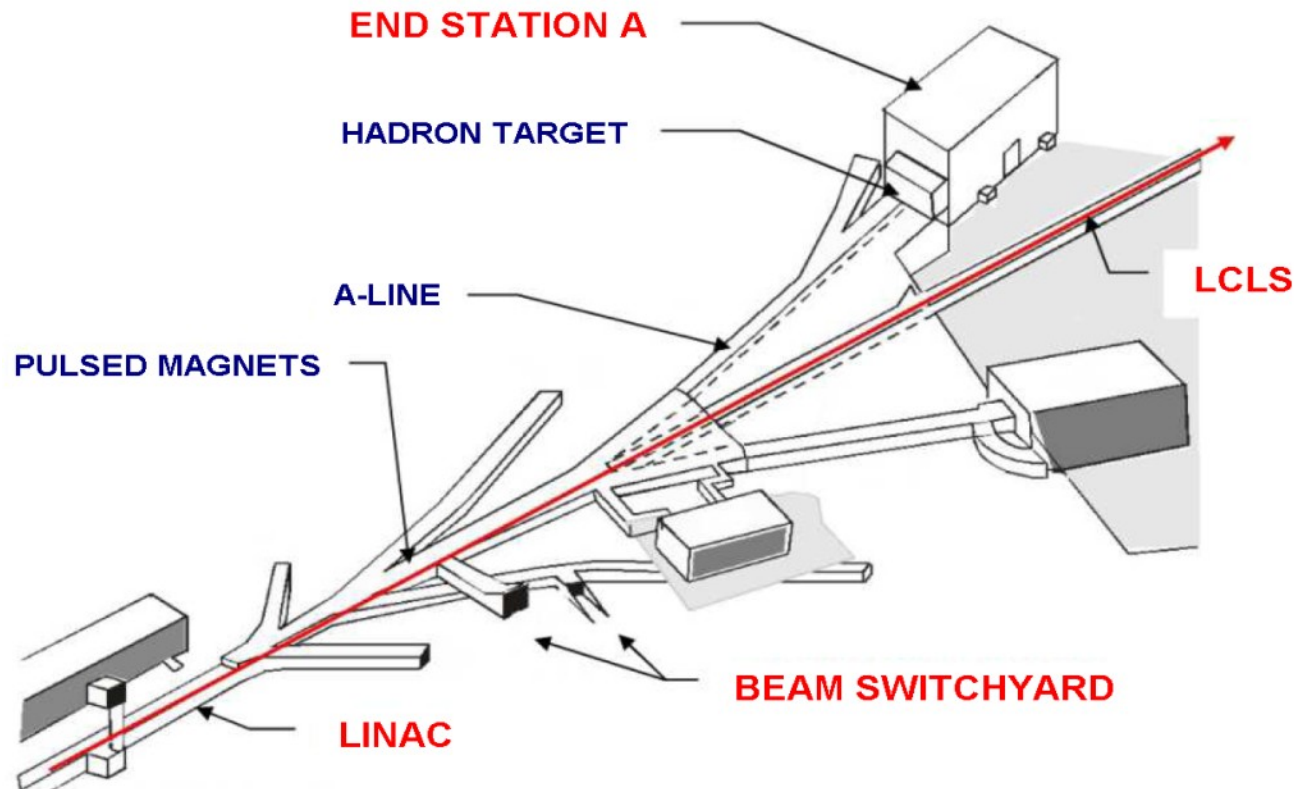



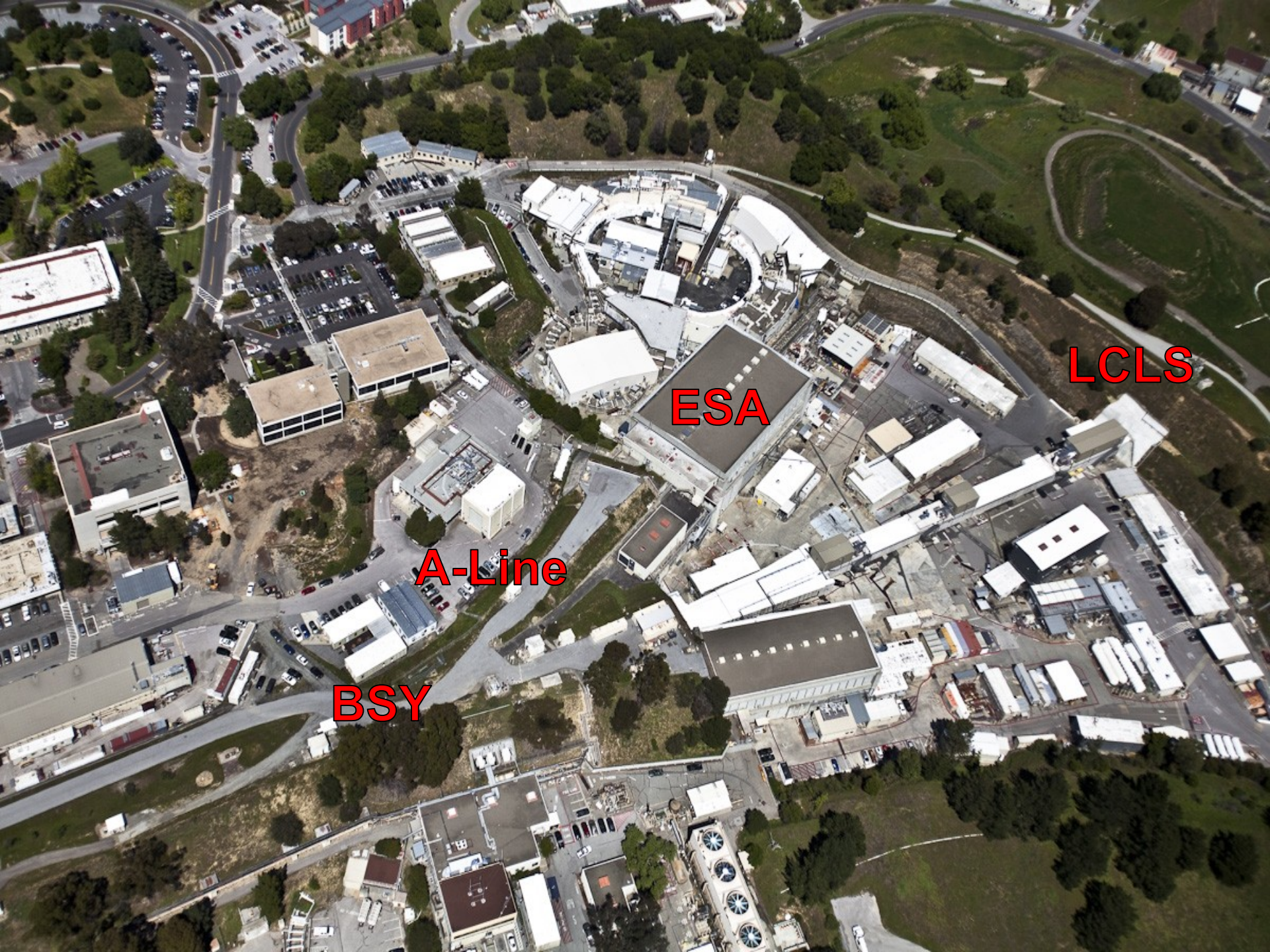

**BSY**

**A-Line**

**ESA**

**LCLS**



# LCLS/ESTB Beams

---

## LCLS beam

- Energy: 3.5 –13.6 GeV
- Repetition rate: 120Hz
- Beam current: 20 to 250 pC
  - 150 pC preferred by LCLS Users these days
- 350 pC @ 120Hz has been provided
  - This is the current upper limit for the present cathode
  - Radiation Safety approved yesterday 600 pC running!
- Beam availability >95%!

## ESTB beam

- Kick the LCLS beam into ESA @ 5 Hz
- Primary beam 3.5 -13.6 GeV
  - Determined by LCLS
  - $<1.5 \times 10^9$  e-/pulse (250 pC)
- Clean secondary electrons
  - 1 GeV to 13.6 GeV, 0.1/pulse to  $10^9$  e-/pulse

# Additional Rate: BYKIK “On”

If LCLS experiments don't need full 120 Hz rate, the remaining beam is parked out by BYKIK

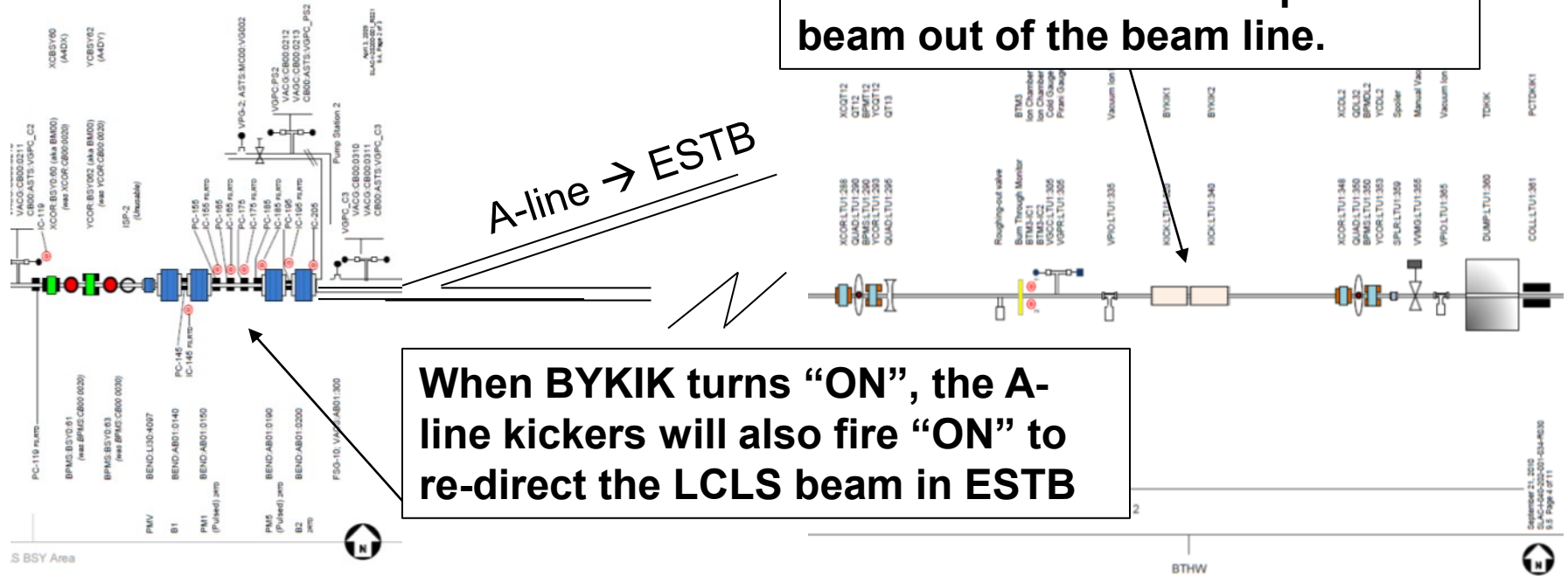

**Extra 5% of beam time at 120Hz possible**



# ESTB Hardware Needed

- 4 new kicker magnets including power supplies and modulators and vacuum chambers are designed and components are being ordered and manufactured
- Build new PPS system and install new beam dump

## A-Line Extraction:

Total Kick = 8.7 mrad

2 set of bends, 4.37 mrad  $\Rightarrow$  2.04 kG-m @ 14 GeV

7 m between the two bends

Bends based on LCLS BYKIK: 25 mm coil diameter, air-core

Distances and separations are approximate, need to check layout

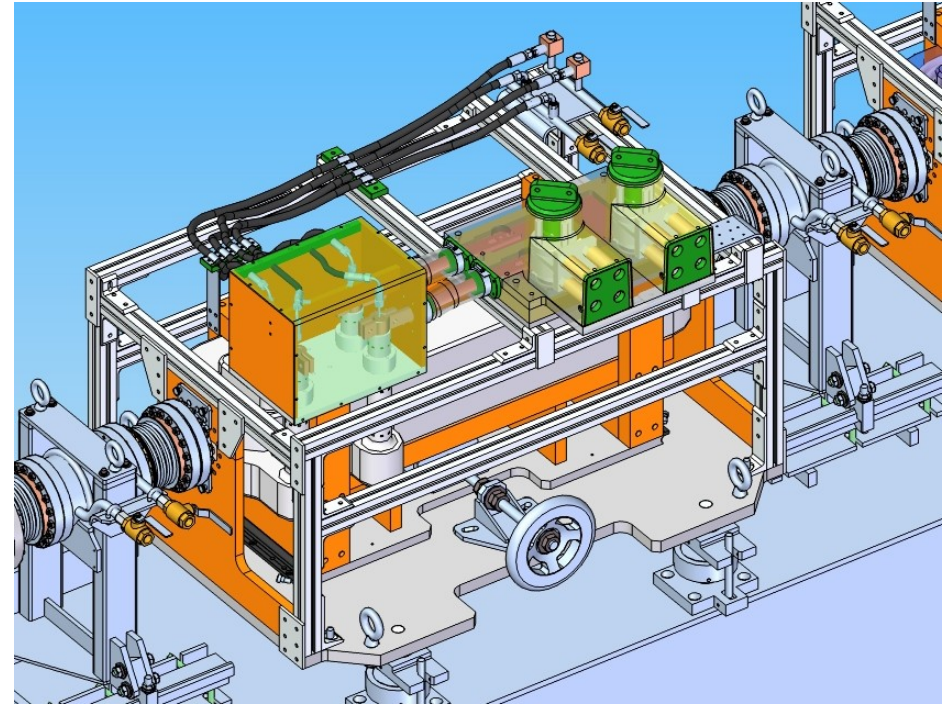
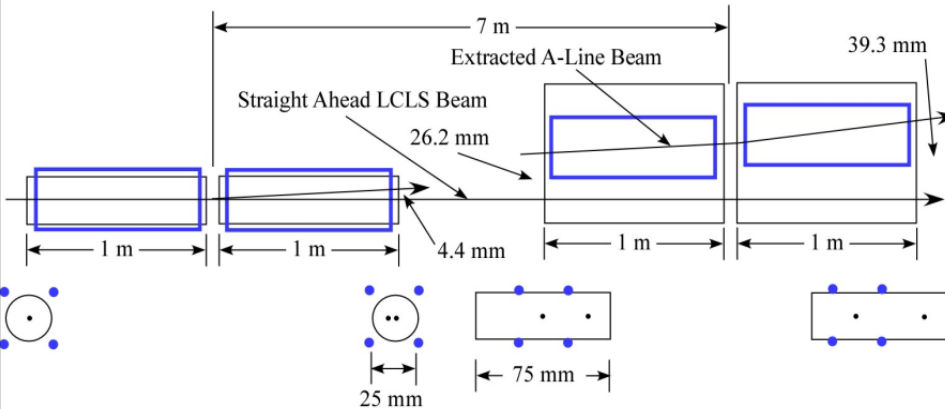

# End Station A Experimental Area

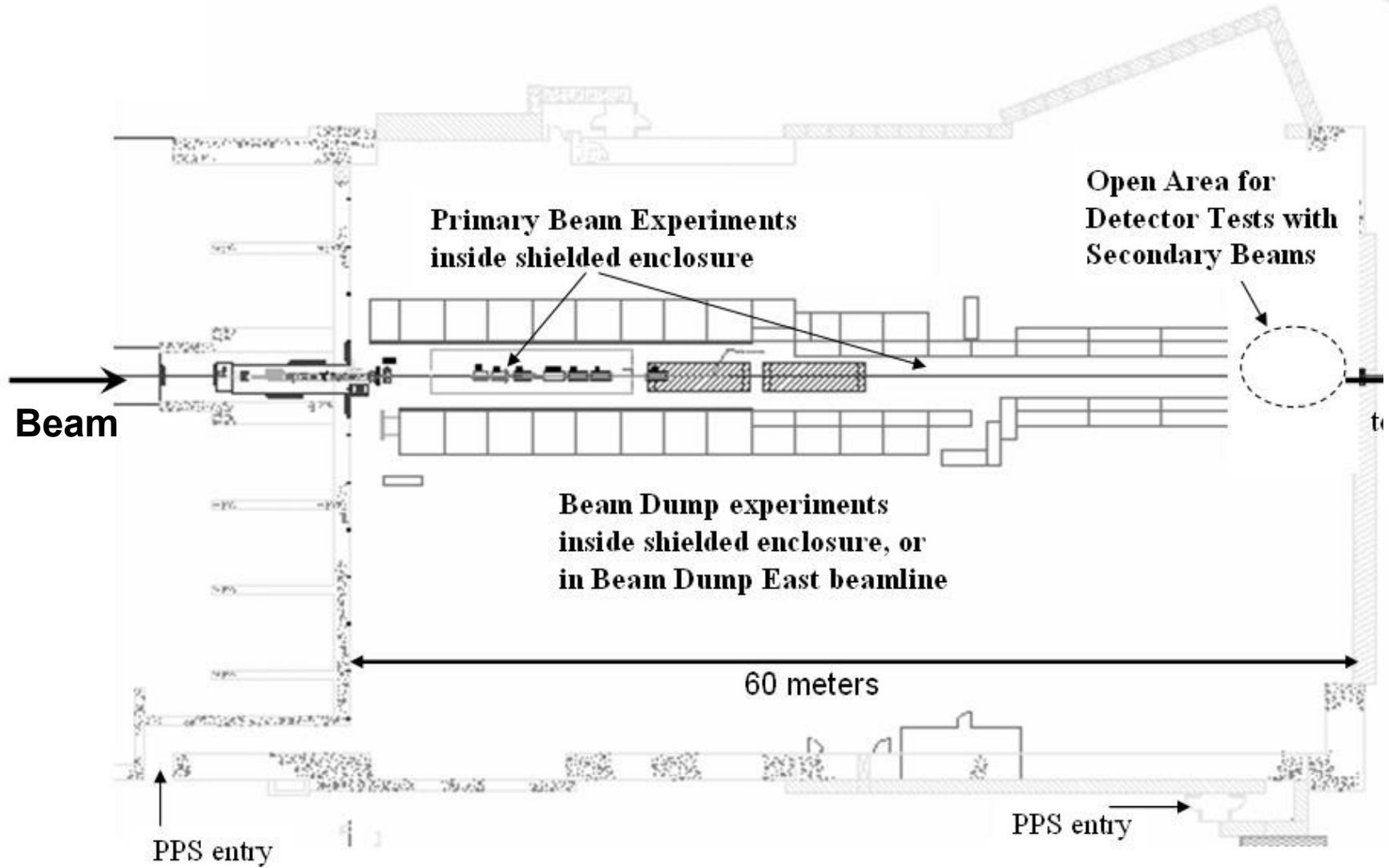

# Primary e<sup>-</sup> Beam Operations

- A full intensity, high energy e<sup>-</sup> beam
- The beam is focused in the middle of ESA

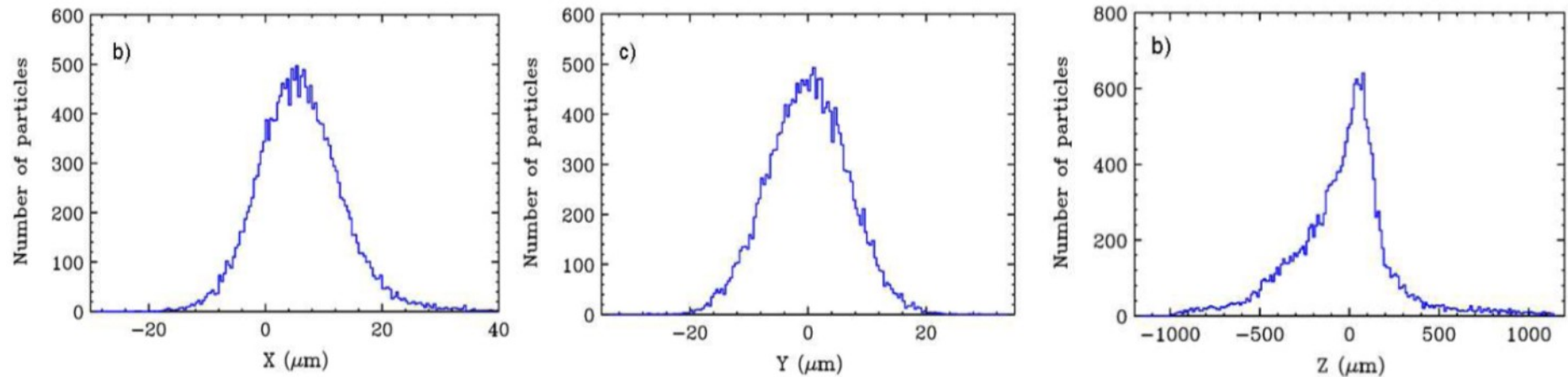

- $\sigma_x \sim \sigma_y \sim 7 \mu\text{m}$
- $\sigma_z = 280 \mu\text{m}$ 
  - 28 larger than LCLS, large R56 in A-line
- 3.5-13.6 GeV, up to 250 (maybe 350) pC



# Secondary e<sup>-</sup> Beam Operations

---

Primary beam can be directed onto a target

- Secondary e<sup>-</sup> are momentum-selected in A-line
  - 1 GeV (maybe, has been done in the past)
  - 2 GeV for most likely
  - 4 - 13 GeV easy,  $10^{-4}$  momentum resolution
- Adjusting 2 existing collimators
  - 0.1 -  $10^9$  particles/pulse

# Tagged Photon Beam in ESA

GLAST/Fermi test 1999

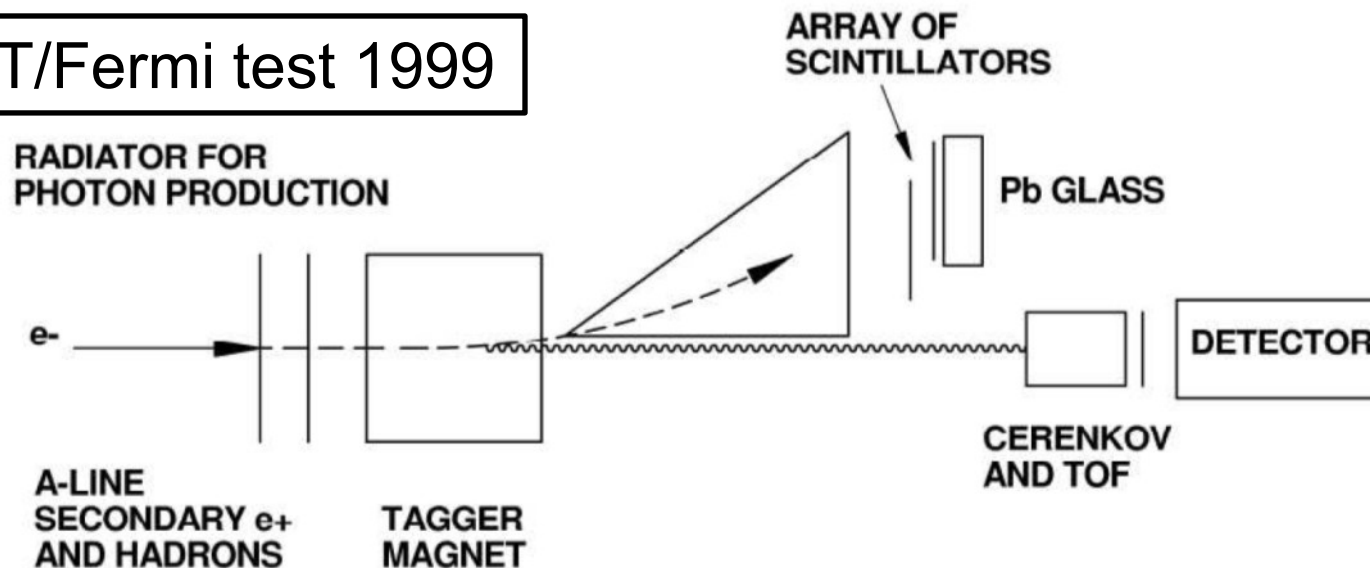

- 2<sup>nd</sup> e<sup>-</sup> beam hits thin radiator in ESA
- Bend e<sup>-</sup> off axis and measure displacement = energy of e<sup>-</sup>
- tagging the photon energy

We need 10cm by 2cm, 100  $\mu\text{m}$  pitch Si strip detector  
**Donations welcome!**

# ESTB Stage II: Hadron Production

- Add Be target, beam dump, analyzing magnet, momentum slit, and quadrupole doublets to produce a secondary hadron beam
- Production angle =  $1.35^\circ$  and Acceptance =  $10 \mu\text{sr}$

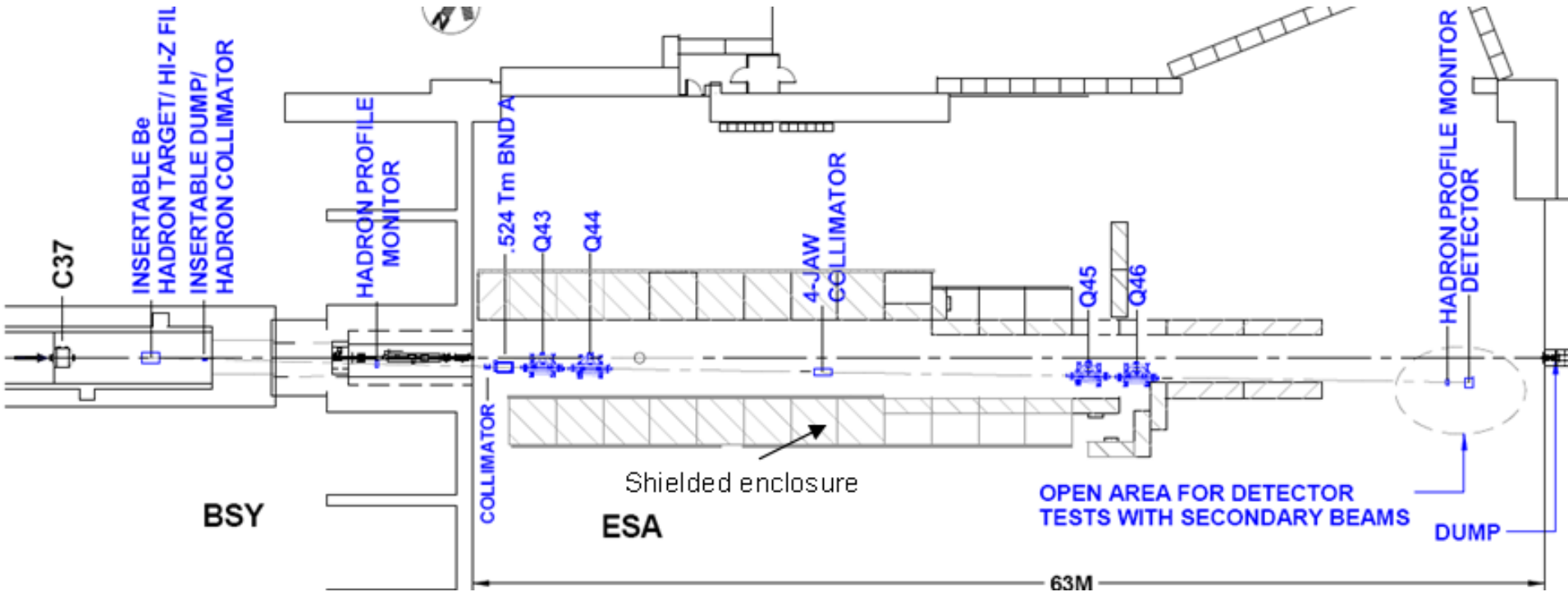



# Secondary Hadron Beam Properties

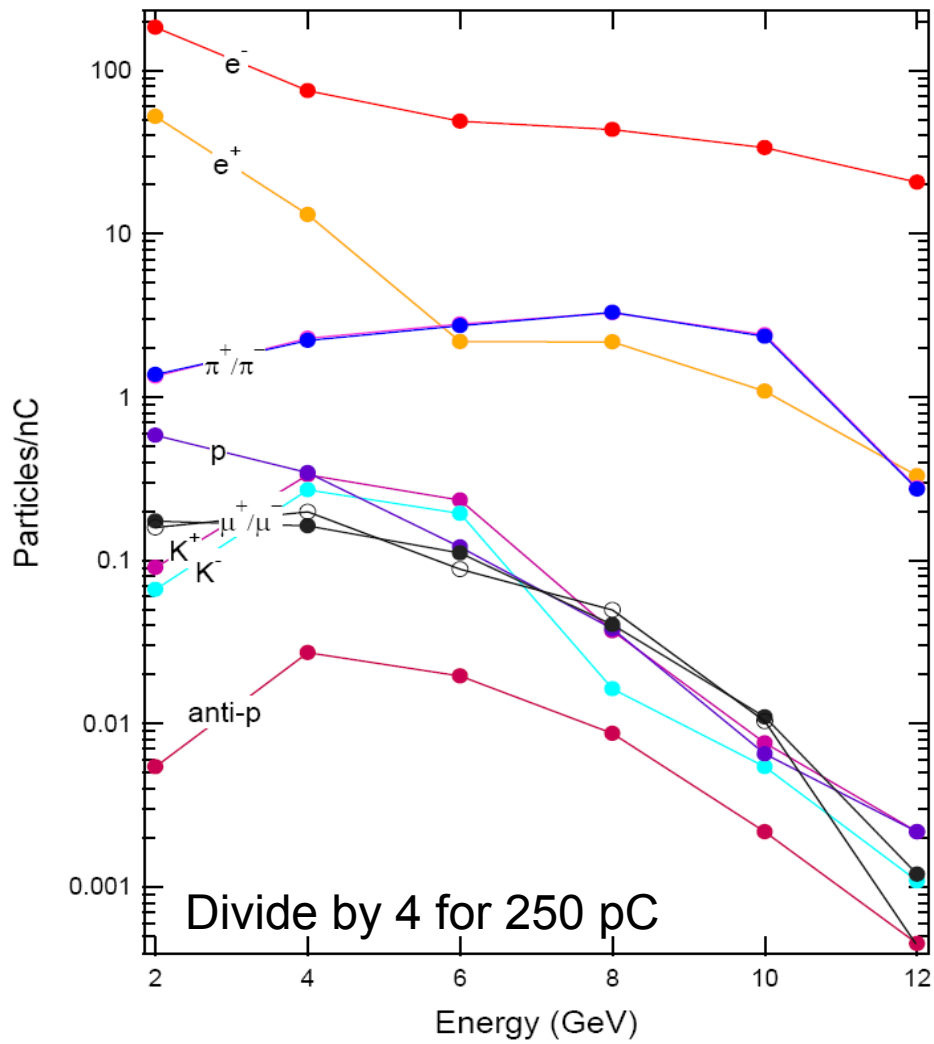

## Beam Properties at Detector Plane

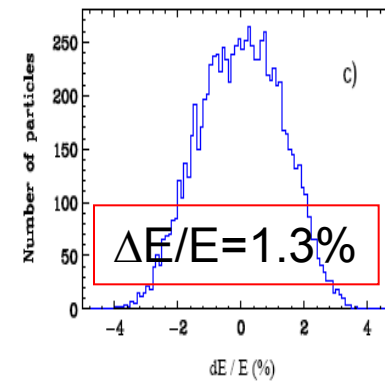
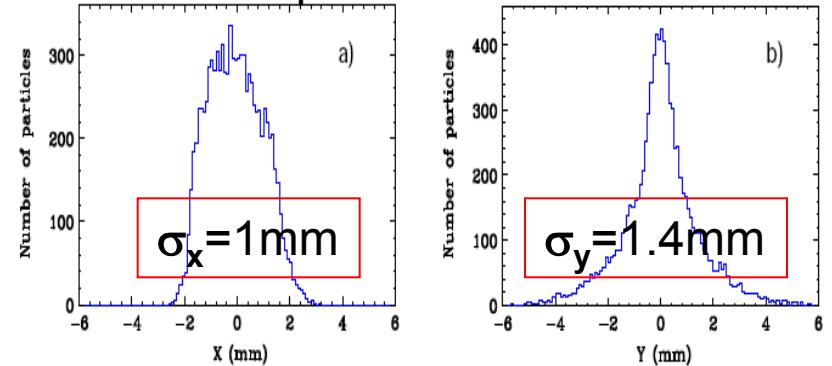

$\pi$  produced 1/0.25nC beam

Protons and Kaons at  $\sim 0.02/0.25\text{nC}$

# Secondary Hadron Beam Properties

---

**Production of Hadrons  
would add  
desirable capabilities to  
ESTB**

**But:  
Not Funded**

**We need User Requests!!!**

# Proposals

- [Test of the SSD Electronics for STAR HFT Upgrade](#)
- [Pixel Sensors for ATLAS Upgrades](#)
- [STAR Pixel Detector](#)
- [Fermi Large Area Telescope](#)
- [LC detector: Silicon-Tungsten Calorimeter](#)
- [Super B R&D](#)
- [Energy Spectrometry](#)
- [CLIC Wakefield Collimator Studies](#)
- [Radiation Physics Beam Tests](#)
- [Beamcal Radiation Damage Study](#)
- [Geosynchrotron Radio Emission from Extensive Air Showers](#)
- [Modeled pulse function for waveform analysis using DRS4](#)

Howard Matis, LBNL

Philippe Grenier, SLAC

Leo Grenier, LBNL

Elliott Bloom, SLAC

Ray Frey, University of Oregon

Jerry Va'Vra, SLAC

Mike Hildreth, Notre Dame University

Roger Jones, Cockcroft/Manchester U

Mario Santana, SLAC

Bruce Schumm, UC Santa Cruz

Konstantin Belov, UCLA

Andriy Zatserklyaniy, Puerto Rico Univ.



# Schedule

---

- This Down Time (now to mid May)
  - We install one BSY kicker with a stainless steel vacuum chamber
- End of May LCLS starts up and runs until Christmas (one week off in October)
- Mid of June FACET runs until August
- Mid of July ESTB can do first test of kicking a 4GeV beam into A-line
- ESA PPS becomes available this summer
  - 4GeV primary beam to ESA
  - 4-14GeV secondary electron beam to ESA
- Commissioning of ESA infrastructure September/October
- Oct 25<sup>th</sup> – Nov 1<sup>st</sup> install 4 BSY kicker magnets with ceramic chambers
- First ESTB run in November and December (need commissioning time)
- Linac off from Christmas to end of January
- ESTB running resumes February 2012
- SLAC downtimes are in Aug/Sept and over Christmas for the next years

# Summary

---

- We are excited to re-start ESA test beams!
  - Unique High energy test beam line in the US, with plenty of infrastructures and SLAC support for Users
- We install a short-term system for  $e^-$  beams in ESTB with commissioning by summer
  - 4 GeV full intensity or up to 13.6 GeV 2<sup>nd</sup>  $e^-$  beams
- Installation of the full 4 kicker system by end October
  - First ESTB run in November / December 2011
- Beam parameters determined by LCLS. Availability 5Hz. Some opportunities to increase rate when not needed for LCLS.
- Hadron beam line upgrade needs user requests and funding

**See you all at SLAC soon!**