

Goal of this working group (Mark Ross)

- Review and discuss ongoing R&D to understand how it is to be included in the TDR. Special focus should be given to those changes which could substantially impact system interfaces and/or project cost.
- Evaluate the potential of R&D on alternates and upgrades to be carried out after the TD phase. This fits well with the emphasis on the 1 TeV upgrade and cost containment.
- Develop a schedule for the next 12 months that leads to the start of the actual writing and editing of the TDR and allows the collection of key supporting documents.



TDR Preparation Baseline Technical Reviews

Baseline Technical Reviews		
Area / Group	When	Where
DR	Summer 2011	INFN or Cornell
RTML	Summer 2011	Fermilab
BDS	Fall 2011	DESY
Sources	Fall 2011 (Early December)	SLAC or ANL
SCRF / Main linac integration	Winter 2011 / 2012	KEK
CFS	Winter 2011 / 2012	Fermilab



ILC RDR baseline schematic

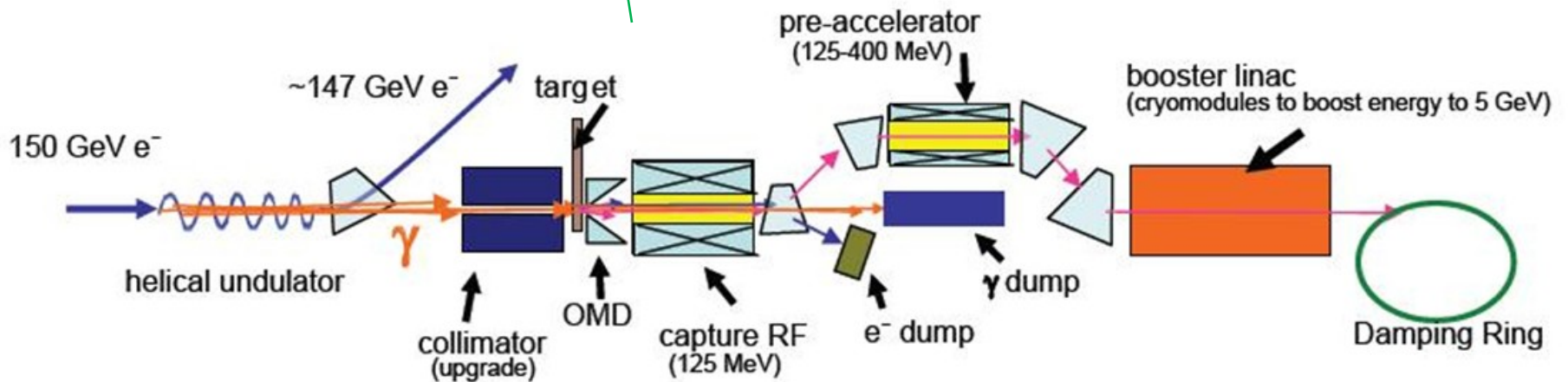
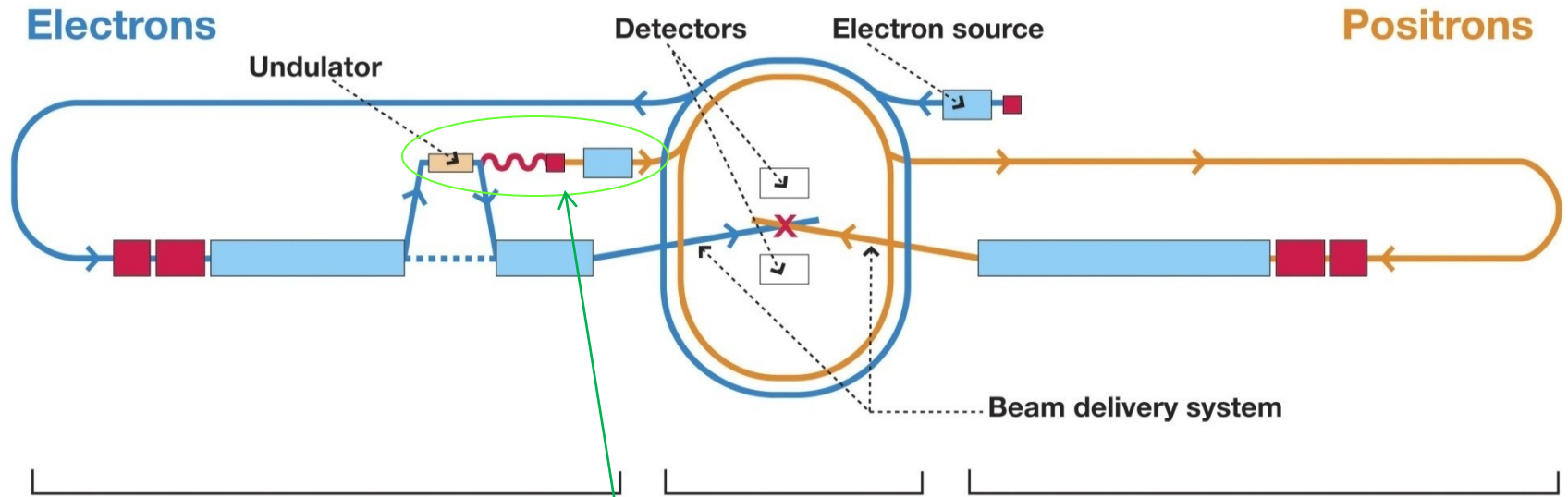

Location of sources at the ILC

RDR:

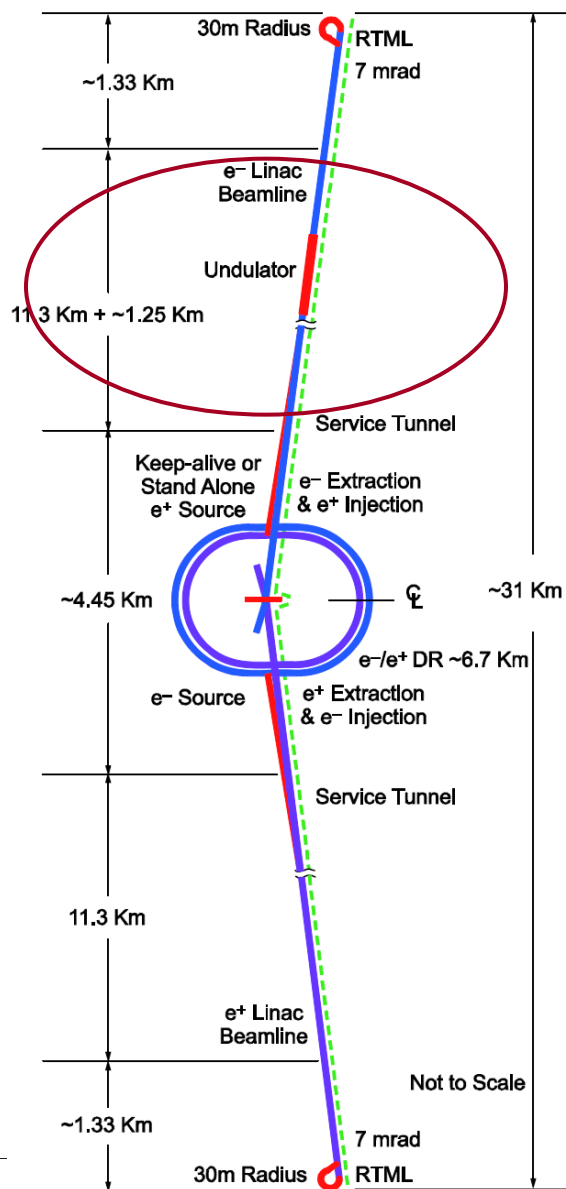

SB2009

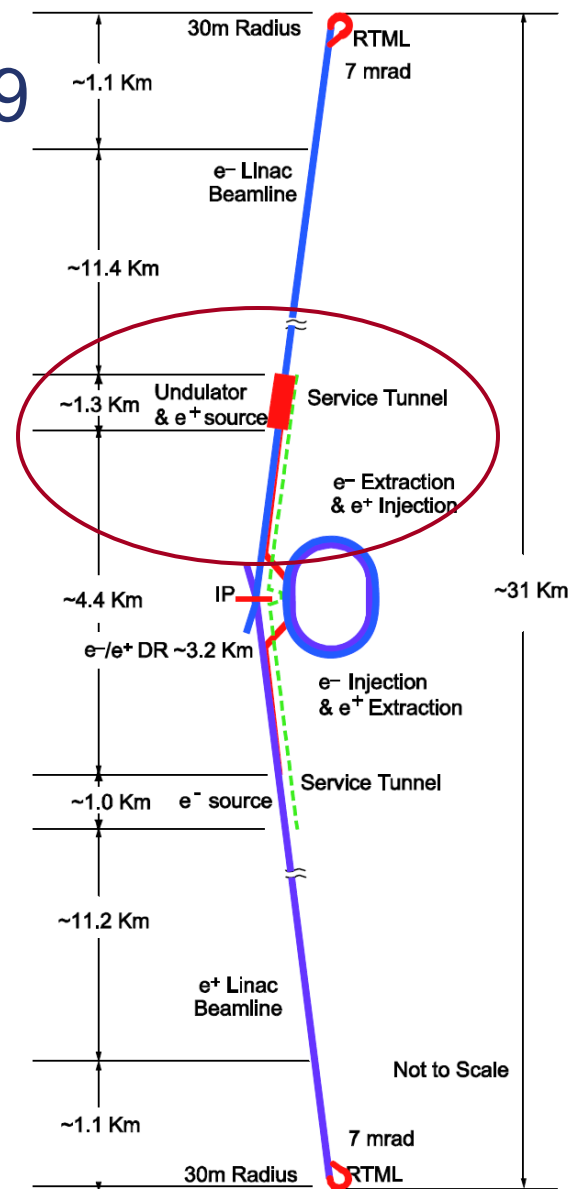

Parameters:

- Optimize the positron yields for known technologies:
 - Superconducting helical undulator.
 - Undulator parameter: $K=0.92$, $\lambda_u=1.15\text{cm}$
 - Capturing magnets
 - Optical matching device: FC and $\frac{1}{4}$ wave transformer
 - Targets: 0.4 X0 Ti, W and liquid Pb also considered (not covered in this talk).
- Damping ring acceptance
 - Energy spread $< 1\%$
 - $\text{emittance}_x + \text{emittance}_y < 0.09 \text{ m-rad}$
- Goal:
 - Achieve yield of 1.5 positrons per electron in the drive beam.
 - No polarization required.
 - Polarization required.
- A parameter table developed (thanks for the efforts from Nick, Sabine, Norbert and Jim)
 - Will distribute through EMDS
 - But I can email to anyone right now.



Summary Parameters (Sabine Riemann, 2011)

Parameter	RDR	SB2009	Units
e+ per bunch at IP	2 x 10 ¹⁰	1 to 2 x 10 ¹⁰	
Bunches per pulse	2525	1312	
e+ energy (DR injection)	5	5	GeV
DR transverse acceptance	0.09	0.09	m-rad
DR energy acceptance	±0.5	± 0.5	%
e- drive beam energy	150	125-250	GeV
e- energy loss in undulator	3.01	0.5-4.9	GeV
Undulator period	11.5	11.5	mm
Undulator strength	0.92	0.92	
Active undulator length	147 (210 after pol. Upgrade)	231 max.	m
Field on axis	0.86	0.86	T
Beam aperture	5.85	5.85	mm
Photon energy (1 st harm.)	10	1.1 (50 GeV) 28 (250 GeV)	MeV
Photon beam power	131	Max: 102 at 150 GeV	kW
Target material	Ti-6%Al-4%V	Ti-6%Al-4%V	
Target thickness	14	14	mm
Target power adsorption	8	8	%
PEDD in target			
Dist. Undulator center - target	500	500	m
e+ Polarization	34	22	%



Status of the critical hardware components

- 4 meter cryo-module, two 1.7m long RDR undulator. (Completed, STFC/RAL/Daresbury)
- Target wheel prototype design and test. (Lancaster/Cockcroft/STFC/LLNL)
- Rotating vacuum seal prototype test. (LLNL, ongoing)
- Capturing RF structure. (SLAC, Completed)
- Flux Concentrator prototype design. (LLNL, ongoing)
- New short period, high K undulator. (Cockcroft/STFC, ongoing).



ILC Positron source optimization: Cases Studied:

- Common Input Parameters:
 - Undulator parameter: $K=0.92$, $\lambda_u=1.15\text{cm}$
 - Target: 0.4 X0 Ti
 - Drift between undulator and target: 400m
 - Photon collimator: None
- OMD:
 - Flux Concentrator Capturing (137 m long Undulator).
 - Quarter Wave Transformer Capturing (231 m long undulator).
- Undulator Impacts on Drive Beam
 - Energy Spread and,
 - Emittance
- Target Energy Deposition.
- Path toward higher polarizations
 - Photon collimators



A pulsed flux concentrator

- Pulsing the exterior coil enhances the magnetic field in the center.
 - Needs ~ 1 ms pulse width flattop
 - Similar device built 40 years ago. Cryogenic nitrogen cooling of the concentrator plates.

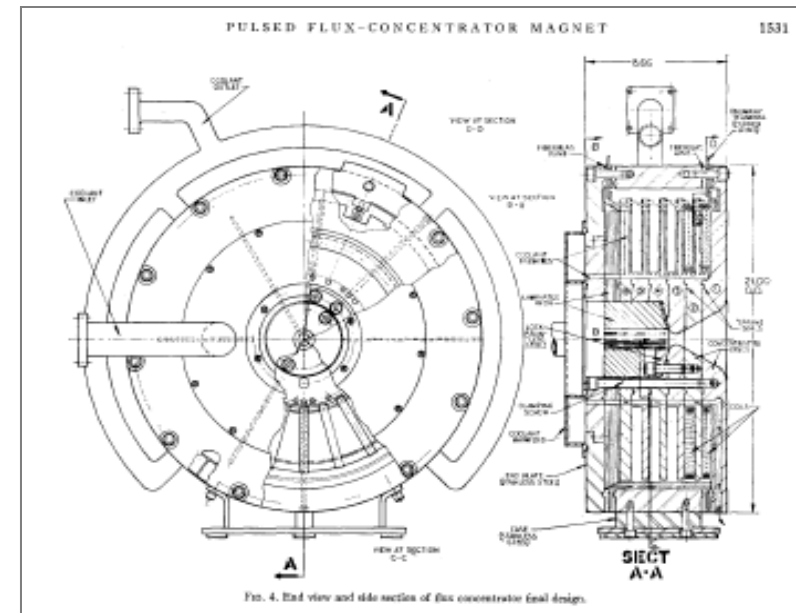
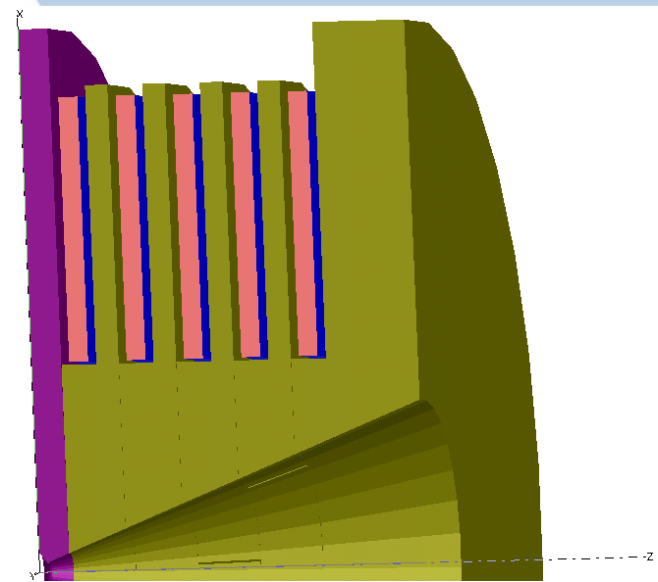
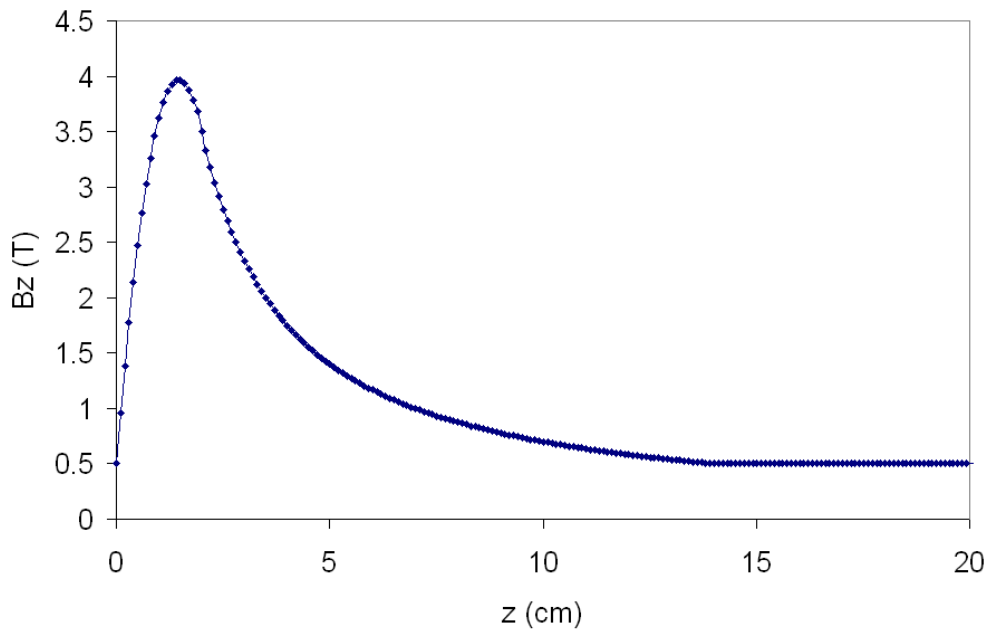

Yield Calculations Using RDR Undulator Parameters (137 meter and FC without photon collimators)

Drive beam energy	Yield	Polarization	Required Undulator Length for 1.5 Yield	Emittance Growth X/Y for 1.5 Yield*	Energy Spread from Undulator for 1.5 Yield
50 GeV	0.0033	0.42	Very long		
100 GeV	0.2911	0.39	685 m		
150 GeV	1.531	0.34	137 m	~ -2.5%/-1.6%	0.17%
200 GeV	3.336	0.27	61 m		
250 GeV	5.053	0.23	40 m	~-1%/-0.4%	0.18%

* No Quads misalignment included.



Emittance growth due to BPM to Quad misalignments

-- From Jim Clark's report

Table 2 Summary of the vertical emittance growth results due to BPM to quadrupole misalignments.

	BPM to quadrupole Error (μm)	Vertical emittance growth (%)	Correction algorithm
ANL	20	5	None
Daresbury	10	8	SVD
Daresbury	20	15	SVD
Kubo	10	2	Kick minimisation
Schulte	10	5	Dispersion free
Schulte	10	10	Dispersion free (restricted energy range)
Schulte	30	10	Kick minimisation



RDR undulator, Quarter Wave Capturing Magnet

- Undulator: RDR undulator, $K=0.92$, $\lambda_u=1.15\text{cm}$
- Length of undulator: 231m
- Target to end of undulator: 400m
- Target: 0.4X0, Ti
- Drive beam energies: 50GeV to 250GeV
- Reference: 150 GeV

1/4 wave solenoid

- Low field, 1 Tesla on axis, tapers down to 1/2 T.
- Capture efficiency is only 25% less than flux concentrator
- Low field at the target reduces eddy currents
- This is probably easier to engineer than flux concentrator
- SC, NC or pulsed NC?

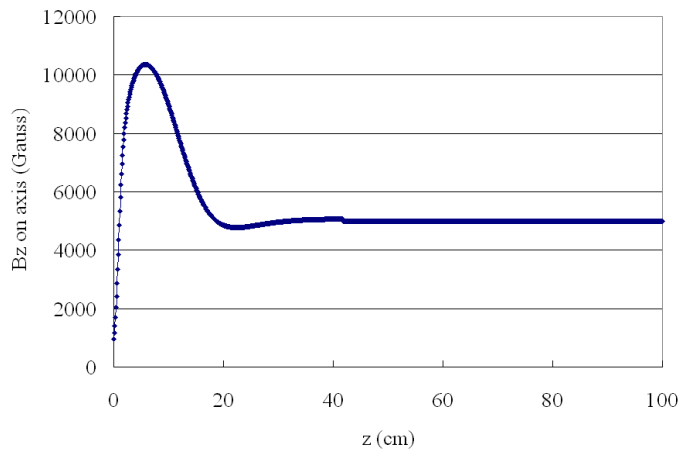

ANL 1/4 wave solenoid simulations

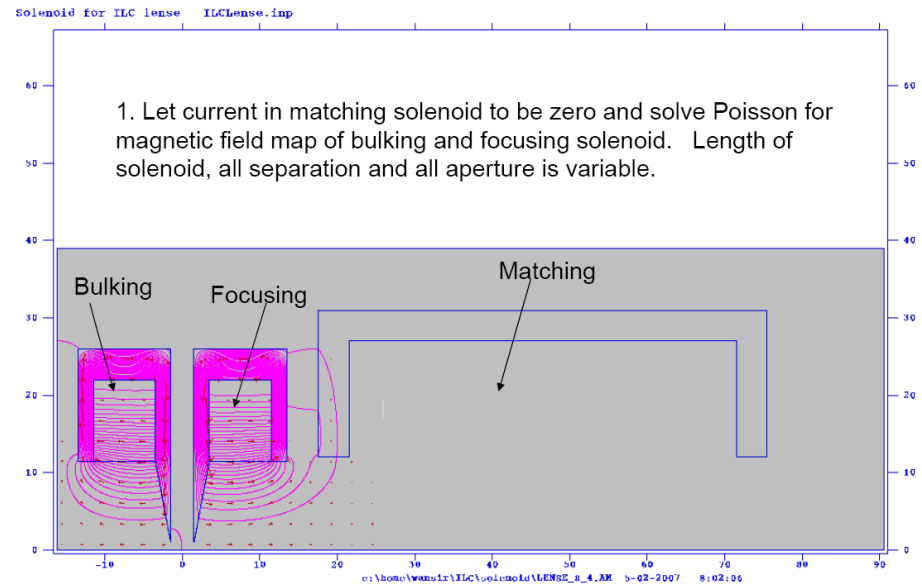

The target will be rotating in a B field of about 0.2T

W. Liu

Yield and polarization of RDR configuration for different drive beam energy

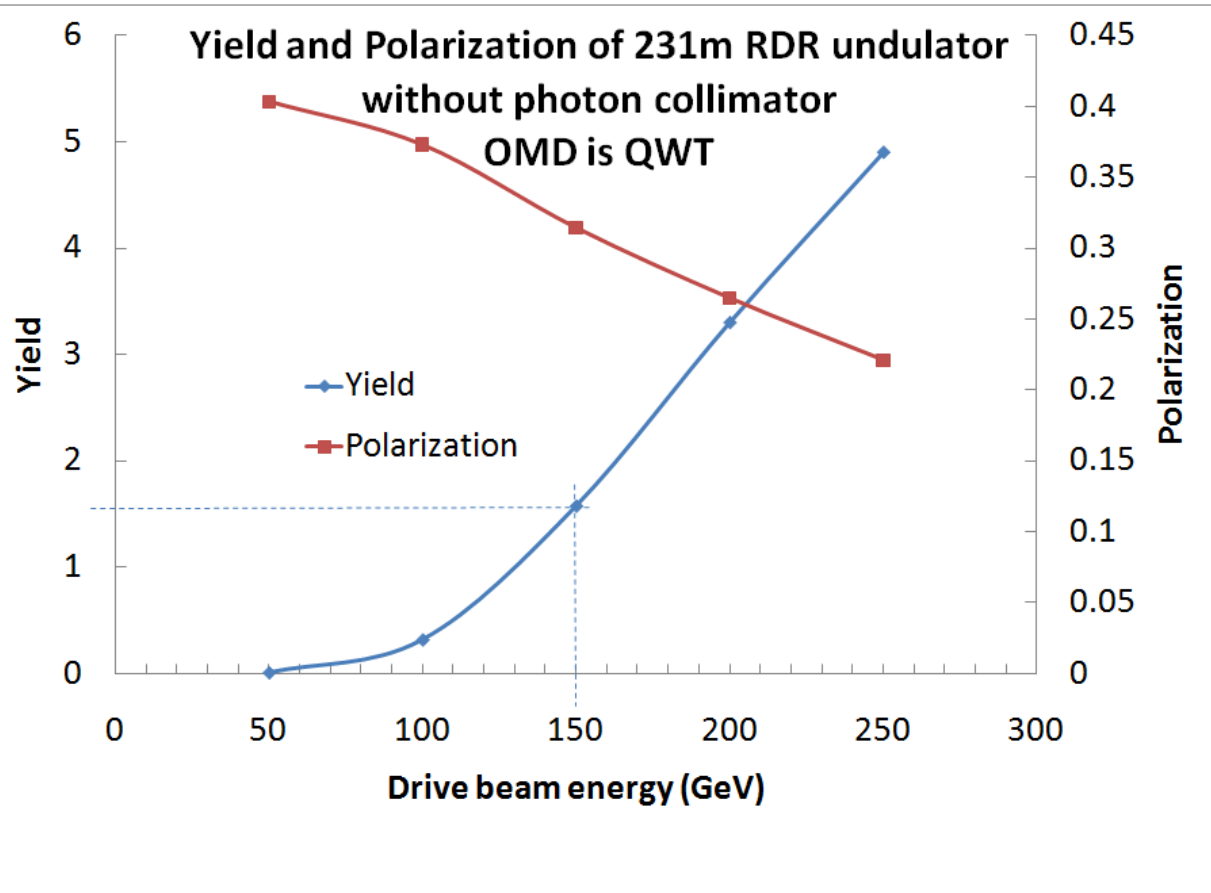

Drive beam energy	Energy lost per 100m	Energy lost for 1.5 yield
50GeV	~225MeV	N/A
100GeV	~900MeV	~9.9GeV
150GeV	~2GeV	~4.6GeV
200GeV	~3.6GeV	~3.7GeV
250GeV	~5.6GeV	~3.96GeV

Drive beam energy	Yield	Polarization
50GeV	0.0041	0.403
100GeV	0.3138	0.373
150GeV	1.572	0.314
200GeV	3.298	0.265
250GeV	4.898	0.221



OMD comparison

- Same target
- Beam and accelerator phase optimized for each OMD
- OMD compared:
 - AMD
 - Flux concentrator
 - $\frac{1}{4}$ wave transformer
 - Lithium lens

OMD	Capture efficiency
Immersed target, AMD (6T-0.5T in 20 cm)	~30%
Non-immersed target, flux concentrator (0-3.5T in 2cm, 3.5T-0.5T 14cm)	~26%
1/4 wave transformer (1T, 2cm)	~15%
0.5T Back ground solenoid only	~10%
Lithium lens	~29%



Yield calculations

- So far, we calculated the yield of 1.5 at 125 MeV, ANL and DESY results are all in agreement.
- Ongoing calculation for different scenarios.
- Need to have a dogleg and a lattice design that will accelerate beam to 400 MeV first and then 5 GeV with low losses, as shown in Norbert's report. This lattice should be simpler, only one dogleg, no long transport line as in RDR. Need to be finalized before the TDR.
- This is urgent; spin tracking also needs the lattice design.
- DESY and ANL will work on this.



Energy deposition/accumulation on Target with RDR undulator



Density of accumulated deposit energy (for RDR rotating target)

1.5 yield / 3×10^{10} e ⁺ captured,	Ti target (density= 4.5 g/cm^3)				
	Thickness for highest yield (X0)	Energy deposition per bunch (J.)	Average power (KW)	Peak energy density	
				(J/cm^3) ;	(J/g)
150GeV,FC (137 m)	0.4	0.72	9.5	348.8	77.5
250GeV, FC (40 m)	0.4	0.342	4.5	318.8	70.8
150GeV, QWT (231 m)	0.4	1.17	15.3	566.7	126
250GeV, QWT (76 m)	0.4	0.61	8.01	568.6	126.4





Shockwaves in the target

- Energy deposition causes shockwaves in the material
 - If shock exceeds strain limit of material chunks can spall from the face
- The SLC target showed spall damage after radiation damage had weakened the target material.
- Initial calculations from LLNL had shown no problem in Titanium target
- Two groups are trying to reconfirm result
 - FlexPDE (S. Hesselbach, Durham → DESY)
 - ANSYS (L. Fernandez-Hernando, Daresbury)
 - No definitive results yet
- Investigating possible shockwave experiments
 - FLASH(?)
 - <https://znwiki3.ifh.de/LCpositrons/TargetShockWaveStudy>



Contours of P in MPa

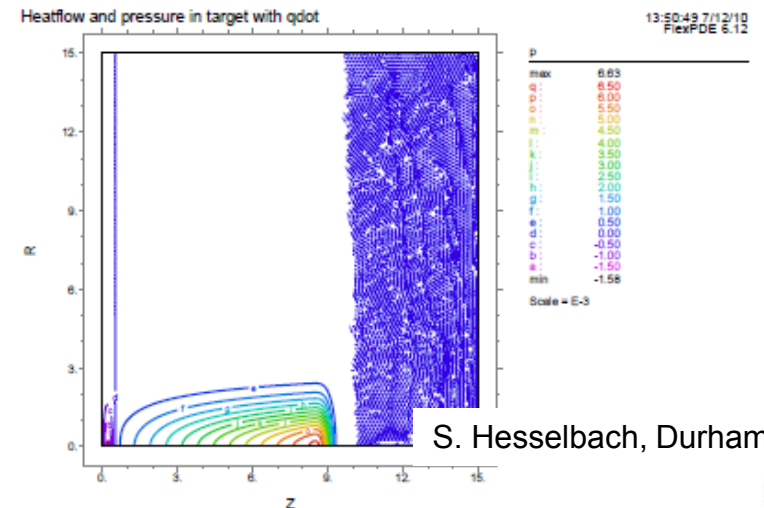



Remote Handling

- Use detailed target, RF, etc model in Fluka – Andriy
- Send CAD model to DESY for RH items – Norbert
- Can RH be accessed when target removed? – Andriy
- RH scenarios refined
 - **Changeover times (requirement ties in with lifetime of kit in RH)**
 - **Replacement of pillow seals?**
- Pillow seals need R&D
- Need engineered design compatible with source layout (remove inconsistencies!)
- If yield increases then RH not needed (limited only?)

From J. Clarke, 7th collaboration meeting DESY 2010

High K and short period λ Undulator Option

- Important to SB2009 scenarios.
- Assumptions:
 - Length of undulator: 231m
 - Drive beam energy: 100GeV
 - Target: 0.4X0, Ti
 - Photon Collimation: None
 - Drift to target: 400m from end of undulator
 - OMD:FC, 14cm long, ramping up from 0.5T to over 3T in 2cm and decrease adiabatically down to 0.5T in 12cm.



High K, short period, 100GeV drive

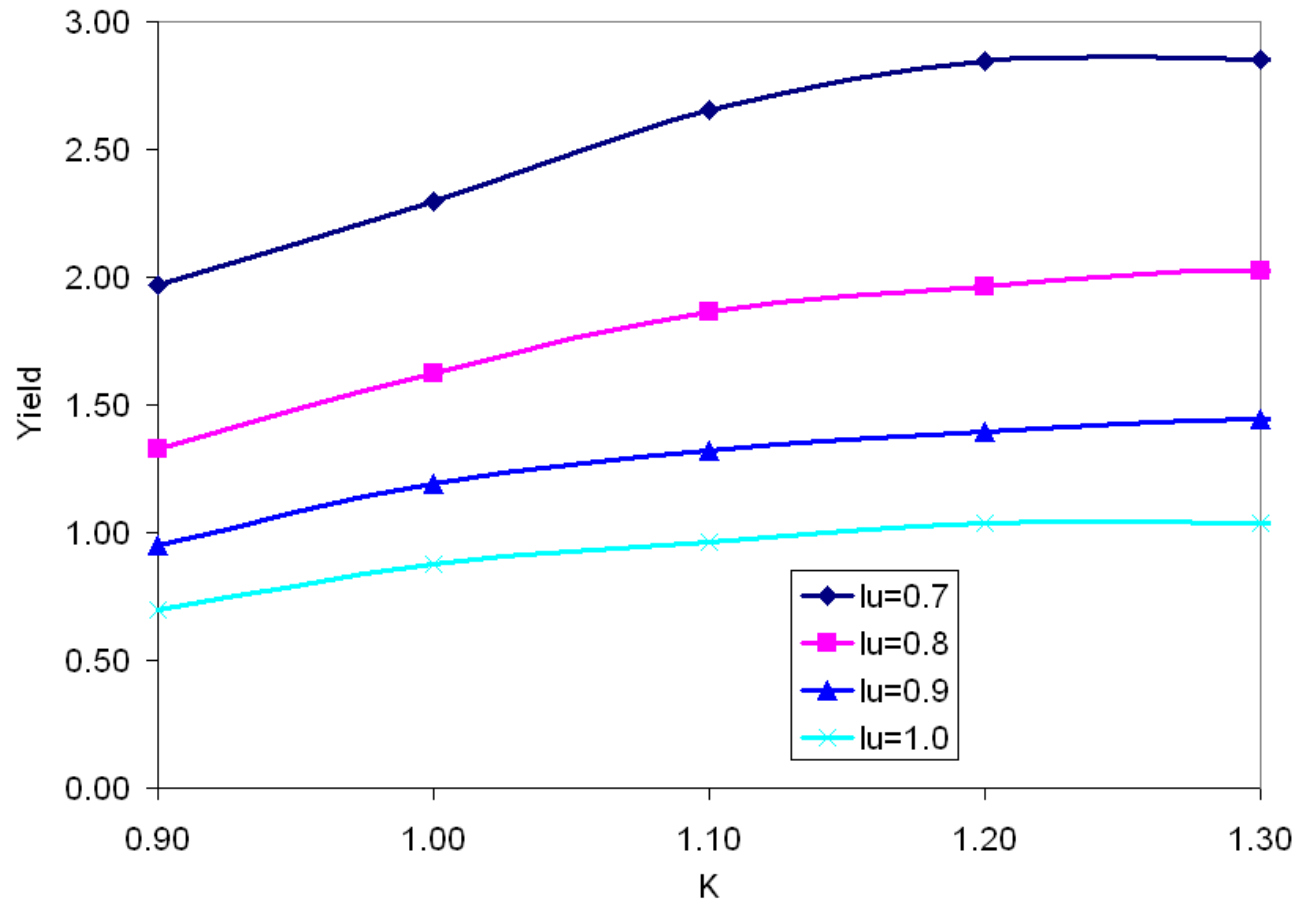

Towards High Polarizations



- Most sensitive parameter: Transverse photon distribution:
 - Photon Collimation would eliminate unwanted off axis photons that have low polarization.
 - Other parameters (drive beam energy and low K undulator) also have influences, but not dominate (skipped from this presentation).

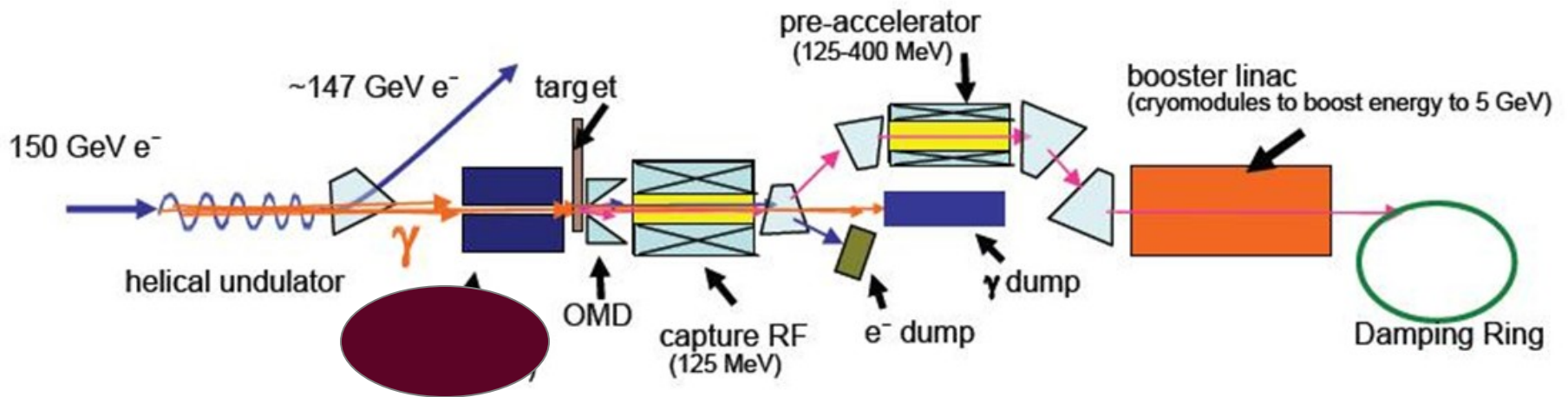

Photon Collimator

Recommendation from ILC positron source meeting in Durham (2009) was to include a tungsten/graphite collimator of radius 2mm.

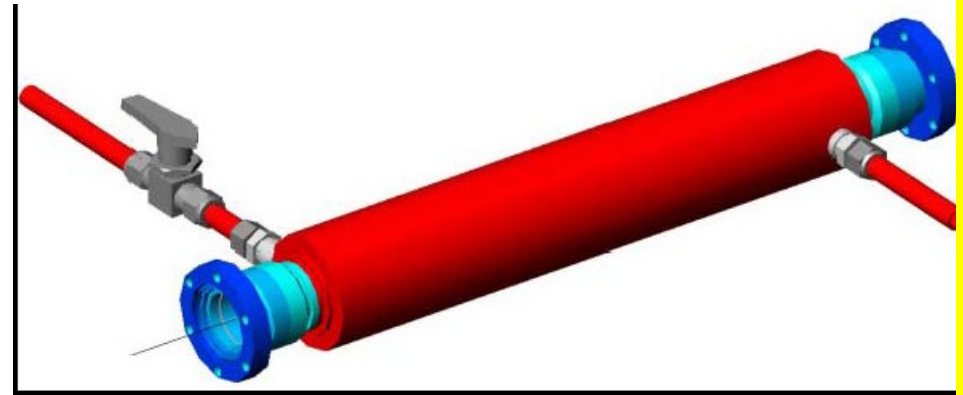

Yield and Polarization vs Aperture Radius of Photon Collimator

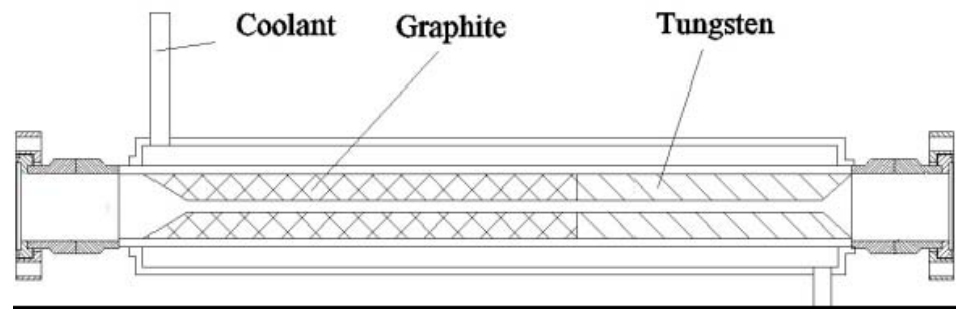
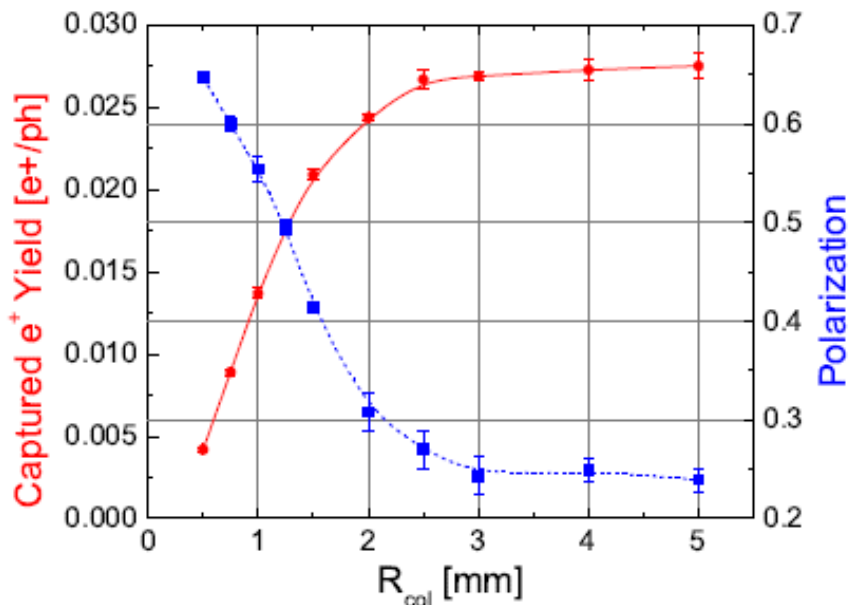

Same specification works for SB2009 (2.5kW in collimator)

Polarization upgrade

231m RDR undulator, 150GeV drive beam, $\frac{1}{4}$ wave transformer

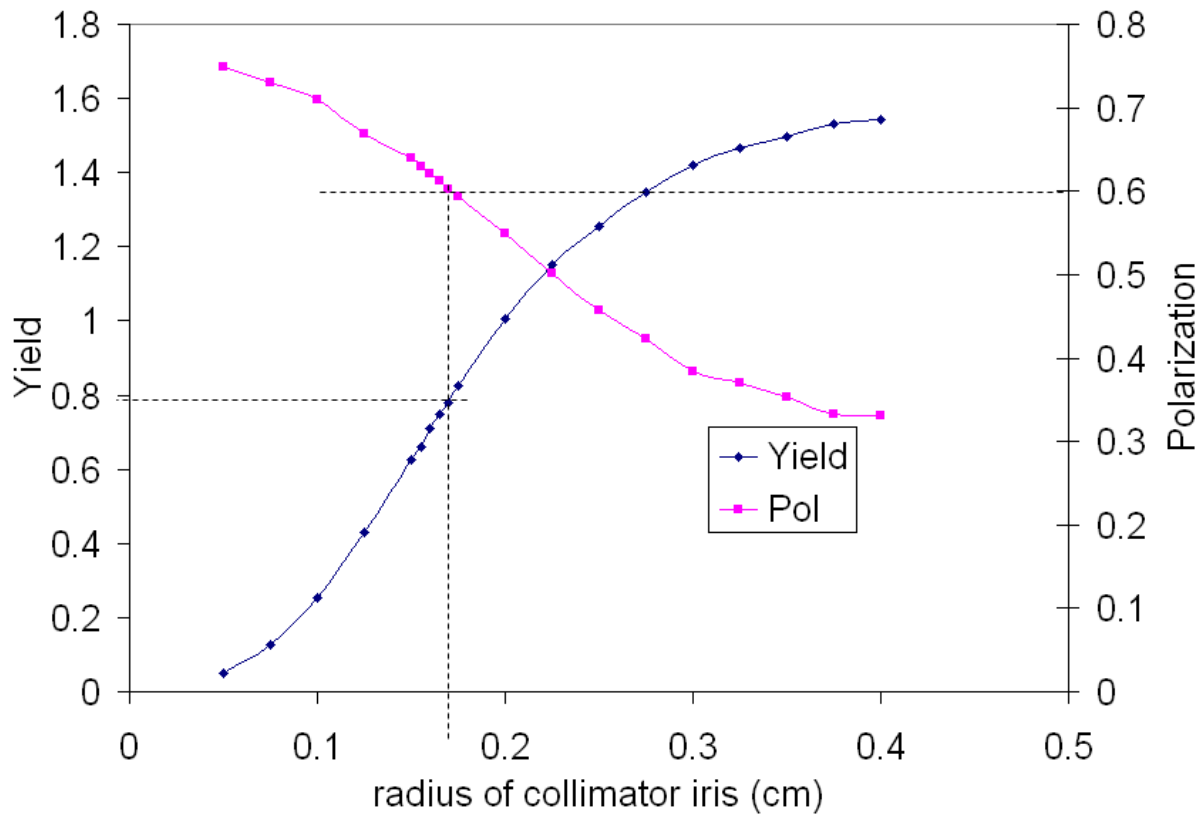

With QWT, with a photon collimator to upgrade the polarization to 60%, the positron yield will drop to ~ 0.8

Drive beam energy	Energy lost per 100m	Energy lost for 1.5 yield and 60% polarization
150GeV	~ 2 GeV	~ 8.8 GeV

R/Ds of Alternative Solutions

From T. Omori, KEK



R/Ds are on going for Alternative Solutions as well

- **Why Alternative Solutions?**

- Pursuit better/advanced solutions
- Mitigate Risks
- Back Up

- **Alternative Solutions**

- **Compton**

- Independent Source with Polarization

- (1) French 4-Mirror Cavity installed in ATF: F-J Collab.

- (2) Multi-bunch observation with 2-Mirror Cavity

- **Conventional**

- only e⁺ source which we have experience in real accelerators
- 300 Hz scheme (expansion in time) to mitigate target issue

- (3) Liquid Target

- (4) Hybrid Target

- (5) Truly Conventional (Slow Rotation Target: 4m/s)



Risk assessments for the e+ system:

Work to be done (incomplete list)

- Undulator based
 - Undulator
 - Photon Collimators
 - Capturing magnets
 - Target
 - Pre-accelerator
 - RH
 - KAS
 - Overall system design (including realistic lattices)
 -
- Alternative scheme
 - Compton
 - Conventional
- Anything that relevant to the TDR.
- More interestingly, what about the 1 TeV option? Compatible with existing design (SB2009)?

