

Cavity production R&D in STF

H. Hayano 09092010

STF and Cavity Fabrication Facility



STF phase 2 Accelerator Plan

DRFS base cryomodule operation with ILC-structure beam

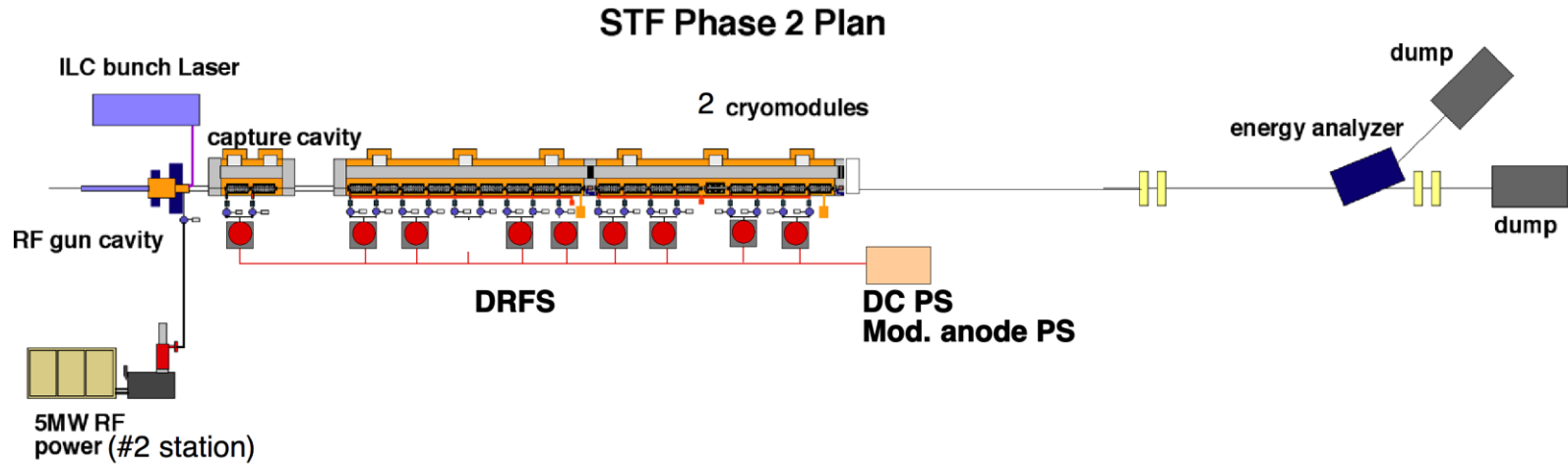

Cavity: Capture Module(2 cavities) +
CM1(9 cavities)
+CM2(8 cavities)

beam: 9mA, 5Hz

at RF-gun:4.7MeV

at Capture Module exit: 21MeV,

CM1 exit: 273MeV

CM2 exit: 525MeV

*CM-2 is still under discussion

RF-gun cavity: 41.4MV/m (3.5MW input power)

Cavity gradient: Capture Module:15.2MV/m

CM1:31.5MV/m

CM2:31.5MV/m

STF phase2.0 accelerator : Tunnel Layout

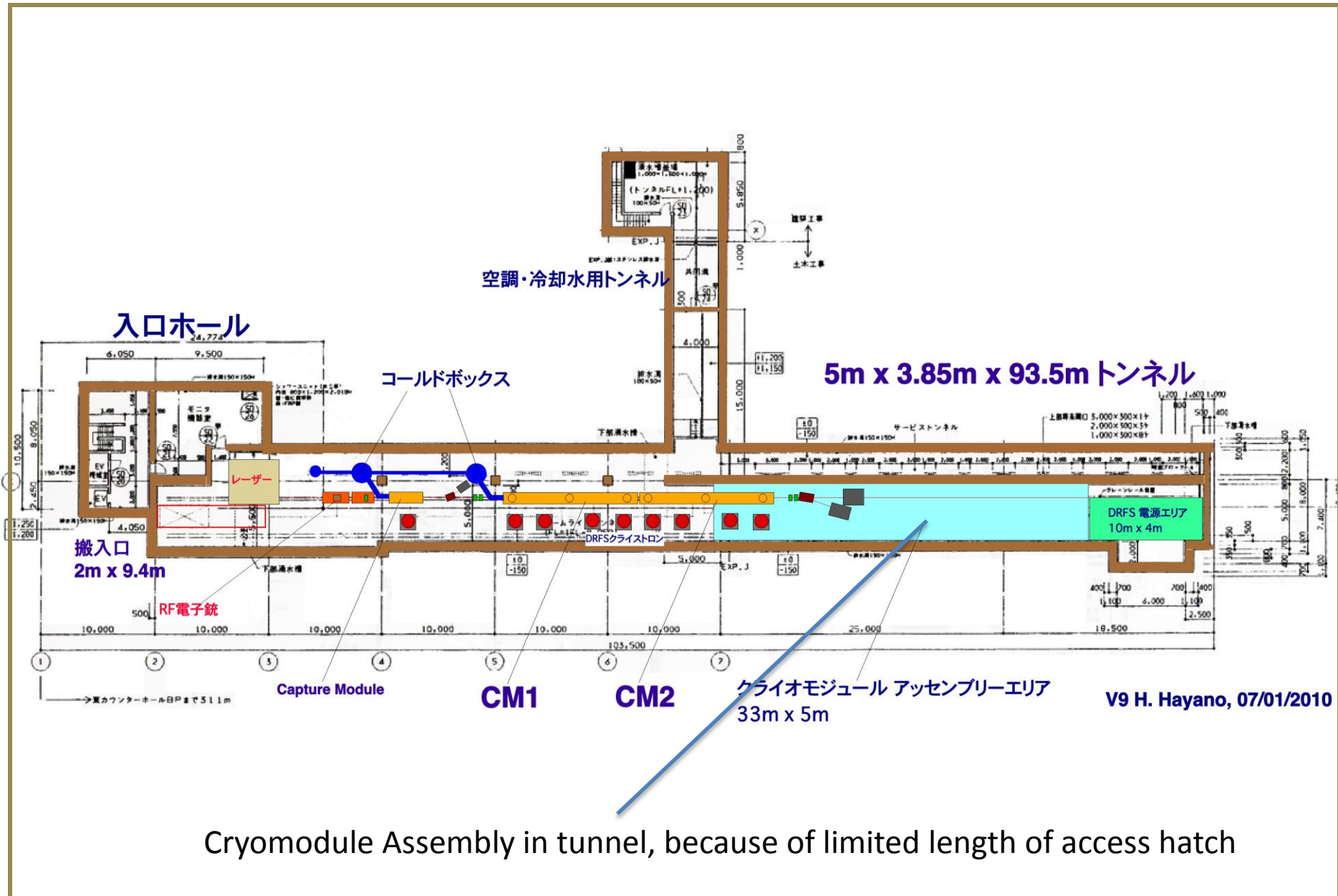

Cryomodule Assembly in tunnel, because of limited length of access hatch

Q.B. experiment setup in STF (using RF-gun and capture cryomodule)

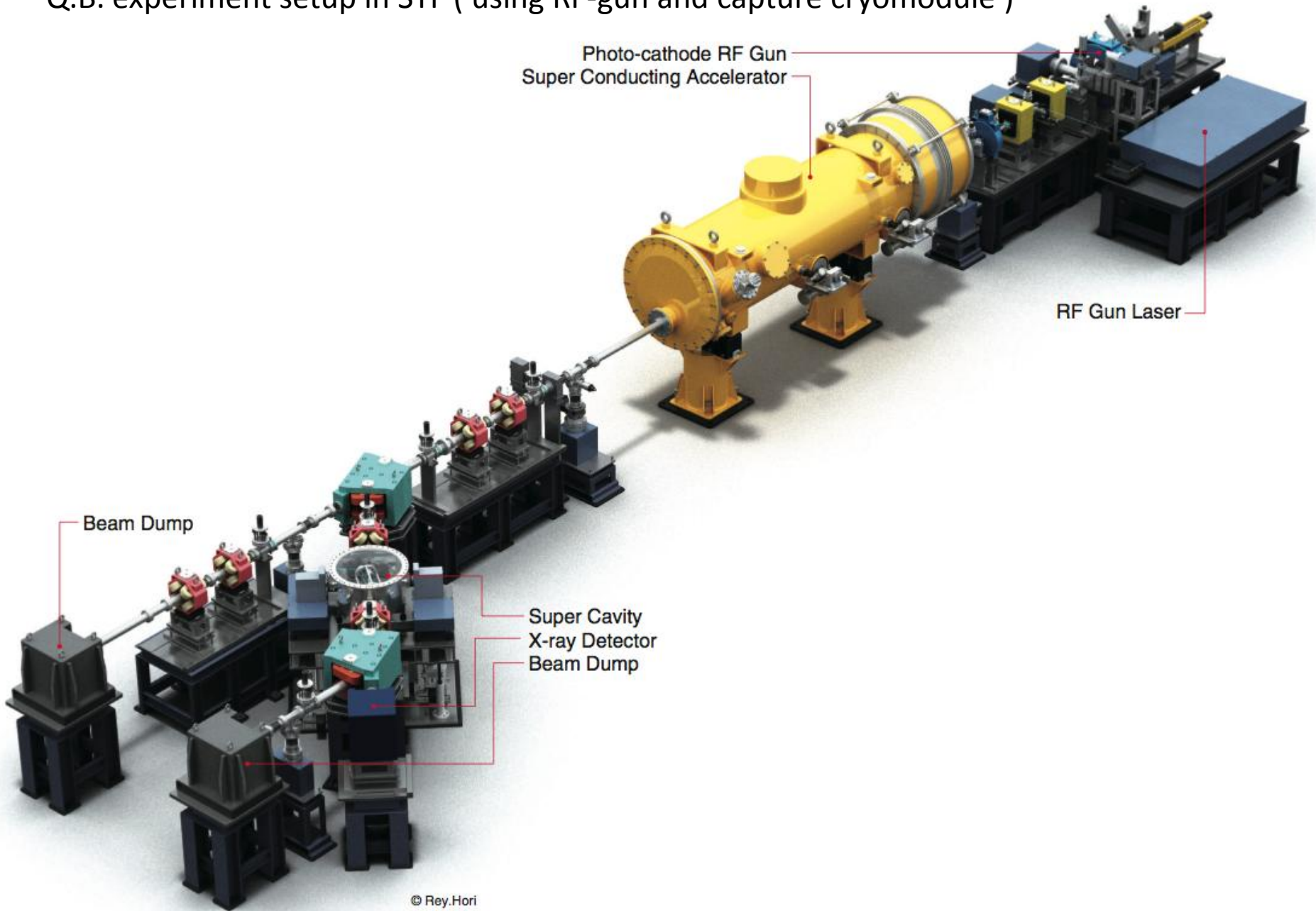

Beam parameters

	Q.B. operation	STF Phase2 operation
Pulse length	1ms	0.9ms
Repetition rate	5Hz	5Hz
Bunch Spacing	6.15ns (162.5MHz)	369.27ns (2.708MHz)
Number of bunch/pulse	162500	2437
Bunch charge	62pC	3.2nC
Total charge /pulse	10,000nC	7,798nC
Beam current	10mA	8.7mA
Bunch length	12ps(Laser, FWHM)	10ps(Laser, FWHM)
Max. beam energy	40MeV	21.5MeV
Beam power	2.0kW (40MeV beam)	0.8kW (21.5MeV beam)

STF Plans for 5 years (still under discussion)

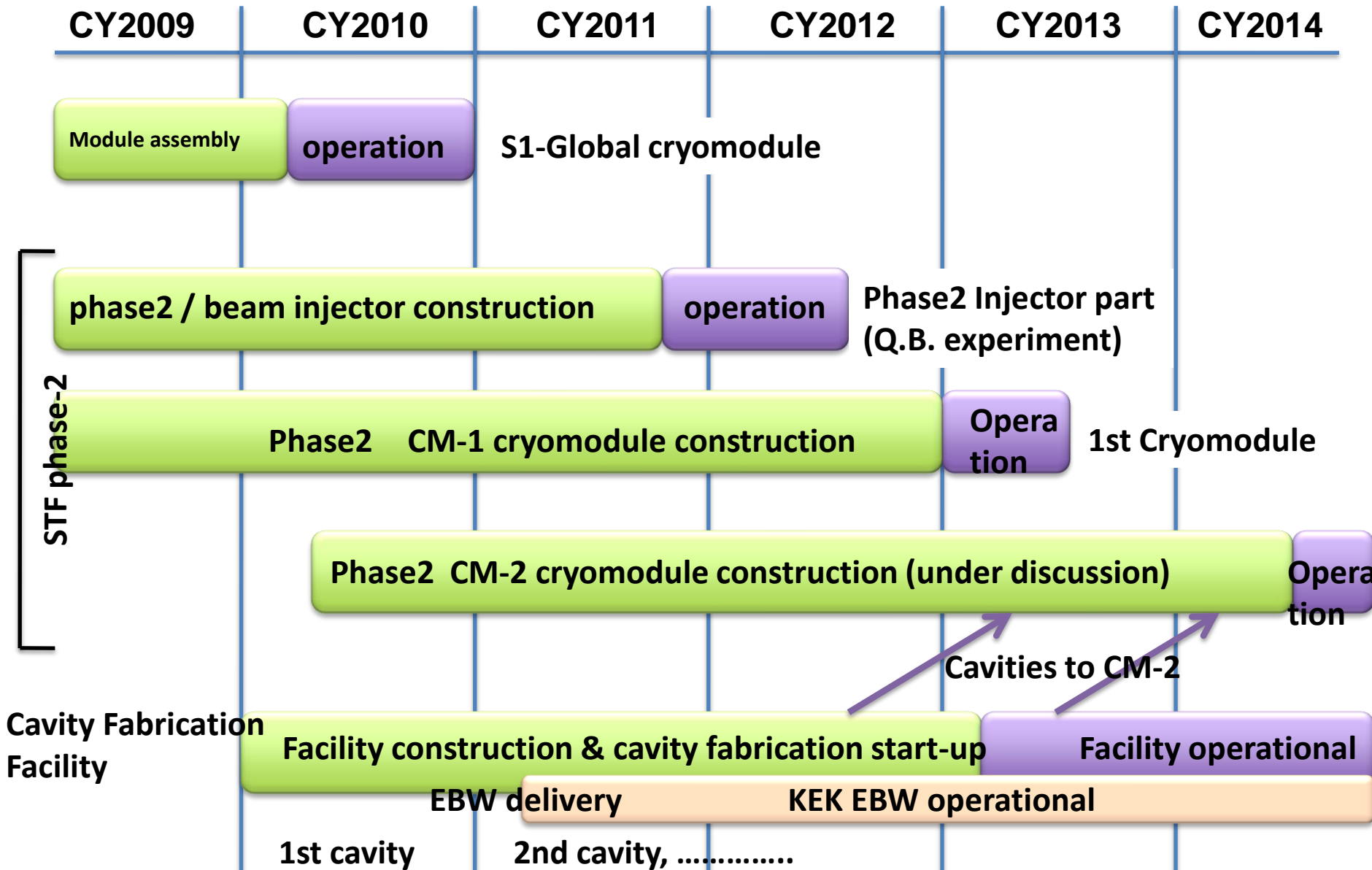

STF Cavity Production plan

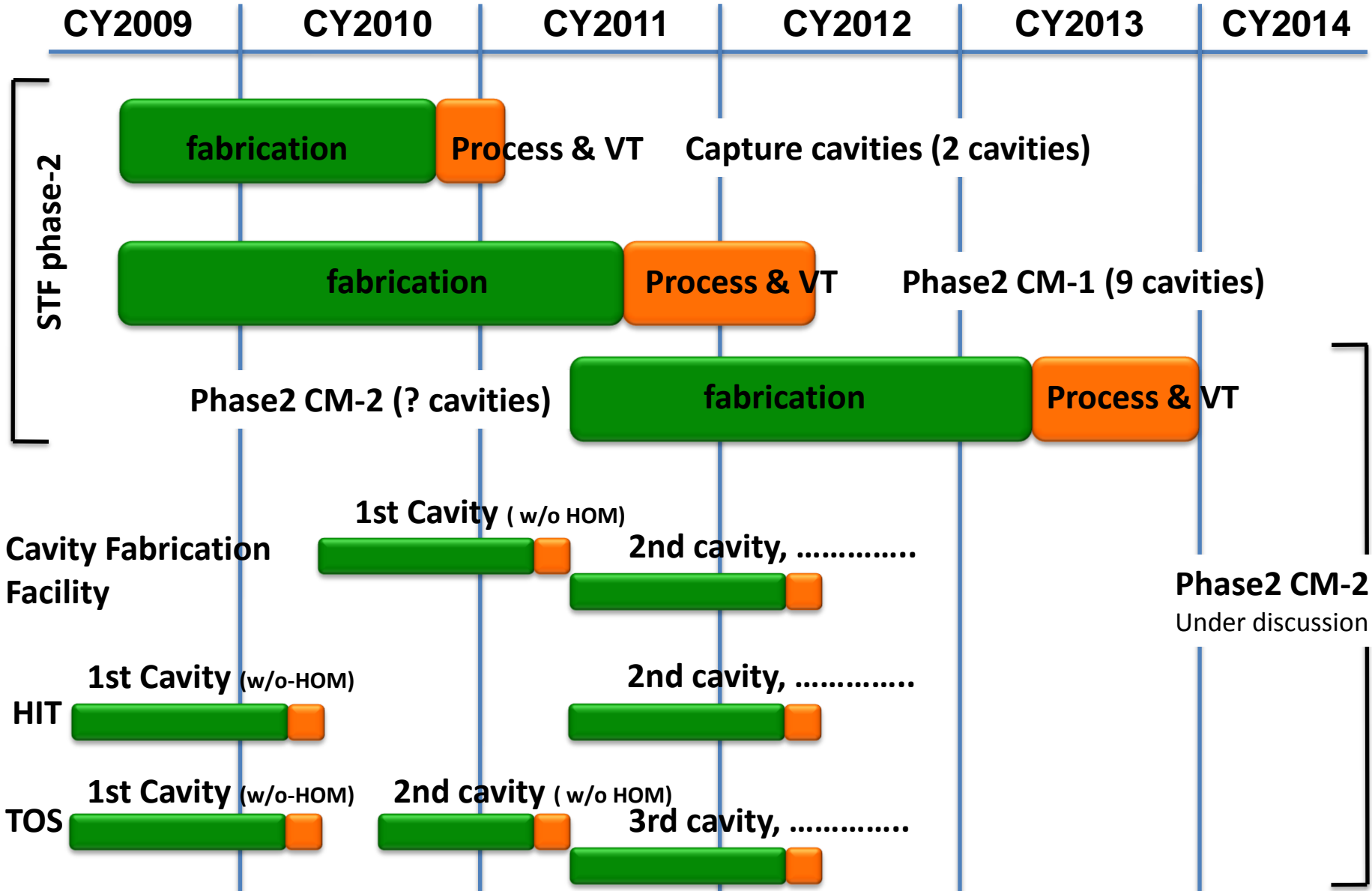

Cavity Fabrication Facility

KEK Pilot plant

Industrialization of Cavity Fabrication

start preparation of ILC mass-production technology development

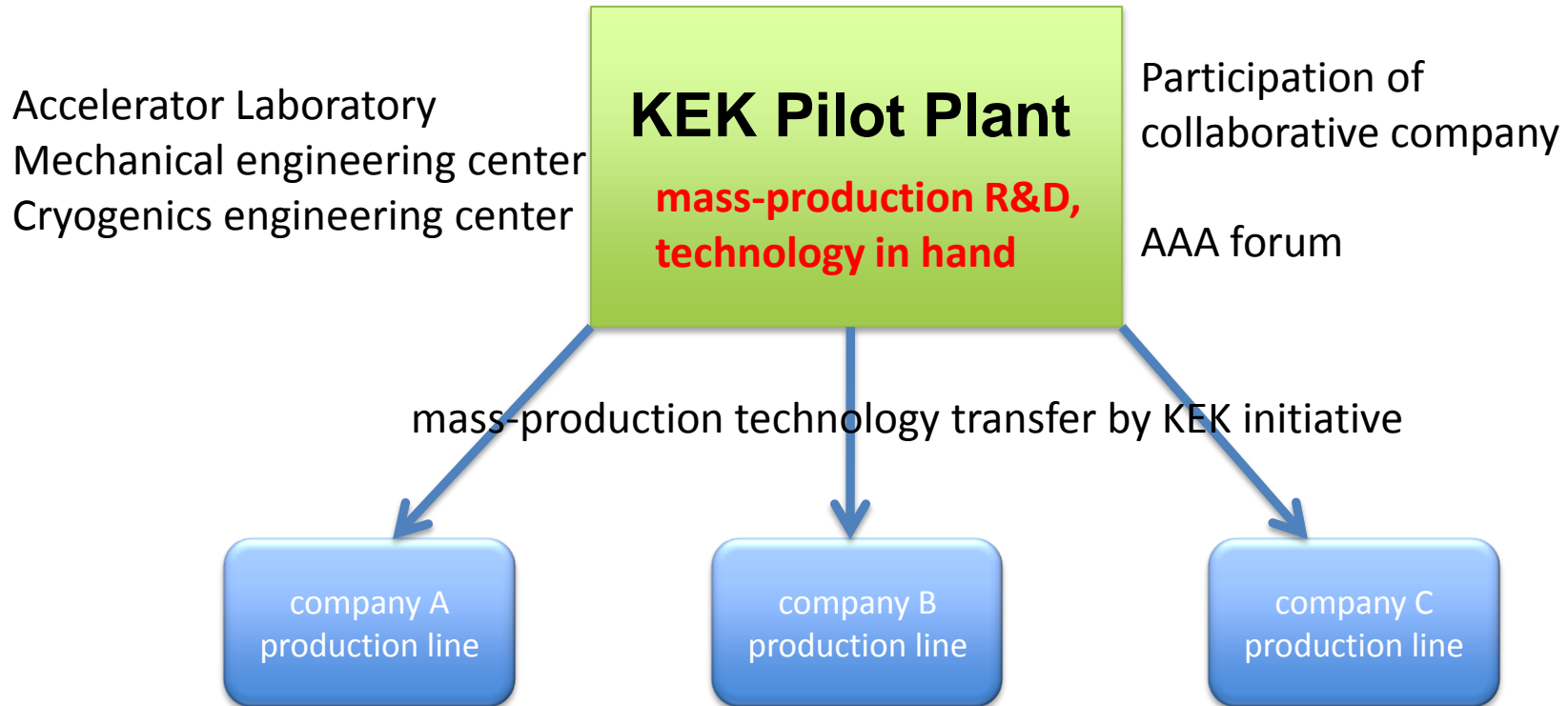

KEK Pilot Plant: main R&D

Center cell

EBW Quality Control Technology

multi-dumbbell, multi-cell, multi-cavity Jigs for EBW

End-group

Deep Drawing Technology

Fine-blanking (cutting-out) and Press-forming Technology

End-group Jigs for EBW

R&D Place in KEK

Refurbishment of 'P.S. energy center' building was completed.

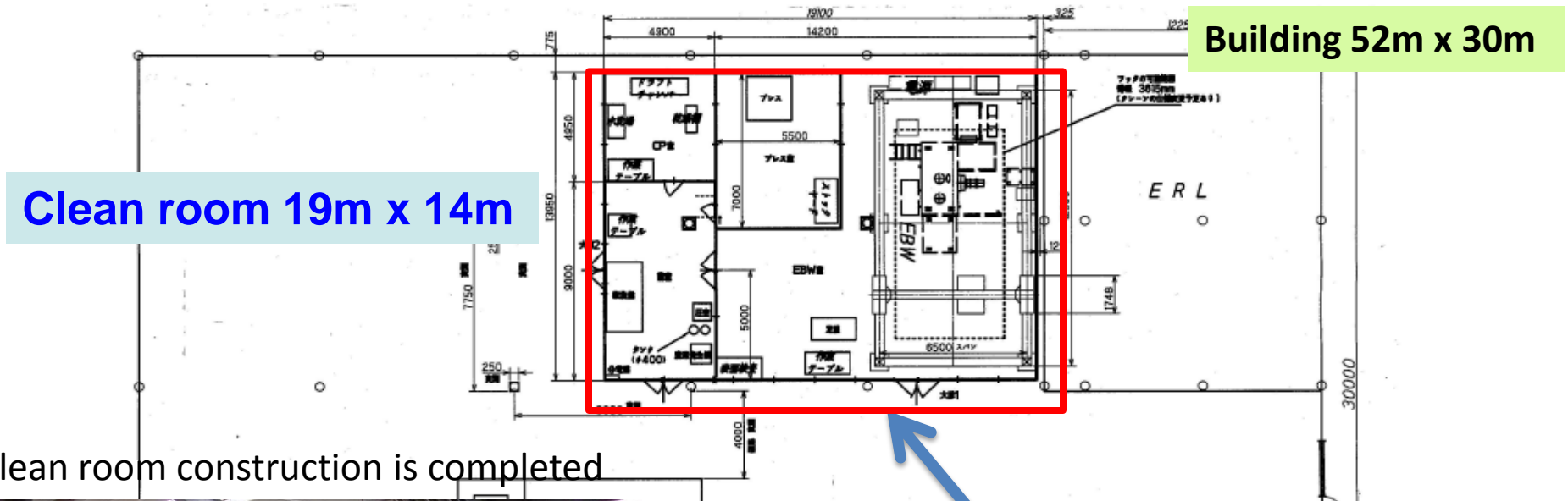

Pilot plant clean room

Chemical Polish room

19m x 14m ISO class-5 clean room

Electron Beam Welder

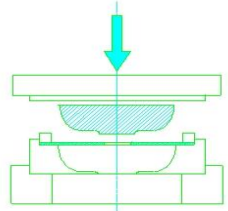

Press machine

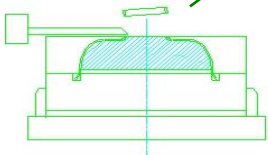

Triming machine

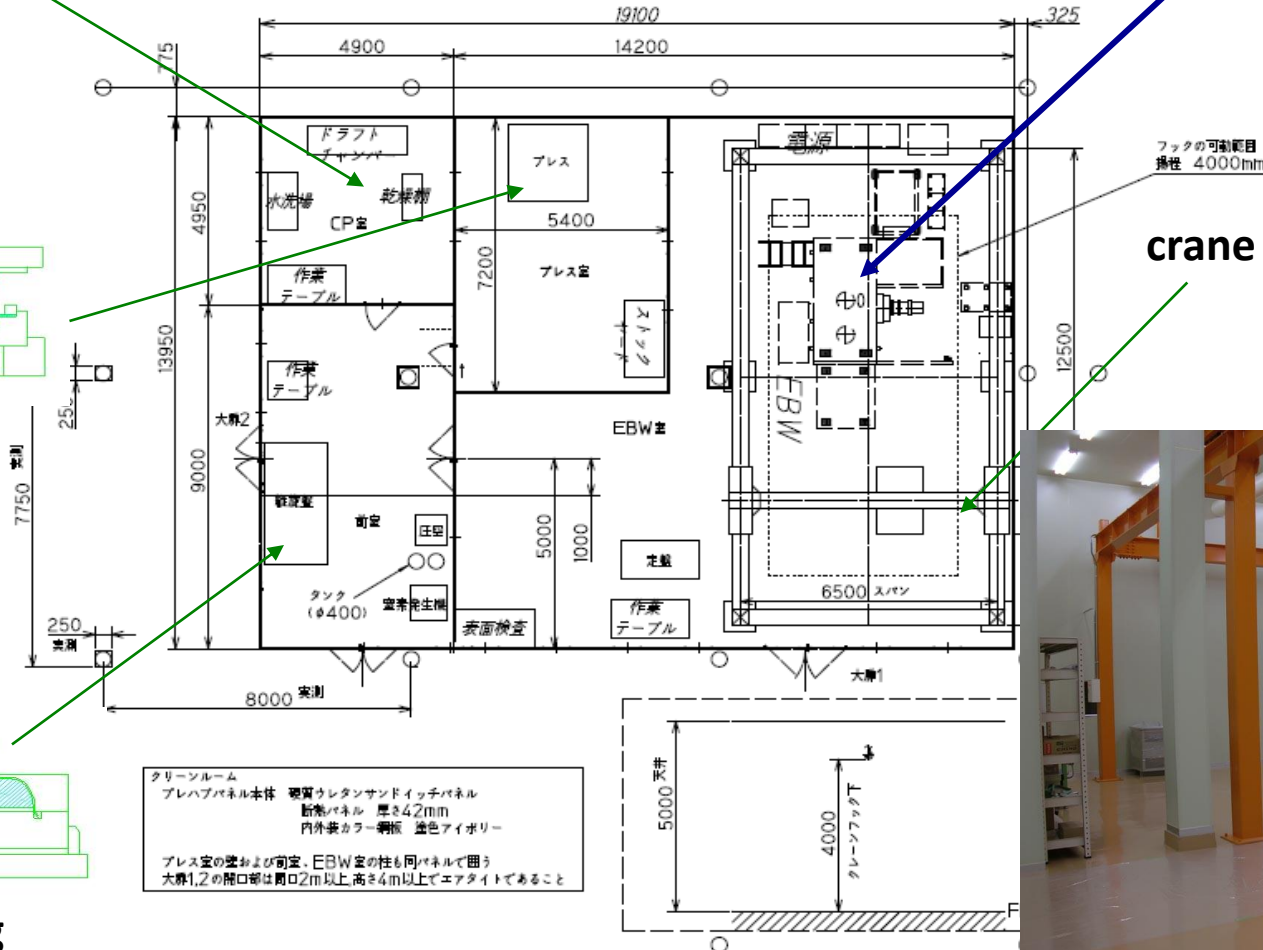

クリーンルーム
 プレハブパネル本体 硬質ウレタンサンドイッチパネル
 断熱パネル 厚さ42mm
 内外装カラー鋼板 塗色アイボリー
 プレス室の壁および前室、EBW室の柱も同パネルで囲う
 大昇1,2の開口部は開口2m以上、高さ4m以上でエアタイトであること



EBW place and crane girder

Main facility: Electron Beam Welder

we spent one year for survey of cavity EBW machine.
After bidding, one EBW machine was ordered.

electron gun

electron gun in horizontal place. (vertically movable)

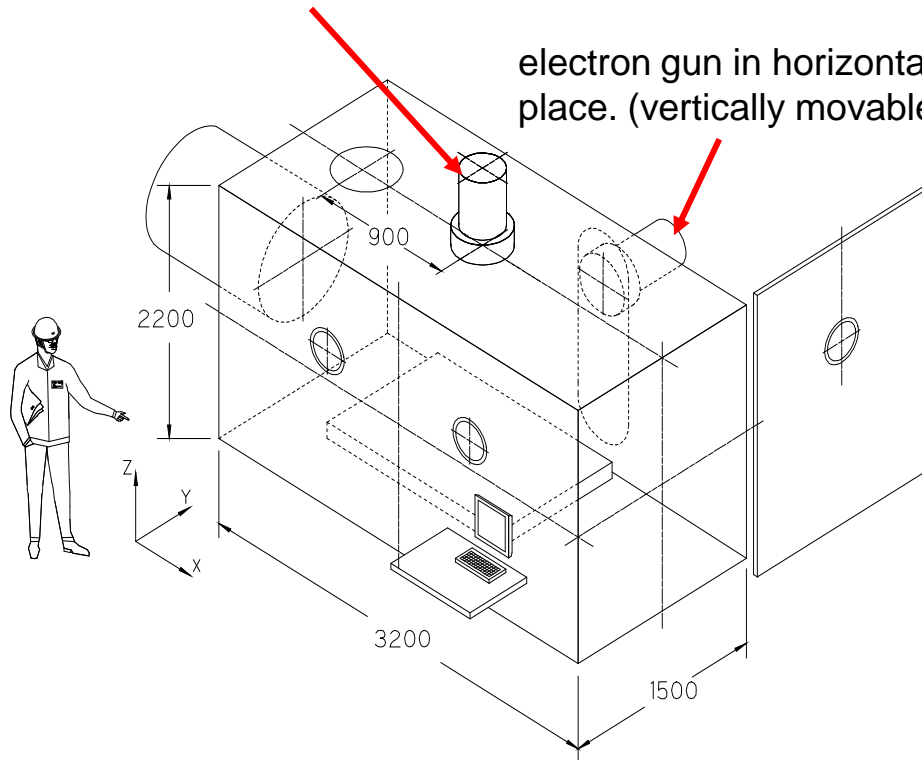

DESY EBW; the same company

Steigerwald 150kV 15kW machine will be delivered in March 2011.

Plan of multi-cavity welding

6 cavities welding plan in the final process

electron gun from side wall

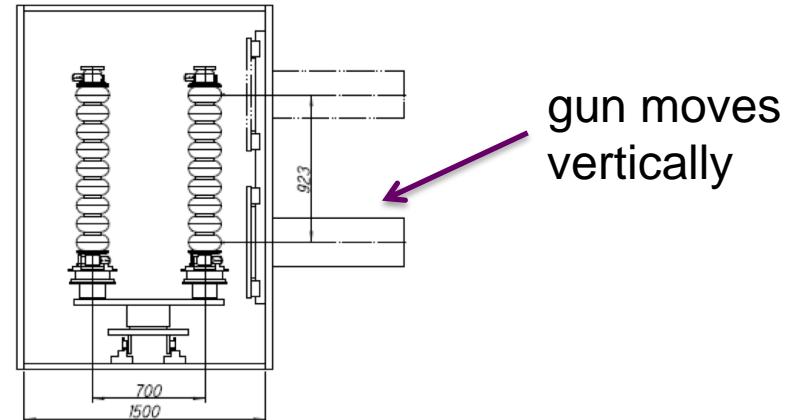
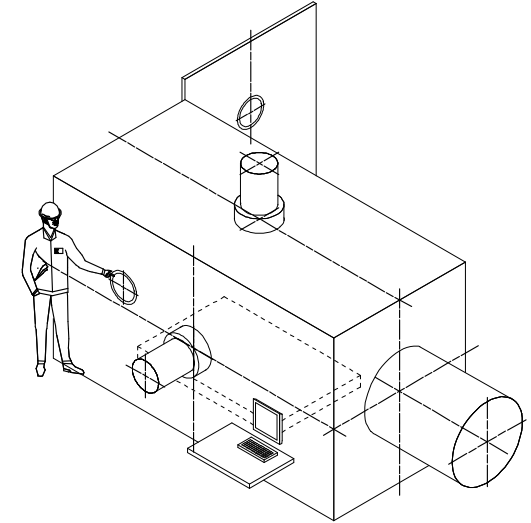
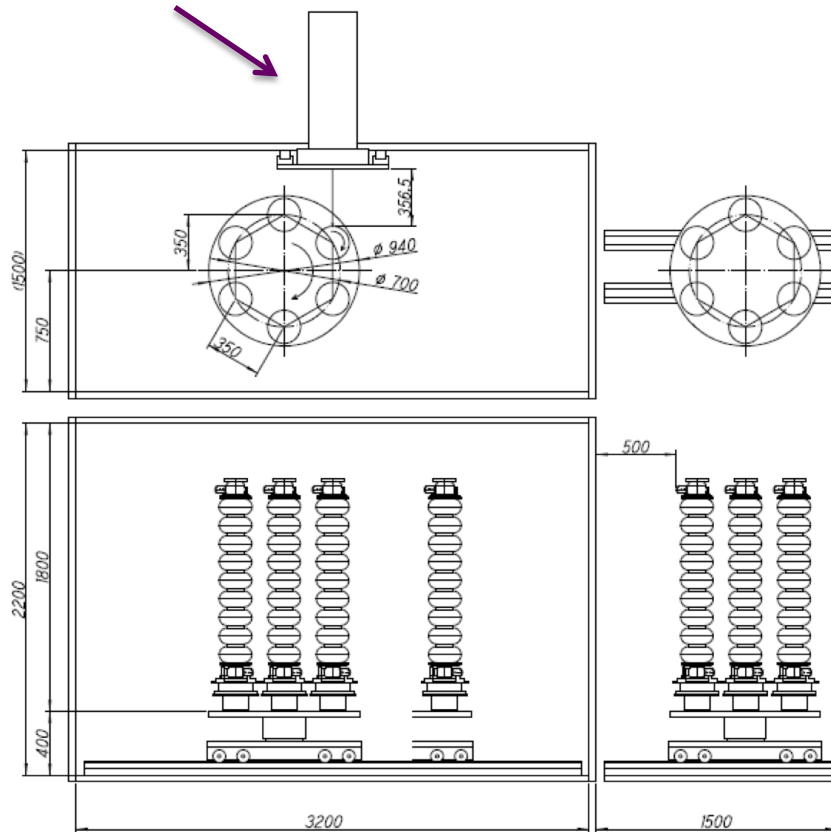

Digital servomotor Press machine

combination of servomotor and crank mechanism

max. 150t



from Amada presentation

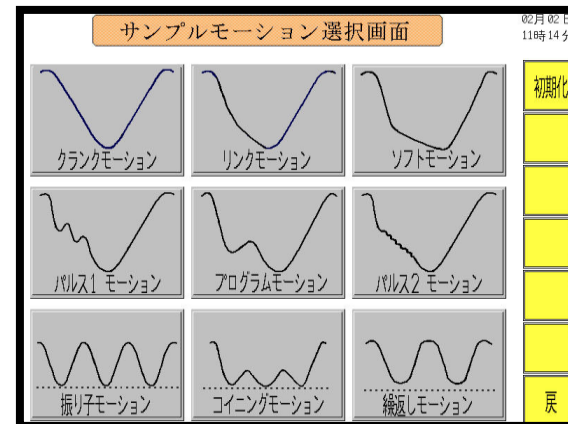
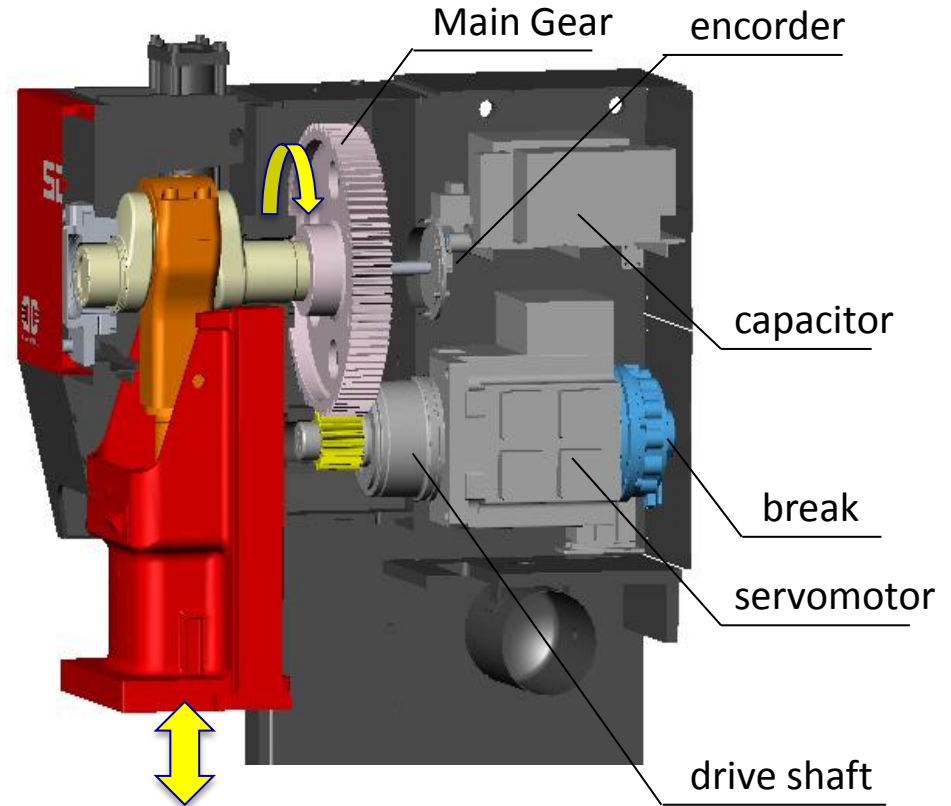

press motion controls

Deep drawing of cup; for example

conventional press

TPL150



① plate
Φ165 0.5 t

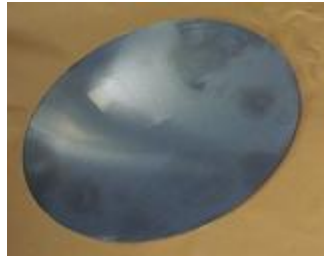

→ ② 1st deep drawing → ③ 2nd deep drawing → ④ 3rd deep drawing

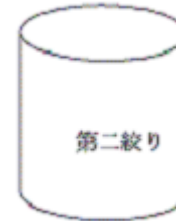
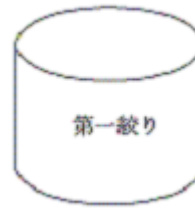

SDE1522



① plate
Φ160 0.5 t



→ ② one deep drawing

モーシヨソ設定	パルス1モーシヨソ
上昇移動量	0.1 mm
追い込み移動量	1 mm
繰り返し回数	30 回
加工ストローク数	10 min-1



no shock-line

digital servomotor press

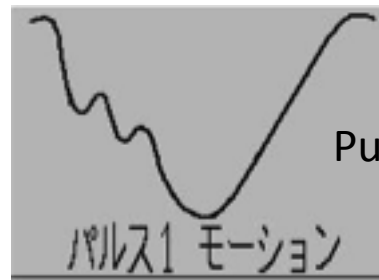

Pulse motion press

Press machine application



Deep drawing of HOM-cup, beam-pipe
 Burring of beam-pipe
 Cut-out & pressing of HOM antenna, etc

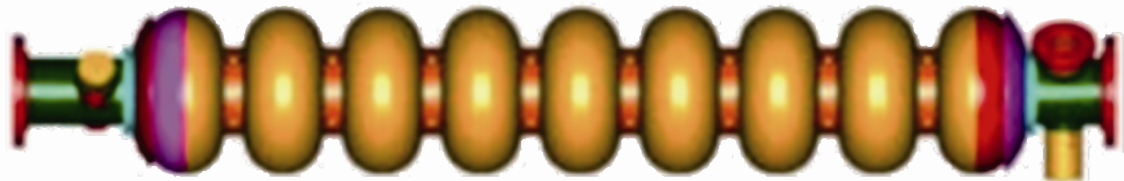

Short End group

EBW 1 2ヶ所



End cell : short side



HOM1

input port



beam pipe

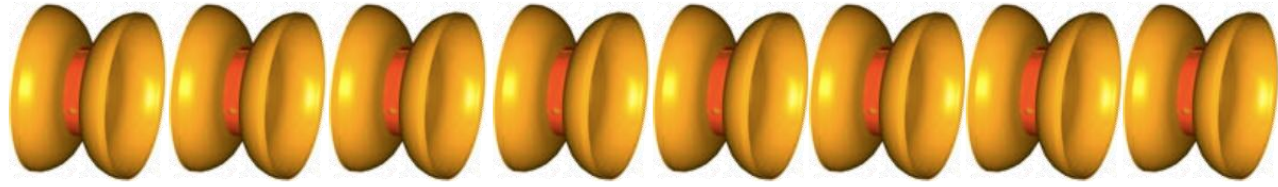

Dumbbell x8



× 8組

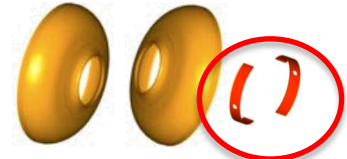

center cell x8

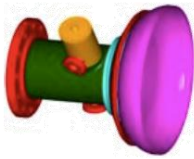

Long End group



beam pipe

pickup port

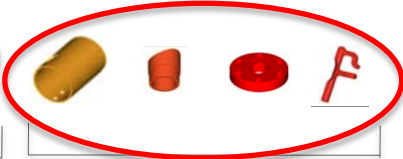

HOM2

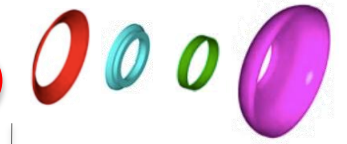

End cell : long side

Cavity Fabrication (TESLA Cavity)

56 parts: Nb (RRR>300)= 46, Nb-Ti = 10, by press, burring, machining
 75 Electron Beam Welding (EBW) place

Cell trimming machine



cell cup is held in horizontal plane, and rotate.

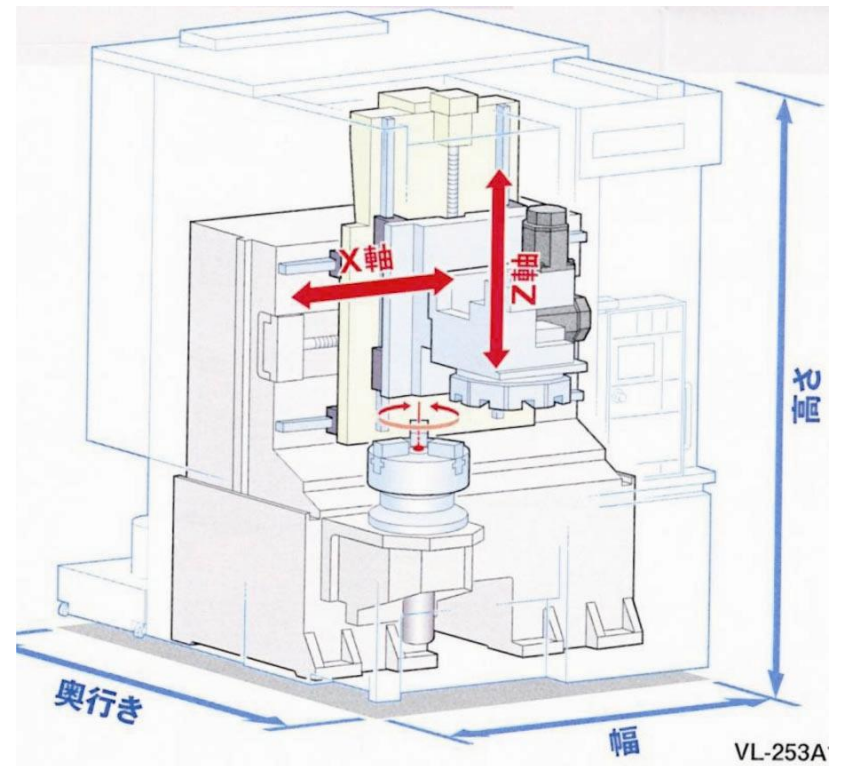

inspection instruments for fabrication support

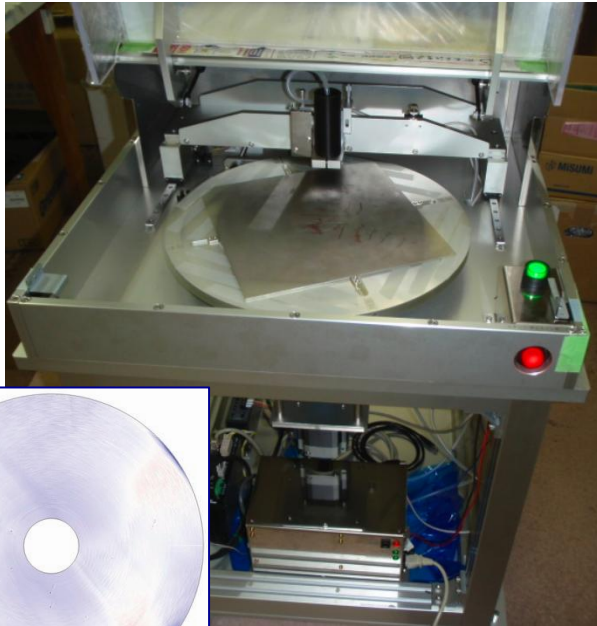

eddy current scanner

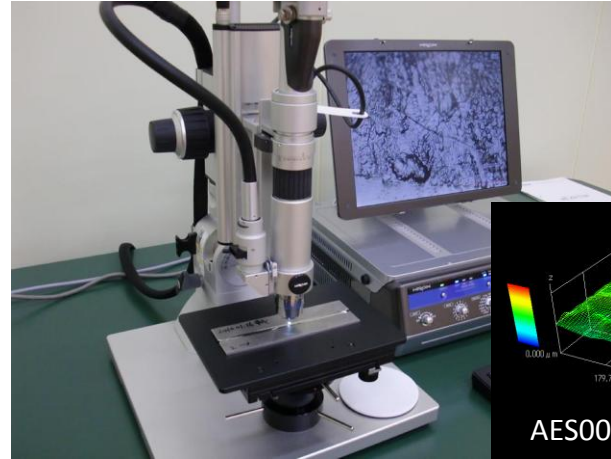

optical 3D profiler

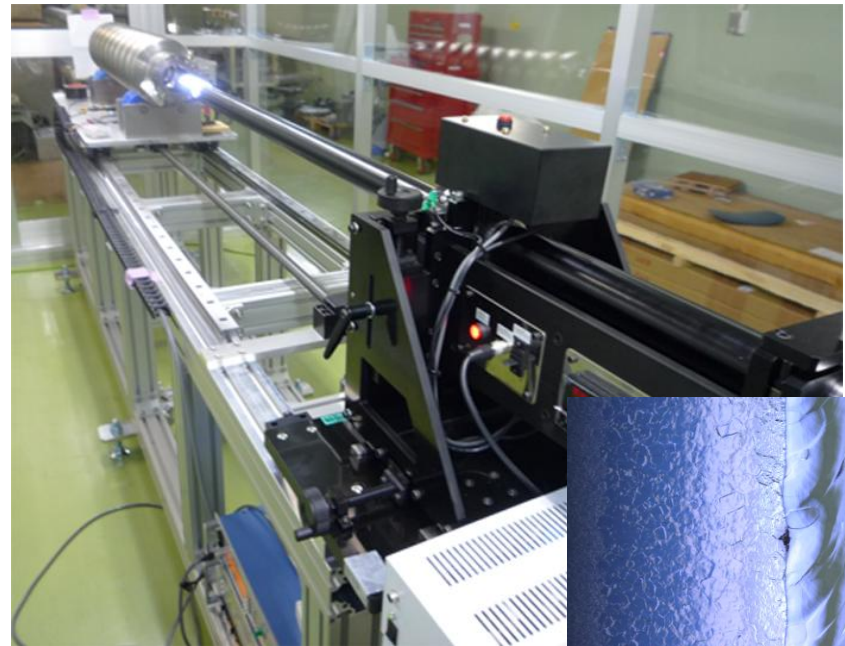
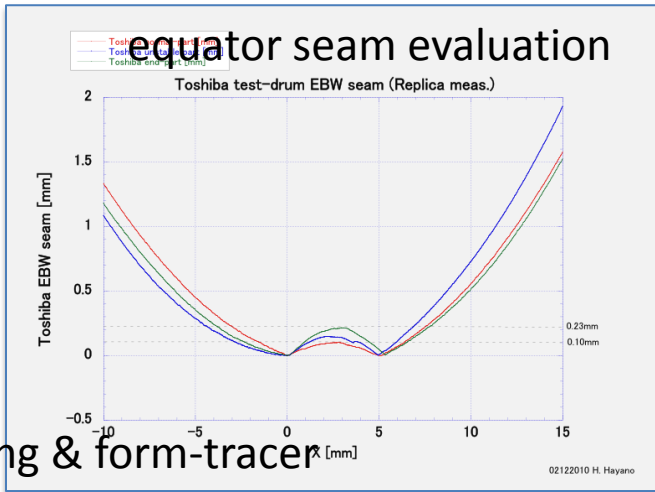
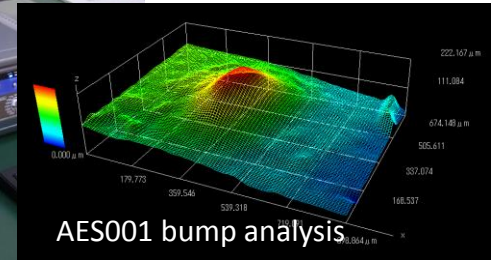

inner surface inspection



MHI008

molding & form-tracer

2009 installation

Clean room construction

EBW performance was surveyed, bid, and ordered
press machine

trim machine

optical instruments, eddy current scan for inspection

infra-structure (water, compressed-air, N₂-gas, etc)

2010-2011 installation

EBW

Jigs of EBW

Chemical Polish system

Jigs of deep-drawing and burring

3D coordinate machine

microwave measurement system

control & data-base system

EBW, Press R&D were started



Tosei-electrobeam co.
SST EBW



Tosei-electrobeam co.
Mitsubishi-EBW

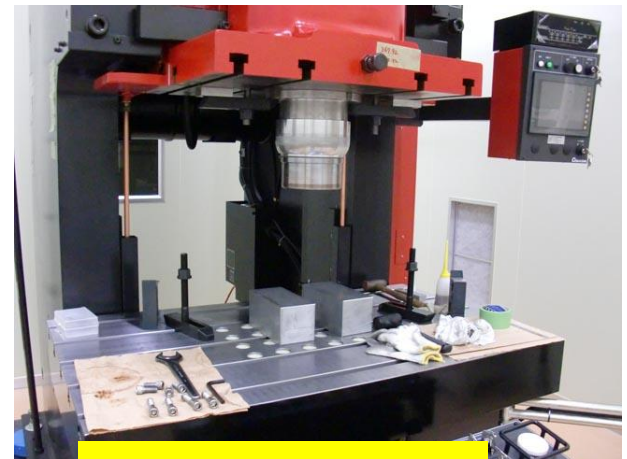

KEK Press Machine

using EBW Job-shop

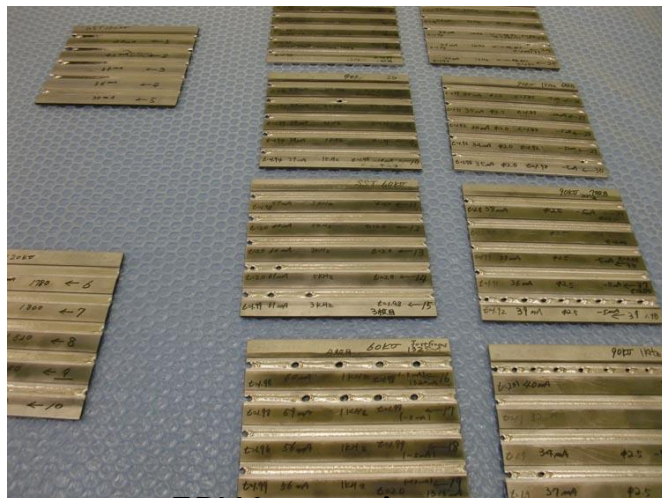

EBW test pieces



Press test cells

Vender development

KEK-Hitachi collaboration

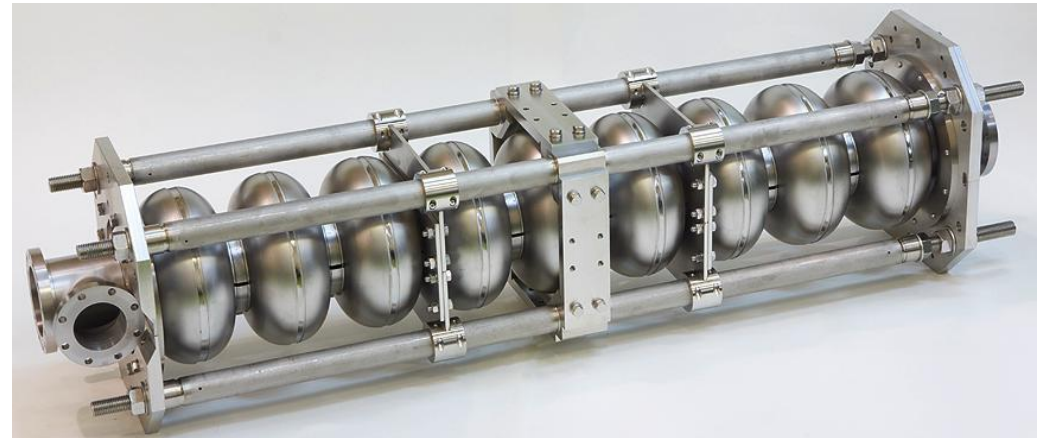

2009: 9 cell cavity w/o HOM fabrication.
Preparation of High-pressure-code application.

2010: HOM fabrication, and preparation of the next full-spec. 9 cell cavity.

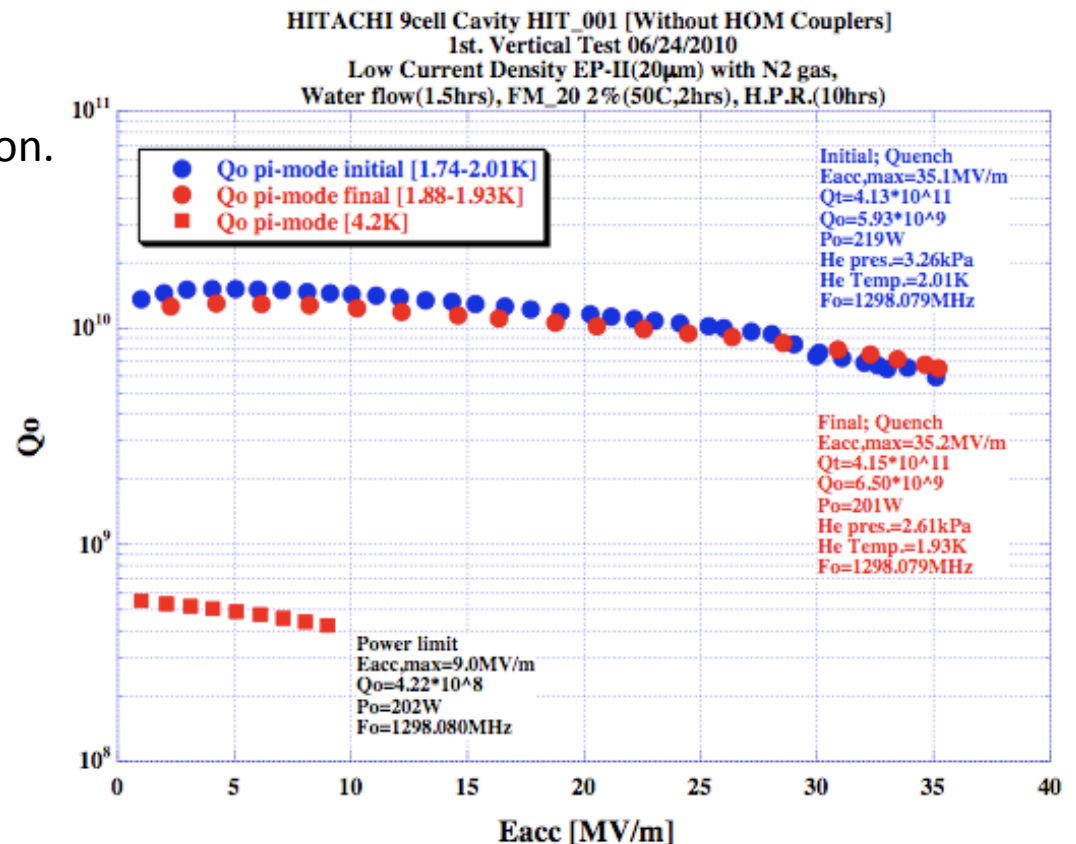

KEK-Toshiba collaboration

2009: 9 cell cavity w/o HOM fabrication.
Preparation of High-pressure-code application.

2010: one more 9 cell cavity w/o HOM fabrication.
HOM fabrication, and preparation of the next full-spec. 9 cell cavity.



TOSHIBA 9cell Cavity TOS_001 [Without HOM Couplers]
1st. Vertical Test 07/08/2010
Low Current Density EP-II(20 μ m) with N2 gas,
Water flow(1.5hrs), FM_20 2%(50C,2hrs), H.P.R.(10hrs)

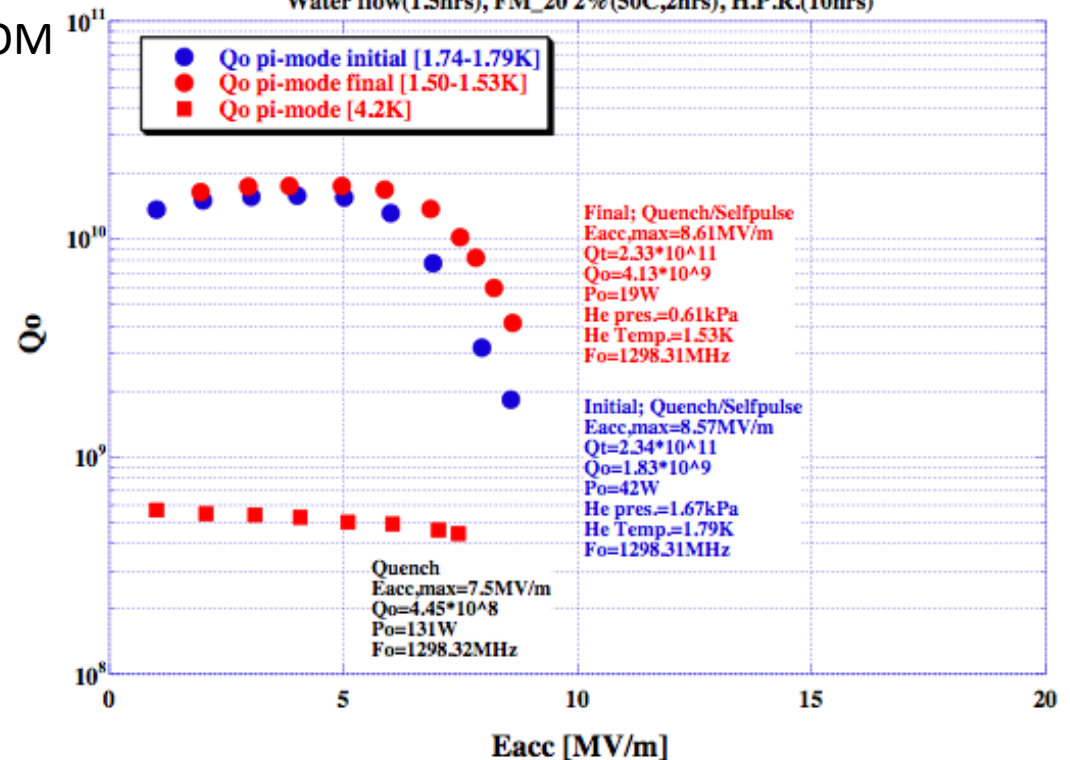

KEK-MHI development for cost-effective fabrication

MHI-A cavity

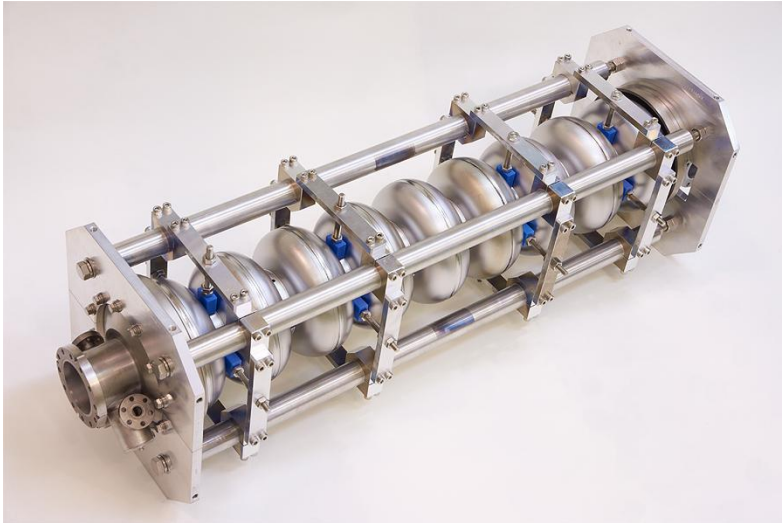

Deep drawing of HOM cup,
Laser beam welding,
more smooth EBW seam

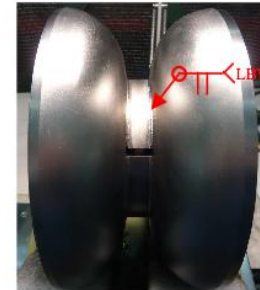

MHI trial of cylinder forming to dumbbell by spinning



Summary

KEK cavity fabrication facility (R&D of EBW and press (deep drawing))

Project was started in 2009,

Housing was completed, Press machine and trimming machine was delivered.

EBW machine delivery is scheduled on March 2011.

produce 1 cavity by using EBW Job-shop in 2010.

produce several cavities by KEK EBW, then put into STF phase2 cryomodule.

Collaboration with press-company for deep drawing, burring, and cut-out forming is started.

Industry participation will be after EBW machine delivery.

Collaboration with industries

Hitachi, Toshiba: 2009-2010 two years collaboration

MHI: total 11 cavities were fabricated. 11 more cavity fabrication by contract was started.

During this fabrication, cost effective fabrication will be pursued.