



Fast kicker study

Machine Time

2010/03/08~03/19(2 weeks)

2010/06/07~06/11(1 week)

*ATF2 project meeting
2010/06/30 T.Naito*

Beam Extraction Orbit using Strip-line Kicker, Aux. septum & Pulse bump

3mrad kick angle

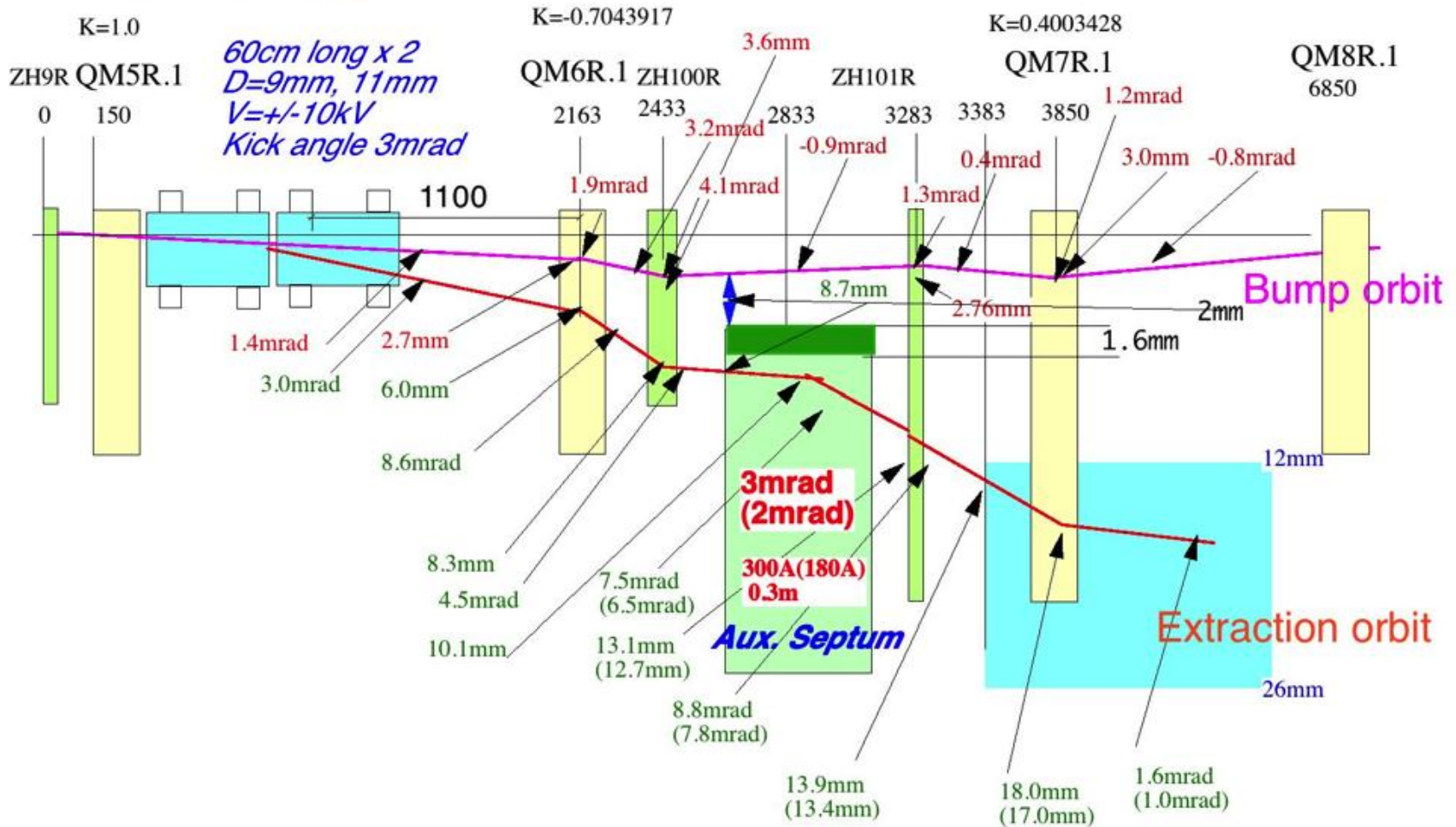

Timing chart of 30 bunches beam extraction

The bump orbit is gradually changed after all of the bunches have been damped. The strip-line kicker kicks out the beams at the timing of the flat-top of the bump orbit. The beams are extracted as one long bunch train, which is a 10micro-sec long with 308 ns bunch spacing.

Injection beam
1st Train 2nd Train 3rd Train



~500msec

Stored beam



Local bump height



~100msec

Extracted beam

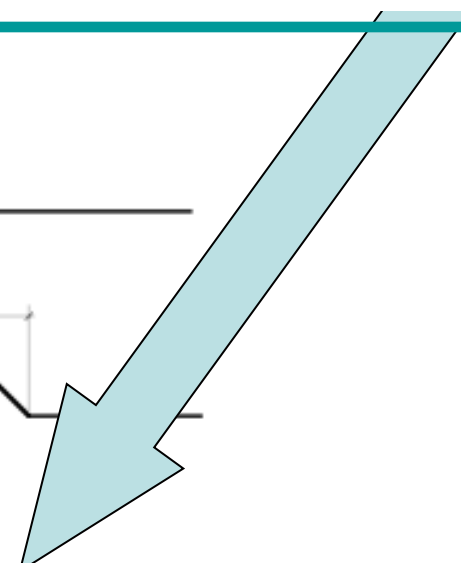
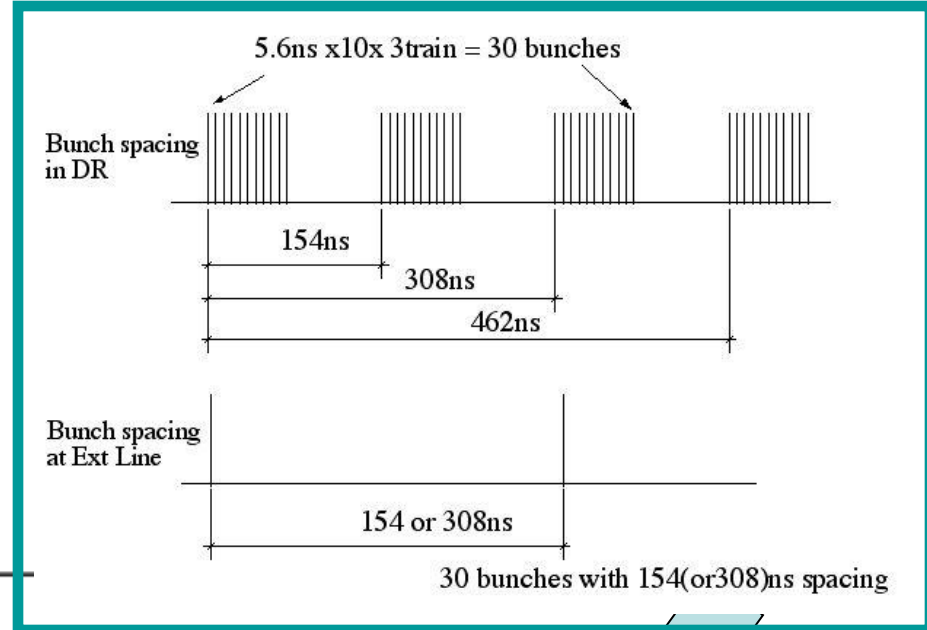

Beam Extraction succeeded from DR to ATF2 2009.Oct. 22.

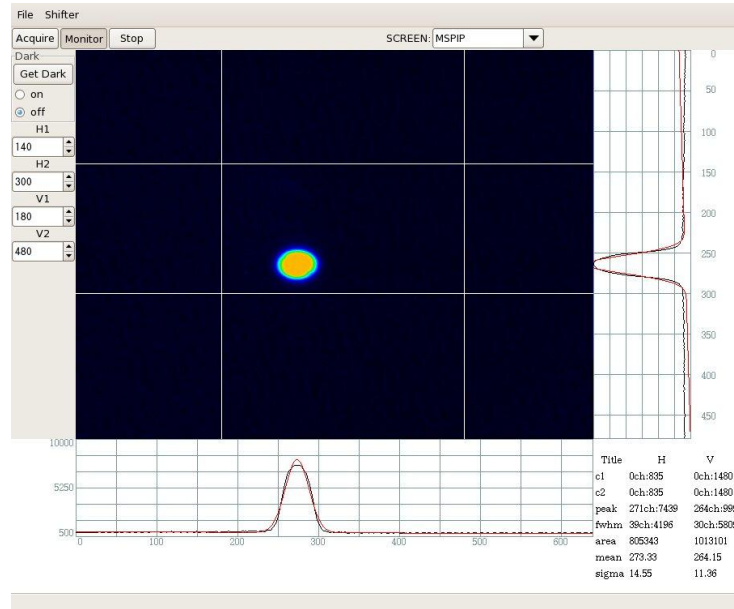
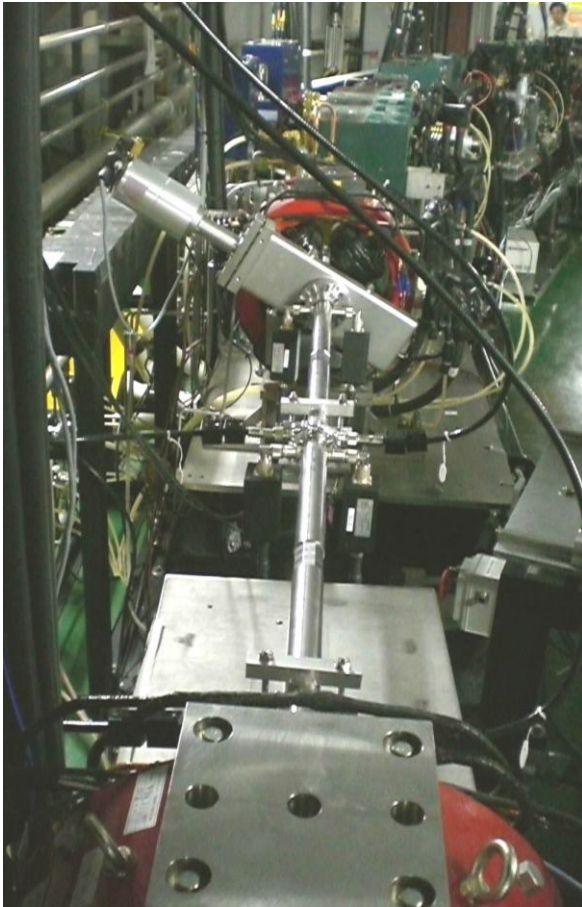

*Beam profile at
MS1X*

*Firs Beam extraction was confirmed
2009/Oct/22. However, the kick angle jitter
was not so good(2×10^{-3}) and the extracted
multi-bunch was only 17 bunches not 30
bunches.*



Improvements from Oct09

- 1. Wrong trigger timing for multi-bunch was corrected. We found that the multi-bunch were injected to the unintended bucket number of DR at Oct09.*
- 2. Pulsers were repaired. The waveforms were improved. One of pulsers did not work 3MHz at Oct09.*
- 3. Laser 2.8ns -> 56.ns*
- 4. Trigger circuit - fine delays use same version, which was caused the trigger jitter.*
- 5. Re-trigger circuit - a trigger from DR BPM is used for the kicker trigger to cure the 2.8ns jitter.*
- 6. Strip-line - 9mm gap x2 -> 9mm + 11mm to get aperture .*

Distribution of fitted angle at EXT entrance

(single bunch)

Jitter $1.05e-6/3e-3=3.5e-4$

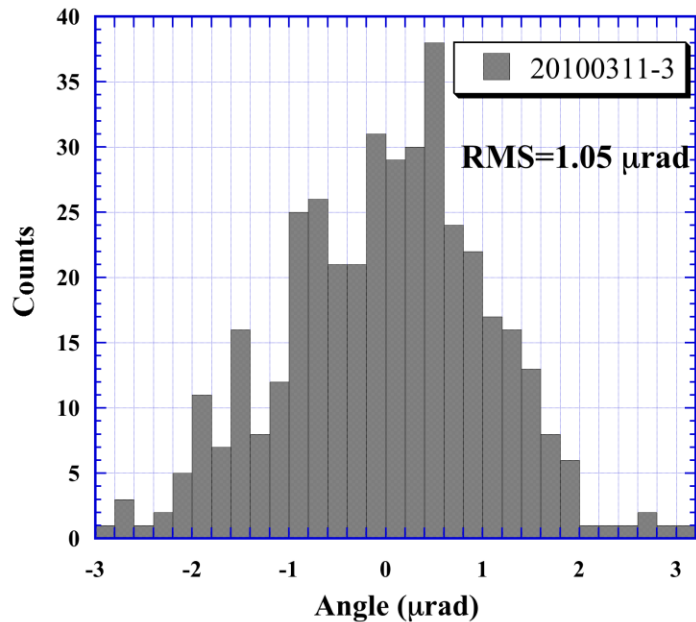

Jitter $2.24e-6/3e-3=7.4e-4$

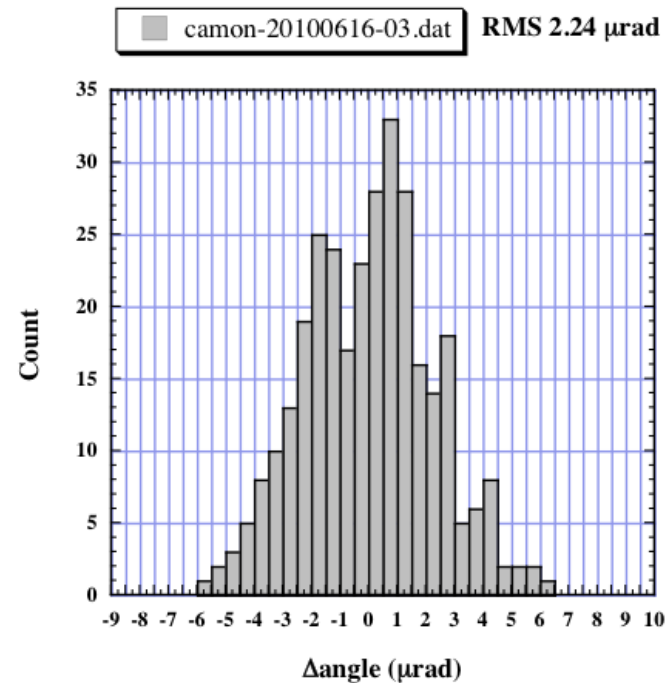

K.Kubo

Use for ATF2 beam

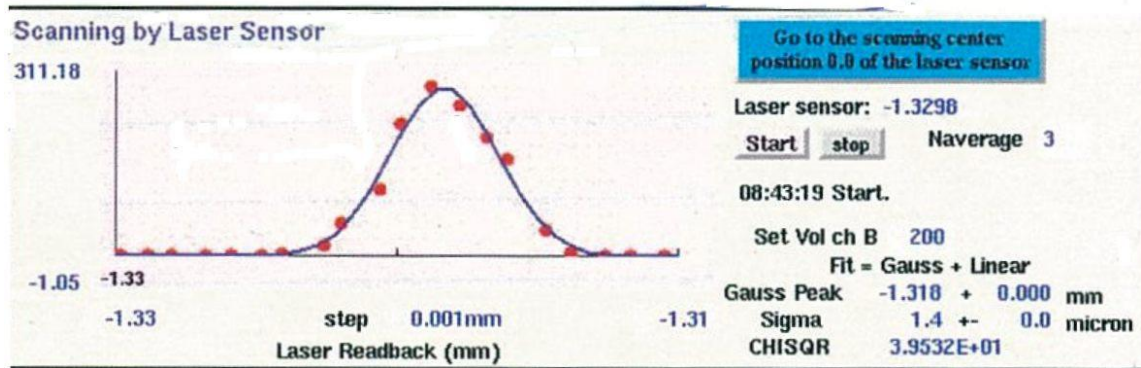

The beam tuning at the focus point was done at the ATF2 beam line including the dispersion correction by looking the beam profile change of the MS1IP wire scanner. The measured size was limited to 1.4 μ m due to the wire size.

Flattop of the kick field and the jitter

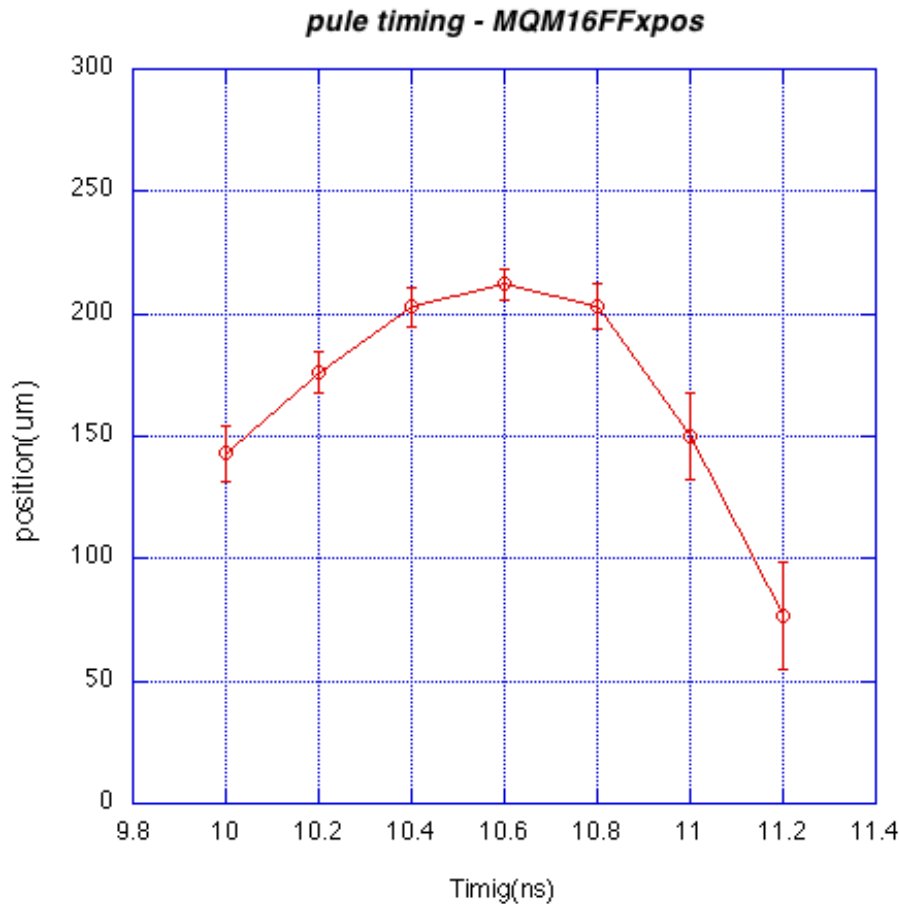

Plot shows the beam position at MQM16FF BPM. The flattop of the kick field is only 400ps and the jitter increased at the both side of the flat top.

It needs to careful timing adjustment of four pulses.

Re-synchronization circuit

The frequency scan is needed for the dispersion measurement. The problem is the count error at the frequency scan when the clock signal moves across the input trigger timing, some of the counter counts one and the others counts zero. Because the phase of the clock signal is different for each counter, there is a probability that the count error happens at the frequency scan for the kicker trigger. If the count error happens, then the trigger shifts 2.8ns(1.4ns) and the orbit of the extracted beam changes so much.

We introduced a re-synchronization circuit, which detects the beam timing from the DR BPM, then re-makes the trigger signal from the kicker trigger and BPM signal.

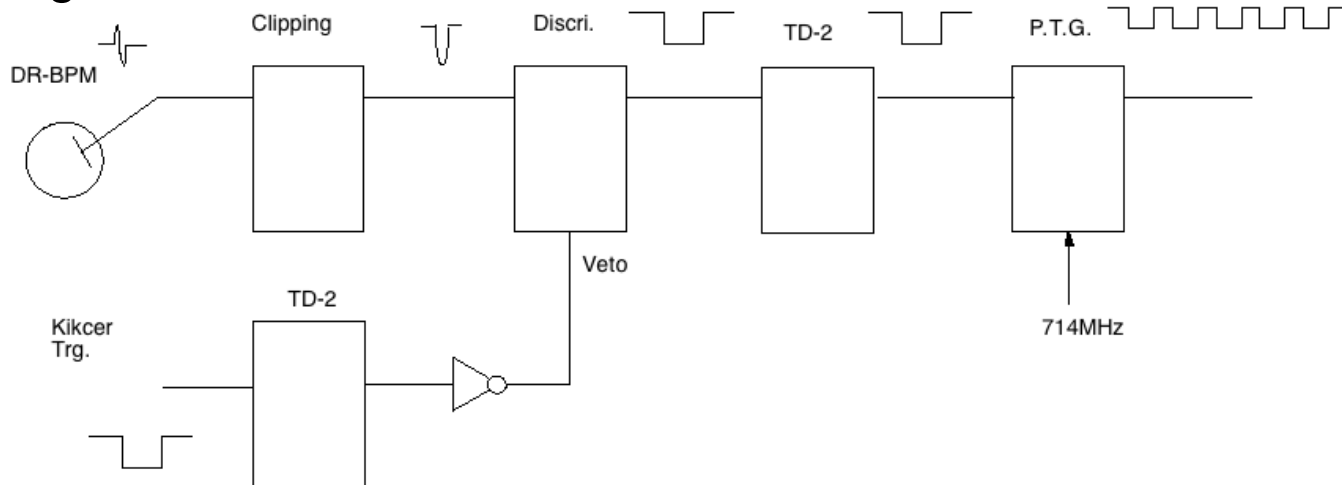

Jitter measurement @ df on condition

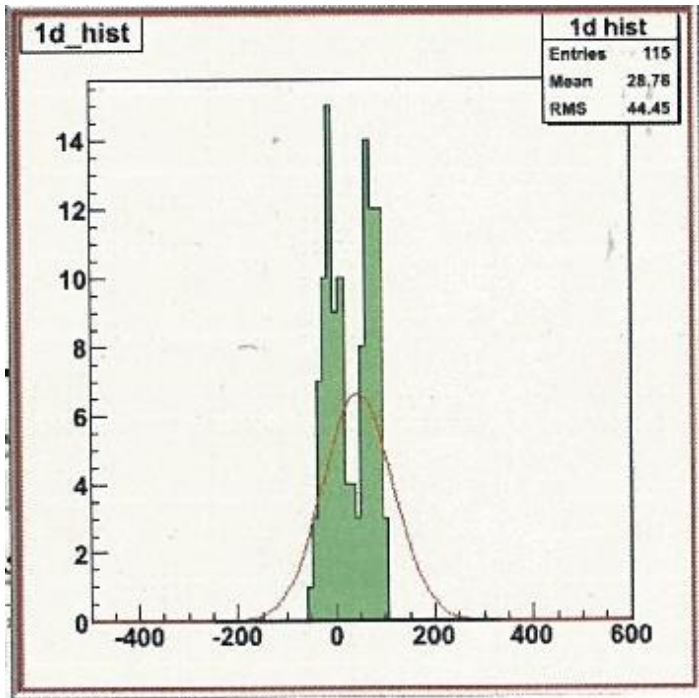

Without Re-synchronization

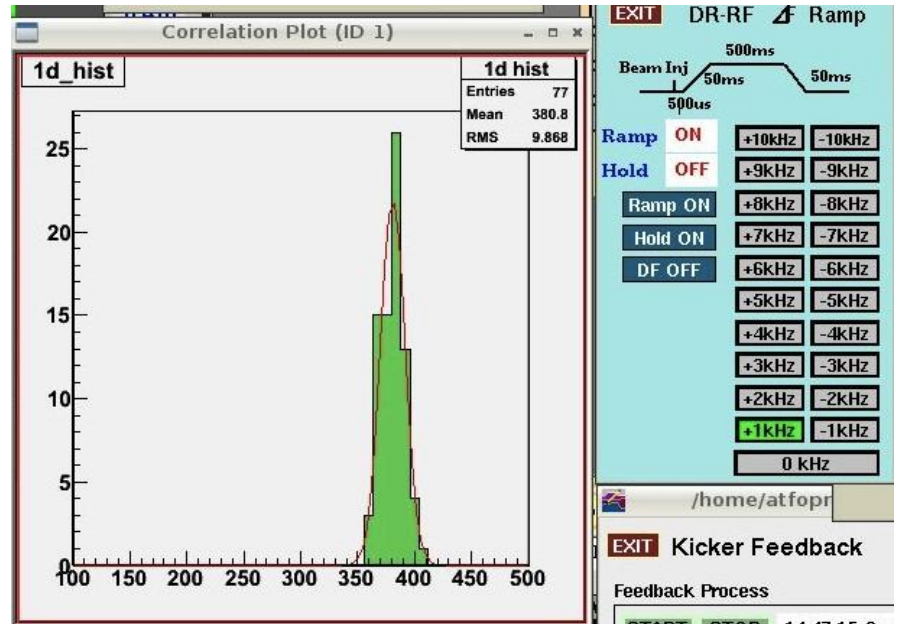

With Re-synchronization

Multi-bunch extraction (27 bunches) with 308ns bunch spacing

2010/03/17

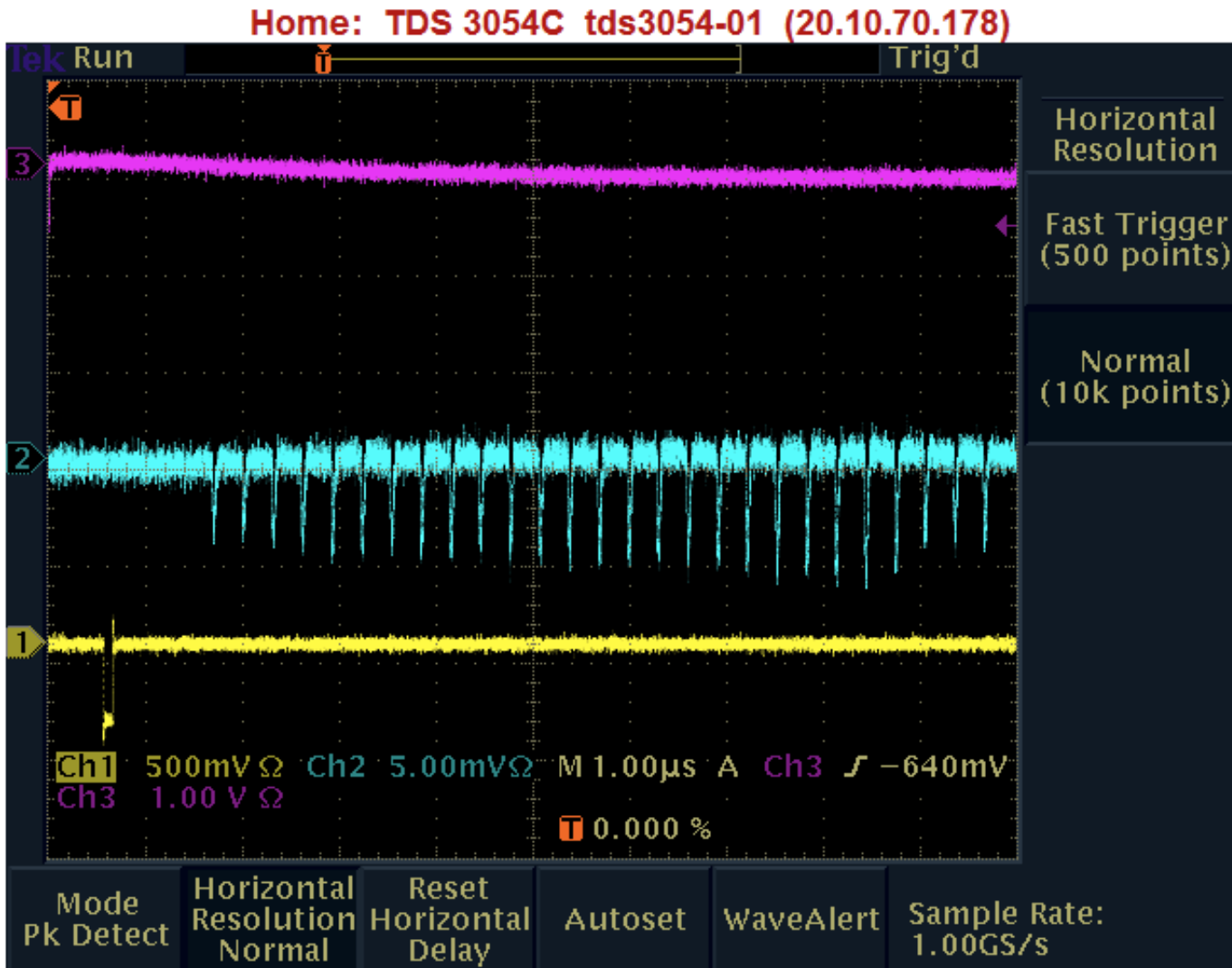

Multi-bunch extraction (30 bunches) with 308ns bunch spacing

2010/06/17

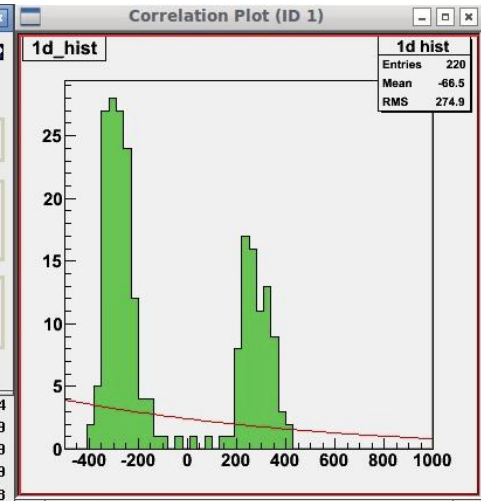
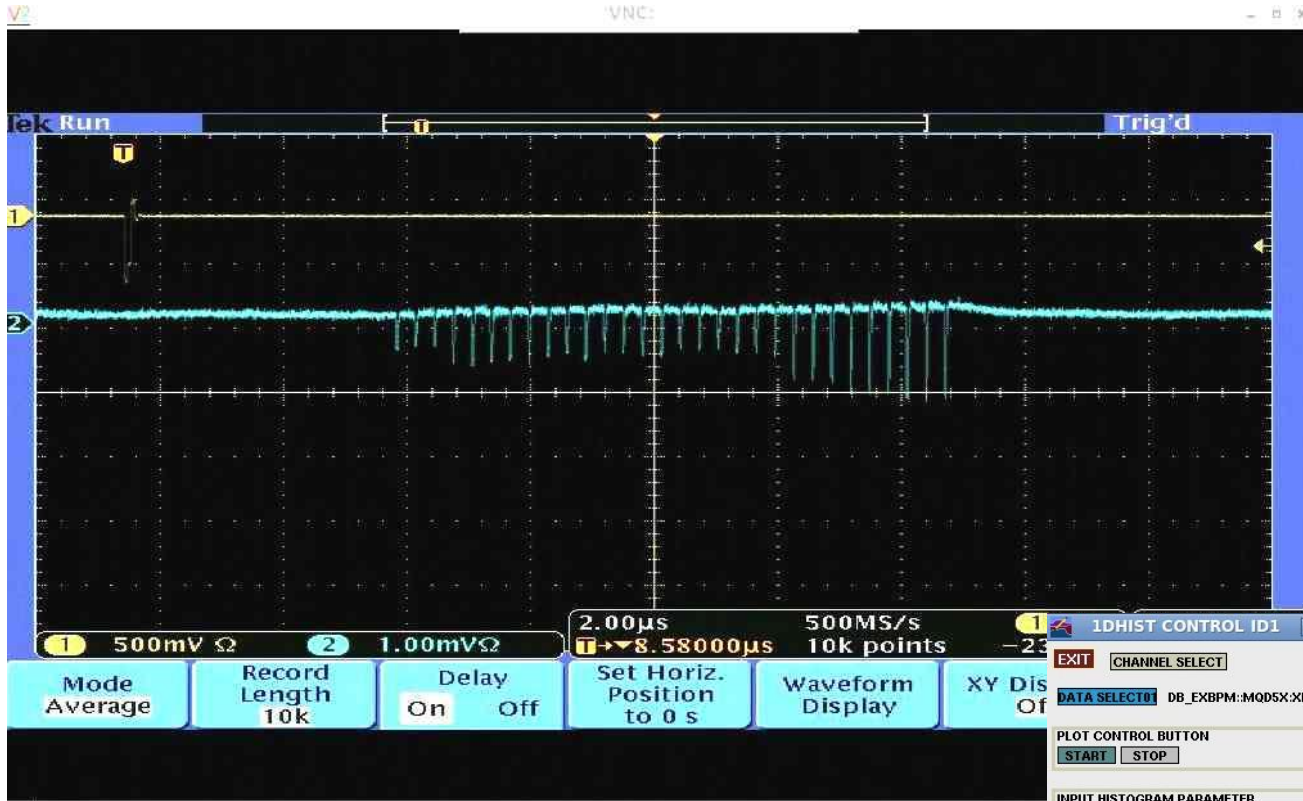

The intensity of each bunch is not flat and unstable.

The horizontal beam position was distributed to two position.

2010/6/30

Multi-bunch beam extraction

There is two problems,

- *Pulse timing of FID pulser - the timing delay of each pulse is different.*
- *Multi-bunch(Multi-train) instability - It makes unstable storage current.(K.Kubo)*

FID10-3000G timing delay from the input to the output

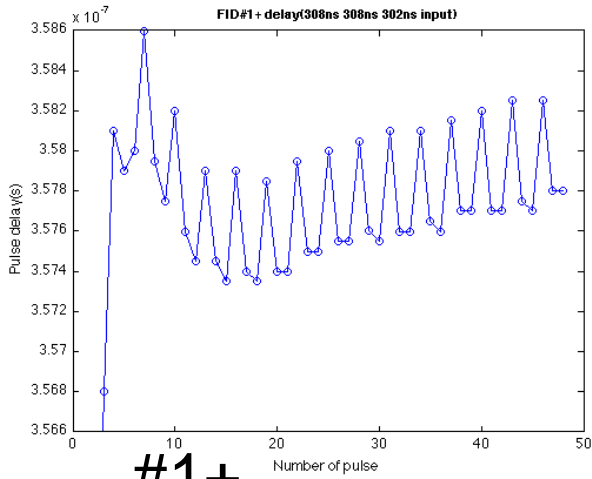

#1+

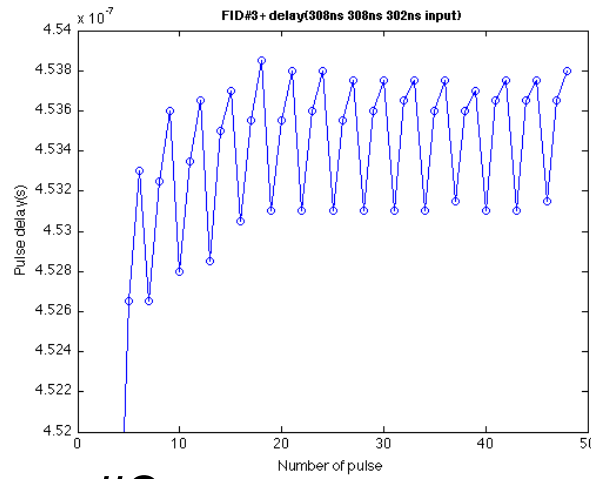

#3+

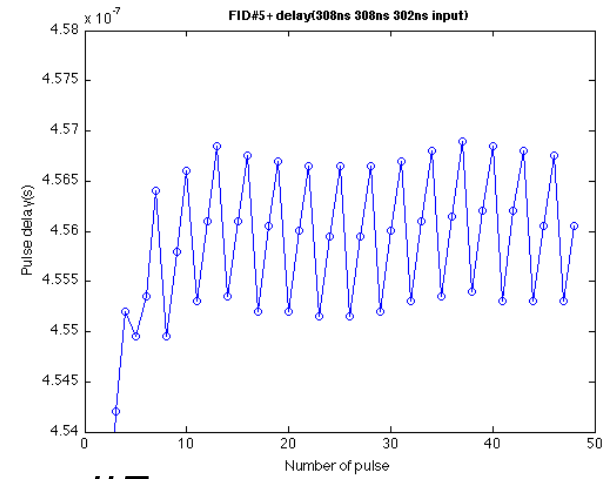

#5+

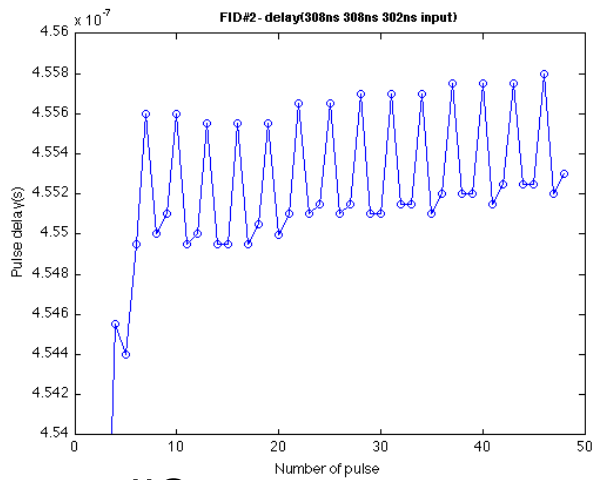

#2-

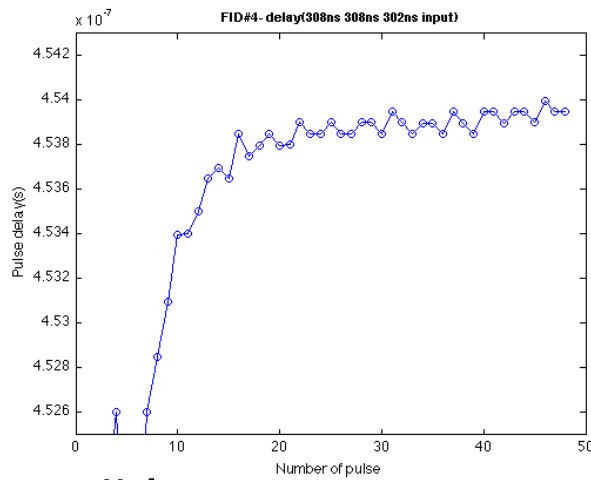

#4-

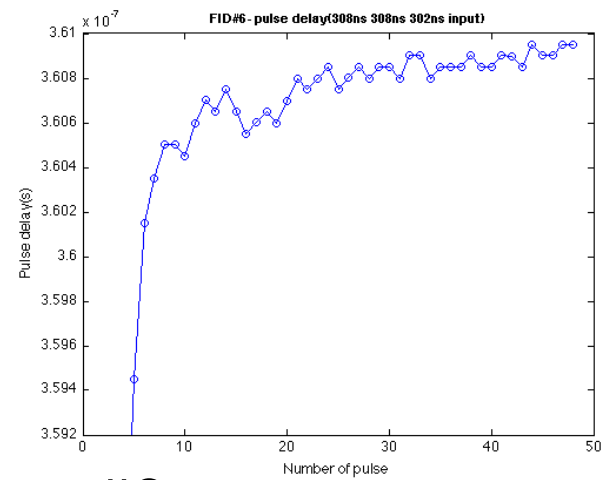

#6-

Hor: number of pulse, Ver: timing delay(200ps/tic)
2010/6/30
measured by a oscilloscope with 50ps/sample resolution

pulse train delay adjustment circuit

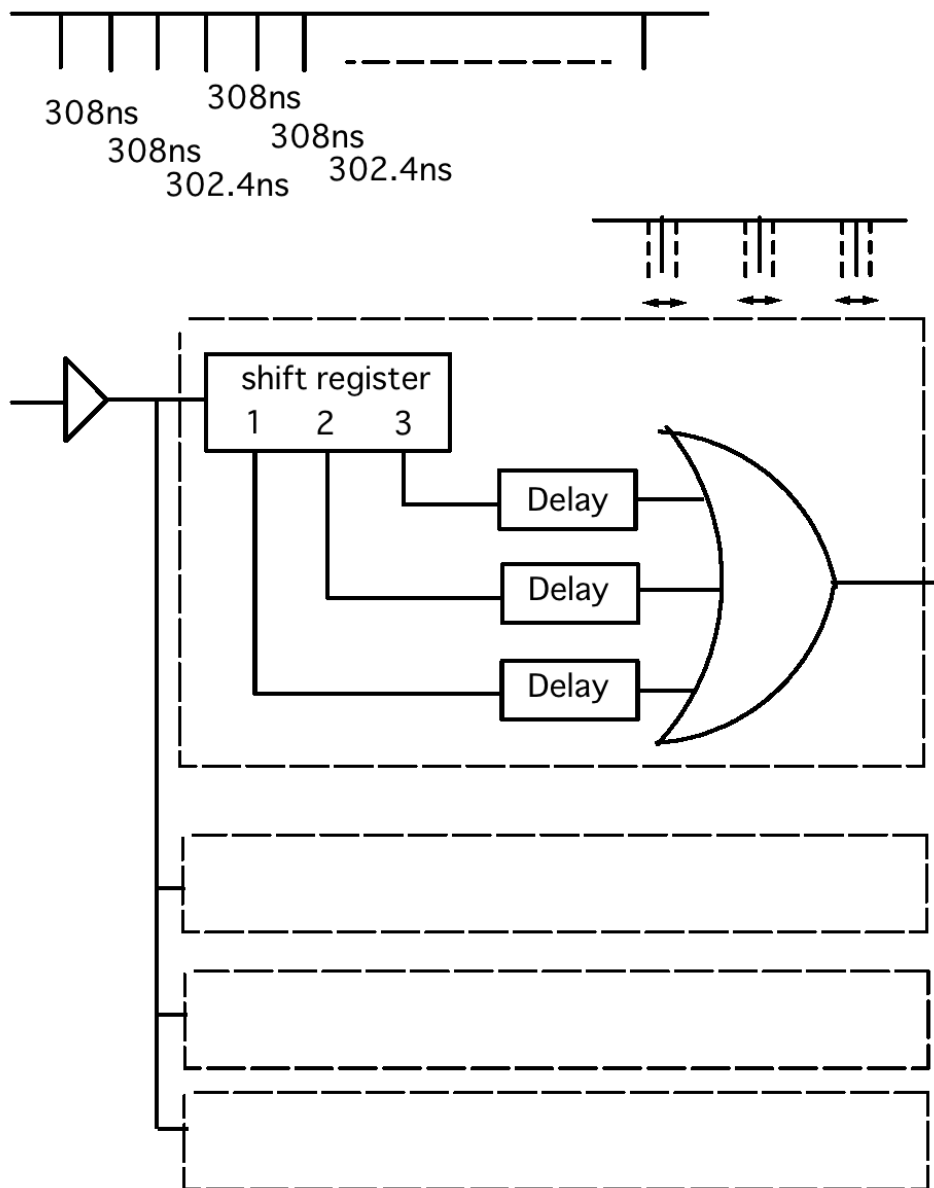

The pulse train of the input signal is separated every three pulses and delayed independently for compensate the output pulse timing of FID pulsers.

The different timing delay of FID pulsers will be compensated by using this circuit.

Instability@multi-train(1)

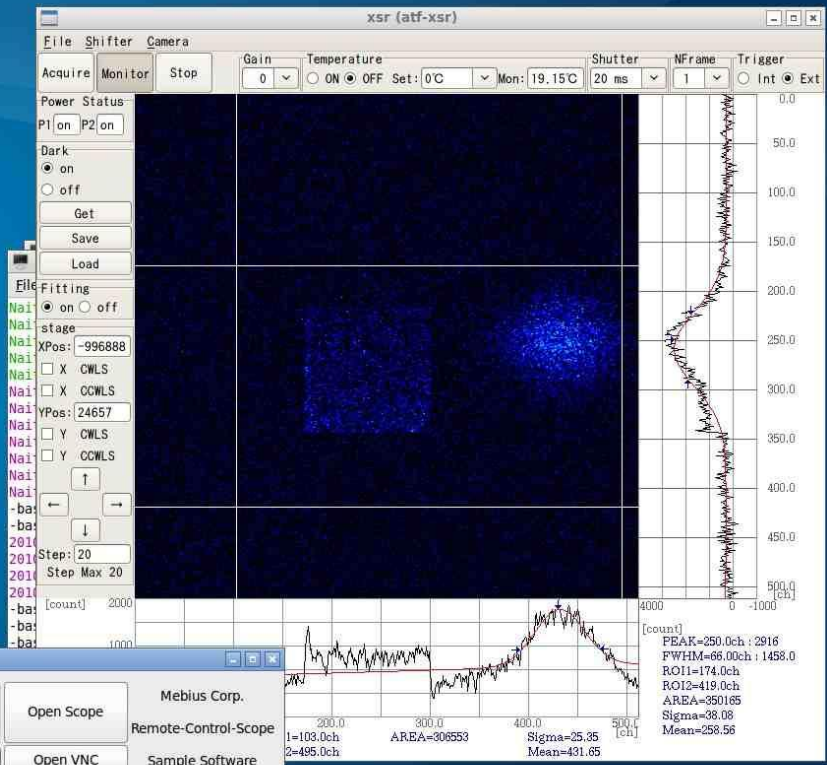
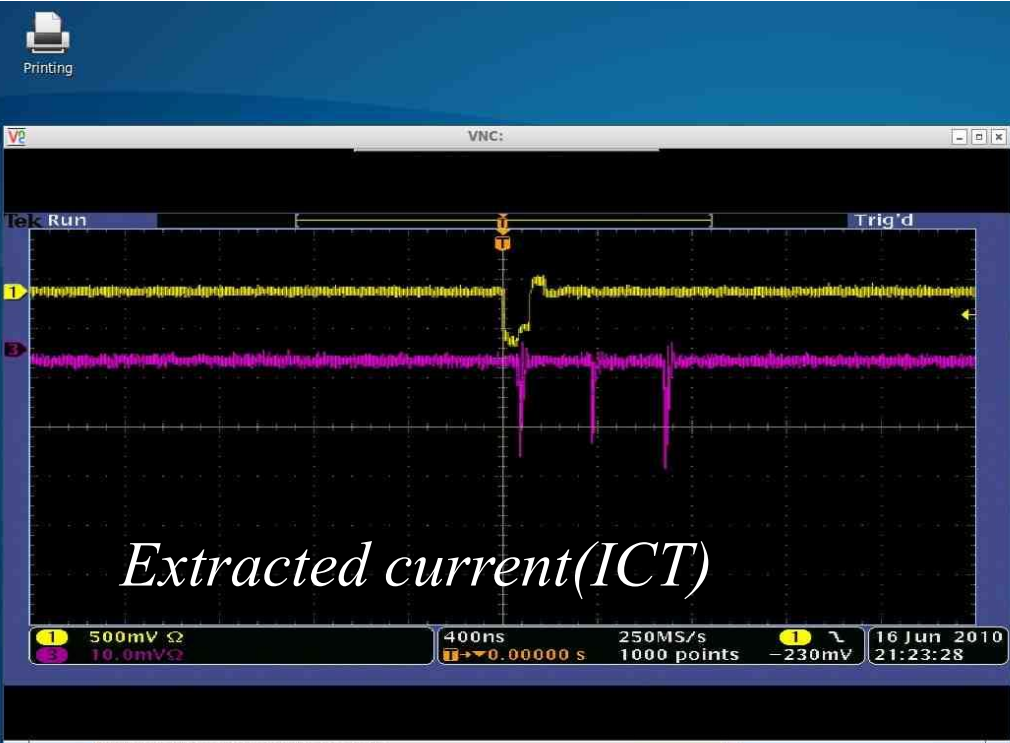

```
atfop4@ubuntu:/atf/op/tools/app$ ls
firefox lxpanel qtiplot RCSSVXIV103 vnc-E4_5_3_r39012-x86
gcalctool panel RCSSVXIV102 RCSSVXIV104
atfop4@ubuntu:/atf/op/tools/app$ cd RCSSVXIV104
atfop4@ubuntu:/atf/op/tools/app/RCSSVXIV104$ ls
CHANGELOG.txt RCSSVXIV104.py vxill user fo
GNU_General_Public_License.txt README.txt vxill user fo
libvxillforc.so remote-ctrl-scope.sh vxill user.h
libvxillforc.so.1 vxill cmd.cc vxill.x
Makefile vxill user.cc vxi.py
RCSSVXI.doc vxill user.cc.patch
atfop4@ubuntu:/atf/op/tools/app/RCSSVXIV104$ ./remote-ctrl-scope.sh

VNC@ Viewer Enterprise Edition E4.5.3 (r39012) for X
Built on Apr 9 2010 16:11:14
Copyright (C) 2002-2010 RealVNC Ltd.
VNC is a registered trademark of RealVNC Ltd. in the U.S. and in ot
See http://www.realvnc.com for information on VNC.
```

RCSSVXIV104.py

Scope IP: 20.10.70.99

MRO(VNC) IP: 20.10.70.100

VNC viewer... /atf/op/tools/app/vnc-E4_5_3_r39012-x86_linux/

CH1:On CH2:Off CH3:On CH4:Off

500.0mV 10.0mV 400.0ns NORMAL CH1 FALL -230.0mV

XSR profile

Instability@multi-train(2)

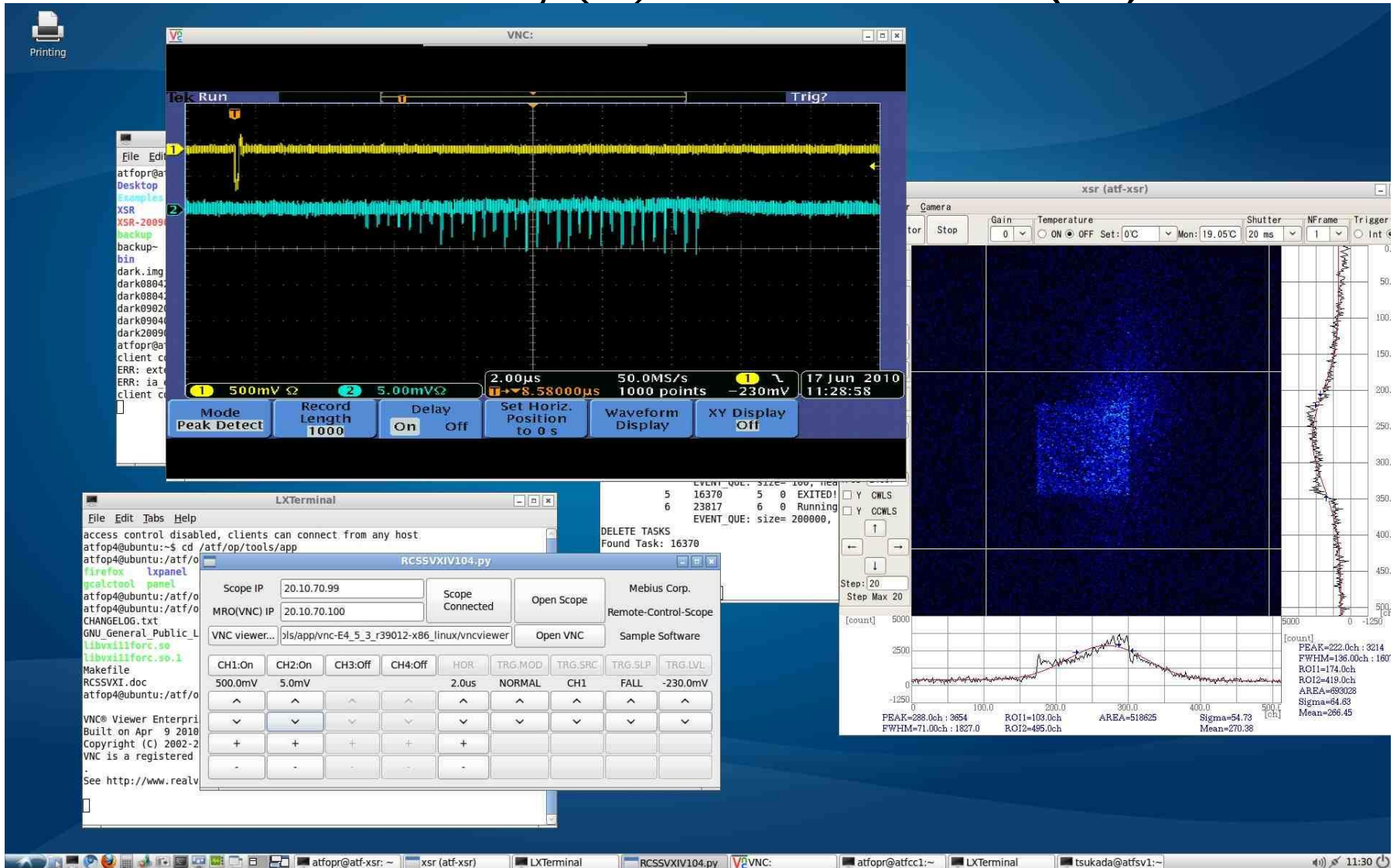

The screenshot displays a Linux desktop environment with several open windows:

- VNC Viewer:** Shows a signal waveform with a sharp spike. The interface includes a toolbar with settings such as **Mode Peak Detect**, **Record Length 1000**, **Delay On**, **Set Horiz. Position to 0 s**, **Waveform Display**, and **XY Display Off**. The scale is set to **500mV** and **5.00mV**. The date and time are **17 Jun 2010 11:28:58**.
- LXTerminal:** Shows system logs and a script execution. The output includes:

```

      access control disabled, clients can connect from any host.
      atfop4@ubuntu:~$ cd /atf/op/tools/app
      atfop4@ubuntu:/atf/op/tools/app$ ./RCSSVXIV104.py
      DELETED TASKS
      Found Task: 16370
      
```
- Camera Interface (xsr):** Shows a dark image with a histogram on the right. The histogram has a peak at approximately 222.0ch. The interface includes controls for **Gain**, **Temperature**, **Shutter**, **NFrame**, and **Trigger**.

Instability@multi-train(3)

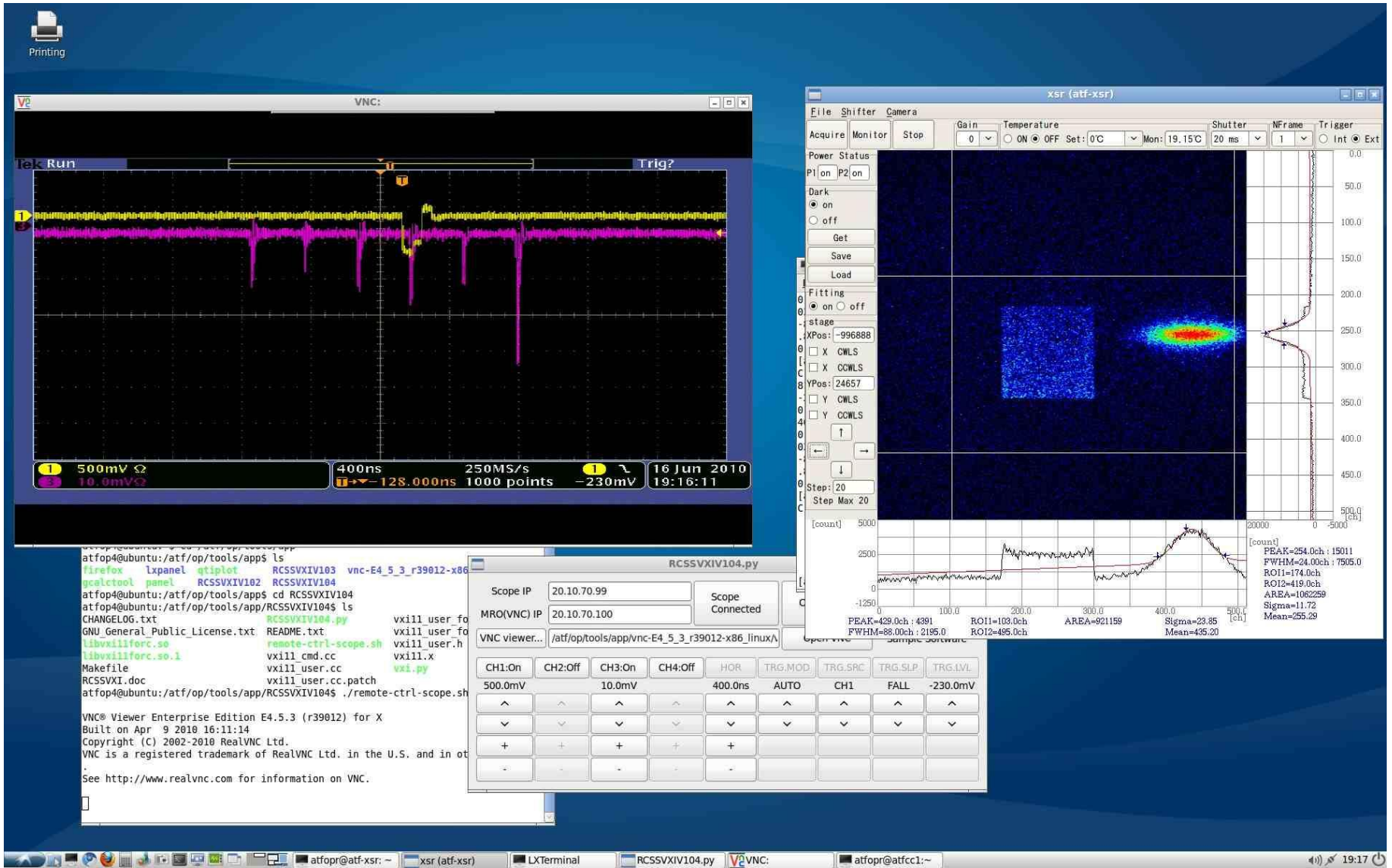

Terminal Output:

```

atfop4@ubuntu:/atf/op/tools/app$ ls
firefox          lxpanel          qtplot          RCSSVXIV103    vnc-E4_5_3_r39012-x86
gcalctool        panel            RCSSVXIV102    RCSSVXIV104
atfop4@ubuntu:/atf/op/tools/app$ cd RCSSVXIV104
atfop4@ubuntu:/atf/op/tools/app/RCSSVXIV104$ ls
CHANGELOG.txt    RCSSVXIV104.py  vxll user fo
GNU_General_Public_License.txt  README.txt      vxll user fo
libvxi11forc.so  remote_ctrl_scope.sh vxll user.h
libvxi11forc.so.1 vxll_cmd.cc     vxll.x
Makefile          vxll_user.cc   vxll1.py
RCSSVXI.doc      vxll_user.cc.patch
atfop4@ubuntu:/atf/op/tools/app/RCSSVXIV104$ ./remote_ctrl_scope.sh
VNC® Viewer Enterprise Edition E4.5.3 (r39012) for X
Built on Apr  9 2010 16:11:14
Copyright (C) 2002-2010 RealVNC Ltd.
VNC is a registered trademark of RealVNC Ltd. in the U.S. and in ot
See http://www.realvnc.com for information on VNC.
  
```

RCSSVXIV104.py Control Panel:

Scope IP	20.10.70.99	Scope	Connected
MRO(VNC) IP	20.10.70.100		
VNC viewer...	/atf/op/tools/app/vnc-E4_5_3_r39012-x86_linuxA		

Channel Settings:

CH1:On	CH2:Off	CH3:On	CH4:Off	HOR	TRG.MOD	TRG.SRC	TRG.SLP	TRG.LVL
500.0mV	10.0mV	400.0ns	AUTO	CH1	FALL	-230.0mV		

xsr (atf-xsr) Analysis Data:

PEAK=429.0ch : 4391	ROI1=103.0ch	AREA=921159	Sigma=23.85	Mean=435.20
FWHM=88.00ch : 2195.0	ROI2=495.0ch			

Peak Analysis Summary:

PEAK=254.0ch : 15011	FWHM=24.00ch : 7505.0
ROI1=174.0ch	ROI2=419.0ch
AREA=1062259	Sigma=11.72
Mean=255.29	



Next Beam Test

*Fast kicker beam test,
2010 Oct(Sep) 2weeks*

Goal of the next beam test,

- 1. To install and test of the pulse train delay circuit.*
- 2. To confirm the stable beam extraction up to 30 bunches, to measure the each orbit of multi-bunch.*
- 3. To confirm the long term stability of the fast kicker.*