

LP1 Beam Test with Three Asian GEM Modules

**EUDET
Annual Meeting 2010
29 Sept 2010
DESY**

**Takeshi MATSUDA
DESY/FLC
In behalf of the Asian LC TPC group and the
Lund group**

(I tank Ryo and Takahiro for their slides.)

Tracking at ILC: Momentum Resolution

1. **Higgs recoil mass: $e^+e^- \rightarrow ZH (Z \rightarrow \mu\mu/ee) + X$:**
If $\delta M(\mu\mu/ee) \ll \Gamma_{Z'}$ then the beam energy spread dominates when $\delta(1/pt) \leq 5 \times 10^{-5}$.
2. **Slepton and the LSP masses through the end point measurement:**
 σM (Momentum resolution) $\sim \sigma M$ (Parent mass) at 1 ab^{-1} when $\delta(1/pt) \leq 5 \times 10^{-5}$
3. **E_{cm} determination from $e^+e^- \rightarrow \mu^+\mu^-(\gamma)$:**
4. **Rare decay Br ($H \rightarrow \mu\mu$) in $e^+e^- \rightarrow ZH$ and Hvv:**



$$\delta(1/pt) \leq 5 \times 10^{-5}$$

ILD example for 1.

$$\Delta M_H \sim 70 \text{ MeV}$$

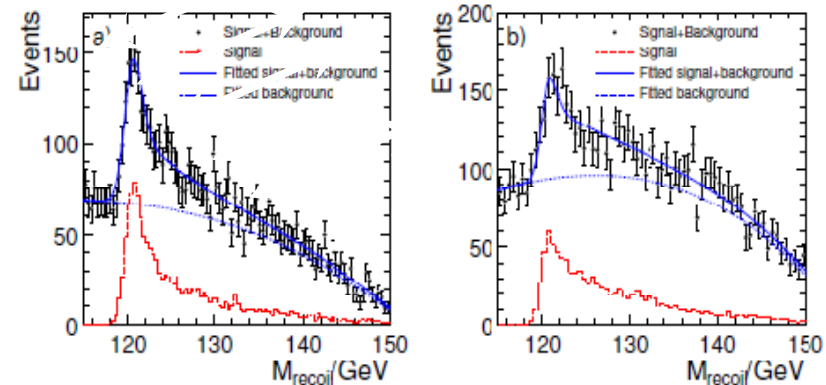

FIGURE 3.3-7. Results of the model independent analysis of the Higgs-strahlung process $e^+e^- \rightarrow HZ$ in which a) $Z \rightarrow \mu^+\mu^-$ and b) $Z \rightarrow e^+e^-$. The results are shown are for the $P(e^+, e^-) = (+30\%, -80\%)$ beam polarisation.

TPC Large Prototype (LP1) Beam Test at DESY Using EUDET Facility

Goals of LP1 Beam Test:

Study, in practice, design and fabrication of all components of MPGD TPC in larger scale; field cage, endplate, detector modules, front-end electronics, and field mapping of non uniform magnetic field. (But not yet the engineering stage.)

Demonstrate full-volume tracking in non-uniform magnetic field, trying to provide a proof for the momentum resolution at LC TPC.

Demonstrate dE/dX capability of MPGD TPC.

Study effects of detector boundaries.

Develop methods and software for tracking, alignment, calibration, and corrections.

Beijing tracker review, Jan 2007

Candidates of MPGD TPC for ILC (ILD)

Analog TPC:

GEMs + narrow pad readout (Asian module, DESY module)

Defocusing by multilayer GEM.

Narrow (1mm) pads.

MicroMEGAS + resistive anode: (Saclay/Canada modules)

Widening signal by resistive anode.

Possibly with wider pads ($\leq 2-3$ mm).

GEMs + Timepix:

As an analog TPC with finer "pad = pixel".

Digital TPC:

Ingrid (MicroMEGAS) Timepix:

Free from the gas gain fluctuation.

Possibly better point resolution.

GEM + Timepix:

Need to improve the efficiency for a primary electron.

LP1 Asian GEM Module

Two layers of thick GEMs + Gating GEM

Current module structure: Two layers of 100 μ m GEM and a gating GEM
Minimize R ϕ boundaries.
Easily replace each layer of GEM.

More parts and a complicated structure
Flatness of GEMs (dE/dX)

PCB on BackFrame

- 2 pieces

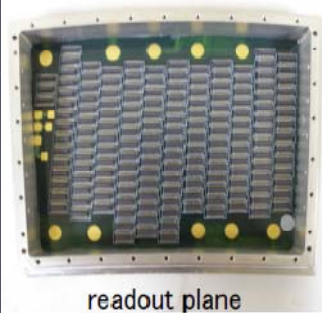
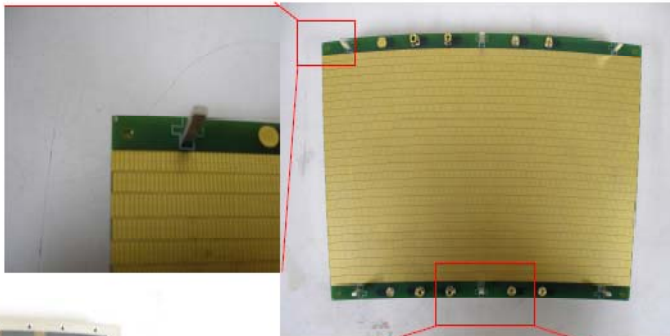

readout plane

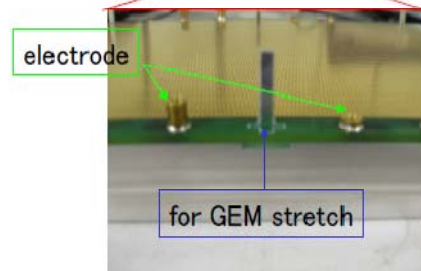

- Amp. GEM
 - 100 μ m-thick
 - 70 μ m ϕ , 140 μ m pitch
 - Insulator : LCP
 - 12 pieces

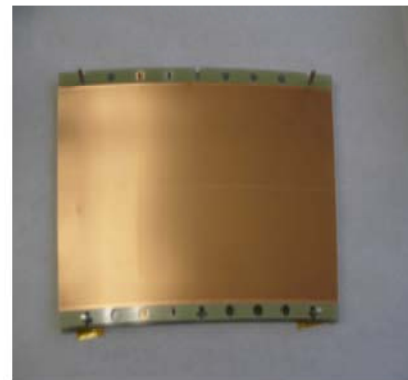

- Gate GEM
 - 14 μ m-thick
 - 90 μ m ϕ , 140 μ m pitch
 - 3 pieces



LP1 Asian GEM Module

Two layers of thick GEMs + Gating GEM

LC TPC Asian group

GEM Module (w/o Gating GEM)

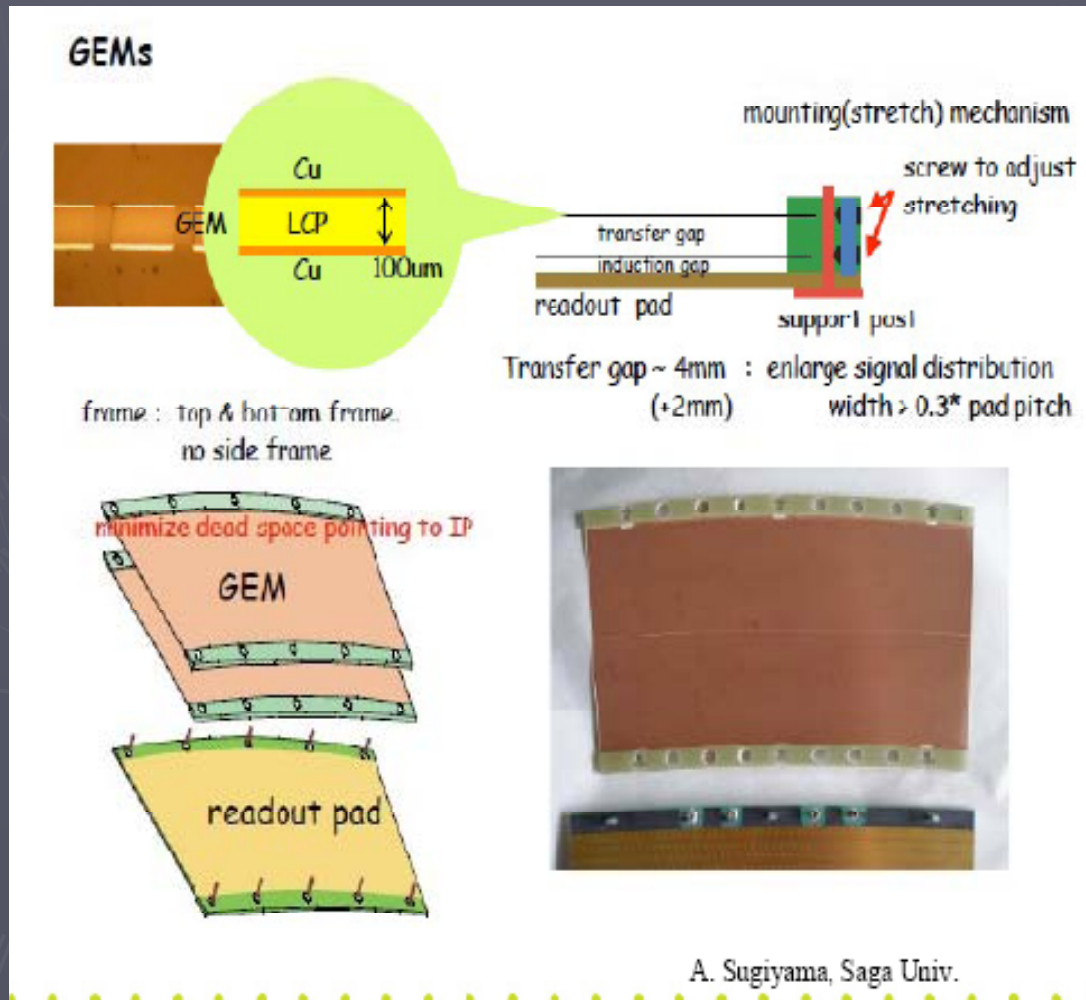

- 28 pad-rows of 176 -194 pads
- Pad size $\sim 1.1 \times 5.4 \text{ mm}^2$
- Total 5152 pads/modules

- GEMs: 2 layers of GEM (100µm) (w/o Gating GEM this time.)

Electrically divided in 2

Transfer gap = 4 mm

Induction gap = 2 mm

(Gating = 10 mm)

- 4 modules made and 3 modules installed to cover full length of beam

- GEMs from SiEnergy & PCB layout/fabricated by Tsinghua University

LP1 Asian GEM Module

Two layers of thick GEMs + Gating GEM

(Pictures in March 2010)

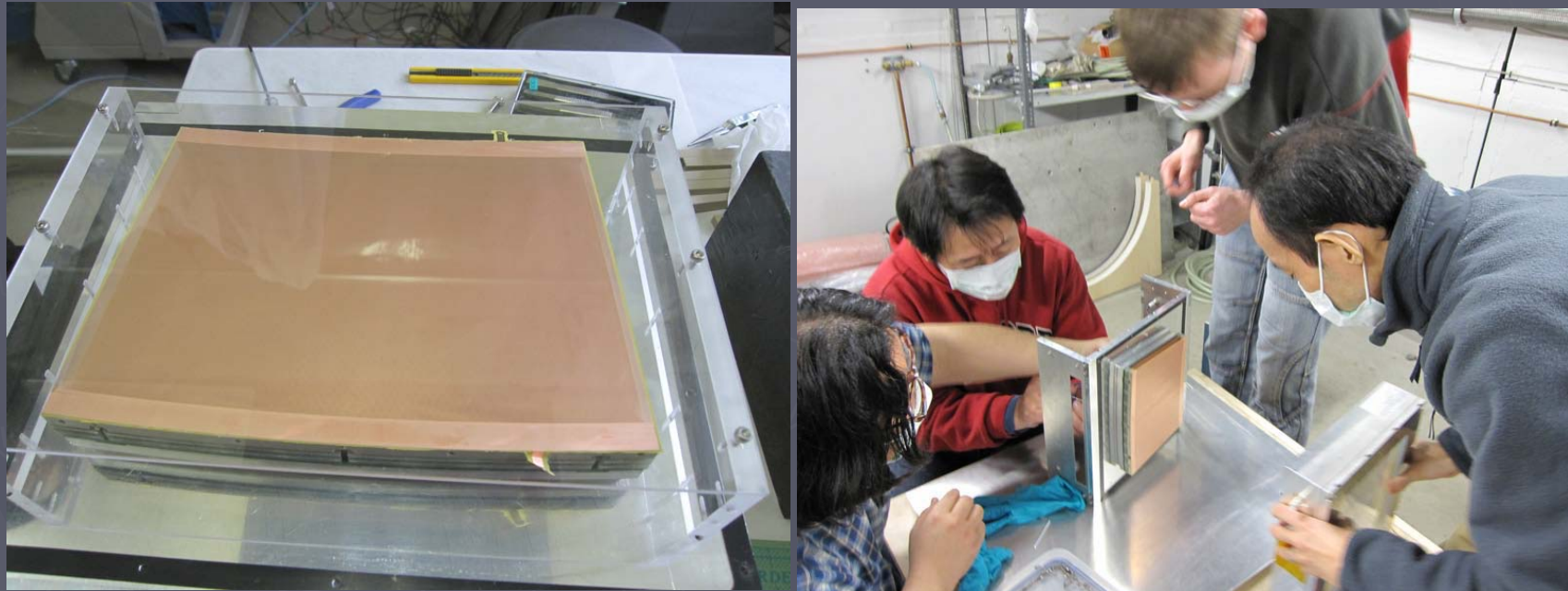

Electron transparency of the current gate GEM is not high (1T and $E_d=100V$): 50% from the position resolution for cosmic tracks in MP TPC, and 24-33% in the test with Fe55 in March 2010 at DESY and KEK

Some of the gating GEMs were broken in an accidental discharge in the March 2010 beam test → Need some replacement in a short term.

LP1 Beam Test of Asian GEM Modules in September 2010

A field shaper in place of the gating GEM:

A tentative solution for this beam test without gating device; a gating GEM, gating wires, or something else, since we need a gating device at ILC!

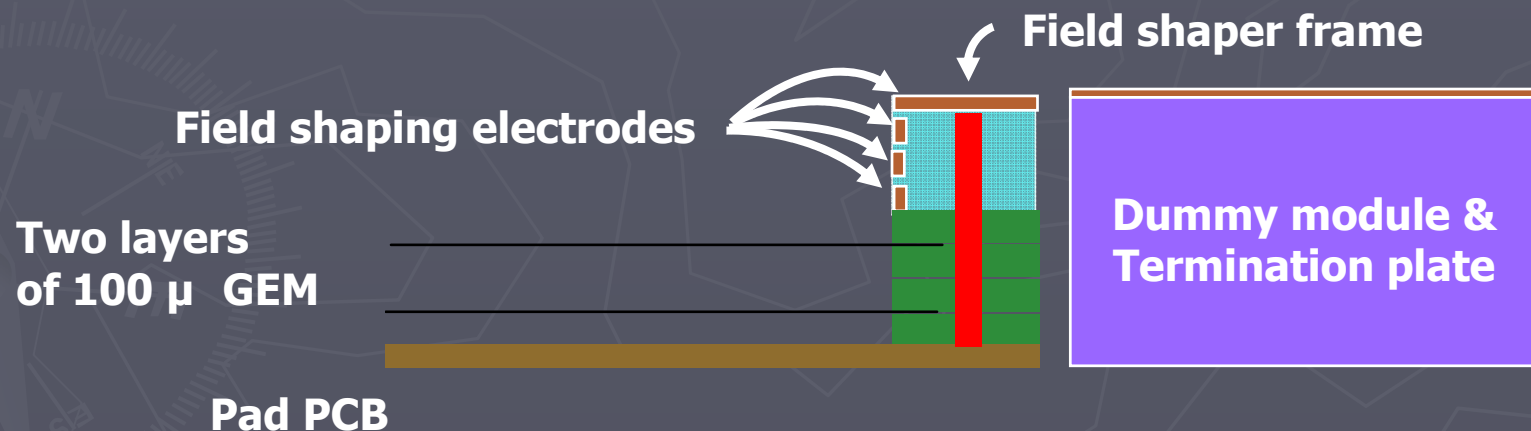

LP1 Beam Test of Asan GEM modules in September 2010



An Asan GEM module: A field shaper in place of the gating GEM.

ALTRO Readout Electronics with PAC16 mounted on the LP1 TPC:

**Total 7616 readout channels.
With an enforced air cooling system.**

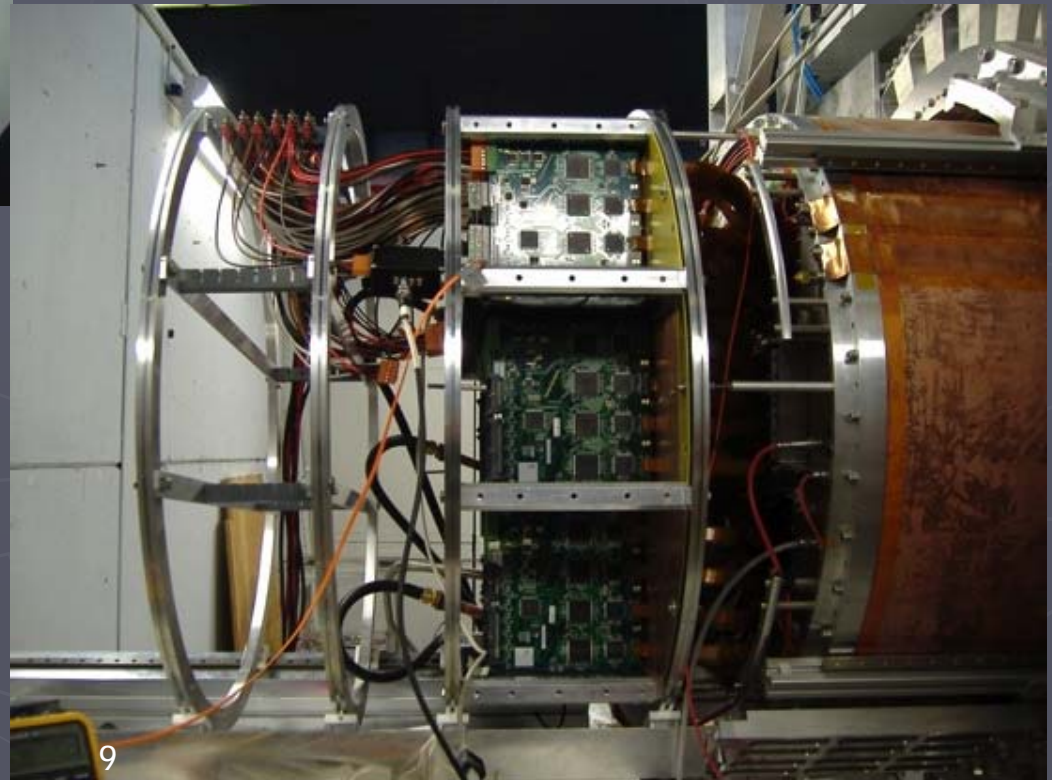

Events by 5 GeV/c Electron Beam

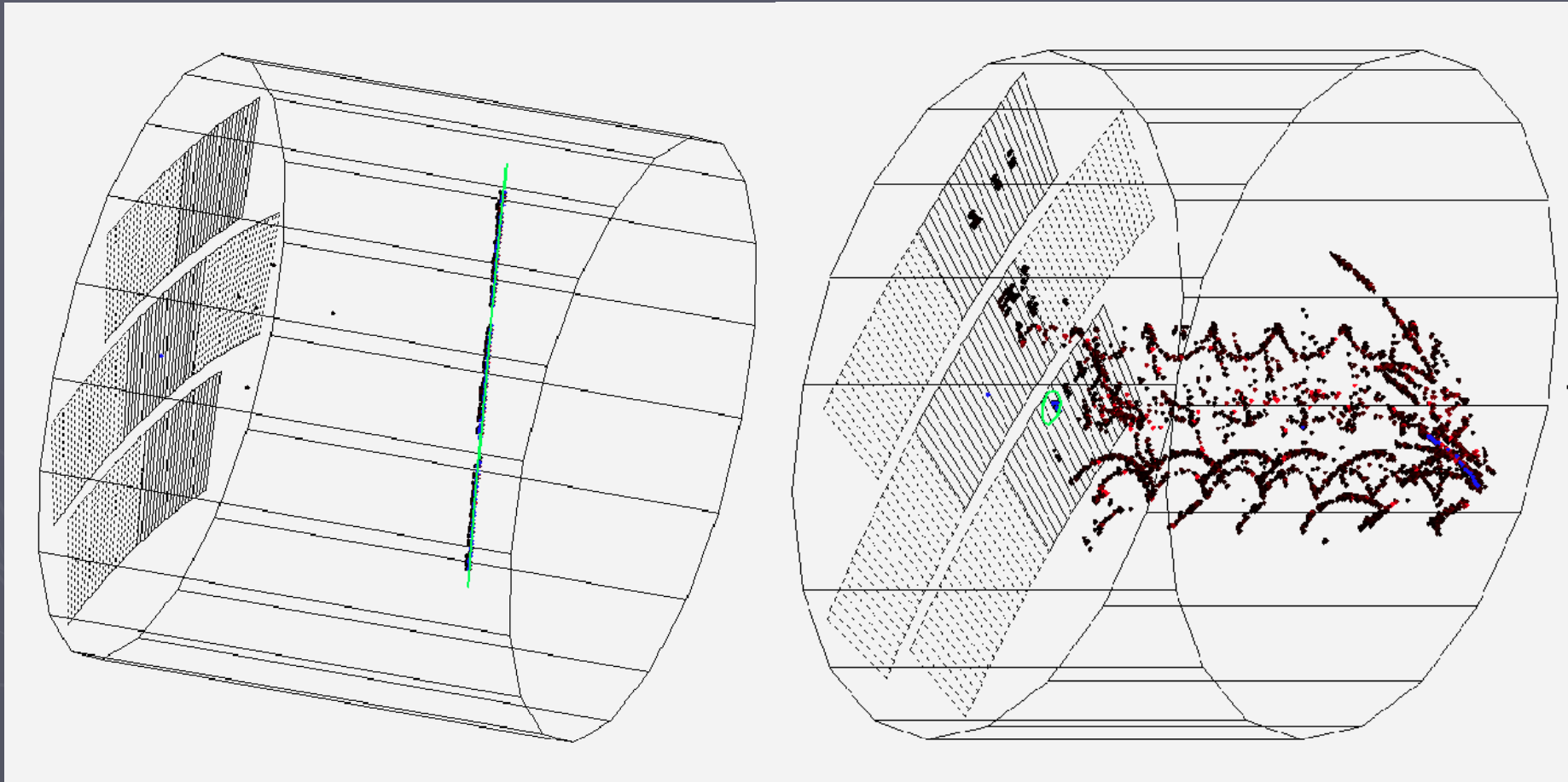

A typical single track event (left), and an event with many low-energy curling tracks from the TPC cathode plane where a beam electron hits (right). Only a part of the three GEM modules are quipped with readout electronics.

Two Tracking Software

YokalowMon with Track-Finding Kalman Filter Processor:

Use Kalman filter algorithm only in track fitting.

**Tracking with only hits around center of modules; pad rows: 6 ~ 21
n.d.f cut > 80 (maximum n.d.f = 90) , No. of tracks in an event = 1
in this analysis**

Marlin TPC with Track-Making-Kalman-Filter-Processor:

Use Kalman filter algorithm both in track finding and track fitting

MaxSkipRows 5, MinTrackHits 60,,, in this analysis

Some Preliminary Results: An Example of Drift Velocity

Relative drift length was measured by a linear scale of PCMAG movable table with a very good resolution
Measurement error is dominated by the uncertainty of gas composition, which is not included here.

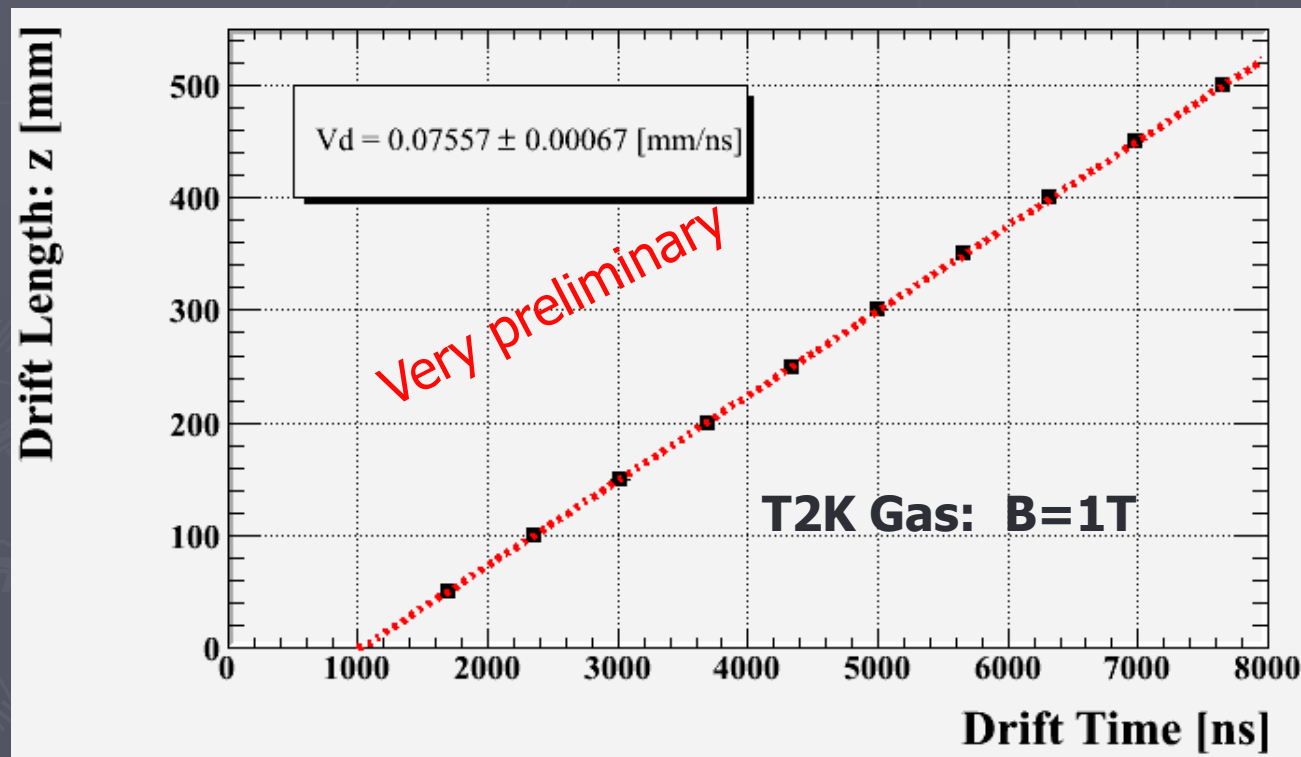

Magboltz (v8.5) gives 7.509 ± 0.002 [cm/ μ s]
at $T = 290\text{K}$, $P = 1$ atm, with 200 ppm H_2O

Some Preliminary Results: An Example of Transverse Diffusion Constant C_D from Pad Response

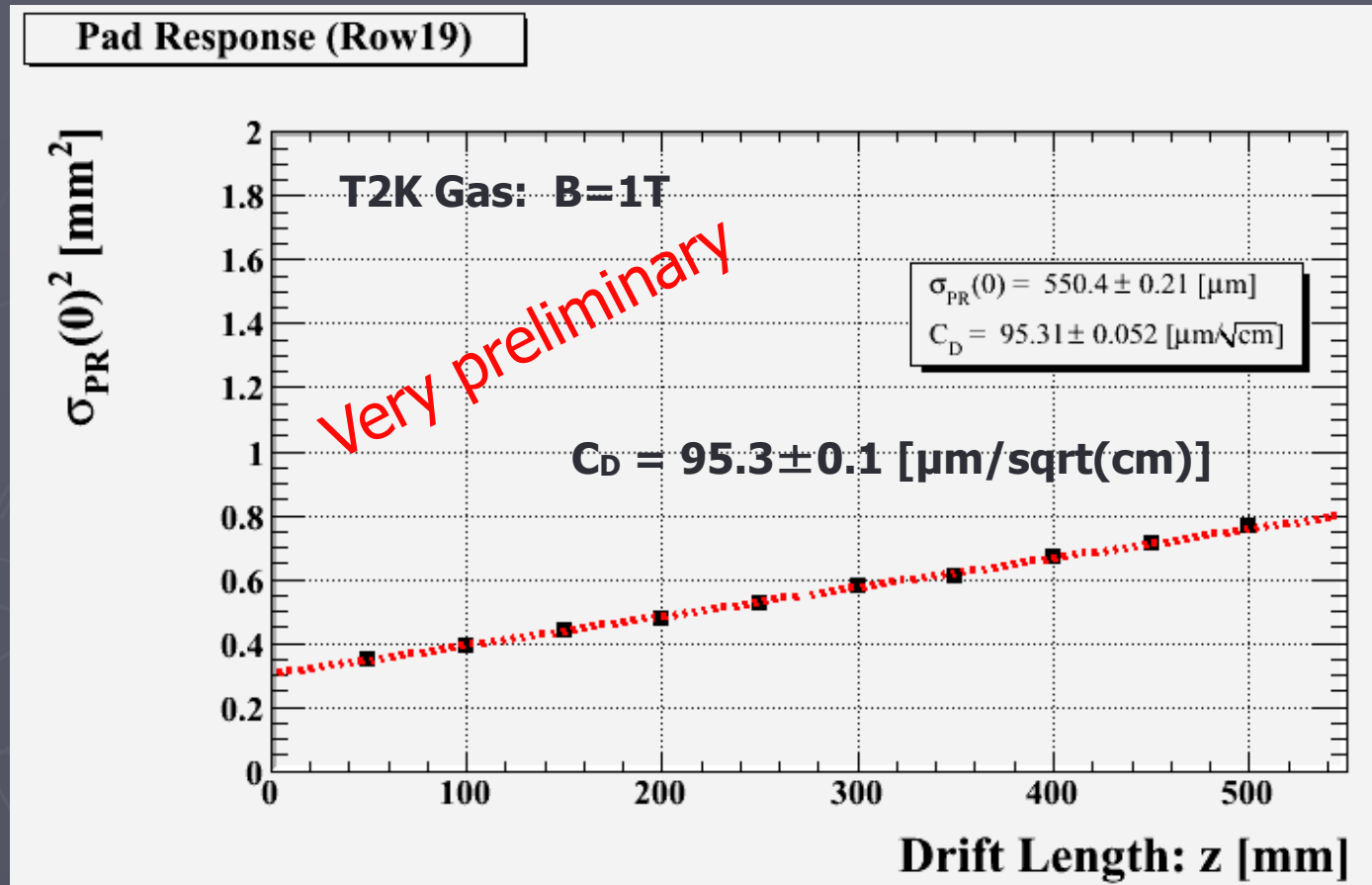

Magboltz (v8.5) gives $C_D = 94.3 \pm 1.9$ [$\mu\text{m}/\text{sqrt}(\text{cm})$] at
 $T = 290\text{K}$ and $P = 1$ atm with 200ppm H_2O .

Some Preliminary Results: An example of Point Resolutions

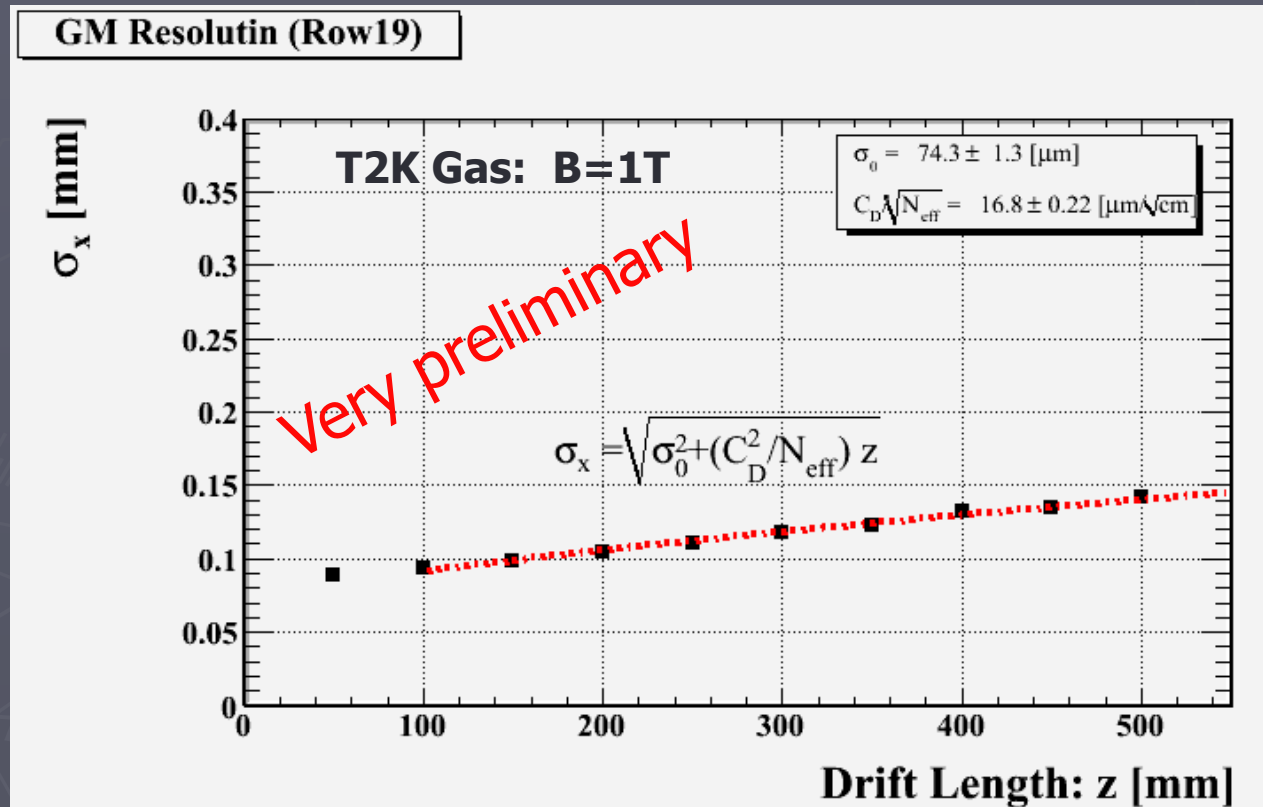

Note that T0 correction has not been applied.
This point resolution measurement gives Neff of around 30.

Some Preliminary Results: Track Fitting (1/P_T Distribution)

Preliminary results by Marlin TPC

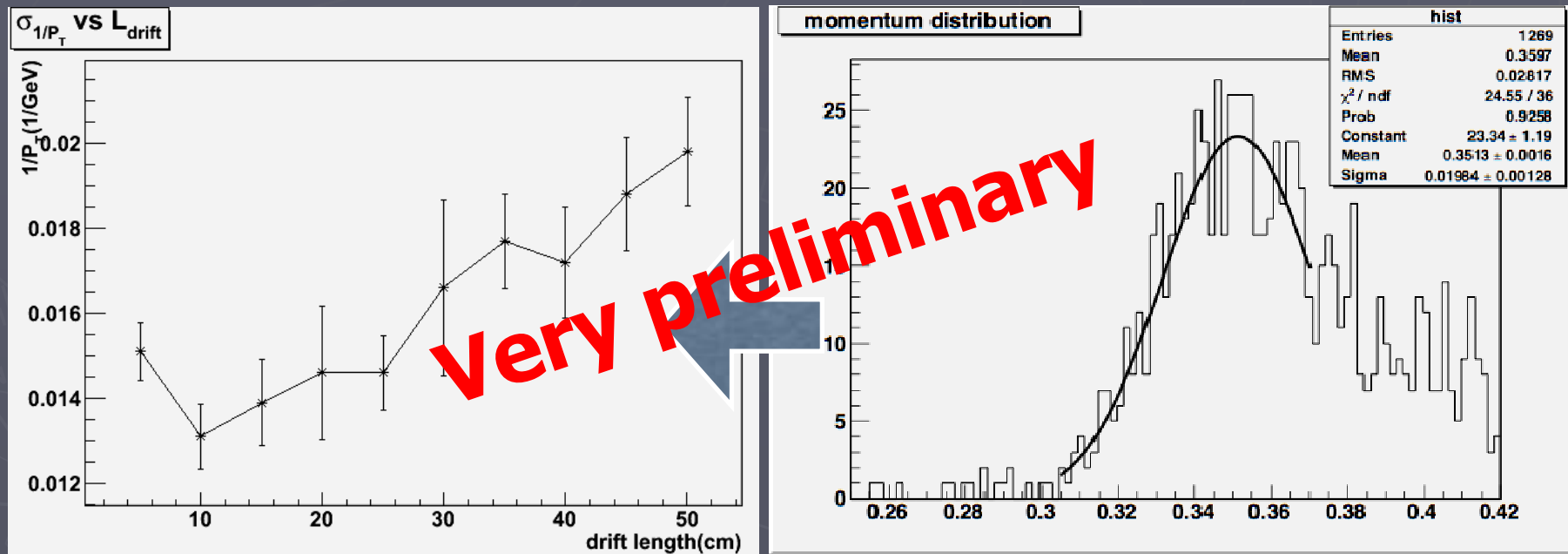

Note that large distortion seen due to wrong voltages applied to the Field shaper strips shifts the peak of the momentum distribution. No correction has applied yet in this data.

Significant Distortion !

Wrong voltages applied to the Field Shaper strips

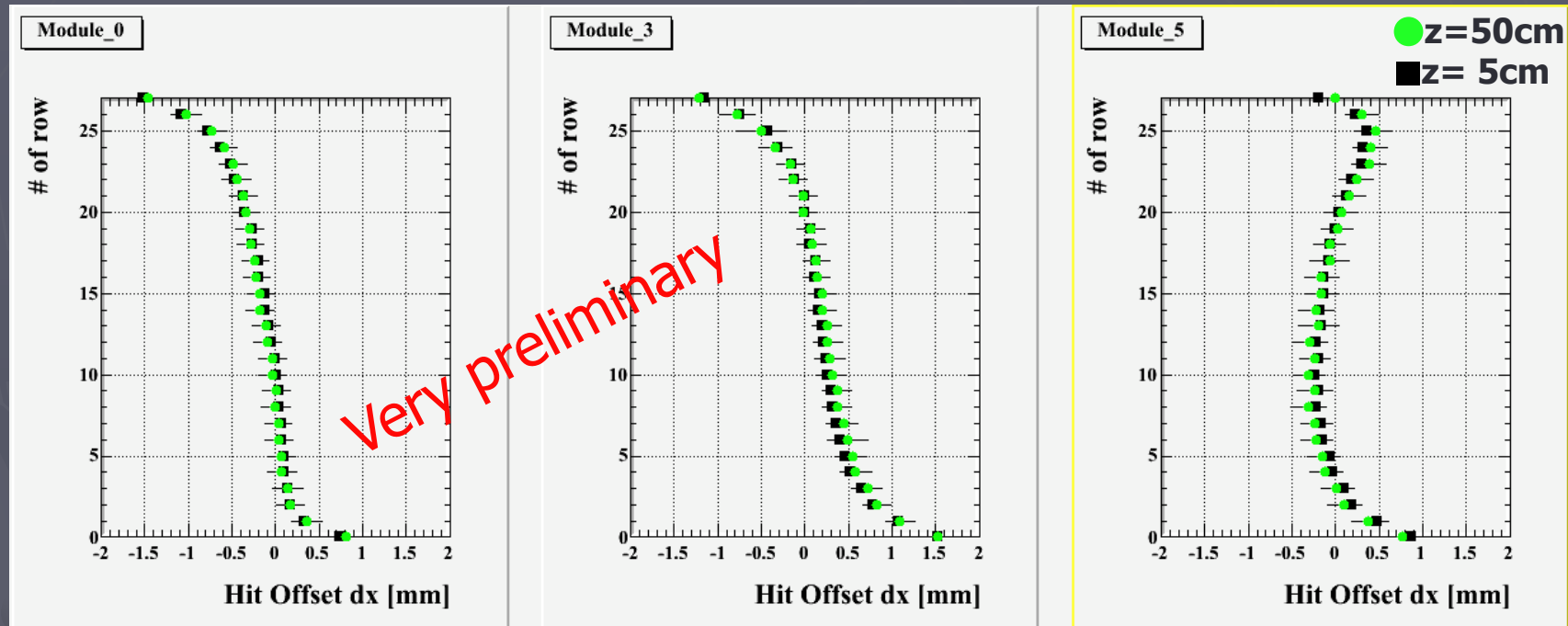

The wrong voltages could have been corrected easily, but the beam test was terminated by other problems.

This distortion limits us to measure the momentum of track.

Significant Distortion! Due to Wrong Voltages applied to the Field Shaper Strips

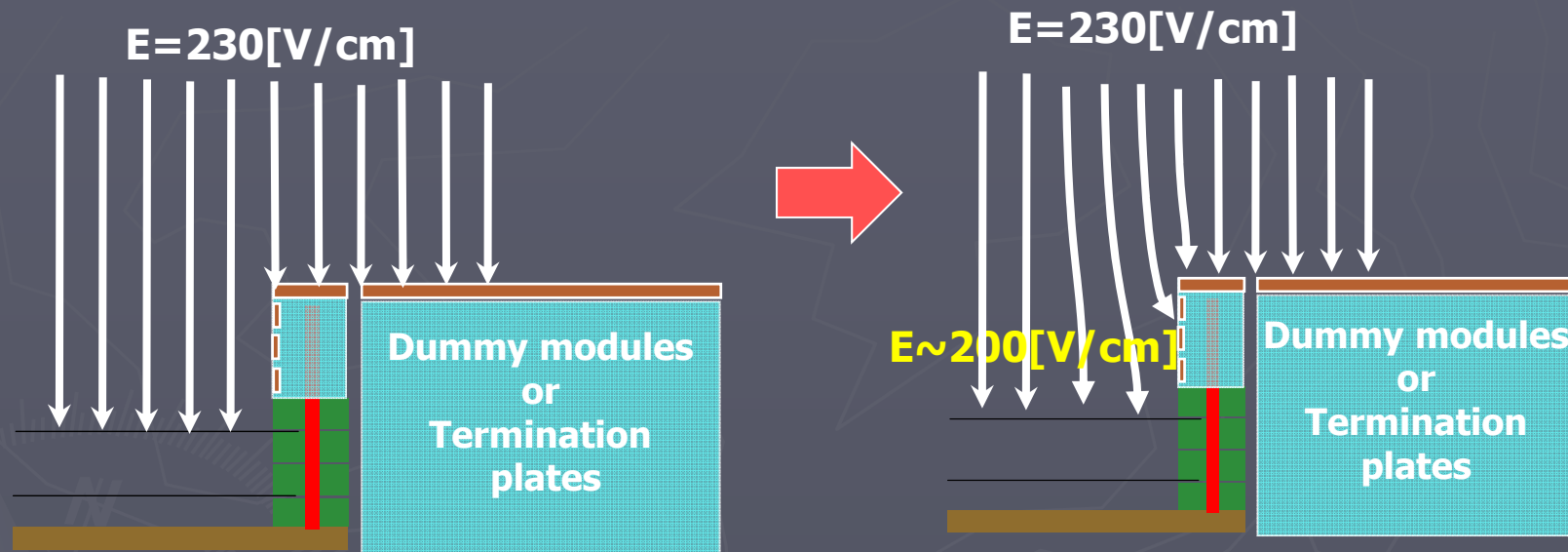

Proper voltage setting

Wrong voltage setting by a simple misunderstanding/miscommunication!
(The height of the field shaper frame)

We can correct this wrong voltage setting easily. However, we had not the time because we decided to terminate the beam test by other problems.

Other Problems

This should not be , probably, a place to discuss our failures, but,,,

(1) Failure of one (top module 5) of the field shapers : A bad connection or bad resistors inside the field shaper caused trips of the HV for the 7th strip of TPC field cage (and eventually also GEMs) . Possibly discharge to the 7th strip. → Stopped the beam test!

**(2) Increased dead channels of the ALTRO readout electronics:
See next slide for possible cause, most probably (3).**

(3) Trips of GEMs: Due to (metal) dust in TPC?

Replaced two unstable GEMs before data taking, and one dead GEM. During the data taking. To replaced the dead GEM, the Lund group dismounted and mounted the ALTRO readout electronics, which took 1.5 day. One highly possible cause is (metal) dust (in TPC). Need some measures to decrease the risk to bring in dust during the module mounting procedure, and to keep reasonably-clean environment in laboratories and the beam test area.

Influence of LP1 GEM Trip to FEC frontend In our GEM HV scheme

Observation:

No. of dead channels and No. of FECs with problematic high pedestals increases gradually. (The phenomena are observed most frequently for the module 5.)

The pedestal seems to recover after FEC power reboot, but the dead channels seems un-recoverable.

Dead channels and pedestal increase may be happening after GEM trips, although we are not very sure.

We want to know whether the GEM trip can really damage the FEC frontend (by a simple Spice simulation).

Influence of LP1 GEM Trip to FEC Frontend: In OurCurrent HV Scheme for GEM

Spice Simulation – Results

TopSPICE 7.10a
23-SEP-2010
18:54:37

— V(VD0)
— V(VG0)
— V(VD1)
— V(VG1)
— V(VG2)

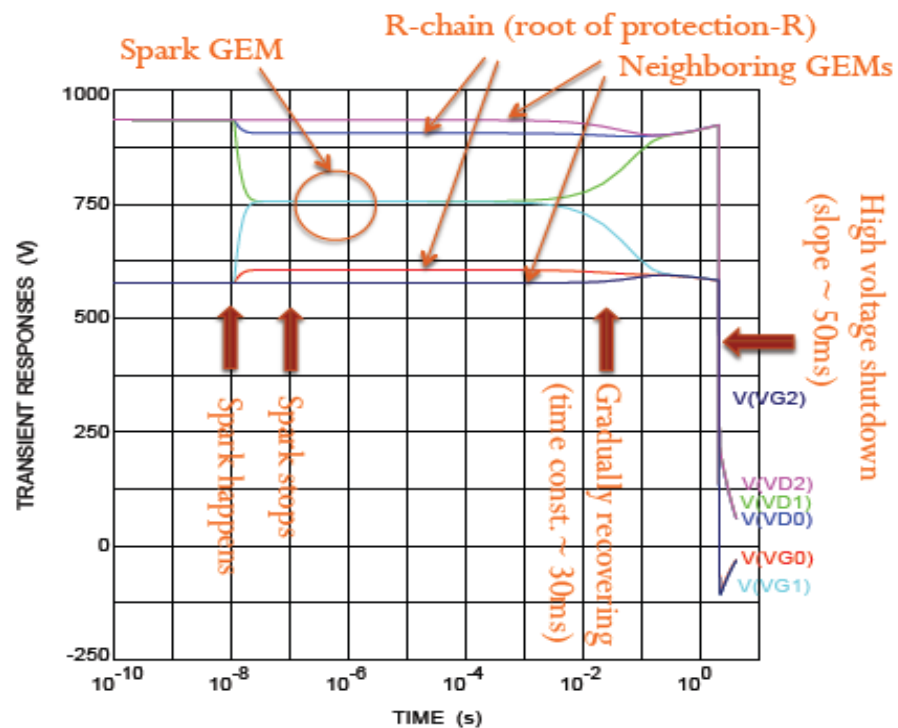

Spice Simulation – Circuit 1

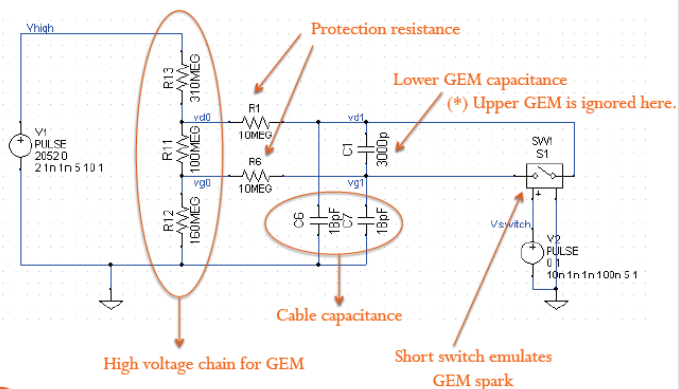

3

arch\lctpc\100918 [topspice] gem spark\topspice without gem-resistance\DIFF.OUT Rev: 236

Influence of LP1 GEM Trip to FEC frontend In our GEM HV scheme

What's happened by sudden change of the lower GEM (anode side)?

Change of the voltage between the lower electrode of the lower GEM and an anode pad:	150V
Distance between the lower GEM and anode pads:	2mm
A pad size:	1mm x 5mm
The capacitance between a pad and the GEM:	about 25fF
The charge induced on the pad: $25\text{fF} \times 150\text{V}$:	$\sim 4\text{pC}$

Applied to 100fF feedback capacitor **40V in CMOS!**

Each PCA channel has protection against up to 10V, but over-10V is not well known. So, as a conclusion, GEM trip can damage PCA frontend channels.

Then, need to minimize the voltage change of the lower electrode of the lower GEM when it trips.

Influence of LP1 GEM Trip to FEC Frontend: A Possible Measure in Our Current HV Scheme

An immediate measure in the current HV scheme is the insertion of a protection capacitance to make the voltage change slower. We may also use other scheme of HV.

Insertion of Protection Capacitance to make the voltage change slower

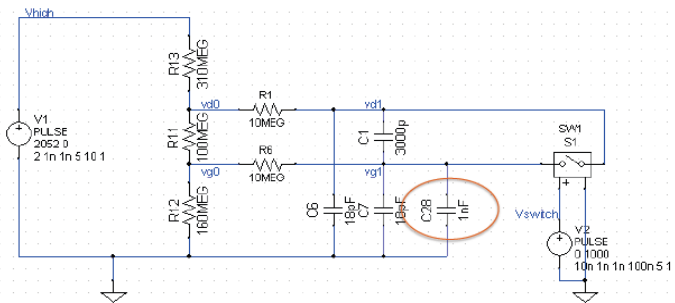

Effect of the Protection Capacitance

TopSPICE 7.10a
23-SEP-2010
23:05:40
— V(VD0)
— V(VG0)
— V(VD1)
— V(VG1)
— V(VD2)
— V(VG2)

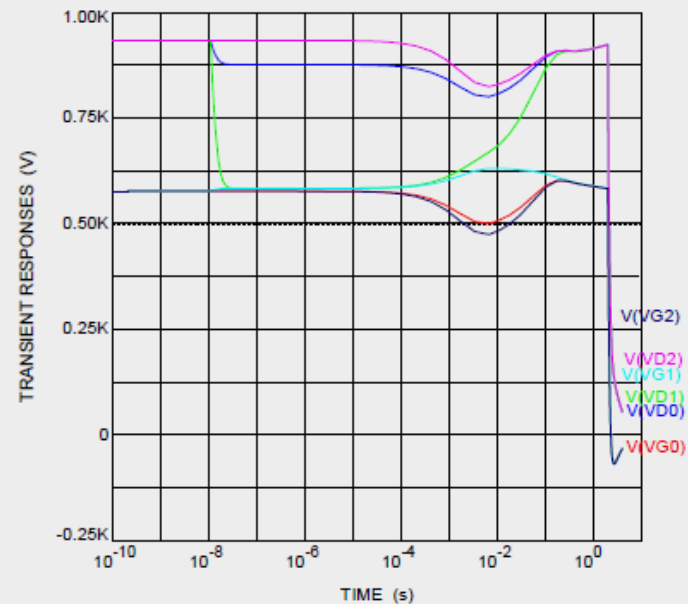

Conclusions

We have performed a beam test of the three Asian GEM modules with the filed shapers, using the EUDET TPC Large Prototype (LP) test facility, in September 2010.

The three GEM modules were readout by 7616ch ALTRO readout electronics successfully.

Significant track data of 5GeV/c electrons at 1T were collected quickly using the PCMAG movable table. The beam test was shortened due to a malfunction of one of the field shapers.

The data are being analyzed by two tracking software: YokalowMon with the track finding Klamann filter and marlin TPC with the track making Kalman filter.

Preliminary results of the drift velocity, diffusion constant, and point resolution seem to be constituent with the expectations and previous results . The distortion observed due to a wrong voltage setting of the field shaper limits our momentum measurement.

The problem of the GEM trip and the increase of the dead channel of the readout electronics has to be solved before next beam test.