

Introduction to CLIC detectors and accelerator

Lucie Linssen, CERN

<http://lcd.web.cern.ch/LCD/>

<http://cern.ch/CLIC-study>

- The LHC has brought us to the threshold of discovery of new physics. We hope to cross it very soon.....
- If the new physics is within the centre-of-mass reach for a future linear e^+e^- collider, the structure of that new physics can be determined with high precision:
 - Higgs sector
 - SUSY
 - Extra
 - Electroweak Symmetry Breaking
 - symmetries, dimensions...
- Physics information from an e^+e^- Collider is **complementary** to physics input from pp collisions at LHC
- LHC will indicate what physics, and at which energy scale
- The current CLIC detector and accelerator studies address 3 TeV in the centre of mass (the most difficult case).
- A staged energy approach up to 3 TeV is foreseen for CLIC

linear collider, producing e^+e^- collisions

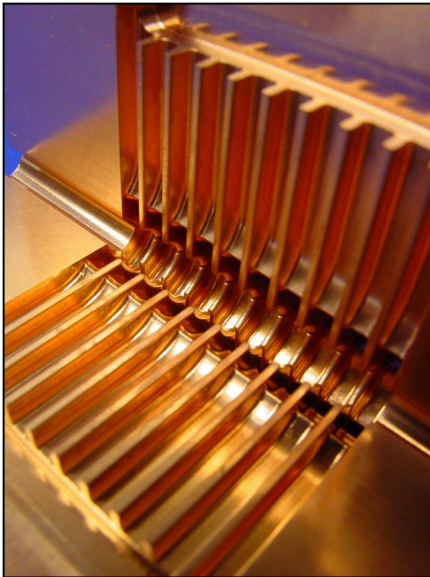

CLIC

ILC

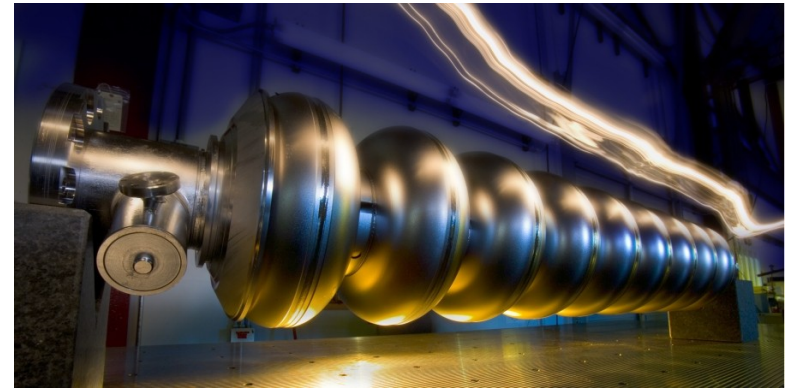

- Based on 2-beam acceleration scheme
- Gradient 100 MV/m
- Energy: 3 TeV, though will probably start at lower energy (~0.5 TeV)
- Detector study focuses on 3 TeV

- Based on superconducting RF cavities
- Gradient 32 MV/m
- Energy: 500 GeV, upgradeable to 1 TeV (lower energies also considered)
- Detector studies focused until now mostly on 500 GeV

Luminosities: few $10^{34} \text{ cm}^{-2}\text{s}^{-1}$

- Introduction to the CLIC accelerator
- Beam-induced background
- Detector concepts at CLIC
- Detector challenges at CLIC
 - Comparison to LHC
- A bit about sub-detectors
 - Vertex detector
 - Hadron Calorimetry and Particle Flow Analysis (PFA)
- Current linear collider detector activities @ CERN
- R&D plans

Two Beam Scheme:

Drive Beam supplies RF power

- 12 GHz bunch structure
- low energy (2.4 GeV - 240 MeV)
- high current (100A)

Main beam for physics

- high energy (9 GeV – 1.5 TeV)
- current 1.2 A

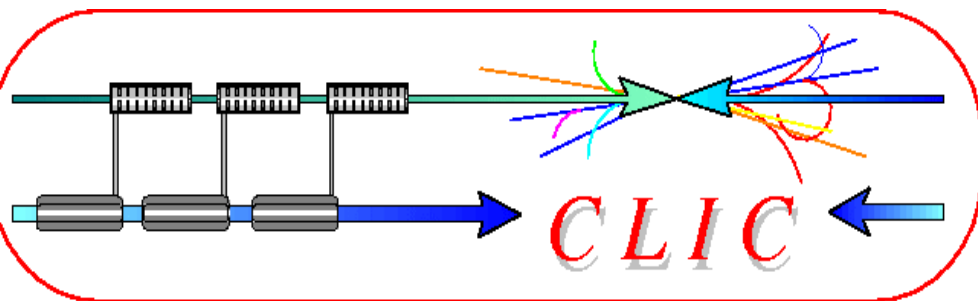
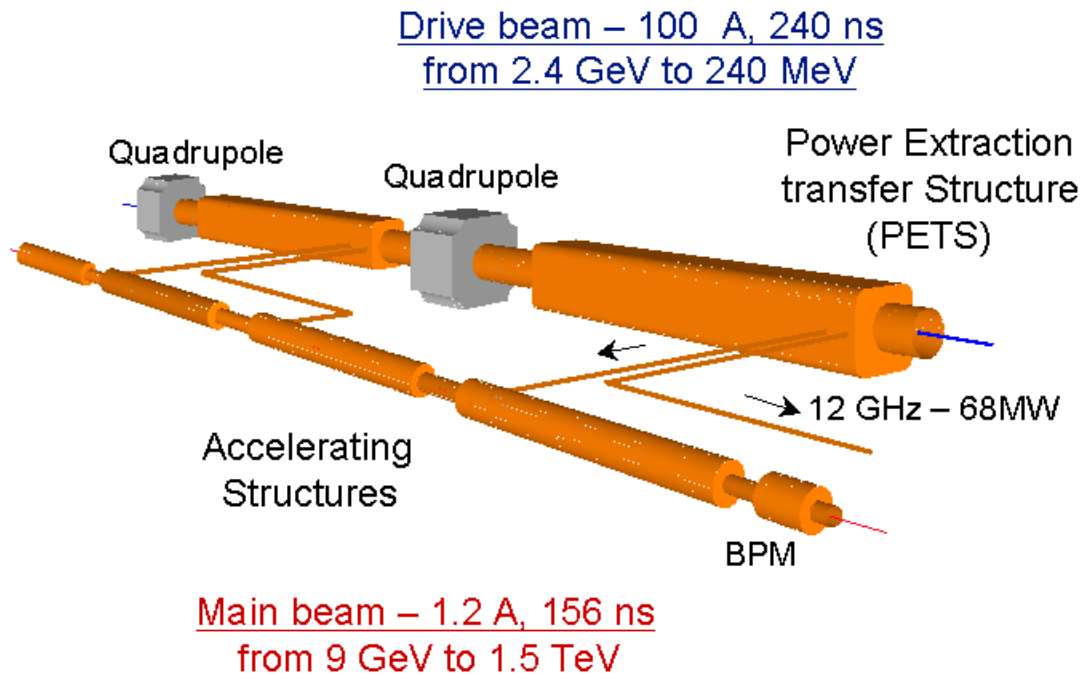

No individual RF power sources

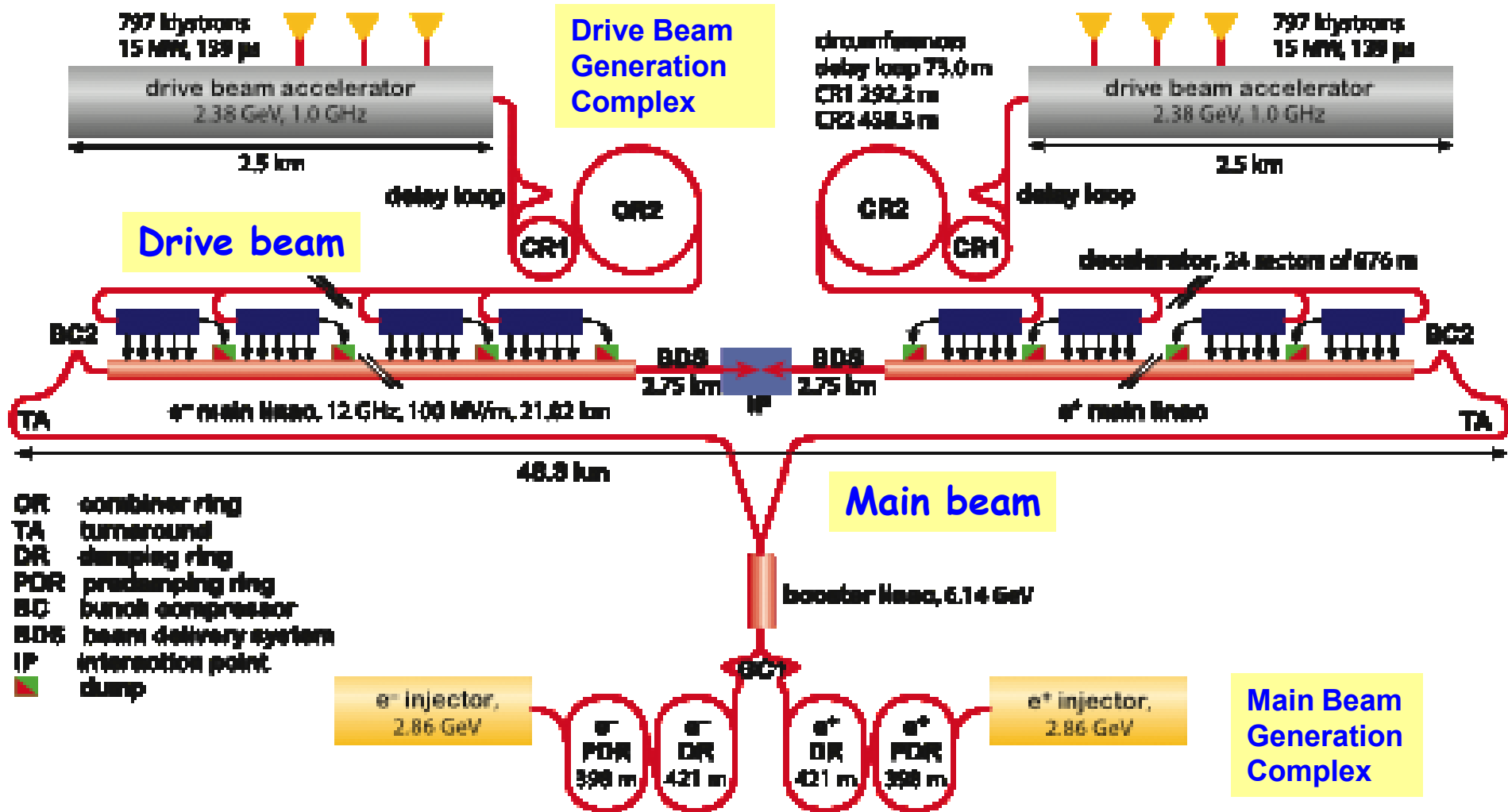

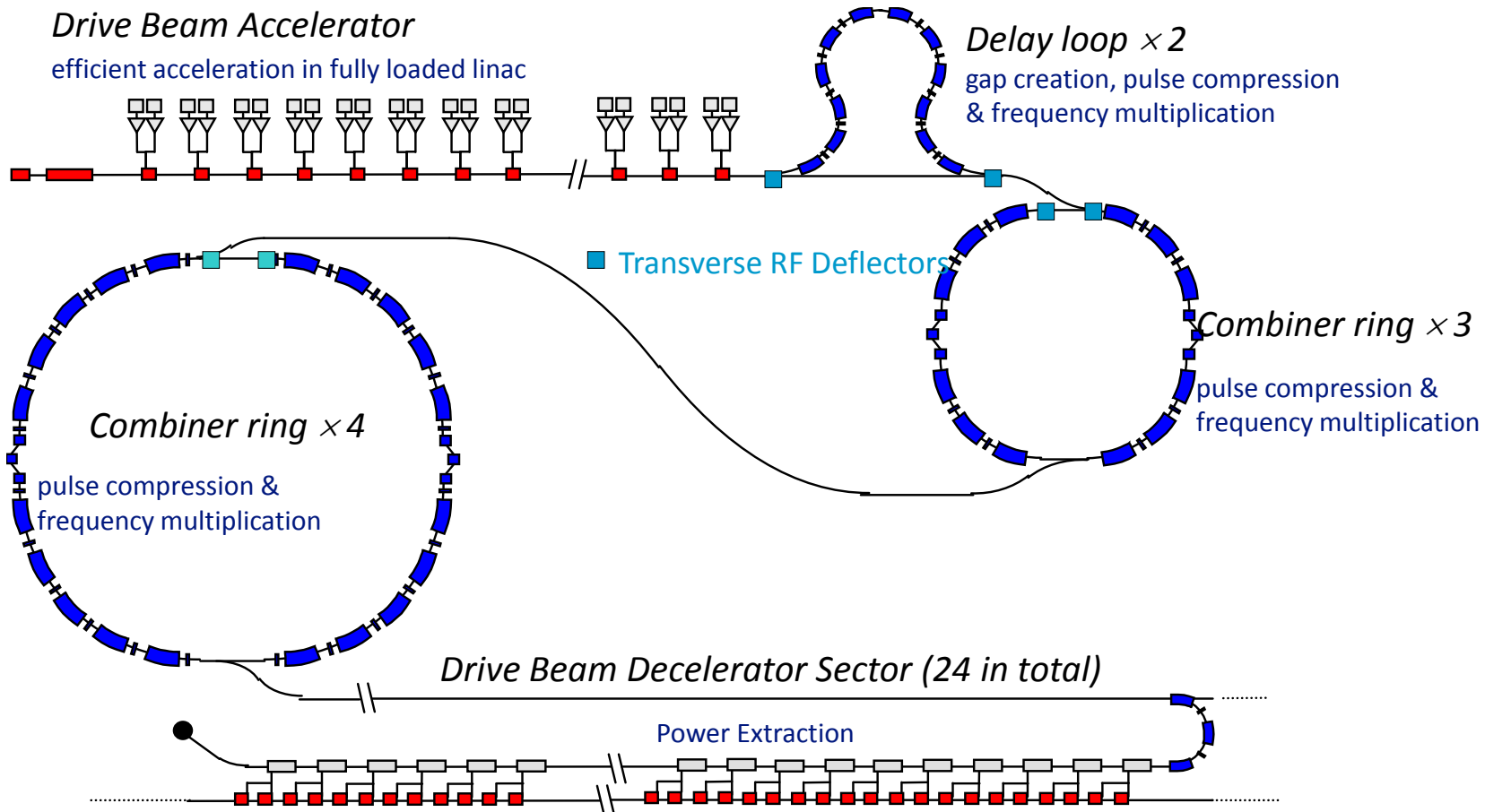

Drive beam time structure - initial

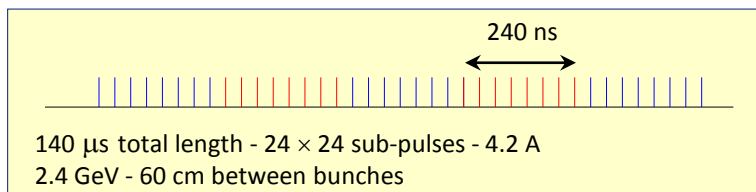

Drive beam time structure - final

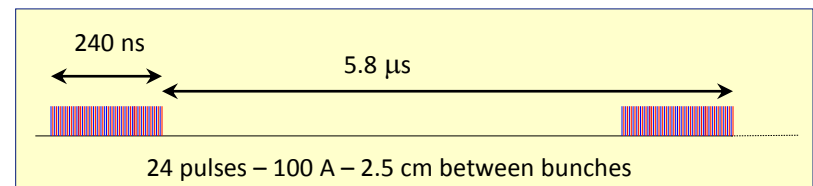

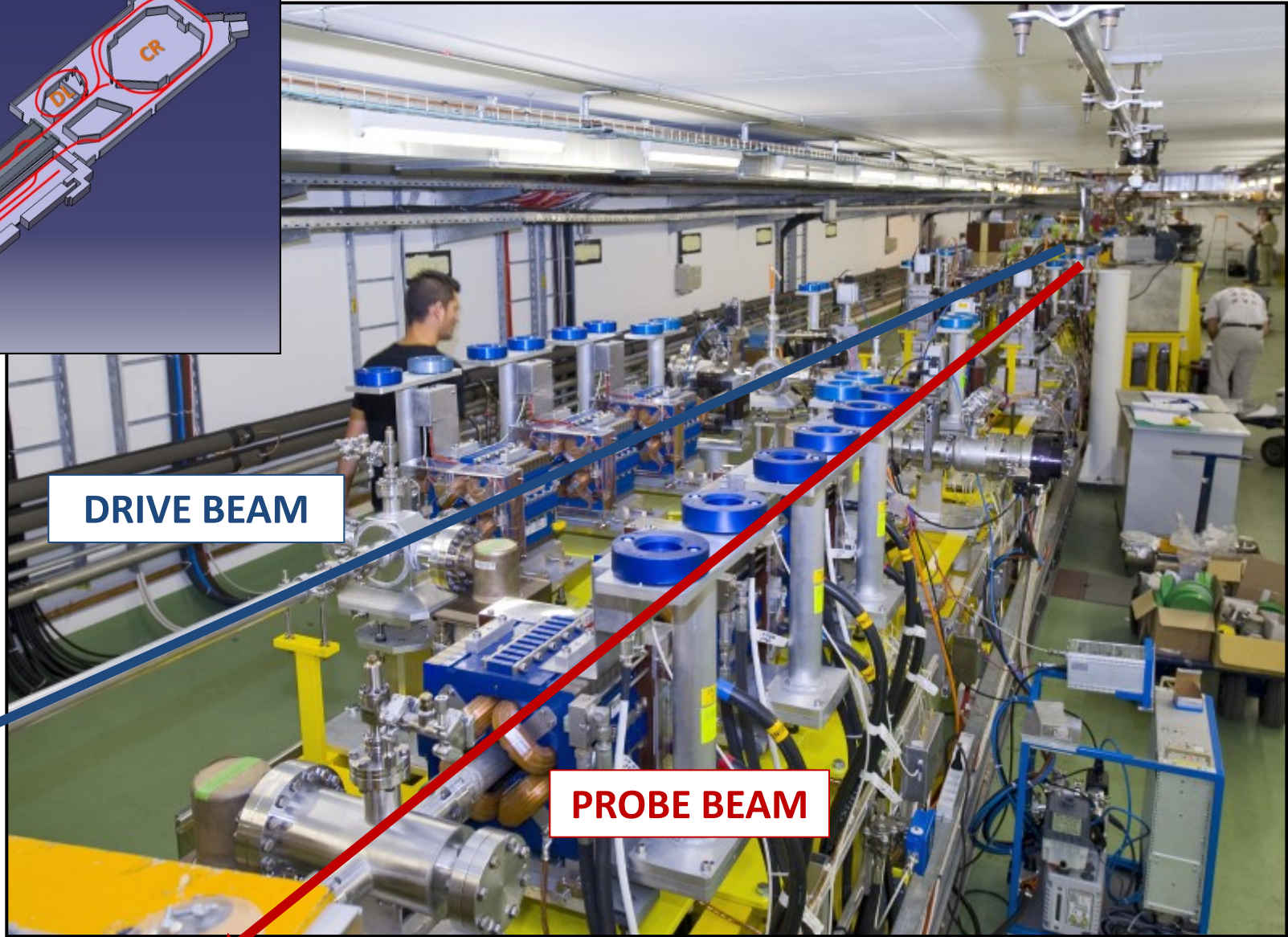
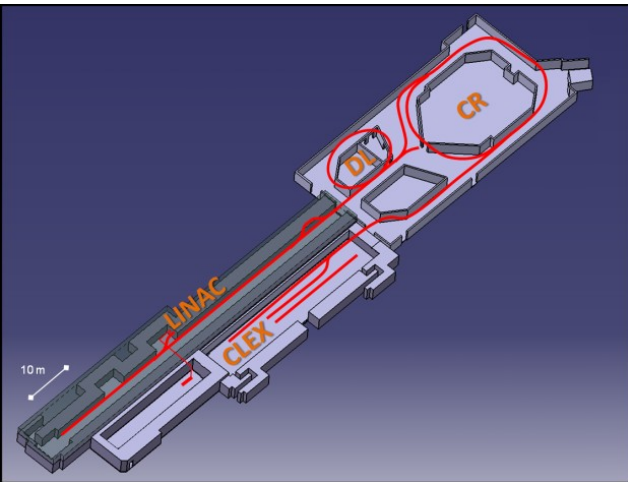

DRIVE BEAM

PROBE BEAM

Center-of-mass energy	ILC 500 GeV	CLIC 500 GeV	CLIC 3 TeV
Total (Peak 1%) luminosity [$\cdot 10^{34}$]	2(1.5)	2.3 (1.4)	5.9 (2.0)
Repetition rate (Hz)	5	50	
Loaded accel. gradient MV/m	32	80	100
Main linac RF frequency GHz	1.3	12	
Bunch charge [$\cdot 10^9$]	20	6.8	3.7
Bunch separation (ns)	370	0.5	
Beam pulse duration (ns)	950 μ s	177	156
Beam power/beam (MWatts)		4.9	14
Hor./vert. IP beam size (nm)	600 / 6	200 / 2.3	40 / 1.0
Hadronic events/crossing at IP	0.12	0.2	2.7
Incoherent pairs at IP	$1 \cdot 10^5$	$1.7 \cdot 10^5$	$3 \cdot 10^5$
BDS length (km)		1.87	2.75
Total site length km	31	13	48
Total power consumption MW	230	130	415

Train repetition rate 50 Hz

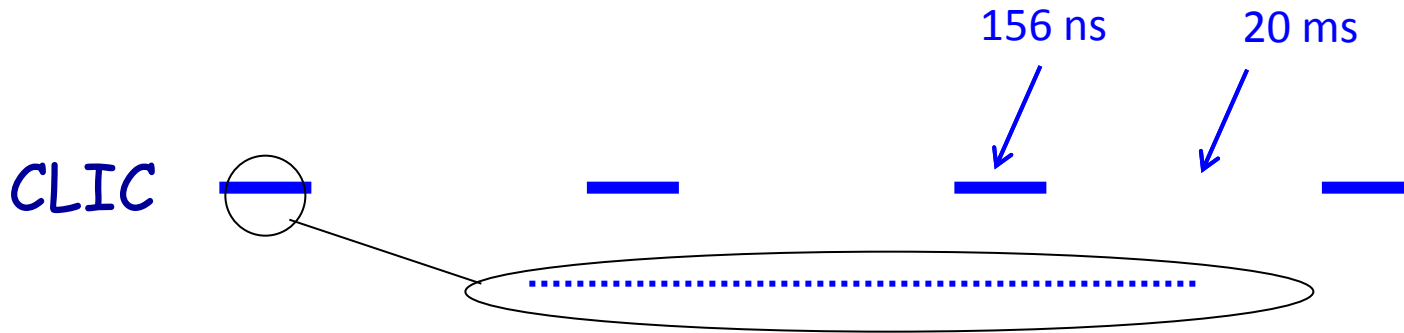

CLIC: 1 train = 312 bunches 0.5 ns apart 50 Hz

ILC: 1 train = 2820 bunches 308 ns apart 5 Hz

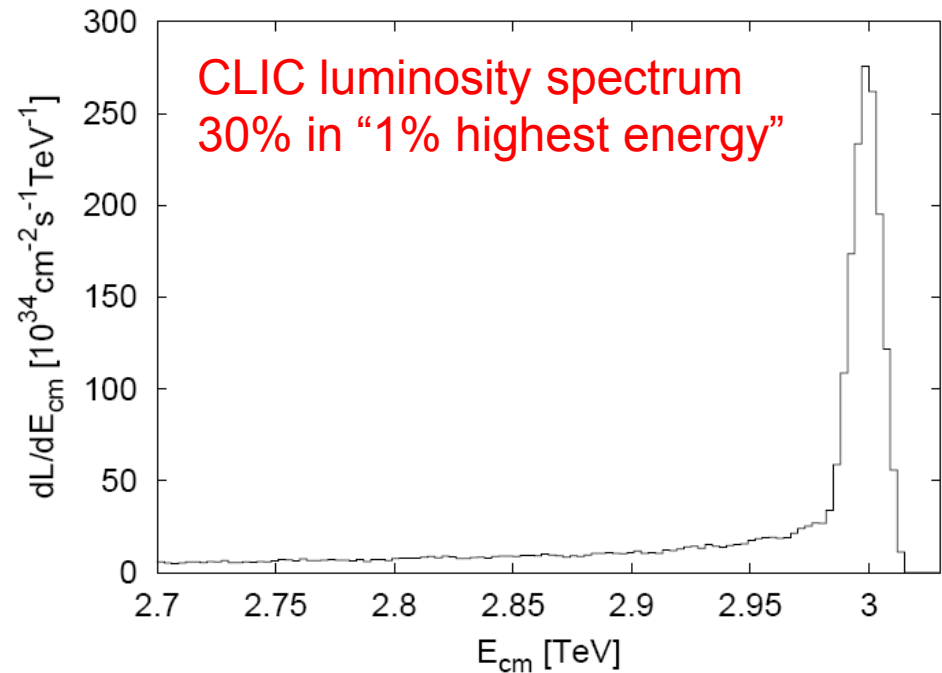
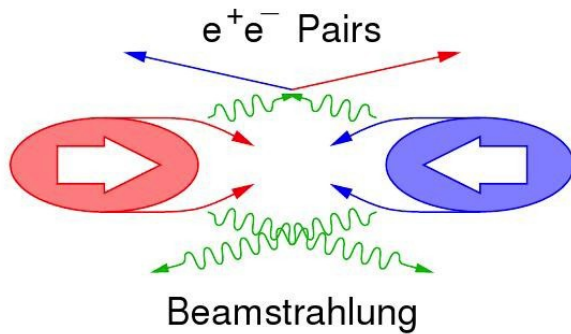

Main backgrounds:

- CLIC 3TeV beamstrahlung $\Delta E/E = 29\%$ ($10 \times ILC_{\text{value}}$)
 - **Coherent pairs** (3.8×10^8 per bunch crossing) \Leftarrow disappear in beam pipe
 - **Incoherent pairs** (3.0×10^5 per bunch crossing) \Leftarrow suppressed by strong solenoid-field
 - $\gamma\gamma$ interactions \Rightarrow hadrons (**3.3 hadron events per bunch crossing**)

- In addition: Muon background from upstream linac (~ 5 muons per bunch crossing) \Leftarrow spread over detector surface

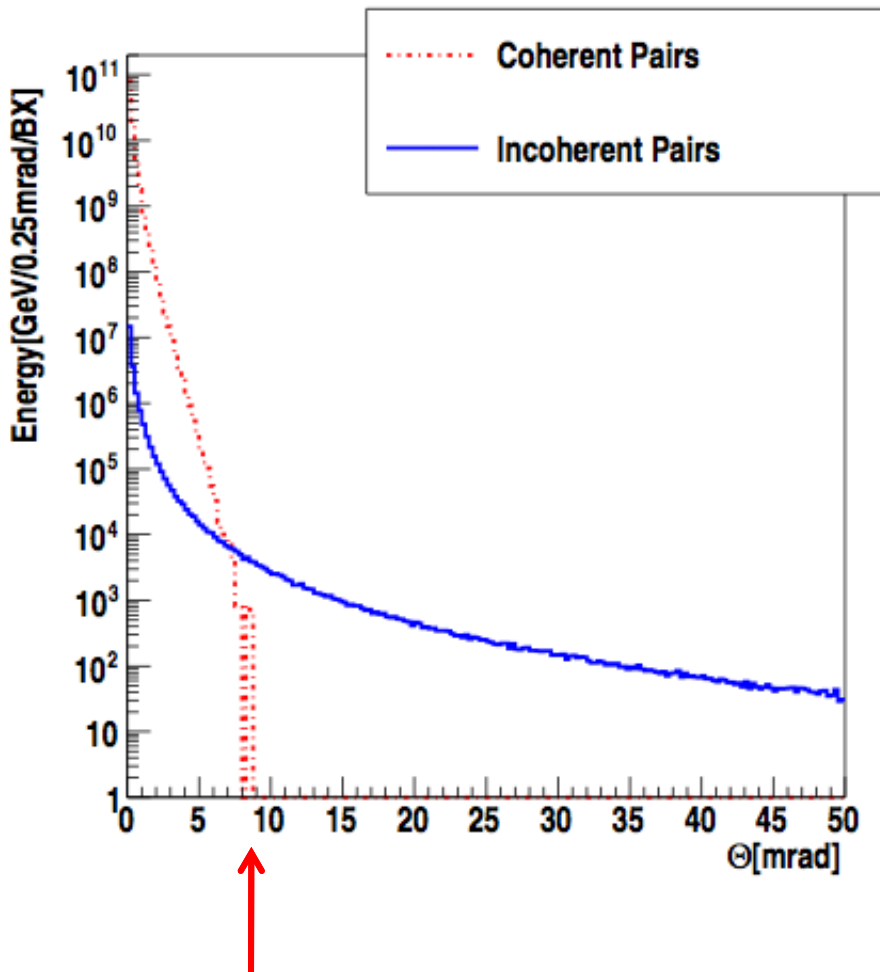

Coherent pairs:

Very numerous at very low angles
Very high total energy

Incoherent pairs:

Extend to larger angles
More difficult for the detector

Determines beam crossing angle (20 mrad)

Determines opening angle of beam pipe for outgoing beam (± 10 mrad)

CLIC beamstrahlung: $\gamma\gamma \rightarrow$ hadrons

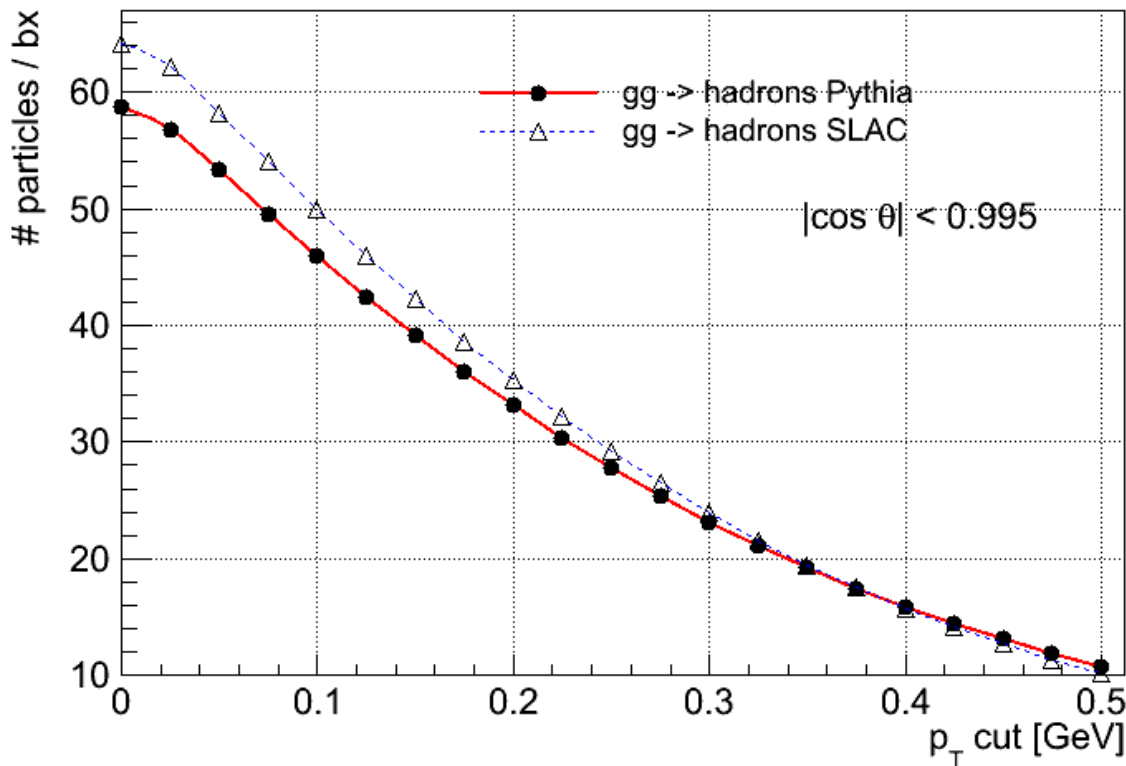

Per bunch crossing:

- 3.2 such events
- ~28 particles into the detector
- 50 GeV
- Forward-peaked

15 TeV dumped in the detector per 156 ns bunch train !

**we need
TIME STAMPING !
...and play with clever
event selections**

D. Dannheim, CERN

$O(10^9)$ readout cells

Yoke instrumentation
(glass RPC's or
scintillator
detectors)

Final Focus
quadrupole of
accelerator (0.3 nm
stability)

Solenoid coil
(superconducting,
4-5T, 7-6 m diam.)

PFA Calorimetry
(tungsten, steel,
silicon, scintillator, RPC)

6 m

Main tracker
(silicon strips 50 μm ,
TPC gas detector)

Pixel detector
(silicon pixels 20 μm)

ILD: International Large Detector

“Large” : tracker radius 1.8m

B-field : 3.5 T

Tracker : TPC + Silicon

Calorimetry : **high granularity particle flow**

ECAL + HCAL inside large solenoid

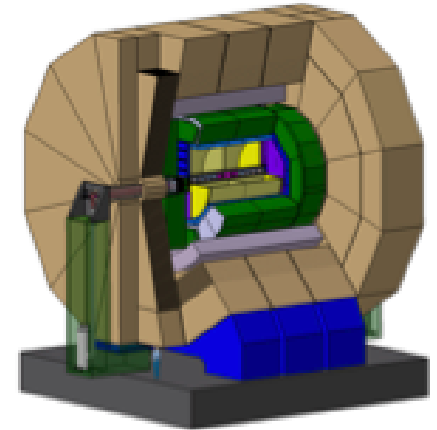

SiD: Silicon Detector

“Small” : tracker radius 1.2m

B-field : 5 T

Tracker : Silicon

Calorimetry : **high granularity particle flow**

ECAL + HCAL inside large solenoid

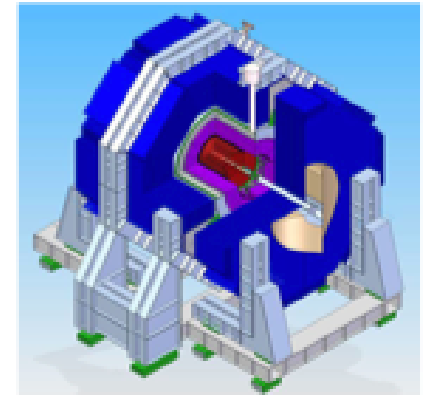

CLIC detector concepts will be based on SiD and ILD.
Modified to meet CLIC requirements

CLIC_SiD [5T]

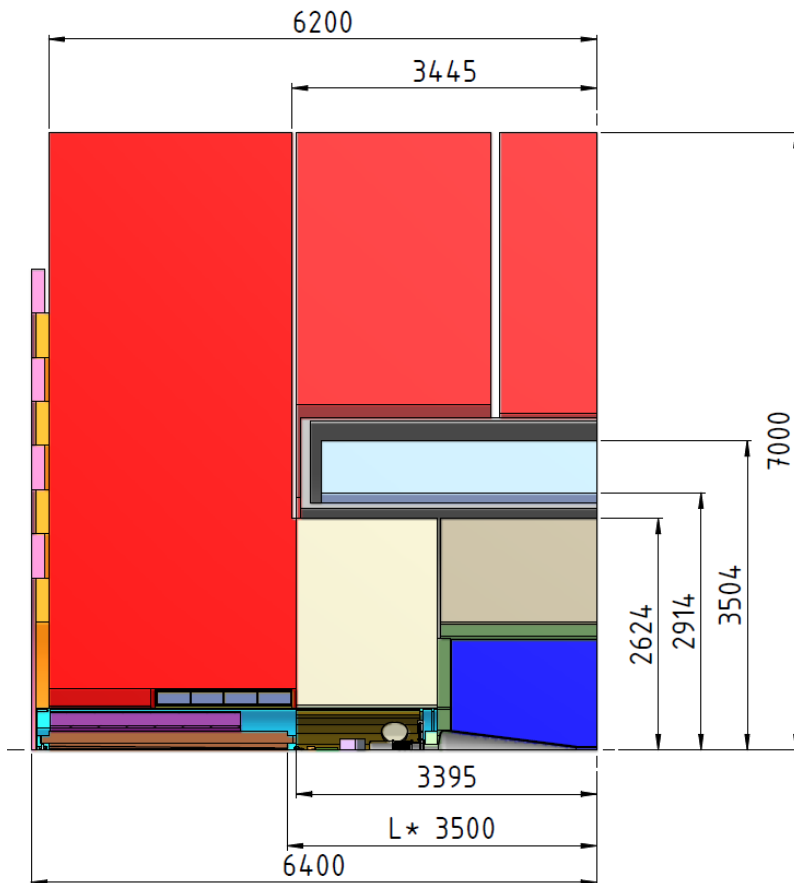

CLIC_ILD [4T]

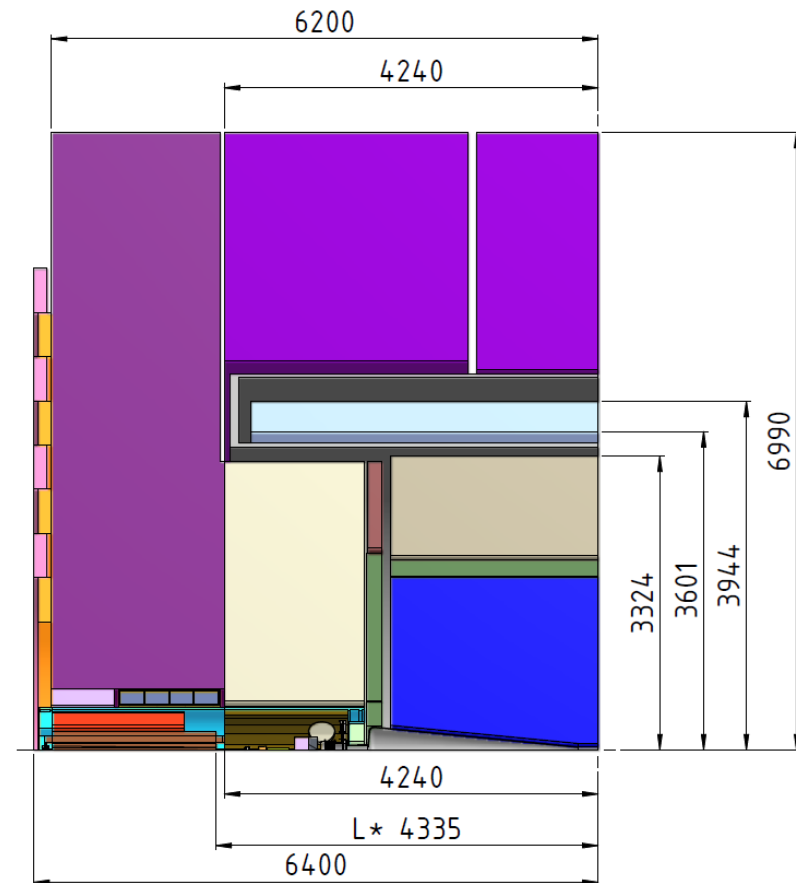

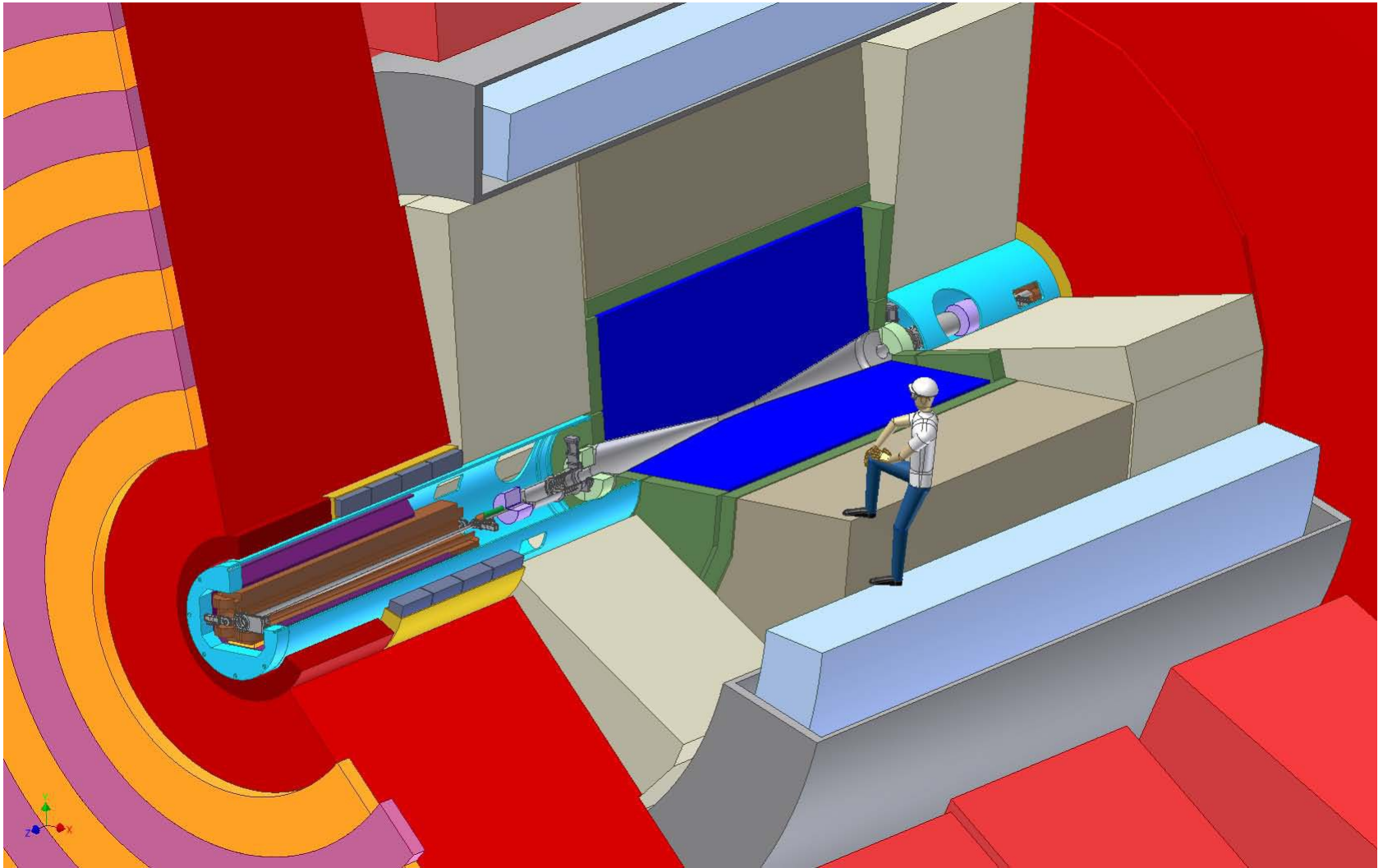

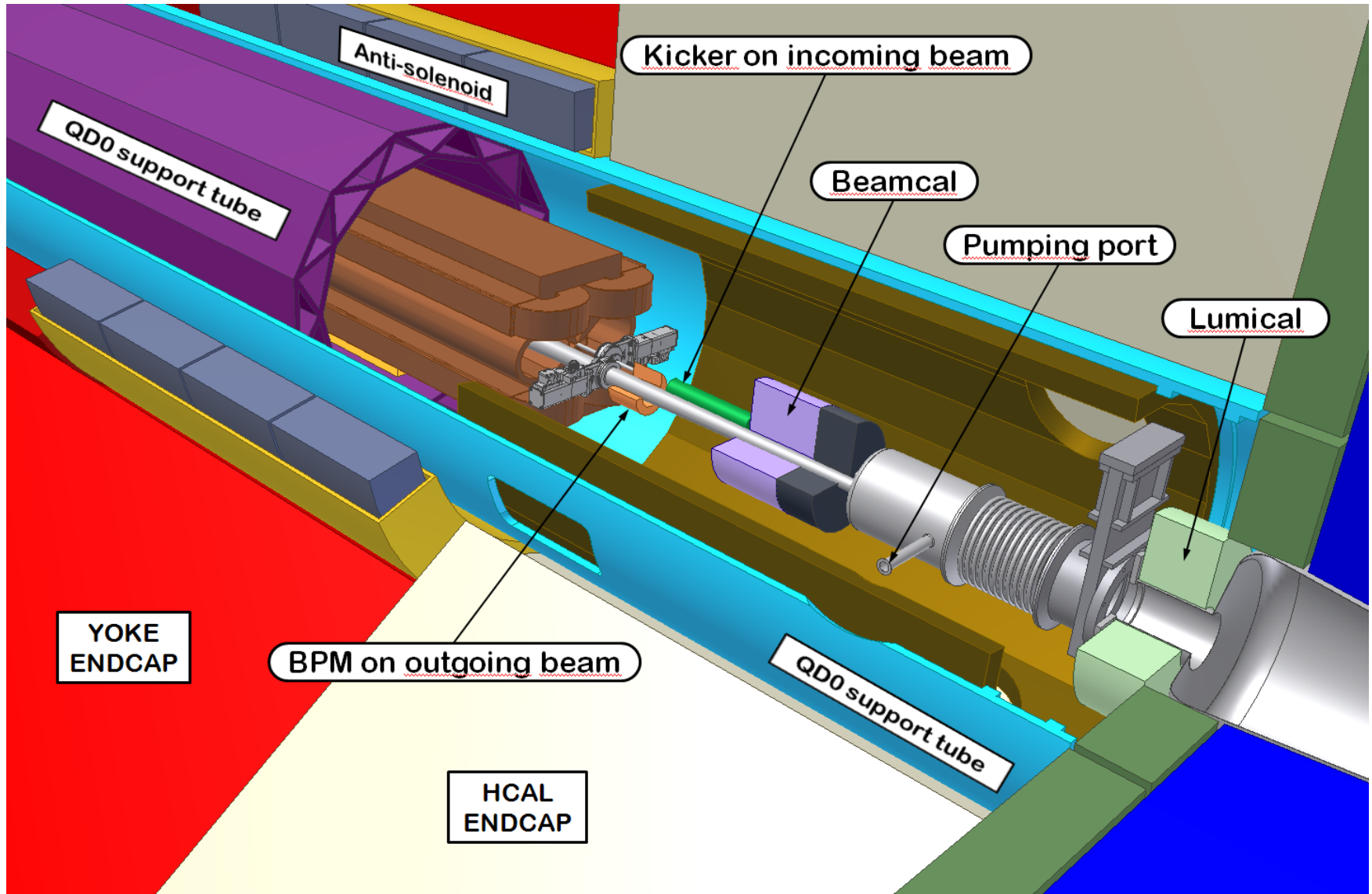

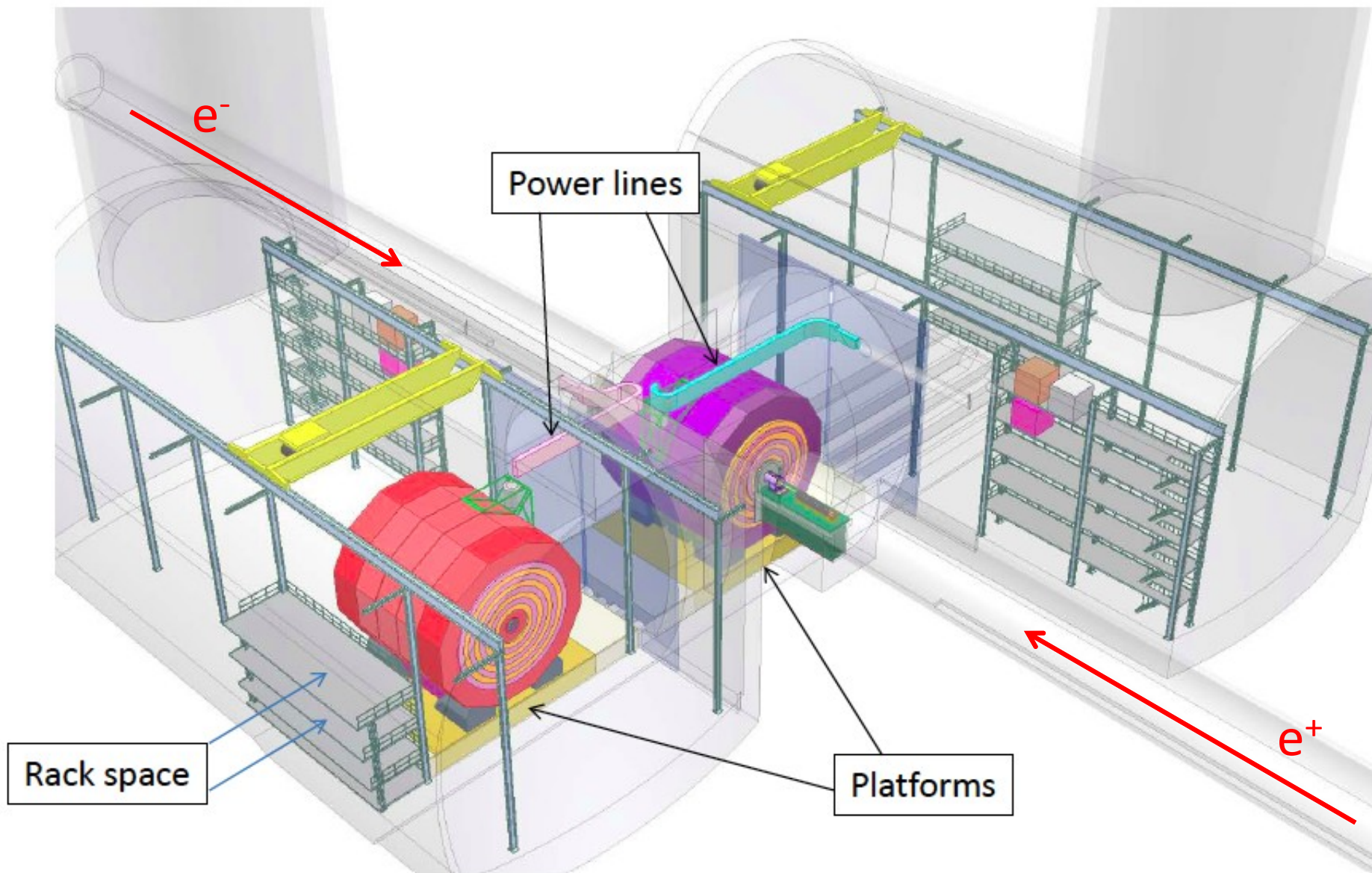

Physics

- Unambiguous identification of multi-jet decays of Z's, W's, top, H's, χ 's,

$$ZH H$$

- Higgs recoil mass and Susy decay endpoint measurements

$$ZH \rightarrow \ell^+ \ell^- X$$

- Full flavor identification and quark charge determination for heavy quarks

$$ZH, H \rightarrow c\bar{c}, b\bar{b}, \dots$$

- Full hermiticity to identify and measure missing energy and eliminate SM backgrounds to SUSY

$$\tilde{\mu} \text{ decay}$$

- The unexpected

Detector

- Demands unprecedented jet energy resolution

$$\sigma_{E_{jet}} / E_{jet} = 3\%$$

- Pushes tracker momentum resolution

$$\sigma(1/p_T) = 5 \times 10^{-5} (\text{GeV}^{-1})$$

- Demands superb impact parameter resolution

$$\sigma_{r\phi} \approx \sigma_{rz} \approx 5 \oplus 10 / (p \sin^{3/2} \vartheta)$$

- Instrumented forward region

$$\Omega = 4\pi$$

- Smarts Marcel Demarteau ANL

In a nutshell:

CLIC detector:

•High precision:

- Jet energy resolution
 - => fine-grained calorimetry
- Momentum resolution
- Impact parameter resolution

•Overlapping beam-induced background:

- High background rates, medium energies
- High occupancies
- Cannot use vertex separation in z
- Need precise time-stamping (5-10 ns)

•No issue of radiation damage (10^{-4} LHC)

•Beam crossings “sporadic”

•No trigger, read-out of full 156 ns train

LHC detector:

•Medium-high precision:

- Very precise ECAL (CMS)
- Very precise muon tracking (ATLAS)

•Overlapping minimum-bias events:

- High background rates, high energies
- High occupancies
- Can use vertex separation in z
- Need precise time-stamping (25 ns)

•Severe challenge of radiation damage

•Continuous beam crossings

•Trigger has to achieve huge data reduction

- Due to **beam-induced background** and **short time between bunches**:
 - High occupancy in the inner regions (incoherent pairs)
 - Jets scale and resolution are affected ($\gamma\gamma \Rightarrow$ hadrons)
 - Time-stamping is a must for almost all detectors
- **Narrow jets at high energy**
 - Calorimeter has to measure high-energy particles (leakage)
 - Separation of tracks in dense jets

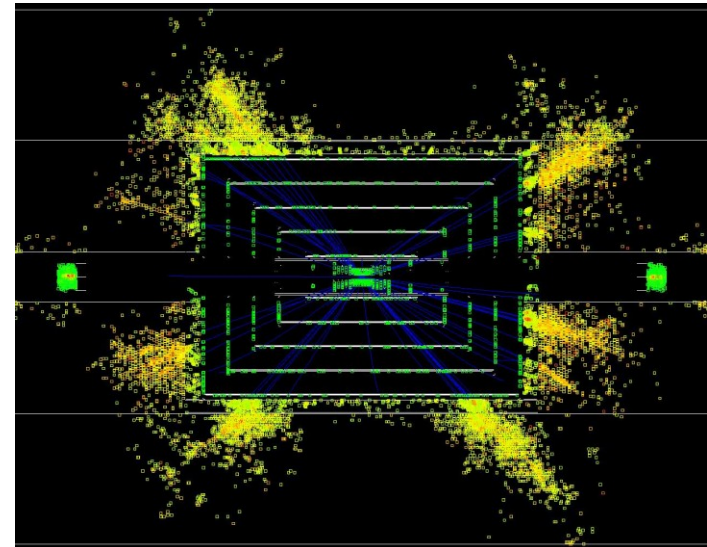
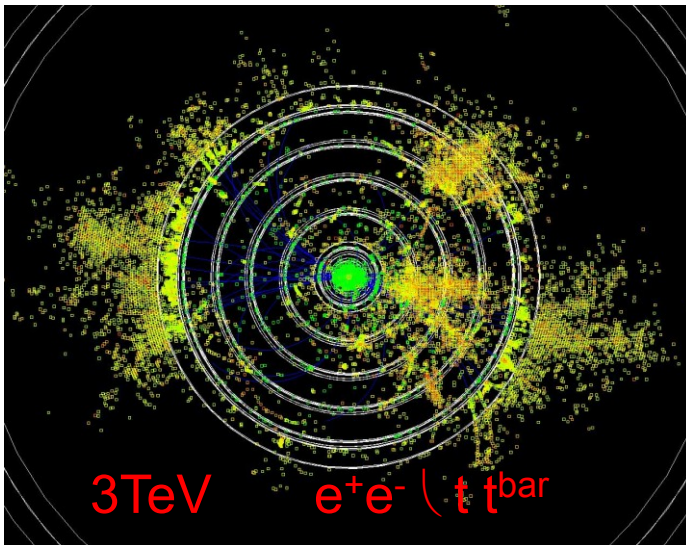

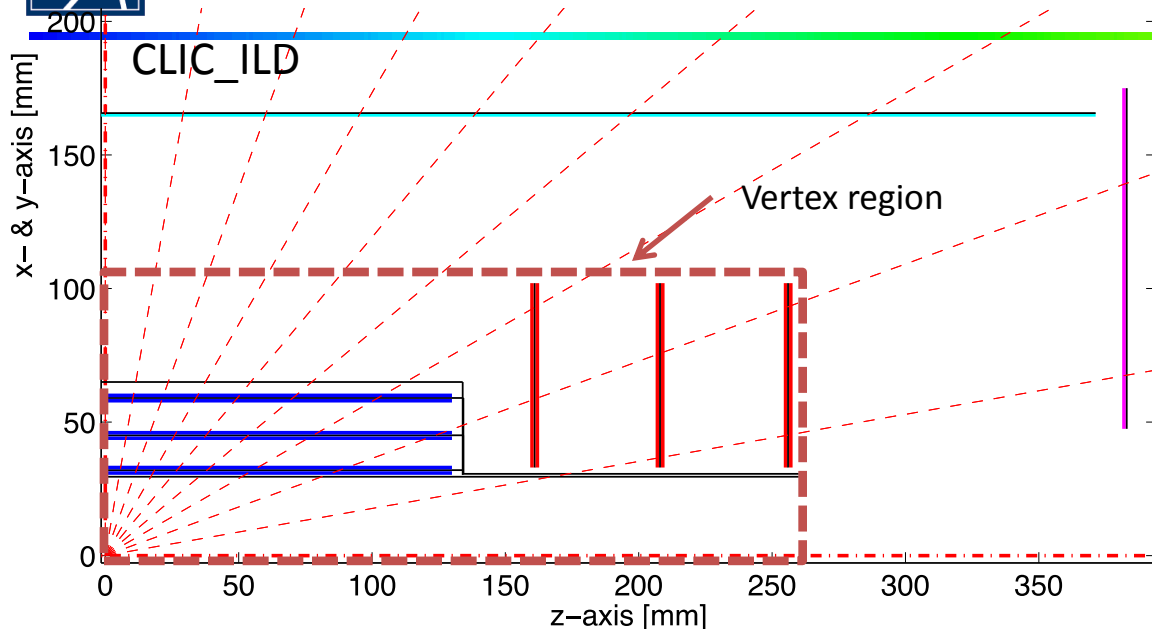

CLIC_ILD

3 double layers of pixel cylinders
3 double layers of pixel disks
20 μm pixels, analog readout, $\sigma_{\text{sp}}=2.8 \mu\text{m}$
 $X=0.18\% X_0$ / double layer
0.74m² surface, 1.84G Pixel

CLIC_SiD

5 single layers of barrel pixel cylinders
7 single layers of forward pixel disks
20 μm pixels, binary (analog) r/o,
 $\sigma_{\text{sp}}=3-4 \mu\text{m}$
 $X=0.12\% X_0$ / single layer
1.1m² surface, 2.77G Pixel

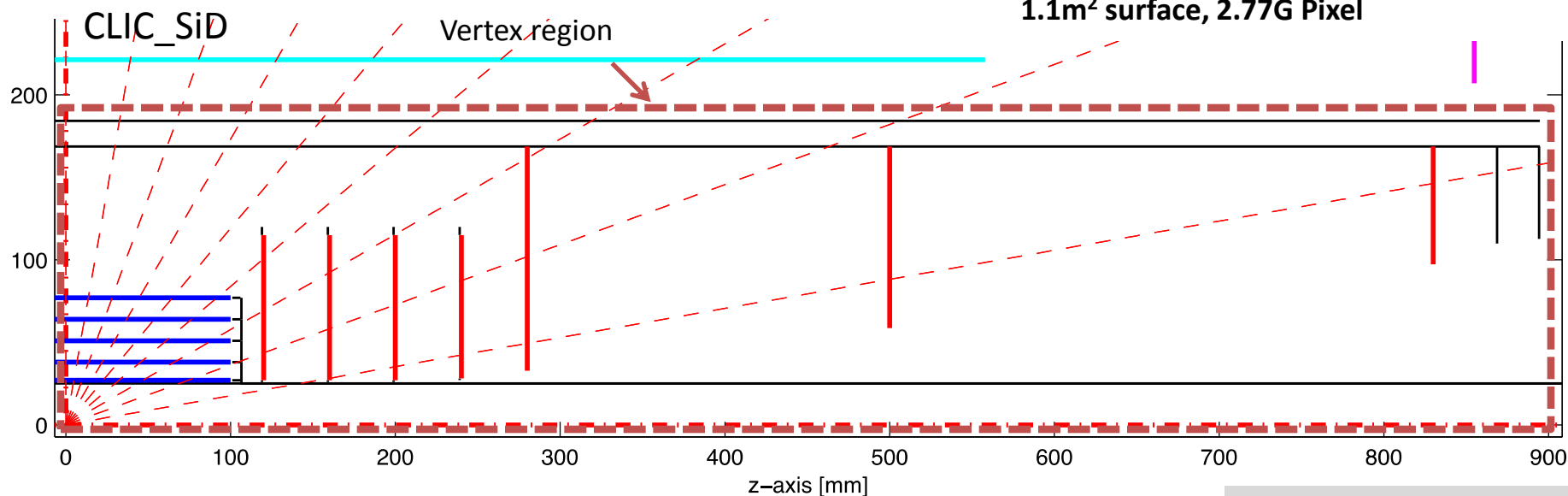

Requirements for the vertex detector:

- Single-layer **position resolution** 3-4 μm
 - Typically achieved with 20*20 micron pixels
- Single-layer **material thickness** 0.1% X_0 – 0.2% X_0
 - Equivalent to 50 μm thick sensor + 50 μm thick readout chip + thin support + connect
 - Requires very low power dissipation => no liquid cooling (“air flow”)
 - **Requires power pulsing (factor ~50 in heat dissipation)**
- **Time-stamping** ~5-10 ns
 - Still needs more study with full simulation
- **Occupancy**
 - ~1.5% per 20*20 μm^2 pixel per bunch train (156 ns) in the innermost layer
- **Triggerless readout over the 156 ns bunch-train**
 - With full data readout in less than 200-400 μsec to allow power-pulsing

Very challenging hardware project !

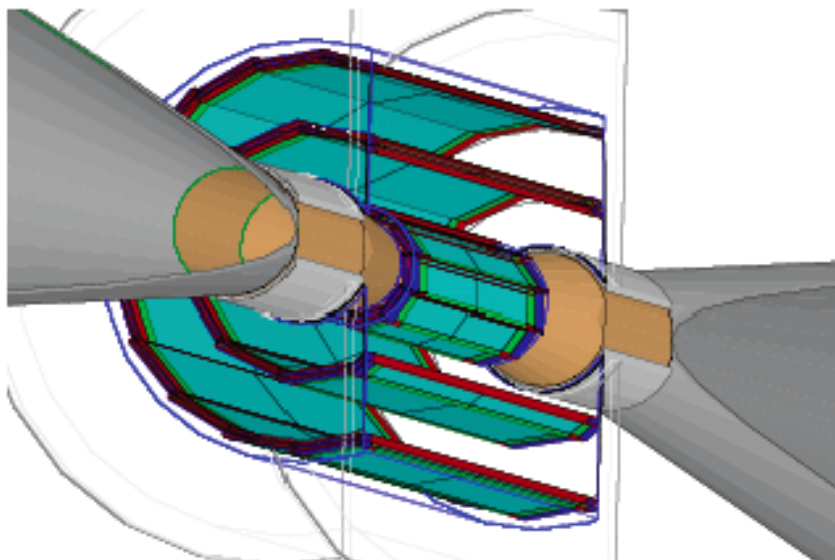

3D view of ILD vertex detector and beam pipe

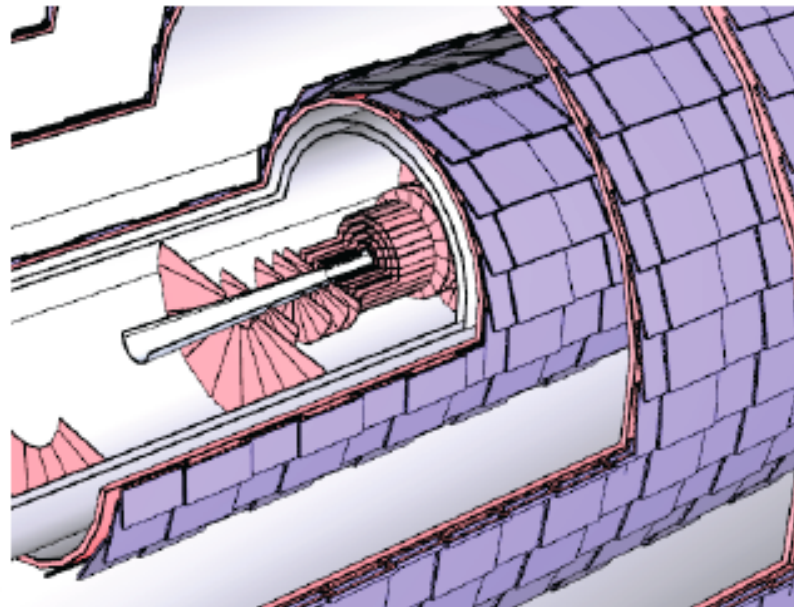

SiD vertex detector and silicon tracking

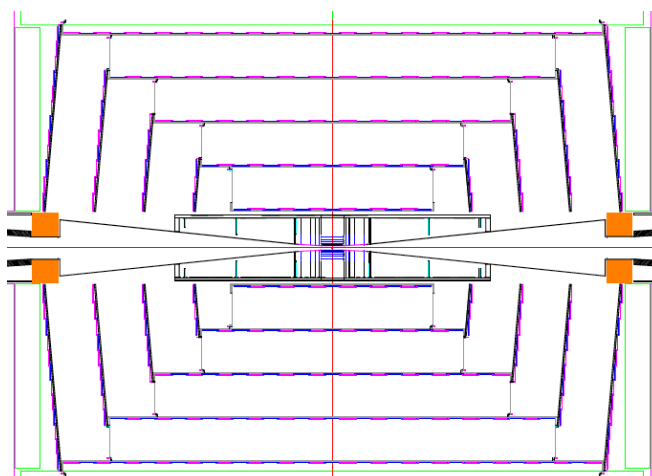

R&D on hybrid-less silicon strip detectors (SiD)

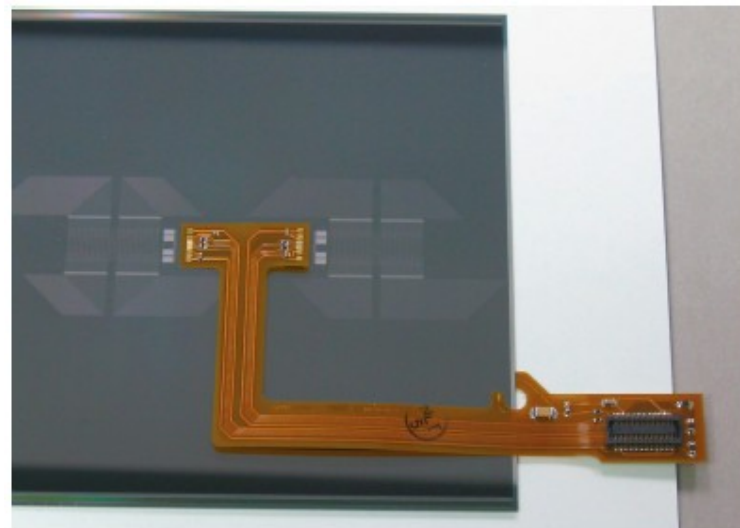

- **MicroMegas**

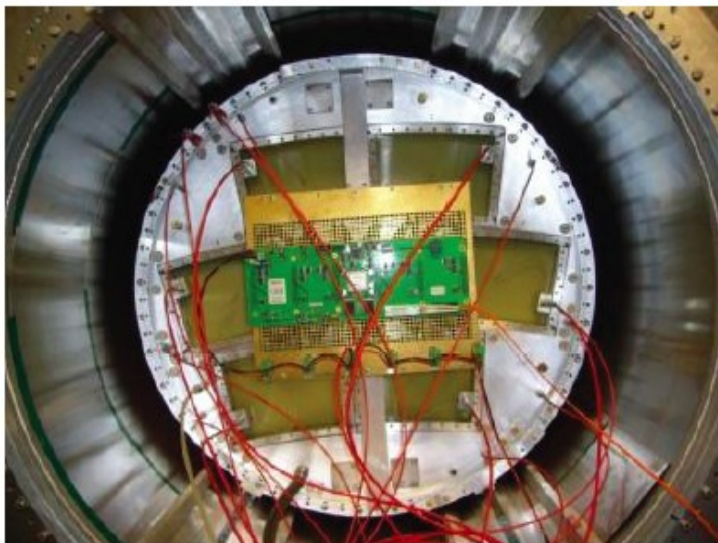
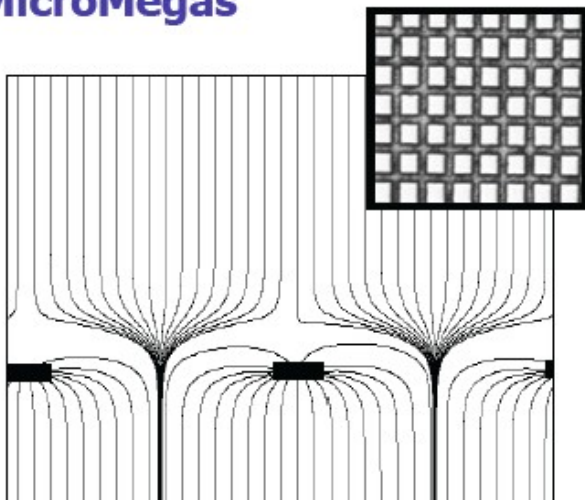

- **GEM**

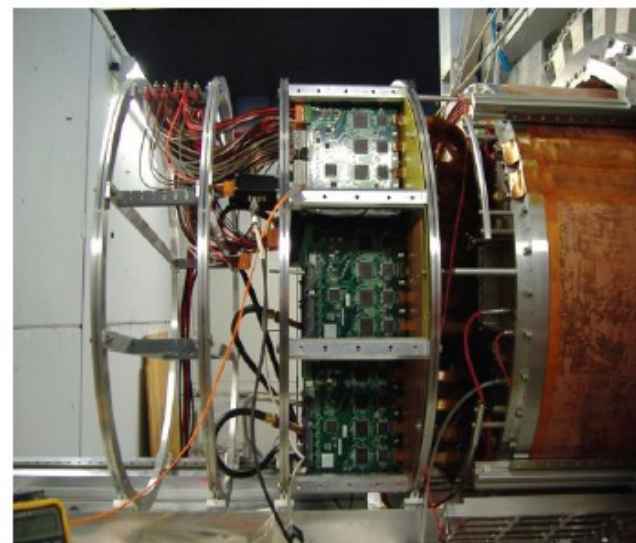
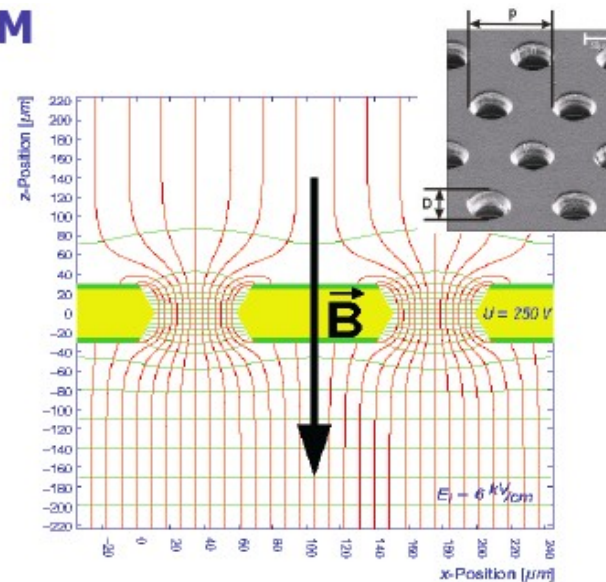

Motivation:

- To limit longitudinal leakage CLIC HCAL needs $\sim 7\Lambda_i$
- A deep HCAL pushes the coil/yoke to larger radius (would give a significant increase in cost and risk for the coil/yoke)
- A tungsten HCAL (CLIC option) is more compact than Fe-based HCAL, (ILC option) while Geant4 performance is similar
- Increased cost of tungsten barrel HCAL compensates gain in coil cost

Prototype tungsten HCAL: check simulation in test beam

- Prototype tests performed within CALICE collab.
- Use 30-40 layers of Tungsten, 1 cm thick, 80 cm \emptyset
- Use different active materials
- Start in Nov 2010 at CERN PS, with 30 W plates, and scintillator planes; continue in 2011 at SPS with 38 planes.
- +T3B tests for precise time measurement of shower development

Stack of 30-39 tungsten plates
10 mm thick
80 cm diameter

Main purpose:
Validation of Geant4 simulation for
hadronic showers in tungsten

Scintillator tiles
3*3 cm (in the centre)
Read out by SiPM (and wave-length
shifting fibre)

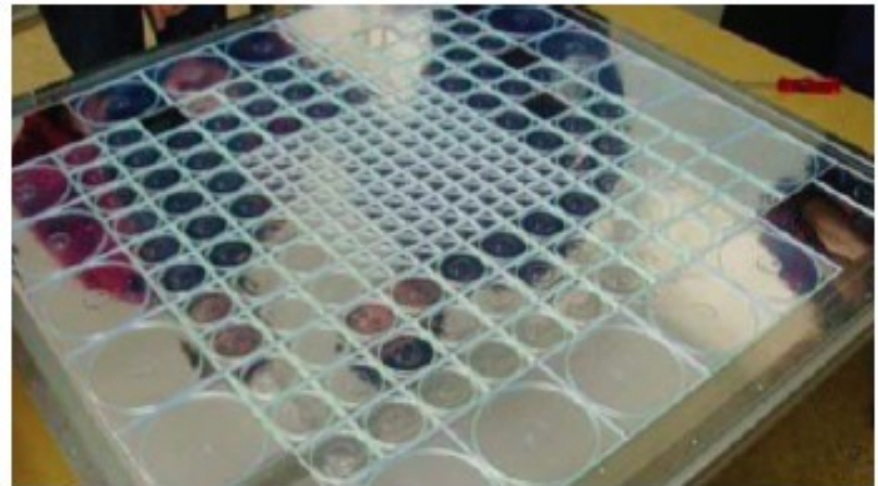

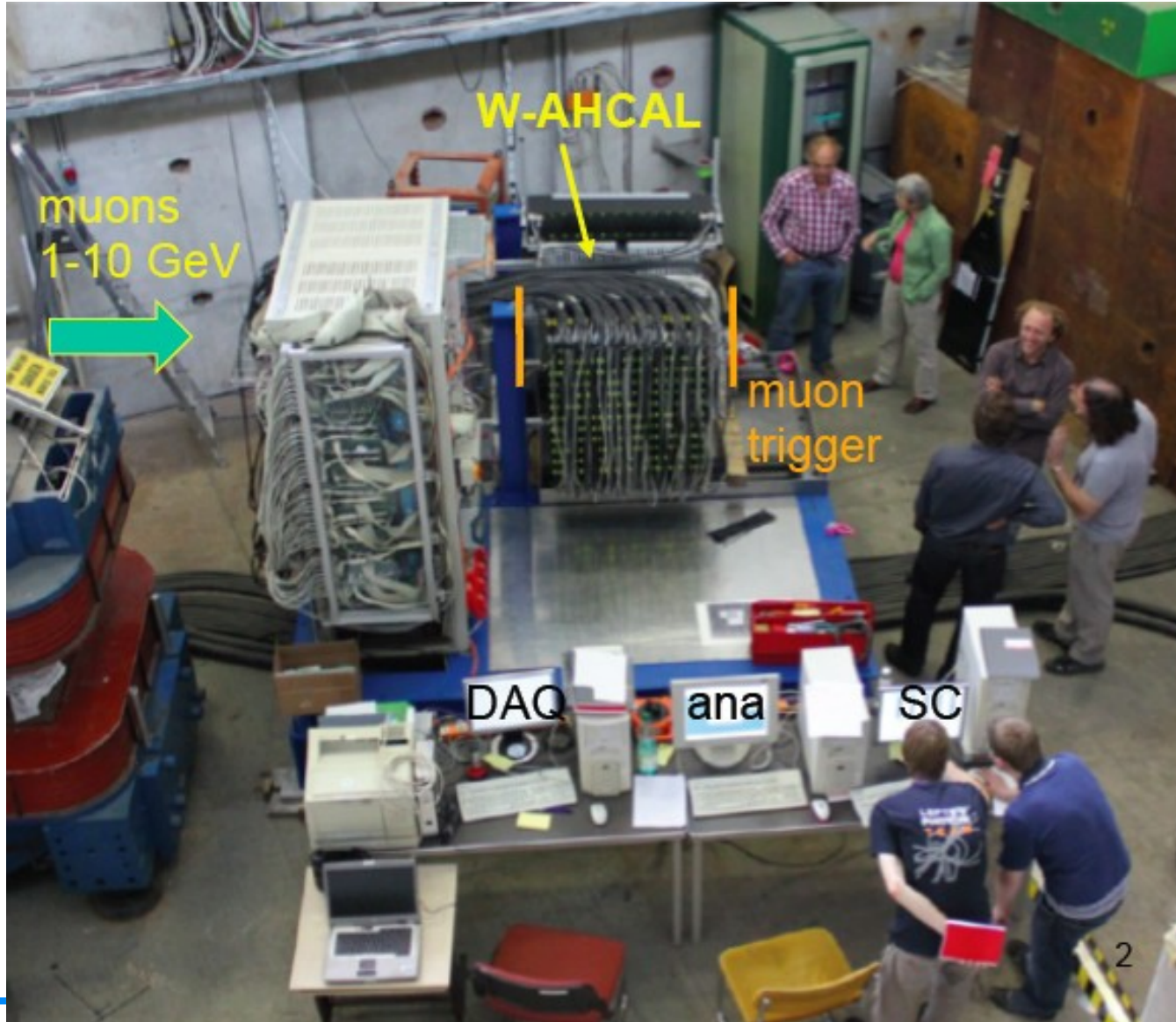

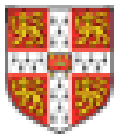

PandoraNewPFAs

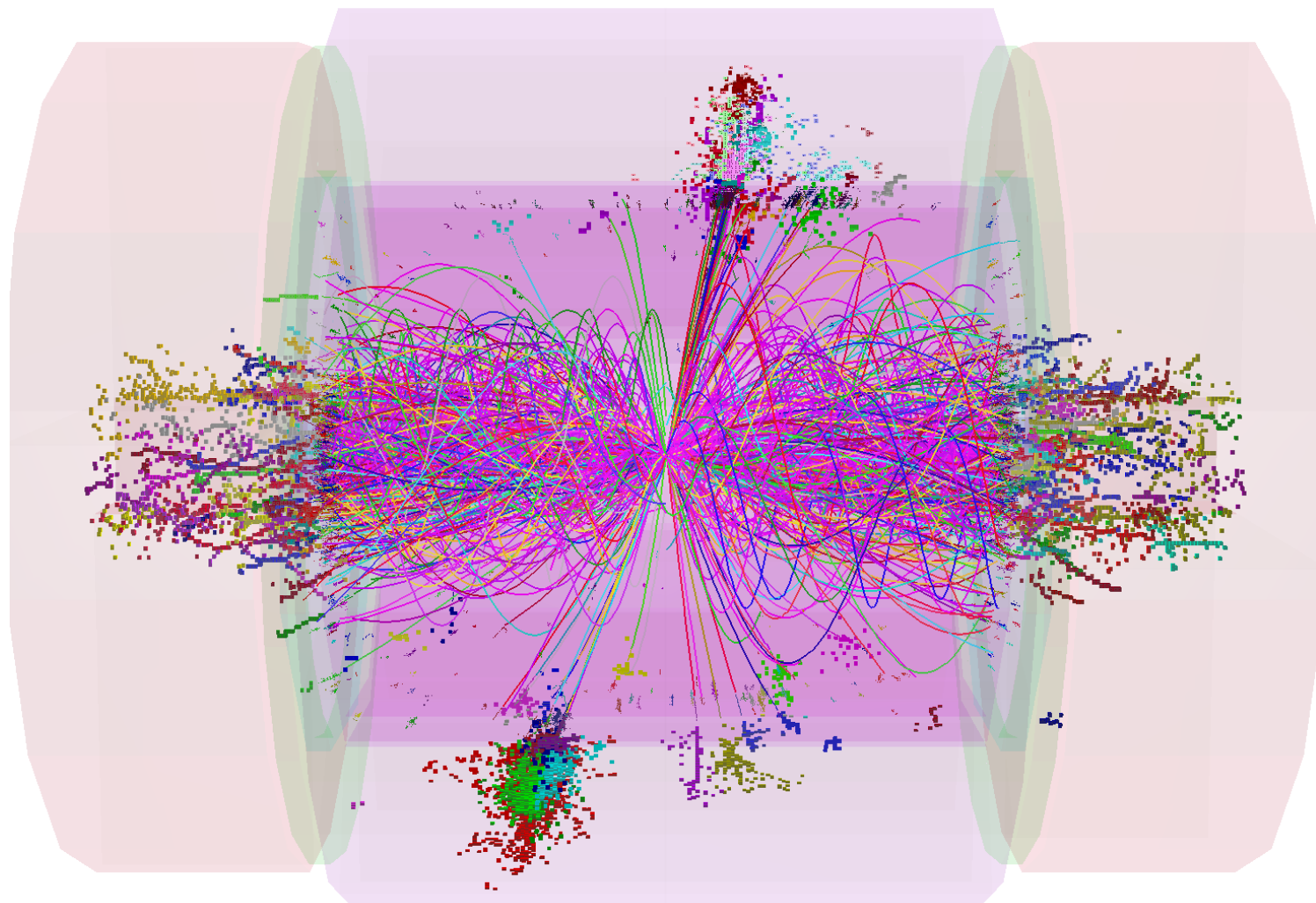

1 TeV $Z \Rightarrow q\bar{q}$

1.4 TeV of background !

with 60 BX background



LooseSelectedPandoraNewPFAs

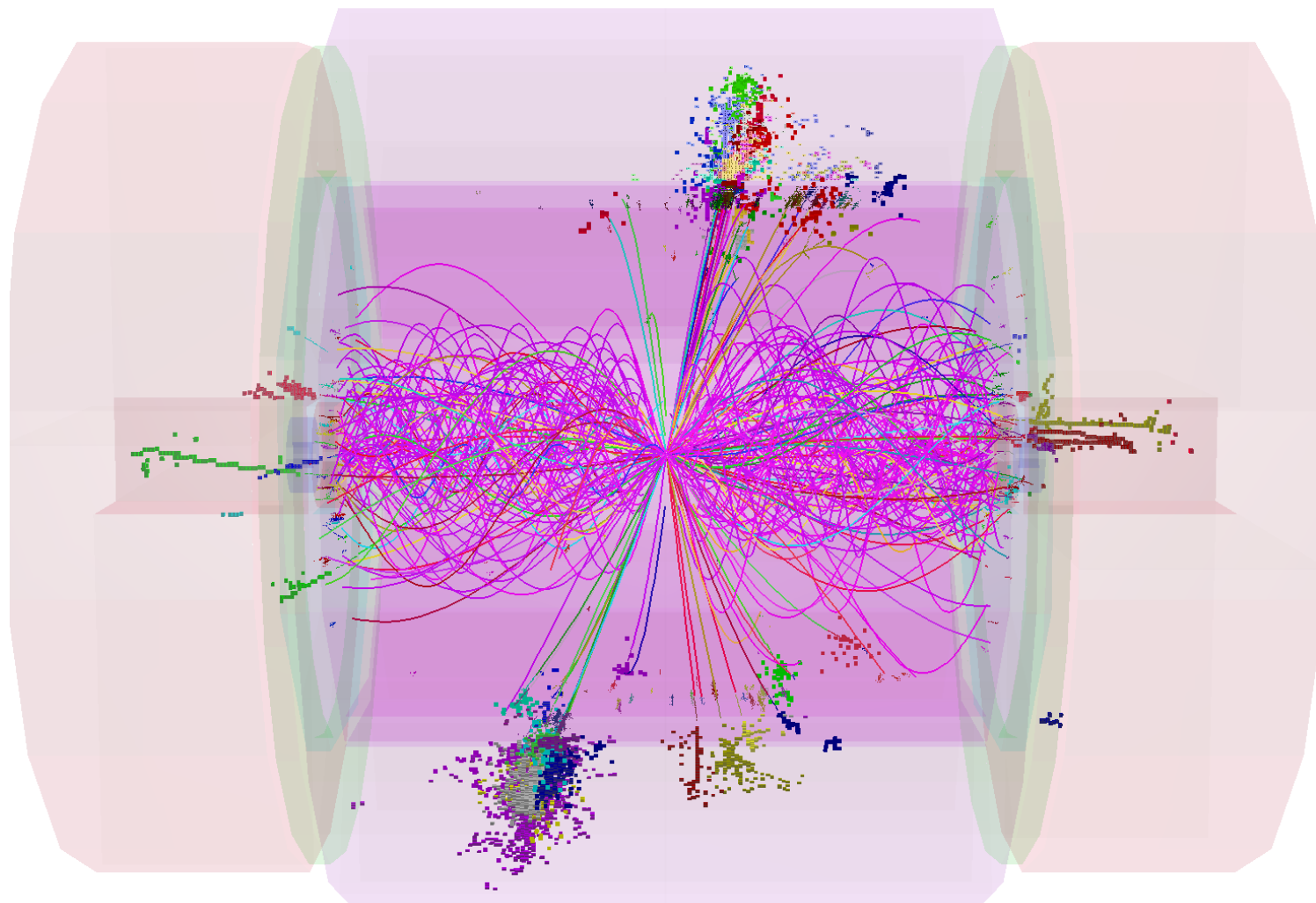

0.3 TeV of background



Selected PandoraNewPFAs

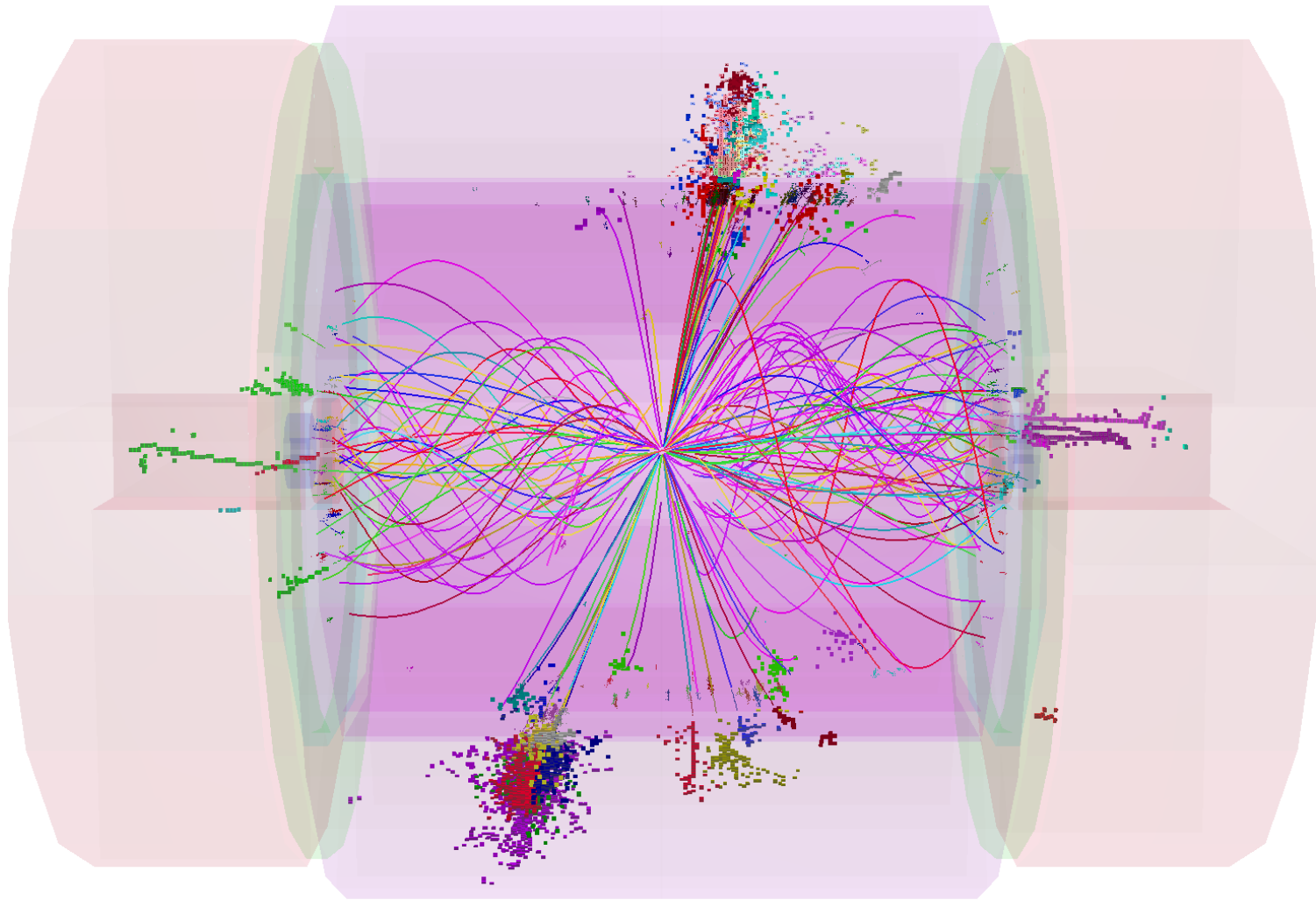

0.2 TeV of background

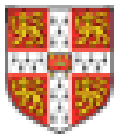

TightSelectedPandoraNewPFAs

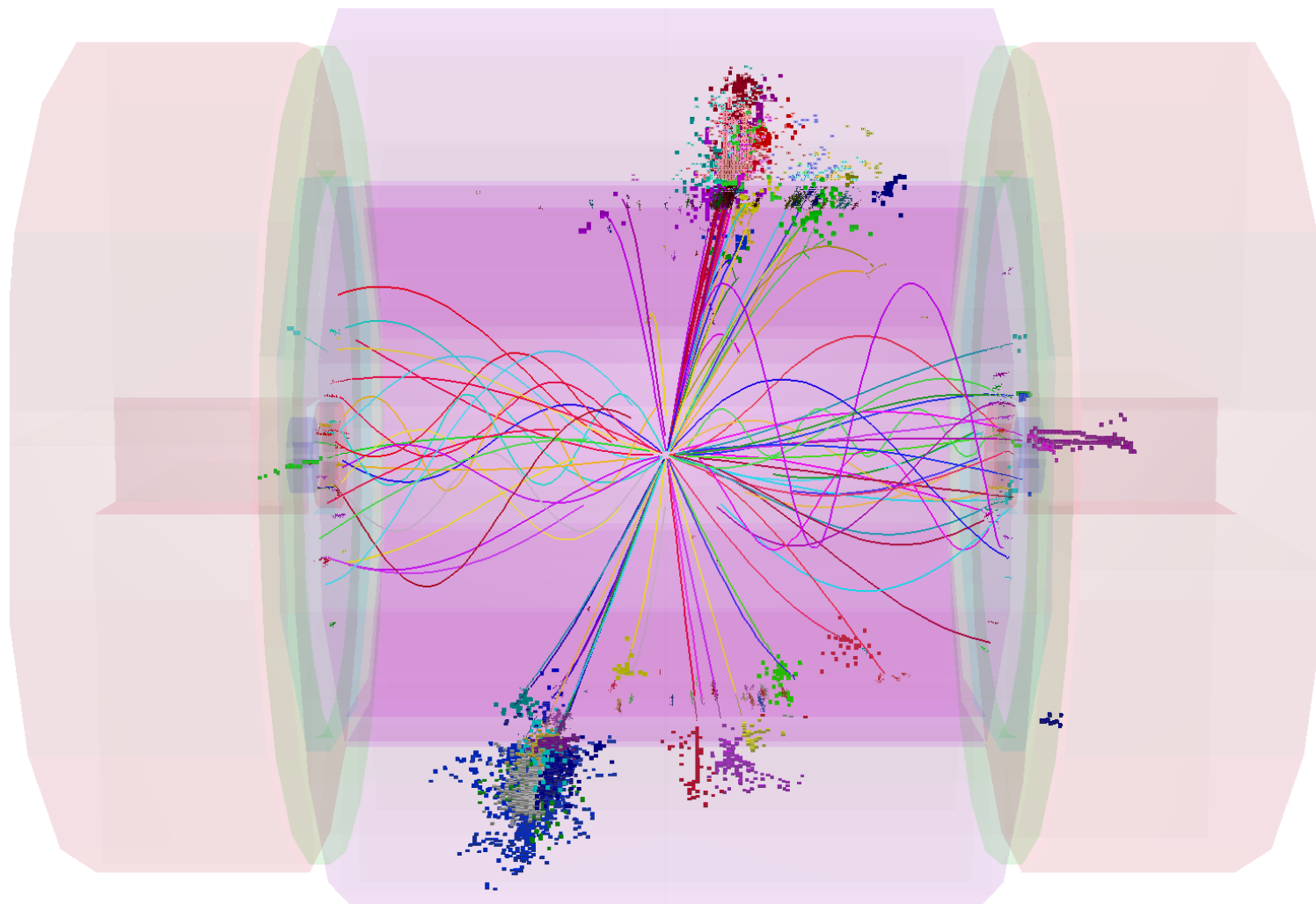

0.1 TeV of background

Mark Thomson, Cambridge

Current activities concentrate on preparation for CDR

- Mostly simulation studies:
 - Demonstrate that CLIC physics potential can be extracted from detector
 - Propose ILD-type and SiD-type detectors that can do the job
 - Perform physics benchmark studies
- Concentrate on critical issues
 - Determine required sub-detector performances to see the physics
 - Redesign of the very forward region
 - Take engineering aspects, cost etc into account
- Targeted hardware R&D (on critical elements)

Conceptual Design Report due for August 2011 (for 3 TeV), and end-2011 (including strategies for intermediate energies)

CERN LCD hardware/engineering R&D (needed for CLIC beyond existing ILC developments):

- Vertex detector
 - trade-off between pixel size, amount of material and timing resolution
- Hadron calorimetry
 - Tungsten-based HCAL (PFA calo, within CALICE)
- Power pulsing
 - In view of the 50 Hz CLIC time structure => allows for low-mass detectors
- Solenoid coil
 - Large high-field solenoid concept, reinforced conductor (CMS/ATLAS experience)
- Overall engineering design and integration studies
 - In view of sub-nm precision required for FF quadrupoles
 - For heavier calorimeter, larger overall CLIC detector size etc.
- In addition at CERN: TPC electronics development (Timepix-2, S-ALTRO)

- *Why do we care about power delivery and power pulsing?*
- **Power delivery:**
 - Reduce the total current to be brought into the detectors
 - For exactly the same reasons as LHC => synergy with sLHC work
 - Reduced space for services, reduced mass of cables and cooling
- **Power pulsing** => potential large impact on power requirements and cooling requirements:
 - Main reason is different for tracking and calorimetry
 - Calorimetry:
 - Important to have very compact showers => important to make active layer very thin in space. This is achievable if no space for cooling pipes is needed
 - Vertex detector and tracking detectors
 - High precision requirements at LC call for ultra-thin vertex/tracking detectors
 - If air-cooling can be used, the required low material budgets come within reach

Thank you!

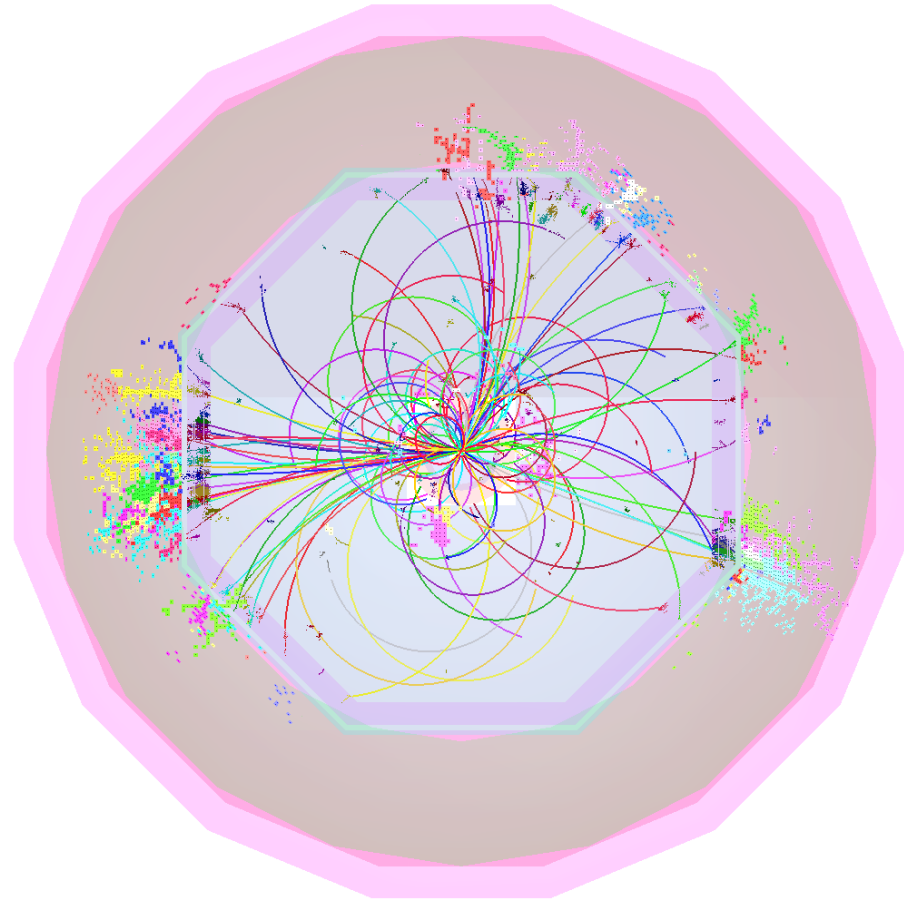
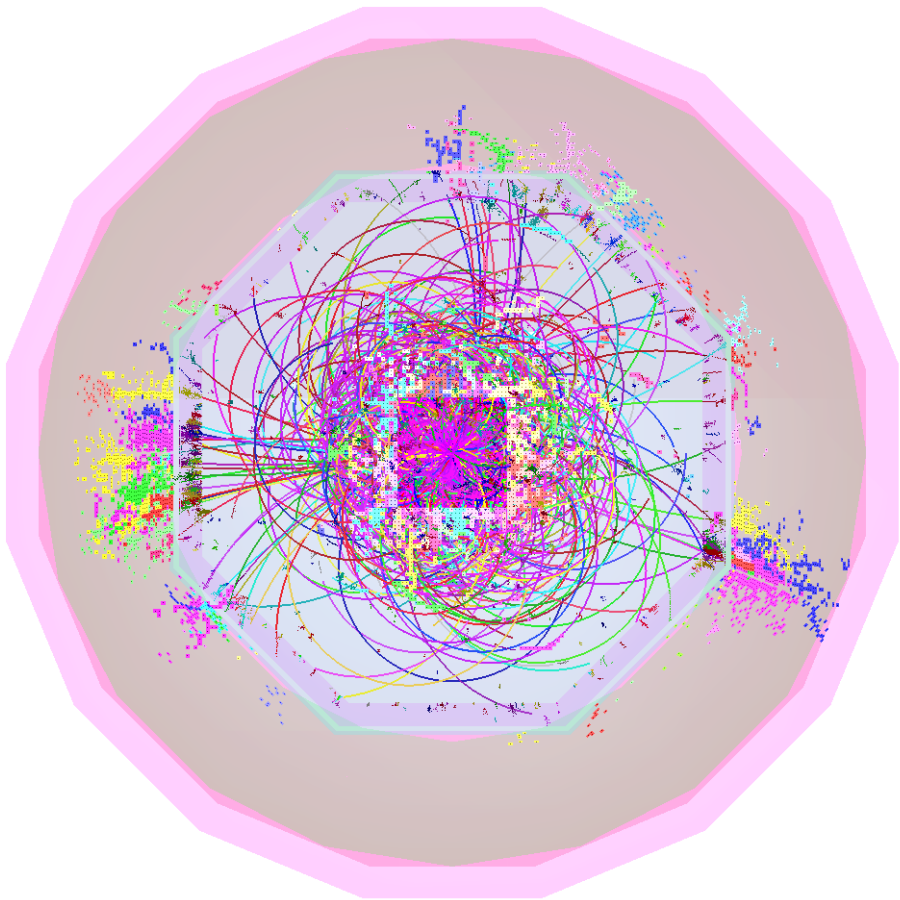

SPARE SLIDES

Parameter	Value
Center-of-mass energy \sqrt{s}	3 TeV
Instantaneous peak luminosity	$5.9 \times 10^{34} \text{ cm}^{-2} \text{ s}^{-1}$
Integrated luminosity per year	500 fb^{-1}
Beam crossing angle	20 mrad
Train length	156 ns
$N_{\text{bunches}} / \text{train}$	312 (every 0.5 ns)
Train repetition rate	50 Hz
IP size x/y/z	45 nm / 1 nm / 40 μm
# $\gamma\gamma \rightarrow \text{hadrons} / \text{bx}$	3.2
# incoherent electron pairs / bx	3×10^5

What can CLIC provide in the 0.5-3 TeV range? In a nutshell...

Higgs physics:

- Complete study of the light standard-model Higgs boson, including rare decay modes (rates factor ~ 5 higher at 3 TeV than at 500 GeV)
 - Higgs coupling to leptons
 - Study of triple Higgs coupling using double Higgs production
- Study of heavy Higgs bosons (supersymmetry models)

Supersymmetry:

- Extensive reach to measure SUSY particles
- Including weakly interacting SUSY particles

And in addition:

- Probe for theories of extra dimensions
- New heavy gauge bosons (e.g. Z')
- Excited quarks or leptons

Mass measurements ~ 5 -10 times better than LHC
(tbc)

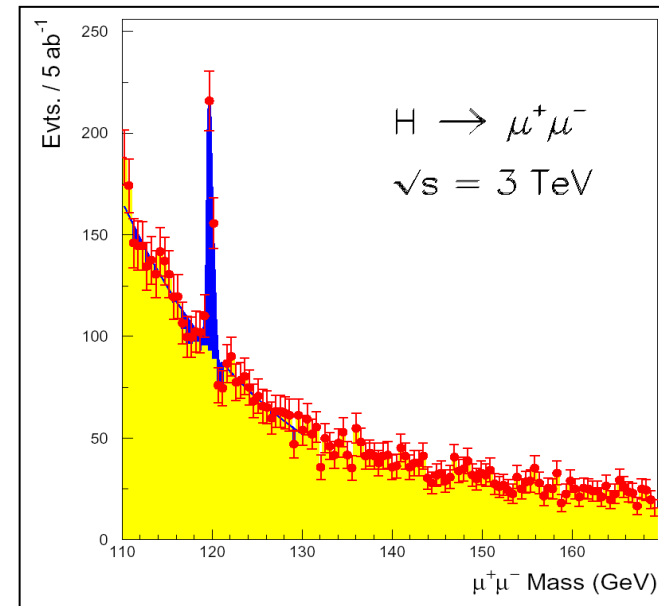

	LHC 100 fb⁻¹	ILC 800 GeV 500 fb⁻¹	SLHC 1000 fb⁻¹	CLIC 3 TeV 1000 fb⁻¹
Squarks (TeV)	2.5	0.4	3	1.5
Sleptons (TeV)	0.34	0.4		1.5
New gauge boson Z' (TeV)	5	8	6	22
Excited quark q* (TeV)	6.5	0.8	7.5	3
Excited lepton l* (TeV)	3.4	0.8		3
Two extra space dimensions (TeV)	9	5-8.5	12	20-35
Strong W _L W _L scattering	2σ	-	4σ	70σ
Triple-gauge Coupling (95%)	.0014	0.0004	0.0006	0.00013

Small scale version of the CLIC drive beam complex

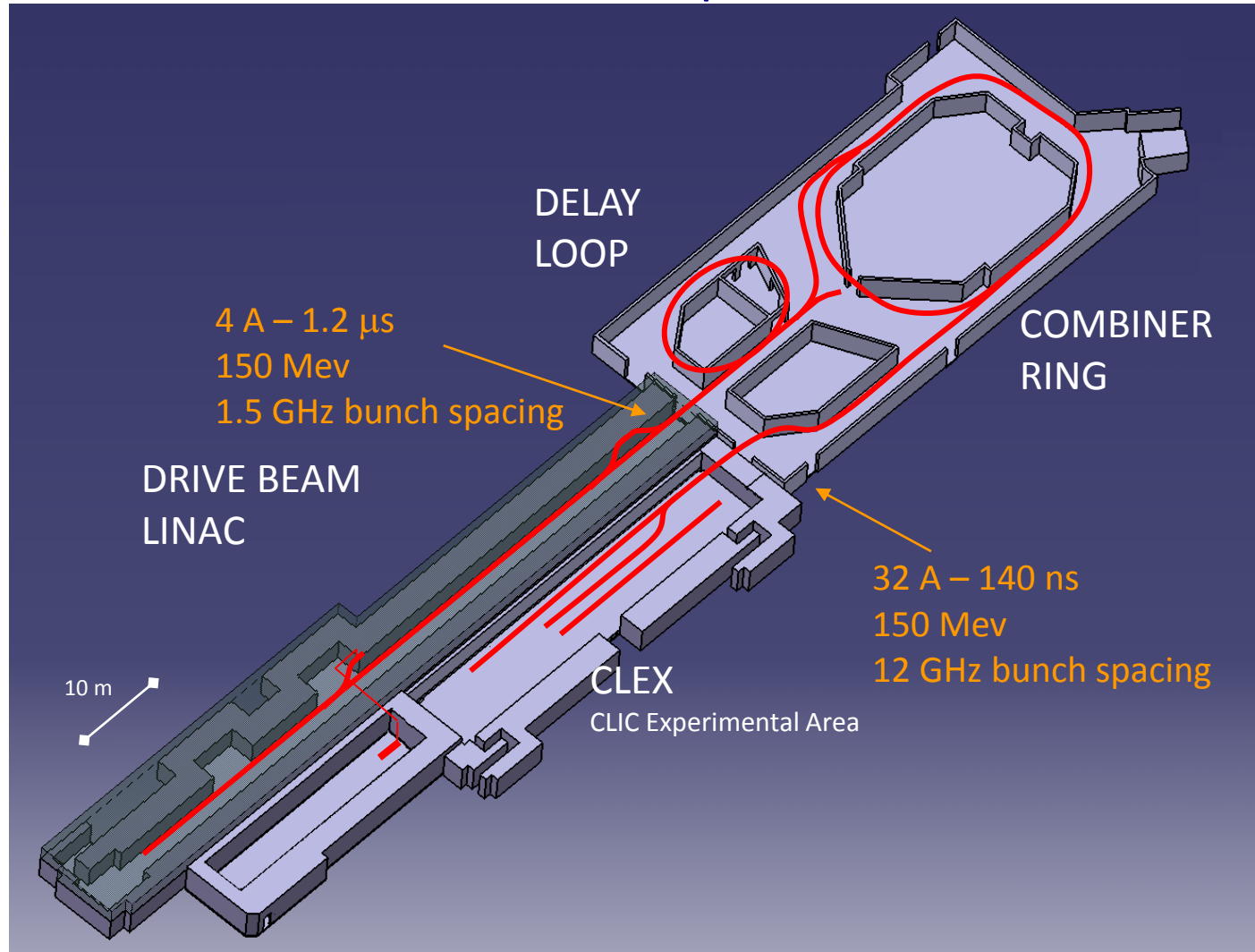

- ✓ ~ 27 A combined beam current reached, nominal 140 ns pulse length
- ✓ → **Full drive beam generation**, main goal of CTF3, **achieved**

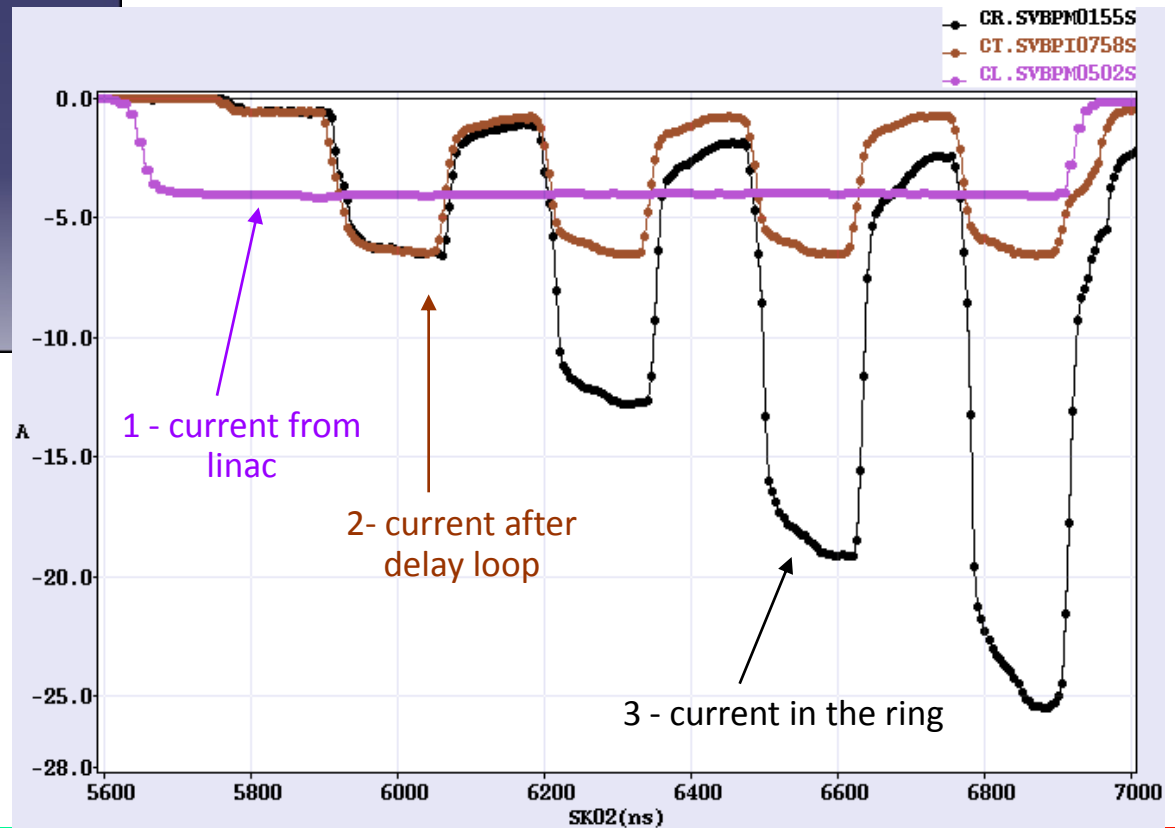
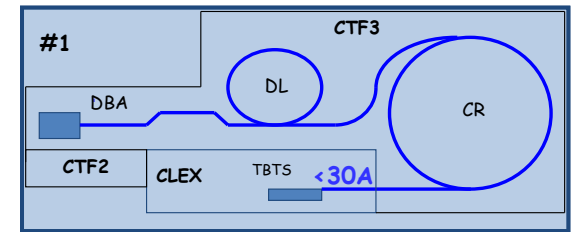
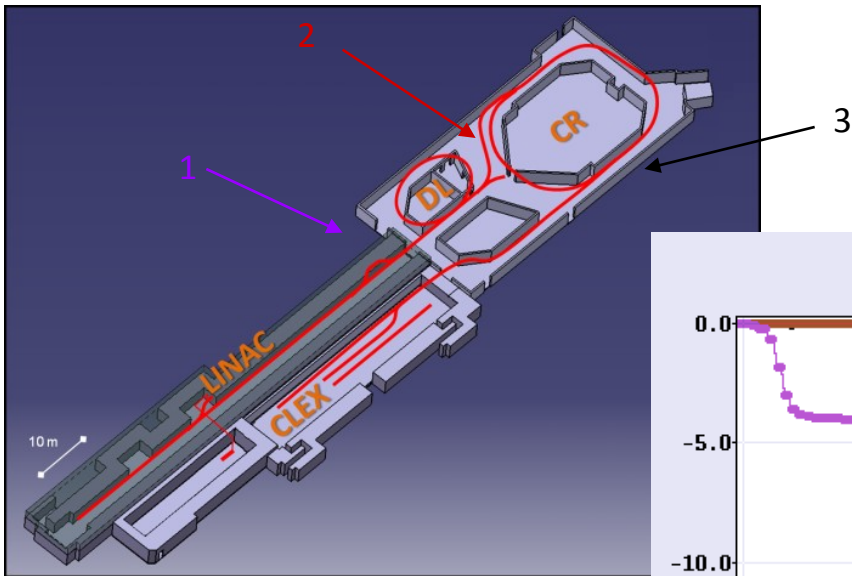

- CLIC Decelerator sector: ~ 1 km, 90% of energy extracted

Two-beam Test Stand (TBTS):

- Single PETS with beam
- Accelerating structure with beam
 - wake monitor
 - kick on beam from break down
- Integration

Test Beam Line (TBL):

- Drive beam transport (16 PETS)
 - beam energy extraction and dispersion
 - wakefield effects

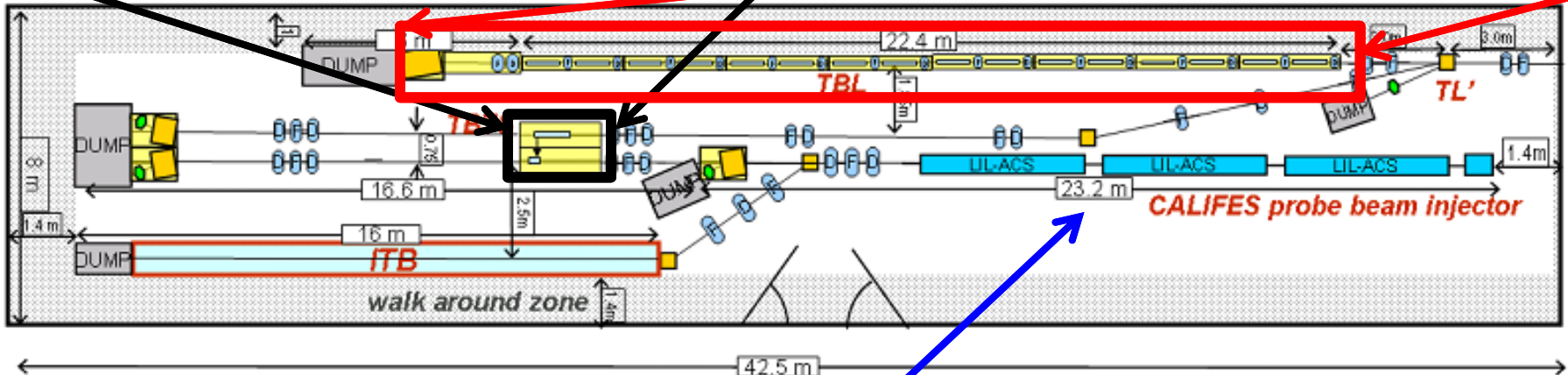

- **Califes:** Probe beam photo-injector
- Beam energy 175 MeV

G. Riddone et al.

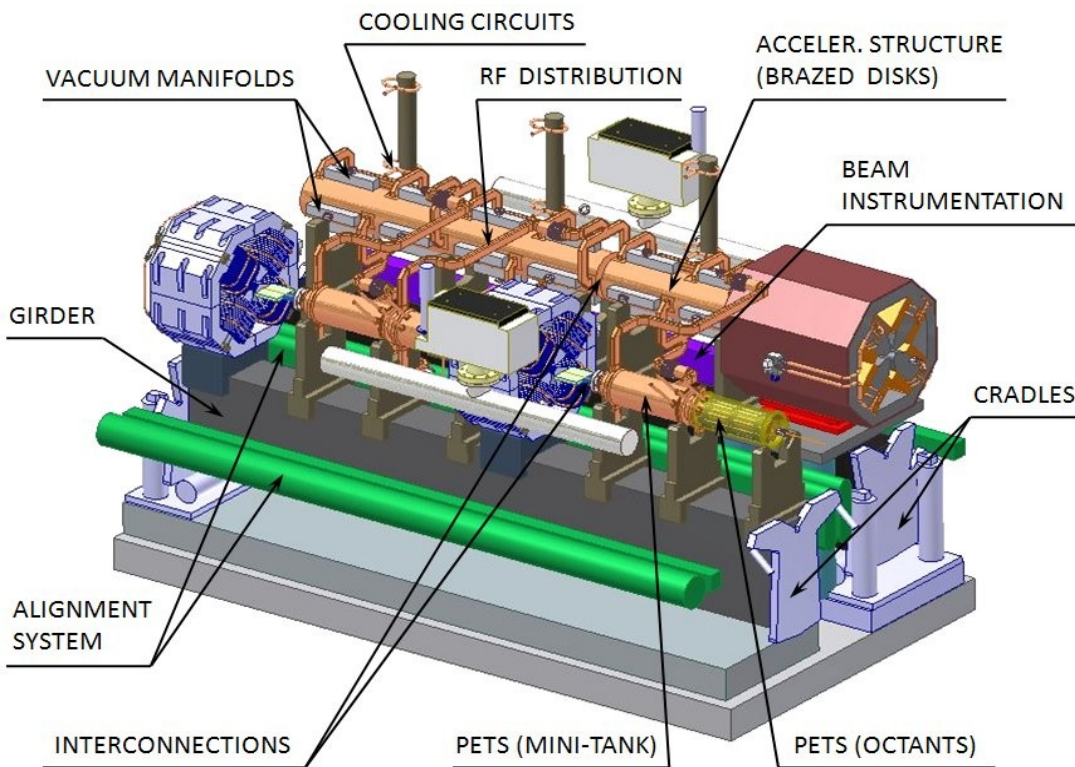

Installation in the CLEX facility

Test in CLEX, very recent result

23 MeV beam acceleration
106 MV/m accelerating gradient

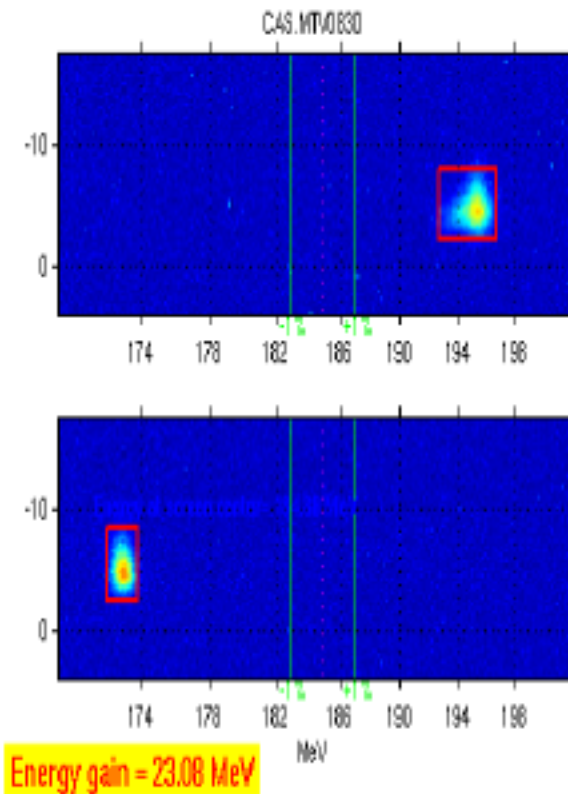
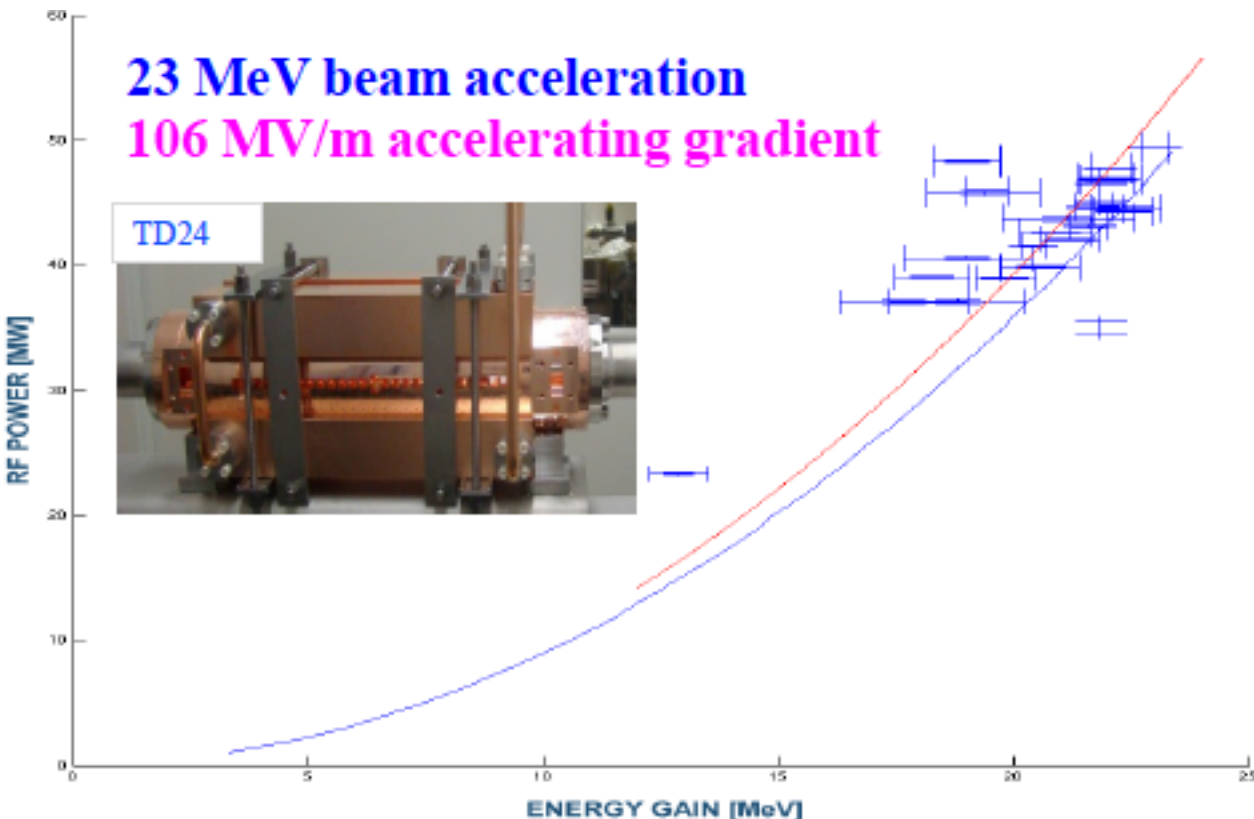
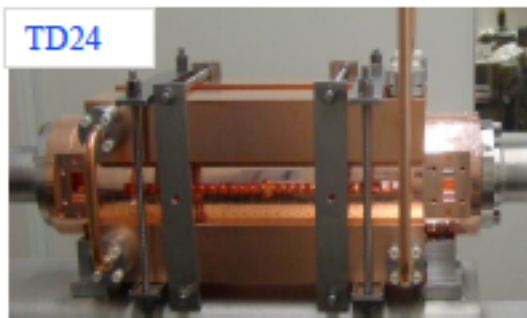

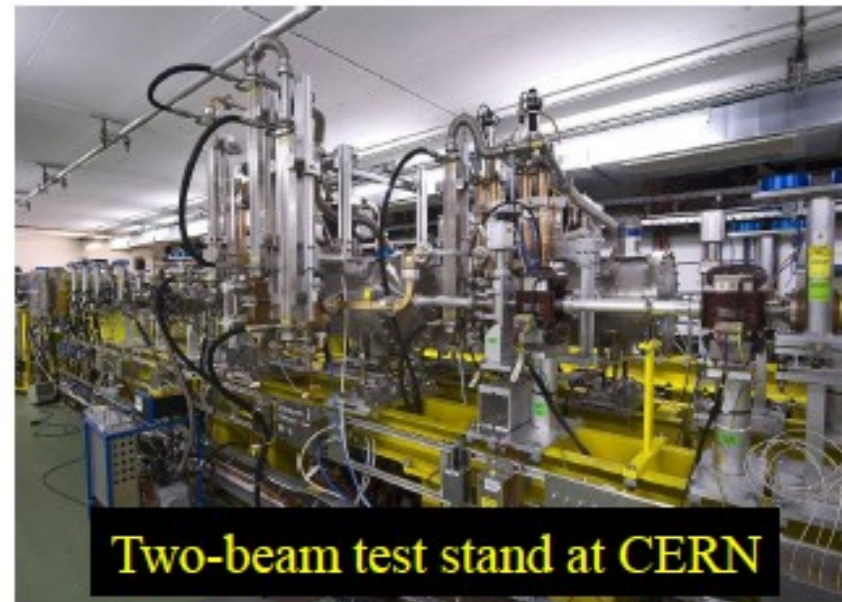
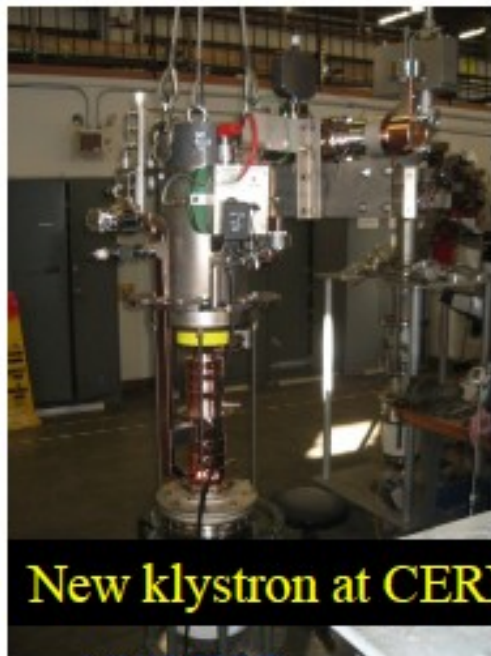



World-wide CLIC&CTF3 Collaboration

http://clic-meeting.web.cern.ch/clic-meeting/CTF3_Coordination_Mtg/Table_MoU.htm



CLIC multi-lateral collaboration 41 Institutes from 21 countries

ACAS (Australia)
 Aarhus University (Denmark)
 Ankara University (Turkey)
 Argonne National Laboratory (USA)
 Athens University (Greece)
 BINP (Russia)
 CERN
 CIEMAT (Spain)
 Cockcroft Institute (UK)
 ETHZurich (Switzerland)
 FNAL (USA)
 Gazi Universities (Turkey)

Helsinki Institute of Physics (Finland)
 IAP (Russia)
 IAP NASU (Ukraine)
 IHEP (China)
 INFN / LNF (Italy)
 Instituto de Fisica Corpuscular (Spain)
 IRFU / Saclay (France)
 Jefferson Lab (USA)
 John Adams Institute/Oxford (UK)

John Adams Institute/RHUL (UK)
 JINR (Russia)
 Karlsruhe University (Germany)
 KEK (Japan)
 LAL / Orsay (France)
 LAPP / ESIA (France)
 NIKHEF/Amsterdam (Netherlands)
 NCP (Pakistan)
 North-West. Univ. Illinois (USA)
 Patras University (Greece)

Polytech. University of Catalonia (Spain)
 PSI (Switzerland)
 RAL (UK)
 RRCAT / Indore (India)
 SLAC (USA)
 Thrace University (Greece)
 Tsinghua University (China)
 University of Oslo (Norway)
 Uppsala University (Sweden)
 UCSC SCIPP (USA)



Large international collaborations for Linear Collider detector technology studies:

CALICE

- Fine-grained calorimetry, based on particle flow analysis
- <https://twiki.cern.ch/twiki/bin/view/CALICE/WebHome>

LC-TPC

- Time projection chamber based on MPGD readout
- <http://alephwww.mppmu.mpg.de/~settles/tpc/lp/wpmtg/wpmtg.html>

SILC

- Silicon-based tracking technologies
- <http://lpnhe-lc.in2p3.fr/>

FCAL

- Very forward region: background studies and calorimetry
- <http://www-zeuthen.desy.de/ILC/fcal/>

AIDA and EUDET

EU-funded FP6/FP7 projects including LC detector technologies

<http://aida.web.cern.ch/>

<http://www.eudet.org/>

**List not fully complete (e.g. vertex detector groups)
Until recently these technology collaborations concentrated on ILC**

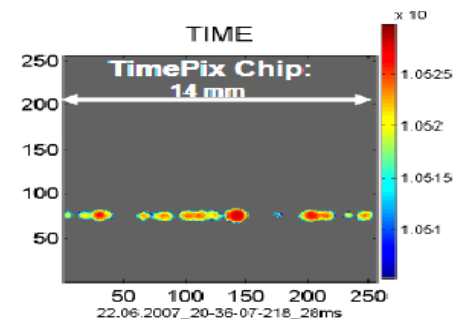
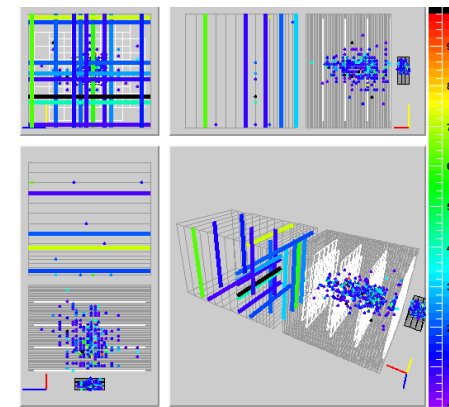

- Background occupancies in vertex region dominated by **incoherent electron pairs** produced from the interaction of real or virtual photons with an electron from the incoming beam
 - 20 mrad crossing angle leads to large amount of back-scattered particles, suppressed in latest design by optimization of absorbers and forward geometry
 - In CLIC_ILD innermost barrel layer (R=30 mm):
 - **~1.5 hits / mm² / 156 ns train**
 - assuming 20 x 20 μm^2 pixels, cluster size of 5, safety factor of x5:
 - **~1.5% occupancy / pixel / 156 ns train**
 - $\gamma\gamma \rightarrow$ hadrons: ~5-10x smaller rates
 - CLIC-SiD: similar background rates
- Multiple hits per bunch train can occur
 → Sufficient to readout only once per train
 → **Time stamp** with **5-10 ns** required

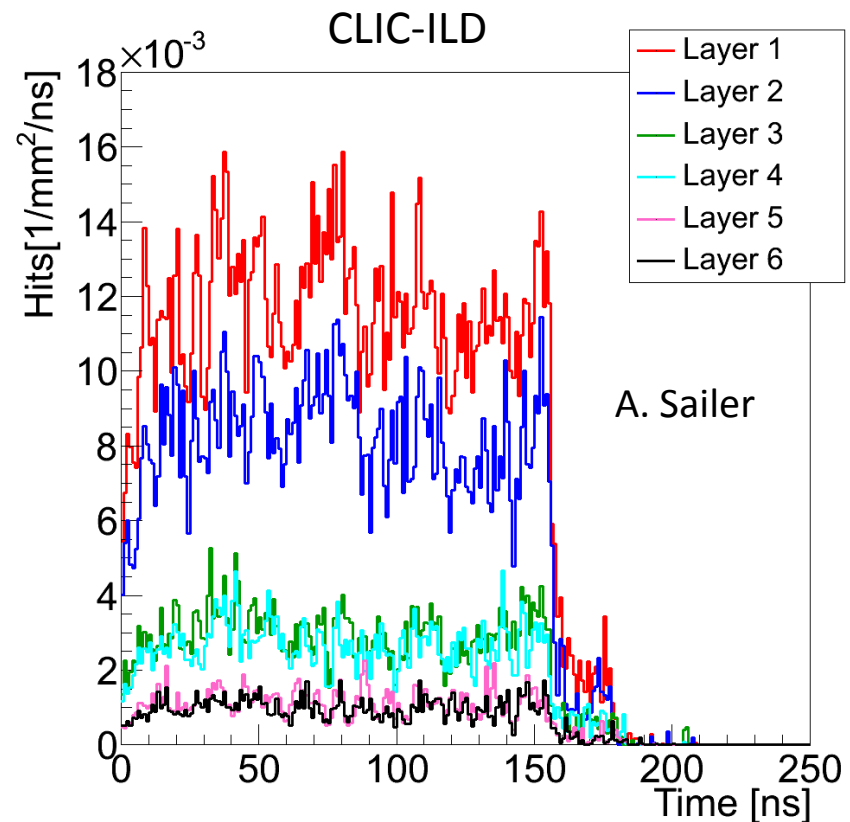

A. Sailer

Power delivery,
on/off at 50Hz,
driven by front-
end electronics

Final Focus: Active
and passive
stabilisation,
alignment

Solenoid coil:
Reinforced conductor
tests. Materials

Calorimetry:
>1000 m² cost-effective
silicon sensors; Integrated
HCAL sensor planes

Main tracker
(silicon strip detectors 150 m²,
TPC gas detector)

Pixel detector:
Integrated solid state sensors,
deep submicron, small-pitch
interconnect, low-mass
cooling, ultra-thin materials

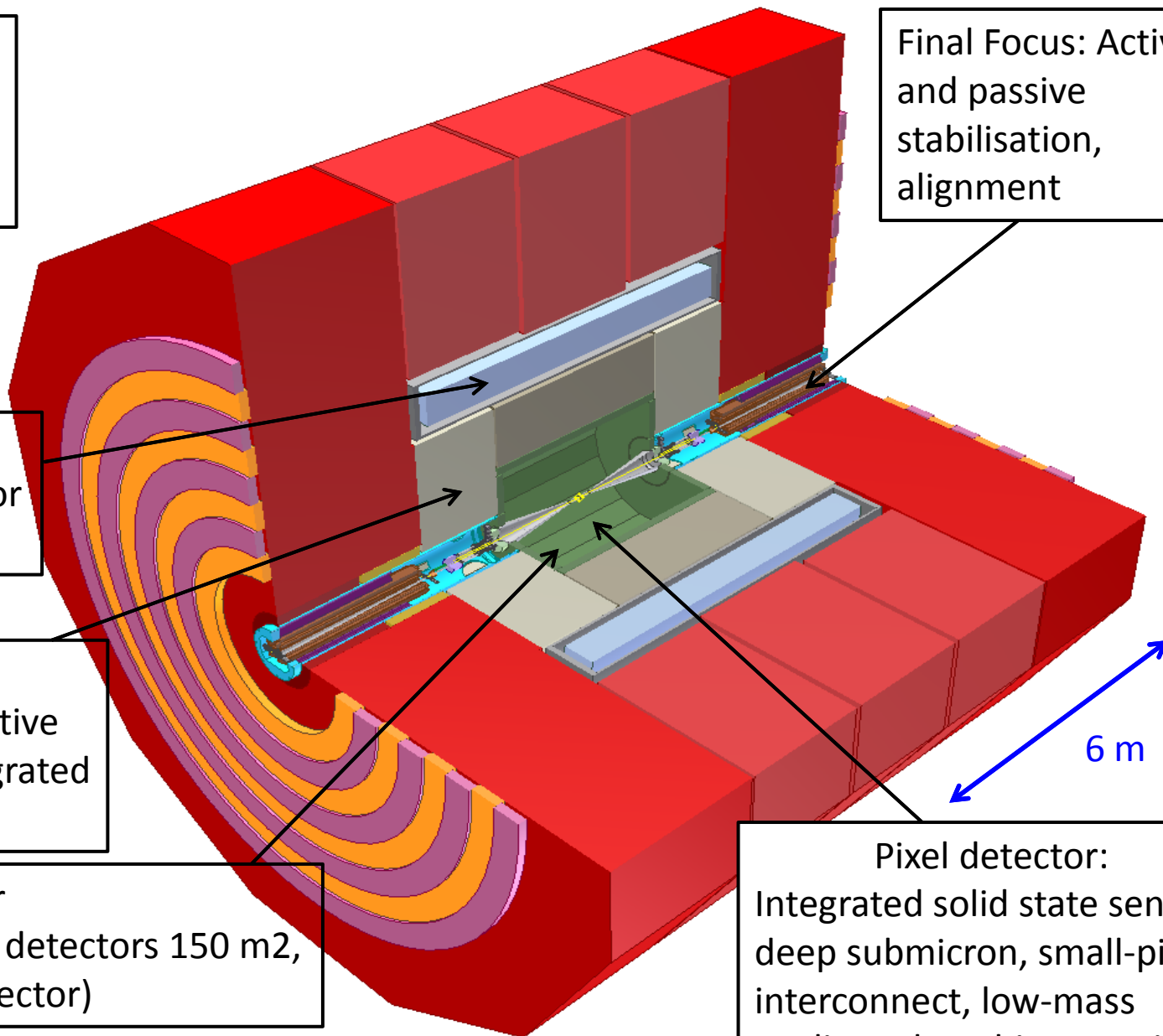

Very preliminary, data not yet calibrated

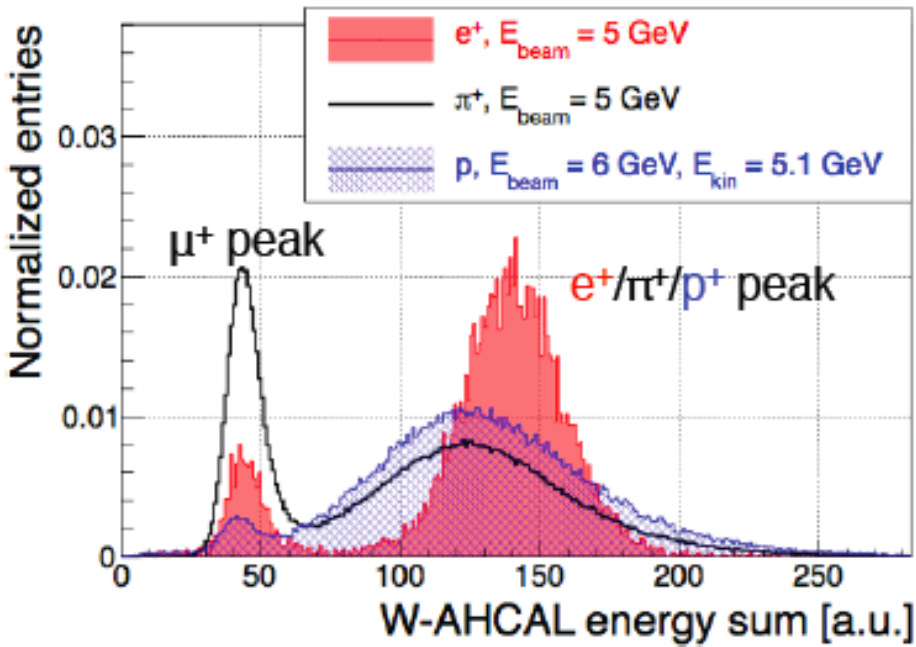

Response to μ^+, e^+, π^+, p^+ at 5 GeV

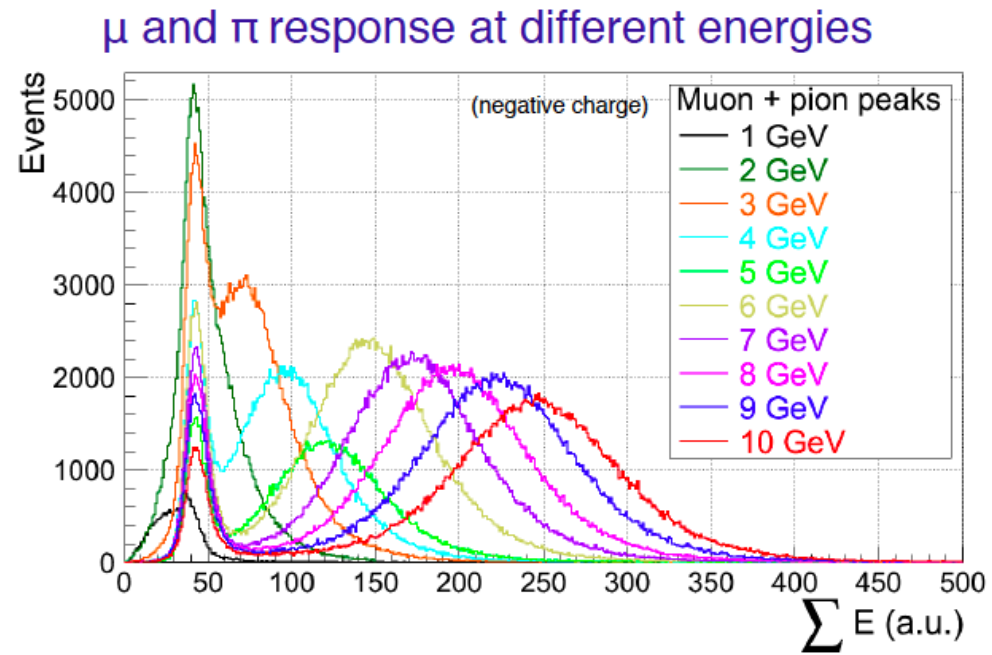

- Follow-up on Timepix and Medipix3 chips
- Broad client community (HEP and non-HEP):
 - X-ray radiography, X-ray polarimetry, low energy electron microscopy
 - Radiation and beam monitors, dosimetry
 - 3D gas detectors, neutrons, fission products
 - Gas detector, Compton camera, gamma polarization camera, fast neutron camera, ion/MIP telescope, nuclear fission, astrophysics
 - Imaging in neutron activation analysis, gamma polarization imaging based on Compton effect
 - Neutrino physics
- **Main Linear Collider application: pixelized TPC readout**
- Technology IBM 130nm DM 3-2-3 or 4-1
- Design groups: **NIKHEF, BONN, CERN**
- PLL and on-pixel oscillator architecture test (MPW, spring 2011)
- **Expected submission of full Timepix2 chip (early 2012)**

- Matrix layout: 256x256 pixels (Pixel size 55x55 μm)
- Low noise and low minimum detectable charge:
 - < 75 e- ENC
 - < 500 e- minimum threshold
- Time stamp and TOT recorded simultaneously
 - 4 bits Fast time-stamp
 - resolution $\sim 1.5\text{ns}$ (if using on-pixel oscillator running at 640MHz)
 - Dynamic range 25ns
 - 10-12 bits Slow time-stamp
 - Resolution 25ns (@40MHz)
 - Dynamic range 25.6 μs (10 bit) to 102.4 μs (12 bit)
 - 8-10 bit Energy Measurement (TOT)
 - Standard Resolution 25ns (@40MHz)
 - Energy Dynamic range from 6.4 μs to 25.6 μs (@40MHz)
- Bipolar input with leakage current compensation
 - e- and h+ collection, input capacitance $\ll 50\text{ fF}$
- Sparse Readout

Timepix2 Top Level Schematic

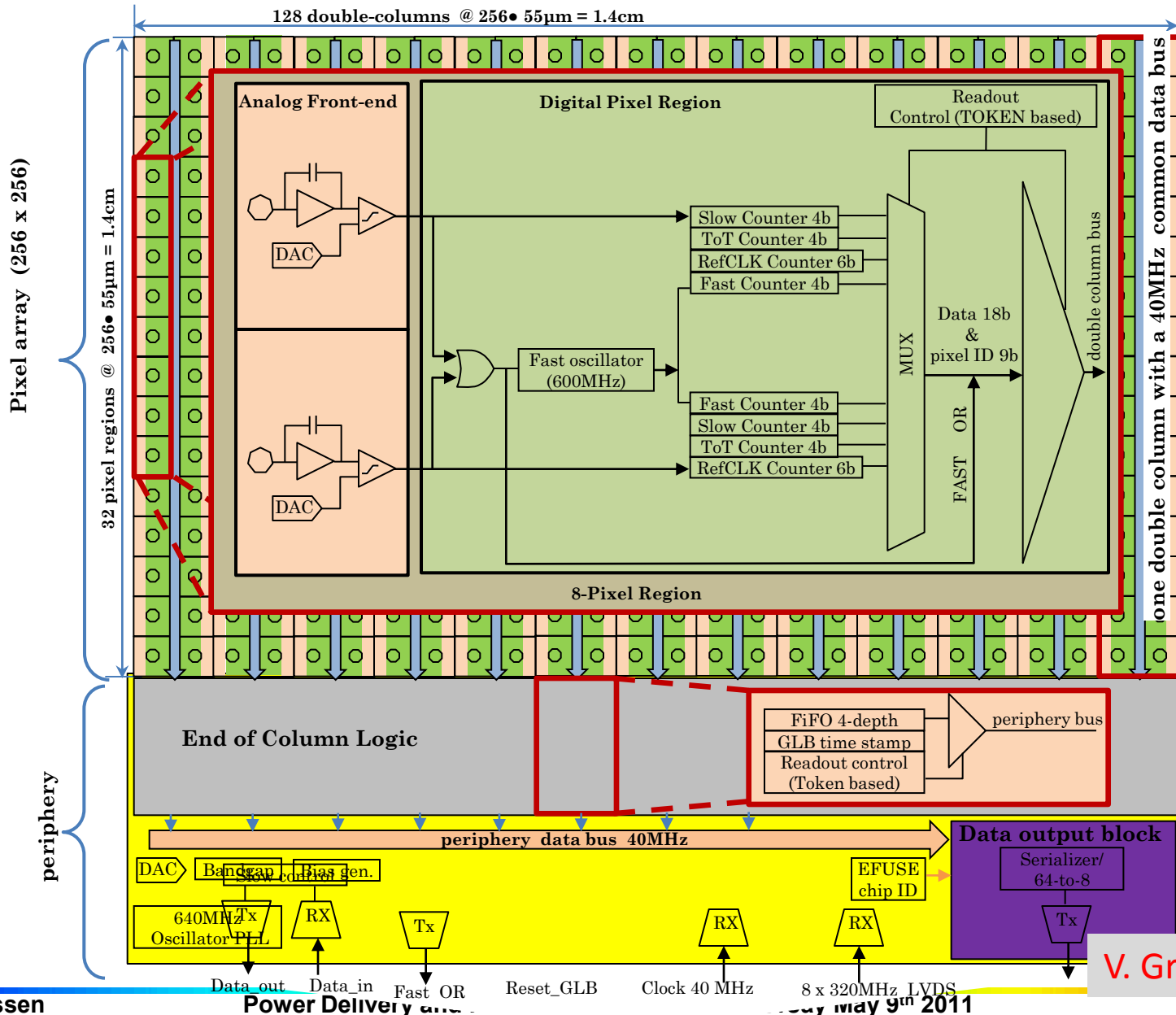

P. Aspell, M. de Gaspari, H. Franca,
E. Garcia, L. Musa, CERN

A 16 channel front-end chip including DSP functions for the readout of gaseous detectors such as MWPC, GEM, Micromegas.

Submitted in IBM 130nm CMOS technology, Q3 2010.

Received back from the foundry Q1, 2011, currently under test.



Size: 5750um x 8560um, 49.22mm²



The Saltro 16 architecture.

16 channels,

Each channel comprising :
 Low-noise programmable pre-amplifier and shaper,
 ADC,
 Digital Signal Processor.

Max sampling frequency: 40MHz

Max readout frequency: 80MHz

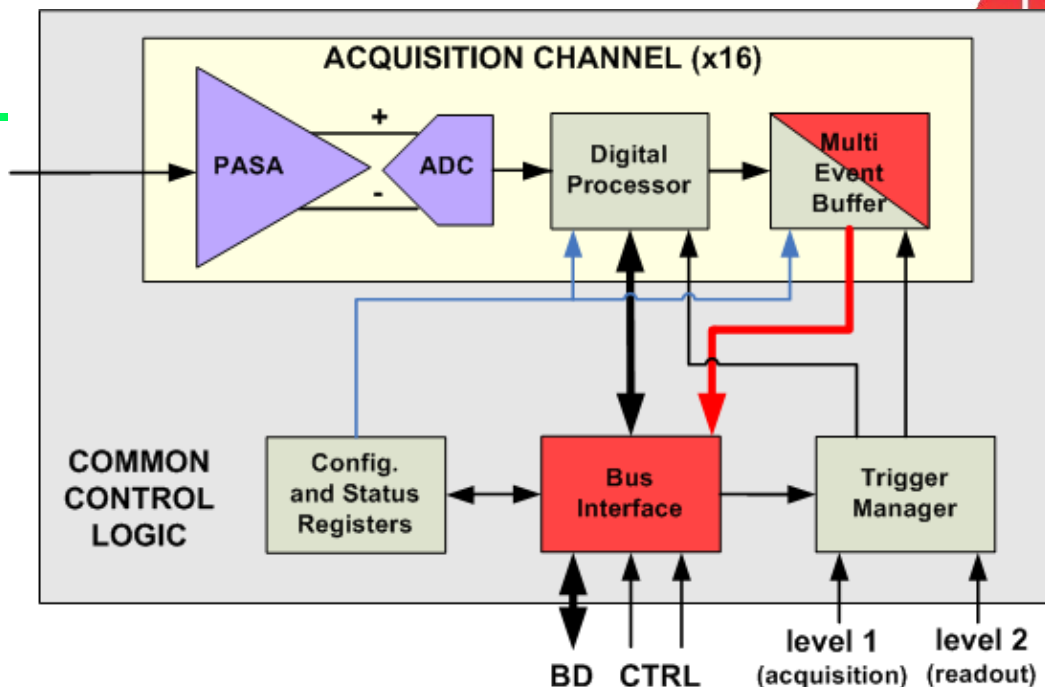

- Runs with Sampling Clock
- Runs with Readout Clock

Interface compatible with the
ALICE TPC

PASA	ADC	Digital Signal Processor
Single-ended to differential	10bit	Baseline correction 1: removes systematic offsets
Pos/neg polarity	40MHz max freq	Digital shaper: removes the long ion tail
Shaping time 30-120ns	Power adjustable to the freq	Baseline correction 2: removes low-freq baseline shifts
Gain 12-27mV/fC		Zero Suppression
Power pulsing feature included.	Possibility of power pulsing via external bias control.	External clock control for power pulsing

Material studies and magnet calculations are ongoing in several labs.

Using experience from ATLAS and CMS magnet systems, an **R&D effort has started on the superconducting cable for the main solenoid.**

Conductor overview

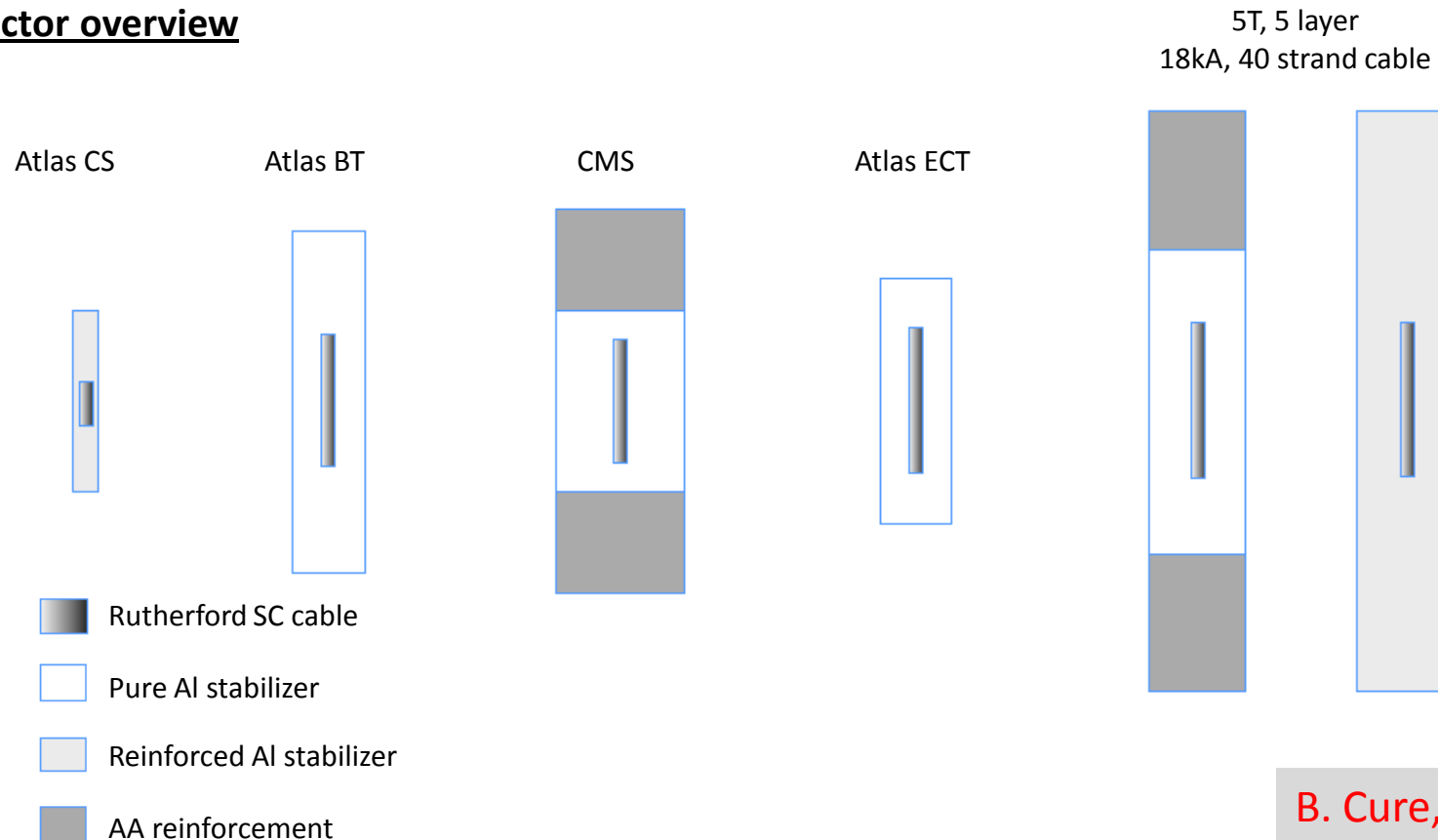

B. Cure, CERN



Update:

SC conductor R&D
– main detector magnet

Coextrusion “Rutherford cable”
With structural Al stabiliser (Al-
0.1wt%Ni)

Preparations under way
(in collaboration CERN+KEK)

Collaboration with industry

-> first tests foreseen
second half of 2011



B. Blau, ETHZ

Co-extrusion press at Nexans

B. Cure, A. Gaddi, Y. Makida, A. Yamamoto