

Main Linac Basics

D. Schulte

5th Linear Collider School, October/November 2010

Introduction



Stepping Stones

- Introduction
- Accelerating structures
- Power efficiency
- Beam parameters
 - single bunch longitudinal wakefield and energy spread
 - beam transport and emittance
 - transverse wakefields and beam break-up
- Imperfections
- Structure challenges
- Parameter optimisation

Generic Linear Collider Design

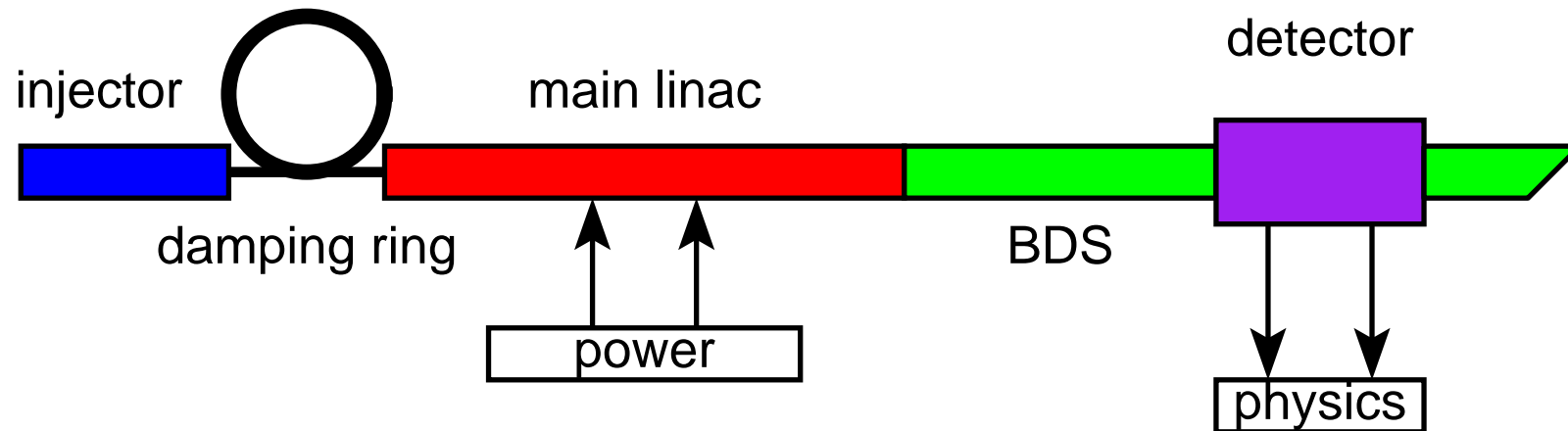

SLC

- The only linear collider so far
- Has been used as a Z_0 factory
- Now used as X-FEL

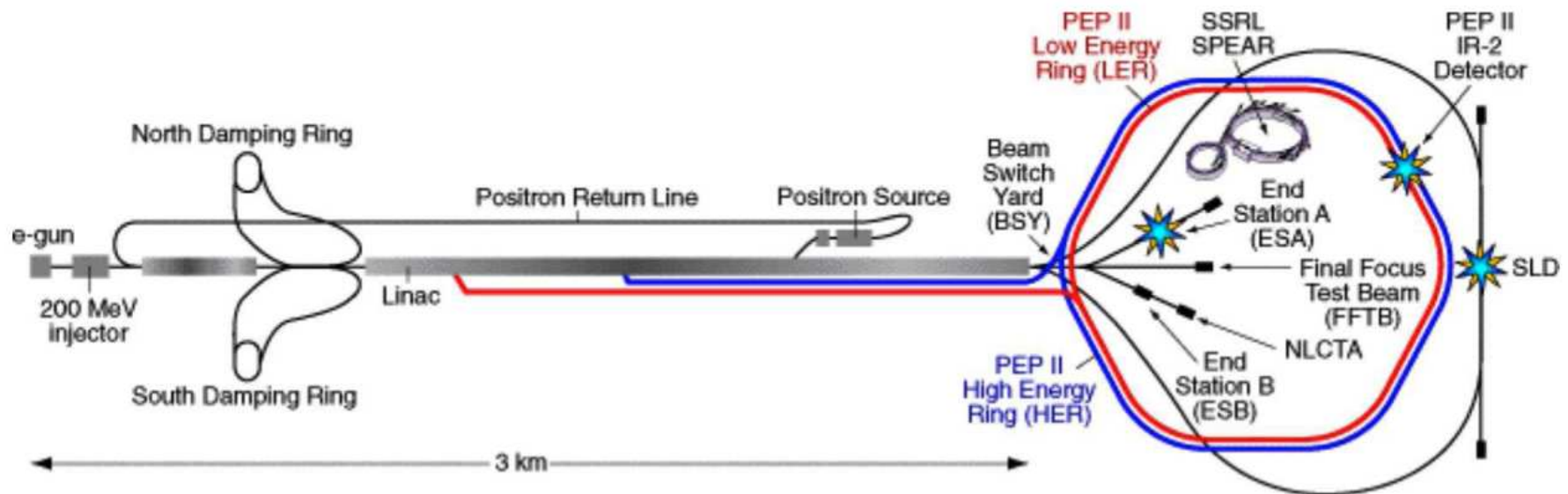
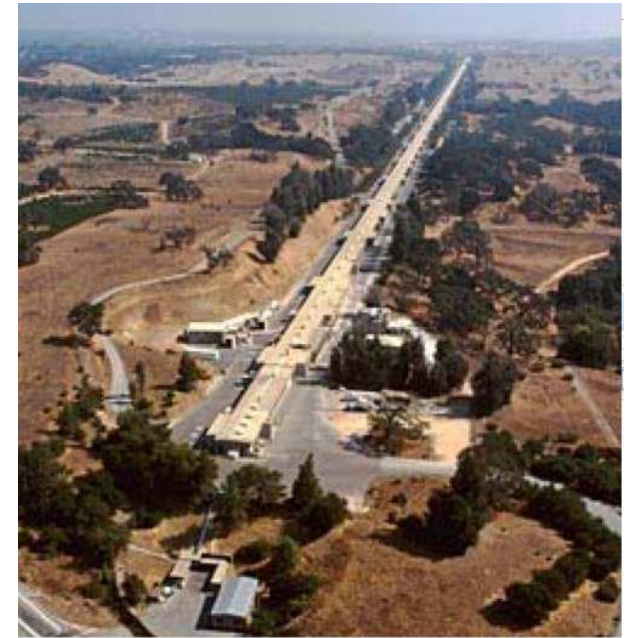

Tunnel Layout (ILC)

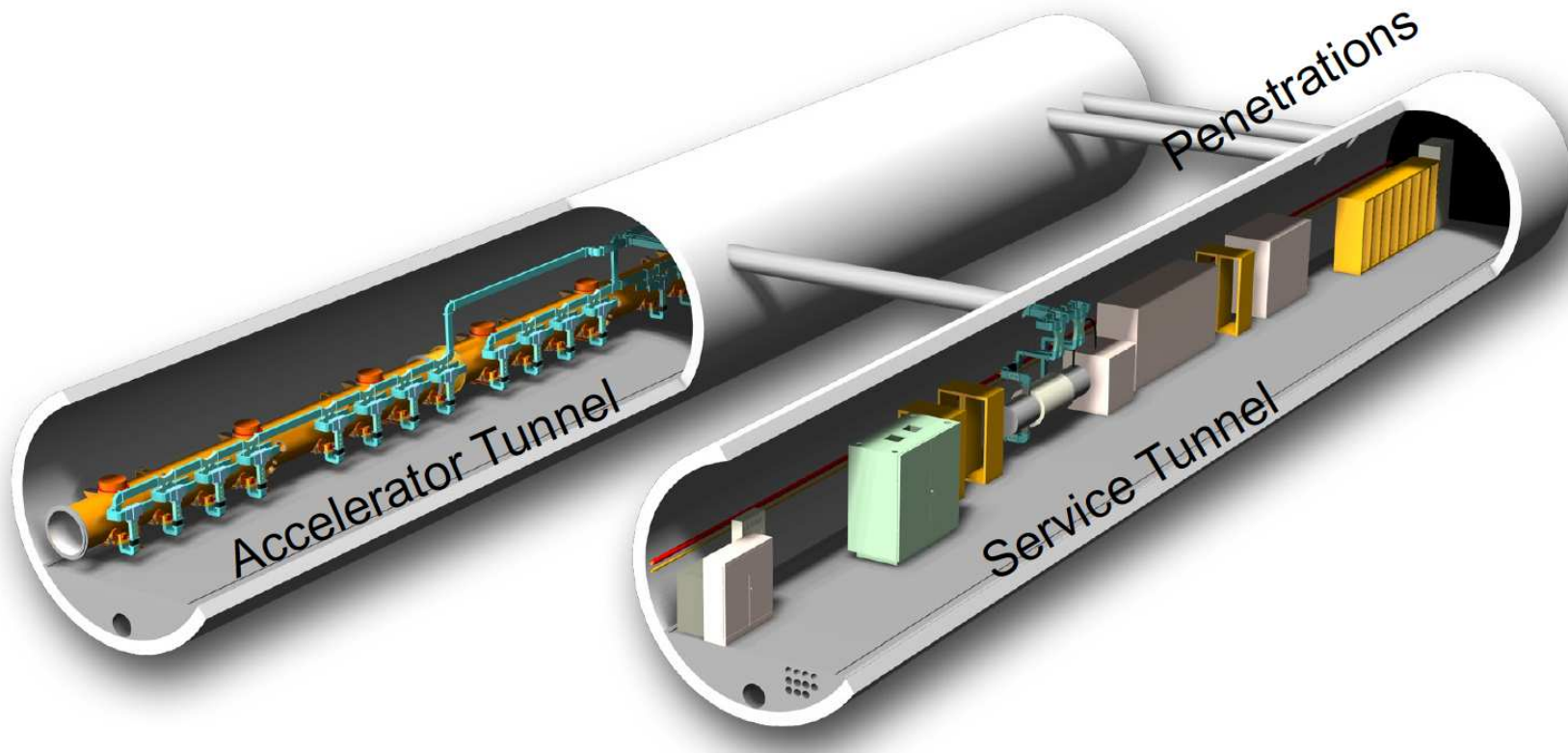

Layout is being revised (single tunnel)

Module Design (ILC)



RF Unit Design (ILC)

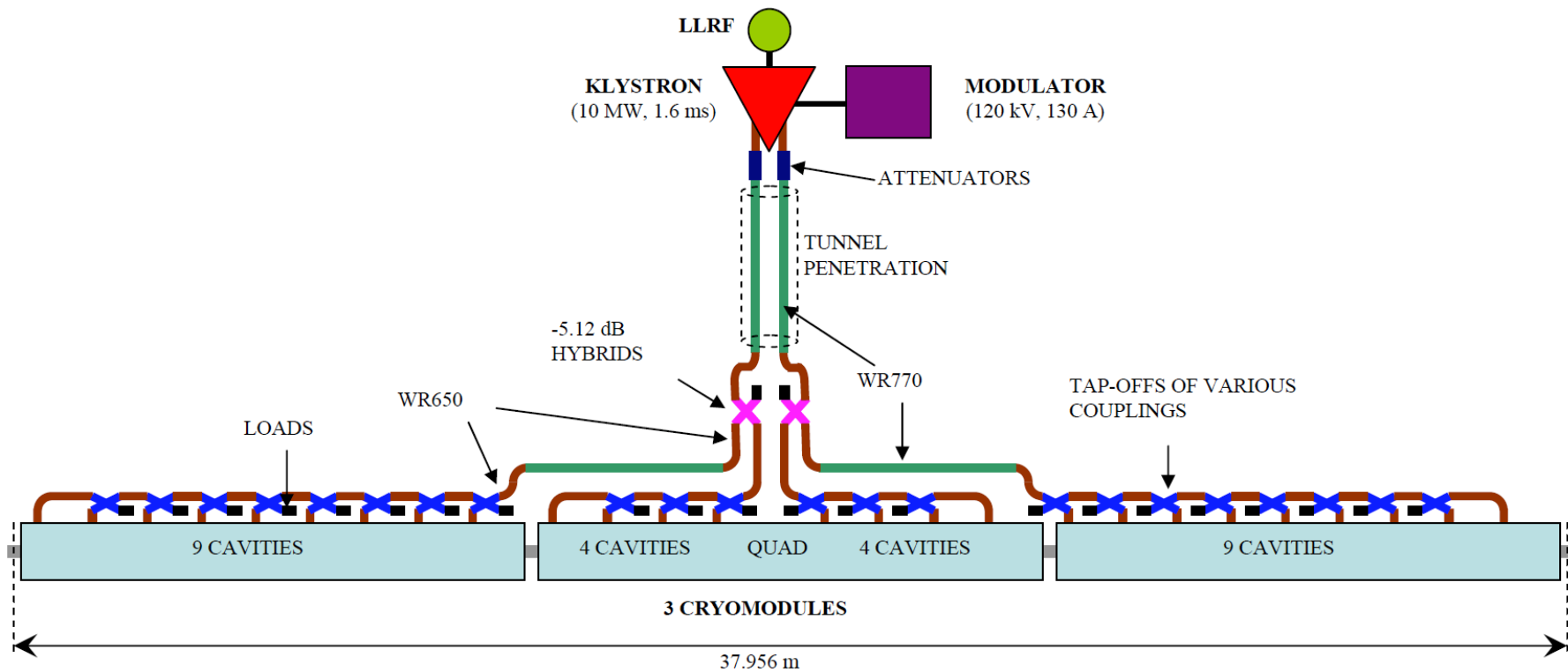

- Most relevant components for the beam
 - accelerating structures
 - quadrupoles
 - beam position monitors (BPMs) and correctors

Module Design (CLIC)

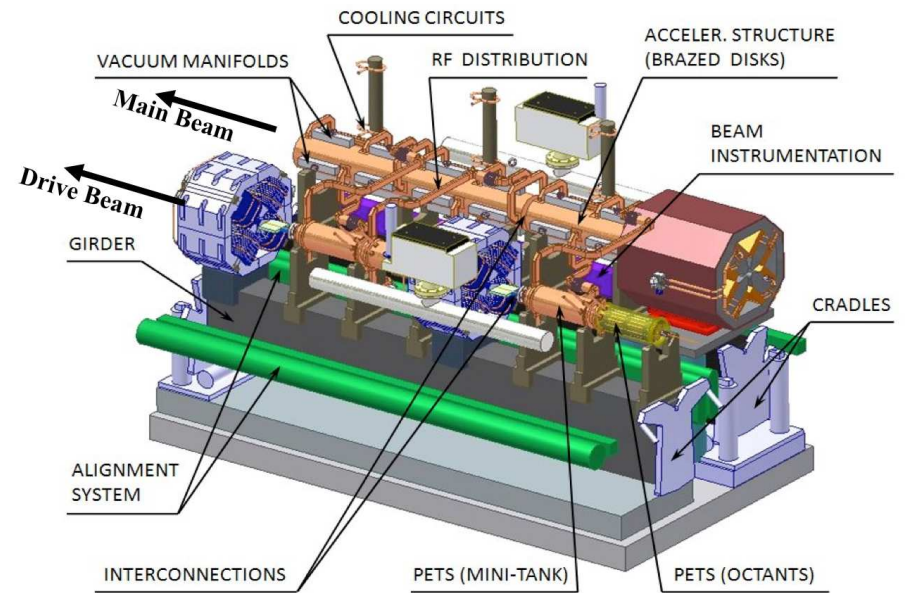
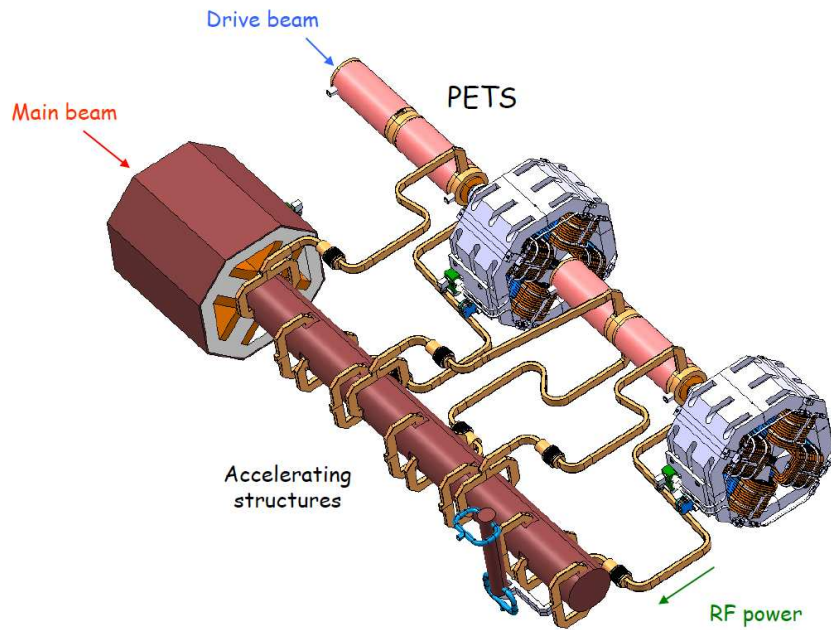

- Five types of main linac modules
- Drive beam module is regular
- Most relevant components for the beam
 - accelerating structures
 - quadrupoles
 - beam position monitors (BPMs) and correctors

Why is the Main Linac Important?

- Two main parameters that are important for the physics experiments
 - collision energy
 - luminosity, a measure for the rate of events at the interaction point
- The main linac is the main component to accelerate the beam
 - ⇒ it is responsible for the beam energy
 - the main relevant parameter is the accelerating gradient
- The main linac is the main consumer of power
 - ⇒ it is an important limitation for the beam current
 - the luminosity depends on the beam current
- The main linac is one of the main sources of emittance growth
 - ⇒ the emittance is a parameter that affects the luminosity
- There is a third parameter which the main linac affects very much, the cost
 - is the society willing to pay for it?

Cost Impact

- In ILC 60% of the cost is in the ML
- The long tunnel is expensive
 - and important for the schedule (tunnel boring machines)
- The installed components are expensive
- The linac drives other machine components
 - large damping rings in ILC to be able to store the full bunch train
 - drive beam complex in CLIC

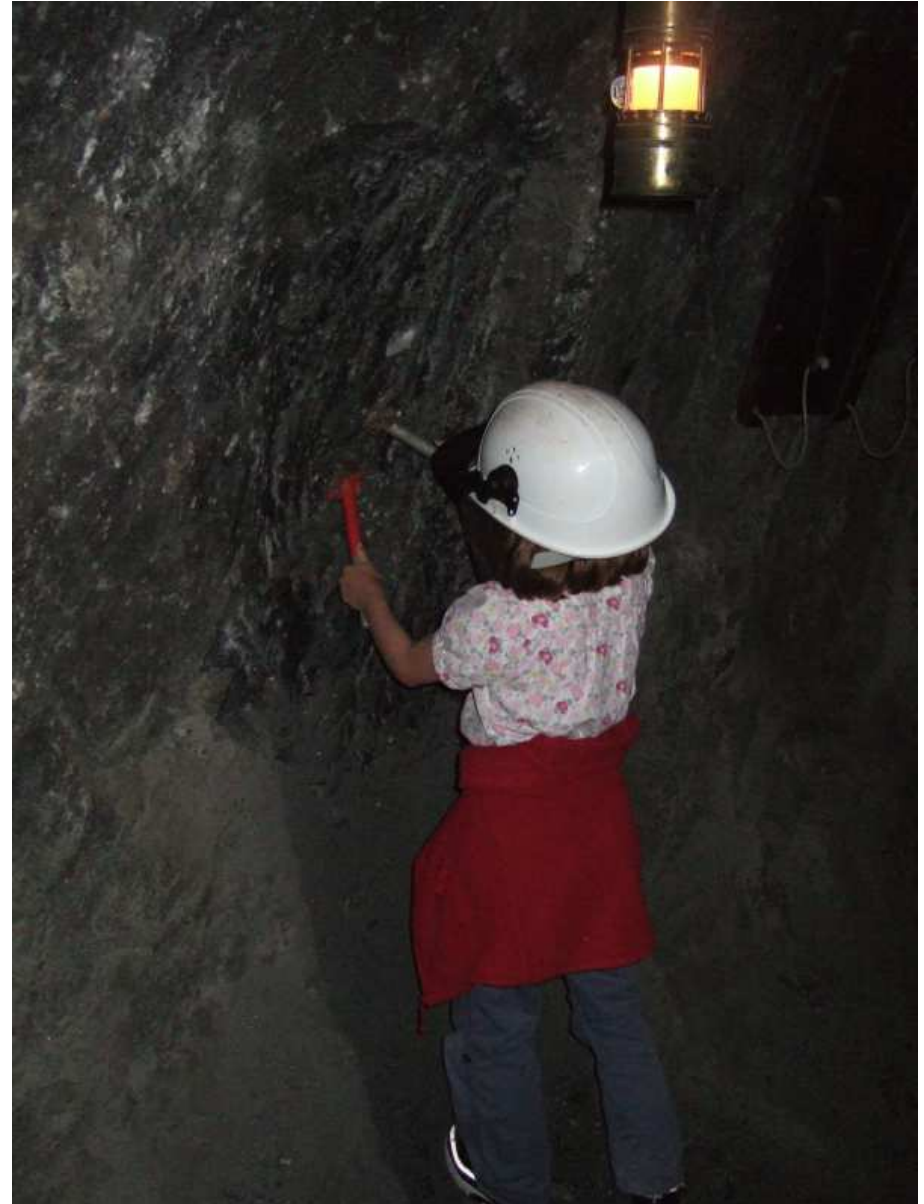

CLIC Feasibility Issues

- RF structures (gradient and power production)
 - accelerating structures (CAS)
 - power production structures (PETS)
- Two-beam acceleration (power generation and machine concept)
 - drive beam generation
 - two-beam module
 - drive beam deceleration
- Ultra low beam emittance and beam sizes (luminosity)
 - emittance preservation during generation, acceleration and focusing
 - alignment and stabilisation
- Detector (experimental conditions)
 - adaptation to short interval between bunches
 - adaptation to large background at high beam collision energy
- Operation and Machine Protection System (robustness)

ILC Feasibility Issues

- None
- But cost is an important issue
 - the cavity gradient drives the ML length and cost

Some Fundamental Parameters

parameter	symbol	ILC	CLIC
centre of mass energy	E_{cm}	500 GeV	3000 GeV
luminosity	\mathcal{L}	$2 \cdot 10^{34} \text{ cm}^{-2}\text{s}^{-1}$	$6.5 \cdot 10^{34} \text{ cm}^{-2}\text{s}^{-1}$
luminosity in peak	$\mathcal{L}_{0.01}$	$1.4 \cdot 10^{34} \text{ cm}^{-2}\text{s}^{-1}$	$2 \cdot 10^{34} \text{ cm}^{-2}\text{s}^{-1}$
gradient	G	31.5 MV/m	100 MV/m
charge per bunch	N	$2 \cdot 10^{10}$	$3.72 \cdot 10^9$
bunch length	σ_z	300 μm	44 μm
horizontal emittance	ϵ_x	8400 nm	600 nm
vertical emittance	ϵ_y	24 nm	10 nm
bunches per pulse	n_b	2625	312
distance between bunches	n_b	369 ns	0.5 ns
repetition frequency	f_r	5 Hz	50 Hz

⇒ Beam Parameters are very different

- in particular time structure

- this also affects the experiments

- We will see that this is driven by the main linac

Accelerating Structures



Accelerating Structure (ILC)

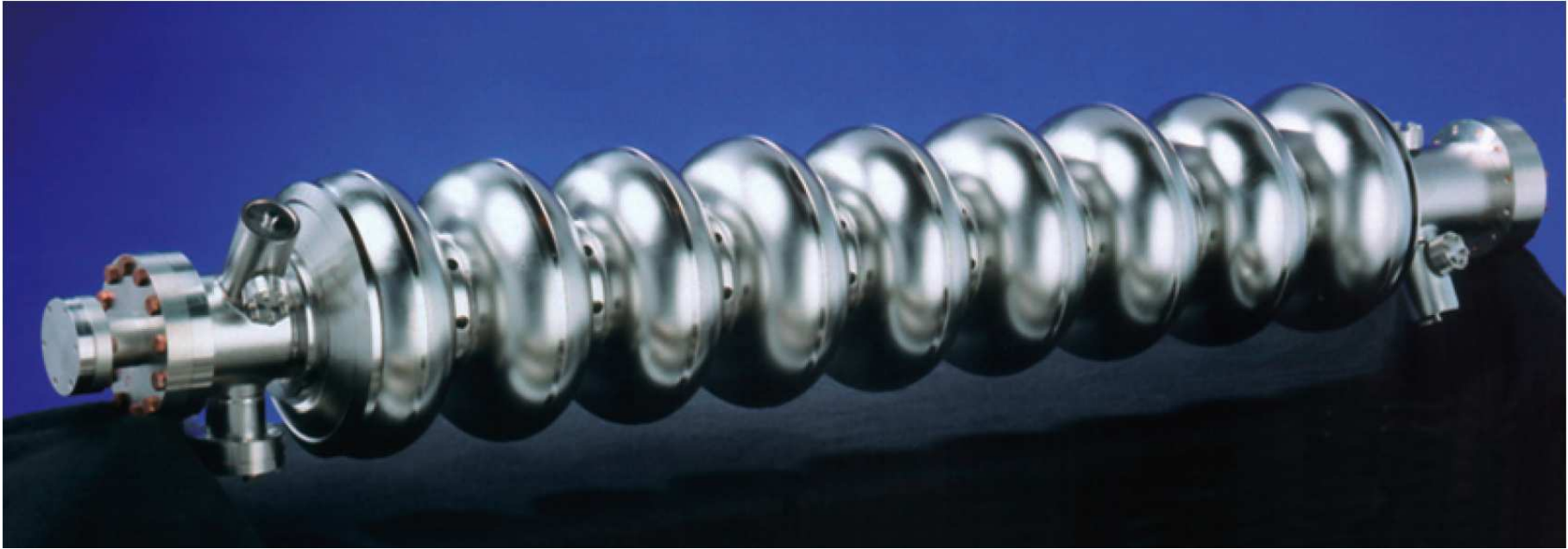

- About 1 m long, super-conducting, 1.3 GHz, standing wave, constant impedance, 31.5 MV/m

Accelerating Structure (CLIC)

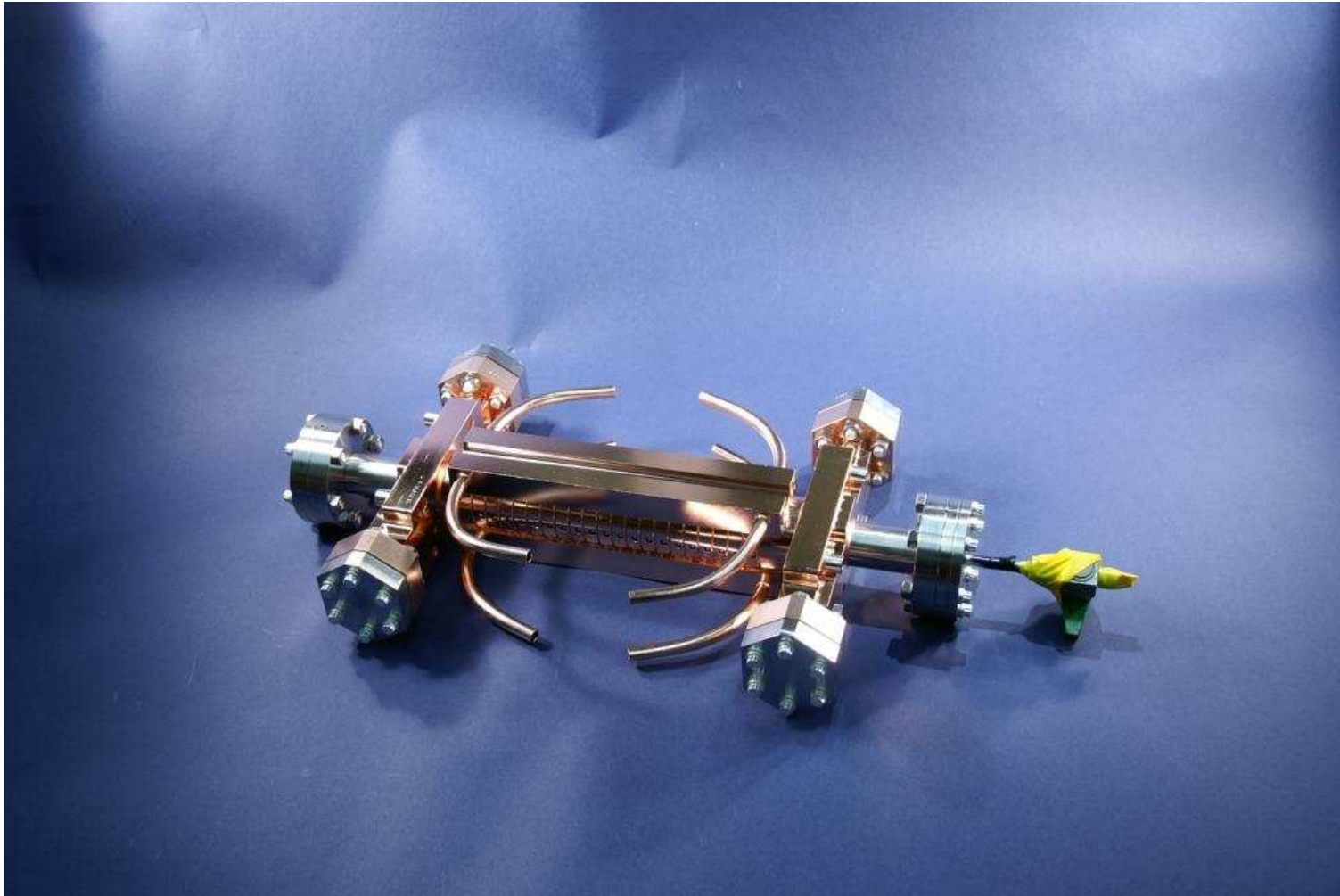

- About 23 cm long, normal-conducting, 12 GHz, travelling wave, constant gradient (almost), 100 MV/m

Types of Structures

- Accelerating structures can be normal-conducting or super-conducting
 - in a super-conducting structure very little power is lost in the walls
 - in a normal conducting structure a significant power is lost in the walls (in most cases)
- They can be standing wave or travelling wave structures
 - in standing wave the energy is trapped and the RF wave is reflected at the ends creating the standing wave
 - in a travelling wave structure power is coupled into one end and extracted at the other
- They can be constant impedance structures or constant gradient structures (or something else)
 - all cells can be the same design or the design differs along the structure

Choice of Material

- The material is the most fundamental design choice
- Super-conducting structures
 - allow a small beam current
 - ⇒ low background per unit time in IP
 - ⇒ intra-pulse feedback is possible everywhere
- Normal conducting structures
 - allow for high gradient
 - ⇒ high centre-of-mass energy
 - need high beam current
 - ⇒ significant wakefield effects
 - use short pulses
 - ⇒ smaller damping ring

Standing Wave Structures

- The power is feed into one end
 - the power is reflected at the coupler
 - as the power in the cavity is increasing, the reflection is reduced
- there is a level when there is no reflection
⇒ now switch on the beam

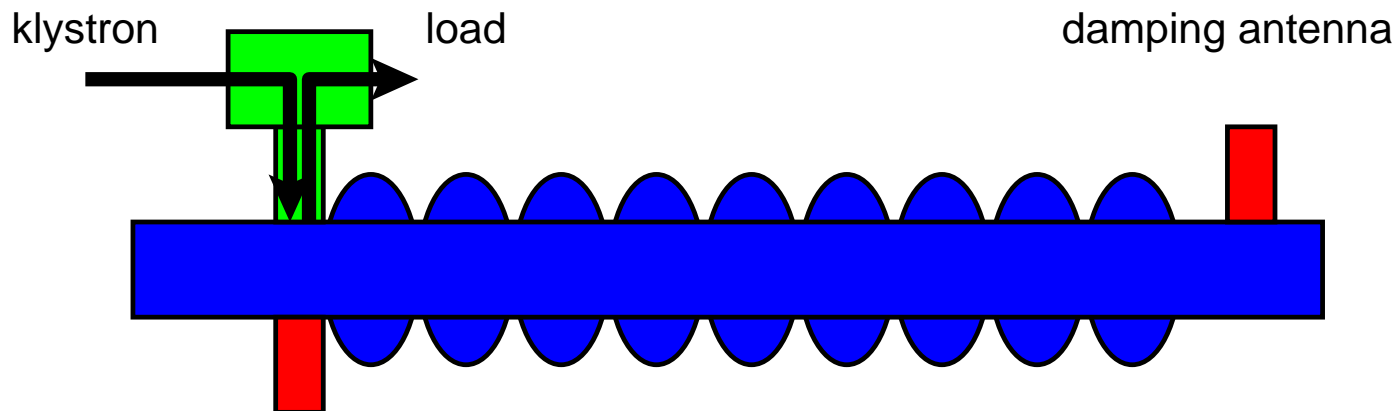

Travelling Wave Structures

- The power is feed into one end
 - no reflection if designed properly
- It slowly moves through the structure
 - group velocity is typically a few percent of the speed of light

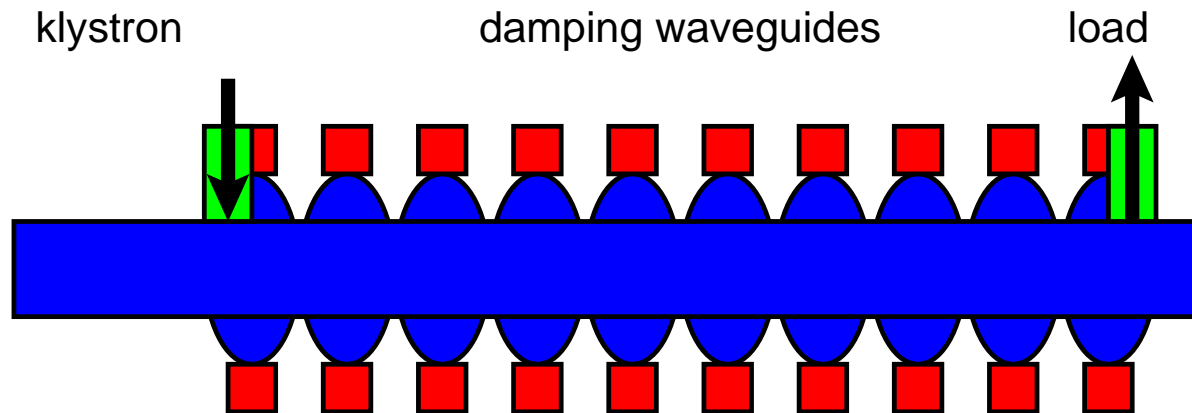

Choice of Structure Design

- In a super-conducting structure the beam current is small
 - little power is extracted but over long times
 - natural choice is standing wave structures, to avoid all the power draining out at the end
 - no need to compensate extraction of energy along the structure
- For a normal conducting structure all four options (constant impedance/constant gradient and standing/travelling wave) could be used
 - for CLIC travelling wave, constant gradient structures have been chosen
 - travelling wave structures avoid recirculators to keep the energy in the structures
 - constant gradient allows to reach higher effective gradients

Choice of Frequency

- Obviously the frequency choice differs
 - CLIC: 12 GHz
 - ILC: 1.3 GHz
- So what drives the choice?
- ILC uses super-conducting structures
 - high frequencies lead to higher surface resistance
 - high frequencies lead to higher wakefield amplitudes $W_L \propto f^2$, $W_{\perp} \propto f^3$
 - a very low frequency makes the structures expensive (dimension $\propto \lambda$)

⇒ so a frequency with existing power sources has been picked
- CLIC uses normal-conducting structures
 - higher frequencies help in reaching high gradients
 - but also lead to higher wakefields

⇒ full optimisation of the design has been performed to achieve the lowest cost for a fixed energy and luminosity target

RF Power Generation



Klystron

- Usually the input RF power for the accelerating structures is provided by klystrons
- In ILC klystrons are used to directly power the main beam
- In CLIC they power the drive beam accelerator
 - would be difficult in main linac
- Klystrons tend to be more efficient at low frequencies and long pulses
 - perfect for ILC (1.3 GHz, 1.5 ms) and the CLIC drive beam accelerator (1 GHz and 140 μ s)

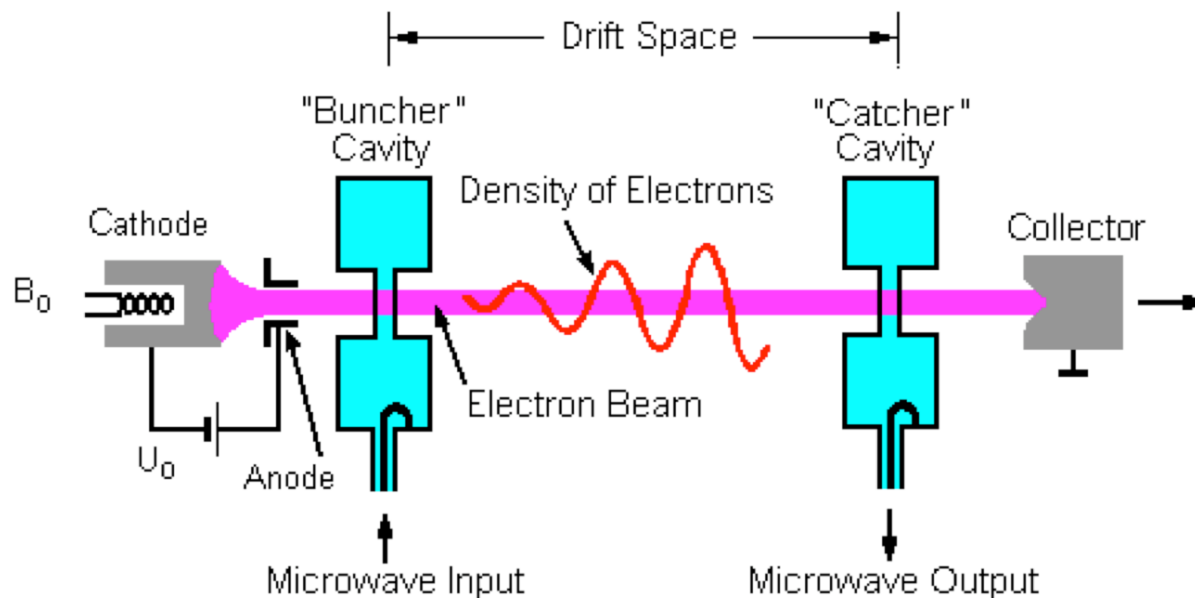

Drive Beam (CLIC)

- In CLIC power is produced by a high current drive beam (100A)
 - decelerated in a low impedance structure
- Beam loading is used for acceleration

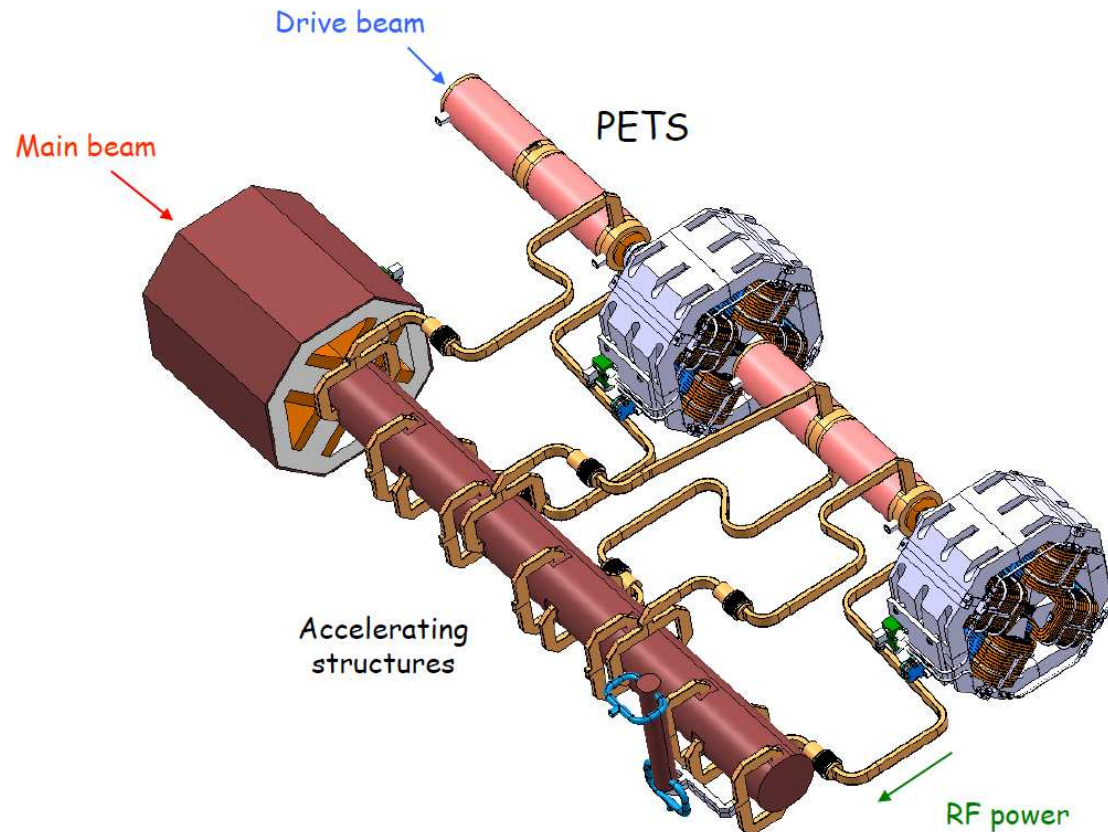

PETS

Assembly of the eight PETS bars.

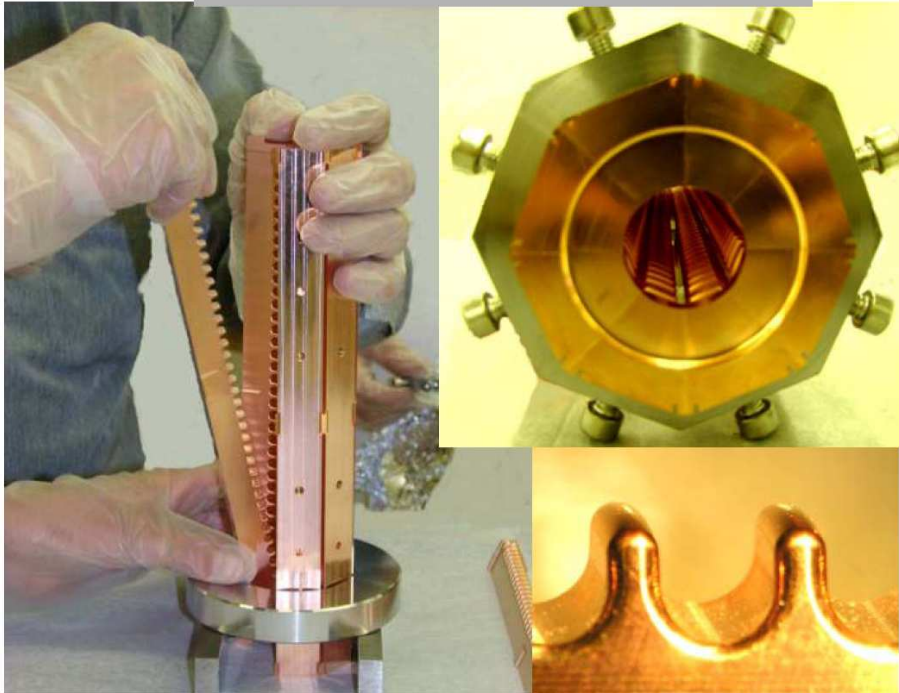

Power Efficiency



Coordinate Systems

- We use two frames, the laboratory frame and the beam frame
- The nominal direction of motion of the beam is called s in the laboratory frame, the beam moves toward increasing s
- The same direction is called z in the beam frame, with smaller z moving ahead of particles with larger z
- A particle preserves its longitudinal position within the beam
- The transverse dimensions are x in the horizontal and y in the vertical plane, in both coordinate systems
- People use different systems so find out what they talk about

Power Consumption

- Power consumption of the main linac is a prime consideration
 - electricity cost
 - equipment cost

- Examples of total beam power

- ILC

$$P_{beam} = 2n_b f_r N E \approx 22 \text{ MW}$$

- CLIC

$$P_{beam} \approx 28 \text{ MW}$$

- Wall plug power can be transformed into RF power with limited efficiency
- The efficiency of transforming RF power into beam power depends on
 - structure design
 - the gradient
 - the beam parameters
- The structures need to be cooled (especially in a super-conducting machine)

RF to Beam Power Efficiency

- Efficiency is

$$\eta_{RF \rightarrow beam} = \frac{\tau_{beam}}{\tau_{beam} + \tau_{fill}} \cdot \frac{P_{beam}}{P_{beam} + P_{loss} + P_{out}}$$

- RF pulse needs to be longer than beam pulse in order to fill the structures with energy before the beam arrives
- In a super-conducting cavity
 - little RF power is lost in the walls during the pulse
 - but the cooling requires some significant overhead
 - some cooling is also needed against heating from the environment
- In normal conducting structures
 - A significant fraction of the RF power is lost into the walls
 - some power will be draining out of the travelling wave structure (usually)

RF Pulse Length

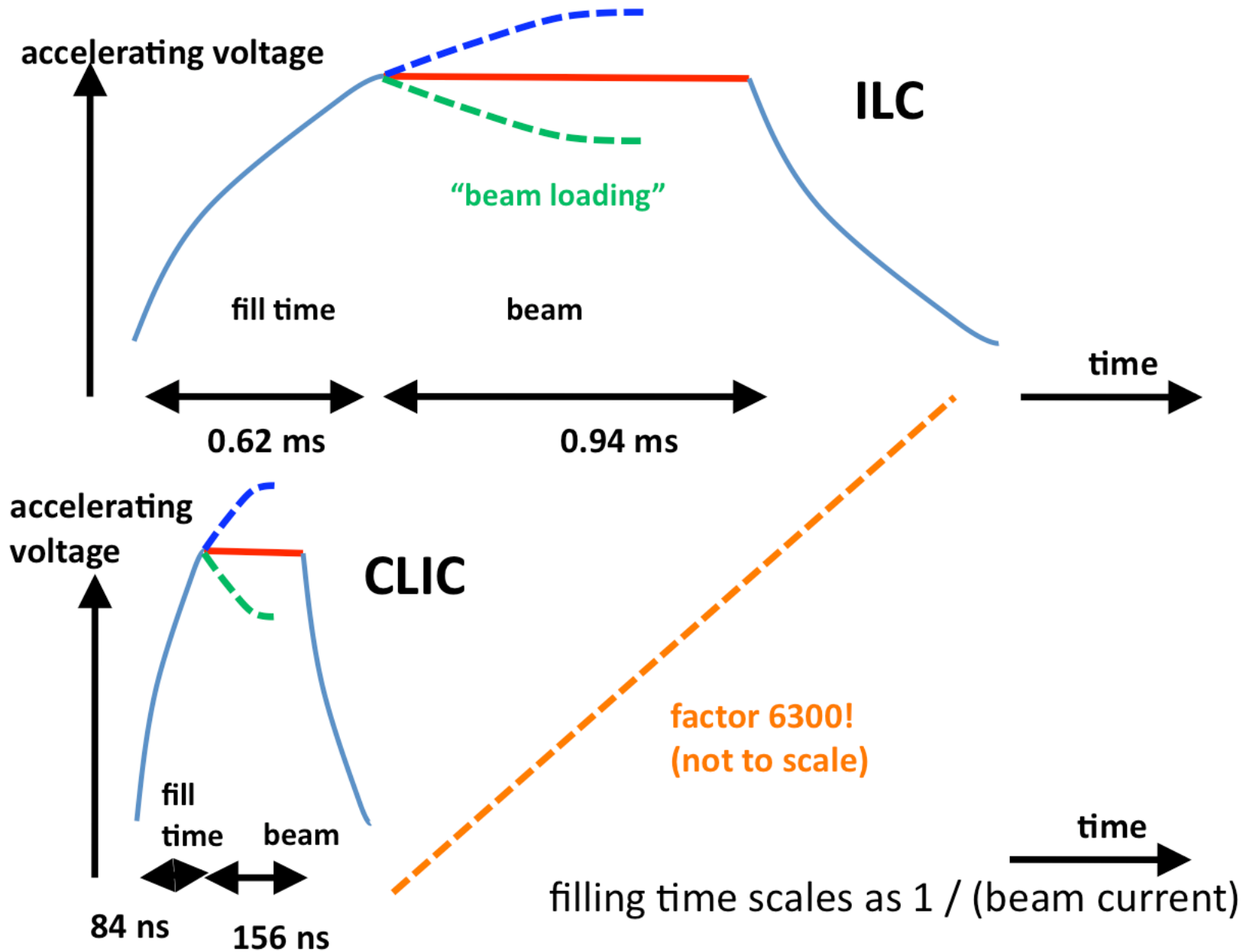

Passage of a Particle

- A particle in the structure will

⇒ extract energy (depending on energy in structure)

- induce electromagnetic wakefields

⇒ cosine-like longitudinal (monopole) and sine-like transverse (dipole) modes

⇒ the wakefield does not depend on the energy in the structure

- Analytic longitudinal wake

$$W_L(z \rightarrow 0) = \frac{Z_0 c}{\pi a^2}$$

- For larger distances one has to perform simulations

- Analytic transverse wake

$$W_{\perp}(z \rightarrow 0) = \frac{4Z_0 c}{\pi a^4} z$$

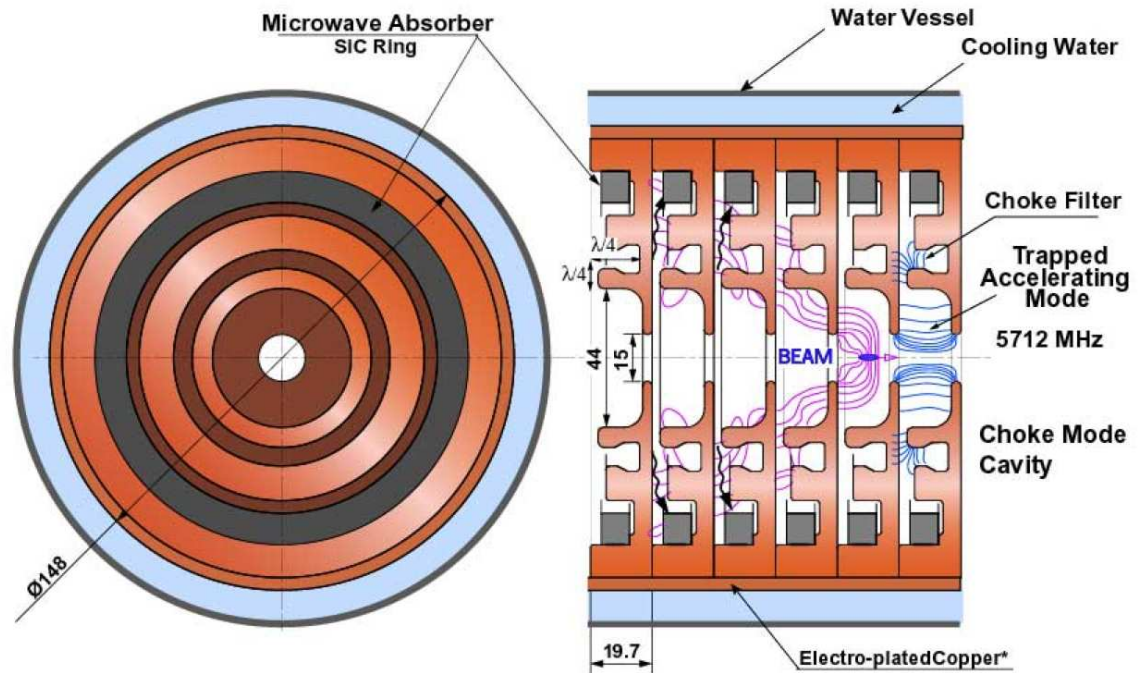

Power Loss: Shunt Impedance

- We calculate the power loss in the walls for the flat top of the pulse
 - can think of steady state
- The RF experts have defined a variable R' , the shunt impedance per unit length, as

$$R' = \frac{\text{effective gradient}^2}{\text{ohmic power loss per unit length}} = \frac{G^2}{P'}$$

this allows to easily determine the power lost in the walls of a structure of length L as a function of the acceleration

$$P'(s) = \frac{G^2(s)}{R'(s)}$$

- The value of R depends on two things
 - the geometry
 - the resistivity of the material
- R relates the power lost in the walls to the gradient

Power Loss: Shunt Impedance (cont.)

- The RF experts have also defined another variable Q

$$Q = \frac{\text{stored energy}}{\text{ohmic power loss per radian of RF circle}} = \frac{E'}{P'}\omega$$

this allows to easily write the decay of the energy due to ohmic losses

$$E'(t) = E'_0 \exp(-\omega t/Q)$$

- The value of Q depends on two things
 - the geometry
 - the resistivity of the material
- Q relates the stored energy and the power lost in the walls

Power Loss: Shunt Impedance (cont.)

- We can simply calculate R'/Q

$$R' = \frac{\text{effective gradient}^2}{\text{ohmic power loss per unit length}} = \frac{G^2}{P'}$$

$$Q = \frac{\text{stored energy}}{\text{ohmic power loss per radian of RF circle}} = \frac{E'}{P'\omega}$$

- This yields

$$(R'/Q) = \frac{G^2}{P'} \frac{P'}{E'\omega} = \frac{G^2}{E'\omega}$$

so one can calculate

$$E' = \frac{G^2}{(R'/Q)\omega}$$

⇒ So the structure geometry defines R'/Q and does not depend on the material

⇒ While Q depends mainly on the material

Power Loss: Local Loss

- Power loss in the walls

$$P'_{loss} = \frac{\omega}{Q} E' = \frac{\omega}{Q} \frac{G^2}{(R'/Q)\omega} = \frac{G^2}{R'}$$

power given to the beam

$$P'_{loss} = IG$$

The ratio is

$$\frac{P'_{beam}(s)}{P'_{wall}(s)} = \frac{R'(s)I}{G(s)}$$

⇒ higher efficiency at lower gradient G

⇒ higher efficiency at higher current I

⇒ higher efficiency at higher shunt impedance R'

- For standing wave $P_{out} = 0$, so we are done
 - but travelling wave needs more work

Wakefield and Power Extraction

- Why can a wakefield model be used for the beam loading?

- i.e.

$$\Delta G(q) = \text{const } q$$

- The energy stored per unit length in the accelerating structure is

$$E' = \frac{G^2}{(R'/Q)\omega}$$

- The reduction of accelerating field due to the passing charge q is $-\Delta G$
- This yields for the energy lost by the structure

$$\Delta E'_{lost} = \frac{G^2 - (G - \Delta G)^2}{(R'/Q)\omega} \Rightarrow \Delta E'_{lost} = \frac{2G\Delta G - (\Delta G)^2}{(R'/Q)\omega}$$

- The beam extracts an energy

$$\Delta E'_{beam} = q \left(G - \frac{1}{2}\Delta G \right)$$

hence

$$q \left(G - \frac{1}{2}\Delta G \right) = \frac{2G\Delta G - (\Delta G)^2}{(R'/Q)\omega}$$
$$\Rightarrow \Delta G = \frac{(R'/Q)\omega}{2} q$$

⇒ The gradient change depends only on the charge not the initial gradient, as expected

- Note: I simplified a bit (sorry, but this is easier with cheating)

Constant Impedance vs. Constant Gradient

- In a travelling wave structure, the beam extracts energy during its passage
 - ⇒ the gradient will be lower at the end of the structure
- This can be avoided by reducing the iris radius along the structure (tapering)
 - the smaller irises produce more gradient per power flowing through them
- An additional difference exists for the long-range transverse wakefields
 - in a constant impedance structure one strong wakefield mode exists
 - in a tapered structure many small modes exist which reduces the effective wakefield

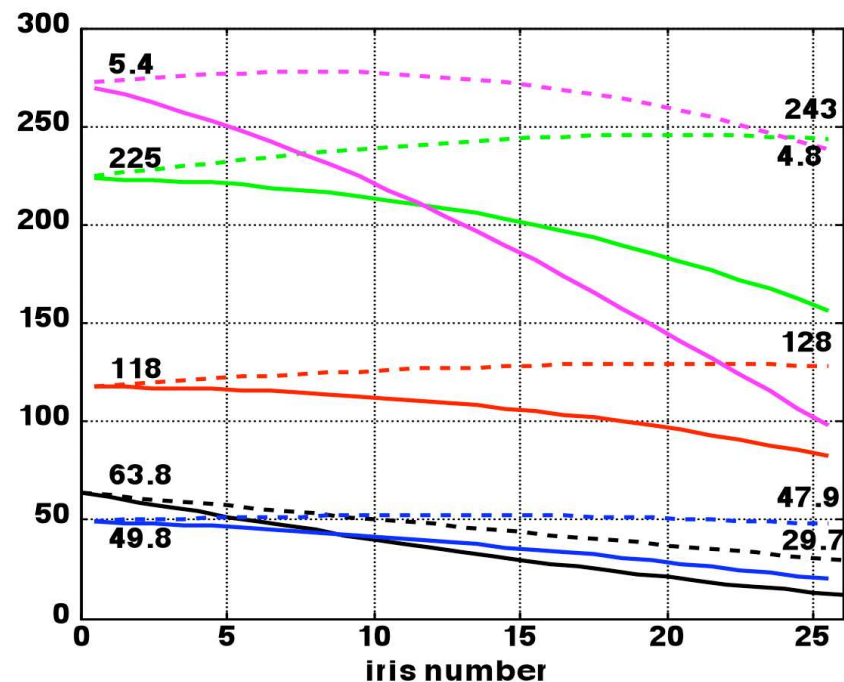

Beam Loading in Travelling Wave Structure

- Consider constant impedance
- Field induced by passing bunch is moving forward
 - as is external RF
- ⇒ beam loading fields build up along the structure
- The RF loses power in the wall
- ⇒ The gradient decreases along the structure

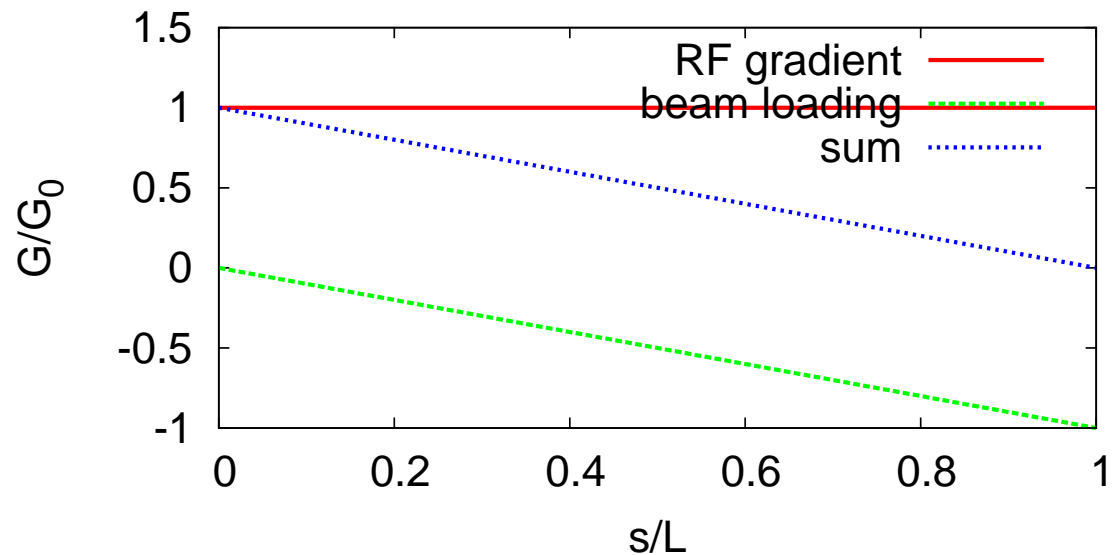
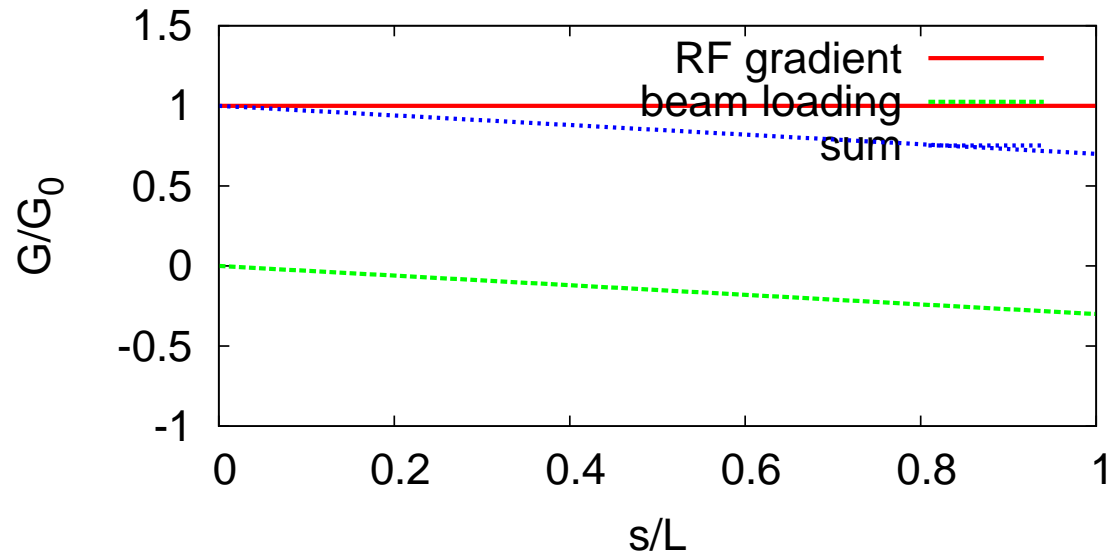
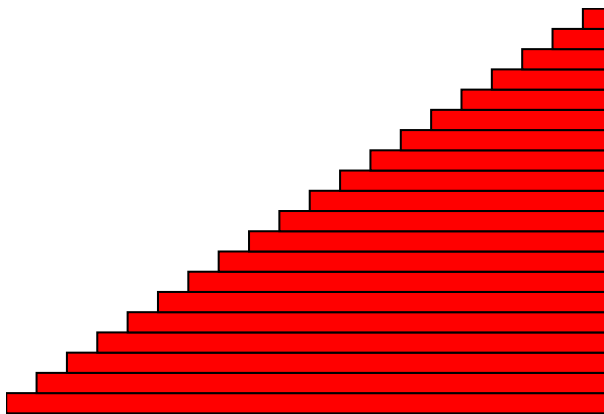

Structure Tapering

- By decreasing the along the structure iris radius the local R/Q increases
- ⇒ The unloaded gradient increases along the structure
- ⇒ The loaded gradient remains constant
- In practice we have to ensure that the RF constraints are fulfilled in each cell
- Note: beam loading could reduce breakdown rate

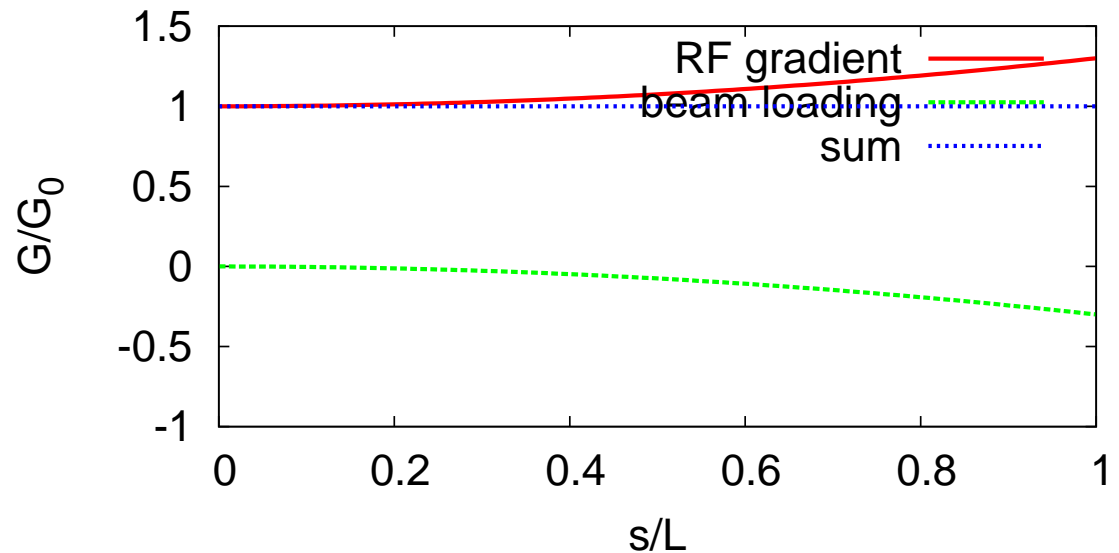

- Note: in CLIC about 20% of the RF power are lost in the loads during the flat top

Beam Loading Compensation

- Constant impedance example with losses into the walls
 - The first bunch sees no beam loading
- ⇒ We need to shape the RF pulse accordingly

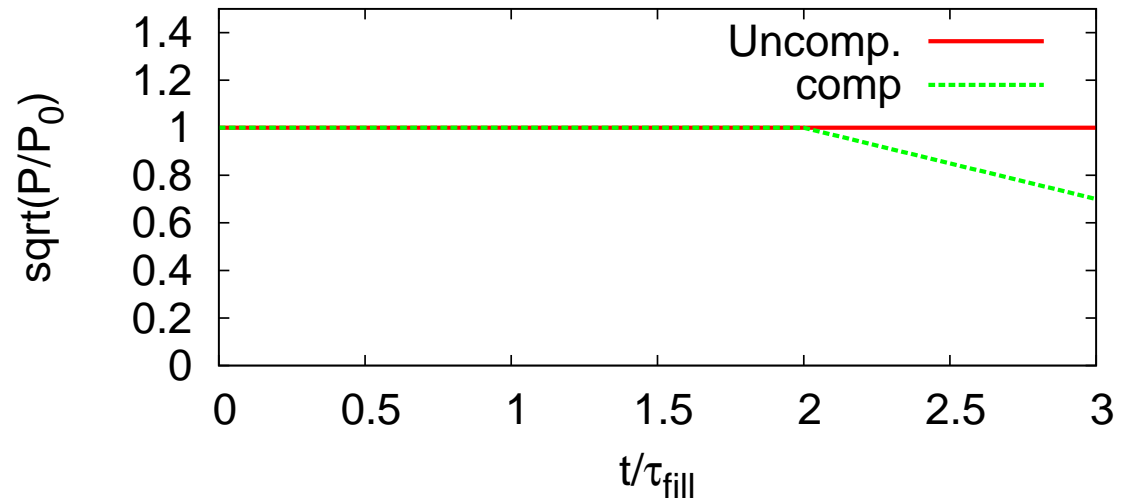
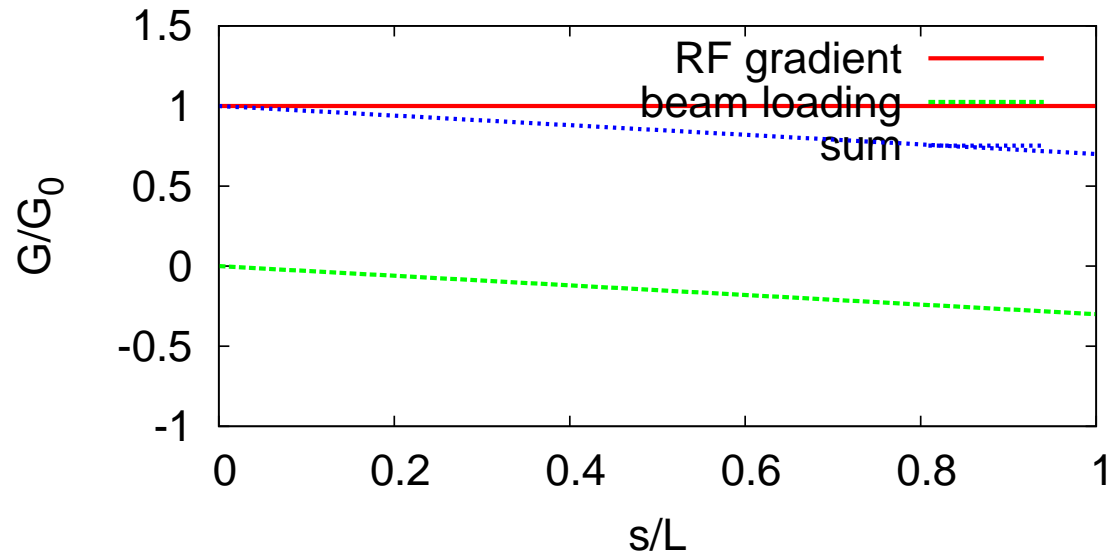

Culprits for the Parameters

- The structure design provides

$$\left(\frac{R}{Q}\right)$$

if we scale all dimensions of a structure this parameters does not change
Energy in the structure (same gradient)

$$E \propto \lambda^3$$

the stored energy per structure is reduced as λ^3/λ_0^3

the energy gain is reduced due to the shorter cell structure L

$$\frac{R}{Q}\omega = \frac{E}{(LG)^2}$$
$$\Rightarrow \frac{R}{Q} = \frac{(LG)^2}{E} \frac{1}{\omega} \propto \frac{\lambda^2}{\lambda^3} \frac{\lambda}{1}$$

one finds

$$(R/Q) = \text{const}$$

- The material, the frequency and to some extent the design can impact Q

RF to Beam Power Efficiency

parameter	CLIC	ILC
R'/Q	$\approx 11 \text{ k}\Omega/\text{m}$	$1.036 \text{ k}\Omega/\text{m}$
Q	≈ 6000	$\approx 10^{10}$
R'	$\approx 66 \text{ M}\Omega/\text{m}$	$\approx 10^7 \text{ M}\Omega/\text{m}$

• ILC: $I \approx 8.7 \mu\text{A}$

\Rightarrow

$$\frac{P'_{beam}}{P'_{wall}} \approx 2500$$

• CLIC: $I \approx 1.2 \text{ A}$

\Rightarrow

$$\frac{P'_{beam}}{P'_{wall}} \approx 0.8$$

- Efficiency is

$$\eta = \frac{\tau_{beam}}{\tau_{beam} + \tau_{fill}} \frac{P_{beam}}{P_{beam} + P_{loss} + P_{out}}$$

- Plugging in numbers for ILC

$$\eta = \frac{940 \mu\text{s}}{940 \mu\text{s} + 620 \mu\text{s}} \approx 0.6$$

- Plugging in numbers for CLIC

$$\eta = \frac{156 \text{ ns}}{156 \text{ ns} + 83 \text{ ns}} \cdot \frac{27 \text{ MW}}{27 \text{ MW} + 25 \text{ MW} + 12 \text{ MW}} \approx 0.65 \cdot 0.42 \approx 0.277$$

Remark: Drive Beam Accelerator

- High current at low gradient allows high efficiency

$$\frac{P'_{beam}}{P'_{wall}} = \frac{R'I}{G}$$

- Acceleration at low frequency is efficient
 - Q is high $Q \propto 1/\omega$
 - klystrons are efficient
- In CLIC $\eta \approx 97.5\%$ expected

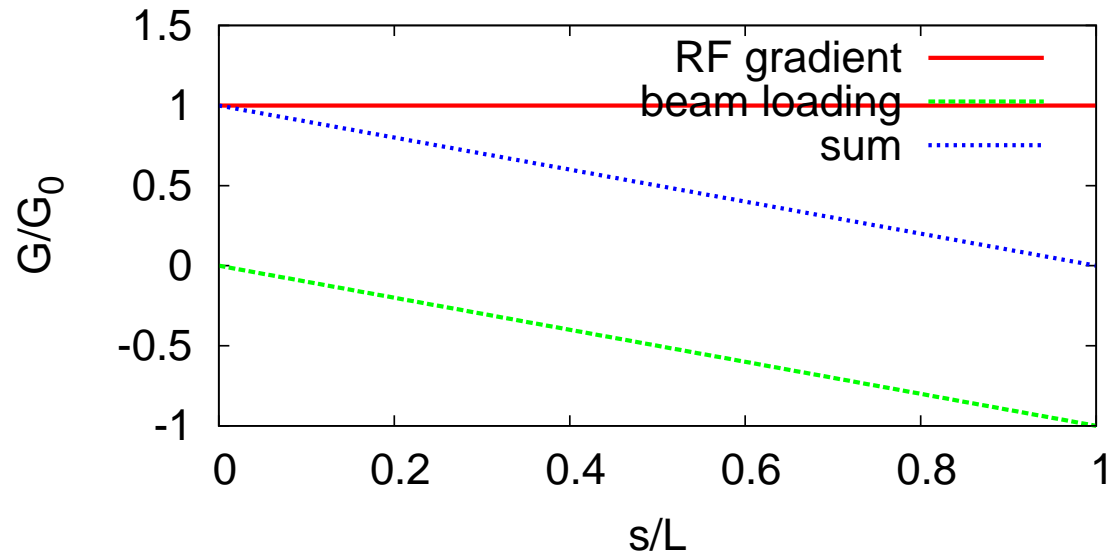

- Structure needs to be long enough not to have power leaking out

ILC Limiting Factors for Efficiency

- The transfer of RF to the beam is almost perfect during the pulse
- The main power consumption is for the cooling
 - to cool 1W at 2K requires about 700W

remember Carnot process, in best case

$$\frac{P_{cool}}{P_{source}} \geq \frac{T_2 - T_1}{T_1}$$

- Additionally a number of other sources exist
 - higher order modes induced by the beam
 - static losses through the cryostat

⇒ Cooling power is about twice the beam power (35 kW)

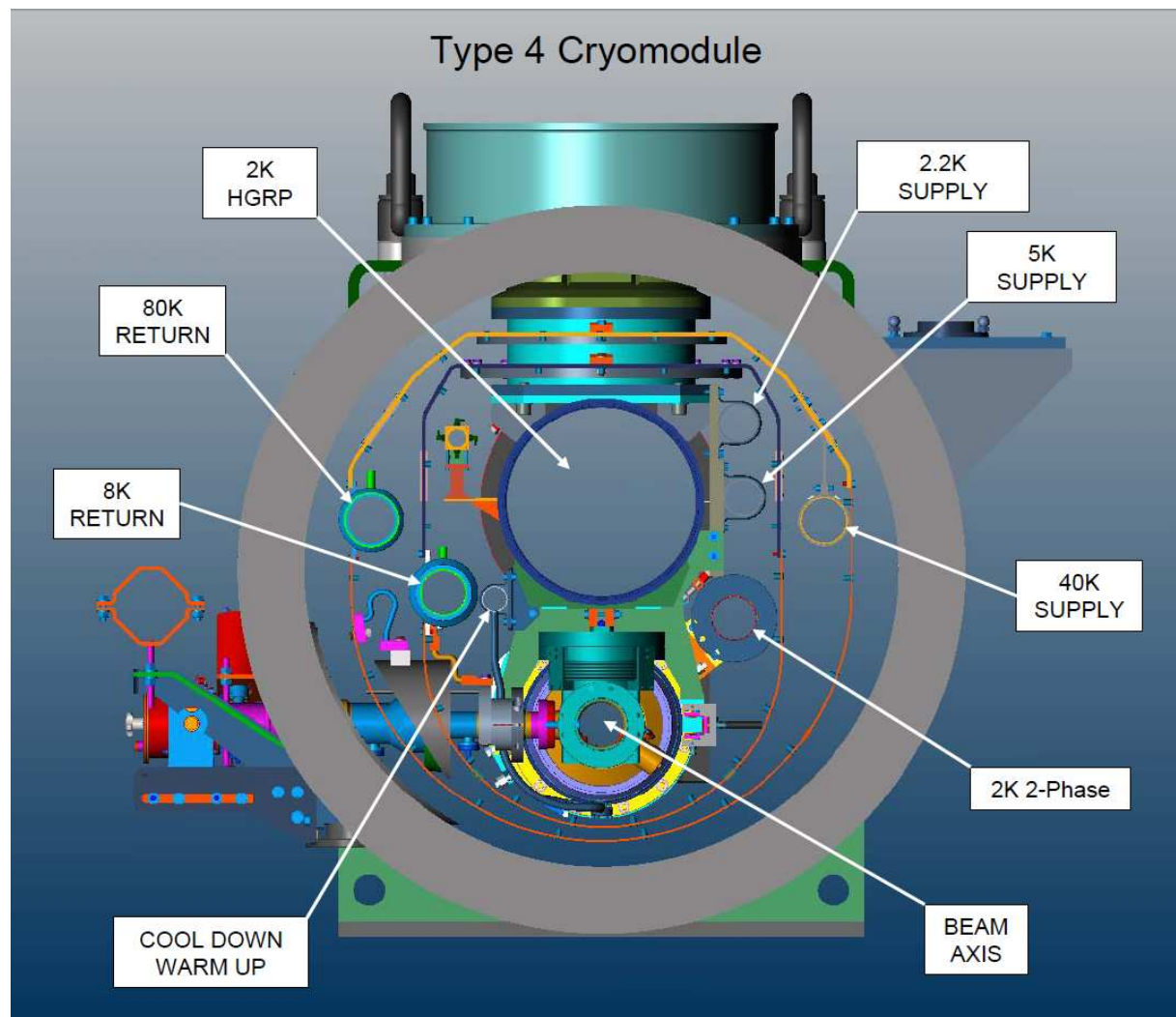

	40–80 K		5–8 K		2 K		Total
	Static	Dynamic	Static	Dynamic	Static	Dynamic	
Heat load (W)	177.6	270.3	31.7	12.5	5.1	29.0	
Installed power (kW)	4.4	6.2	9.6	3.5	8.1	28.5	60.4

CLIC Limiting Factors for the Efficiency

- A lower gradient G
 - leads to a longer main linac hence to higher cost
 - requires reducing the current
- A higher shunt impedance R'
 - leads usually to larger wakefields also in the transverse hence to a less stable beam
- A higher beam current I
 - leads to a less stable beam
- An optimisation can be performed of the whole machine
 - varying G and R' and adjusting the current to the highest possible value
 - selecting the best combination taking into account luminosity and cost
- This optimisation has indeed been performed for CLIC
 - ⇒ let us see which is the highest current for a given structure and gradient

Beam Parameters: Longitudinal Wake and Bunch Charge Limits



Wakefields and Bunch Length

- Aim for shortest possible bunch to reduce transverse wakefield effects
- Energy spread into the beam delivery system should be limited to about 1% full width or 0.35% rms
- Multi-bunch beam loading compensated by RF
- Single bunch longitudinal wakefield needs to be compensated
⇒ accelerate off-crest

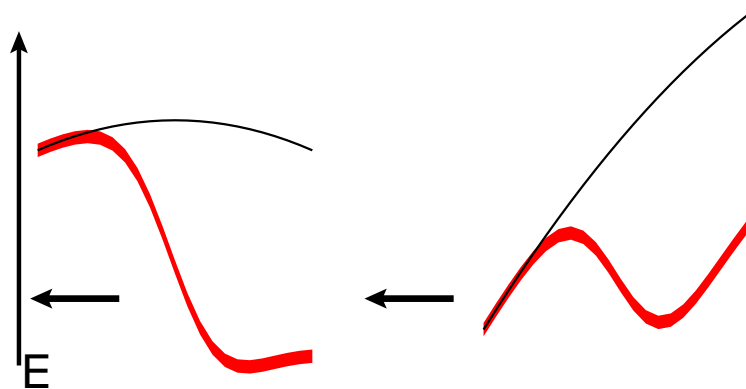

- Limit around average $\Delta\Phi \leq 12^\circ$
⇒ $\sigma_z = 44 \mu\text{m}$ for $N = 3.72 \times 10$

Specific Wakefields

- Longitudinal wakefields contain more than the fundamental mode
- We will use wakefields based on fits derived by Karl Bane

l length of the cell

a radius of the iris aperture

g length between irises

$$z_0 = 0.41a^{1.8}g^{1.6} \left(\frac{1}{l}\right)^{2.4}$$

$$W_L(z) = \frac{Z_0 c}{\pi a^2} \exp\left(-\sqrt{\frac{z}{z_0}}\right)$$

- Use CLIC structure parameters

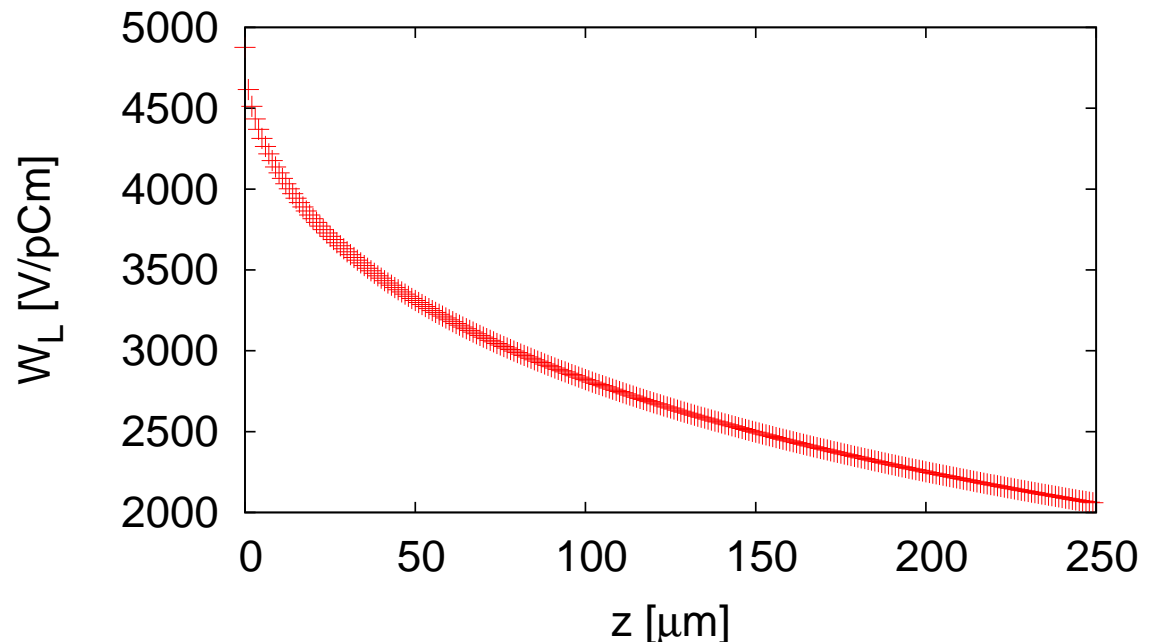

- Summation of an infinite number of cosine-like modes
 - calculation in time domain or approximations for high frequency modes

Energy Spread at End of Linac

- We use a constant RF phase along the linac

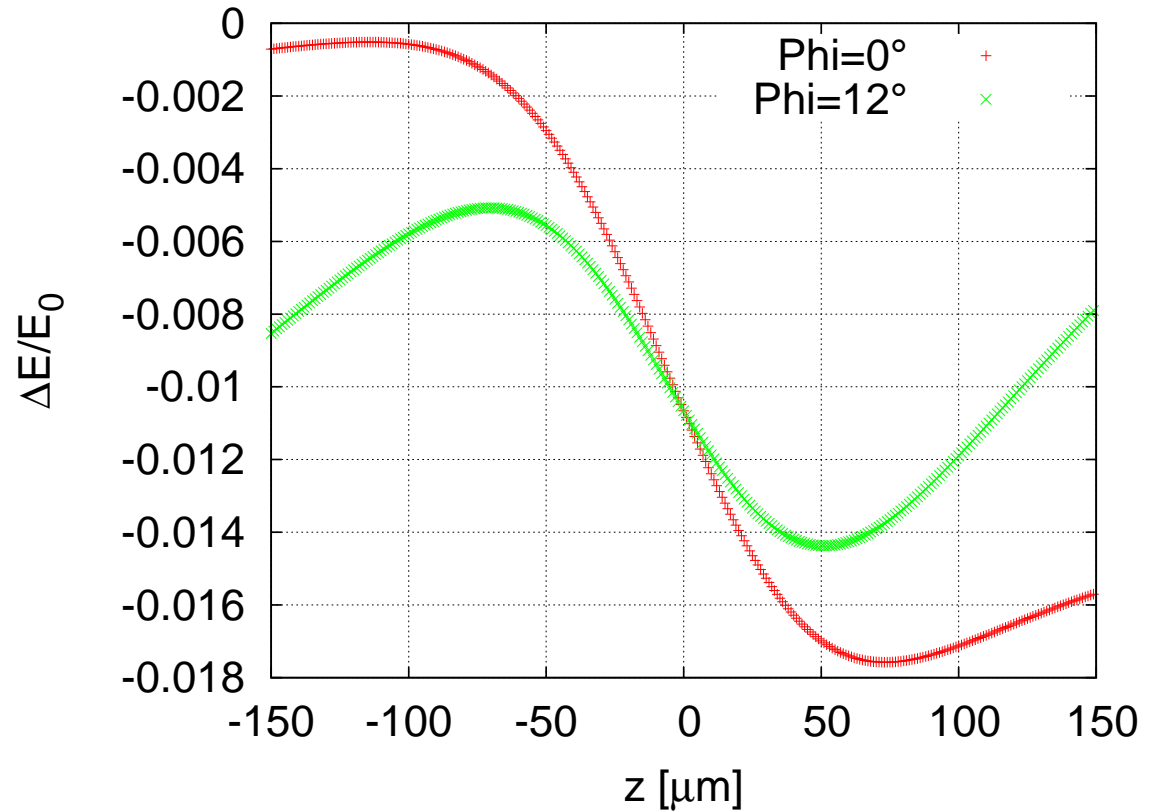

Recipe for Choosing the Bunch Parameters

- Decide on the average RF phase
 - OK, we fix 12°
 - smaller values give less bunch charge, larger values give more sensitivity to phase jitter
- Decide on an acceptable energy spread at the end of the linac
 - OK, we choose 0.35%
 - mainly from BDS and physics requirements
- Determine $\sigma_z(N)$
 - choose a bunch charge
 - vary the bunch length until the final energy spread is acceptable
 - choose next charge
- Determine which bunch charge (and corresponding bunch length) can be transported stably

Dependence of Energy Spread on Bunch Length

- For a given charge and phase the bunch length is varied

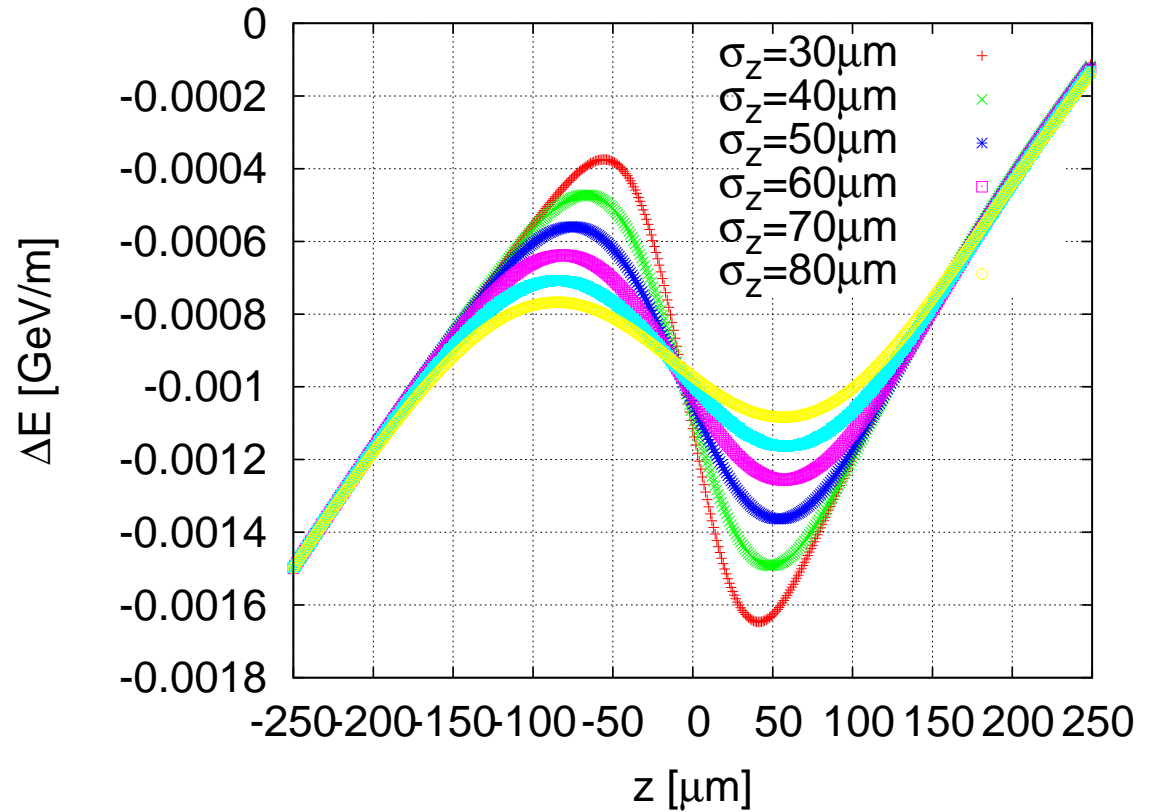

Energy Spread

- Three regions
 - generate
 - maintain
 - compress
- Configurations are named according to RF phase in section 2
- Trade-off in fixed lattice
 - large energy spread is more stable
 - small energy spread is better for alignment

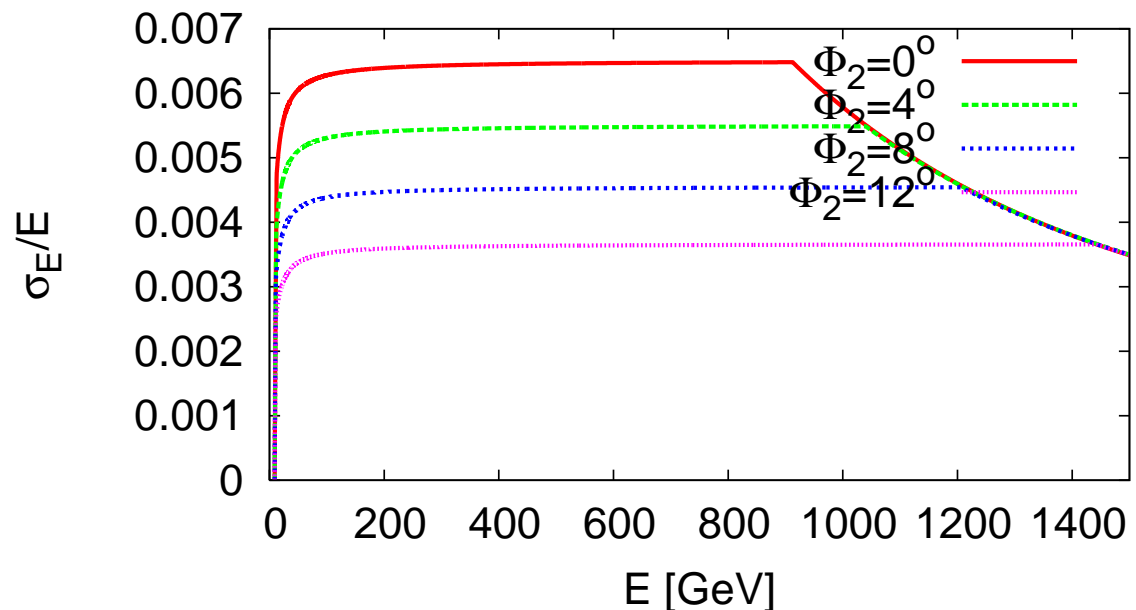
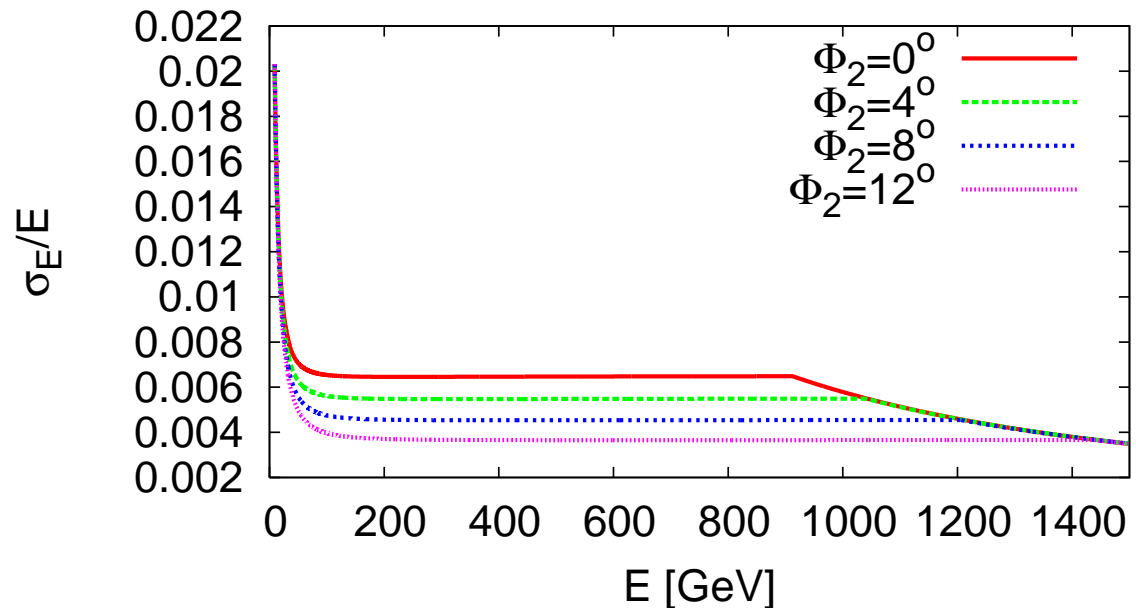

Beam Parameters: Beam Transport and Emittance

Know $\sigma_z(N)$ but current limit will depend on wakefields and lattice design, important problem



Emittance

- The beam particles do not have identical coordinates
 - they occupy some phase space

- According to Liouville theorem (from the Liouville equation)

$$\frac{d\rho}{dt} = \frac{\partial\rho}{\partial t} + \sum_{i=1}^N \left[\frac{\partial\rho}{\partial q_i} \dot{q}_i + \frac{\partial\rho}{\partial p_i} \dot{p}_i \right] = 0$$

the density in phase space around a trajectory remains constant in an unperturbed system

- For some reason particles are conventionally not described by (x, y, z, p_x, p_y, p_z) but by (x, y, z, x', y', E)

⇒ in this representation the “phase space” changes

- We use the emittance to describe the phase space volume
 - geometric emittance is the actual size in $x x'$ and changes with acceleration
 - the normalised emittance is size in $x x'$ for $\gamma = 1$ and is constant

Why is the Emittance Important?

- The luminosity can be written as

$$\mathcal{L} = H_D \frac{N^2 n_b f_r}{4\pi \sigma_x^* \sigma_y^*}$$

H_D a factor usually between 1 and 2, due to the beam-beam forces

N the number of particles per bunch

n_b the number of bunches per beam pulse (train)

f_r the frequency of trains

σ_x^* and σ_y^* the transverse dimensions at the interaction point

- We will see that $\sigma_{x,y}$ can be written as the function of two parameters

$$\sigma_{x,y} = \sqrt{\frac{\beta_{x,y} \epsilon_{x,y}}{\gamma}}$$

$\epsilon_{x,y}$ is the normalised emittance, a beam property

$\beta_{x,y}$ is the beta-function, a lattice property

Main Linac Emittance Growth

- The vertical emittance is most important since it is much smaller than the horizontal one (10 nm vs. 600 nm, 24 nm vs. 8400 nm)
- For a perfect implementation of the machine the main linac emittance growth would be negligible
- Two main sources of emittance growth exist
 - static imperfections
 - dynamic imperfections
- The emittance growth budget is 5 nm for static imperfections
 - i.e. 90% of the machines must be better
- For dynamic imperfections the budget is 5 nm
 - but short term fluctuation must be smaller to avoid problems with luminosity tuning

Low Emittance Transport Challenges

- Static imperfections

 - errors of reference line, elements to reference line, elements. . .

 - excellent pre-alignment, lattice design, beam-based alignment, beam-based tuning

- Dynamic imperfections

 - element jitter, RF jitter, ground motion, beam jitter, electronic noise, . . .

 - lattice design, BNS damping, component stabilisation, feedback, re-tuning, re-alignment

- Combination of dynamic and static imperfections can be severe

- Lattice design needs to balance dynamic and static effects

Guiding the Beams: Quadrupoles

- The focusing is provided by quadrupoles
- They focus in one plane but defocus in the other planes
 - octapoles would focus in x and y but defocus in the planes at 45°
 - also their magnetic field is not linear

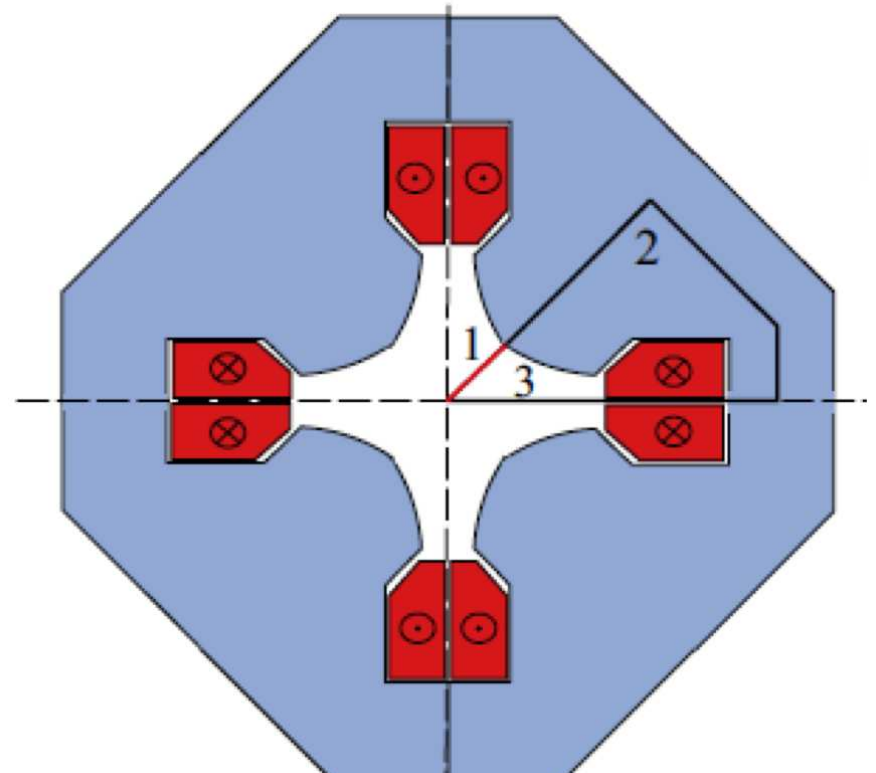
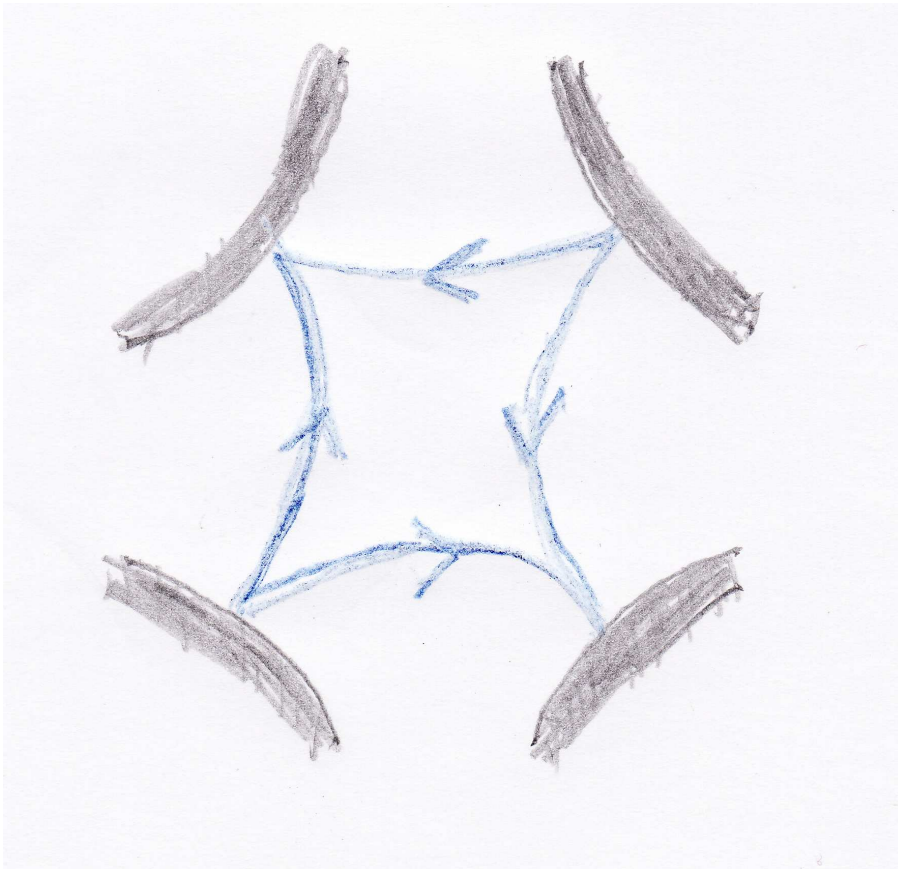
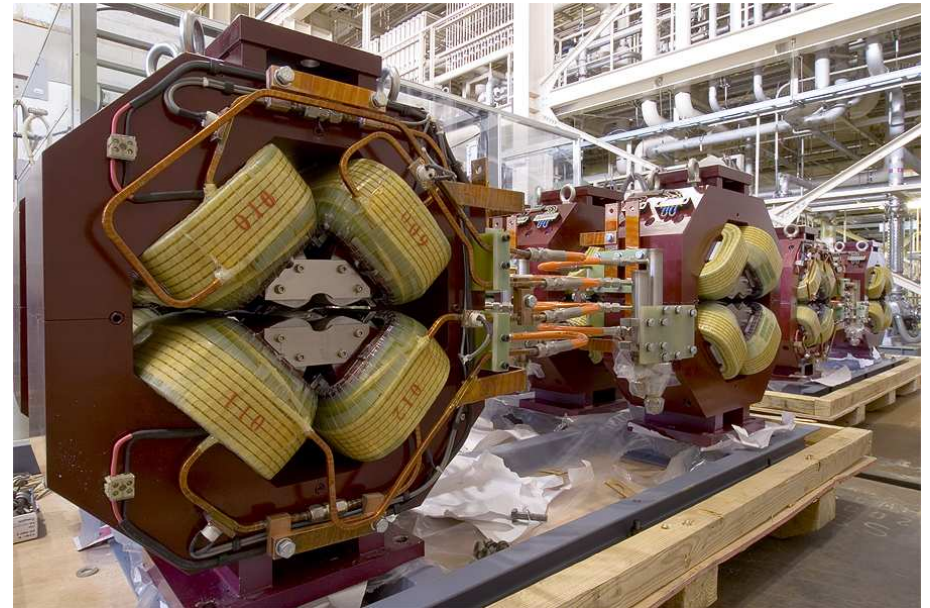

FODO Lattice

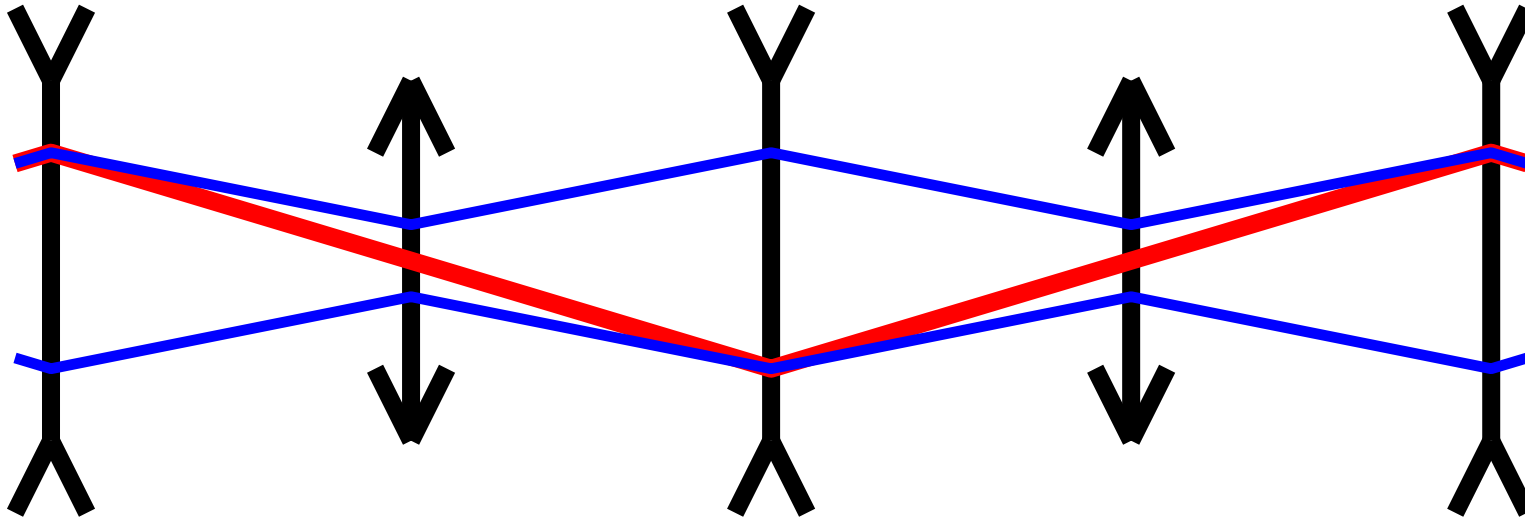

- Focusing is achieved by alternating focusing and defocusing quadrupoles

CLIC Lattice Design

- Used $\beta \propto \sqrt{E}$, $\Delta\Phi = \text{const}$
 - balances wakes and dispersion
 - roughly constant fill factor
 - phase advance is chosen to balance between wakefield and ground motion effects
- Preliminary lattice
 - made for $N = 3.7 \times 10^9$
 - quadrupole dimensions need to be confirmed
 - some optimisations remain to be done
- Total length 20867.6m
 - fill factor 78.6%

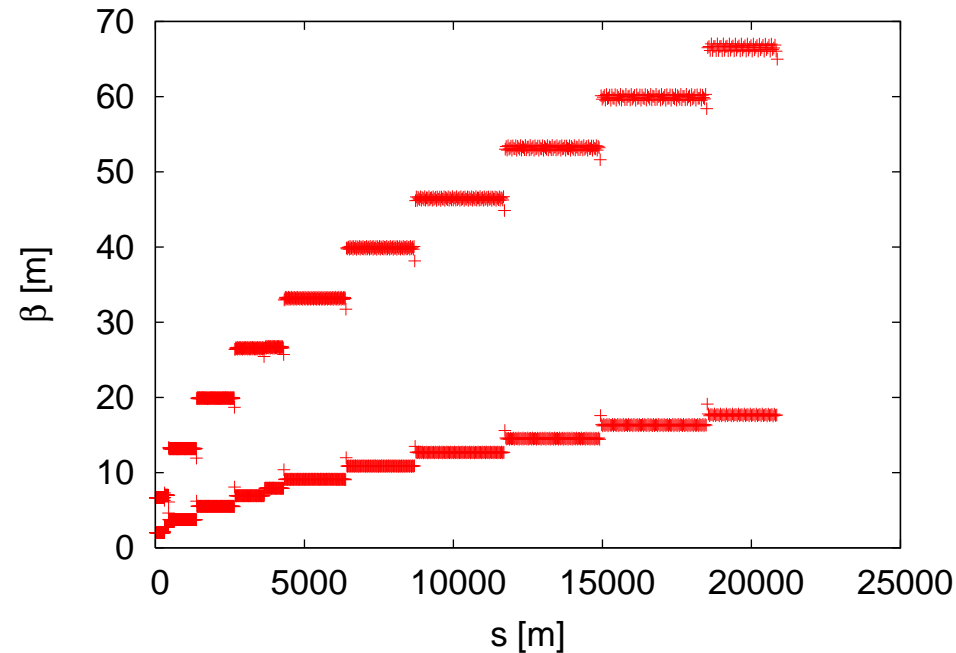

- 12 different sectors used
- Matching between sectors using 7 quadrupoles to allow for some energy bandwidth

ILC Lattice

- In the ILC constant quadrupole spacing is chosen
- The phase advance per cell is constant
- The phase advance is different in the two planes
 - reduces some coupling effects between the two planes

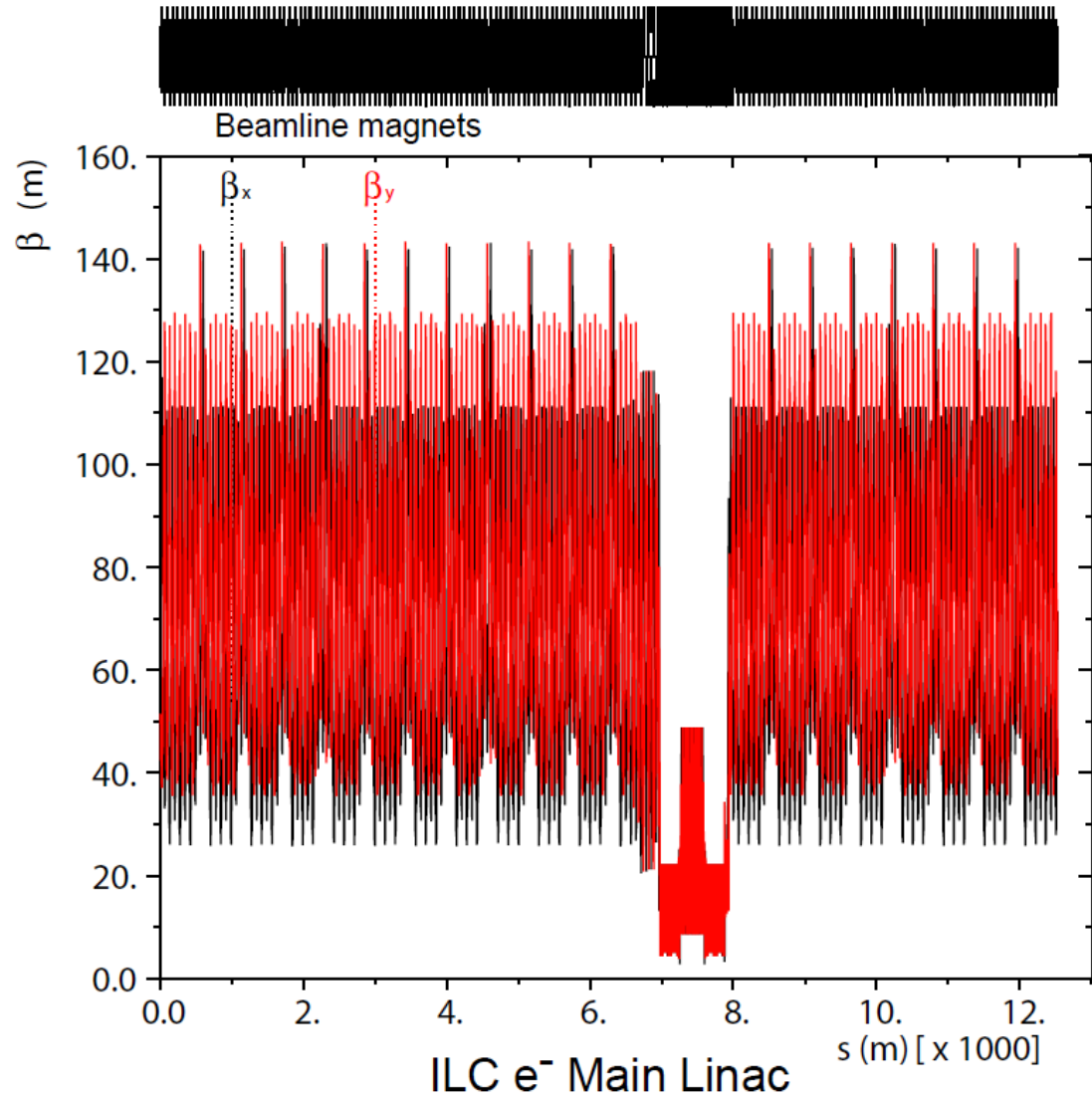
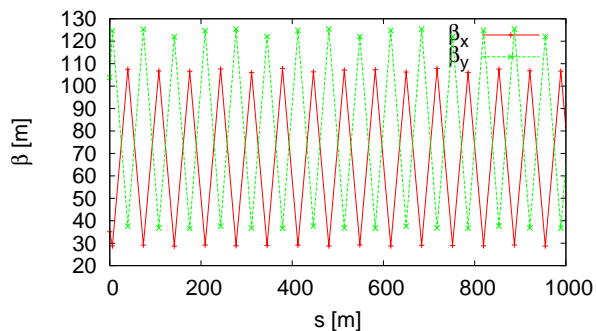

Hill's Equation and Beta-Functions

- In many interesting cases the particle motion can be described by Hill's equation

$$x''(s) + K(s)x(s) = 0$$

The solutions for this equation can be formulated as

$$x(s) = \sqrt{\epsilon\beta(s)} \cos(\phi(s) + \phi_0)$$
$$x'(s) = \sqrt{\frac{\epsilon}{\beta(s)}} \left[\frac{\beta'}{2} \cos(\phi(s) + \phi_0) - \sin(\phi(s) + \phi_0) \right]$$

where

$$\phi(s) = \int_0^s \frac{1}{\beta(s')} ds'$$

and β has to fulfill

$$\frac{\beta''\beta}{2} - \frac{\beta'^2}{4} + K\beta^2 = 1$$

- The solution can be easily verified
- It depends partially on the particle (ϵ , ϕ_0) and partially on the lattice (β)

Phase Space Representation

$$x(s) = \sqrt{\epsilon\beta(s)} \cos(\phi(s) + \phi_0) \quad \times$$

$$x'(s) = \sqrt{\frac{\epsilon}{\beta(s)}} \left[\frac{\beta'}{2} \cos(\phi(s) + \phi_0) - \sin(\phi(s) + \phi_0) \right]$$

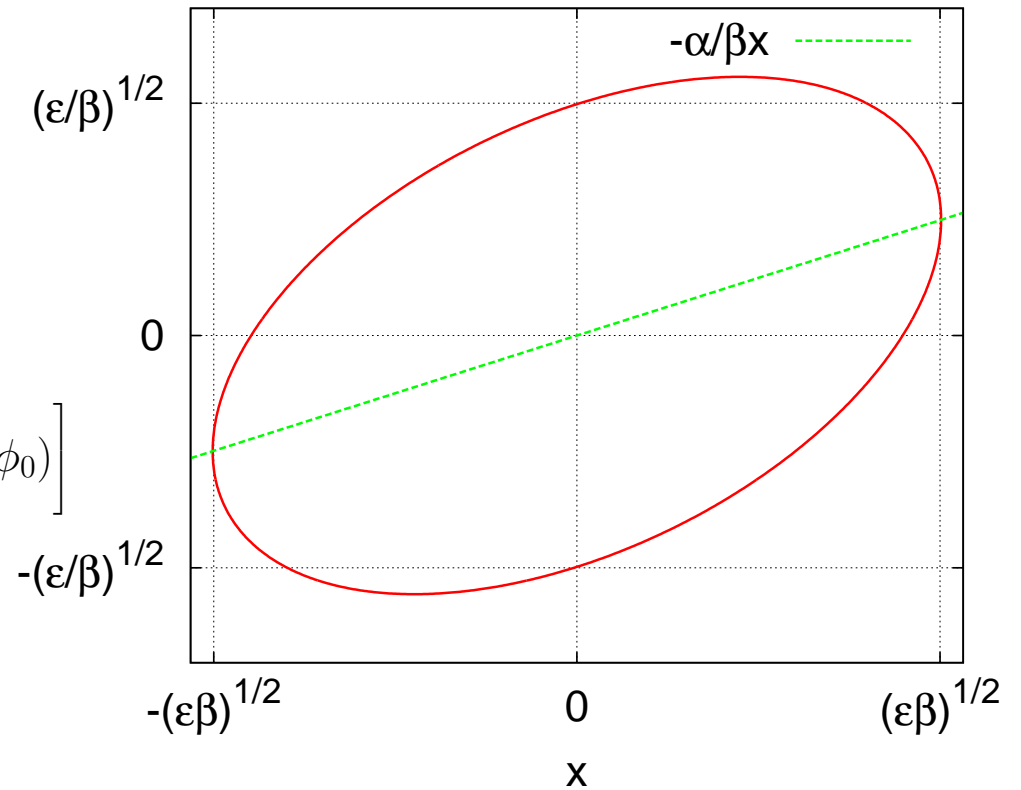

Beam Parameters: Transverse Wakefields and Beam Break-up



Example of Single Bunch Transverse Wakefield (CLIC)

Fit obtained by K. Bane
For short distances the wakefield rises linear
Summation of an infinite number of sine-like modes with different frequencies

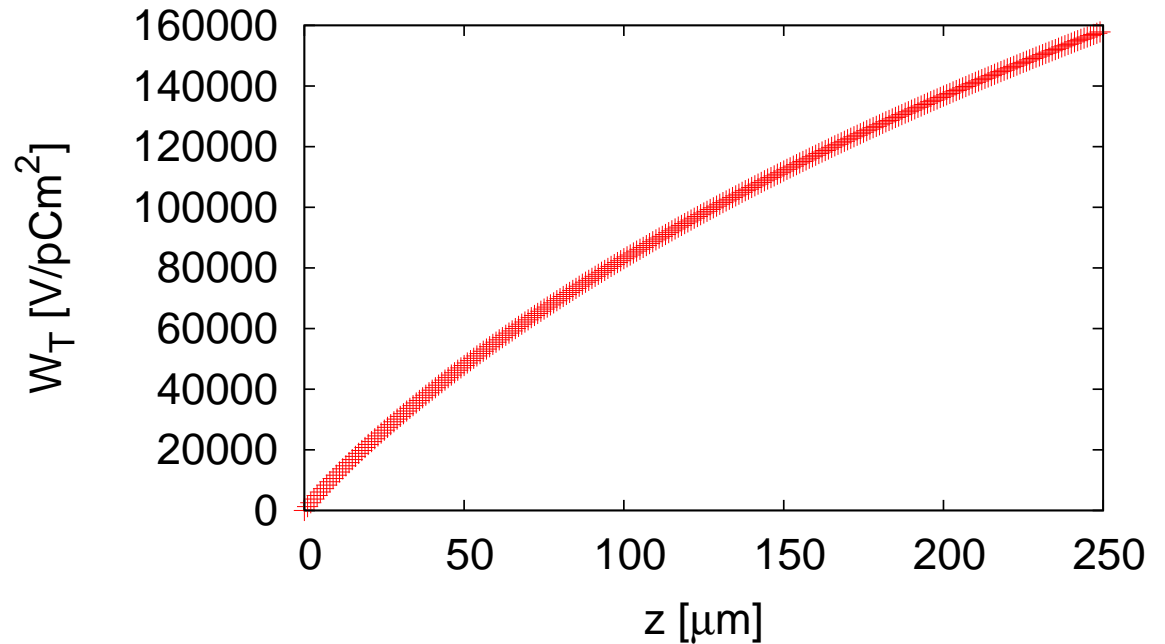

$$z_0 = 0.169a^{1.79}g^{0.38}\left(\frac{1}{l}\right)^{1.17}$$
$$W_{\perp}(z) = 4\frac{Z_0cz_0}{\pi a^4}\left[1 - \left(1 + \sqrt{\frac{z}{z_0}}\right)\exp\left(-\sqrt{\frac{z}{z_0}}\right)\right]$$
$$W_{\perp}(z \ll z_0) \approx 4\frac{Z_0cz}{\pi a^4}$$

Beam Stability

- Transverse stability of a beam with initial offset of σ_y
 - no energy spread assumed in the beam
 - emittance with respect to the beam axis is shown
- ⇒ acceptable for ILC (top)
- ⇒ would be intolerable for CLIC (bottom)

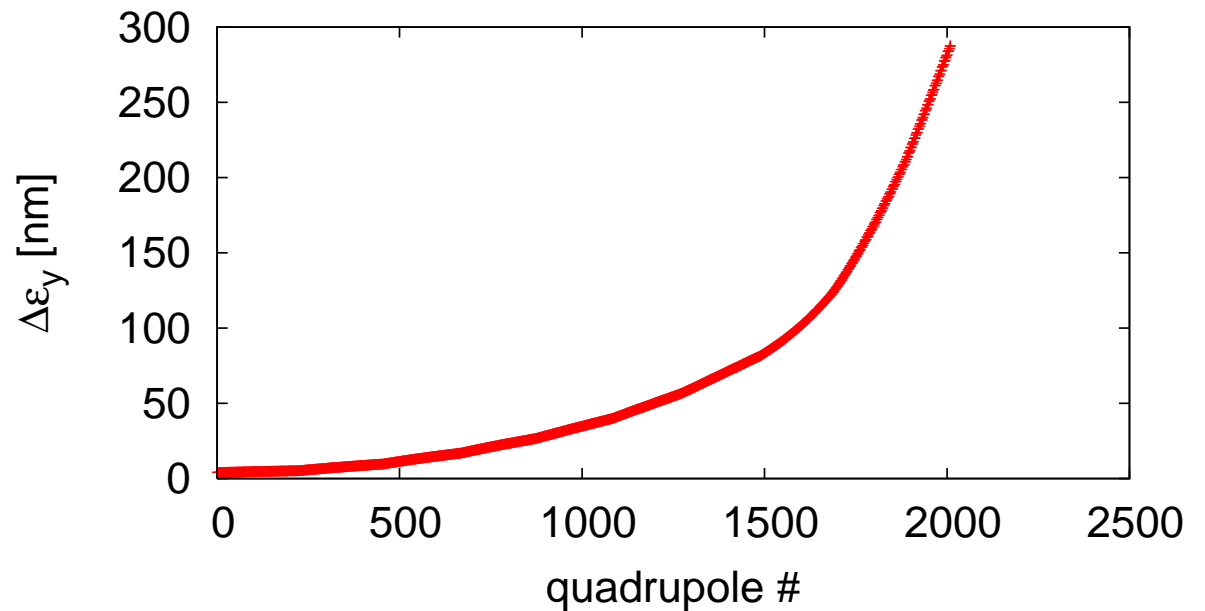
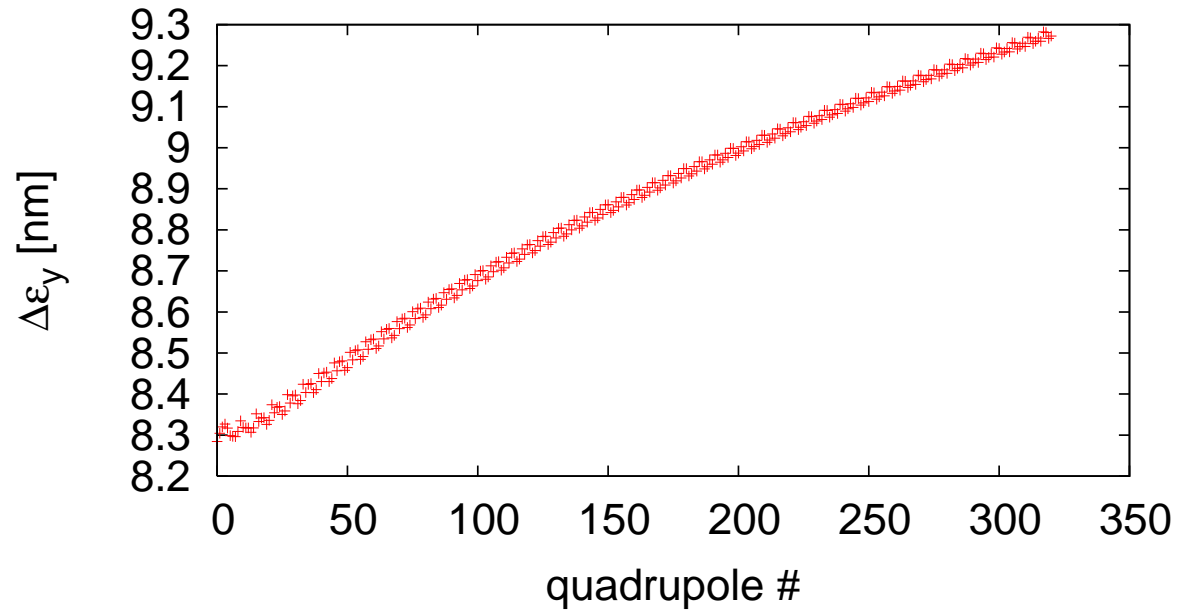

Achieving Beam Stability

- Transverse wakes act as defocusing force on tail
⇒ beam jitter is exponentially amplified

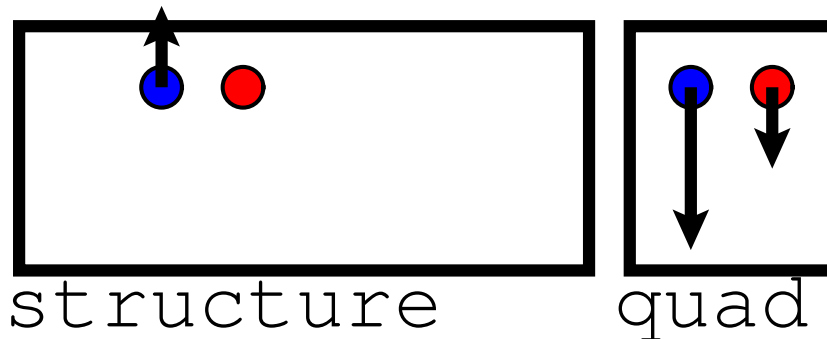

- BNS (Balakin, Novokhatsky, and Smirnov) damping prevents this growth
 - manipulate RF phases to have energy spread
 - take spread out at end

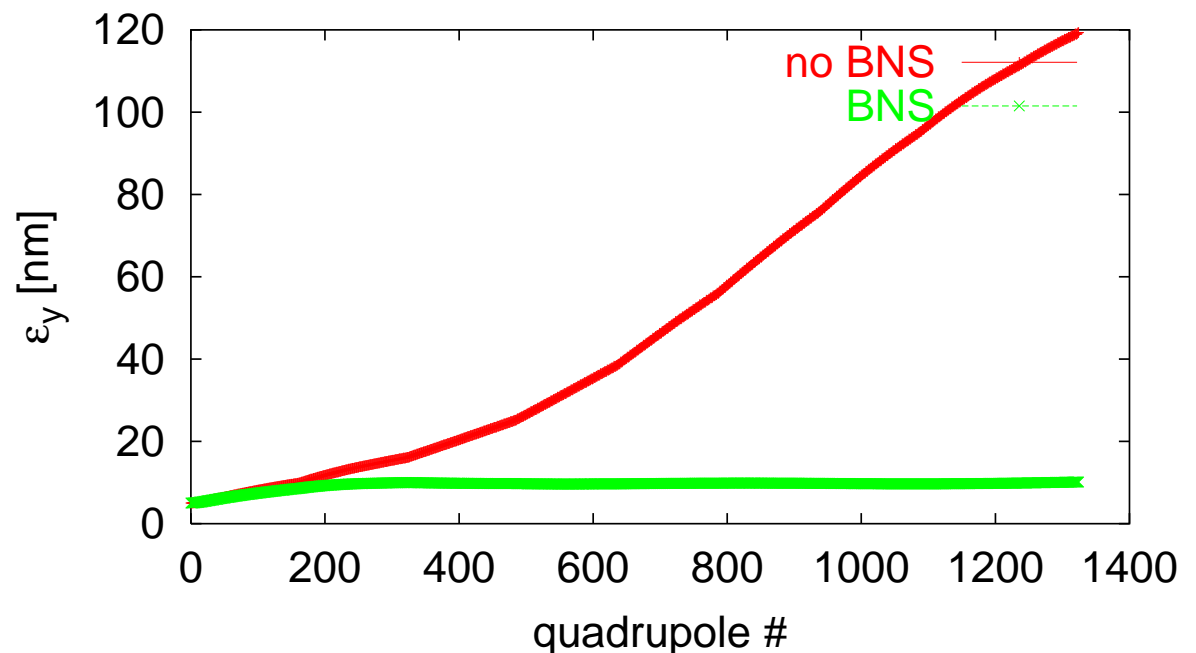

Two-Particle Wakefield Model

- Assume bunch can be represented by two particles and constant $K(s) = 1/\beta^2$
 - second particle is kicked by transverse wakefield
 - initial oscillation

$$x_1'' + \frac{1}{\beta^2}x_1 = 0 \quad x_2'' + \frac{1}{\beta^2}x_2 = \frac{Ne^2W_{\perp}}{P_Lc}x_1$$

$$x_1 = x_0 \cos\left(\frac{s}{\beta}\right) \quad x_2(0) = x_0 \quad x_2'(0) = 0$$

$$x_2'' + \frac{1}{\beta^2}x_2 = x_0 \frac{Ne^2W_{\perp}}{P_Lc} \cos\left(\frac{s}{\beta}\right)$$

- Solution is simple with an ansatz

$$x_2 = x_0 \cos\left(\frac{s}{\beta}\right) + \left(\frac{x_0 Ne^2W_{\perp}\beta}{2E}s\right) \sin\left(\frac{s}{\beta}\right)$$

⇒ Amplitude of second particle oscillation is growing

⇒ The bunch charge and length matter as well as the lattice

⇒ Have a closer look into wakefields

BNS Damping solution

- First particle performs a harmonic oscillation

$$x_1(s) = x_0 \cos\left(\frac{s}{\beta_1}\right)$$

- We want the second particle to perform the **same** oscillation
- Modify unperturbed oscillation frequency of second particle

$$x_2 = x_0 \cos\left(\frac{s}{\beta_2}\right)$$

- Leads to

$$x_2'' + \frac{1}{\beta_2^2} x_2 = x_0 \frac{Ne^2 W_\perp}{P_L c} \cos\left(\frac{s}{\beta_1}\right) = x_1 \frac{Ne^2 W_\perp}{P_L c}$$

- Assuming (can be achieved by changing energy of second particle)

$$\frac{1}{\beta_2^2} = \frac{1}{\beta_1^2} + \frac{Ne^2 W_\perp}{P_L c}$$

- Yields simple solution

$$x_2 = x_0 \cos\left(\frac{s}{\beta_1}\right) = x_1$$

⇒ No more wakefield effect

Energy Spread and Beam Stability

- Trade-off in fixed lattice
 - large energy spread is more stable
 - small energy spread is better for alignment

⇒ Beam with $N = 3.7 \times 10^9$ can be stable

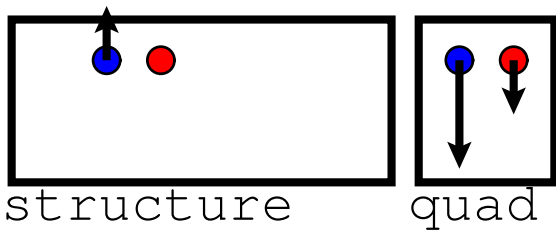

⇒ Tolerances are not a unique number

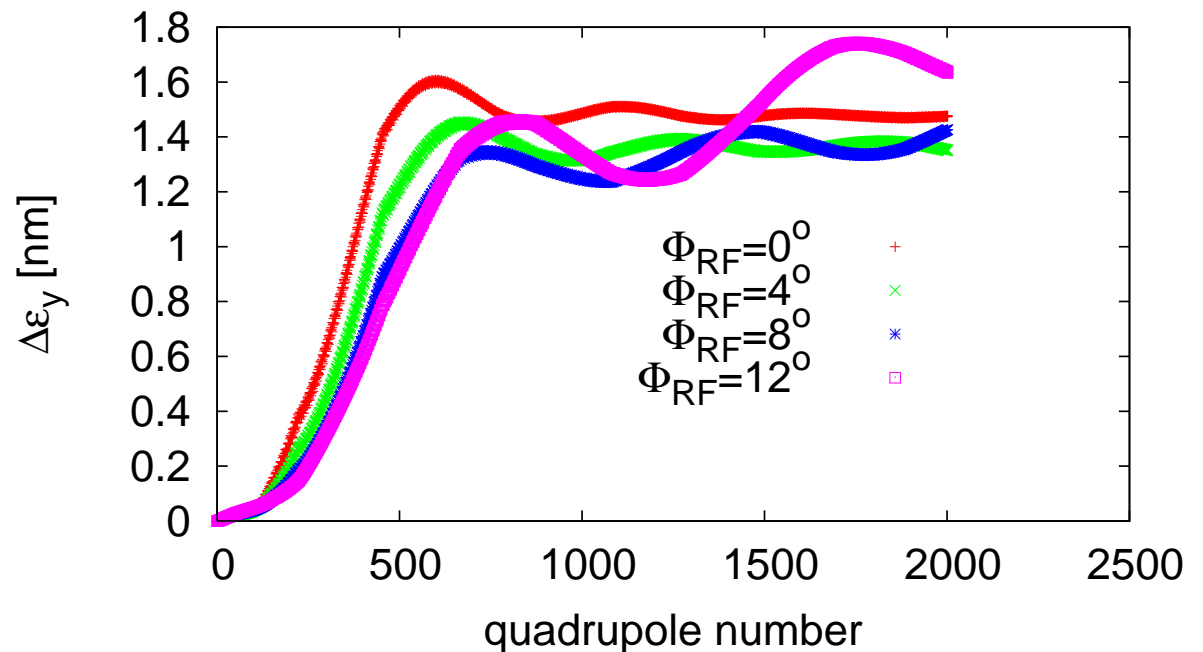
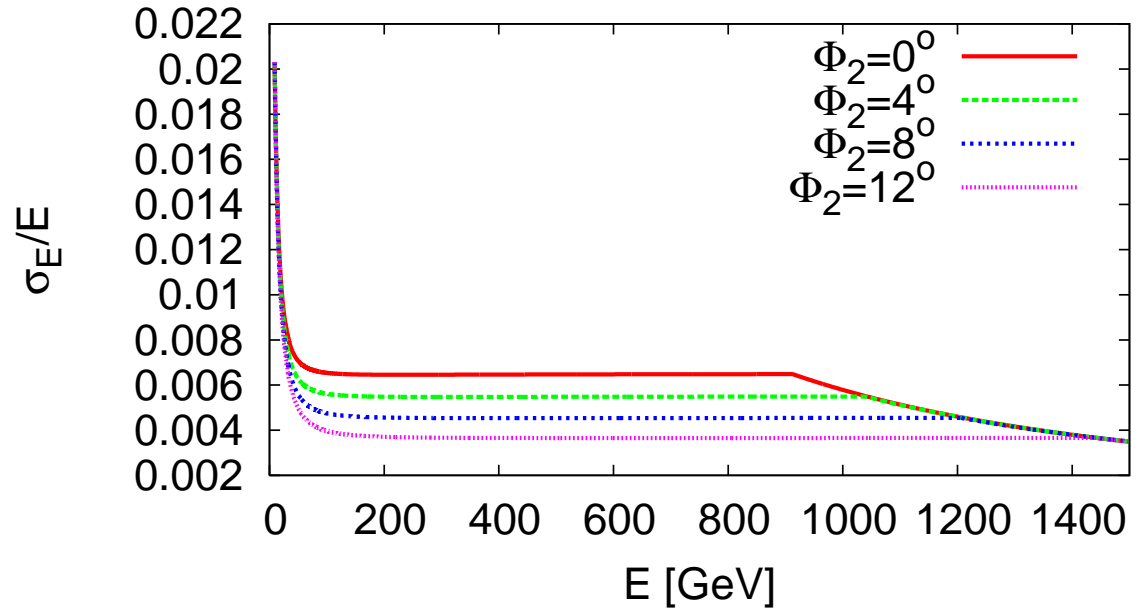

Multi-Bunch Wakefields

- Long-range transverse wakefields are sine-like
- They can be reduced by
 - damping
 - detuning

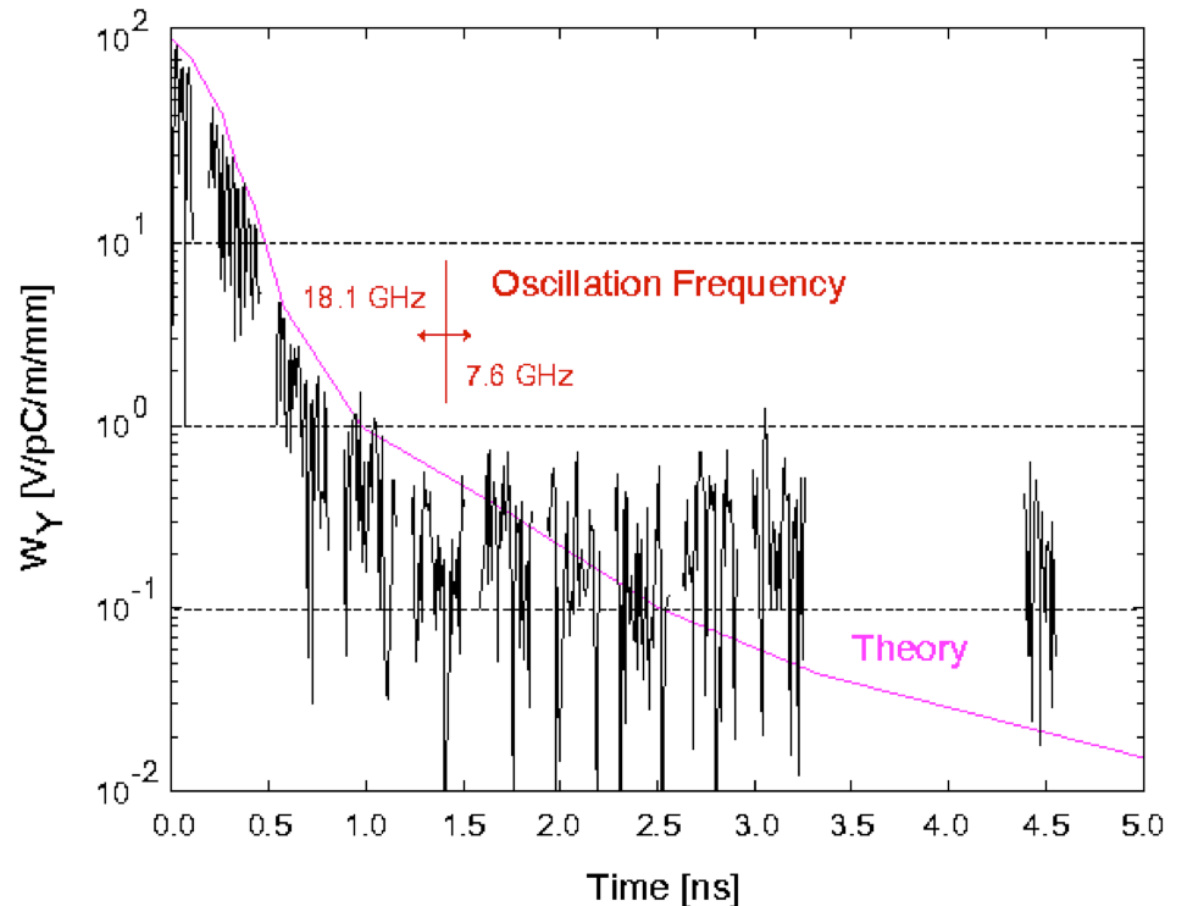

$$W_{\perp}(z) = \sum_i^{\infty} 2k_i \sin\left(2\pi \frac{z}{\lambda_i}\right) \exp\left(-\frac{\pi z}{\lambda_i Q_i}\right)$$

Damping

- Damping can be achieved by extracting the power of transverse modes from the structure
- In CLIC each cell has waveguides for this purpose
 - the fundamental mode cannot escape
- ILC has antennas at the end
 - weaker damping but bunch distance is larger
- Note: the difference has since been understood

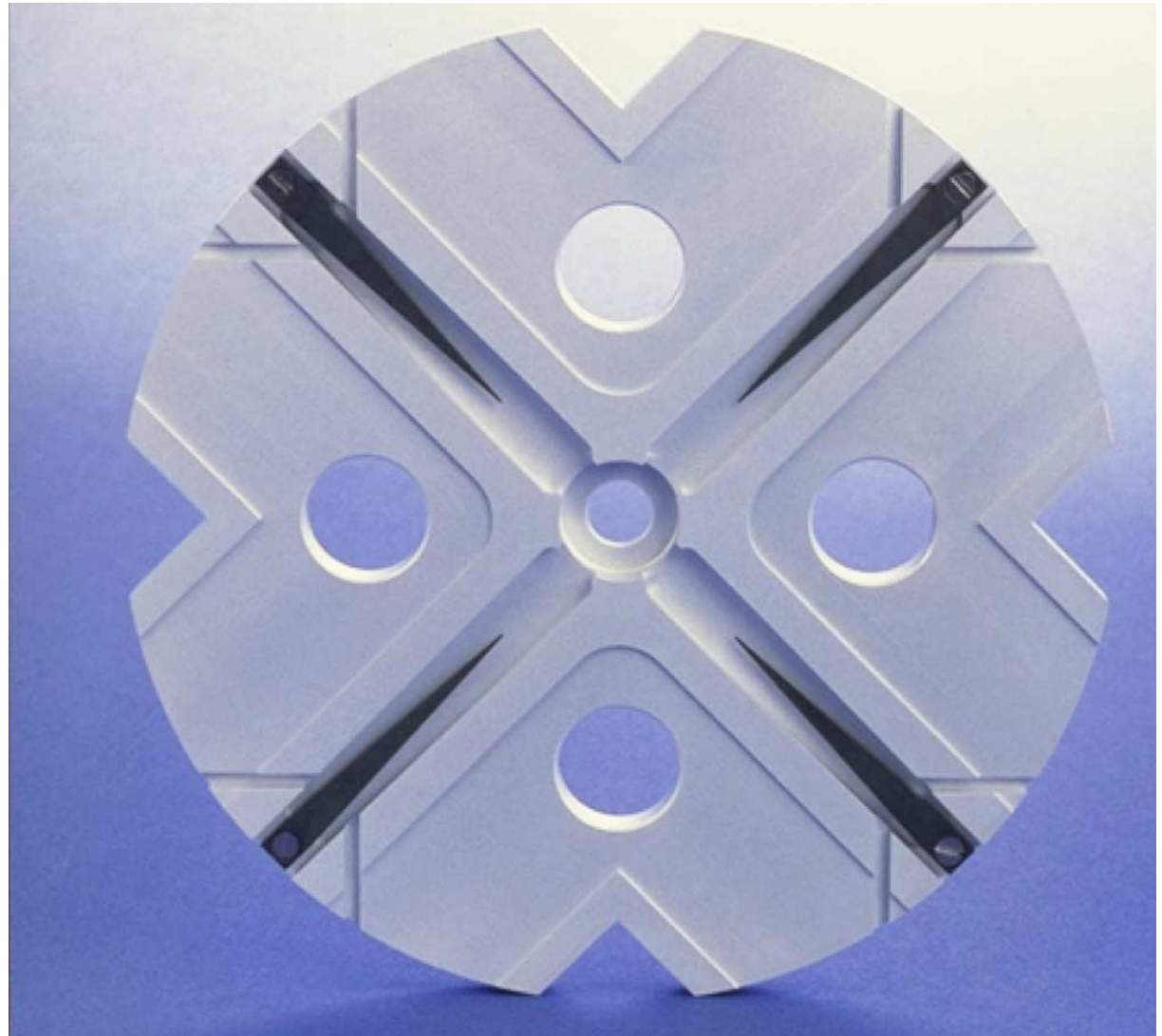

Detuning

To make our life simple we neglect damping

We split the wakefield $W(z) = a \sin(kz)$ into two modes

$$W(z) = W_0 \frac{\sin((k + \Delta)z) + \sin((k - \Delta)z)}{2}$$

the resulting amplitude is

$$W(z) = W_0 \sin(kz) \cos(\Delta z)$$

integrating over a Gaussian distribution yields

$$W(z) = W_0 \sin(kz) \int_0^\infty \frac{2}{\sqrt{2\pi}\sigma_\Delta} \exp\left(-\frac{\Delta^2}{2\sigma_\Delta^2}\right) \cos(\Delta z) d\Delta$$
$$\Rightarrow W(z) = W_0 \sin(kz) \exp\left(-\frac{(z\sigma_\Delta)^2}{2}\right)$$

- For a limited number of modes, recoherence can occur
 \Rightarrow damping is also needed
- In ILC detuning is important

Multi-Bunch Jitter Emittance Growth (CLIC)

- Multi-bunch effects can be calculated analytically for point-like bunches
 - an energy spread leads to a more stable case
- Simulations show
 - point-like bunches
 - bunches with energy spread due to bunch length
 - including also initial energy spread

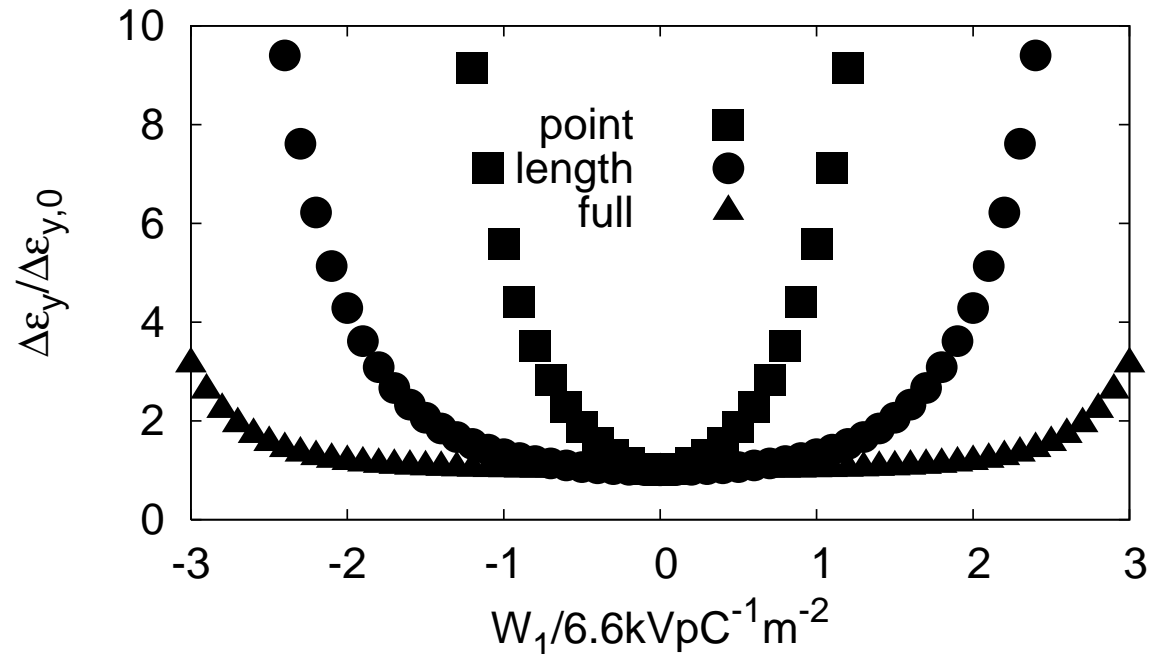

⇒ Point-like bunches is a pessimistic assumption for the dynamic effects

Static Multi-Bunch Effects (ILC)

- Simulation of long-range transverse wakefield effects

- with no detuning
- with random detuning from cavity to cavity

⇒ Cavity detuning is essential

⇒ Need to ensure that this detuning is present

- it does happen naturally
- but also if you depend on it?

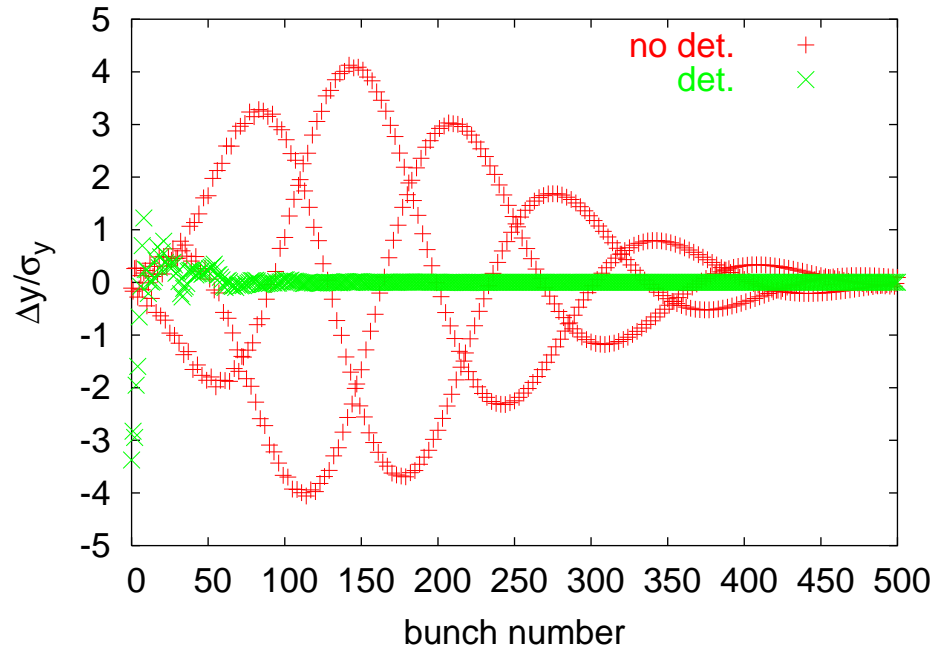

All main linac cavities are scattered by $500 \mu\text{m}$

Long-range wakefields are represented by a number of RF modes

$$W_{\perp}(z) = \sum_{i=0}^n a_i \sin\left(\frac{2\pi z}{\lambda_i}\right) \exp\left(-\frac{\pi z}{\lambda_i Q_i}\right)$$

- Note: results depend on exact frequency of transverse modes
 - some uncertainty in the prediction
 - but not a worry with detuning

Beam Jitter (ILC)

- Perfect machines used
- 100 machines simulated
 - TESLA wakefields with 0.1% RMS frequency spread
 - beam set to an offset
 - 5% bunch-to-bunch charge variations in uncorrected test beam
 - additional relative emittance growth due to multi-bunch is determined

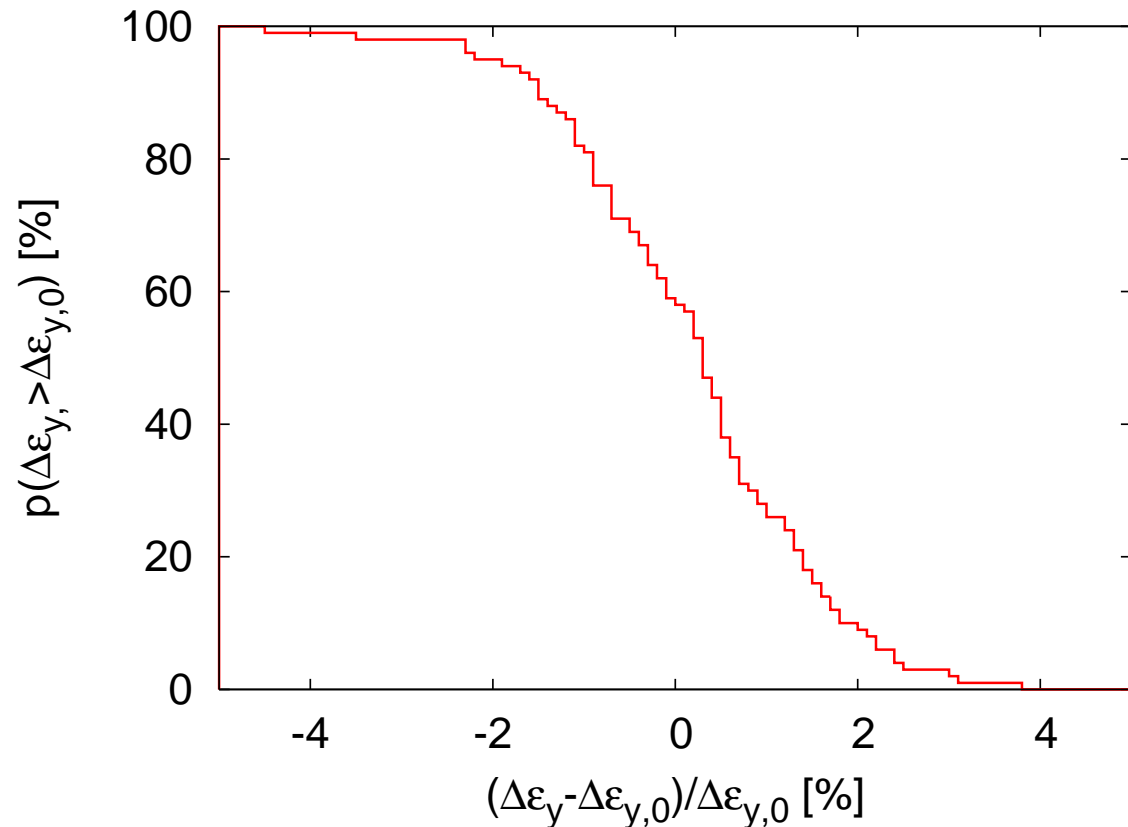

Imperfections



Introduction

- Have now been able to design a lattice that can transport the beam
- Need to determine how the imperfections in the machine affect the emittance preservation
- Will discuss the misalignment of elements
 - most important source of static emittance growth
- Have two ways to deal with tight tolerances for imperfections
 - work on the lattice to loosen tolerances
 - push R&D to satisfy tighter tolerances
 - e.g. in CLIC strong effort is ongoing to push imperfections down by about an order of magnitude

Element Misalignments

- Pre-Alignment imperfections can be roughly categorised into **short-distance** and **long-distance** errors
 - To first order, the imperfections can be treated as independent
 - as long as a linear main linac model is sufficient
 - The short-distance misalignments give largest emittance contribution
 - misalignment of elements is largely independent
 - simulated by scattering elements around a straight line
 - or slightly more complex local model
 - The long-distance misalignments are dominated by the wire system
- ⇒ ignore short-distance misalignments and simulate wire errors only
- Combined studies are mainly for completeness

Simulation Rational

- One can understand the effects qualitatively
 - some can be calculated analytically
 - some can be approximated analytically
 - but things soon become complex
- ⇒ Beam dynamics tracking code is used for studies (choose your favorite one)
- Implemented models are usually very flexible
 - e.g. linear and non-linear effects
 - Script language used to steer the simulation
 - The art is in using minimum model
 - as little as possible
 - as much as necessary
- ⇒ Cannot say what is in the code but rather what is in each individual study

Main Linac Static Tolerances

Element	error	with respect to	tolerance	
			CLIC	ILC
Structure	offset	beam	5.8 μm	$\approx 700 \mu\text{m}$
Structure	tilt	beam	220 μradian	$\approx 1000 \mu\text{radian}$
Quadrupole	offset	straight line	—	—
Quadrupole	roll	axis	240 μradian	190 μradian
BPM	offset	straight line	0.44 μm	15 μm
BPM	resolution	BPM center	0.44 μm	15 μm

- All tolerances for 1nm growth after one-to-one steering
- Goal is to have 90% of the machines achieve an emittance growth due to static effects of less than 5 nm

Assumed Survey Performance

Element	error	with respect to	alignment	
			ILC	CLIC
Structure	offset	girder	300 μm	5 μm
Structure	tilts	girder	300 μradian	200(*) μm
Girder	offset	survey line	200 μm	9.4 μm
Girder	tilt	survey line	20 μradian	9.4 μradian
Quadrupole	offset	girder/survey line	300 μm	17 μm
Quadrupole	roll	survey line	300 μradian	$\leq 100 \mu\text{radian}$
BPM	offset	girder/survey line	300 μm	14 μm
BPM	resolution	BPM center	$\approx 1 \mu\text{m}$	0.1 μm
Wakefield mon.	offset	wake center	—	5 μm

- In ILC specifications have much larger values than in CLIC
 - more difficult alignment in super-conducting environment
 - dedicated effort for CLIC needed
- Wakefield monitors are currently only foreseen in CLIC
 - but could be an option also in ILC

Beam-Based Alignment and Tuning Strategy

- Make beam pass linac
 - one-to-one correction
- Remove dispersion, align BPMs and quadrupoles
 - dispersion free steering
 - ballistic alignment
 - kick minimisation
- Remove residual wakefield and dispersive effects
 - accelerating structure alignment (CLIC only)
 - emittance tuning bumps
- Tune luminosity
 - tuning knobs

Dispersion Free Correction

- Basic idea: use different beam energies
- NLC: switch on/off different accelerating structures
- CLIC (ILC): accelerate beams with different gradient and initial energy
 - try to do this in a single pulse (time resolution)

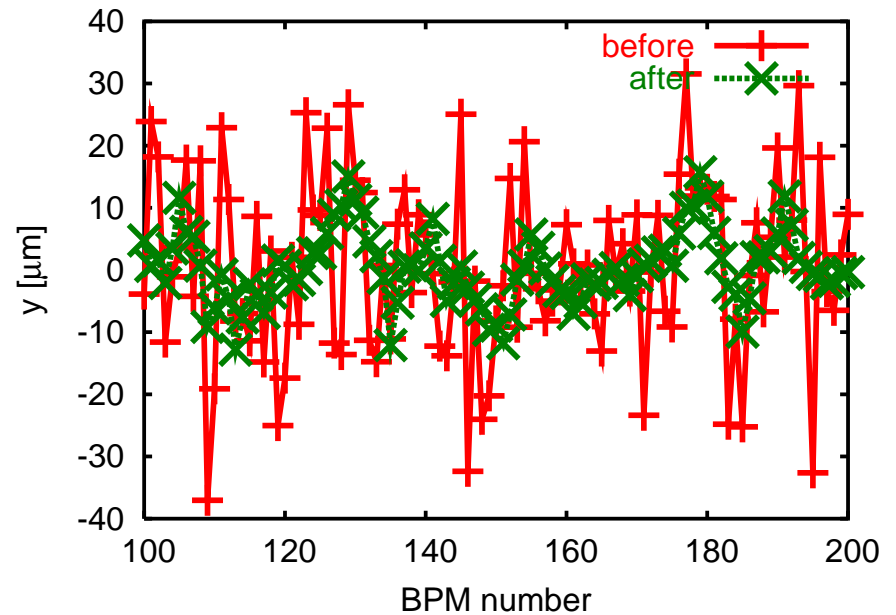

- Optimise trajectories for different energies together:

$$S = \sum_{i=1}^n \left(w_i (x_{i,1})^2 + \sum_{j=2}^m w_{i,j} (x_{i,1} - x_{i,j})^2 \right) + \sum_{k=1}^l w'_k (c_k)^2$$

- Last term is omitted
- Idea is to mimic energy differences that exist in the bunch with different beams

Emittance Growth (ILC)

Error	with respect to	value	$\Delta\gamma\epsilon_y$ [nm]	$\Delta\gamma\epsilon_{y,121}$ [nm]	$\Delta\gamma\epsilon_{y,dfs}$ [nm]
Cavity offset	module	300 μm	3.5	0.2	0.2(0.2)
Cavity tilt	module	300 μradian	2600	< 0.1	1.8(8)
BPM offset	module	300 μm	0	360	4(2)
Quadrupole offset	module	300 μm	700000	0	0(0)
Quadrupole roll	module	300 μradian	2.2	2.2	2.2(2.2)
Module offset	perfect line	200 μm	250000	155	2(1.2)
Module tilt	perfect line	20 μradian	880	1.7	—

- The results of the reference DFS method is quoted, results of a different implementation in brackets
- Note in the simulations the correction the quadrupoles had been shifted, otherwise some residual effect of the quadrupole misalignment would exist

Beam-Based Structure Alignment (CLIC)

- Each structure is equipped with a wake-field monitor (RMS position error $5 \mu\text{m}$)

- Up to eight structures on one movable girders

⇒ Align structures to the beam

- Assume identical wake fields

- the mean structure to wakefield monitor offset is most important

- in upper figure monitors are perfect, mean offset structure to beam is zero after alignment

- scatter around mean does not matter a lot

- With scattered monitors

- final mean offset is σ_{wm}/\sqrt{n}

- In the current simulation each structure is moved independently

- A study has been performed to move the articulation points

- Girder stop size $< 1 \mu\text{m}$

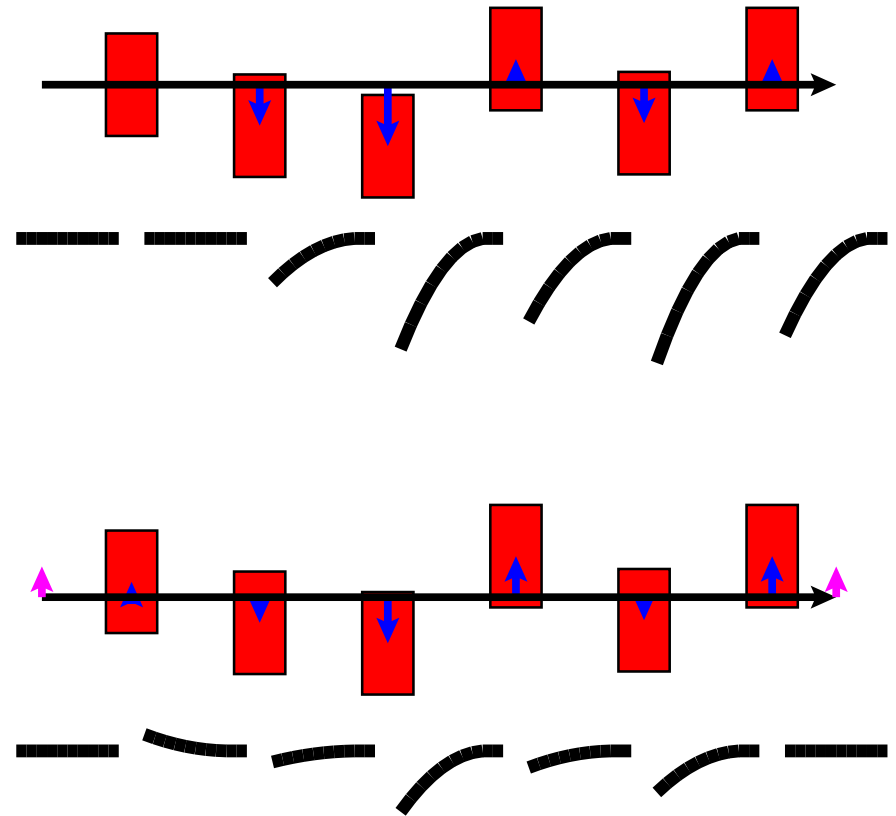

- For our tolerance $\sigma_{wm} = 5 \mu\text{m}$ we find $\Delta\epsilon_y \approx 0.5 \text{ nm}$

- some dependence on alignment method

Emittance Tuning Bumps

- Emittance (or luminosity) tuning bumps can further improve performance
 - globally correct wake-field by moving some structures
 - similar procedure for dispersion
- Need to monitor beam size
- Optimisation procedure
 - measure beam size for different bump settings
 - make a fit to determine optimum setting
 - apply optimum
 - iterate on next bump

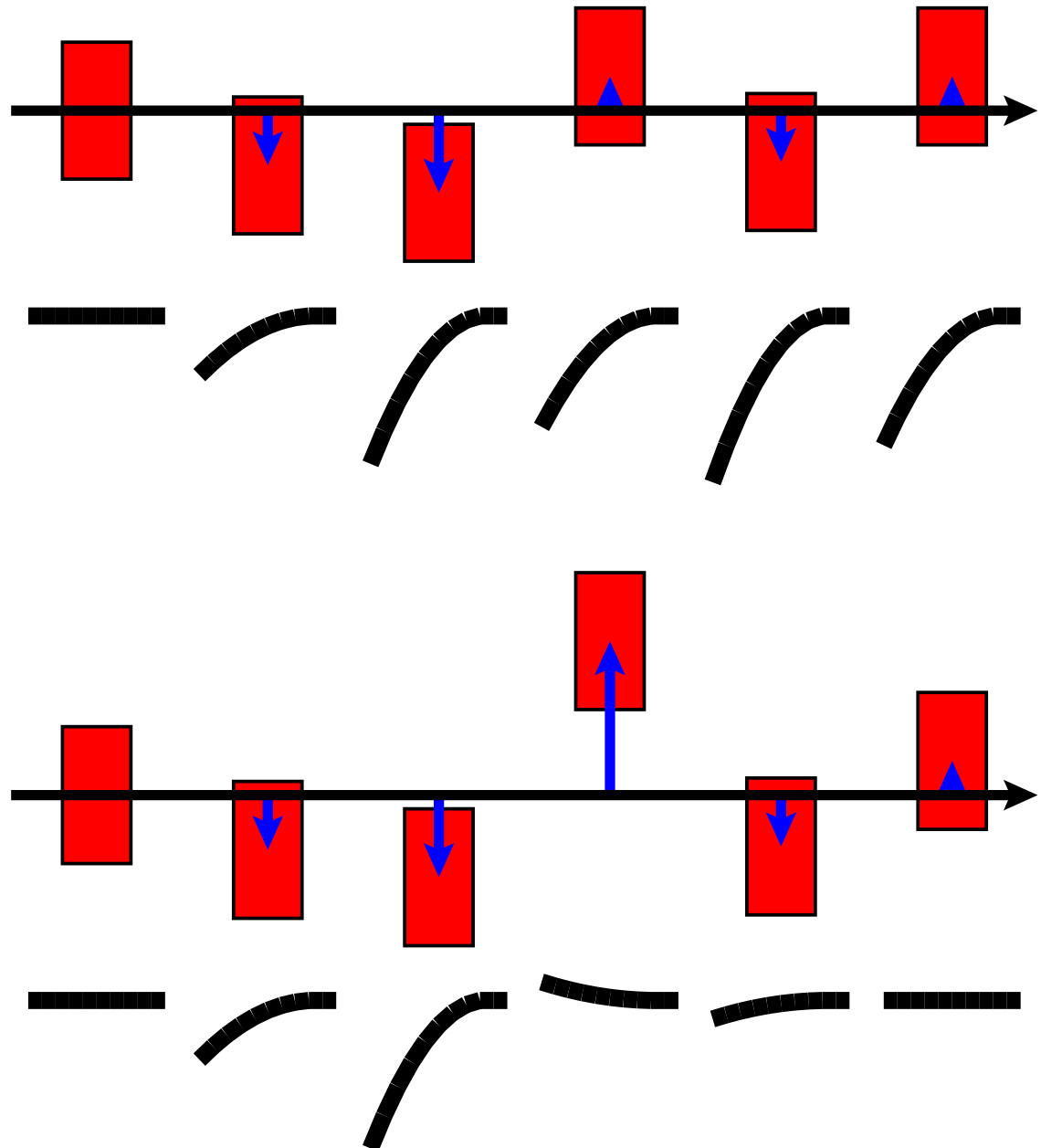

Final Emittance Growth (CLIC)

imperfection	with respect to	symbol	value	emitt. growth
BPM offset	wire reference	σ_{BPM}	14 μm	0.367 nm
BPM resolution	wire reference	σ_{res}	0.1 μm	0.04 nm
accelerating structure offset	girder axis	σ_4	10 μm	0.03 nm
accelerating structure tilt	girder axis	σ_t	200 μradian	0.38 nm
articulation point offset	wire reference	σ_5	12 μm	0.1 nm
girder end point	articulation point	σ_6	5 μm	0.02 nm
wake monitor	structure centre	σ_7	5 μm	0.54 nm
quadrupole roll	longitudinal axis	σ_r	100 μradian	≈ 0.12 nm

- Selected a good DFS implementation
 - trade-offs are possible
- Multi-bunch wakefield misalignments of 10 μm lead to $\Delta\epsilon_y \approx 0.13$ nm
- Performance of local pre-alignment is acceptable

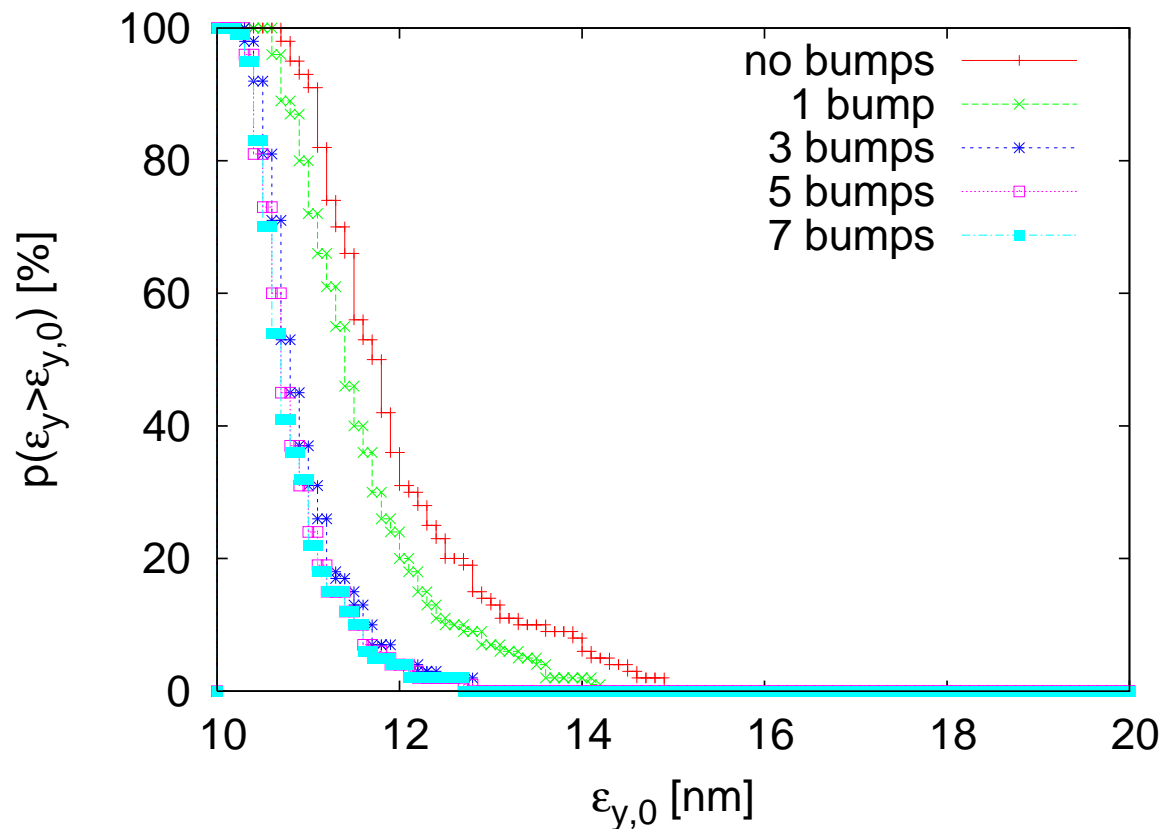

Results (ILC)

- DFS brings us close to the required performance
 - Tuning of the dispersion helps a lot
 - Even wakefield tuning helps us
 - The remaining emittance growth is to a significant extent due to quadrupole roll
- ⇒ should add a tuning bump for this effect as well

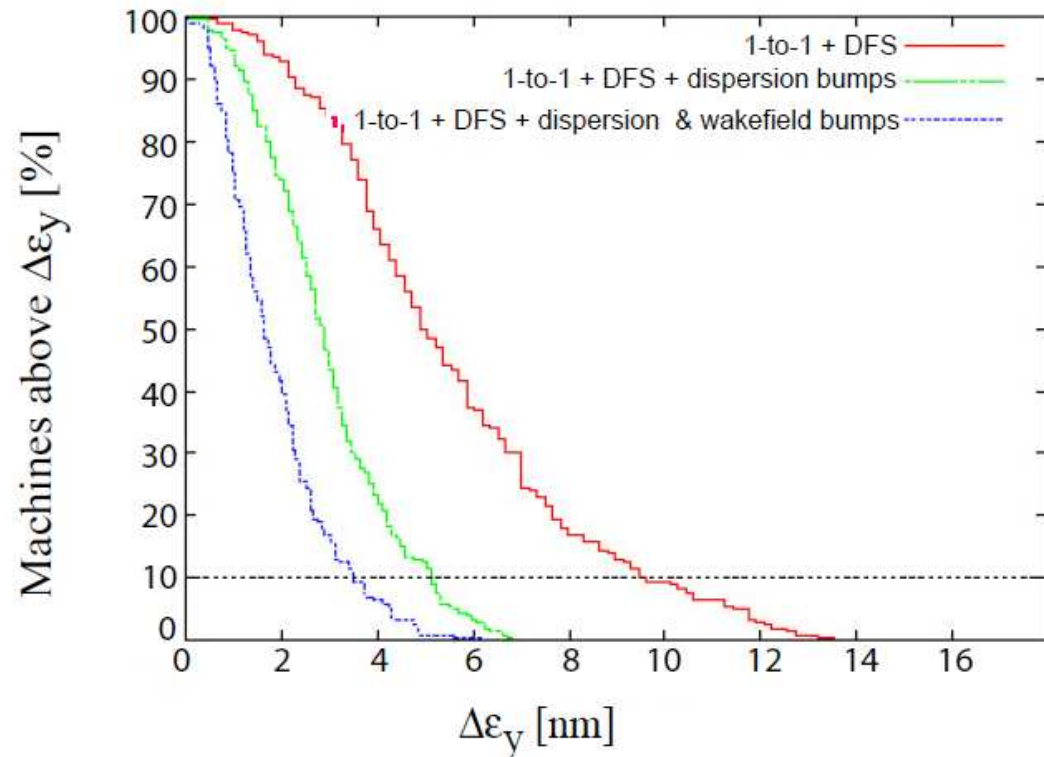

Dependence on Weights (Old CLIC Parameters)

- For TRC parameters set
 - One test beam is used with a different gradient and a different incoming beam energy
- ⇒ BPM position errors are less important at large w_1
- ⇒ BPM resolution is less important at small w_1
- ⇒ Need to find a compromise
- ⇒ **There is no such thing as “the” tolerance for one error source**

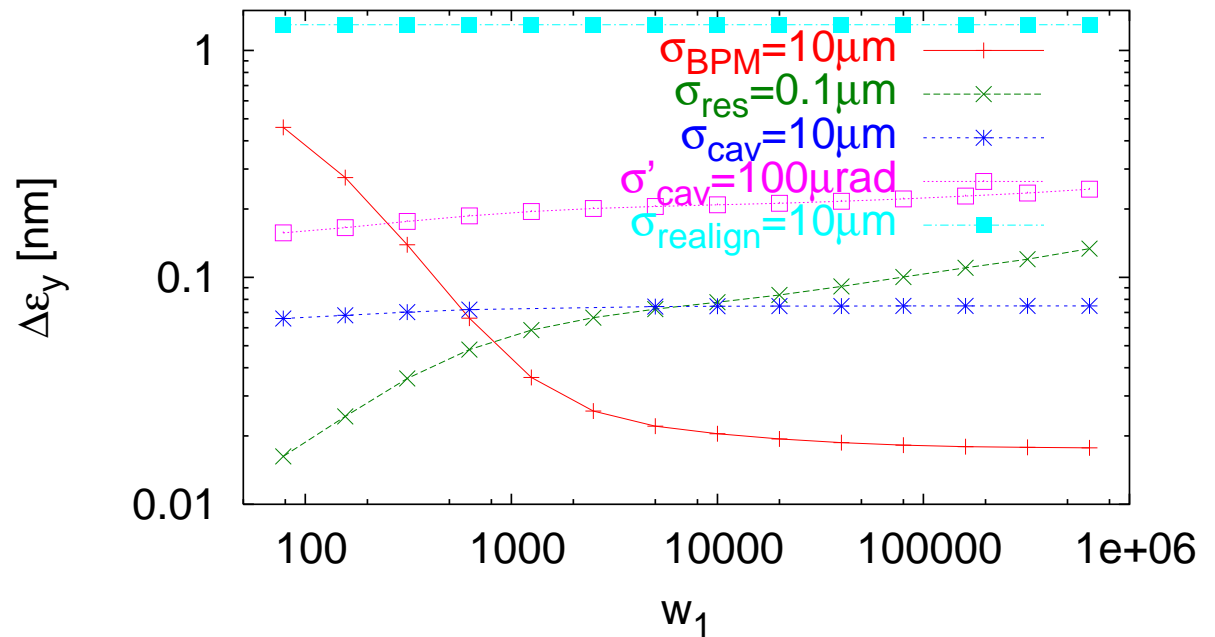

Growth Along Main Linac (CLIC)

- Emittance growth along the main linac due to the different imperfections
- Growth is mainly constant per cell
 - follows from first principles applied during lattice design
- Exception is structure tilt
 - due to uncorrelated energy spread
 - flexible weight to be investigated
- Some difference for BPMs
 - due to secondary emittance growth

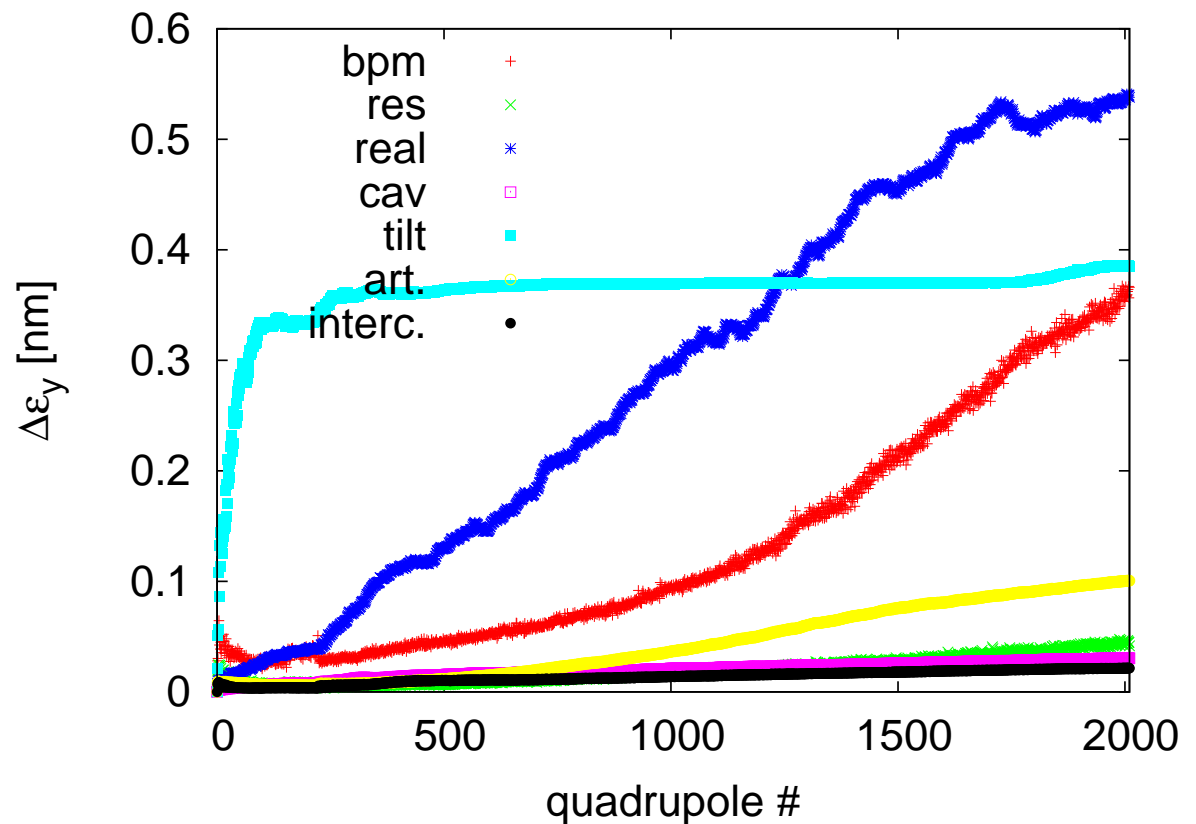

Sensitivity to Survey Line Errors (CLIC)

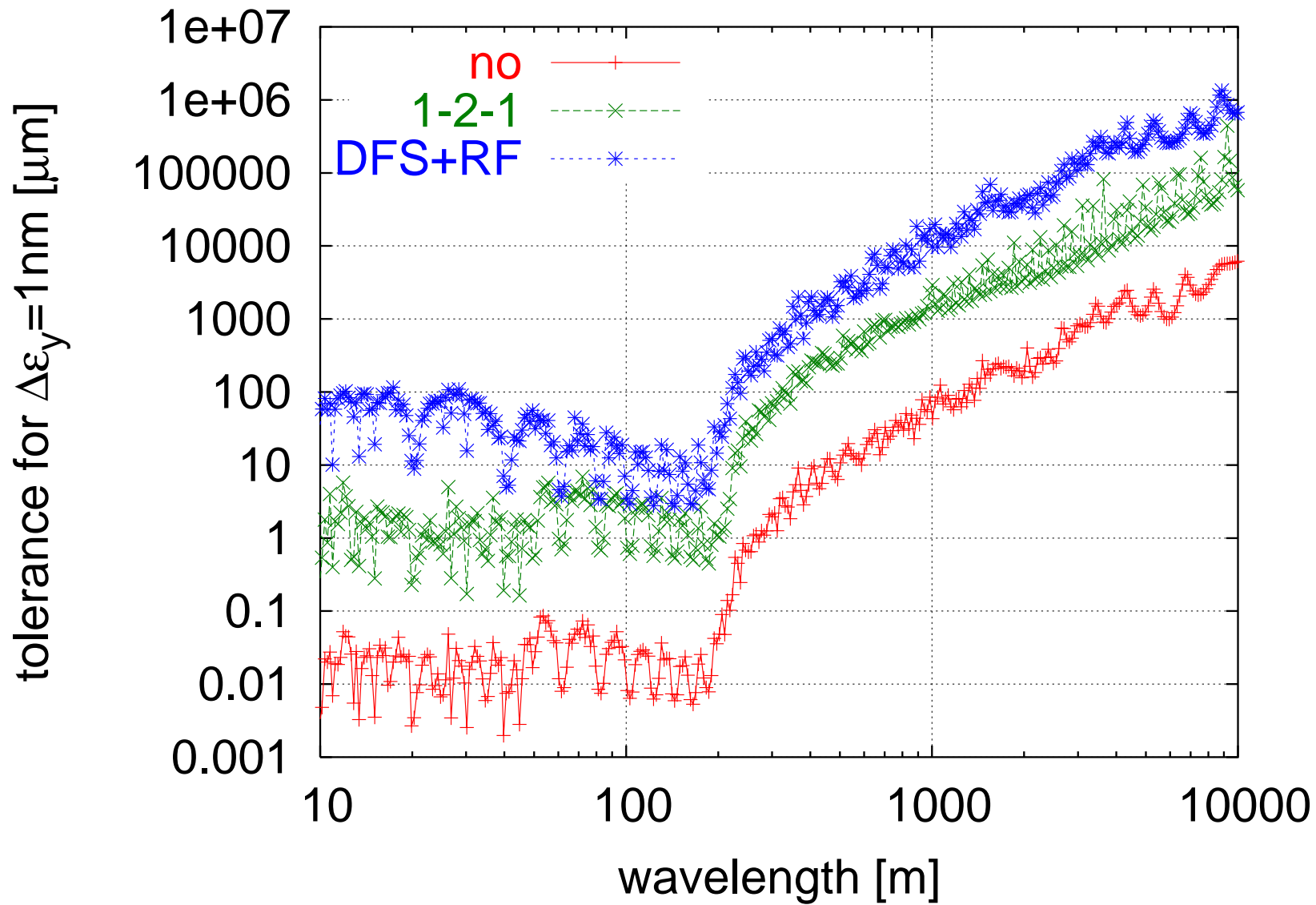

- Cosine-line misalignments, beta-functions clearly visible

Structure Challenges



Introduction

- You heard all about those, so just a short reminder
- Achieving the gradient is a challenge in both designs
- For ILC the Q -value is crucial
 - can only use structures with good value
 - some structure do not reach the gradient required
- In CLIC the breakdown rate is crucial
 - can kick the beam and prevent luminosity

Super-conducting Cavity Q_0 -Values

- The Q_0 -values of super-conducting cavities can strongly vary from one cavity to the next
 - material quality
- Challenge is to produce enough good cavities
 - fraction of good cavities is relevant for cost
- Too low Q_0 means larger cooling power is required

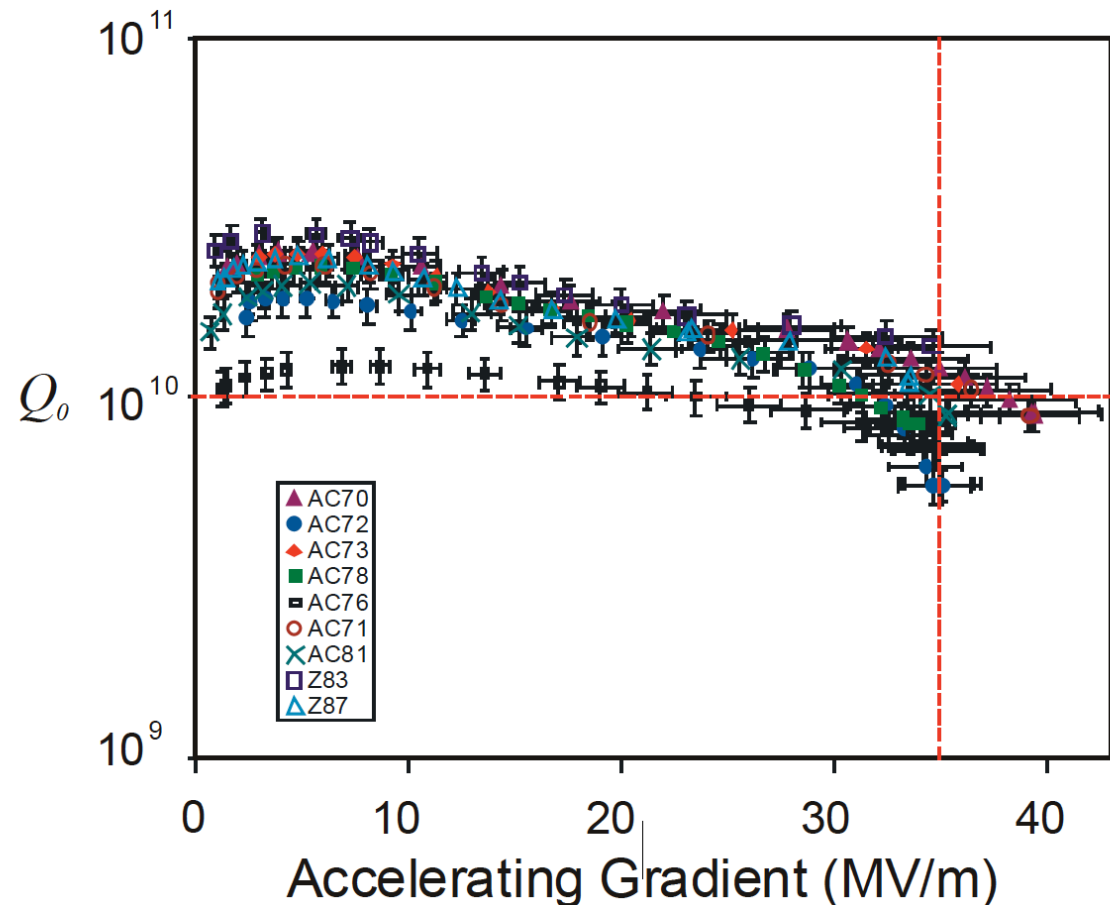

Breakdown Rate (CLIC)

- Direct limit to breakdown rate
 - 1% luminosity loss budget
 - assuming that a pulse with breakdown leads to no luminosity
 - have 7×10^4 structures per linac
- ⇒ breakdown rate
 $0.01 / 14 \times 10^4 \approx 0.7 \times 10^{-7}$
- Assumed strategy is to switch off corresponding PETS and slowly go up to power again

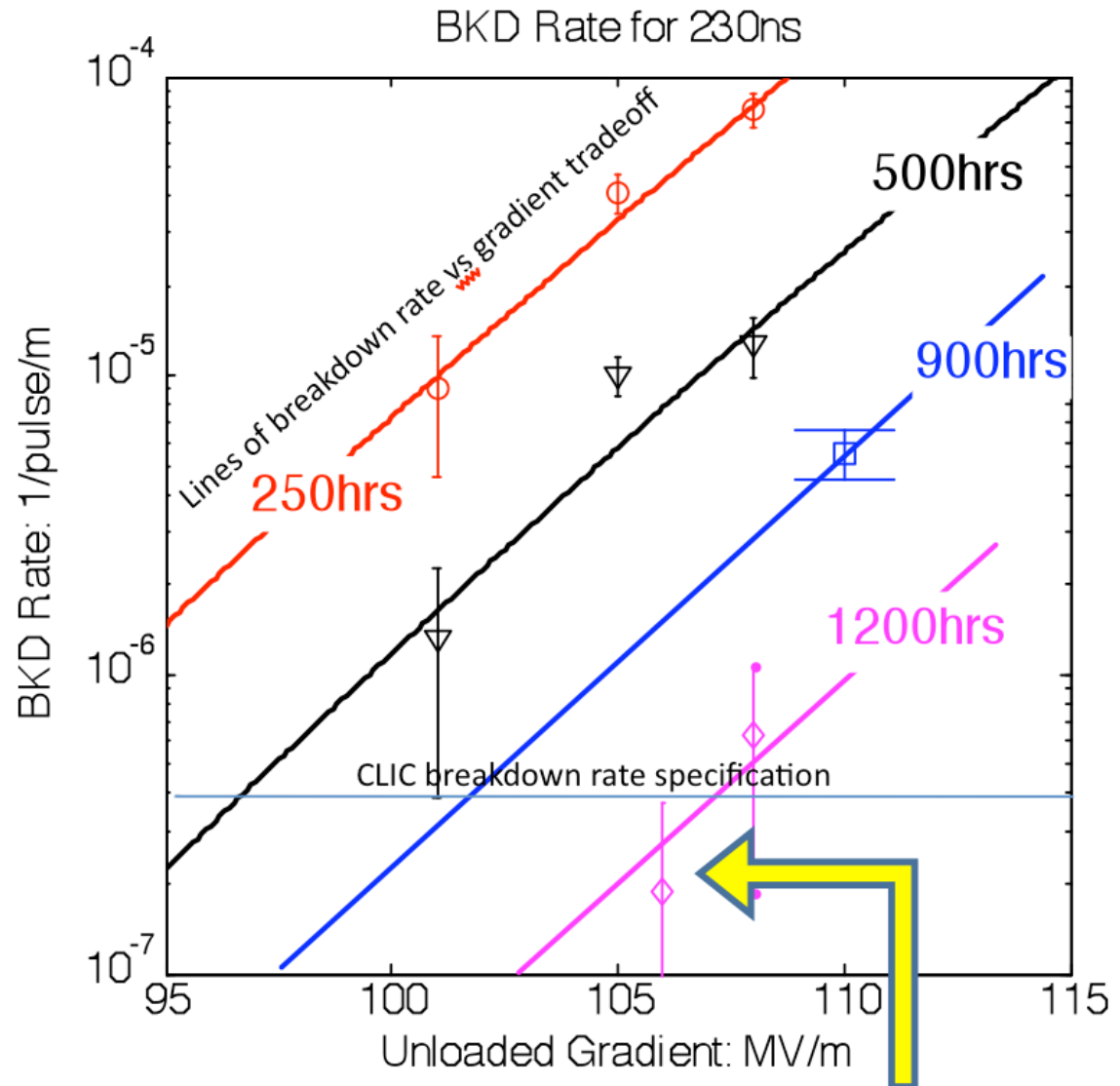

Empirical RF Constraints

- To limit the breakdown rate and the severeness of the breakdowns
- The maximum surface field has to be limited

$$\hat{E} < 260 \text{ MV/m}$$

- The temperature rise at the surface needs to be limited

$$\Delta T < 56 \text{ K}$$

- The power flow needs to be limited
 - related to the badness of a breakdown

empirical parameter is

$$P/(2\pi a)\tau^{\frac{1}{3}} < 18 \frac{\text{MW}}{\text{mm}} \text{ns}^{\frac{1}{3}}$$

Imperfections from the Structure (CLIC)

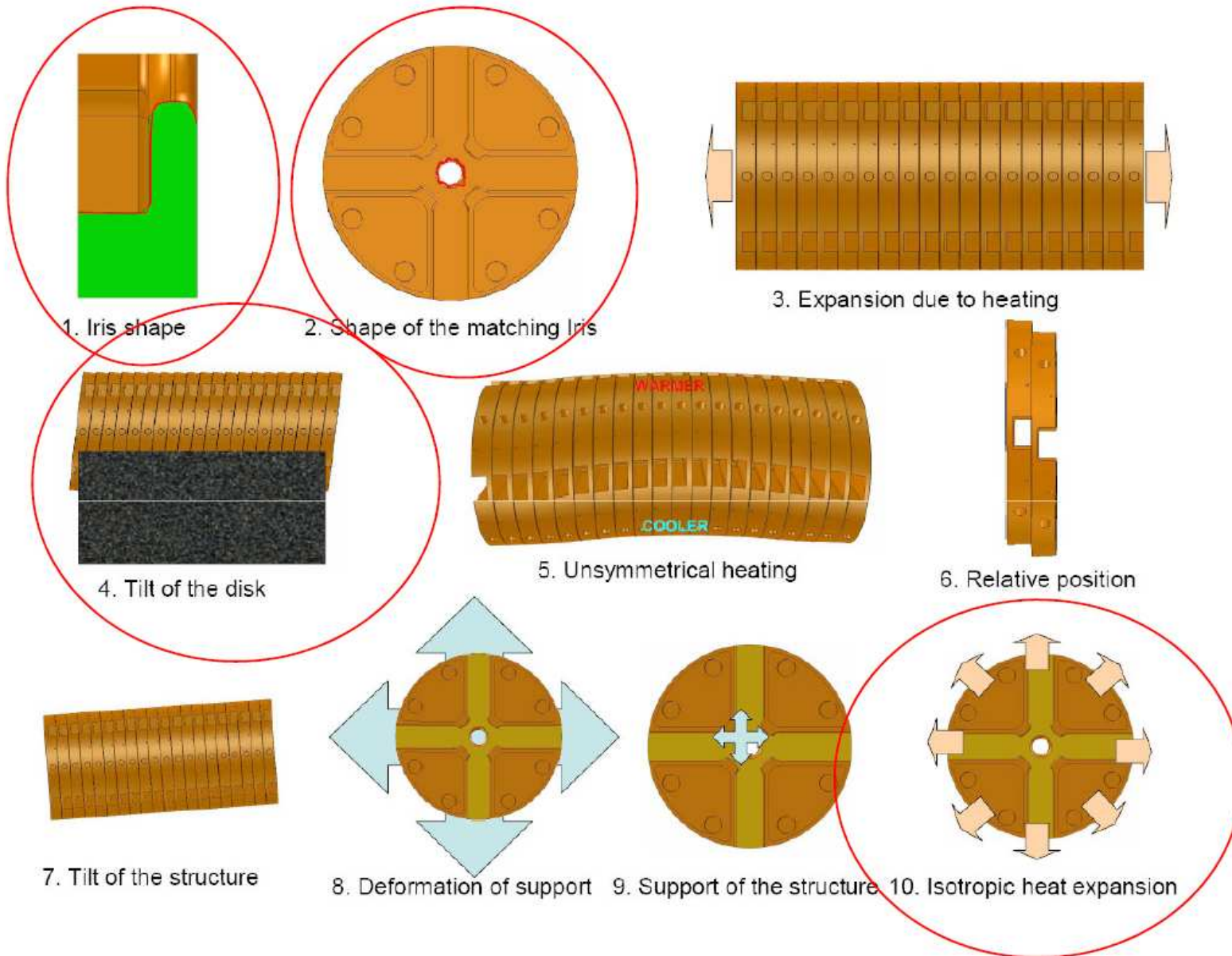

Parameter Optimisation

A not so basic thing for linacs. . .

Done for CLIC only



Luminosity

Simplified treatment and approximations used throughout

$$\mathcal{L} = H_D \frac{N^2 f_{rep} n_b}{4\pi \sigma_x \sigma_y}$$

$$\mathcal{L} \propto H_D \frac{N}{\sqrt{\beta_x \epsilon_x} \sqrt{\beta_y \epsilon_y}} \eta P$$

$$\epsilon_x = \epsilon_{x,DR} + \epsilon_{x,BC} + \epsilon_{x,BDS} + \dots$$

$$\epsilon_y = \epsilon_{y,DR} + \epsilon_{y,BC} + \epsilon_{y,linac} + \epsilon_{y,BDS} \\ + \epsilon_{y,growth} + \epsilon_{y,offset} \dots$$

$$\sigma_{x,y} \propto \sqrt{\beta_{x,y} \epsilon_{x,y} / \gamma}$$

$$N f_{rep} n_b \propto \eta P$$

typically $\epsilon_x \gg \epsilon_y$,
 $\beta_x \gg \beta_y$

Fundamental limitations from

- beam-beam: $N / \sqrt{\beta_x \epsilon_x}$, $N / \sqrt{\beta_x \epsilon_x \beta_y \epsilon_y}$
- emittance generation and preservation:
 $\sqrt{\beta_x \epsilon_x}$, $\sqrt{\beta_y \epsilon_y}$
- main linac RF: η

Potential Limitations

- Efficiency η :
depends on beam current that can be transported
Decrease bunch distance \Rightarrow long-range transverse wakefields in main linac
Increase bunch charge \Rightarrow short-range transverse and longitudinal wakefields in main linac, other effects
- Horizontal beam size σ_x
beam-beam effects, final focus system, damping ring, bunch compressors
- vertical beam size σ_y
damping ring, main linac, beam delivery system, bunch compressor, need to collide beams, beam-beam effects
- Will try to show how to derive $L_{bx}(f, a, \sigma_a, G)$

Beam Size Limit at IP

- The vertical beam size had been $\sigma_y = 1 \text{ nm}$ (BDS)
 \Rightarrow challenging enough, so keep it $\Rightarrow \epsilon_y = 10 \text{ nm}$
- Fundamental limit on horizontal beam size arises from beamstrahlung
 Two regimes exist depending on beamstrahlung parameter

$$\Upsilon = \frac{2\hbar\omega_c}{3E_0} \propto \frac{N\gamma}{(\sigma_x + \sigma_y)\sigma_z}$$

$\Upsilon \ll 1$: classical regime, $\Upsilon \gg 1$: quantum regime

At high energy and high luminosity $\Upsilon \gg 1$

$$\mathcal{L} \propto \Upsilon\sigma_z/\gamma P\eta$$

\Rightarrow partial suppression of beamstrahlung

\Rightarrow coherent pair production

In CLIC $\langle \Upsilon \rangle \approx 6$, $N_{coh} \approx 0.1N$

\Rightarrow somewhat in quantum regime

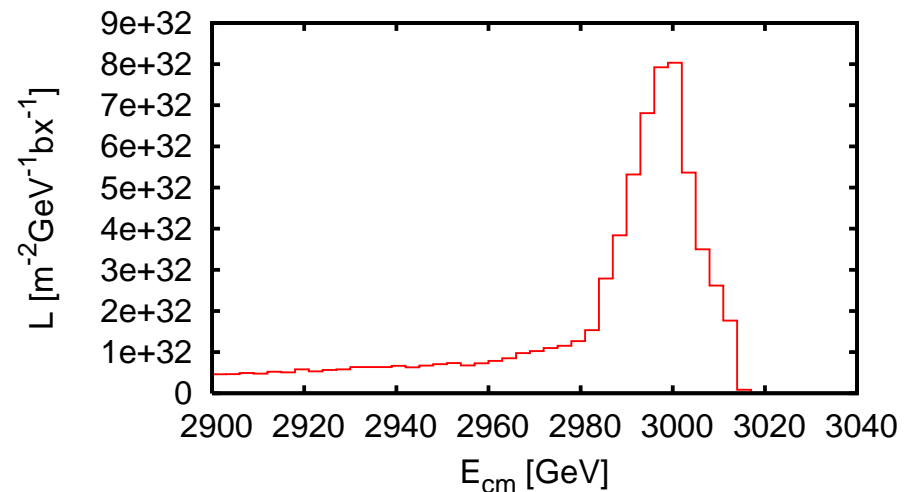
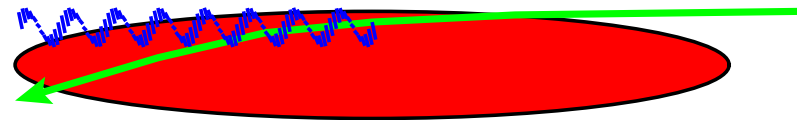

\Rightarrow Use luminosity in peak as figure of merit

Luminosity Optimisation at IP

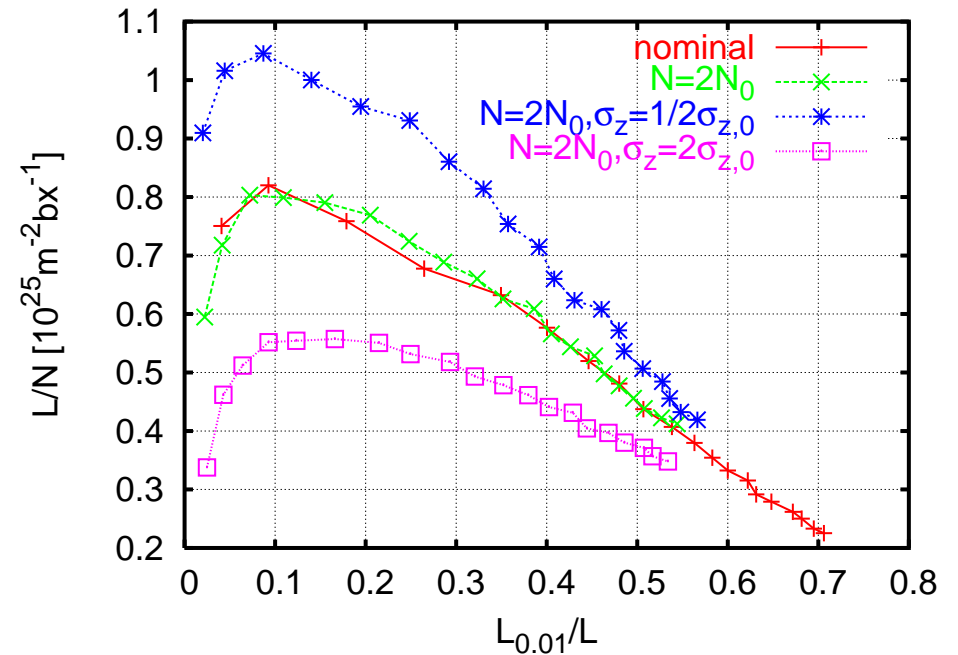
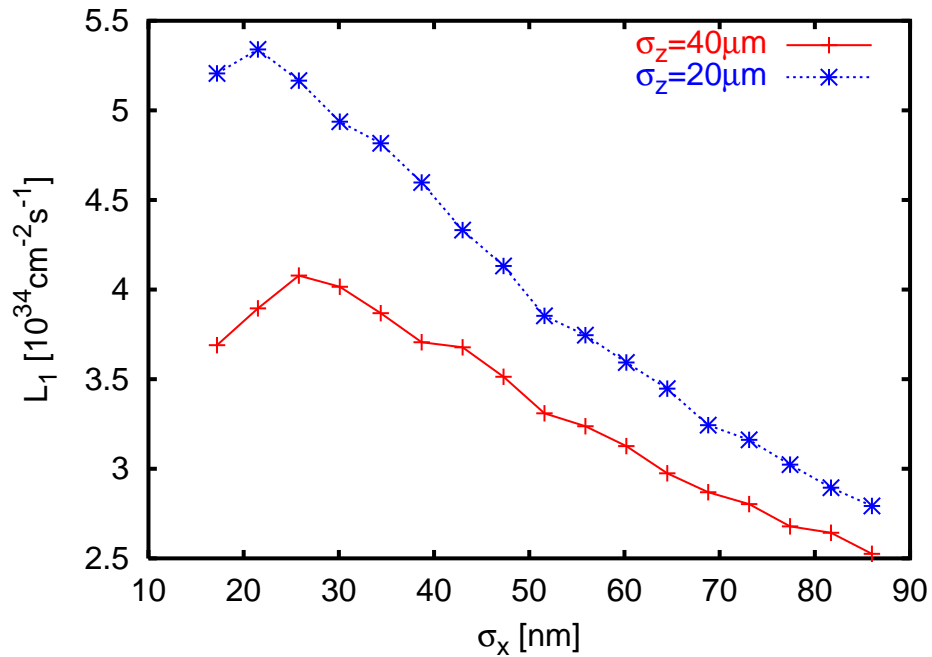

Total luminosity for $\Upsilon \gg 1$

$$\mathcal{L} \propto \frac{N}{\sigma_x \sigma_y} \eta \propto \frac{n_\gamma^{3/2}}{\sqrt{\sigma_z}} \frac{\eta}{\sigma_y}$$

large $n_\gamma \Rightarrow$ higher $\mathcal{L} \Rightarrow$ degraded spectrum

chose n_γ , e.g. maximum $L_{0.01}$ or $L_{0.01}/L = 0.4$ or ...

$$\mathcal{L}_{0.01} \propto \frac{\eta}{\sqrt{\sigma_z} \sigma_y}$$

Other Beam Size Limitations

- Final focus system squeezes beams to small sizes with main problems:
 - beam has energy spread (RMS of $\approx 0.35\%$) \Rightarrow avoid chromaticity
 - synchrotron radiation in bends \Rightarrow use weak bends \Rightarrow long system
 - radiation in final doublet (Oide Effect)
 - Large $\beta_{x,y} \Rightarrow$ large nominal beam size
 - Small $\beta_{x,y} \Rightarrow$ large distortions
 - Beam-beam simulation of nominal case: effective $\sigma_x \approx 40$ nm, $\sigma_y \approx 1$ nm
- \Rightarrow lower limit of $\sigma_x \Rightarrow$ for small N optimum n_γ cannot be reached
- new FFS reaches $\sigma_x \approx 40$ nm, $\sigma_y \approx 1$ nm
- Assume that the transverse emittances remain the same
 - not strictly true
 - emittance depends on charge in damping ring (e.g. $\epsilon_x(N = 2 \times 10^9) = 450$ nm, $\epsilon_x(N = 4 \times 10^9) = 550$ nm)

Work Flow

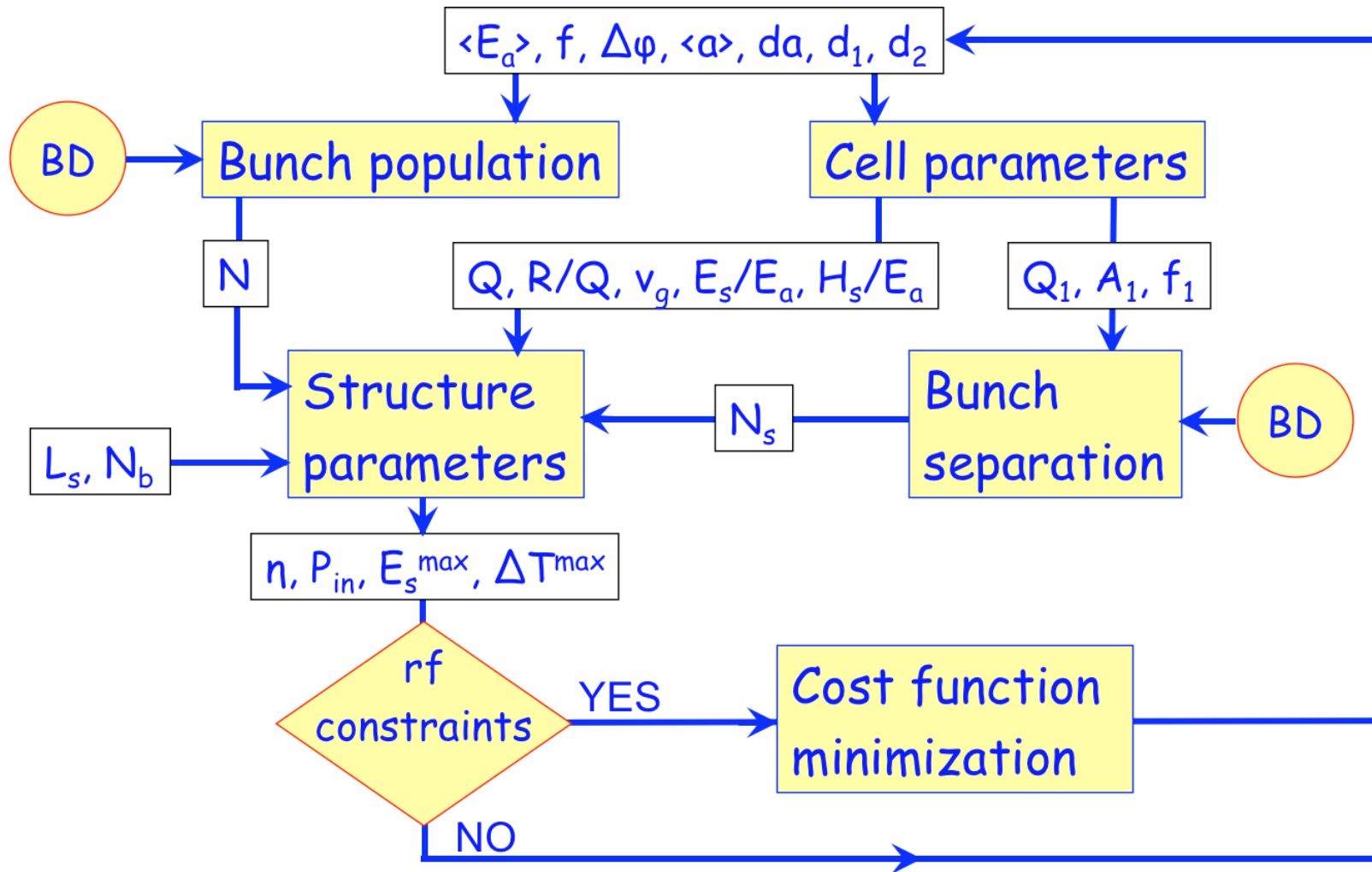

Beam Dynamics Work Flow

- Optimisation keeping the main linac beam dynamics tolerances at the original level
 - do not change the lattice
- Minimum spot size at IP is dominated by BDS and damping ring
 - adjust N/σ_x for large bunch charges to respect beam-beam limit
- For each of the different values of f and a/λ find $\sigma_z(N)$
 - respecting final RMS energy spread to be $\sigma_E/E = 0.35\%$ and running 12° off-crest
 - chose N such that $2NW_\perp(\sigma_z(N))$ is acceptable (i.e. old value)

Results

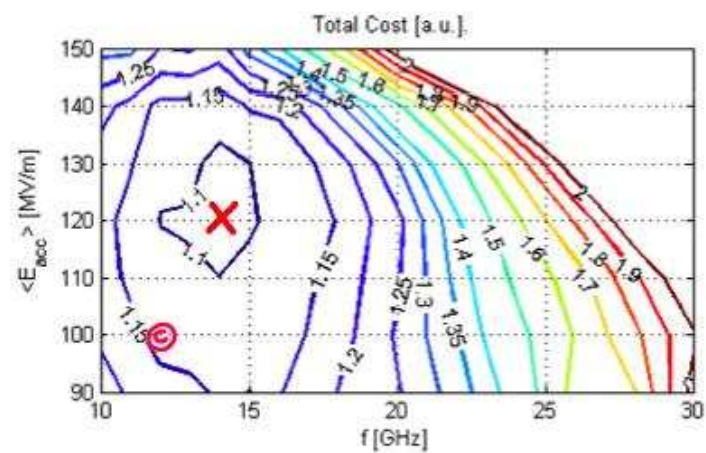
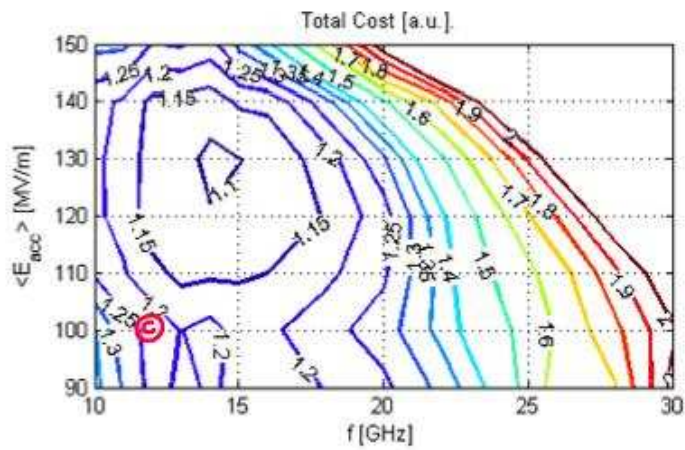
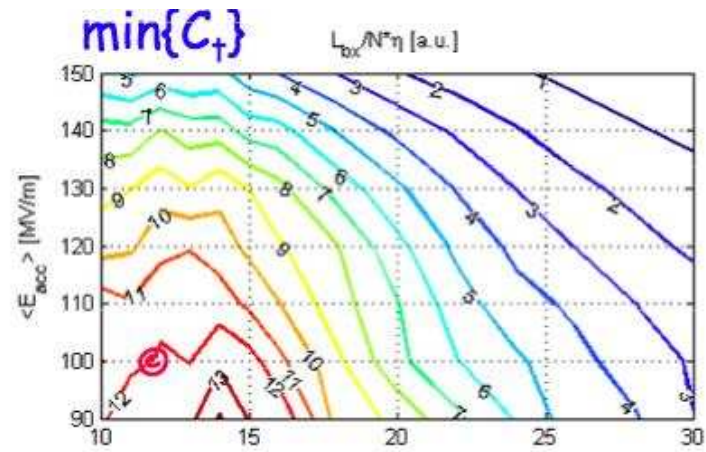
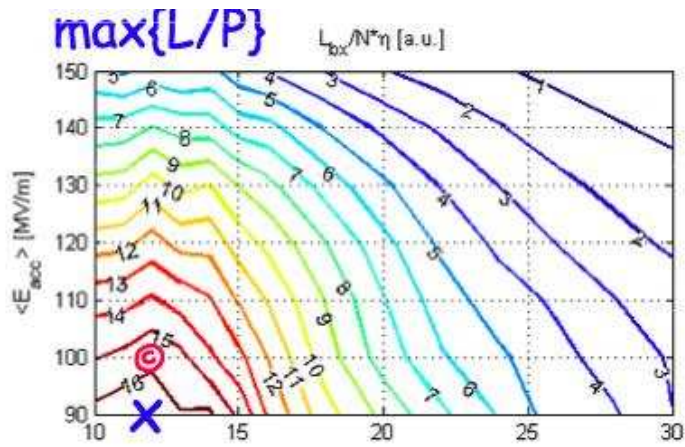

Results 2

$$FoM = L_{bx}/N \cdot n$$

BD

RF

BD optimum aperture:
 $\langle a \rangle = 2.6 \text{ mm}$

Why X-band?
 Crossing gives
 optimum frequency

RF optimum aperture:
 $\langle a \rangle / \lambda = 0.1 \div 0.12$

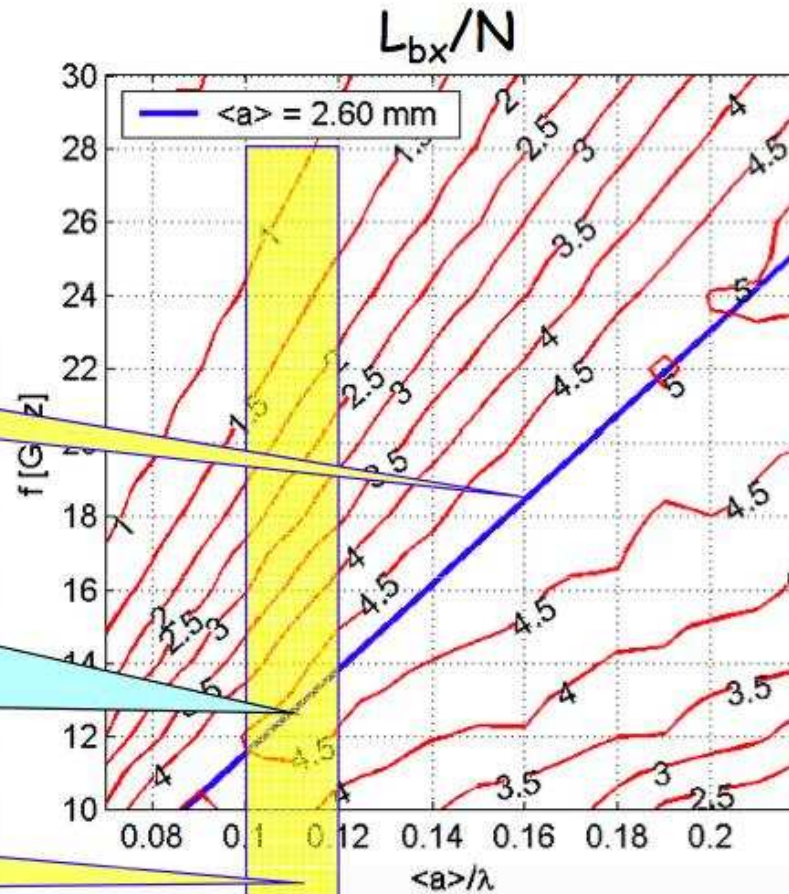

Energy and Phase Stability

Requirements

- The final energy needs to be accurately known for physics
 - measurement
- The final energy needs to be stable for physics
 - large energy variations would also cause luminosity loss due to limited BDS bandwidth
 - need to control final energy
- The emittance needs to be preserved in presence of static imperfections
 - differences between the actual and the assumed lattice can cause emittance growth
 - need to control energy profile
- The emittance needs to be preserved in presence dynamic imperfections
 - the energy profile needs to be stable
 - kicks due to cavity tilts need to be controlled
- Beam timing errors lead to luminosity loss
 - need to control bunch compressor RF stability

Main Linac RF Noise Sources (ILC)

- Lorentz force detuning
 - systematic from pulse to pulse
 - is largely corrected using piezo tuners in feed-forward
- Microphonics
 - unpredictable
 - corrected by klystron-based (or piezo-based) feedback
- Klystron amplitude and phase jitter
 - corrected by klystron based feedback
- Beam current variation
 - measure beam current at damping ring and use feed-forward for klystrons
- Feedback noise
 - measurement noise
 - feedback amplifies at some frequencies
- Jitter of timing reference
 - impacts feedback systems

Low Level RF Controls

- The low level RF control ties the RF phase to a timing reference and adjusts the gradient
- For each cavity one measures
 - field amplitude and phase
 - input power
 - reflected power
- As correctors are used
 - piezo tuners in each cavity
 - stepping motors
 - klystron amplitude and phase
- One needs a beam timing feedback
- The klystron-based feedback acts on the vector sum of all cavity gradients in a unit
- The sensors are calibrated measuring the field with and without beam
 - the field induced by the beam can be calculated
- Input and reflected power per cavity is measured
- Beam current is measured at damping ring and used for feed-forward

Final Energy Static Error

- We can expect systematic errors in the acceleration along the main linac
 - coherent calibration errors of amplitude and phase measurement in all RF units
 - random calibration errors of amplitude and phase in each RF unit
- The beam energy will be measured with the spectrometer and the detector
 - very high precision (10^{-4} , actually it will be precisely the “relevant energy”)
 - can remove coherent calibration errors
- We are left with random calibration errors
 - ⇒ they can cause emittance growth
- Typical parameters are accuracies of 1% and 1°
 - ⇒ should specify that this is acceptable (some work has been already done)
for 1.5% random acceleration error per unit, DFS still works
 - ⇒ should identify our limit

Final Energy Stability

- This is fundamental physics requirement
 - ⇒ has to be achieved by the control system
 - ⇒ let us try to see if this is the tightest tolerance
- Aim for 0.07% energy stability (RDR)
 - but for four error sources, should be reviewed
- Tolerance for coherent errors along main linac are
 - $\sigma_\phi \approx 0.4^\circ$
 - $\sigma_G = 0.07\%$
- Tolerance for independent errors per RF unit along main linac are about 16-times larger
 - $\sigma_\phi = 5.6^\circ$
 - $\sigma_G = 1\%$
- Phase tolerances depend on average RF phase used
- We would expect to have better stability but let us check if we do need it
- Check requirement of single cavity

CLIC RF Jitter Tolerance

- CLIC has similar limits for energy jitter than ILC
 - also luminosity loss is a concern
- Life is a bit more difficult since one drive beam complex powers the main linac
 - phase jitter coherent along each decelerator
 - component is coherent along the whole main linac
- Drive beam is produced at 1 GHz
 - ⇒ relative phase jitter is amplified by factor 12
- Mitigation strategy is to
 - stabilise drive beam accelerator current and RF
 - correct the phase at final turn-around

CLIC Layout

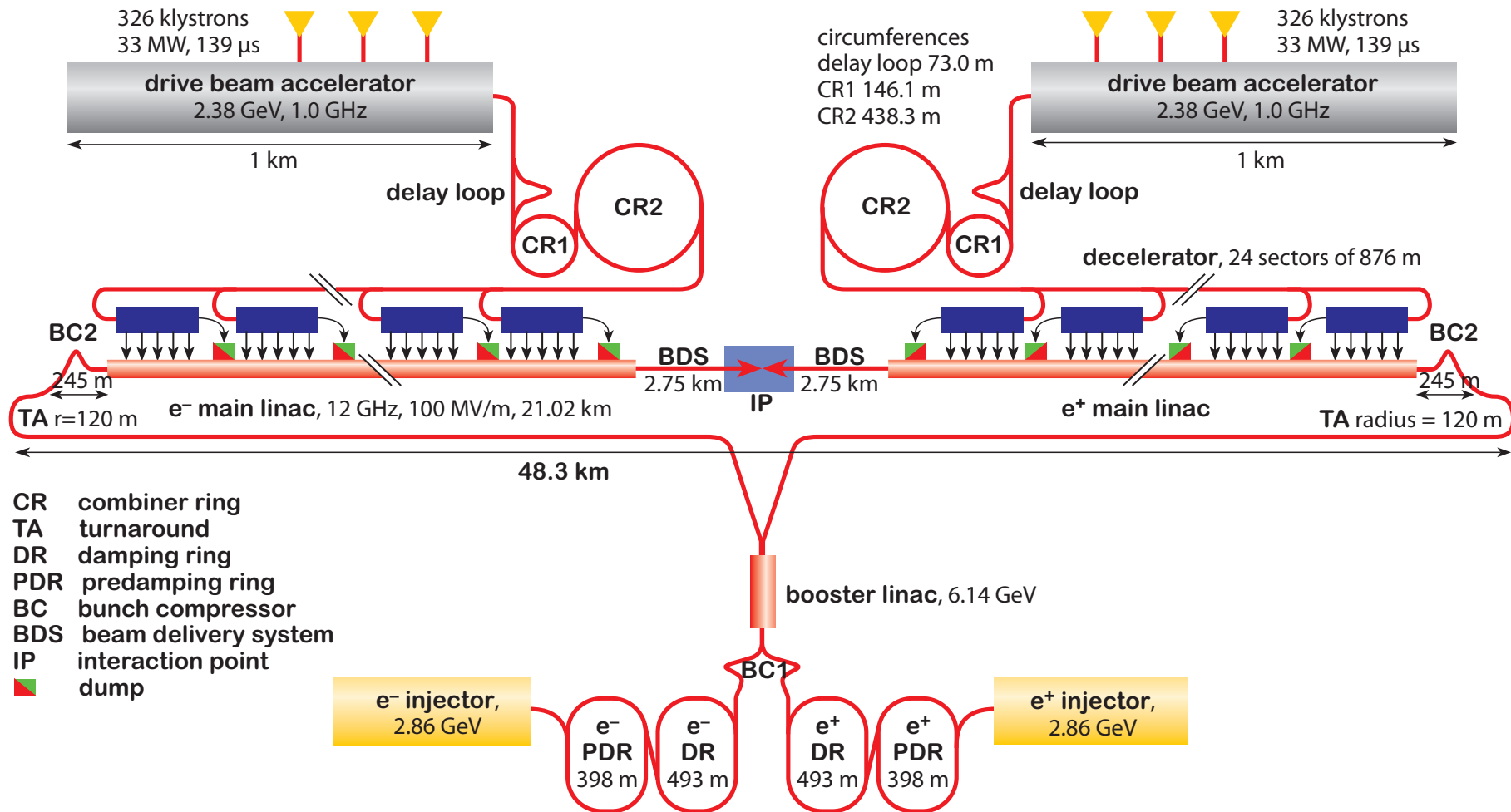

Feed-forward at Final Turn-Around

- Final feed-forward shown
 - ultima ratio
 - requires timing reference (FP6)
 - phase measurement/prediction (FP7)
 - tuning chicane (FP7, PSI)
- Measure phase and change of phase at BC1
- Adjust BC2 with kicker to compensate error
- One could also measure phase and energy at BC1
- Missing will be kicker and amplifier

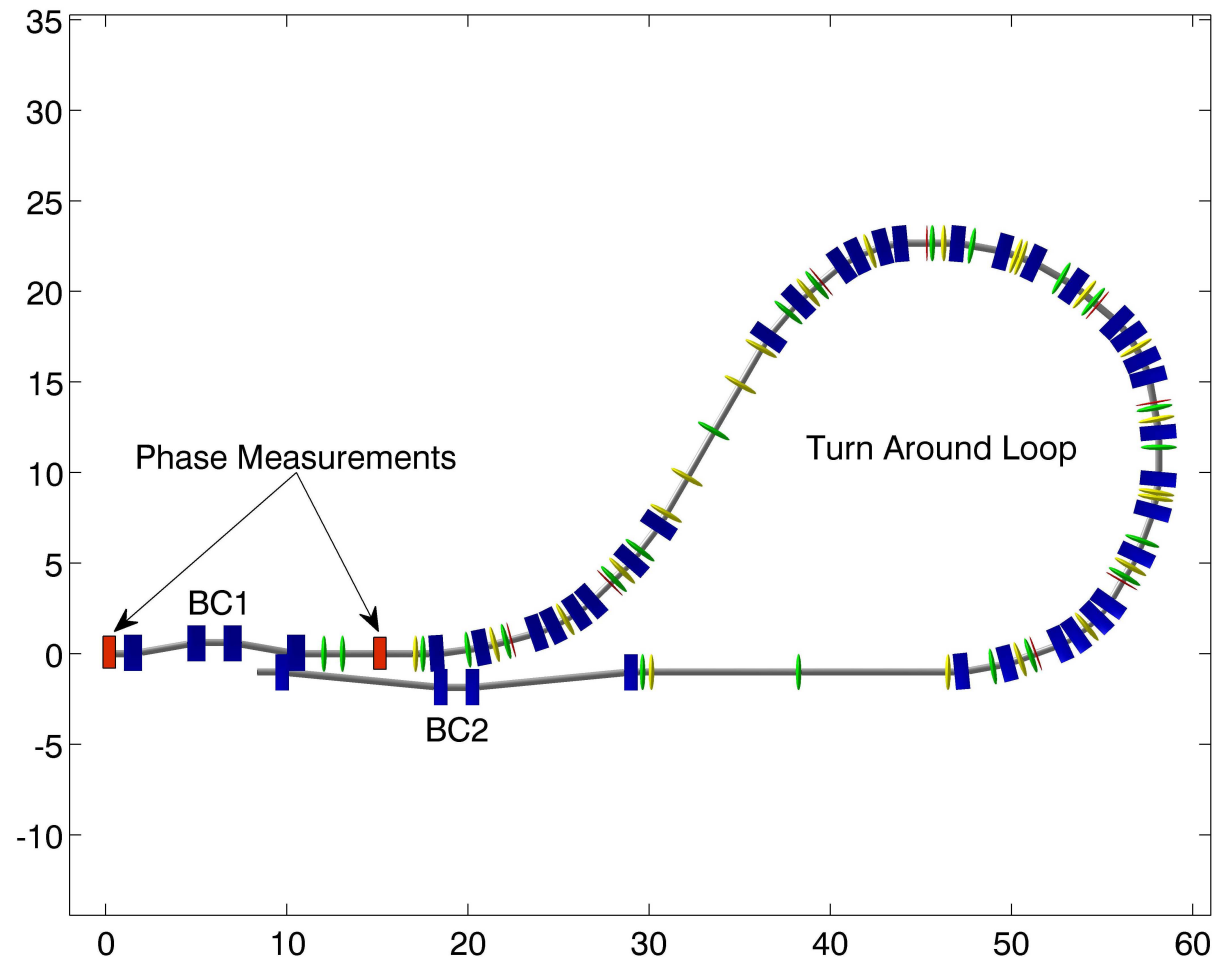

Thanks



- Many thanks to you for listening and to the people who helped me to prepare this lecture
 - with advice
 - with plots

Erik Adli, Alexej Grudiev, Erk Jensen, Jochem Snuverink, Igor Syrathev, Rolf Wegner, Walter Wuensch, Riccardo Zennaro, Frank Zimmermann