

Dynamic Imperfections

D. Schulte

Linear Collider School, October/November 2010

Stepping Stones

- Introduction
- Example: ground motion
- Feedback basics
- Main linac (CLIC example)
- Integrated studies (ILC example)

Introduction

- A large number of dynamic imperfections exist
 - e.g. ground motion, RF phase and amplitude jitter, element transverse jitter, magnet strength jitter, . . .
- They lead to luminosity reduction and fluctuation
 - but they can also impact correction of other imperfections
- Main mitigation is via hardware design/stabilisation and beam-based feedback
- Dynamic effects need to be addressed across the whole machine
 - but can start looking at individual areas, e.g. main linac

CLIC Example of Fast Imperfection Tolerances

- Many sources exist

Source	Luminosity budget	Tolerance
Damping ring extraction jitter	1%	
Magnetic field variations	?%	
Bunch compressor jitter	1%	
Quadrupole jitter in main linac	1%	$\Delta\epsilon_y = 0.4 \text{ nm}$ $\sigma_{jitter} \approx 1.8 \text{ nm}$
Structure pos. jitter in main linac	0.1%	$\Delta\epsilon_y = 0.04 \text{ nm}$ $\sigma_{jitter} \approx 800 \text{ nm}$
Structure angle jitter in main linac	0.1%	$\Delta\epsilon_y = 0.04 \text{ nm}$ $\sigma_{jitter} \approx 400 \text{ nradian}$
RF jitter in main linac	1%	
Crab cavity phase jitter	1%	$\sigma_\phi \approx 0.01^\circ$
Final doublet quadrupole jitter	1%	$\sigma_{jitter} \approx 0.1 \text{ nm}$
Other quadrupole jitter in BDS	1%	
...	?%	

Typical Time Dependence of Imperfections

- Neglect the potential spatial correlation, consider element j at timestep $i + 1$
- γ is a Gaussian random number

- Independent jitter (white noise)

$$y_{i+1,j} = \gamma_{i+1,j}$$

the element jitters around a fixed position

- Random walk (attention, also called drift)

$$y_{i+1,j} = y_{i,j} + \gamma_{i+1,j}$$

the element moves around the new position

- Systematic drift

$$y_{i+1,j} = y_{i,j} + \delta_j$$

the element moves systematically in one direction

What is Needed to Characterise the Imperfection?

- Example of ground motion
- We need full model of imperfections
 - ground motion
 - transfer through girder and elements
 - active stabilisation feedback (CLIC)

Example Imperfection: Ground Motion and Mechanics

A Simple Ground Motion Model

- For times of the order of seconds ground motion can be approximated by the ATL model
 - the relative RMS motion of two points separated by L , after the time T is given by

$$\langle (\Delta y)^2 \rangle = ATL$$

where A is a site dependent parameter

- The ATL-law represents a relative motion of points as a random walk in time and space
 - for element $j + 1$ at timestep $i + 1$ it can be simulated as

$$y_{i+1,j+1} = y_{i,j+1} + y_{i+1,j} - y_{i,j} + \sqrt{A\Delta t(s_{j+1} - s_j)}\gamma_{i+1,j+1}$$

A More Complete Ground Motion Model

- Especially for short times the motion of different points can be correlated
- This can be modelled as waves of ground motion, which are described by by mode spectrum $C(\omega, \lambda)$

- This can be modelled as

$$y(s, t) = \sum_{k,l}^{N_k, N_l} C_{kl} [\sin(\omega_k t) \sin(k_l s + \phi_{kl}) + (\cos(\omega_k t) - 1) \sin(k_l s + \psi_{kl})]$$

- This can be simulated, some tricks are useful to improve the efficiency of the calculation

Example of Technical Noise

- Measurements in this example can be well approximated by

$$a(\omega) = \frac{a_0}{1 + \left(\frac{\omega}{\omega_0}\right)^6}$$

- That means technical noise looks like random pulse to pulse jitter

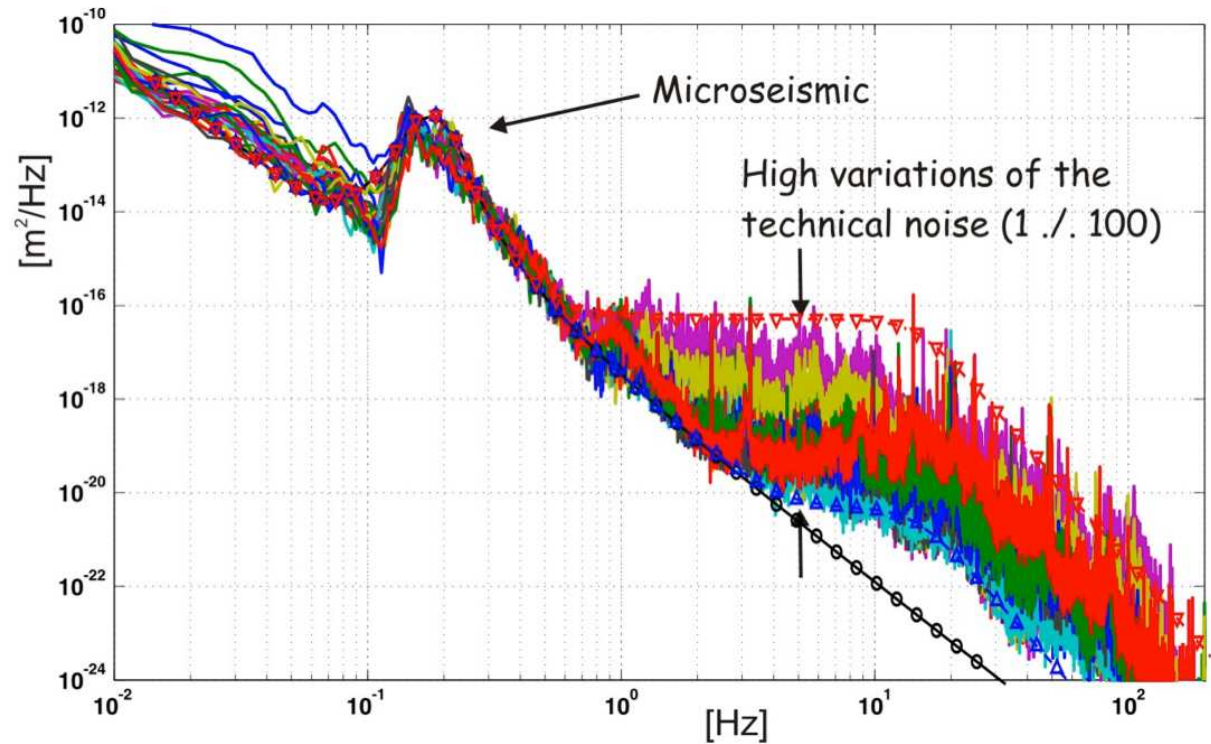

Ground Motion Correlations

K. Artoos and M. Guinchard, CLIC Workshop (16 October 2008)



LHC Measurements

LHC DCUM 1000
~ 80 m under ground

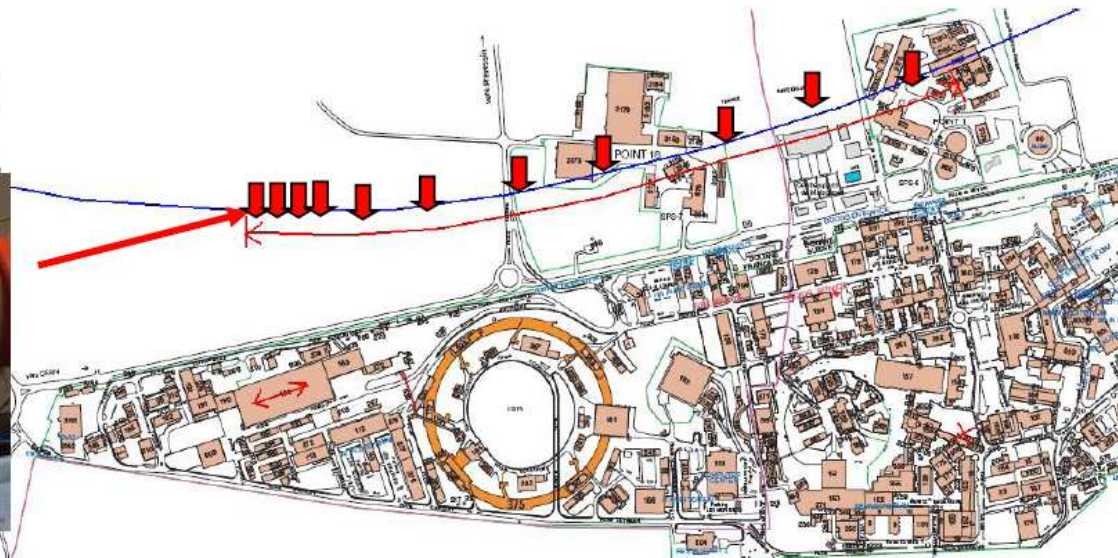

Measurements: 0 1 2 3 4 5 6 7 8 9 10 12 20 30 38 54 108 198 306 412 509 604 706 960 (m)

Specific features :

- Synchronous measurements
- LHC systems in operation, night time
- Multi-directional

Ground Motion Correlations

Coherence using a theoretical model

(Seryi and Napoly, Phys. Rev. E 53)

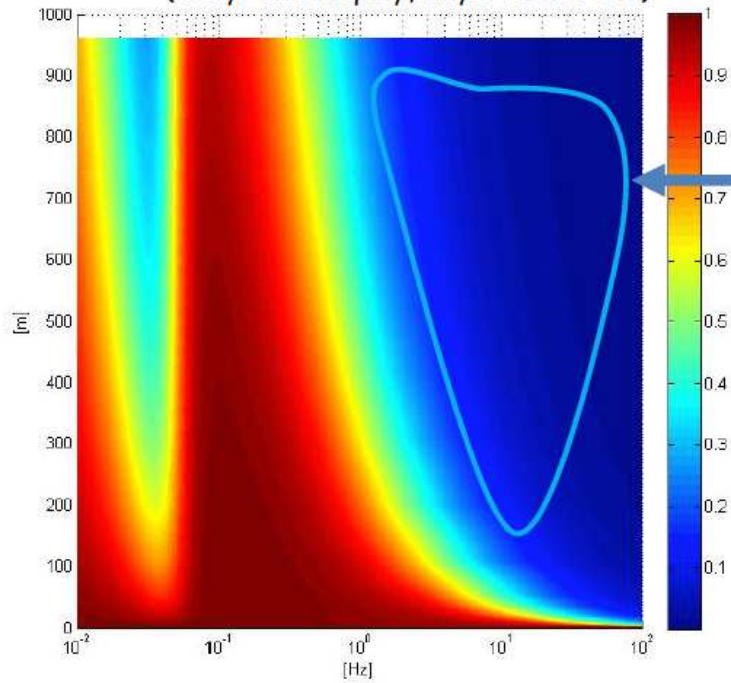

Calculated from measurement

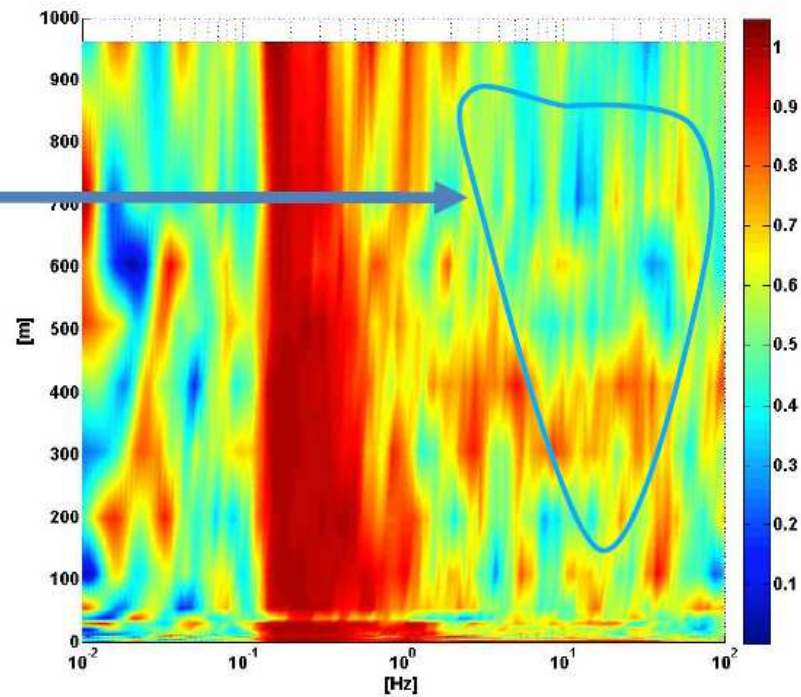

Impact of the Supporting Girder

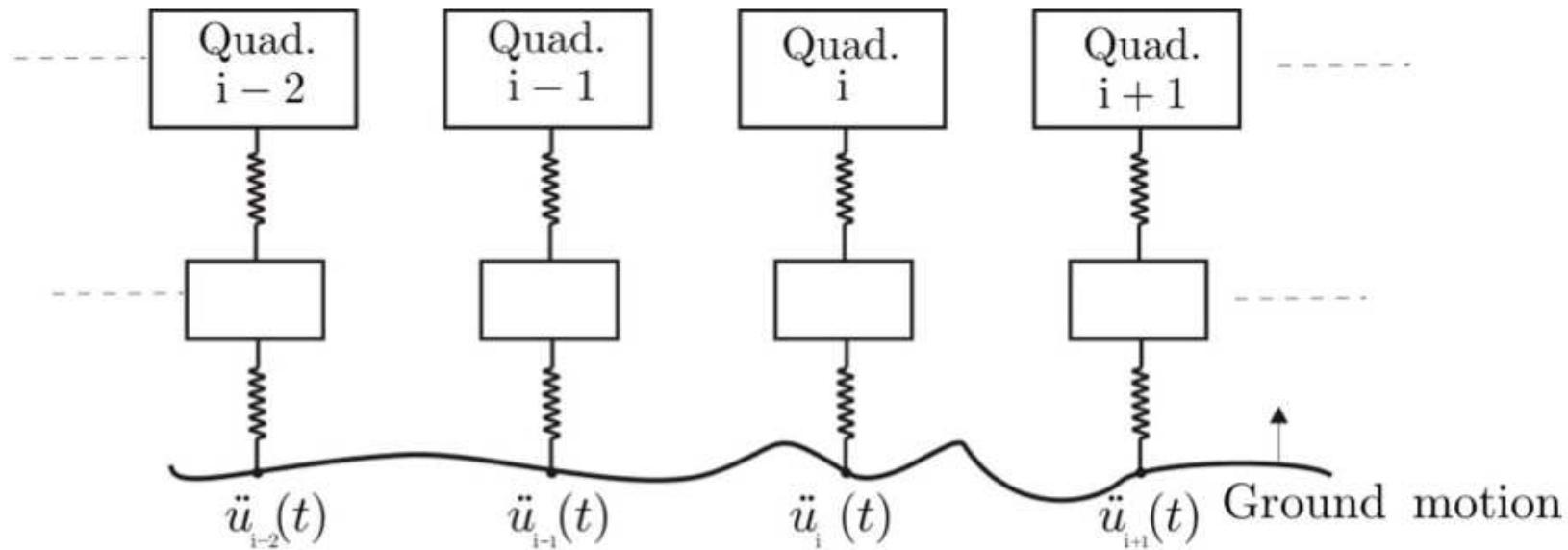

- The quadrupole
- The impact of the supporting girder can be characterised by the simple model

$$T(\omega) = a(\omega) \exp(i\phi(\omega))$$

original ground noise P_0 becomes P at quadrupole

$$P(\omega) = |T(\omega)|^2 P_0(\omega)$$

Example Transfer Function

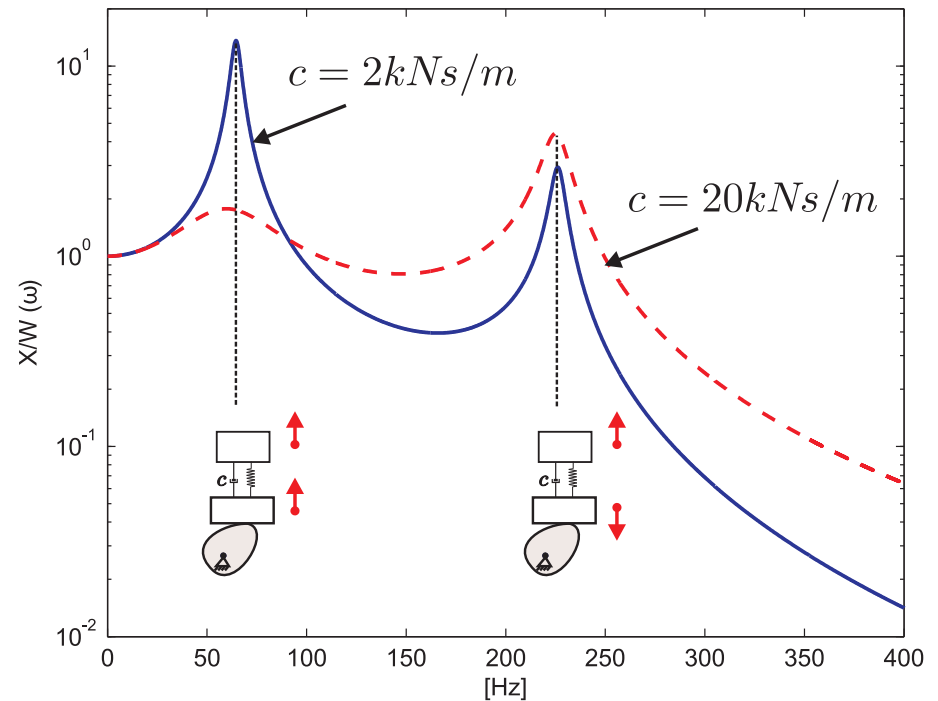
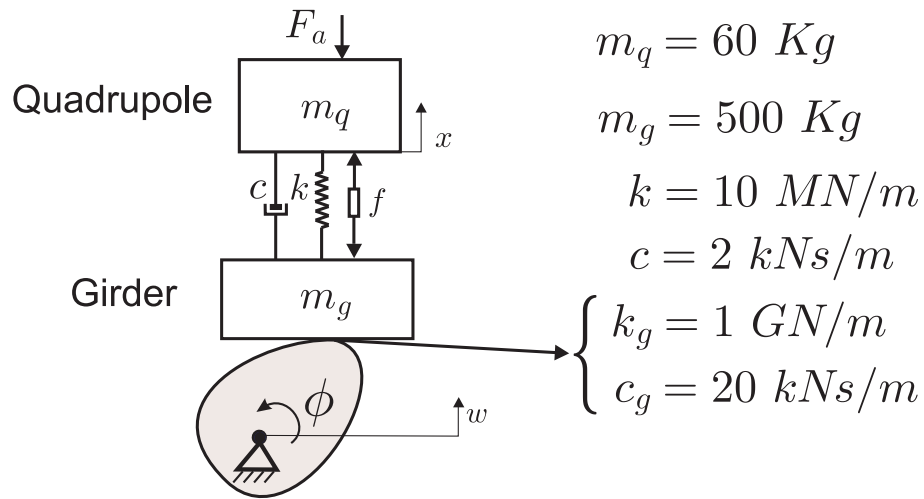

- A very simple model is that of a harmonic oscillator
 - the support is the spring
 - generally can calculate resonance frequencies but the damping is more difficult
- Generally:
 - full transmission for low frequencies
 - suppression of high frequencies
 - resonances in between

Oscillation Modes

Modal analysis of the 2m long quad. with 6 mounts

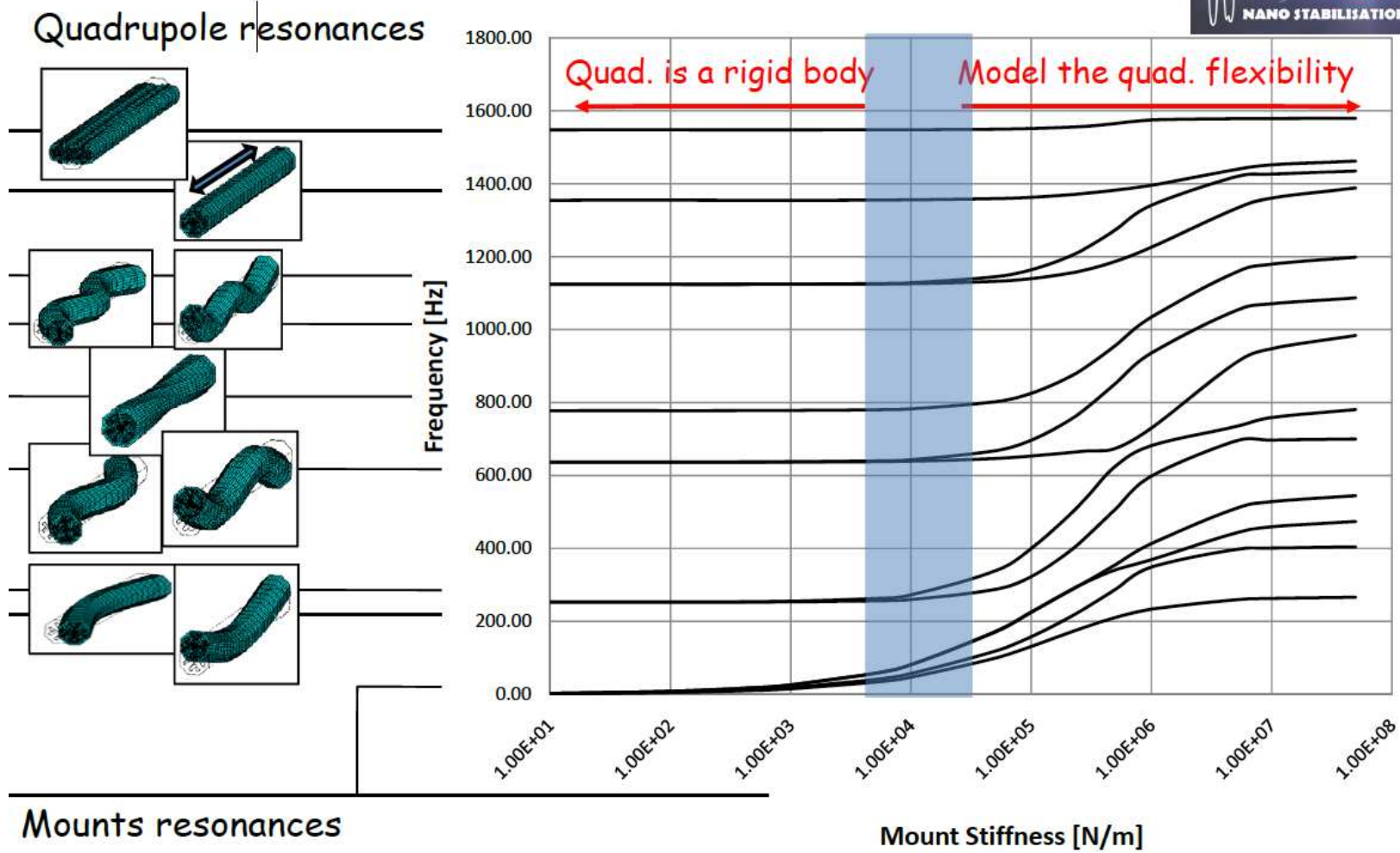

Active Stabilisation

- Need sensors and correctors
 - can measure acceleration
- ⇒ feedback works for high frequencies
- ⇒ but not for low frequencies

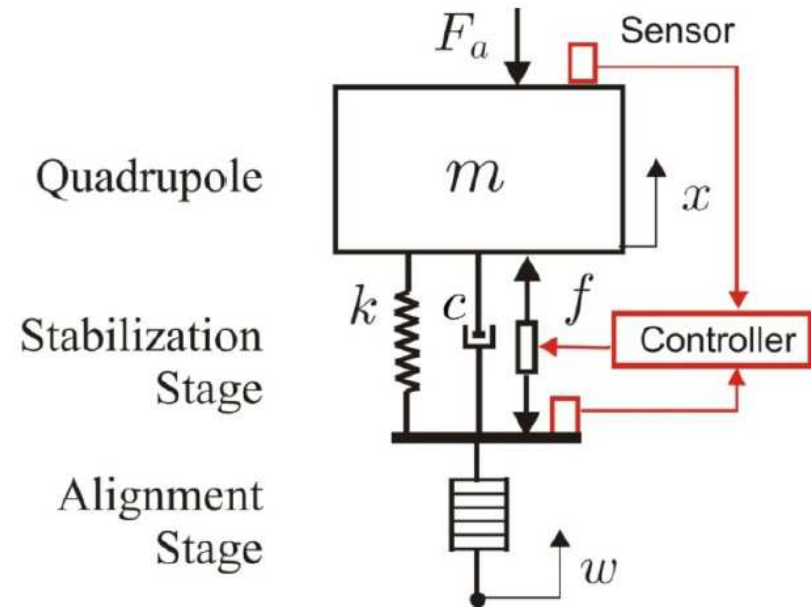

Main Linac Quadrupole Support

- Mechanical stabilisation is essential
- Two concepts have been developed
 - soft support (Anncy)
 - rigid support (CERN)

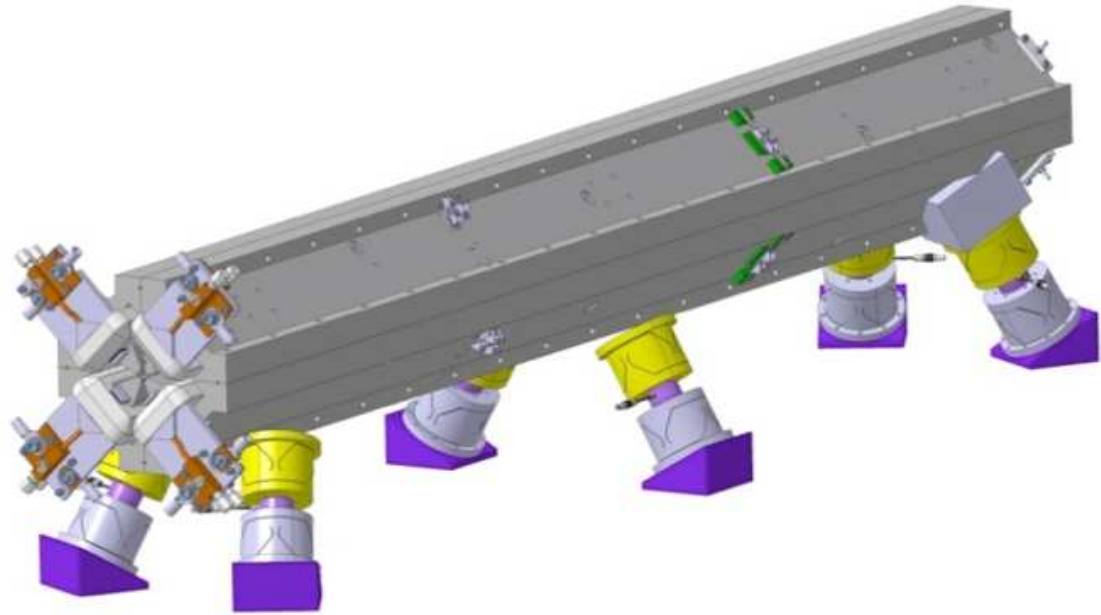

C. Hauviller, K. Artoos, Ch. Collette et al.

Time Dependent Luminosity Loss/Emittance Growth

- Luminosity for first time step is $\Delta\mathcal{L}_0$, starting from static machine
- Luminosity loss/emittance growth are quadratic with the size of the imperfection (for small enough range)
- For the different dynamic imperfection types we find (in linear approximation)

- pulse-to-pulse jitter

$$\langle \Delta\mathcal{L}_n \rangle = \Delta\mathcal{L}_0$$

- ATL like motion

$$\langle \Delta\mathcal{L}_n \rangle = n\Delta\mathcal{L}_0$$

- slow drifts

$$\langle \Delta\mathcal{L}_n \rangle = n^2\Delta\mathcal{L}_0$$

- for mode model situations is somewhat complex
- feedback cannot help in the first case

Example: Quadrupole Jitter

- Want to estimate relative beam jitter Δ at the end of the linac due to quadrupole jitter δ
- Calculate the normalised local kick

$$\frac{\Delta y'_i}{\sqrt{\frac{\epsilon_y}{\beta_y \gamma}}} = \frac{\delta_i}{f_i} \frac{1}{\sqrt{\frac{\epsilon_y}{\beta_{y,i} \gamma_i}}}$$

- For the RMS we sum over all quadrupoles leads to

$$\left\langle \frac{\Delta^2}{\sigma_y^2} \right\rangle = \sum_{i=0}^n \frac{\delta_i^2}{f_i^2} \frac{\beta_{y,i} \gamma_i}{\epsilon_y} \sin^2(\phi_f - \phi_i)$$

- To simplify, we approximate the sum over \sin^2 with $1/2$, since

$$\frac{1}{2\pi} \int_0^{2\pi} \sin^2(x) dx = \frac{1}{2}$$

Calculation of the Average Beta-Function

- Want to calculate the effective mean beta-function

$$\beta = \frac{1}{2} (\hat{\beta} + \check{\beta})$$

we use

$$\hat{\beta} = L \frac{\kappa(\kappa + 1)}{\sqrt{\kappa^2 - 1}} \quad \check{\beta} = L \frac{\kappa(\kappa - 1)}{\sqrt{\kappa^2 - 1}}$$

with $\kappa = \frac{2f}{L}$, which yields

$$\beta = L \frac{\kappa^2}{\sqrt{\kappa^2 - 1}}$$

which could also be written as

$$\beta = L \frac{4 \frac{f^2}{L^2}}{\sqrt{4 \frac{f^2}{L^2} - 1}}$$

Application to CLIC

- We replace the sum with an integral for CLIC

$$f = f_0 \sqrt{\frac{E}{E_0}} \quad L = L_0 \sqrt{\frac{E}{E_0}}$$

with $L_0 = 1.5 \text{ m}$ and $f_0 = 1.3 \text{ m}$

$$\left\langle \frac{\Delta^2}{\sigma_y^2} \right\rangle \approx \frac{\delta^2}{2\epsilon_y} \int_{E_0}^{E_f} L \frac{\frac{4f^2}{L^2}}{\sqrt{\frac{4f^2}{L^2} - 1}} \frac{\frac{E}{mc^2}}{f_0^2 \frac{E}{E_0}} \frac{1}{L} \frac{1}{\eta_{fill} e G} dE$$

$$\Rightarrow \left\langle \frac{\Delta^2}{\sigma_y^2} \right\rangle \approx \frac{\delta^2}{2\epsilon_y} \frac{1}{f_0^2 L_0} \frac{1}{\eta_{fill} e G} \frac{\frac{4f_0^2}{L_0^2}}{\sqrt{\frac{4f_0^2}{L_0^2} - 1}} \frac{E_0}{mc^2} \int_{E_0}^{E_f} dE$$

$$\Rightarrow \left\langle \frac{\Delta^2}{\sigma_y^2} \right\rangle \approx \frac{\delta^2}{2\epsilon_y} \frac{1}{f_0^2} \frac{E_0}{mc^2 \eta_{fill} e G} \frac{\frac{4f_0^2}{L_0^2}}{\sqrt{\frac{4f_0^2}{L_0^2} - 1}} (E_f - E_0)$$

$$\left\langle \frac{\Delta^2}{\sigma_y^2} \right\rangle \approx 0.025 \left(\frac{\delta}{\text{nm}} \right)^2$$

Feedback

Stability and Feedback

- Stability is required to avoid luminosity degradation of a tuned machine
 - beam-based feedback will be used for low-frequency motion
 - typical luminosity with feedback is loss

$$\Delta\mathcal{L}_{total} = \Delta\mathcal{L}_{uncorr}(g) + \Delta\mathcal{L}_{noise}(g) + \Delta\mathcal{L}_{residual}(t)$$

$\Delta\mathcal{L}_{uncorr}$ actual dynamic effect that is not yet corrected/amplified

How fast does the feedback need to be?

$\Delta\mathcal{L}_{noise}$ feedback tries to correct dynamic effect that is faked by diagnostics noise

How good does the feedback need to be?

$\Delta\mathcal{L}_{residual}$ local feedback cannot correct all global effects

For how long is the feedback sufficient?

Difference between ILC and CLIC

- In ILC, the long bunch separation allows for intra-train feedback at the end of the main linac
 - ⇒ relevant measure is the emittance growth
 - ⇒ speed of convergence is also important
- In CLIC the train is too short
 - ⇒ relevant is the multi-pulse emittance
 - the projected emittance of subsequent pulses overlaid

Most Simple Feedback Example

- Correct pulse to pulse
- Have a set of BPMs and a set of correctors
- Know the effect of changing the current in corrector i by δ_i leads to beam trajectory change in BPM j of $r_{j,i}$

- Unperturbed system prediction is then

$$\mathbf{y}_{i-1} - \mathbf{y}_i = R\delta_i$$

- Correction is calculated as

$$\delta_i = -gR^{-1}\mathbf{y}_i$$

R^{-1} is the pseudo-inverse

- For simplification assume that R^{-1} is the inverse and is precisely known one finds

$$\mathbf{y}_{i+1} = \mathbf{y}_i + R\delta_i = \mathbf{y}_i - gRR^{-1}\mathbf{y}_i = \mathbf{y}_i - g\mathbf{y}_i$$

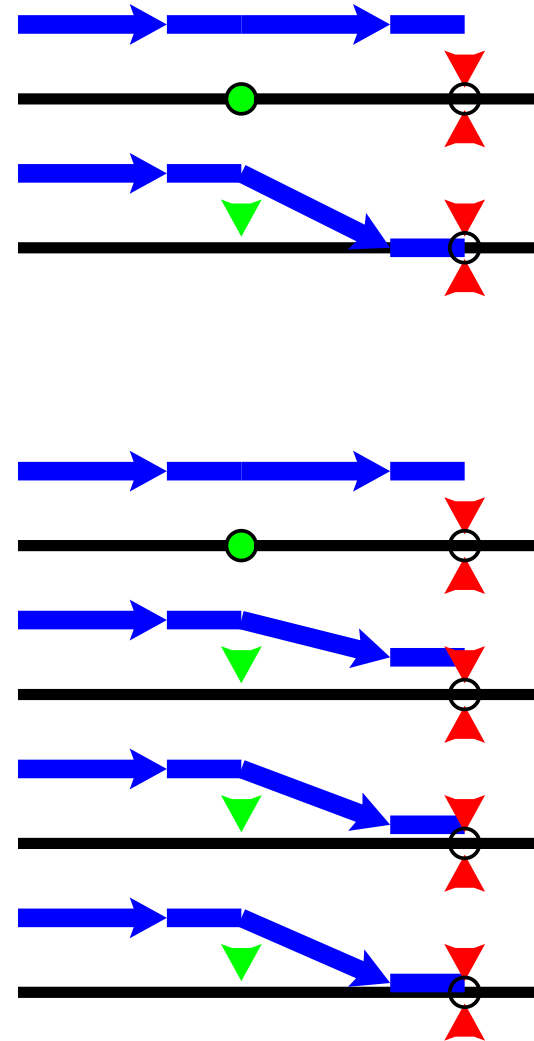

Simple Feedback Transfer Function

- The simplest feedback is to use

$$y_{n+1} = y_n - g \times y_n + \gamma_n$$

- In our linear case the feedback can be described by its transfer function

$$p(\omega) = p_0(\omega)|T(\omega)|^2$$

p noise with feedback

p_0 noise without feedback

T feedback transfer function

- Noise added by the feedback can also be written in this form

$$p(\omega) = p_0(\omega)|T(\omega)|^2 + p_1(\omega)$$

p_1 noise added by feedback, e.g. BPM noise

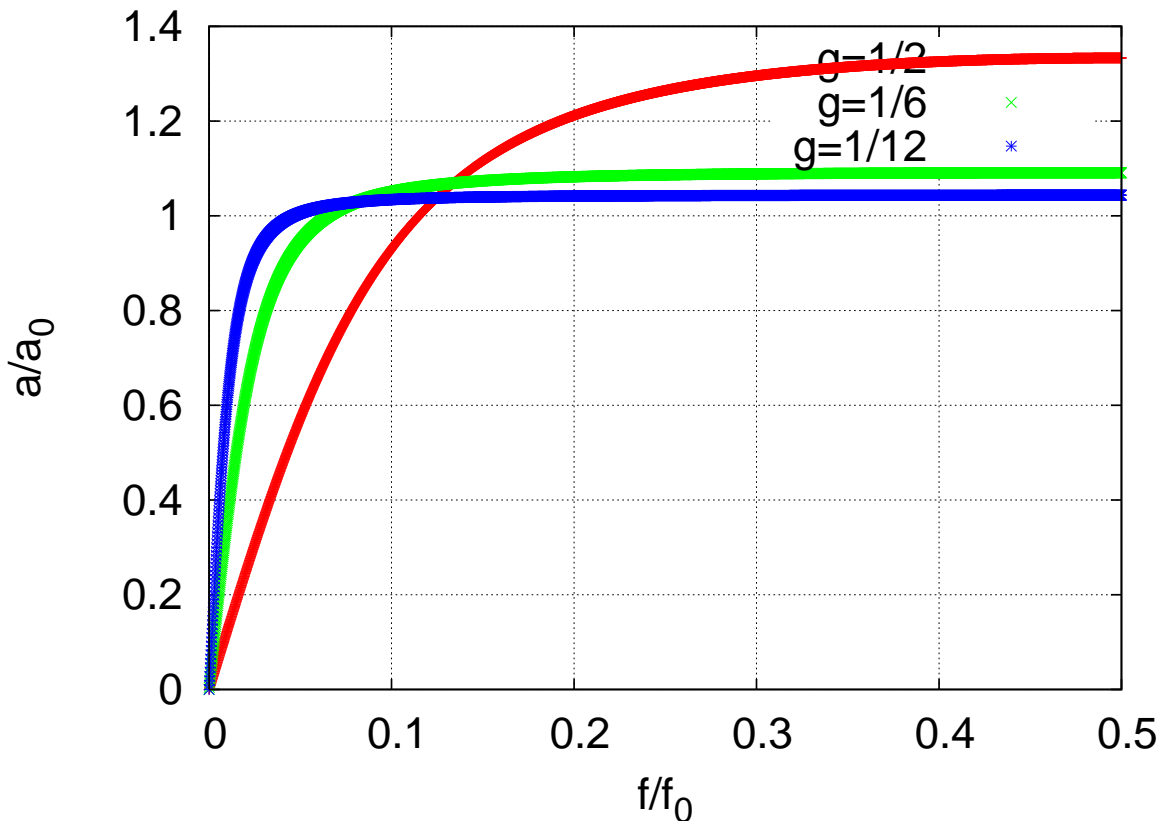

Simple Feedback Transfer Function Calculated

- The impact of a feedback can usually be described by the transfer function R in frequency domain

$$\tilde{X}(\omega) = T(\omega)\tilde{x}(\omega)$$

x is the motion with no feed back, X is the motion with feedback

- For our simple feedback we calculate $T(\omega)$
Difference equation for our system is

$$X_{n+1} - X_n = (x_{n+1} - x_n) - gre(X_n)$$

for motion only at the frequency ω we exploit $X_{n+1} = X_n \exp(-i\omega\Delta t)$ and $x_{n+1} = x_n \exp(-i\omega\Delta t)$

$$\Rightarrow (\exp(-i\omega\Delta t) - 1)X_n = (\exp(-i\omega\Delta t) - 1)x_n - gre(X_n)$$

$$\Rightarrow (\exp(-i\omega\Delta t) - 1)T(\omega)x_n = (\exp(-i\omega\Delta t) - 1)x_n - gre(T(\omega)x_n)$$

to simplify our life we chose the moment where $T(\omega)x_n$ is real

$$\Rightarrow (\exp(-i\omega\Delta t) - 1)T(\omega) = (\exp(-i\omega\Delta t) - 1) - gT(\omega)$$

$$\Rightarrow T(\omega) = (\exp(-i\omega\Delta t) - 1)/(\exp(-i\omega\Delta t) - 1 + g)$$

- Test $g = 0$

$$T(\omega) = 1$$

- Test $\omega\Delta t \rightarrow 0, g \neq 0$

$$T(\omega) = 0$$

Examples for Simple Models

- The feedback will change the required stability

- look at $\Delta L_{uncorr}(g)$ first

- The simplest feedback is to use

$$\Delta y_{n+1} = \Delta y_n - g \times y_n$$

- For the different noise types we find

- pulse-to-pulse jitter

$$\Delta L(n) = \Delta L_0 \quad \rightarrow \quad \Delta L_{uncorr} = \Delta L_0 \frac{2}{2-g}$$

- ATL like motion

$$\Delta L(n) = n\Delta L_0 \quad \rightarrow \quad \Delta L_{uncorr} = \Delta L_0 \frac{1}{g(2-g)}$$

- slow drifts

$$\Delta L(n) = n^2\Delta L_0 \quad \rightarrow \quad \Delta L_{uncorr} = \Delta L_0 \frac{1}{g^2}$$

Not Yet Corrected Growth Calculated

- Random walk

RMS offset is given by

$$\langle \Delta x^2 \rangle = \sum_{i=0}^{\infty} \gamma_i^2 \sigma^2 (1-g)^{2i}$$
$$\Rightarrow \langle \Delta x^2 \rangle = \sigma^2 \frac{1}{g(2-g)}$$

- White noise

RMS offset is given by

$$\langle \Delta x^2 \rangle = \gamma_0^2 \sigma^2 + g^2 \sum_{i=1}^{\infty} \gamma_i^2 \sigma^2 (1-g)^{2(i-1)}$$
$$\Rightarrow \langle \Delta x^2 \rangle = \sigma^2 \frac{2}{2-g}$$

- Systematic motion

$$\langle \Delta x^2 \rangle = (\Delta x_0)^2 \left(\sum_{i=0}^{\infty} (1-g)^i \right)^2$$
$$\Rightarrow \langle \Delta x^2 \rangle = \sigma^2 \frac{1}{g^2}$$

Another Feedback Transfer Function

- Feedback with recursive filter

$$\mathbf{a}_n = \frac{1}{m} \times \mathbf{y}_n + \left(1 - \frac{1}{m}\right) \times \mathbf{a}_{n-1}$$
$$\Delta y_{n+1} = \Delta y_n - a_n$$

- For slow drifts

$$\Delta \mathcal{L}_{uncorr} = \Delta \mathcal{L}_0$$

⇒ good low frequency behaviour

- For jitter for large m

$$\Delta \mathcal{L}_{uncorr} \approx 1.5 \Delta \mathcal{L}_0$$

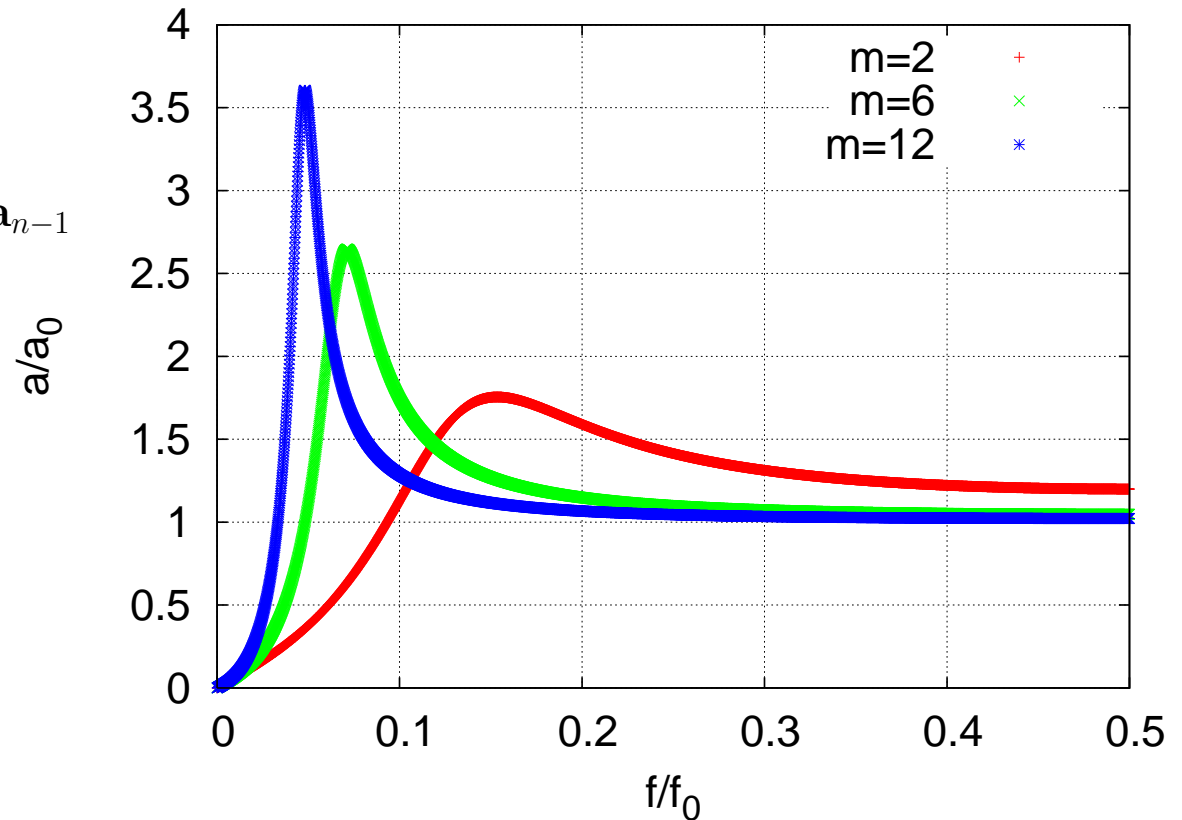

- For CLIC at 1 Hz amplification is 0.27 (m=12), 0.16 (m=6), 0.13 (m=2)
- At 4 Hz m=2 is marginal
- Will have to fold with ground motion/transfer function

Example: Simplified Feedback Model

- Ignore incoming beam jitter
- Assume linear system response
- Home-made controller
 - serious study of controller design started in Annecy (B. Caron et al.)
 - ⇒ integration needed

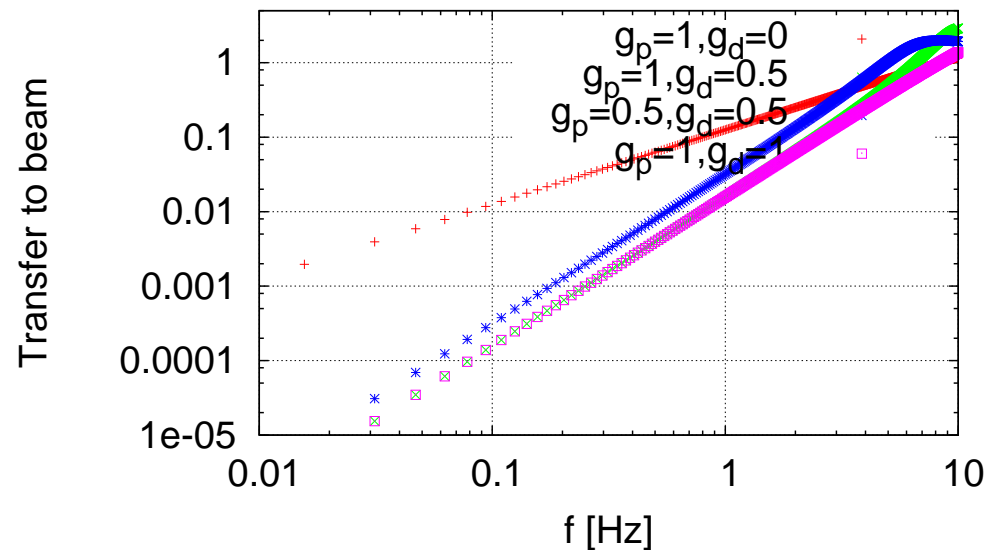
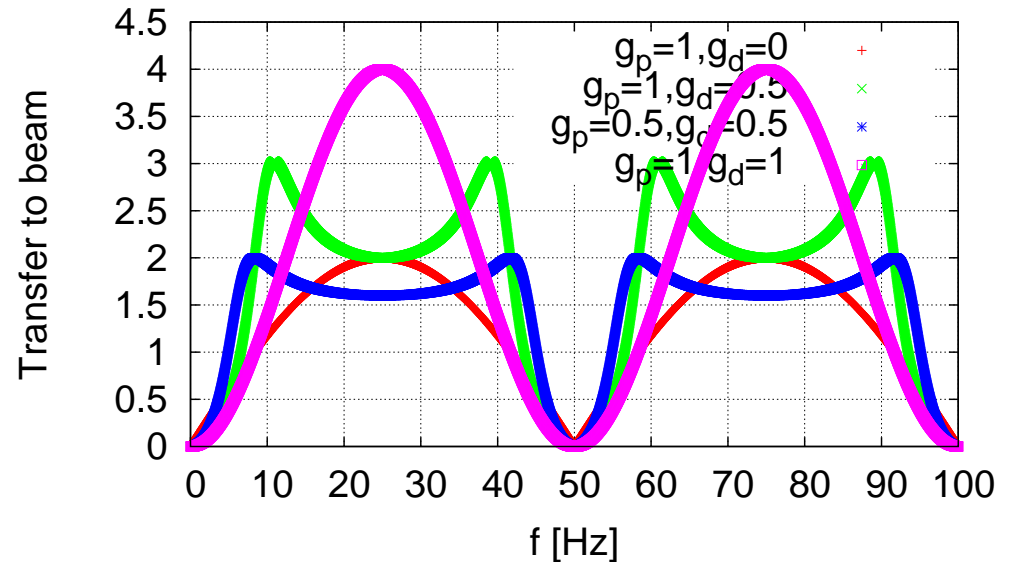

Final Doublet Support

- Heavy mass on a spring
- Mechanical low pass filter

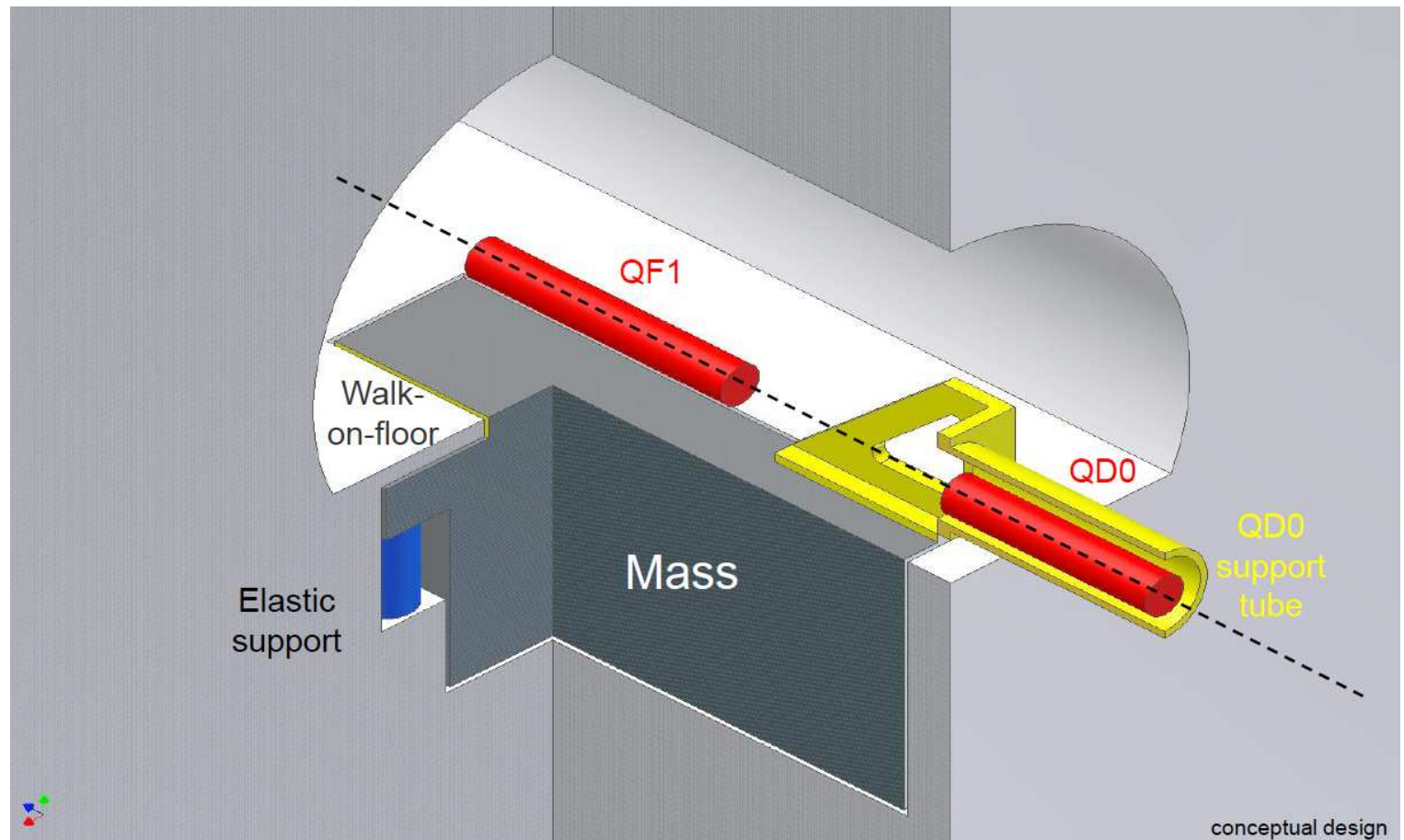

Alain Herve, Andrea Gaddi, Huber Gerwig

Example: Pre-Isolator and ML Quadrupole

- Transfer functions are known
 - for the final doublet support (pre-isolator)
 - for the main linac quadrupoles
 - Need to check, if model is good enough
- Transfer functions from F. Ramos and Chr. Collette

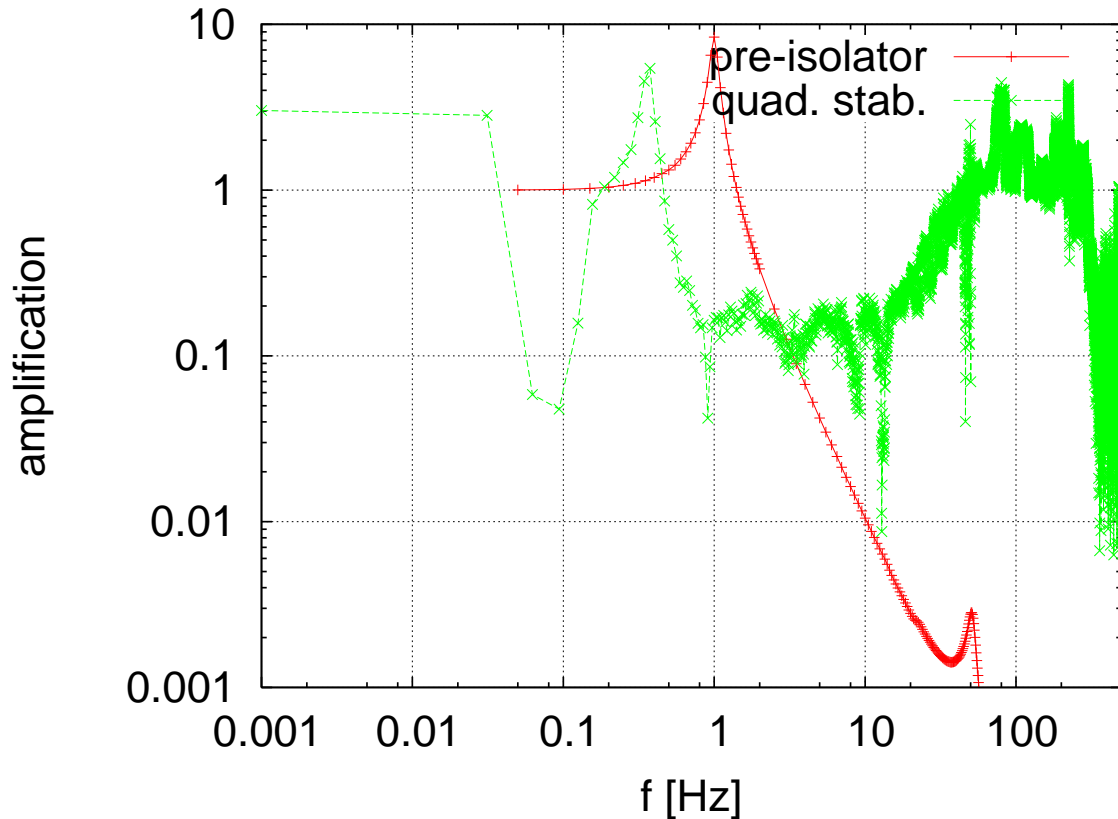

Pre-Isolator Result

- Consider only final doublet with 5 nm RMS jitter

$$P(\omega) = P_0 \frac{1}{1 + \left(\frac{\omega}{\omega_0}\right)^6}$$

$$\omega_0 = 40\pi$$

- Beam-based feedback and pre-isolator
 - two different controllers used

⇒ Looks OK

$$\langle y^2 \rangle = \int_0^\infty |T_B(\omega)|^2 p_Q(\omega) + p_N(\omega) d\omega$$

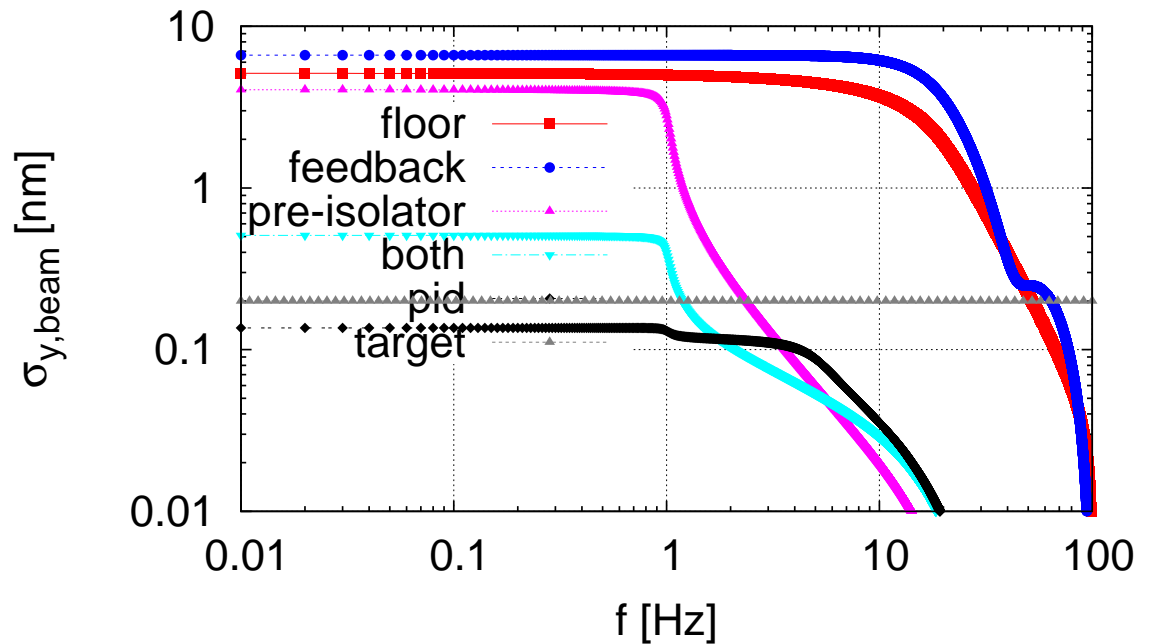
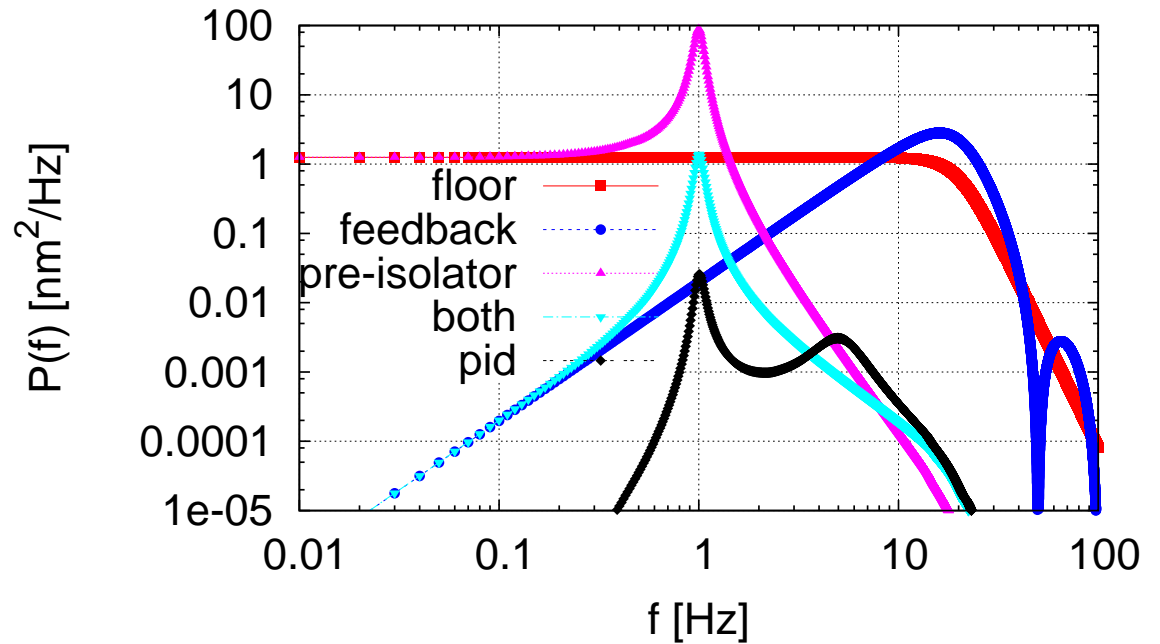

Main Linac

Main Linac Feedback Strategy

- Stabilisation of elements using local mechanical feedback (CLIC only)
- Information from survey system is only recorded, not used directly (CLIC only)
- Intra-pulse beam feedback
 - only possible in ILC (at CLIC at the interaction point)
- Pulse-to-pulse feedback
 - main linac orbit feedback, RF phase and amplitude feedback
- Re-tuning
 - slow process in the main linac
- Complex beam-based alignment and tuning
 - not in normal running conditions
- Other feedback systems exist (e.g. RF feedback)
- Independent feedbacks on the same property will have to share the overall feedback bandwidth
 - ⇒ try to combine as much as possible
 - but need to know response

Single vs Multiple Feedback Loops

- If independent feedback loops correct the same thing the system can become unstable
 - ⇒ need to share bandwidth
 - ⇒ correction becomes small

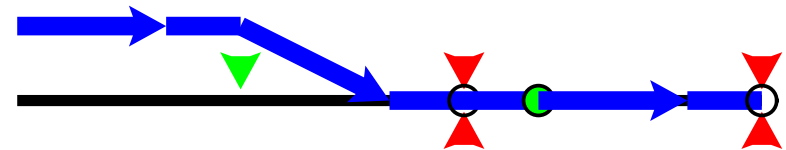
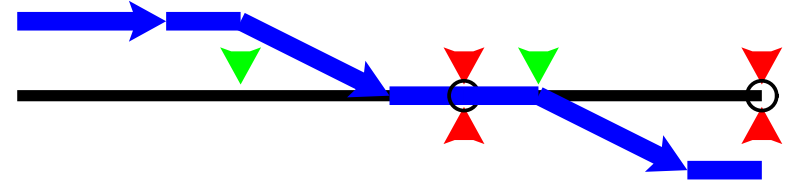
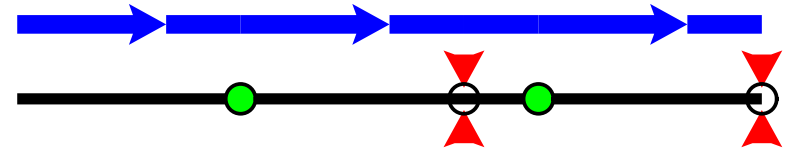

Overall Fast Beam Feedback Design

- Main basis will be a fast BPM-based orbit feedback
 - ⇒ feedback on same beam property at different locations
- Three alternatives considered
 - chain of independent MIMOs, have to share bandwidth, slow
 - chain of decoupled MIMOs, but no perfect decoupling (CLIC)
 - single MIMO, model error needs to be studied
- Except for collision point beam position and angle will be corrected by each feedback

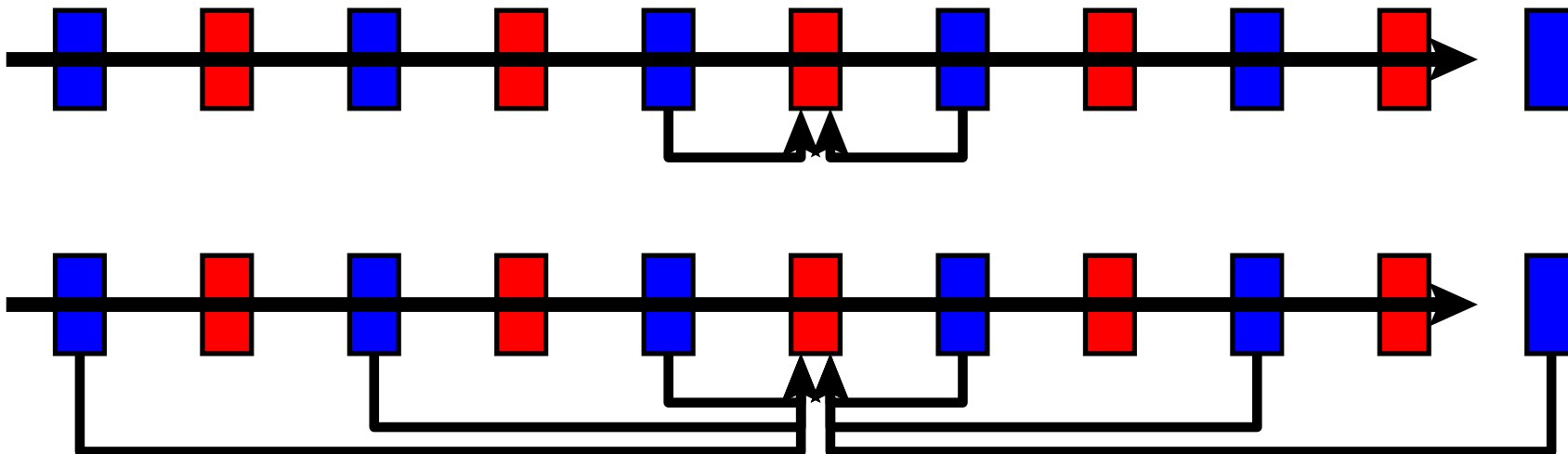

Main Linac Feedback (CLIC)

- Comparison of decoupled feedback and MIMO

- $N_f = 40$ feedback stations
- some quadrupole misalignment, then feedback on stable machine
- perfect knowledge of response assumed

- Corrector step size for feedback is 5 nm with 2 nm precision

- to avoid emittance growth due corrector noise

- Independent feedback loops slow convergence down

⇒ MIMO controller is better

- but system knowledge is important (also for decoupled feedback)

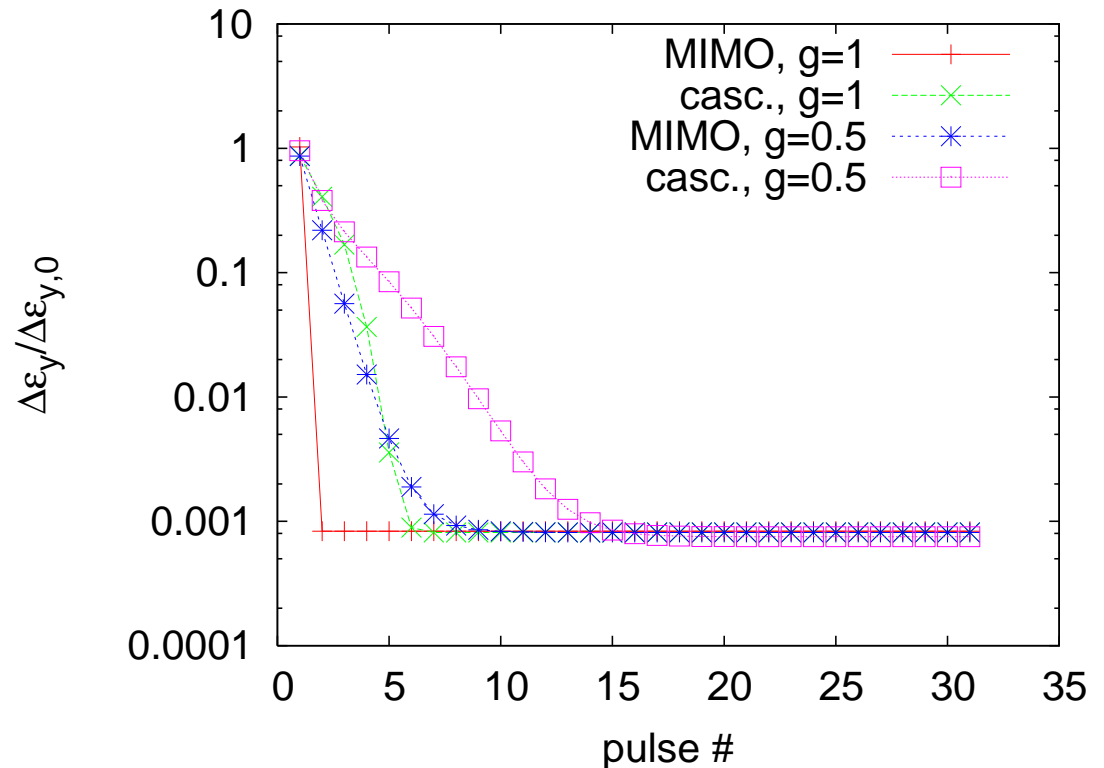

Main Linac BPM Resolution

- The BPM resolution will limit the feedback bandwidth
- Assume pulse-to-pulse uncorrelated BPM readout jitter
- Emittance growth (corresponding to $\Delta\mathcal{L}_{noise}$) can be estimated as function of gain g by

$$\Delta\epsilon = \Delta\epsilon_0 \left(g^2 \sum_{i=0}^{\infty} (1-g)^{2i} \right)$$
$$\Delta\epsilon = \Delta\epsilon_0 \left(\frac{g}{2-g} \right)$$

- For 100 nm resolution, the emittance growth is $\Delta\epsilon_0 \approx 0.3$ nm
- ⇒ Even for large gains $g \leq 1/2$ the emittance growth should be small
- BPM resolution is determined by need to see beam jitter
 - beam jitter is measured in vertically focusing quadrupoles
 - beam is smallest at the end of the linac
 - with $\beta_y \approx 65$ m and $\epsilon_y \approx 10$ nm we find $\sigma_y \approx 465$ nm
- ⇒ require BPM resolution of about 50 nm

Impact of Corrector Step Error

- The steps performed by the correctors may not be predictable
 - will lead to additional emittance growth
- A random error in the corrector step can be regarded as quadrupole jitter
- A simple estimate of allowed error is given by

$$\sigma_{step} \approx \sigma_{jitter} \sqrt{\frac{N_{quad}}{N_{corrector}}}$$

$N_{corrector}$ is the number of correctors used

- To be negligible for $N_{corrector} = 80$ we require $\sigma_{step} < 5 \text{ nm}$
- ⇒ Should use minimum step size of $\Delta = 5 \text{ nm}$ to reduce impact of step size to much less than quadrupole jitter
- Typical movements are some 100 nm (but site dependent)
 - we require convergence between pulses
 - stabilisation during correction with piezo movers is not obvious

Time Dependent Residual Emittance Growth

- The residual emittance growth determines for how long the feedback is sufficient
- Use simple feedback

$$\Delta y_{n+1} = \Delta y_n - g \times \Delta y_n + \gamma_n$$

- For the different dynamic imperfection types we find
 - pulse-to-pulse jitter

$$\Delta \mathcal{L}_{resid,n} \approx 0$$

- ATL like motion

$$\Delta \mathcal{L}_{resid,n} \approx a \times n \Delta \mathcal{L}_0$$

- slow drifts

$$\Delta \mathcal{L}_{resid,n} \approx a \times n^2 \Delta \mathcal{L}_0$$

- Luminosity loss per timestep is $\Delta \mathcal{L}_0$
- Feedback reduces emittance growth per time step by factor a

Number of Feedback Stations and Residual Emittance Growth

- The residual emittance growth is roughly

$$\Delta\mathcal{L}_r \propto \frac{1}{N_f^2}$$

- For ATL motion and $N_f = 40$

$$\Delta\mathcal{L}_r \approx 0.2 \times 10^{-3} \text{ nm/s}$$

⇒ can run for some 1000 s

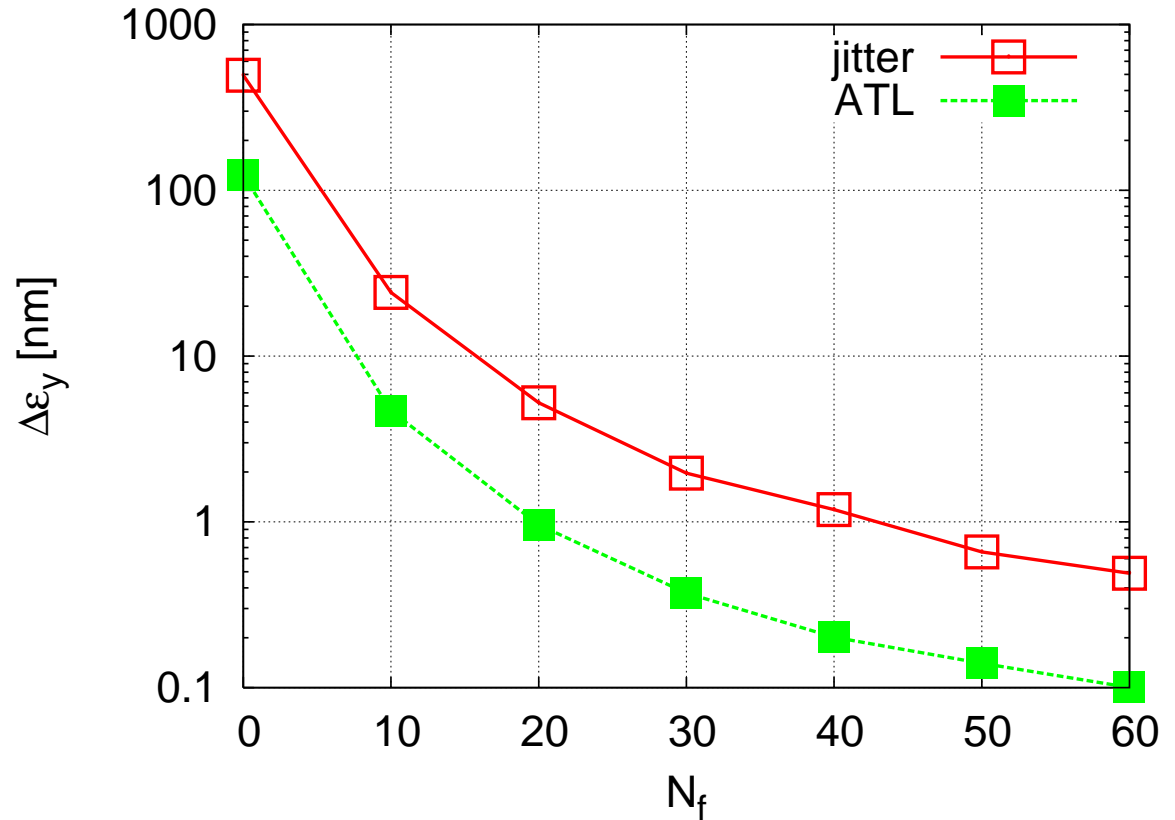

- A final feedback to re-steer to the original orbit is always included

Determination of Response Matrix

- A correct response matrix is important for an efficient MIMO
 - Can be determined by a dedicated measurement
 - takes time
 - machine might slowly drift away from measured response
 - Solution is to introduce noise on purpose
 - kick a beam at location s_1
 - apply another kick at s_2 that should remove the beam oscillation
- ⇒ allows to measure response in this sector

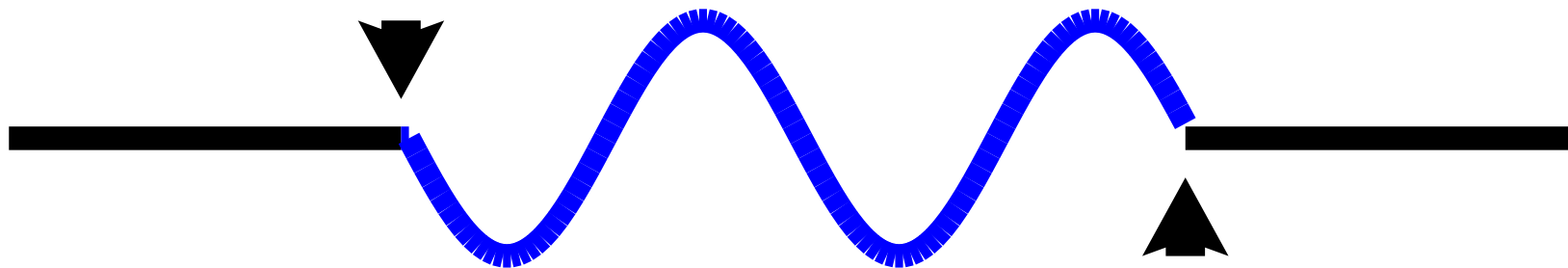

Example: Integrated Simulations for CLIC

Impact of Ground Motion

- Assumed a direct one-to-one transfer to beam line elements and simplified feedback

- Stabilisation is air hook

⇒ A is good enough

⇒ B is marginal

⇒ B10 is bad

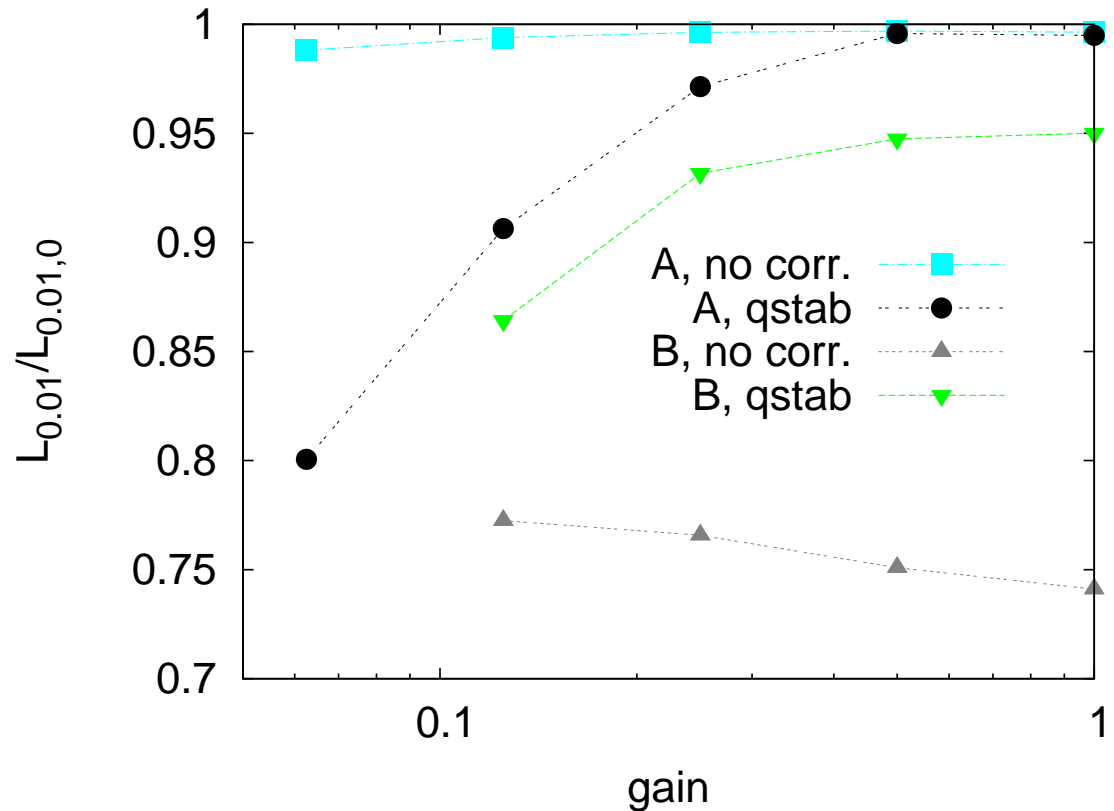

⇒ A medium noisy site (B) is almost OK, if we stabilise the final doublets

Tolerance for Ground Motion

- Full simulation of the machine from start of linacs
 - Determine amplitude for 10% luminosity loss
 - No correction applied
- ⇒ Sine-like perturbations (with respect to IP) are more important
- beam-beam offset
- ⇒ Long wavelength are less harmful

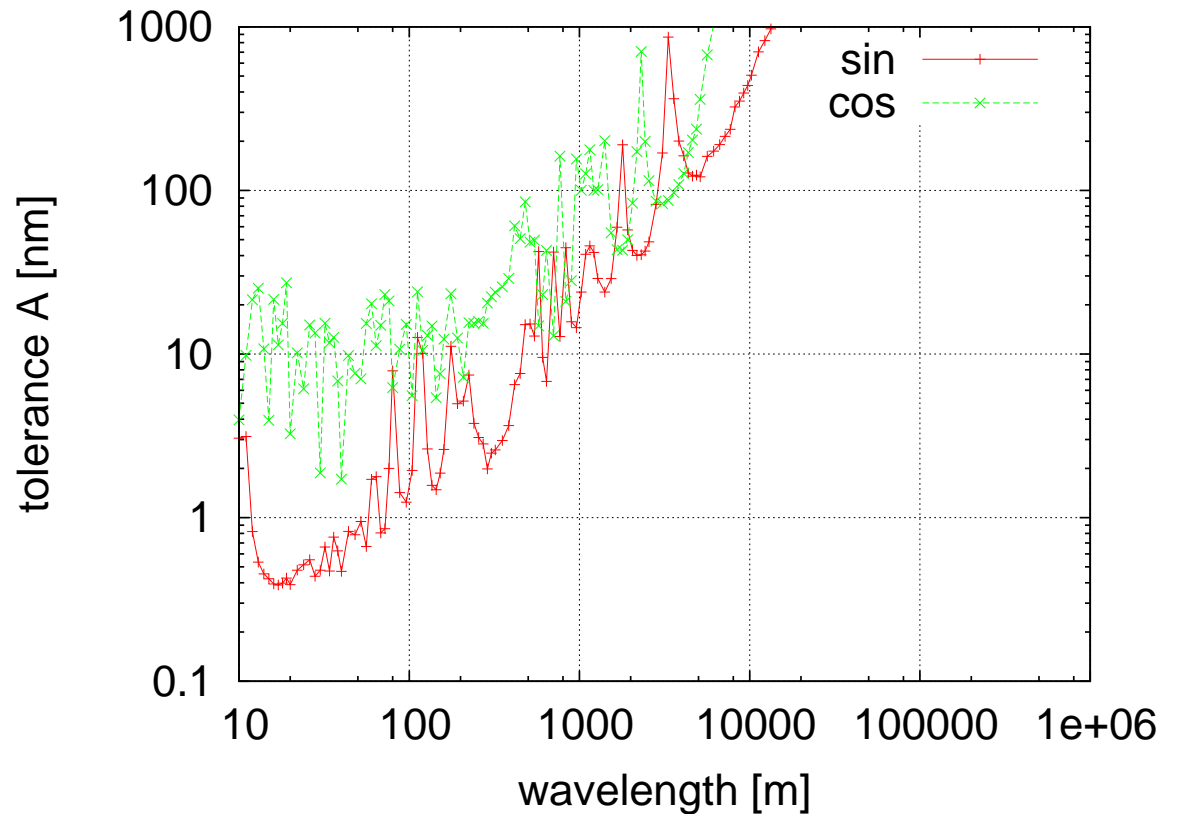

Fixed Final Doublet

- Full simulation of the machine from start of linacs as before
 - Final doublet plus multipoles are stabilised perfectly
- ⇒ For short wavelengths, sine-like perturbations are more important
- ⇒ For long wavelengths, cosine-like perturbations are more important
- machine moves away from final doublets

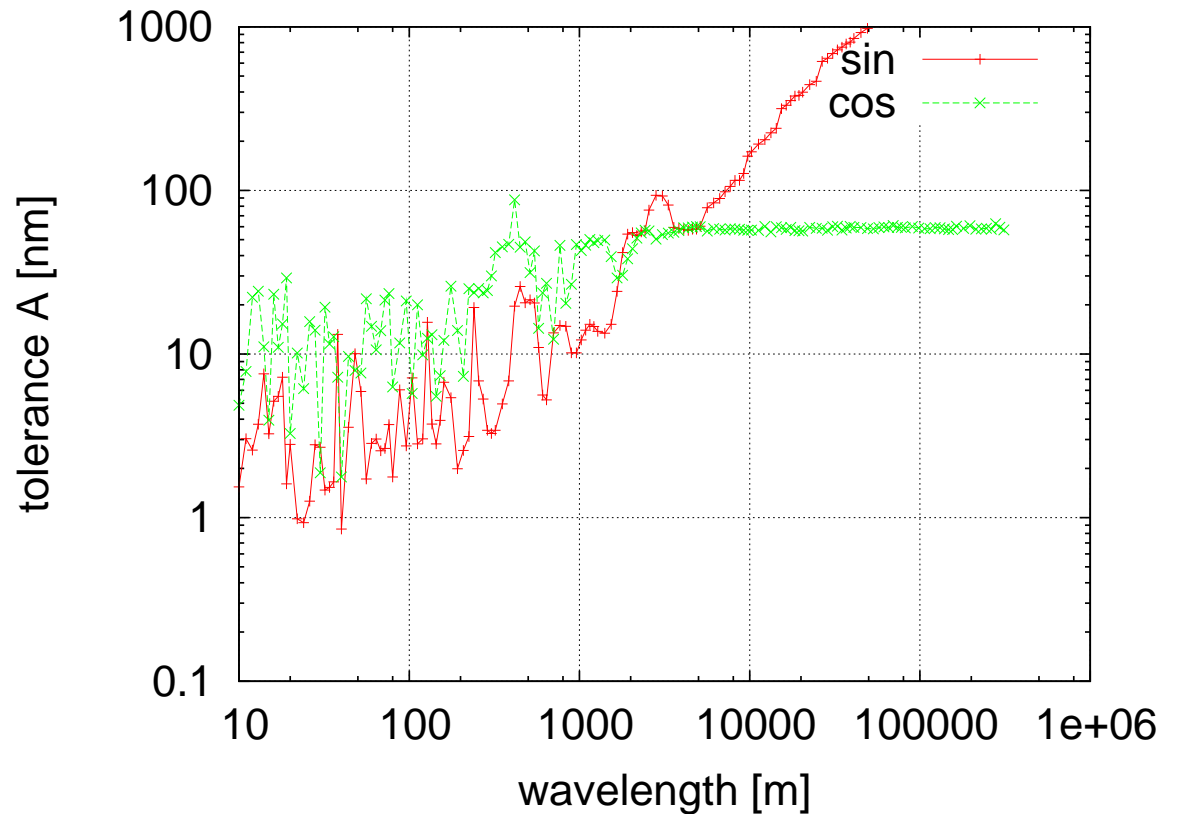

Results

- Final doublet is perfectly stabilised
- Beam-based dead-beat feedback

⇒ Ground motion model A is worse than with beam feedback only

- machine drifts away from final doublets

⇒ Other are also not good enough

$$\langle \Delta L \rangle = \int \int P(\omega, k) |T(\omega)|^2 G(k) dk d\omega$$

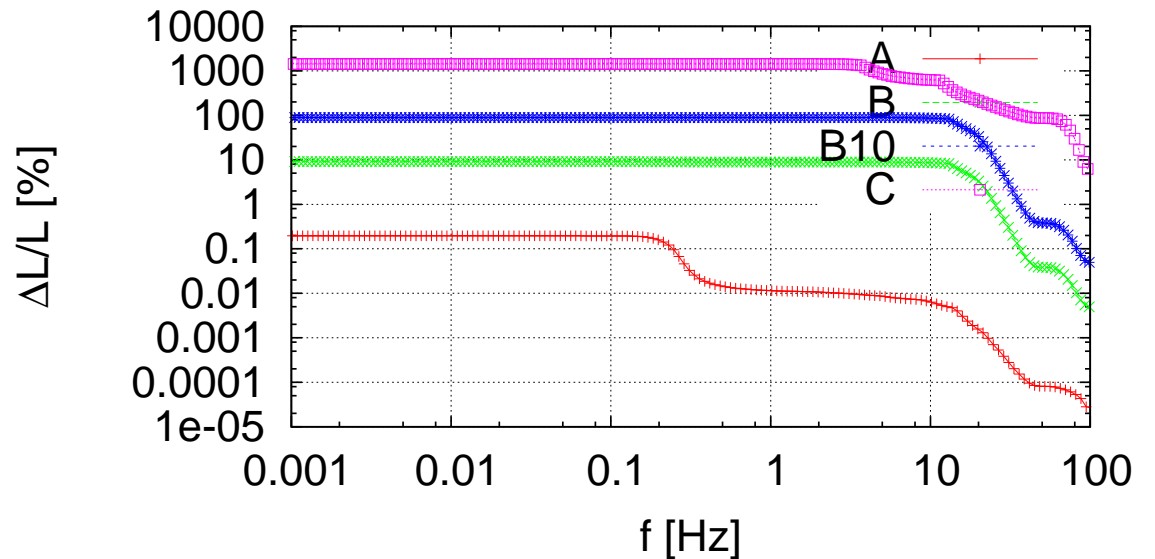
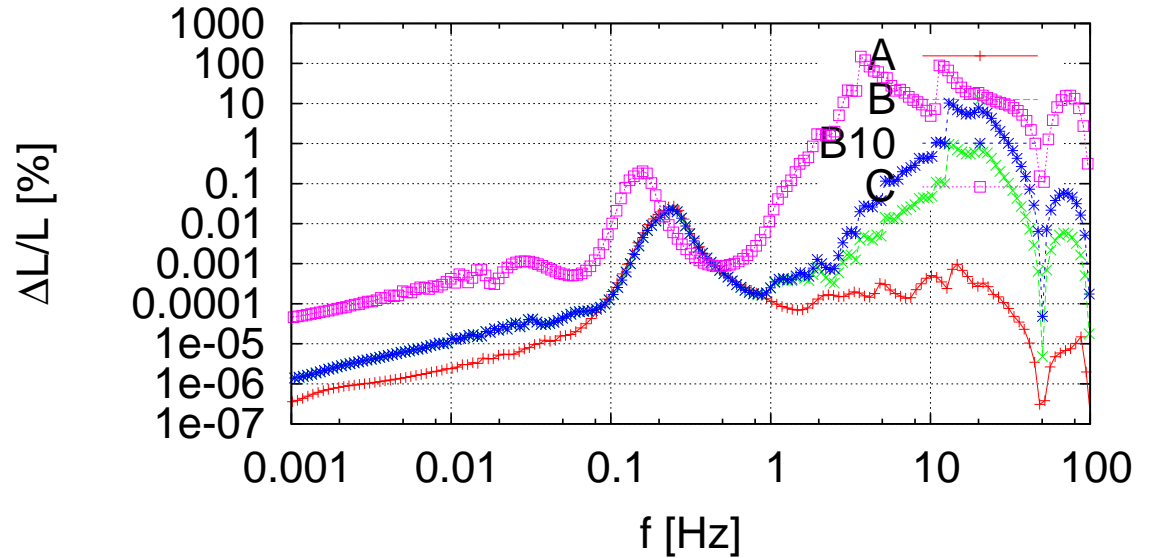

Reason for Luminosity Loss

- Ground motion B10 is used
 - The residual loss is still dominated by frequencies above about 10 Hz
- ⇒ The residual problem are at frequencies above ≈ 10 Hz

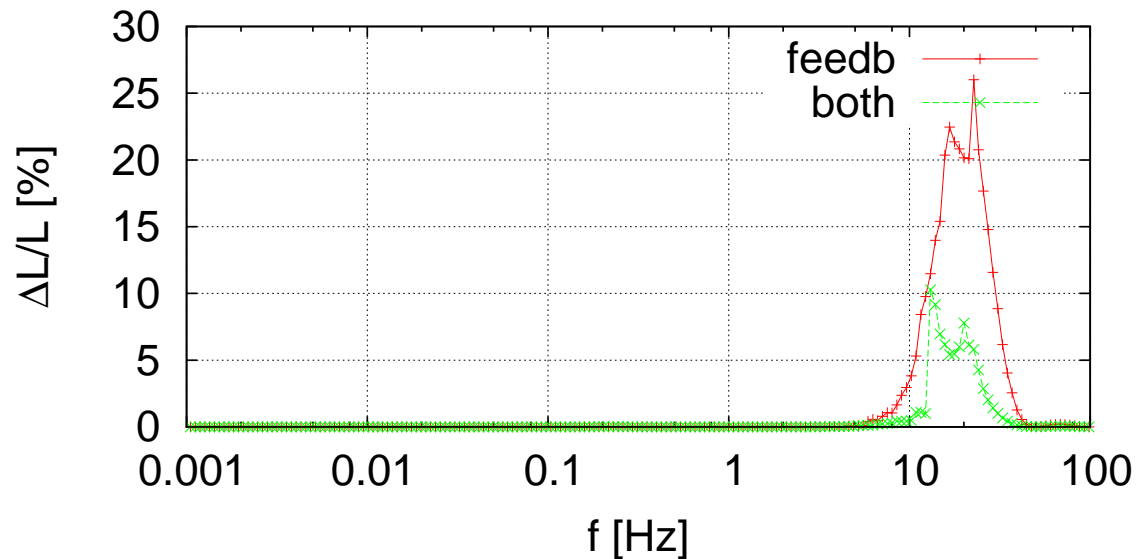
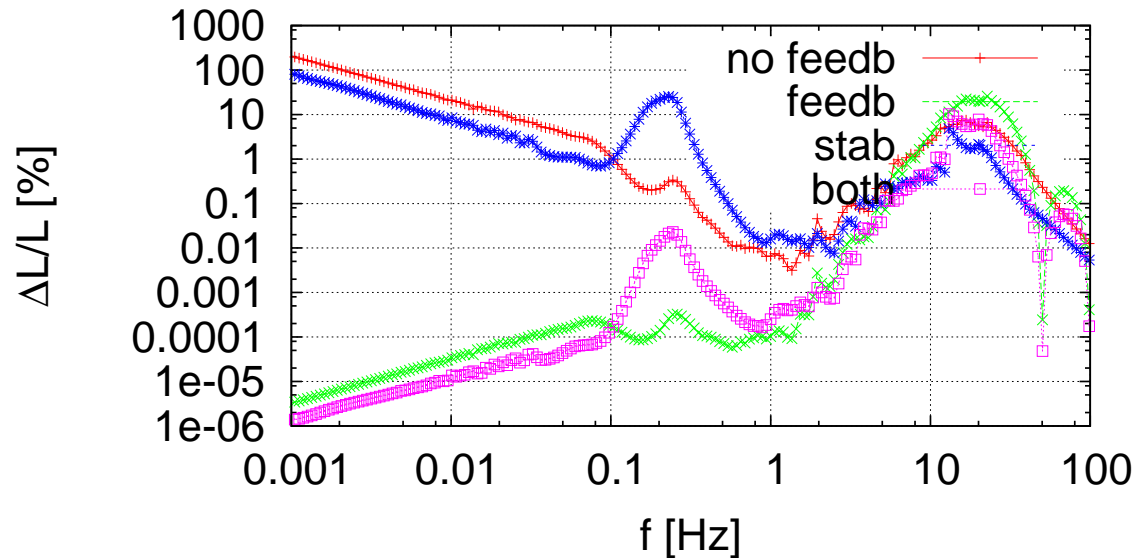

Simplified Simulation Results

- Feedback directly applied to ground motion
 - dead-beat controller used
- Mechanical stabilisation applied to everything
 - only final doublet treated separately
- Ground motion model B10 used
- Results:
 - only beam-based feedback: $\Delta\mathcal{L}/\mathcal{L} \approx 60\%$
 - stabilised final doublet: $\Delta\mathcal{L}/\mathcal{L} \approx 30\%$
 - also stabilised magnets: $\Delta\mathcal{L}/\mathcal{L} \approx 3\%$
- Intra-pulse feedback will improve this (J. Resta Lopez)

Some Results for ILC

The Banana Effect

At large disruption, correlated offsets in the beam can lead to instability

The emittance growth in the beam leads to correlation of the mean y position to z

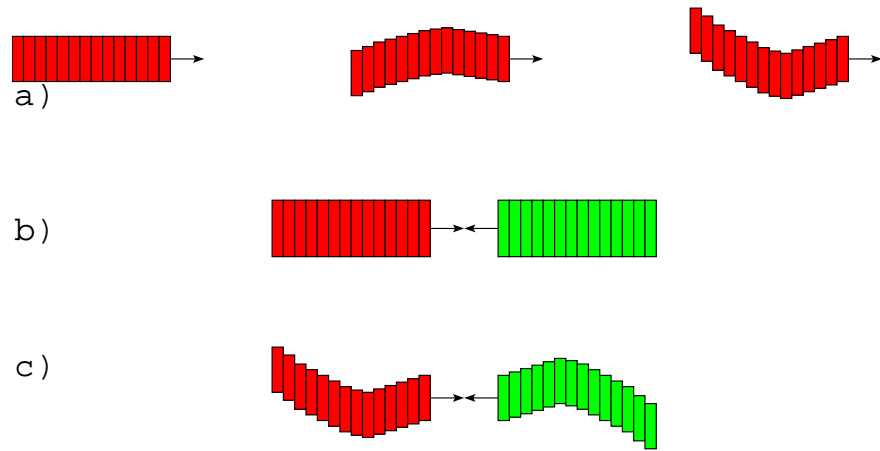

a) shows development of beam in the main linac

b) simplified beam-beam calculation using projected emittances

c) beam-beam calculation with full correlation

⇒ Luminosity loss increased

⇒ Cure exists

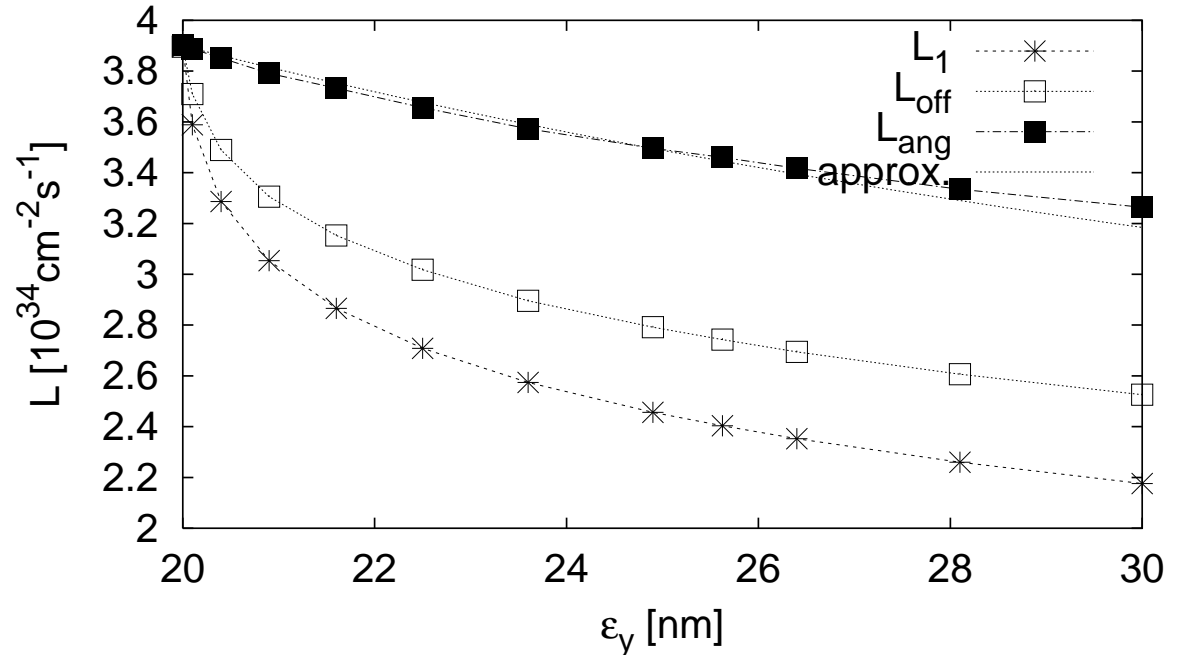

Simplified Simulations of ILC Main Linac Quadrupole Jitter

- Simplified main linac lattice with 32 cavities per quadrupole
⇒ now 24 cavities per quadrupole
- Simulation procedure
 - emittance growth in main linac with PLACET
 - simplified trajectory feedback at end of ML
 - simple transfer matrix to IP
 - beam-beam with GUINEA-PIG

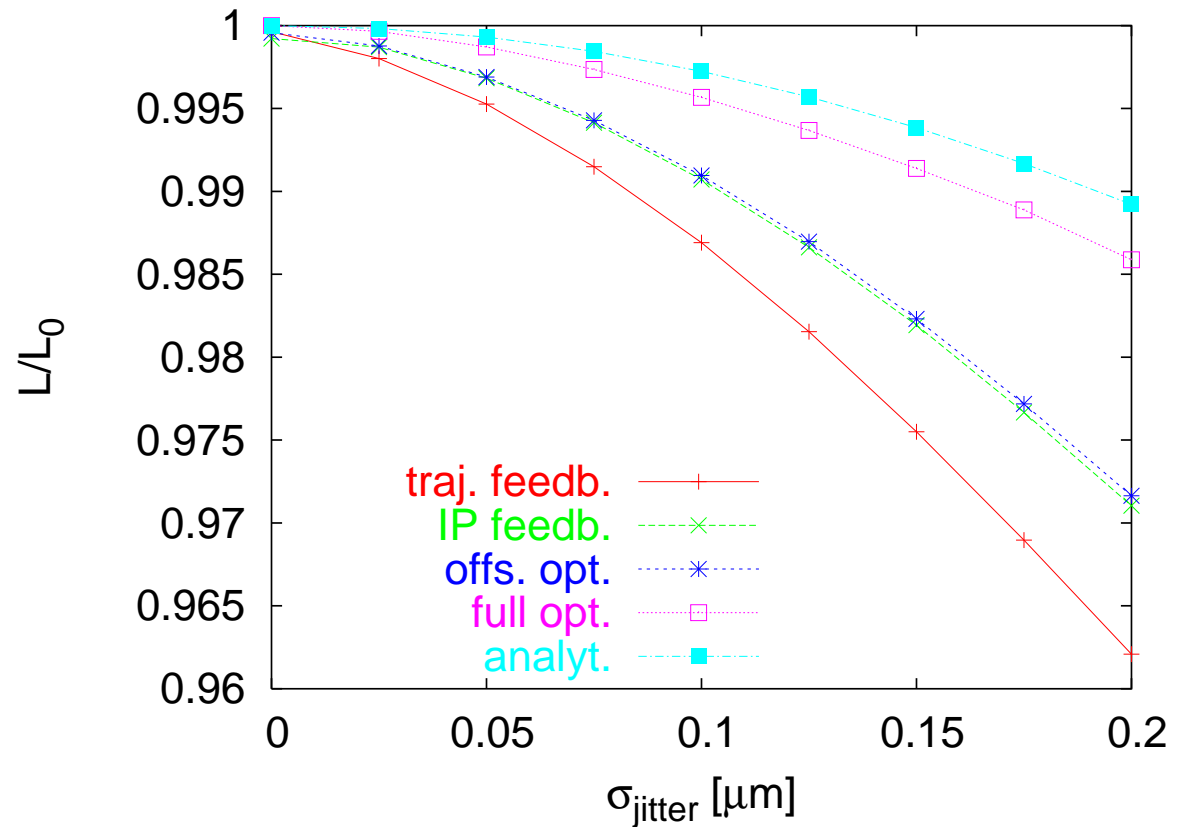

Luminosity Loss Enhancement

- ⇒ Luminosity loss is enhanced with respect to expectation from emittance growth
- ⇒ Offset optimisation does not improve beam-beam feedback a lot
- ⇒ But angle optimisation does
- ⇒ For larger emittance growth loss enhancement is reduced

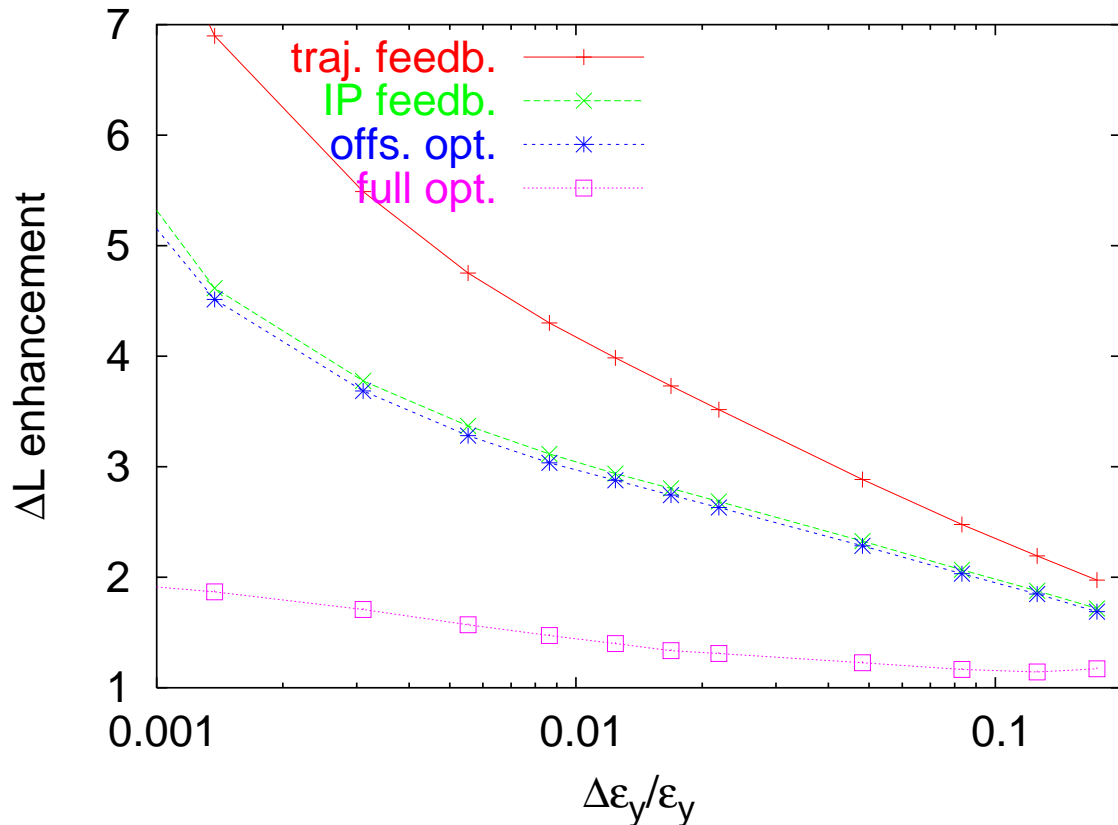

Dynamic Effects During Alignment

Introduction

- Dispersion free steering uses beams at different energies to align quadrupoles
- They can be obtained using different gradients or bunch compressor settings
- Beam jitter during alignment fakes dispersion
 - either accept
 - or try to fit incoming beam trajectory
 - or use different energies within single pulse
- Simulations done using simplified ILC lattice
- Nominal misalignments are used
 - 1.5% RMS gradient jitter from RF unit to RF unit
 - 5% RMS random scale error of BPMs
- Similar results for CLIC
- Small energy difference used
 - gradient difference 1%
 - first two units are off

⇒ alignment of first six quadrupoles not treated

Quadrupole Jitter

- Very large quadrupole jitter of 500nm added
- ⇒ Procedure with no fit suffers most
- ⇒ Fit of incoming beam helps a bit
- ⇒ Use of different energies in single pulse is best
- ⇒ But could try better fit
- ⇒ Recommend to use energy difference within a single pulse

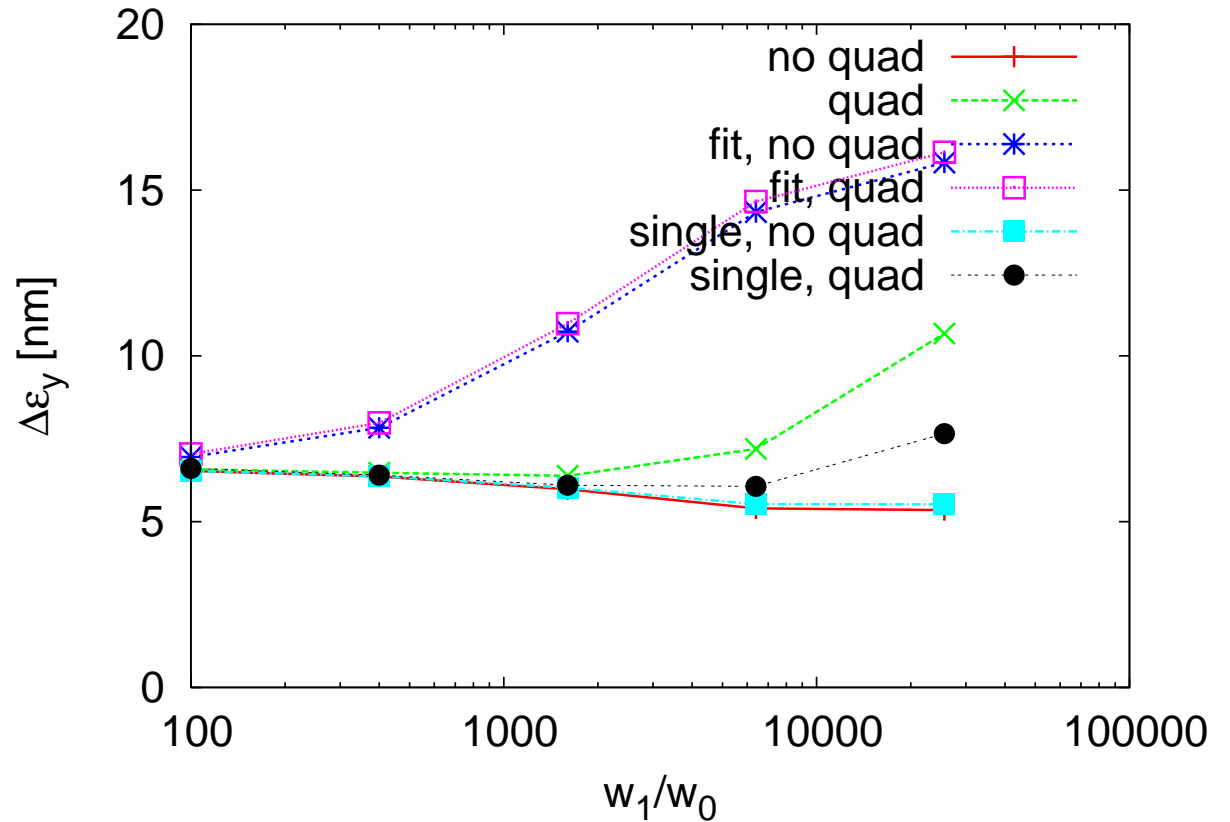

- correction can be performed with stable machine
- if spread can be reduced (better BPM resolution/averaging) or test bunches are used (after main pulse) one could align during luminosity operation

Summary

- Dynamic imperfections can have important impact on luminosity
 - example is ground motion/element jitter
- Countermeasures are
 - beam-based feedback
 - stabilisation of hardware
- Calculations can be done in frequency domain for convenience

Some Fun Stuff

Main Linac Orbit Steering

- All quadrupoles could be stabilised
 - but in the long run they follow the ground motion
 - ATL-model used
 - ⇒ emittance growth is linear with time
 - one day simulated
 - All focusing quadrupoles used for steering in one-to-one correction
- ⇒ Emittance growth is $\Delta\epsilon_{y,residual} = 1 \text{ nm per day}$
- Mover step size of 10 nm is noticeable in emittance

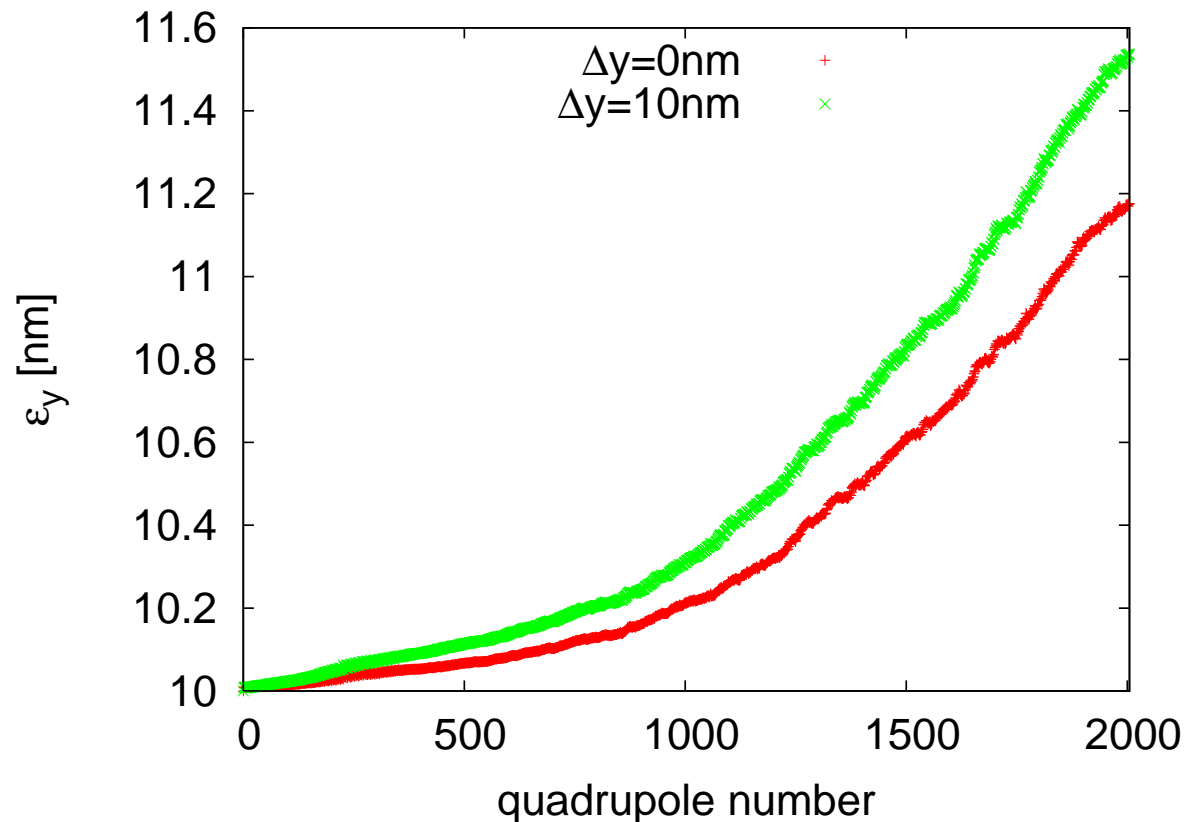

Use of MICADO

- Try to find a small number m of most effective correctors
- Simulation performed using
 - one-to-one correction with given step size
 - then some iterations of MICADO

⇒ Significantly larger corrector step size are allowed

- In principle, MICADO can replace the one-to-one steering
 - speed of correction should be largely unaffected
- The main problem is to have an accurate enough model of the beam line
 - problem shared with other integrated feedback methods

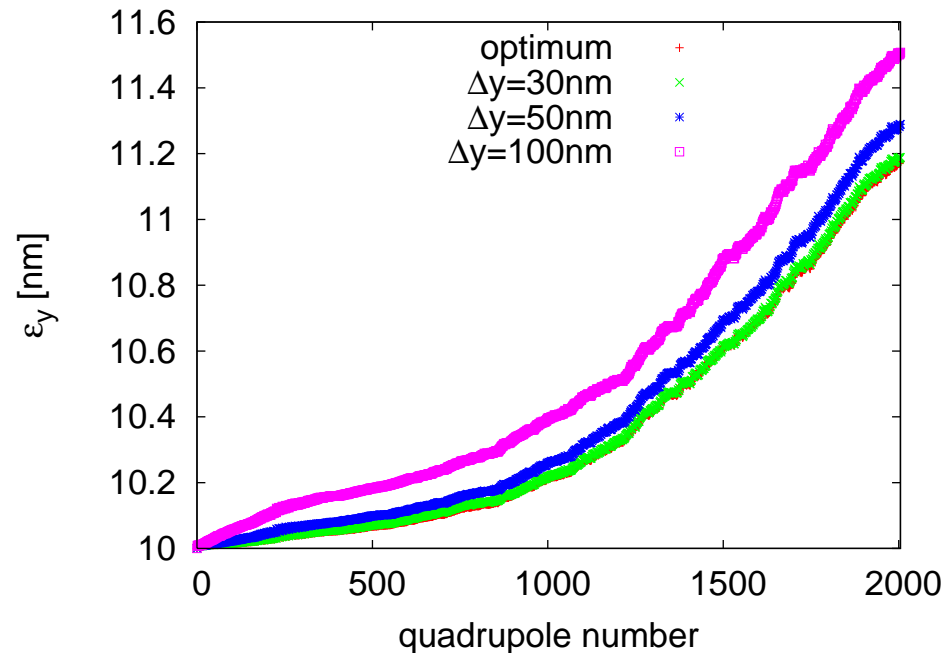

Some Simulation Procedure

- Assumed errors

- $\sigma_K/K = 0.01$

- $\sigma_{BPMscale} = 0.1$

- $\sigma_{correctorscale} = 0.1$

- $\Delta_{corrector} = 0.1\mu m$

- $\sigma_{BPMres} = 1\mu m$

- ATL ground motion assumed for $3 \times 10^6 s$ with $A = 0.5 \times 10^{-6} \mu m/s/m$

- For MICADO 10 correctors are used

- For one-to-one correction all correctors are used (can be improved)

Results

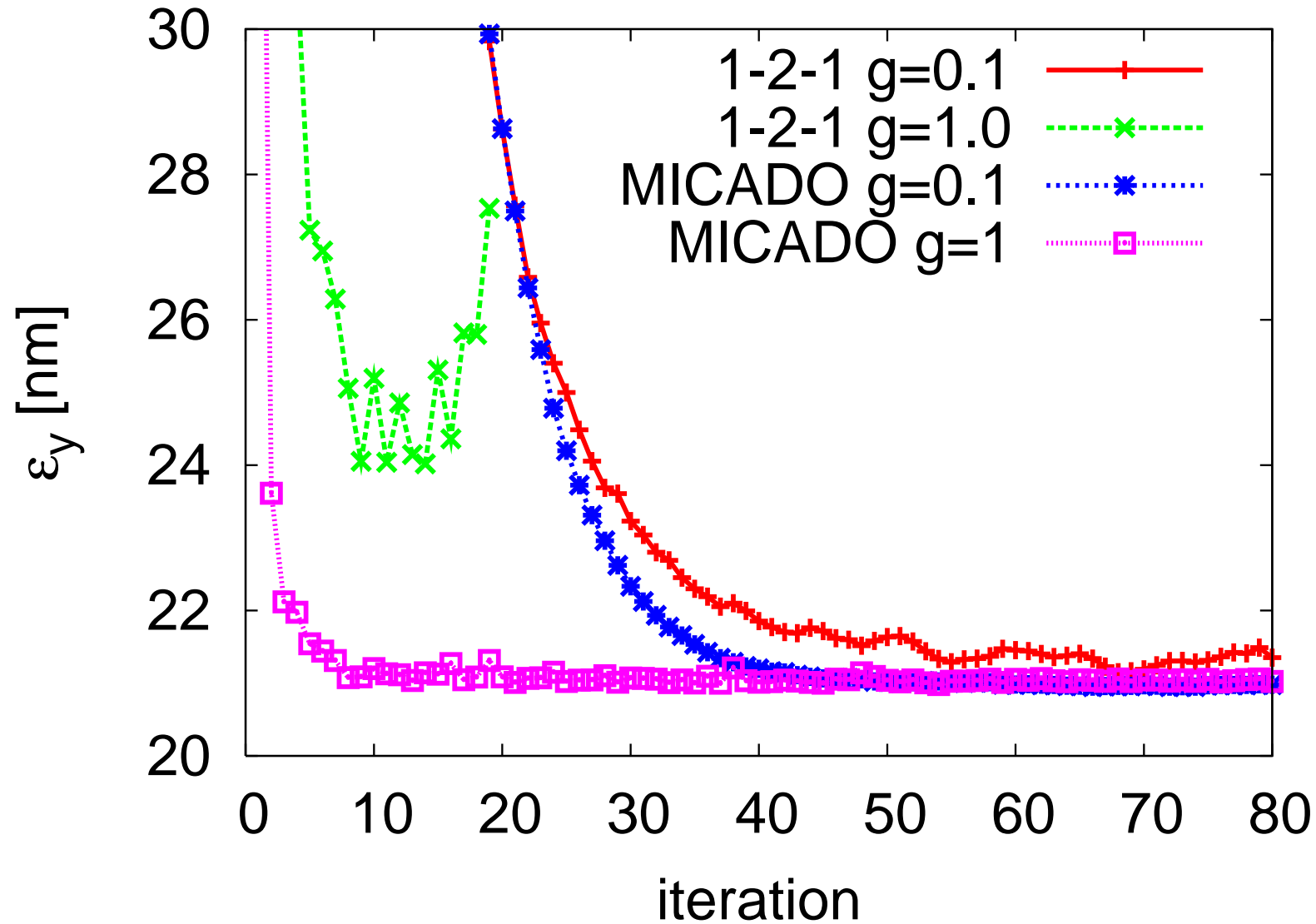

One-To-One Results (BPM resolution $10\mu m$)

