



LLRF Control Applications

LLRF Lecture Part 3.6

S. Simrock, Z. Geng

ITER / SLAC



Outline

- Introduction to the LLRF Applications
- Examples:
 - System Identification
 - Grey box model identification
 - Black box model identification
 - System Calibration
 - Beam based vector sum calibration
 - RF field calibration for RF gun without probes
 - Parameters Optimization
 - Adaptive feed forward
 - Exception Detection
 - Quench detection



Introduction to the LLRF Applications



Challenges for RF Control

- Challenging topics:
 - Vector sum calibration (amplitude & phase)
 - Operation close to performance limits
 - Exception detection and handling
 - Automation of operation
 - Optimal field detection and controller (robust)
 - Reliability
- Sophisticated algorithms and application software are necessary for RF control of a large scale accelerator, such as ILC and XFEL



Category of the LLRF Applications

- System identification
- System calibration
- Parameters optimization
- Diagnostics
- Operation support
- Exception detection
- Exception handling
- ...



Context of LLRF Applications

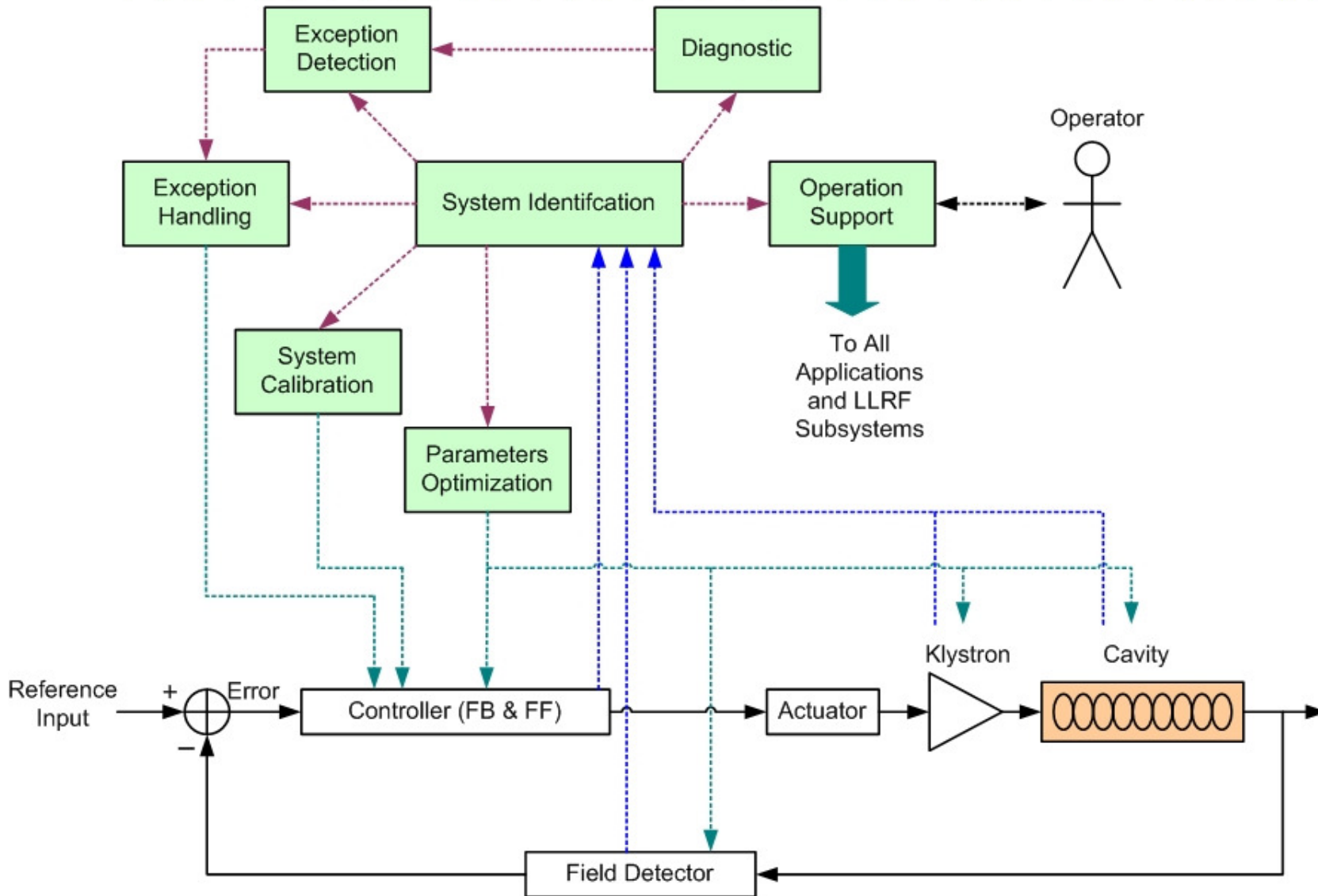



System Identification



RF System Identification

- System identification
 - Build mathematical models of the RF system based on measured data from the system, the results may include
 - Mathematic description of the input/output dynamics
 - System parameters such as QL, detuning, system gain, loop phase, non-linearity of the klystron and field detector ...
- Use cases of the RF system model
 - Controller parameter optimization
 - Diagnostics
 - Predict the system response
 - Estimate the required system input for desired output (adaptive feed forward)



Model for Dynamic System

- Grey box model
 - system internal structure is described by the physical model of the system
- Black box model
 - system internal structure is not known



System Identification - Grey box model



RF System Grey Box Model

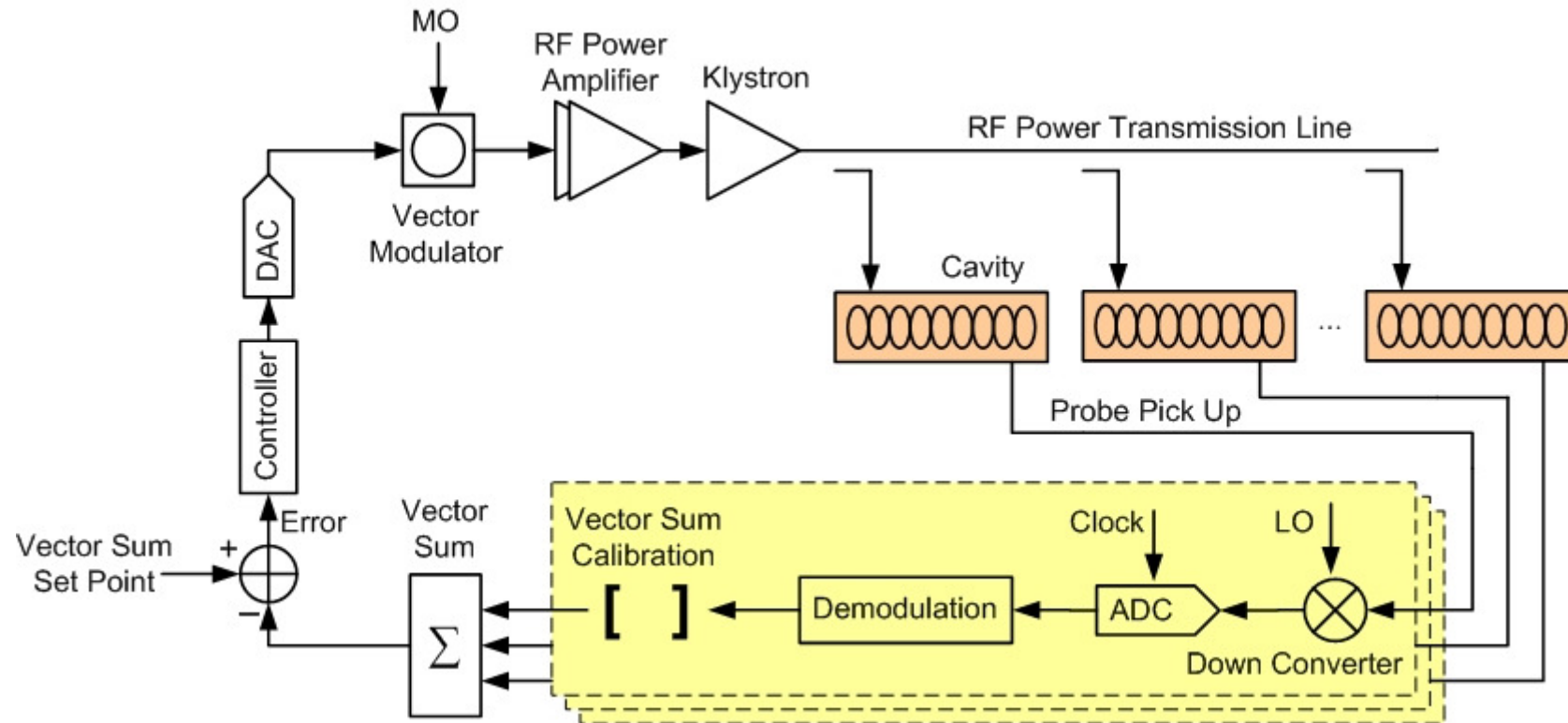

RF system grey box model:

Mathematical description of the system behaviour from **DAC** to **Vector Sum** based on the cavity equations



RF System Grey Box Model

System equations for the grey box model (voltage source driven):

$$\begin{cases} \frac{d\vec{V}_{sum}}{dt} + (\omega_{1/2} - j\Delta\omega)\vec{V}_{sum} = C\sqrt{\omega_{1/2}}\vec{V}'_{for}, & C = \sqrt{\left(\frac{r}{Q}\right)\frac{\omega_0}{Z_0}} \\ \vec{V}'_{for} = G \cdot \vec{V}_{DAC} \end{cases}$$

Gray box model contains of elements of:

- Half bandwidth
- Detuning
- Complex gain G

Available measured signals:

- Vector sum
- DAC output
- Klystron output



Available Data for System Identification

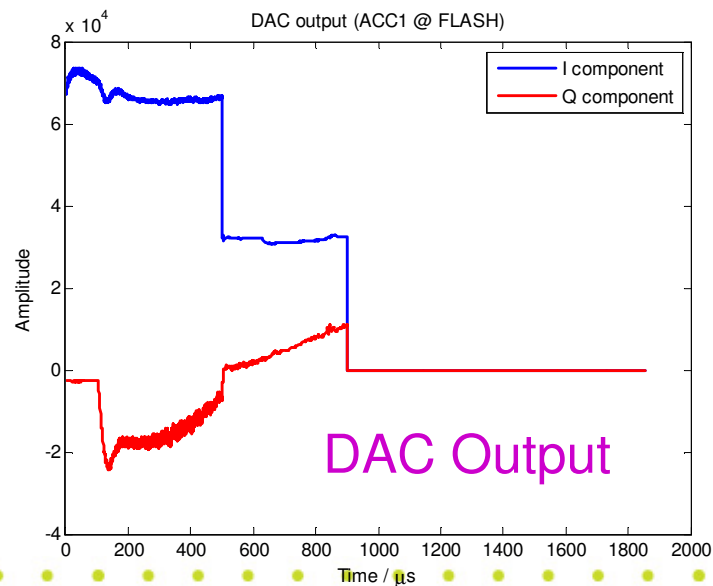
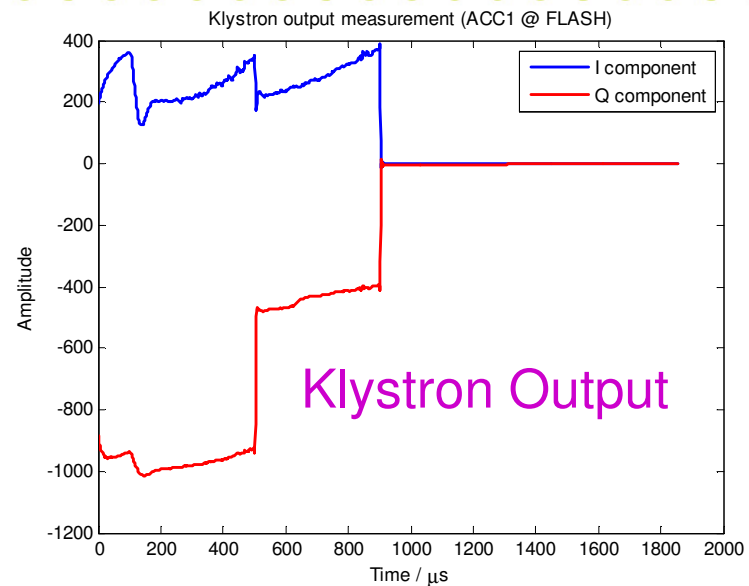
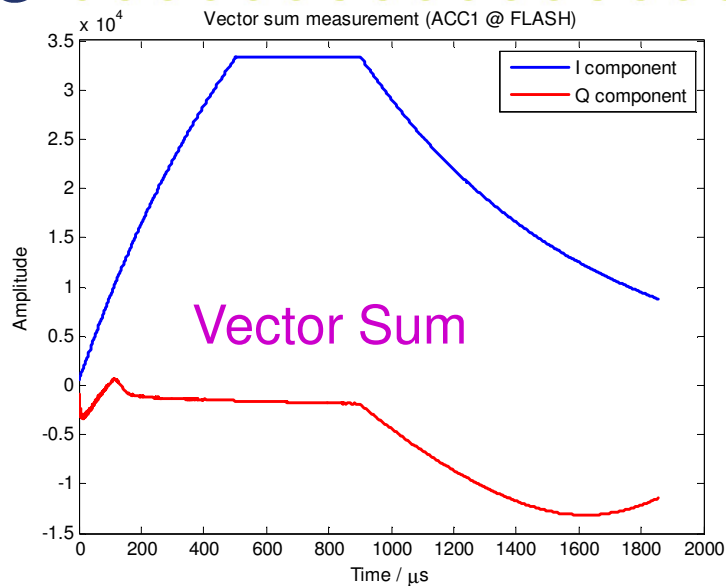

Measured signals at
ACC1 of FLASH.

These data will be used
for on-line identification of
the grey box model.



Model Elements Identification

Remind the system equations:

$$\frac{d\vec{V}_{sum}}{dt} + (\omega_{1/2} - j\Delta\omega)\vec{V}_{sum} = C\sqrt{\omega_{1/2}}\vec{V}'_{for}$$

$$\vec{V}'_{for} = G \cdot \vec{V}_{DAC}$$

$$\vec{V}'_{for} = K_{kly} \cdot \vec{V}_{kly}$$

Calculate the half bandwidth and detuning:

$$\omega_{1/2} - j\Delta\omega = \left(C\sqrt{\omega_{1/2}}K_{kly}\vec{V}'_{kly} - \frac{d\vec{V}_{sum}}{dt} \right) / \vec{V}_{sum}$$

Calculate the complex gain:

$$G = K_{kly} \cdot \vec{V}_{kly} / \vec{V}_{DAC}$$

Appendix 1:
Vector Sum
Driving Signal
Calibration



Model Elements Identification

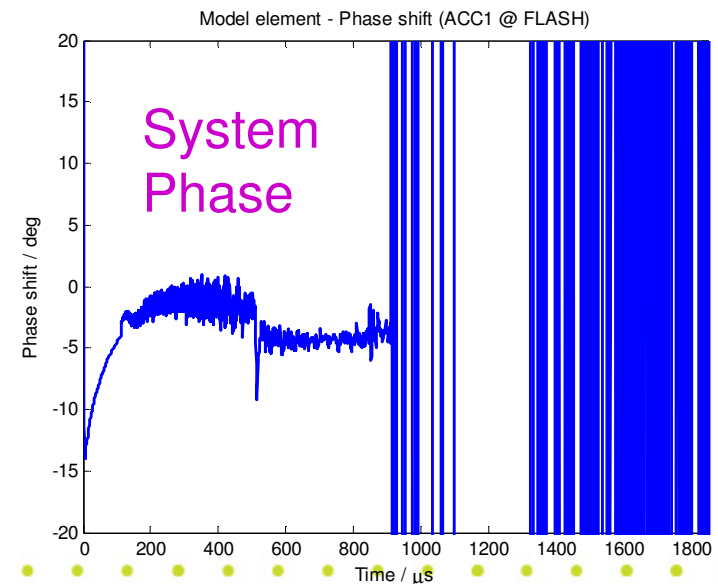
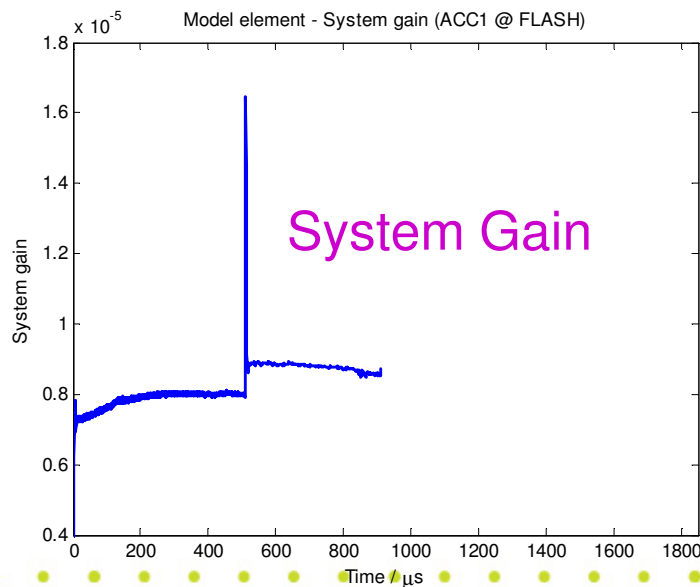
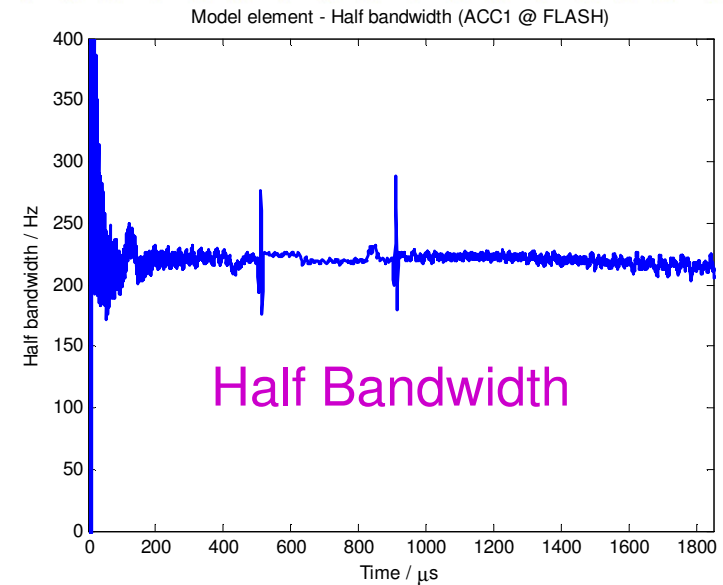
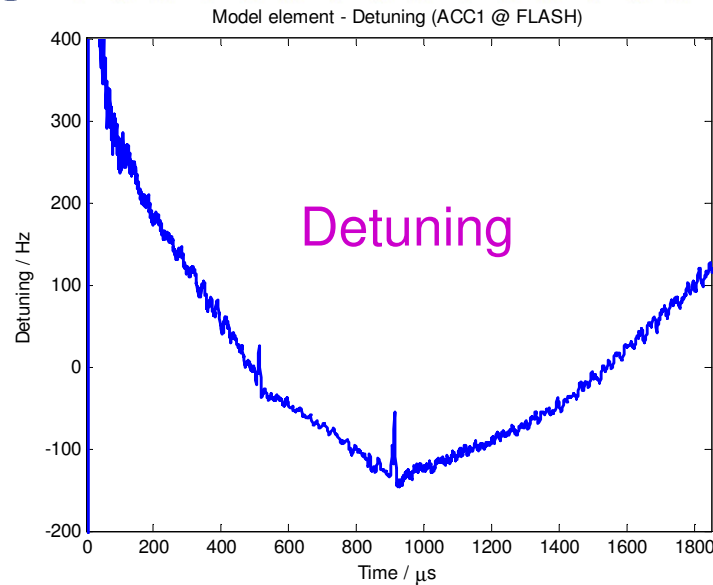



Model Elements Identification

- From the grey box model, we can see
 - Linear time varying model
 - Detuning changes during the RF pulse due to the Lorenz force
 - System gain and phase change during the RF pulse due to klystron non-linearity
- During the flattop, approximation can be made:
 - Detuning as a linear function
 - Half bandwidth, system gain and phase as constants



Summary of the Grey Box Model

- The grey box identification method works for both the vector sum and single cavity
- Advantages:
 - The grey box model can be identified during normal operation, no extra excitations are needed
 - The information provided by the model (detuning, half bandwidth, system gain and phase) will be useful for other applications such as system parameters optimization, exception detection and cavity resonance control
- Limitations:
 - Only valid around the working point



System Identification - Black box model

Black Box Model

Assumption : System Behavior is unknown

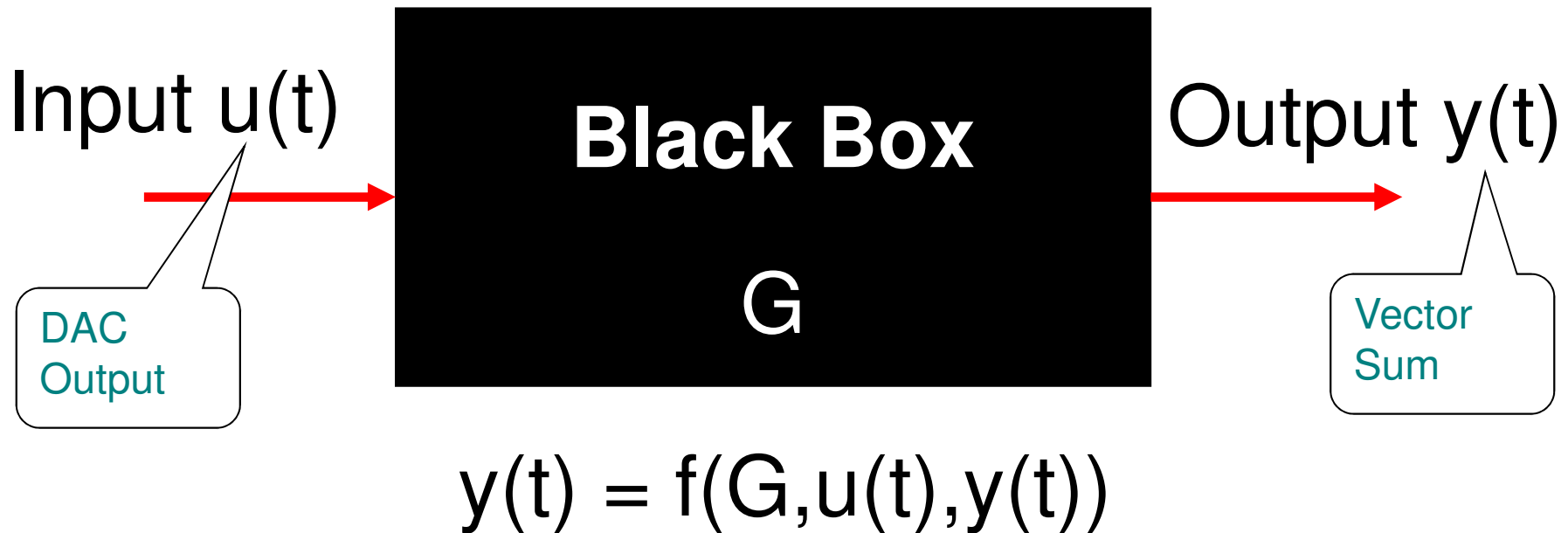

Question : What is G ? How do I get it?

System Model Structure

MIMO (multiple input multiple output)

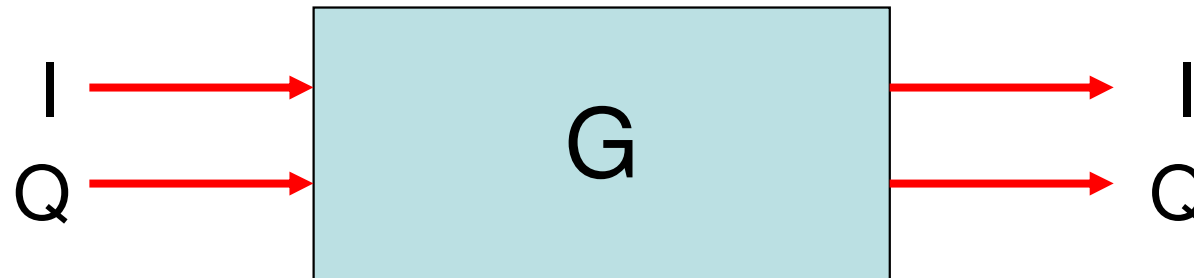

Here: Using a linear, time-invariant model

→ sufficient for around the working point

- State Space system (LTI)

$$\dot{x}(t) = Ax(t) + Bu(t)$$

$$y(t) = Cx(t) + Du(t)$$



System Identification Steps

- Excitation of the system by treating the system with “noisy” input signals
- Measuring the system response to this input sequence
- Fit a model from this input / output data, to find a mathematical system description
- Validate the model by comparing simulations with measured system data
- Model represents system dynamics without having any information about detailed inside.



Exciting System Input at Working Point

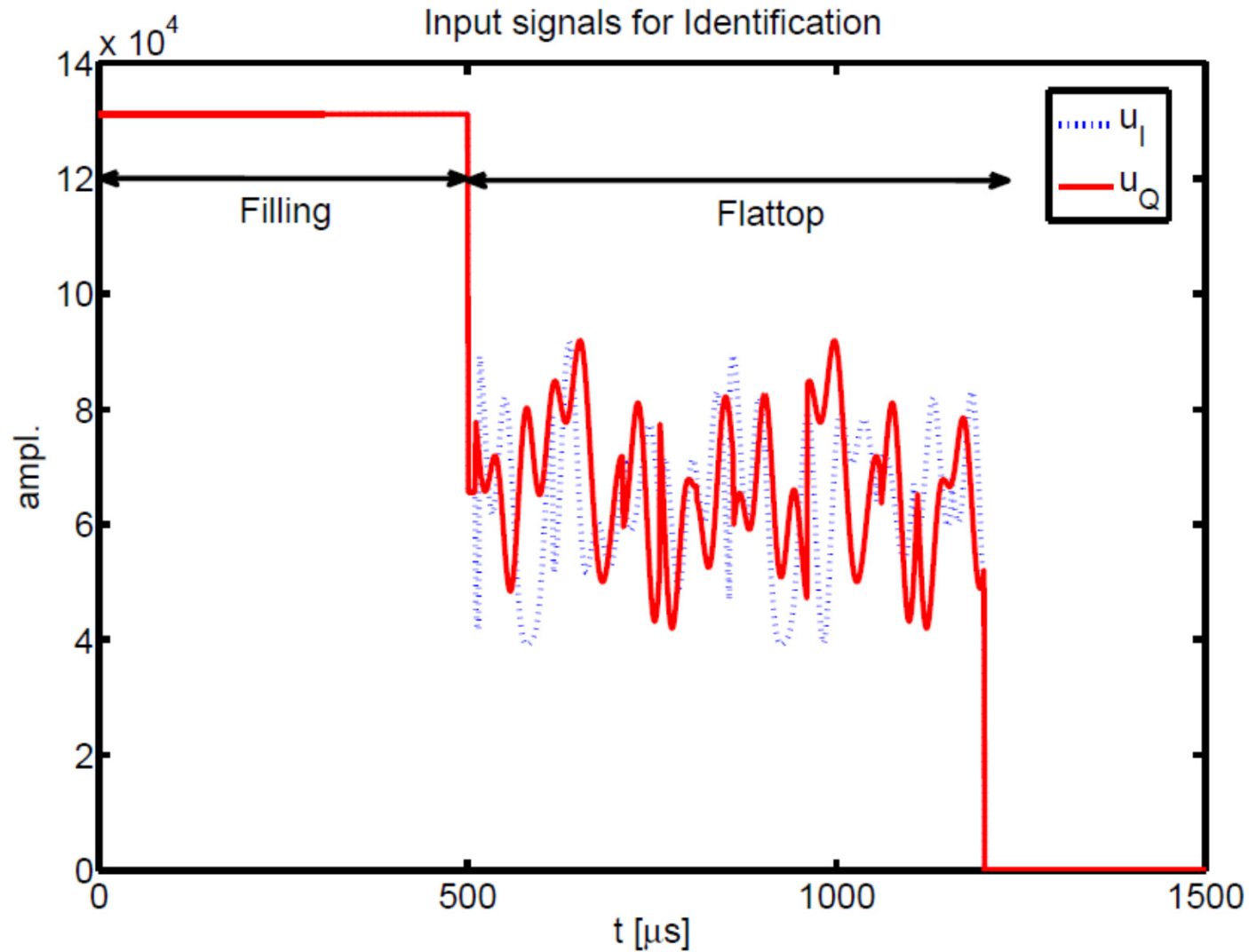



Model Validation with Measurement

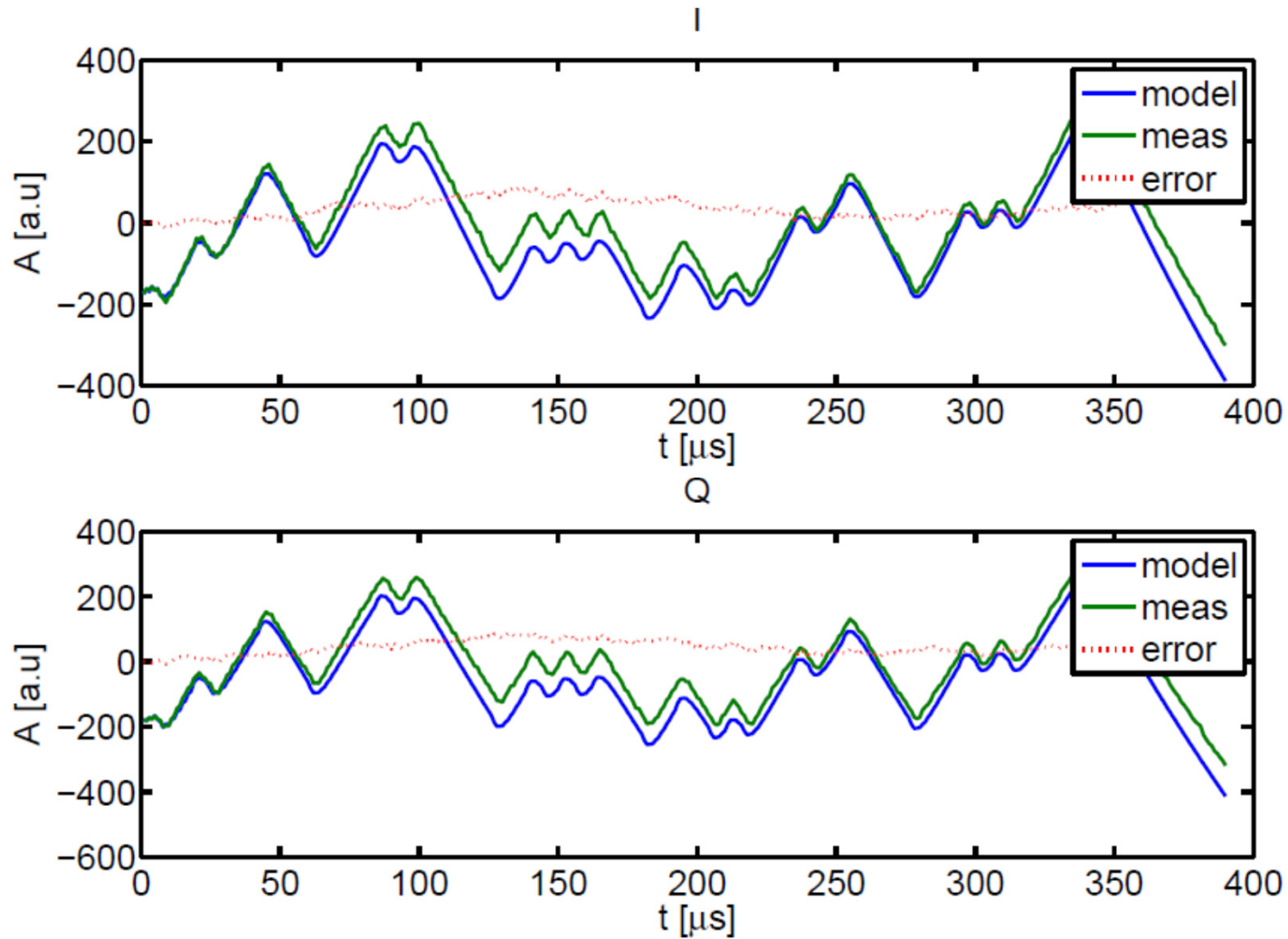



Summary of the Black Box Model

- Advantages
 - No a-priori system information is needed
 - Input / Output behavior models the full system containing all subsystems.
 - LTI models can be used for nearly all control system applications to find the optimal controller.
- Limitations
 - Physical background of the system stays dark
 - Every working point needs a new model



System Calibration

- Beam Based Vector Sum Calibration



Required Calibration in LLRF System

- Vector sum calibration
- Gradient and phase (respect to beam) calibration for each cavity
- Forward and reflected power calibration for each cavity

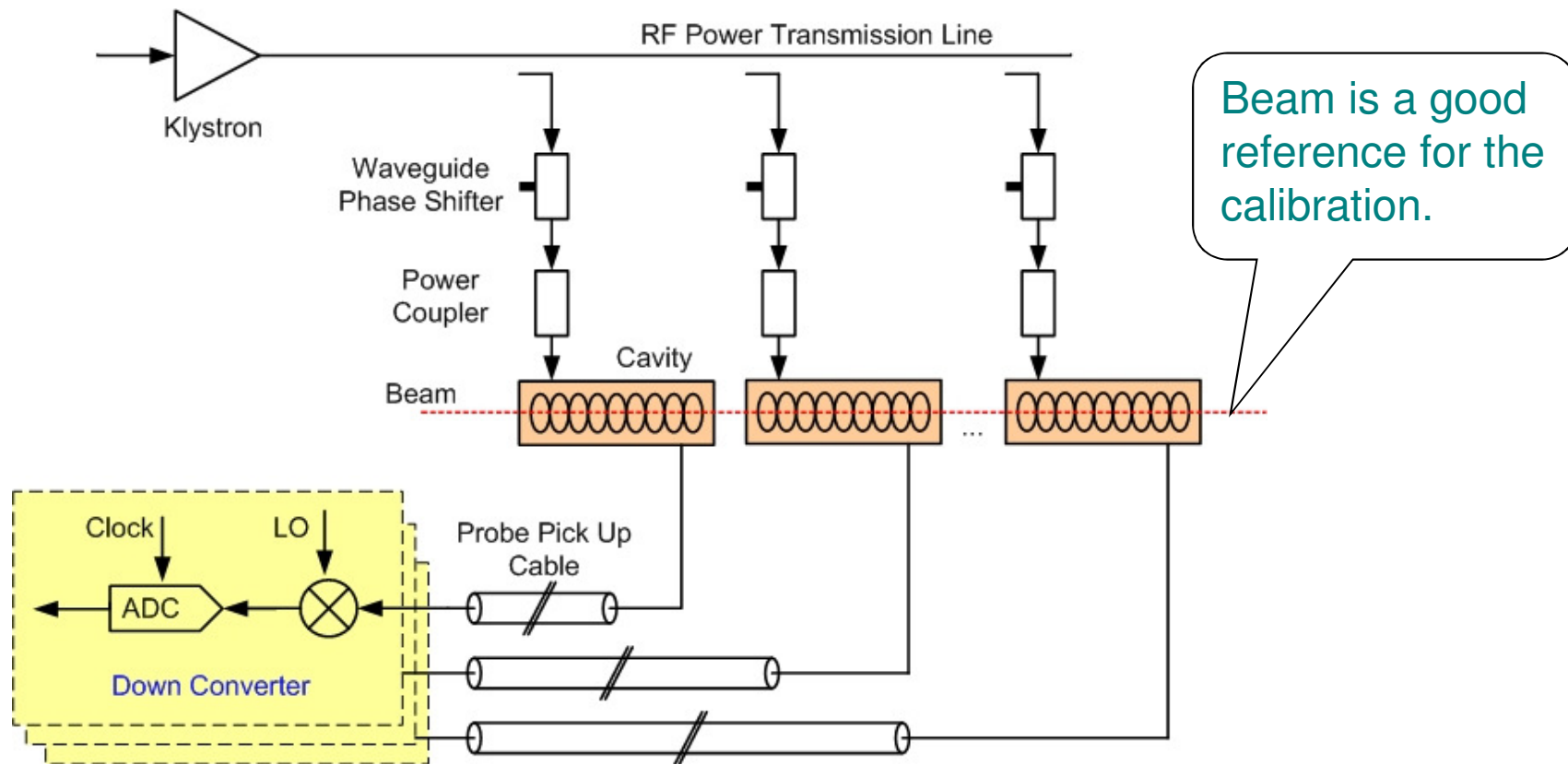



Beam Transient Measurement

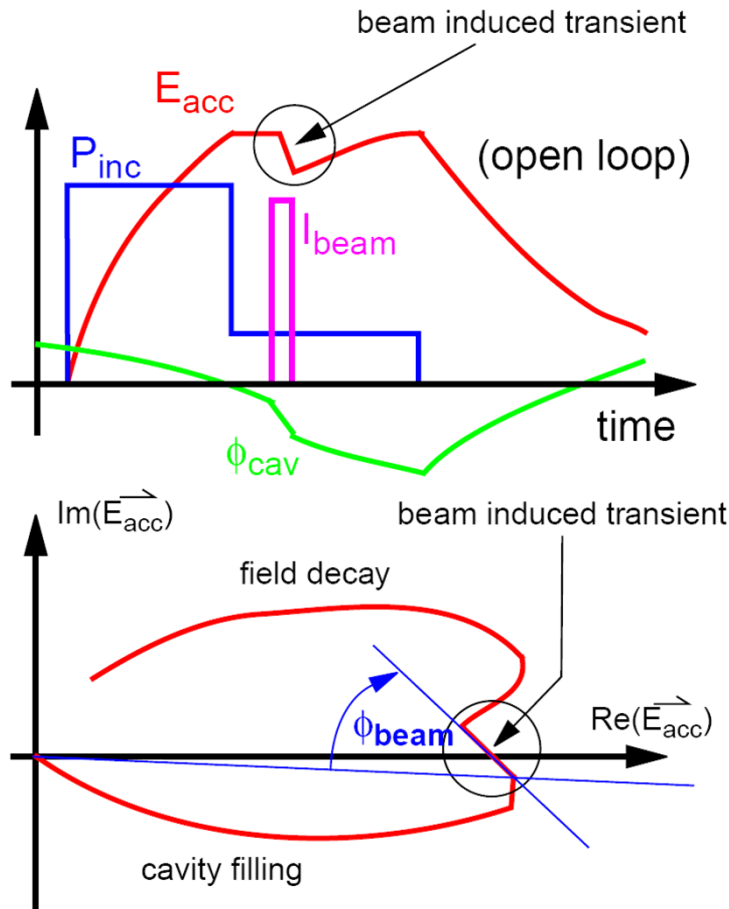

for $\Delta t \ll \tau_{cav}$:

$$\Delta V_{ind} = I \cdot \Delta t \cdot \left(\frac{r}{Q}\right) \cdot \pi \cdot f$$

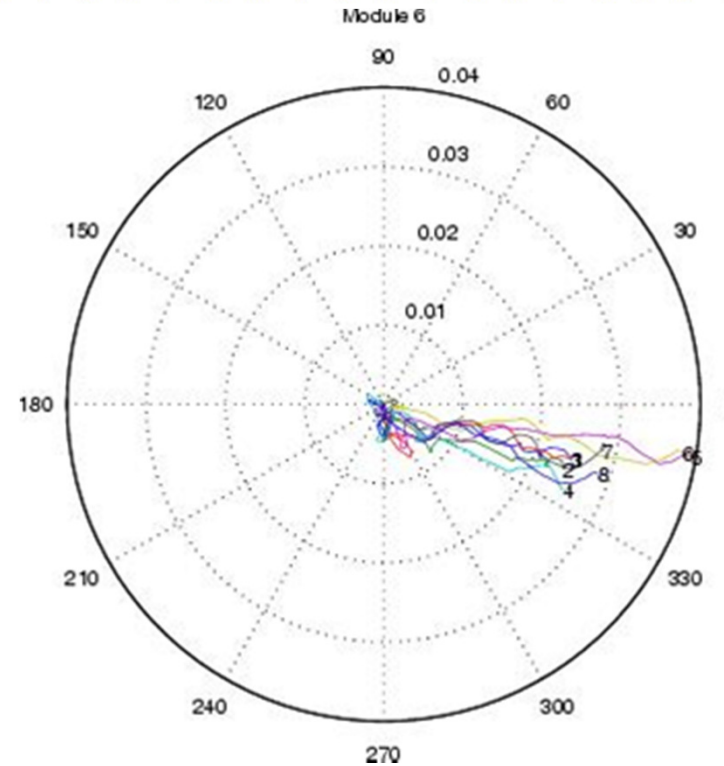

- Open loop operation
- Beam induced transient in each cavity field can be measured by comparing the cavity field waveforms without/with beam



Cavity RF Calibration

- Cavity gradient and phase calibration
- Incident (forward) power calibration
- Reflected power calibration

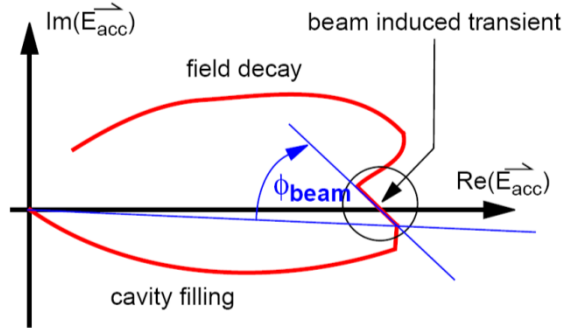
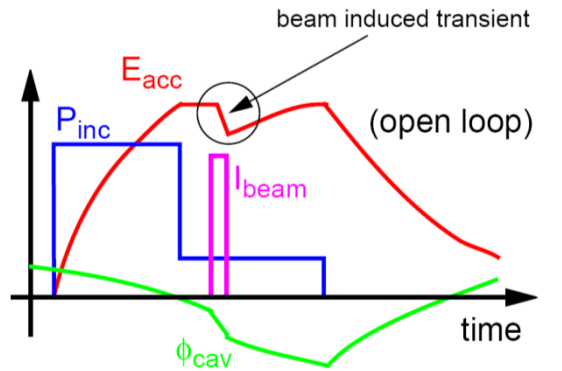

for $\Delta t \ll \tau_{cav}$:

$$\Delta V_{ind} = I \cdot \Delta t \cdot \left(\frac{r}{Q}\right) \cdot \pi \cdot f$$

$$E_{acc}(t_1) = 2 \cdot \sqrt{\left(\frac{r}{Q}\right) \cdot Q_L \cdot P_{inc}(t_0 \leq t \leq t_1)} \cdot \left(1 - \exp\left(\frac{(t_1 - t_0) \cdot \omega}{2 \cdot Q_L}\right)\right)$$

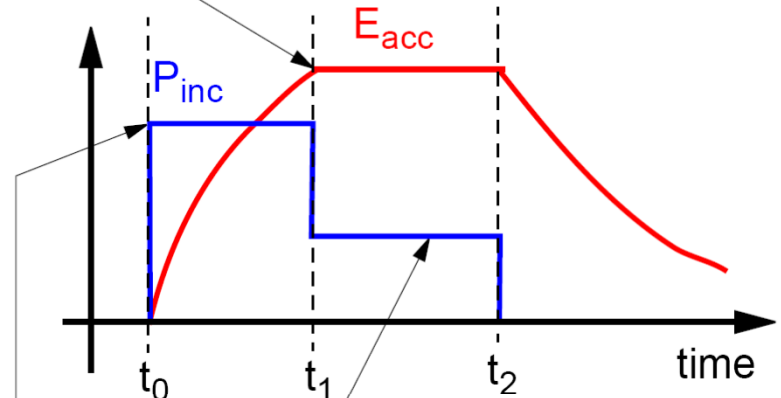

$$P_{ref}(t_0) = P_{for}(t_0) \quad E_{acc}(t_2) = \sqrt{\left(\frac{r}{Q}\right) \cdot Q_L \cdot P_{ref}(t_2)}$$

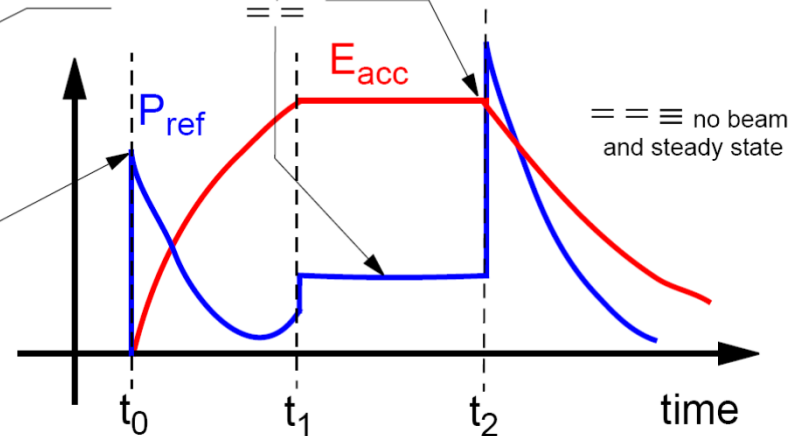



Vector Sum Calibration

- Assumptions:
 - All cavities have the same r/Q
 - Lossless beam
- The absolute values of the beam induced voltage and its phase should be the same for all the cavities, so if the vector of the first cavity acts as reference, the rotation gain and rotation angle of the n th cavity are

$$g_{rot,n} = \left| \frac{\Delta \vec{V}_{ind,1}}{\Delta \vec{V}_{ind,n}} \right|$$

$$\phi_{rot,n} = \angle \Delta \vec{V}_{ind,1} - \angle \Delta \vec{V}_{ind,n}$$



Vector Sum Calibration at ACC1 of FLASH

INPUT CALIBRATION							
1	2	3	4	5	6	7	8
Magnitude	Magnitude	Magnitude	Magnitude	Magnitude	Magnitude	Magnitude	Magnitude
+ 1.00	+ 1.10	+ 1.14	+ 1.09	+ 1.58	+ 1.43	+ 1.23	+ 1.48
Angle	Angle	Angle	Angle	Angle	Angle	Angle	Angle
+ 0.00	- 105.40	+ 104.38	- 15.03	- 181.01	- 54.94	- 127.87	+ 139.74
<input type="checkbox"/>	<input type="checkbox"/>	<input type="checkbox"/>	<input type="checkbox"/>	<input type="checkbox"/>	<input type="checkbox"/>	<input type="checkbox"/>	<input type="checkbox"/>

VECTOR SUM	
Vsum amp	-0.038 multip. with mag.
Vsum phase	+ 4.000 added to angle



IF Vector Sum Calibration Has Error...

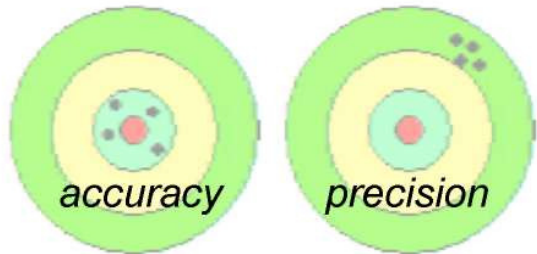

How precise can we measure the vectorsum seen by the beam (not: how good can we control the vectorsum...). We are not interested in *accuracy* but in *precision*!

Every vector carries an error that is assumed to be constant:

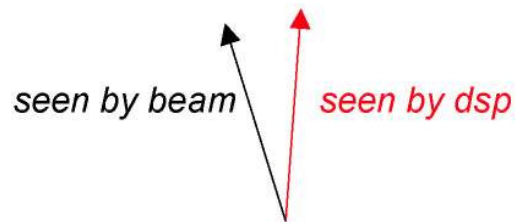

Two extreme configuration: the dsp sees identical vectorsums but the beam does not!

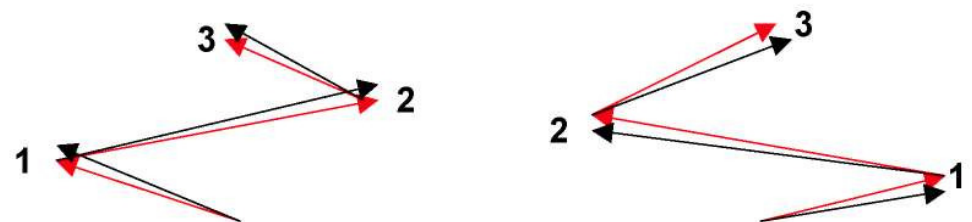



Effect of Vector Sum Calibration Error

Number of cavities: 1,12,32,64, Predetuning: 50 Hz, Detuning-Spread: 11 Hz, Amplitude cal. error: 0.01

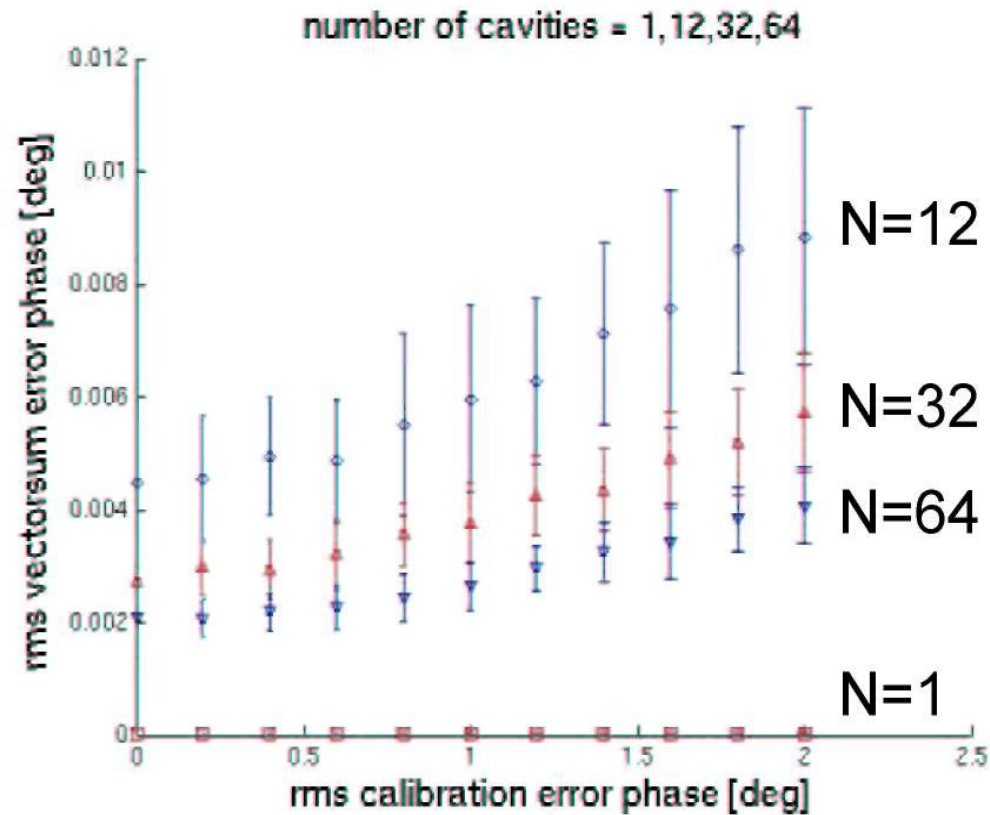

Surprising result: the more we measure, the better we get!



System Calibration

- RF Field Calibration for RF Gun
without Probes



RF Gun at FLASH

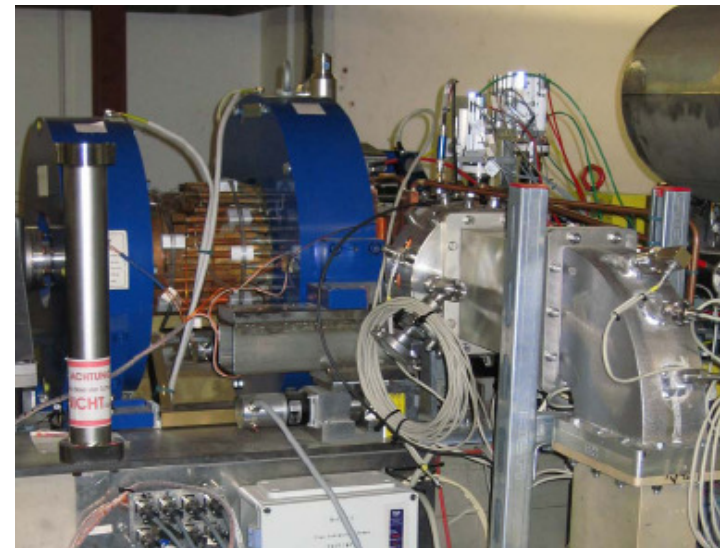
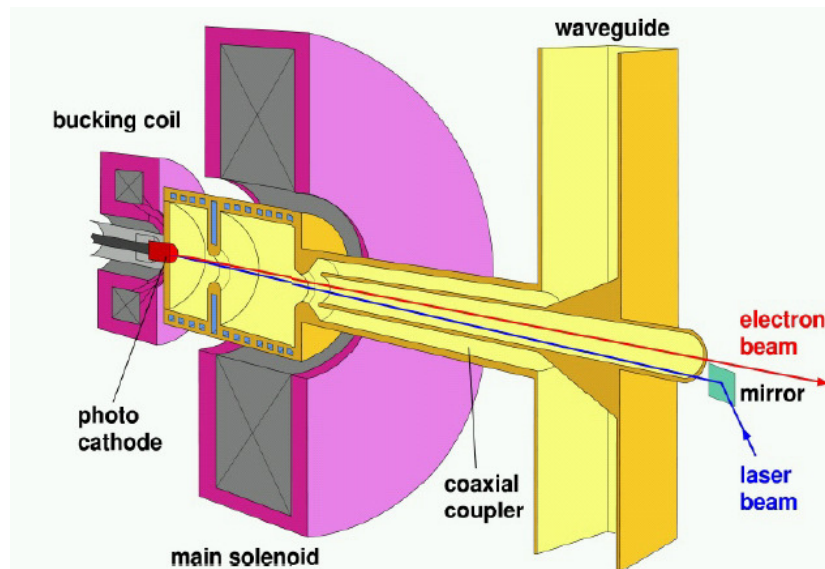
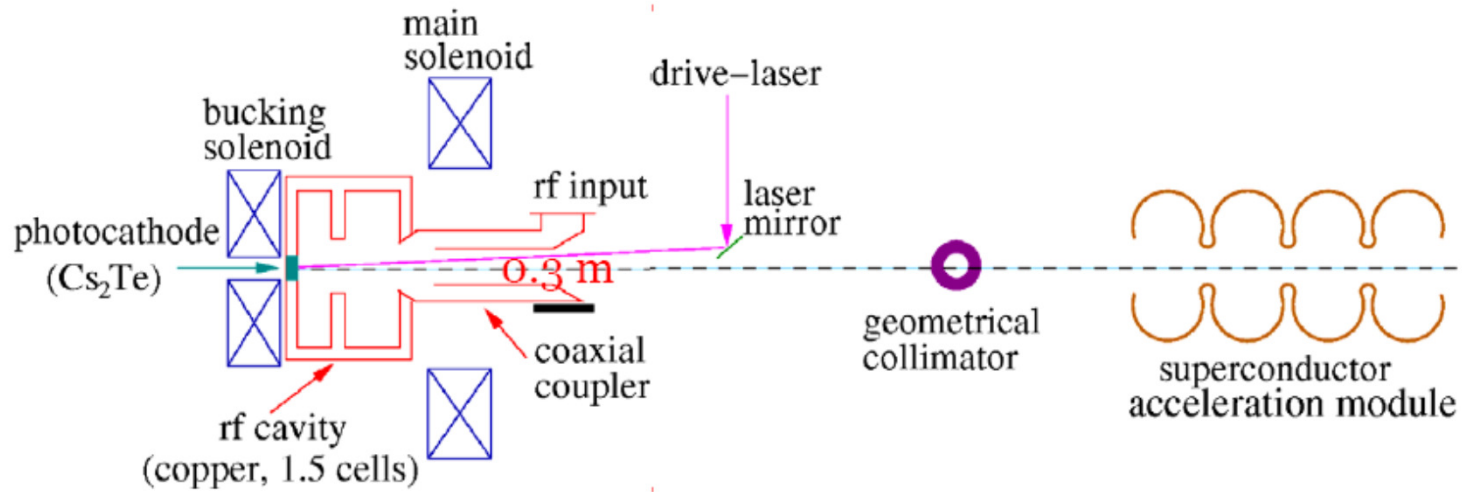



RF Gun at FLASH

- Pulse length: up to 800 μs
- Pulse repetition: up to 5 Hz
- High RF field: 40 MV/m
- Phase stability: 0.5 degree
- Resonance frequency is sensitive to the cavity wall temperature (0.1 deg temperature change corresponds to 2.1 deg in RF phase)
- **No probe installed** for better cooling and field symmetry



RF Gun Control

- Probe is missing, so
 - Cavity field can be calculated from the forward and reflected signals
 - Calibration is needed because of
 - Unknown phase offset and attenuation by the measurement chain

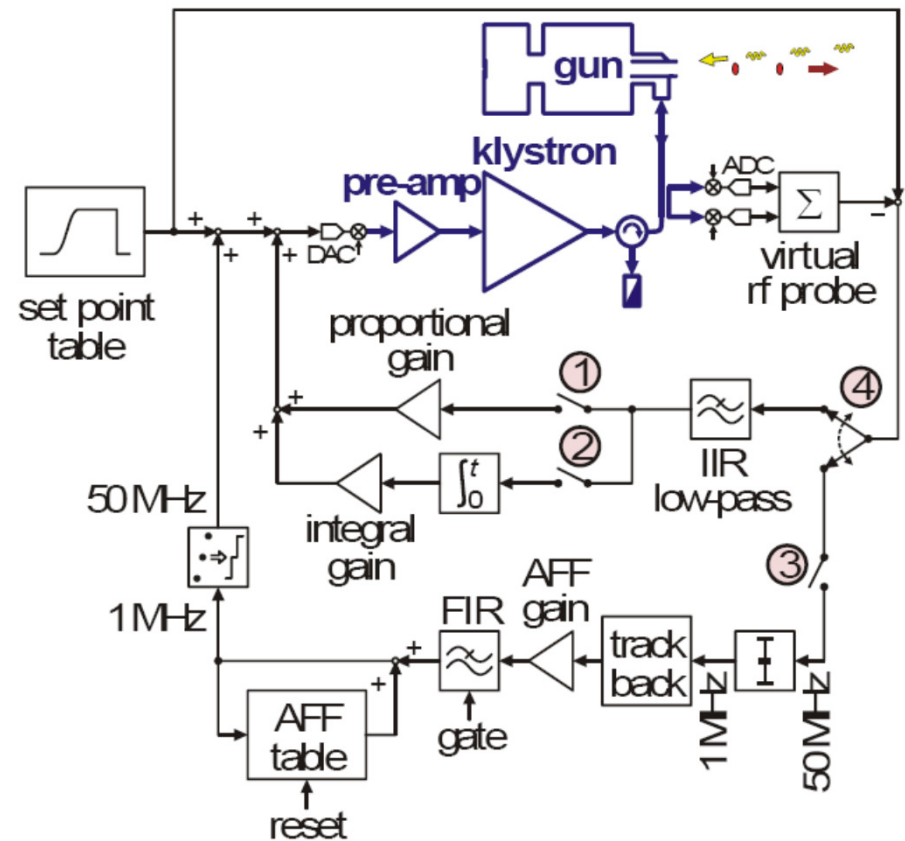



Probe Calibration

- The relation between cavity voltage, forward and reflected signals is

$$\vec{V}_c = \vec{V}_{for} + \vec{V}_{ref}$$

- The true forward and reflected signals can be estimated from the measurement, the coefficients m and n are complex number which need to be calibrated

$$\vec{V}_{for} = m\vec{V}_{for_m}$$

$$\vec{V}_{ref} = n\vec{V}_{ref_m}$$

$$\vec{V}_c = m\vec{V}_{for_m} + n\vec{V}_{ref_m} = m\left(\vec{V}_{for_m} + \frac{n}{m}\vec{V}_{ref_m}\right)$$

- The relative value n/m is of most interested here



Cavity Equations for RF Gun

- Calibration is done with feed forward mode (no feedback) and no beam
- RF gun employs normal conducting cavity, so use the general equation

$$\frac{d\vec{V}_c}{dt} + (\omega_{1/2} - j\Delta\omega)\vec{V}_c = \frac{2\beta}{\beta+1} \omega_{1/2} \vec{V}_{for}$$

- RF gun cavity has a small time constant, so we can examine its steady state equation

$$\vec{V}_c = \frac{2\beta}{\beta+1} \frac{\omega_{1/2}}{\omega_{1/2} - j\Delta\omega} \vec{V}_{for}$$

- Use the formula of

$$\vec{V}_c = \vec{V}_{for} + \vec{V}_{ref}$$

- We get the basic description of the RF gun cavity

$$\Gamma = \frac{\vec{V}_{ref}}{\vec{V}_{for}} = \frac{2\beta}{\beta+1} \frac{\omega_{1/2}}{\omega_{1/2} - j\Delta\omega} - 1$$



Cavity Resonance Circles

$$\Gamma = \frac{\vec{V}_{ref}}{\vec{V}_{for}} = \frac{2\beta}{\beta+1} \frac{\omega_{1/2}}{\omega_{1/2} - j\Delta\omega} - 1$$

- Γ for $\beta < 1$
- Γ for $\beta = 1$
- Γ for $\beta \gg 1$

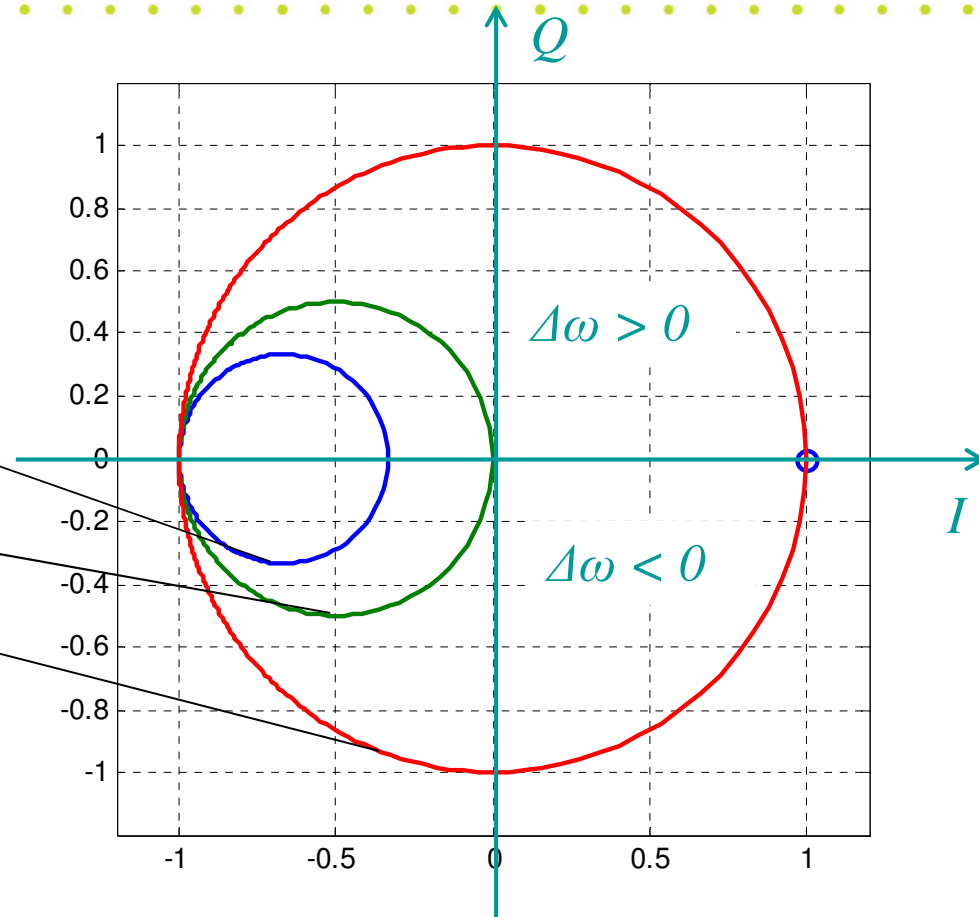

- The reflection factors form a circle in the complex plane with detuning changes
- All resonance circles pass the point of (-1, 0) regardless of the coupling factor when the detuning approaches the infinity (means complete reflection)

Calibration Procedure

- The measured reflection factor

$$\Gamma_m = \frac{\vec{V}_{ref_m}}{\vec{V}_{for_m}} = \left(\frac{2\beta}{\beta+1} \frac{\omega_{1/2}}{\omega_{1/2} - j\Delta\omega} - 1 \right) \cdot \frac{m}{n}$$

- When detuning approaches infinity (maximum reflection), the relative coefficient can be calculated as

$$\frac{n}{m} = - \frac{1}{\Gamma_{m, \Delta\omega = \pm\infty}}$$

- It is not possible to detuning the cavity to infinity, but the reflection factor at infinite detuning can be estimated by fitting the resonance circle (detune the cavity with 1 bandwidth has already cover half of the resonance circle)

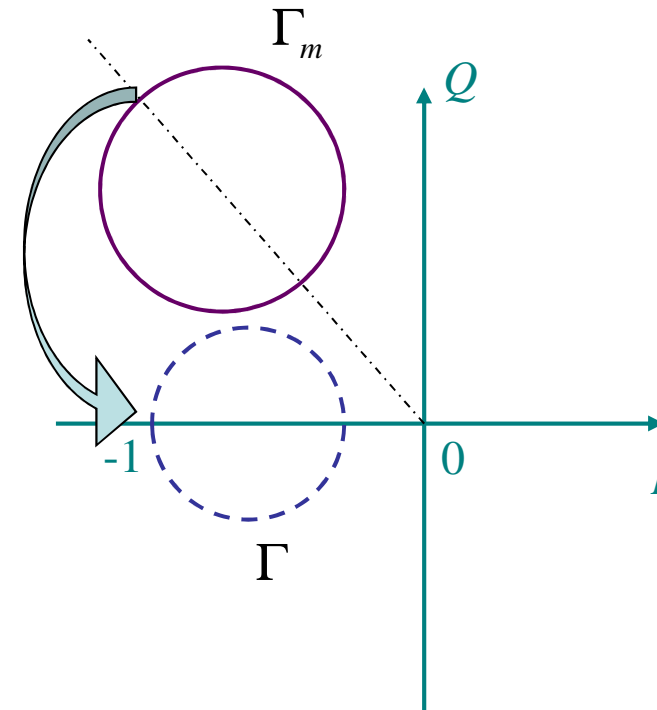



Methods to Detune the RF Gun Cavity

- Change the temperature of the RF gun cavity

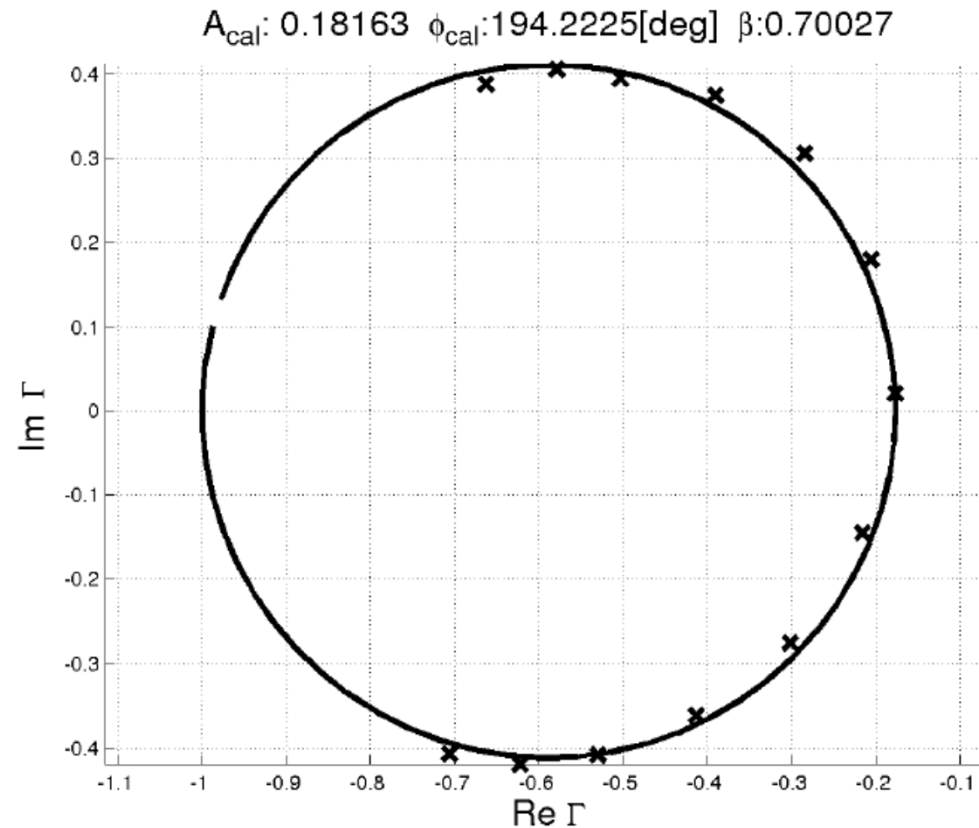



Methods to Detune the RF Gun Cavity

- Phase modulation of the feed forward signal

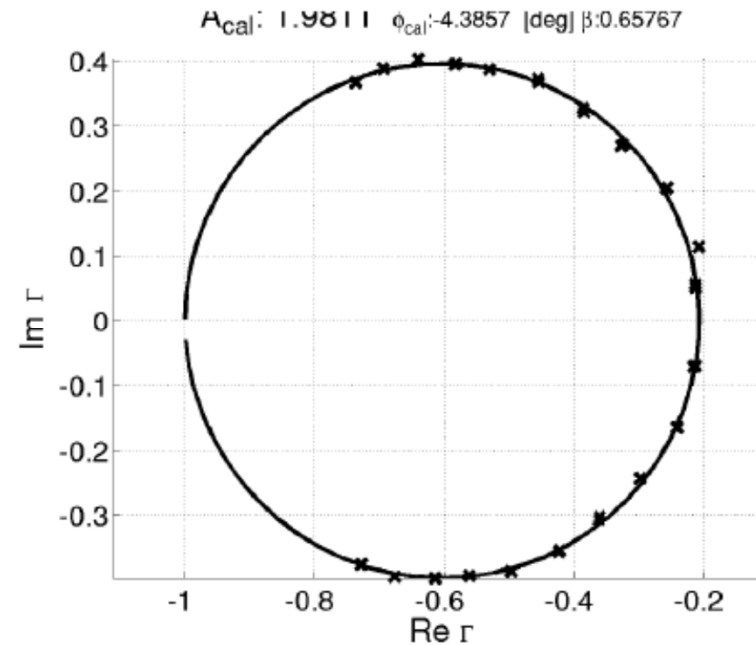
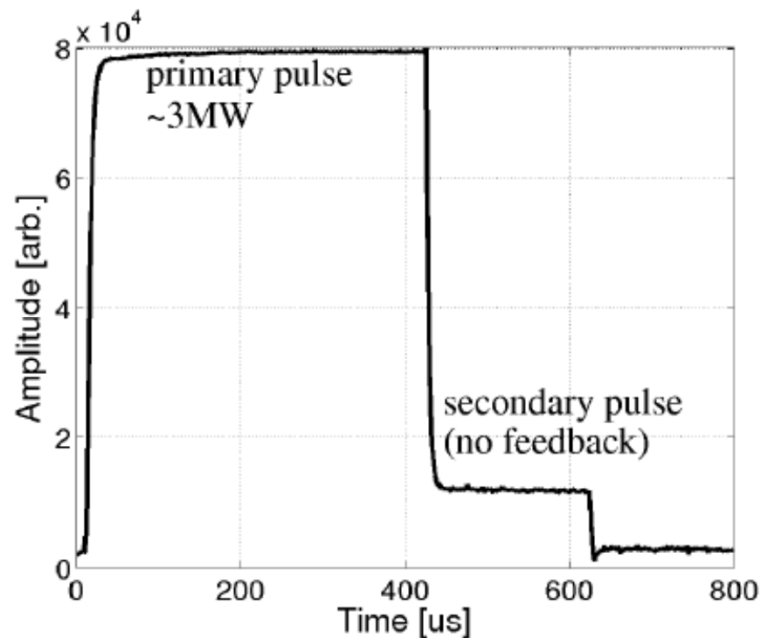



Gun Calibration at FLASH

- Feed forward mode
- Detuning achieved by modification of RF-Gun temperature set point
- For safety reason the reflected power should not exceed 1MW

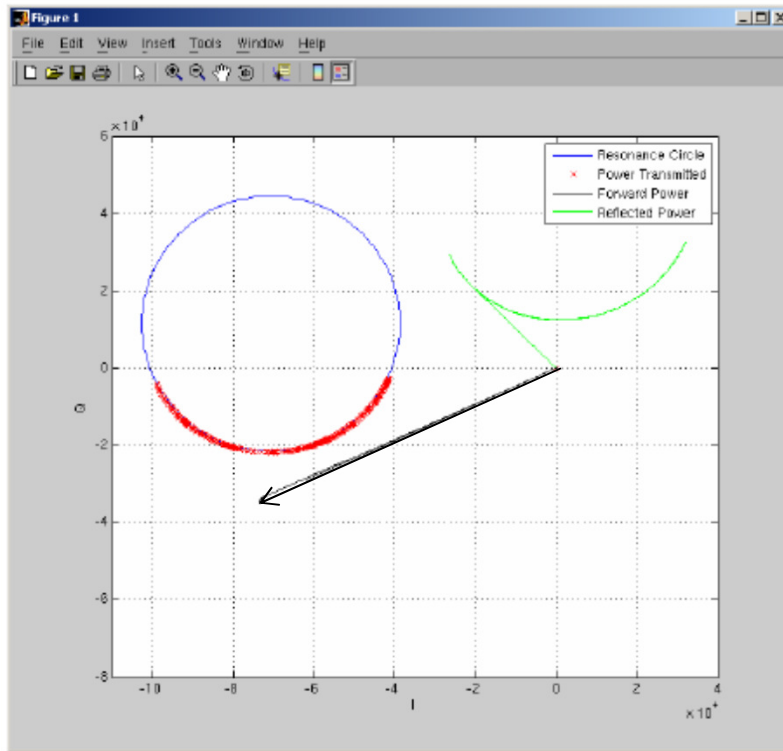

Before calibration

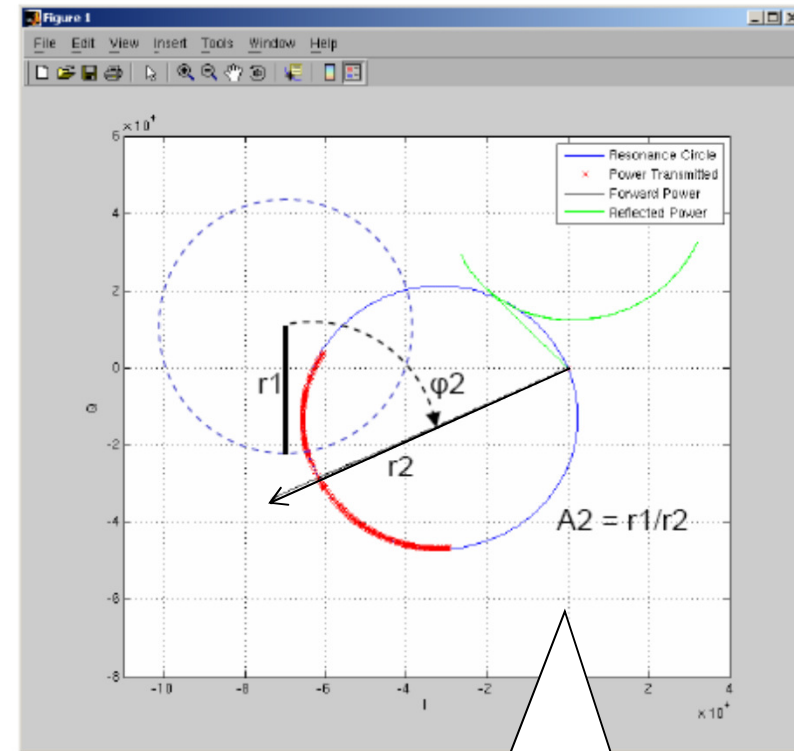

After calibration

$$n/m = A_2 \cdot \exp(j\phi_2)$$



Parameters Optimization - Adaptive Feed Forward



Adaptive Feed Forward

Optimize controller's feed forward tables

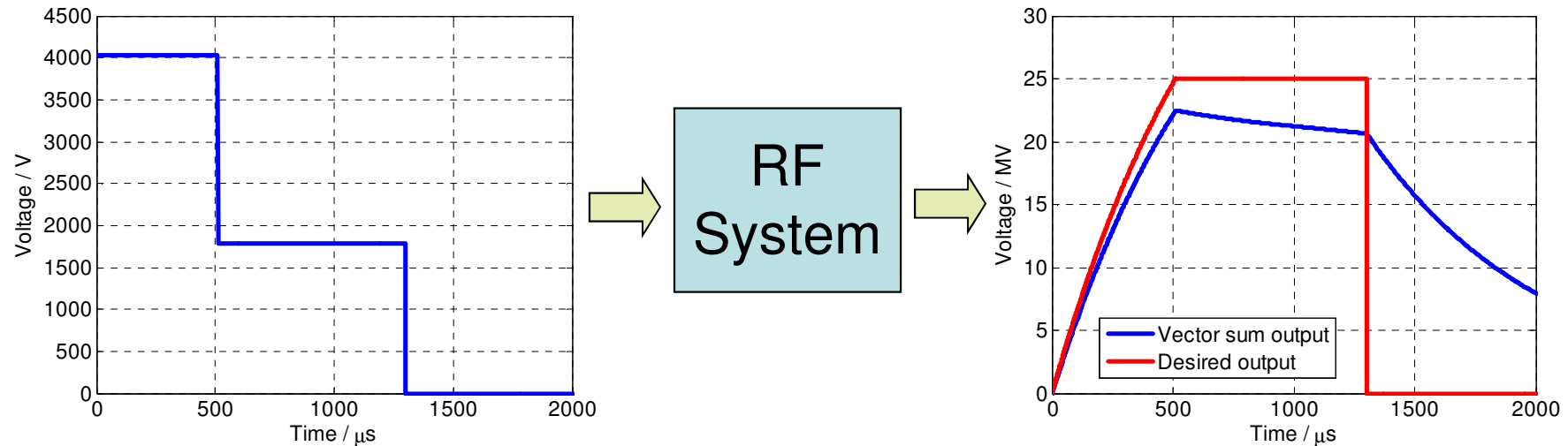

- Compensate the repetitive errors of the system
- Adapt the feed forward table for new working point setting



Adaptive Feed Forward

Solutions:

- Time reversed filter
- Inversed grey box model
- Iterative learning control based on black box model



Time Reversed Filter

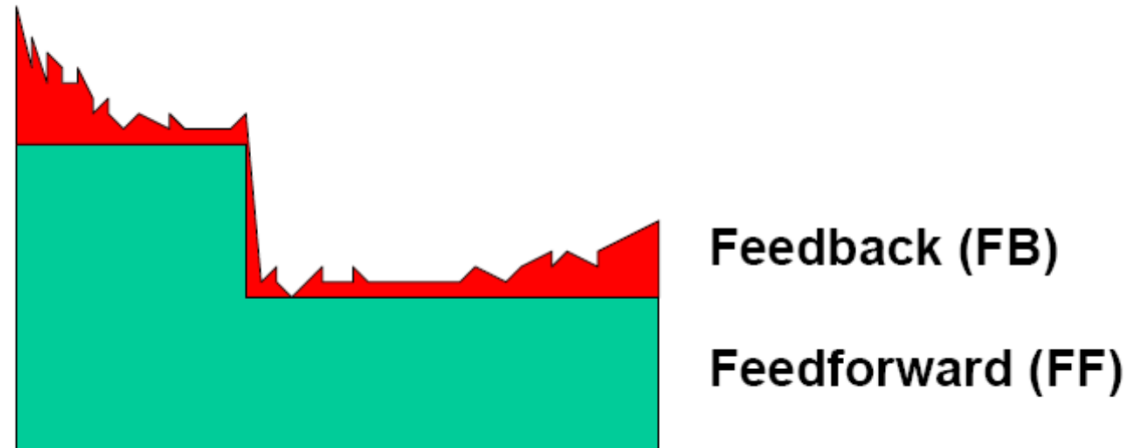

Idea: $FF_{\text{new}} = FF_{\text{last}} + FB_{\text{last}}$

FB is filtered by a time reversed low pass filter



Time Reversed Filter

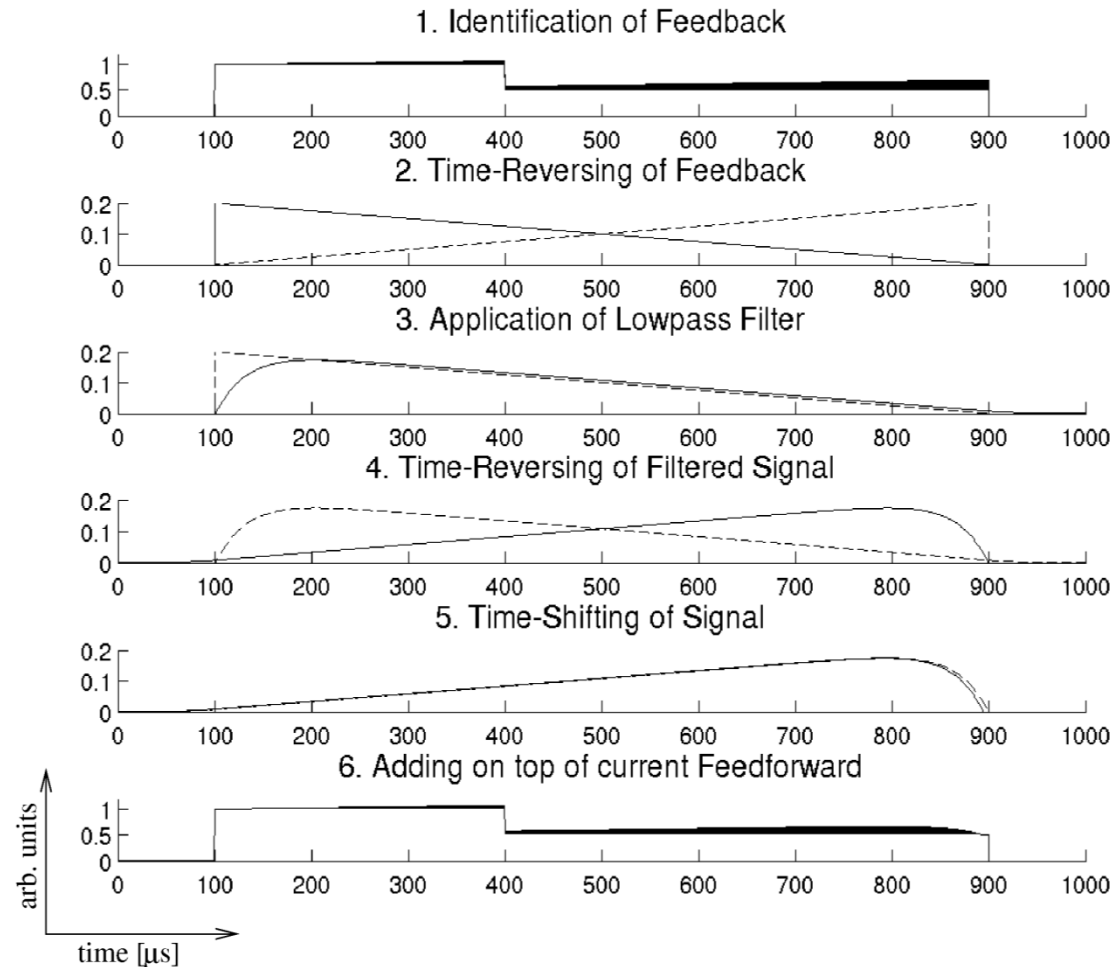



Time Reversed Filter

FB, Gain=25, AFF OFF

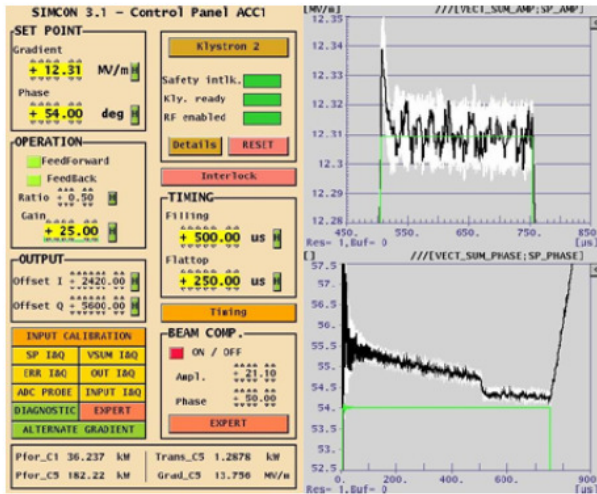

AFF OFF

FB, Gain=5, AFF ON

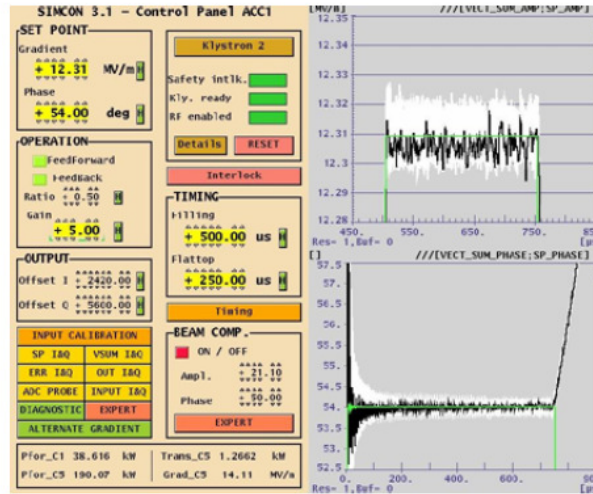

AFF ON

Test at ACC1 of FLASH:

no beam

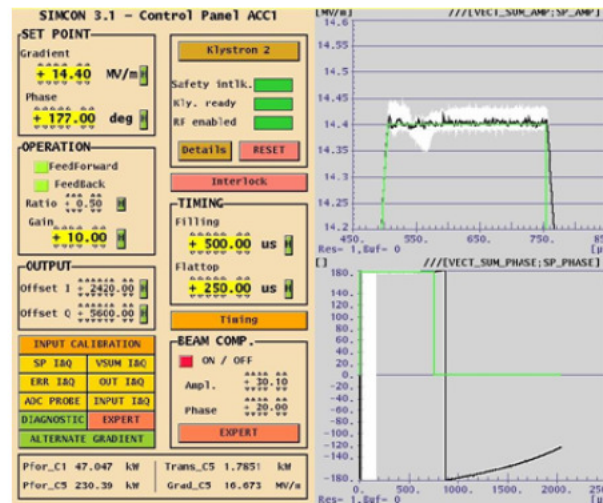
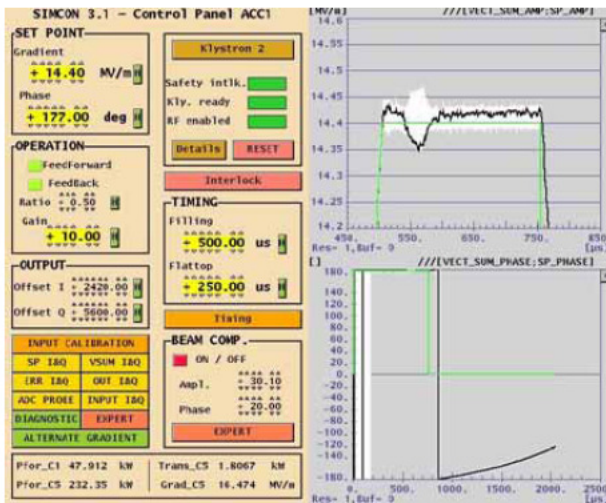

Test at ACC1 of FLASH:

beam loading compensation

Inversed Grey Box Model

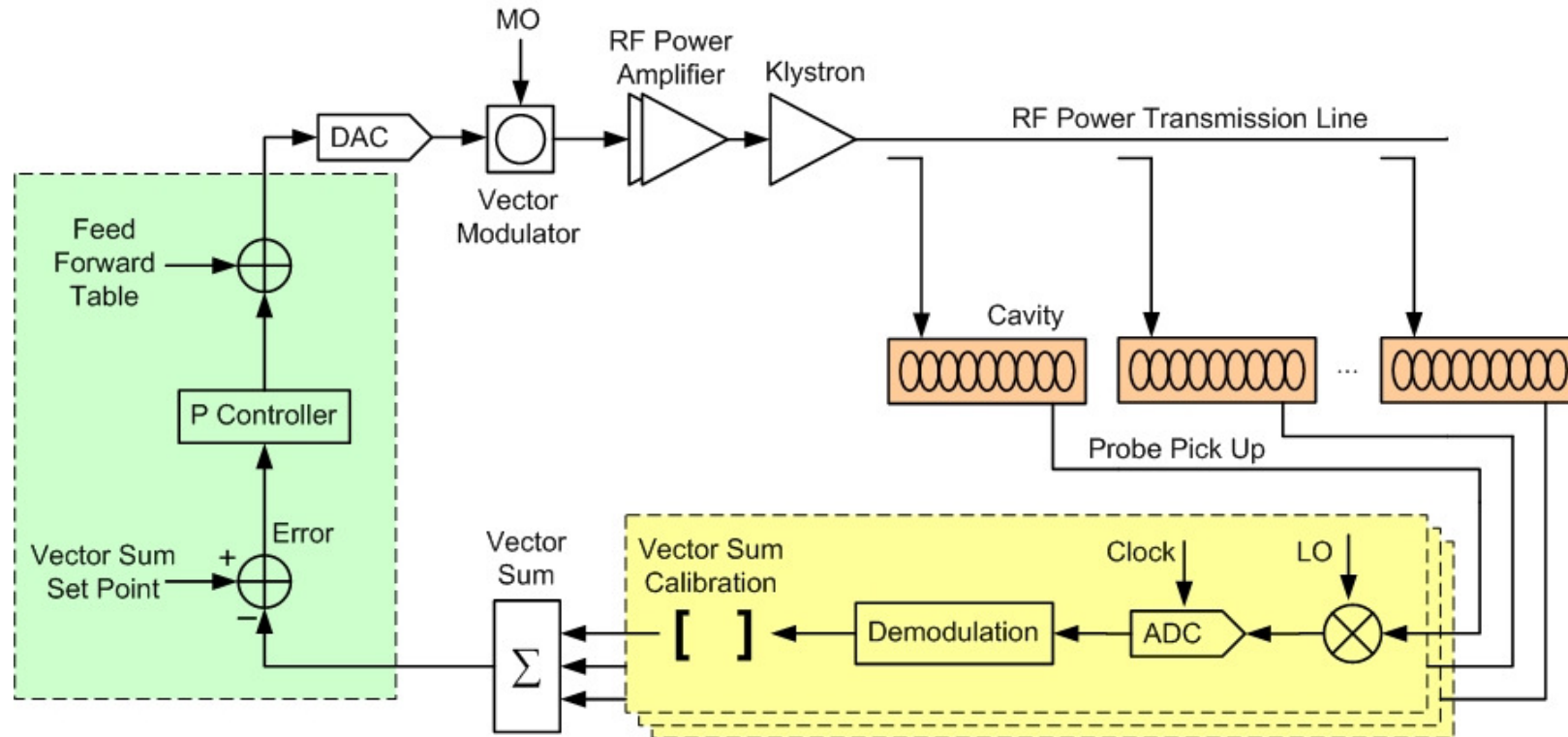

Grey box model in closed loop:

$$\frac{d\vec{V}_{sum}}{dt} + \left(\omega_{1/2} + CGP\sqrt{\omega_{1/2}} - j\Delta\omega \right) \vec{V}_{sum} = CG\sqrt{\omega_{1/2}} \vec{V}_{FF}, \quad C = \sqrt{\left(\frac{r}{Q} \right) \frac{\omega_0}{Z_0}}$$



Inversed Grey Box Model

Correct the feed forward based on vector sum error:

$$\Delta \vec{V}_{FF} = \frac{d(\Delta \vec{V}_{sum})}{dt} + (\omega_{1/2} + CGP\sqrt{\omega_{1/2}} - j\Delta\omega)\Delta \vec{V}_{sum}, \quad C = \sqrt{\left(\frac{r}{Q}\right) \frac{\omega_0}{Z_0}}$$

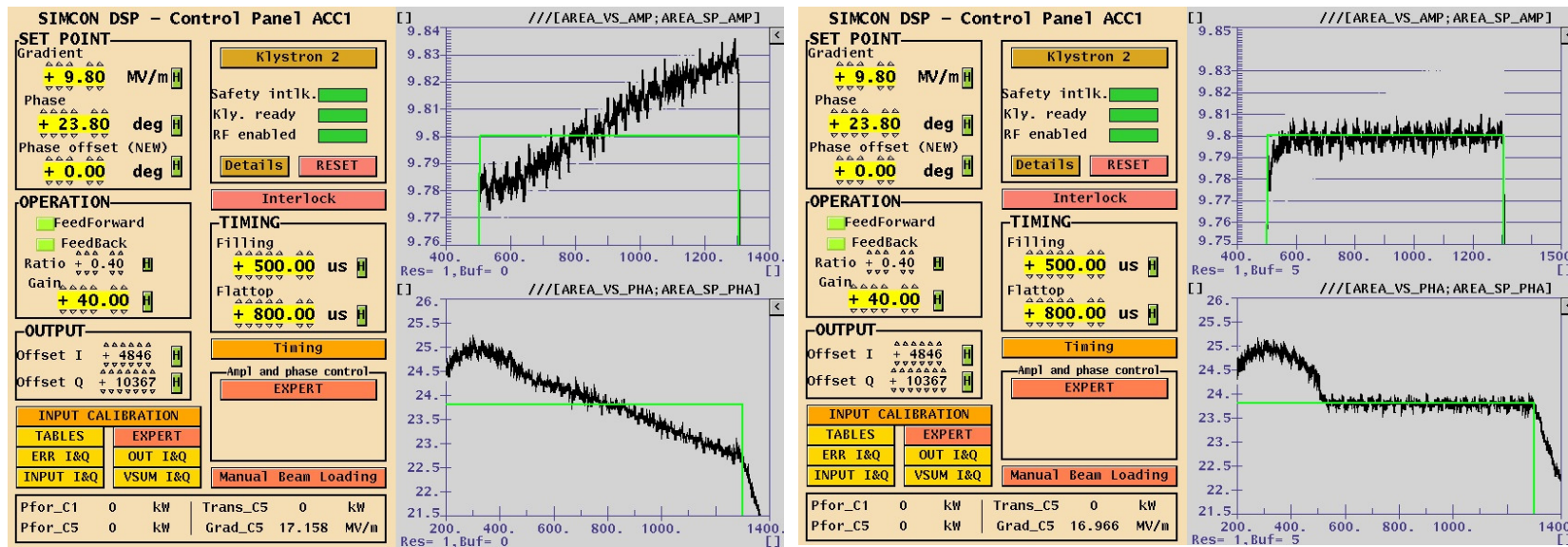



Iterative Learning Control

Idea: Use information from previous trails to improve the FF signal for upcoming pulses.

$$u_{k+1} = u_k + L e_k$$

→ k – trial number
u – system input (FF)

- L can be any Filter function (time reversed low pass,...)
- Here L depends on Black box model parameters
- Norm-Optimal Iterative learning control



RF – Field During Adaptation

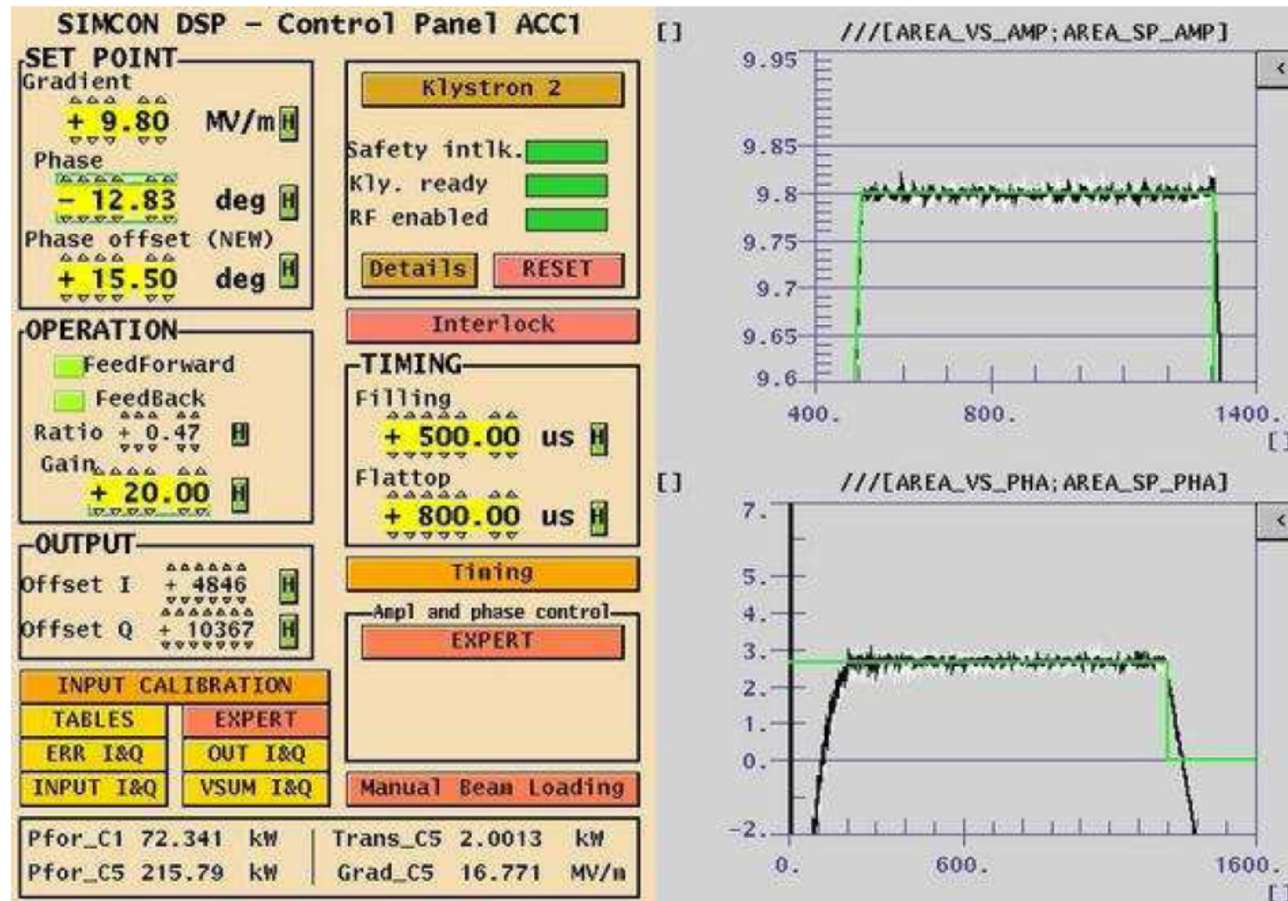

Removed all deterministic effects like:
Beam loading, Lorenz force detuning and overshoots



Beam Loading Compensation

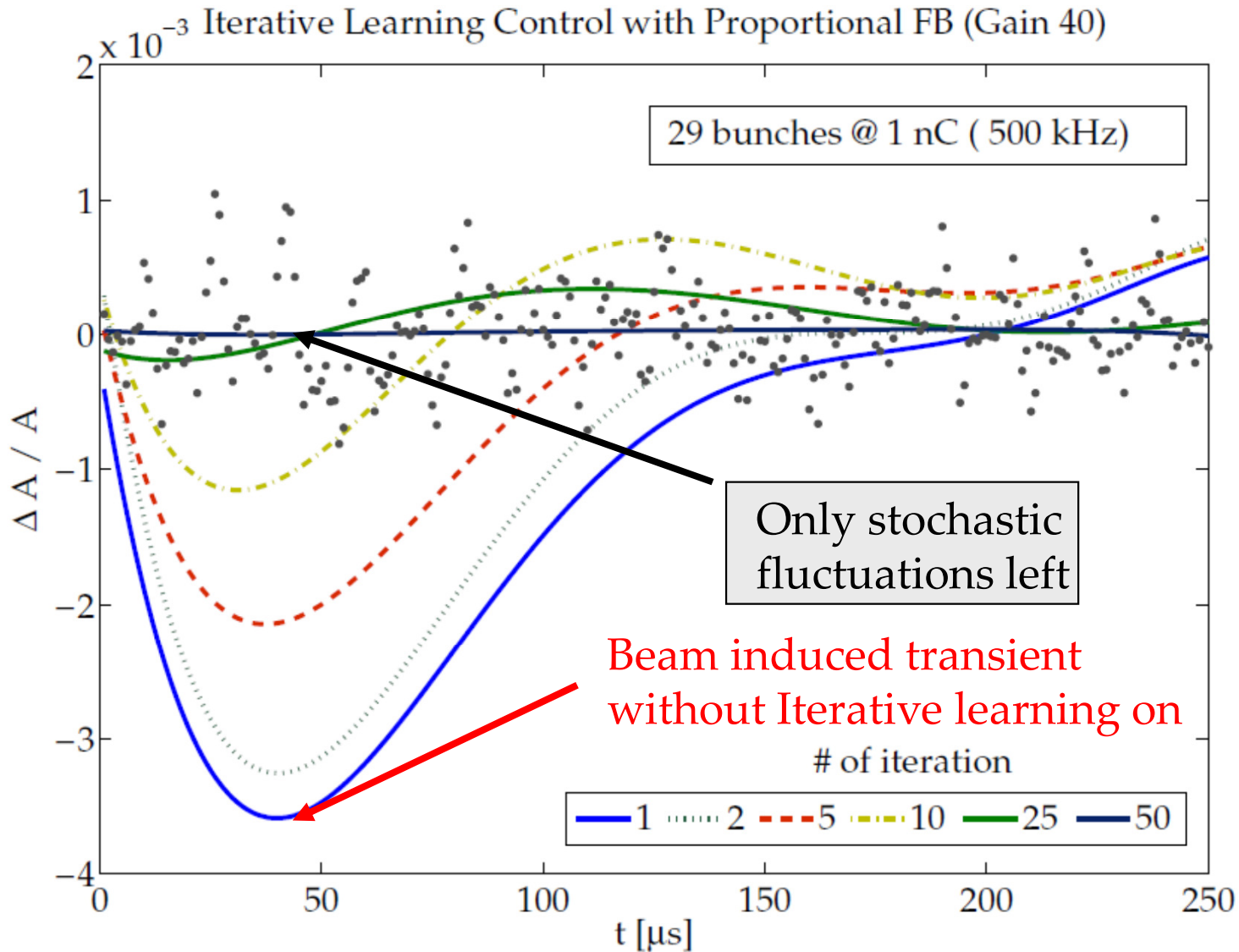



Measured Beam Energy Spread

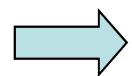
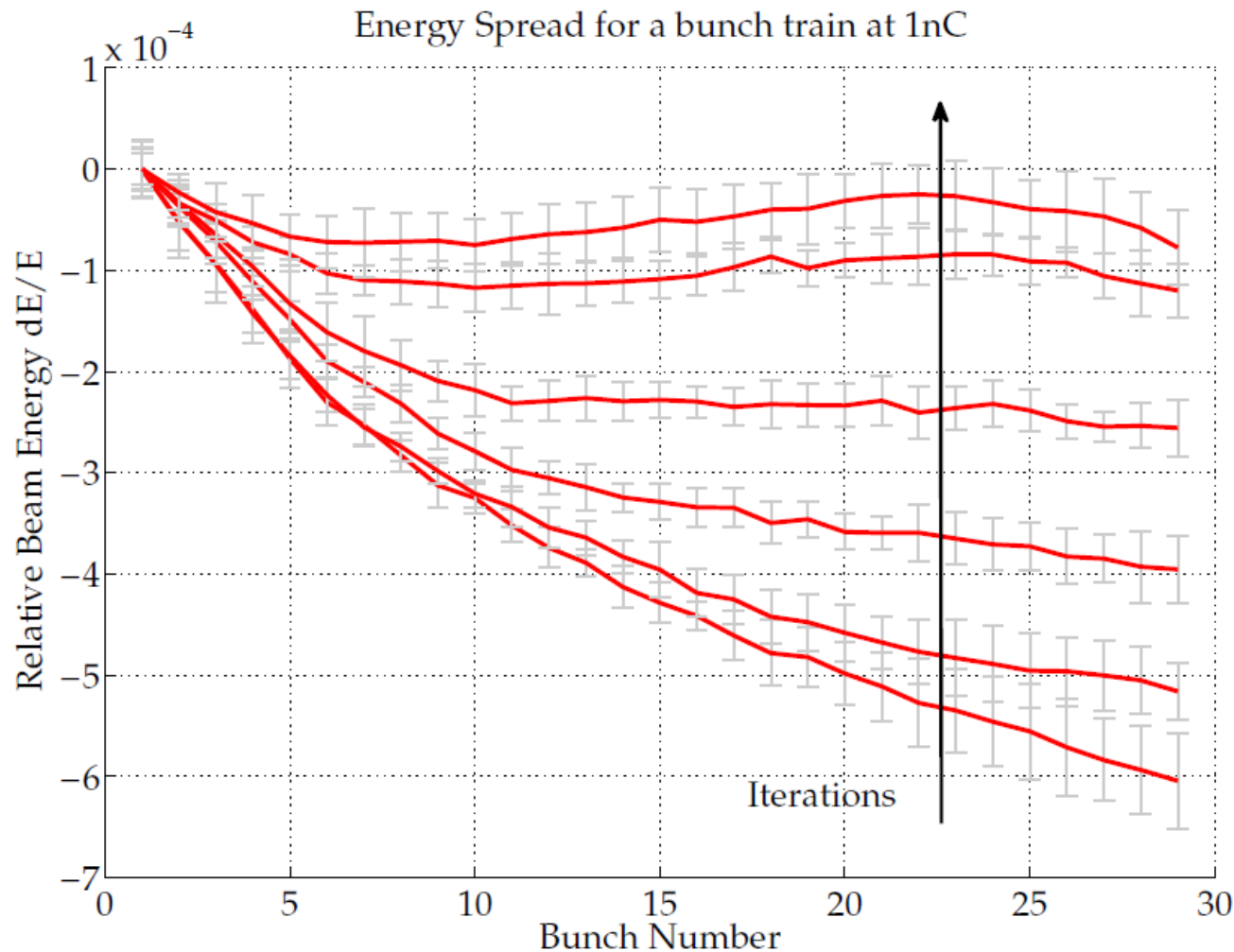

Field adaptation minimizes energy spread!



Animation of Adaptation

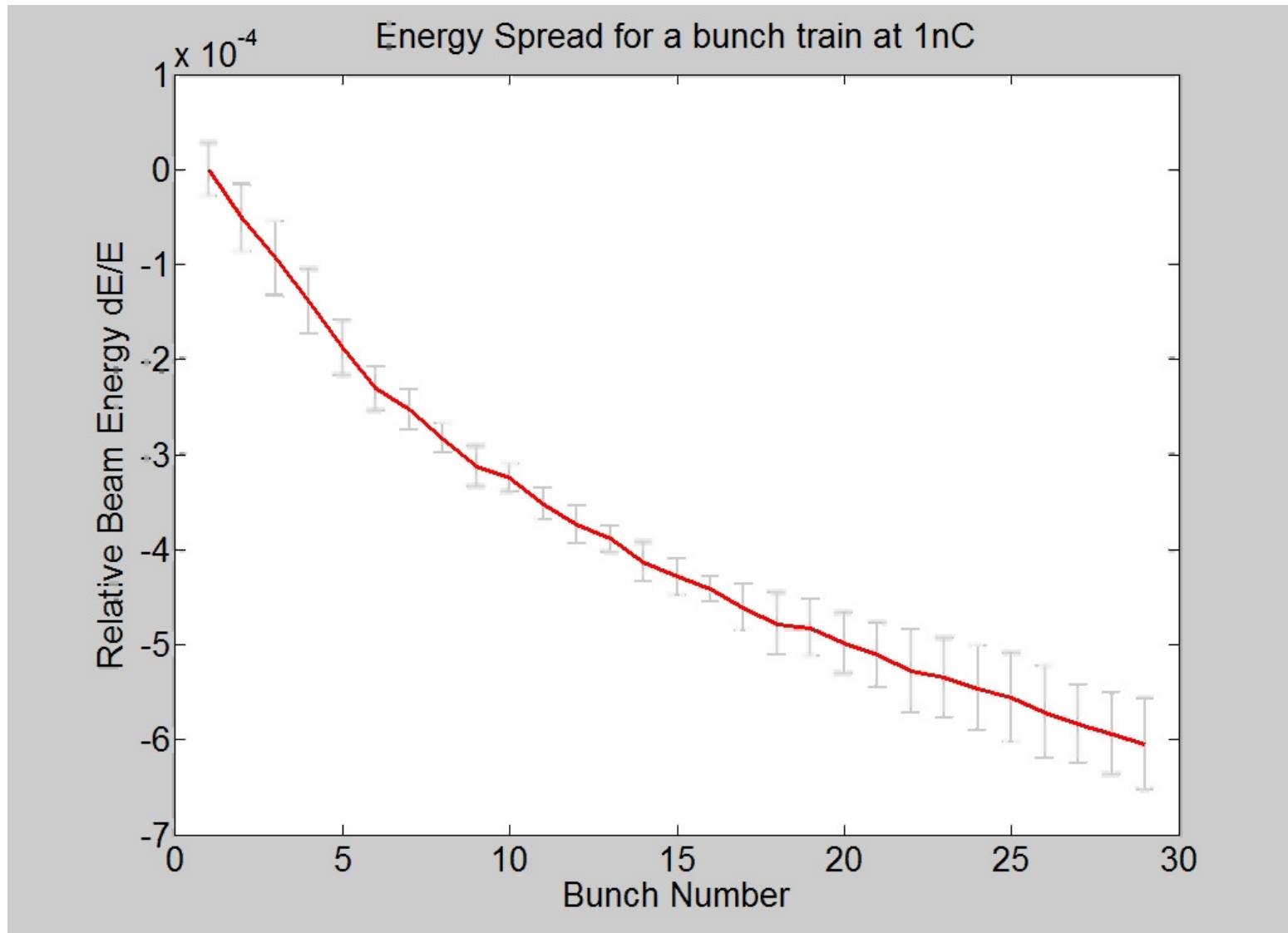



Exception Detection



Exception Detection and Handling

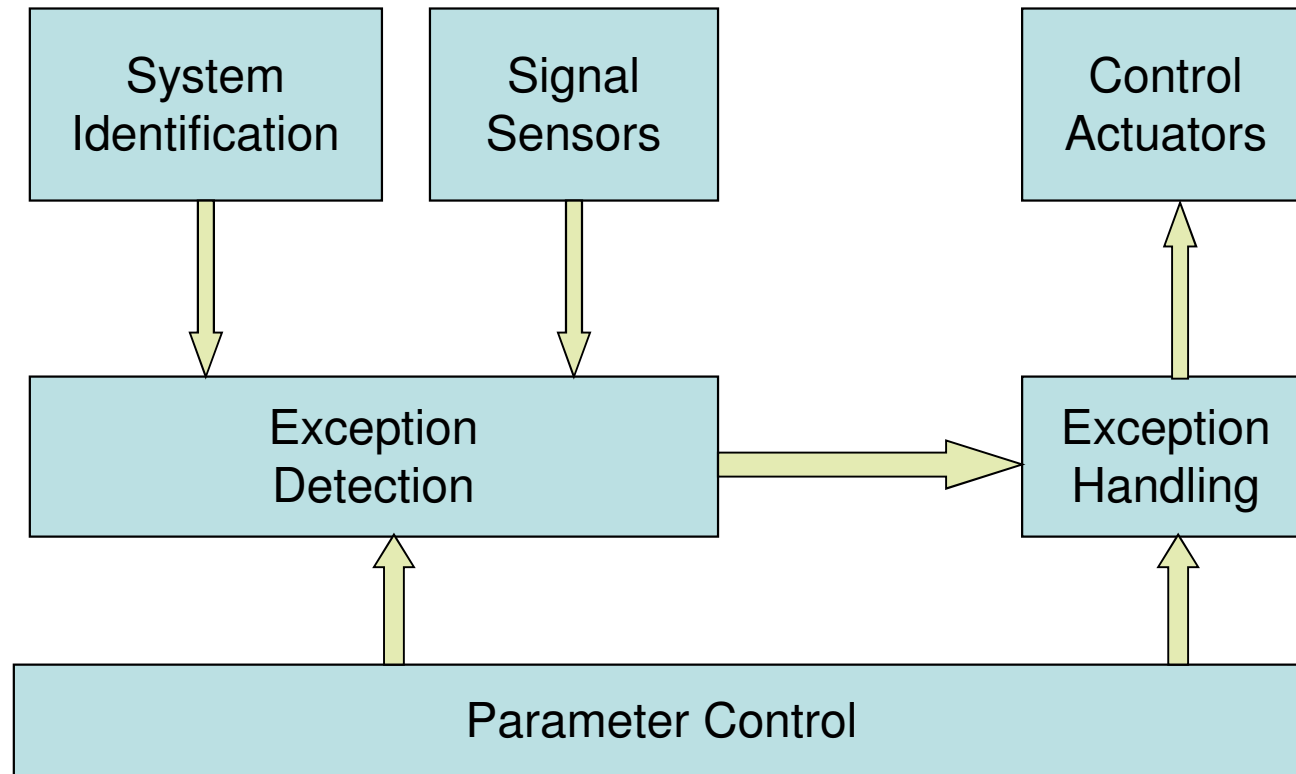



Examples for LLRF Exceptions

Table 1: Examples for Exceptions, their impact, countermeasures and the resulting improvement

Exception	Impact	Countermeasure	Result
cavity quench hard/soft	Beam energy fluctuation	Lower grad., comp. with other cav.	Recover after few pulses
Cavity field emission	Radiation damage Electronics	Lower grad., comp. with other cav.	Reduce radiation levels
Cavity excessive detuning	Gradient / phase stability	Tune cavity to op. frequency	Recover in few pulses
Cavity incident phase error	Reduced available energy gain	Re-phase with 3-stub tuner	Recover on crest- operation
Cavity loaded Q error	Slope on individual gradient	Adjust loaded Q	Flat top in all cavities
Piezo tuner defect	No Lorentz force compensation	Not available	-
Motor tuner stuck	Cavity lost or strong field slope	Not available	-
Occasional klystron gun spark	Beam energy, Beam loss	Reset, bypass	Recovery after few pulses
Frequent klystron gun spark	Low availability, klystron damage	Lower high voltage	High avail., lower gradient
Occasional coupler spark	Shorten rf and beam pulses	Lower power	Operation at lower gradient
Preamplifier failure	Loss of rf station	Switch to redundant system	Recover after few pulses
Modulator HV unstable	Gradient / phase stability		
Preamplifier saturated	Field regulation reduced	Lower gradient	Recover after few pulses
Timing jitter LLRF/Laser	Loss in peak current, energy error	Not available	-
Timing trigger/clock missing	Loss of linac / rf station	Switch to redundant system	Recover after few pulses
Timing error subsystem	Potential loss of SASE	Adjust timing	Recover after few pulses
M.O. and distribution failure	Loss of main linac	Switch to redundant system	Recover after few pulses
Vector-modulator failure	Loss of field control	Switch to redundant vector-mod.	Recover after few pulses
Calibration reference failure	Slow phase drift, beam energy	Use beam feedback	Stable beam
RF station LO missing	Loss of Gradient	Switch to redundant feedforward	Beam at reduced stability



Exception Detection - Quench Detection



Motivation for Quench Detection

- Cavity quench can cause unstable RF field or even beam loss, and increase the cryogenic heat load

Cavity gradient for ACC1, cavity No2 quench (zoom)

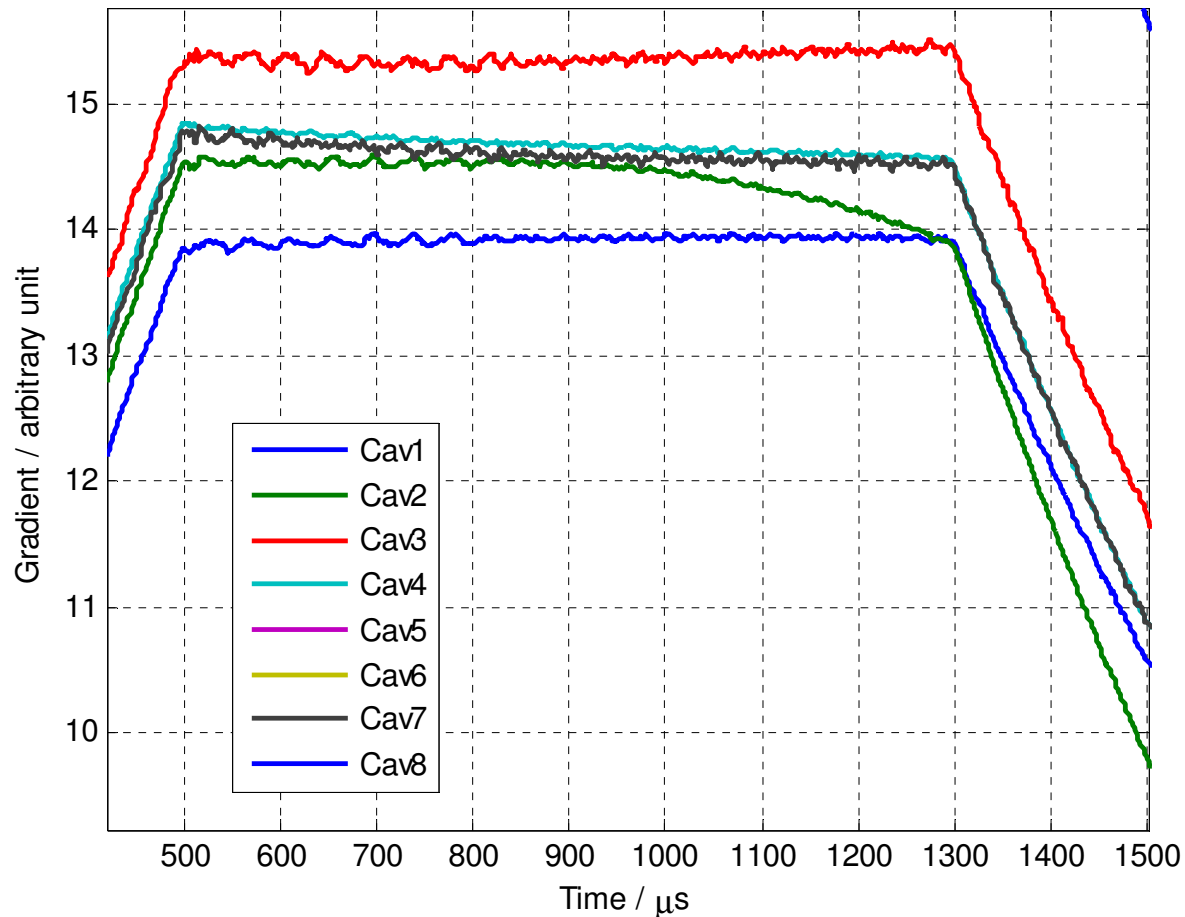



Method for Quench Detection

- Monitoring the cavity gradient drop (gradient drop can also be caused by detuning or beam loading)
- Measure the loaded Q of each cavity, if the loaded Q drops larger than the threshold, quench event will be generated
- Loaded Q can be measured with the grey box system identification algorithm

$$Q_L = \frac{\omega_0}{2\omega_{1/2}}$$



Test at ACC1 of FLASH

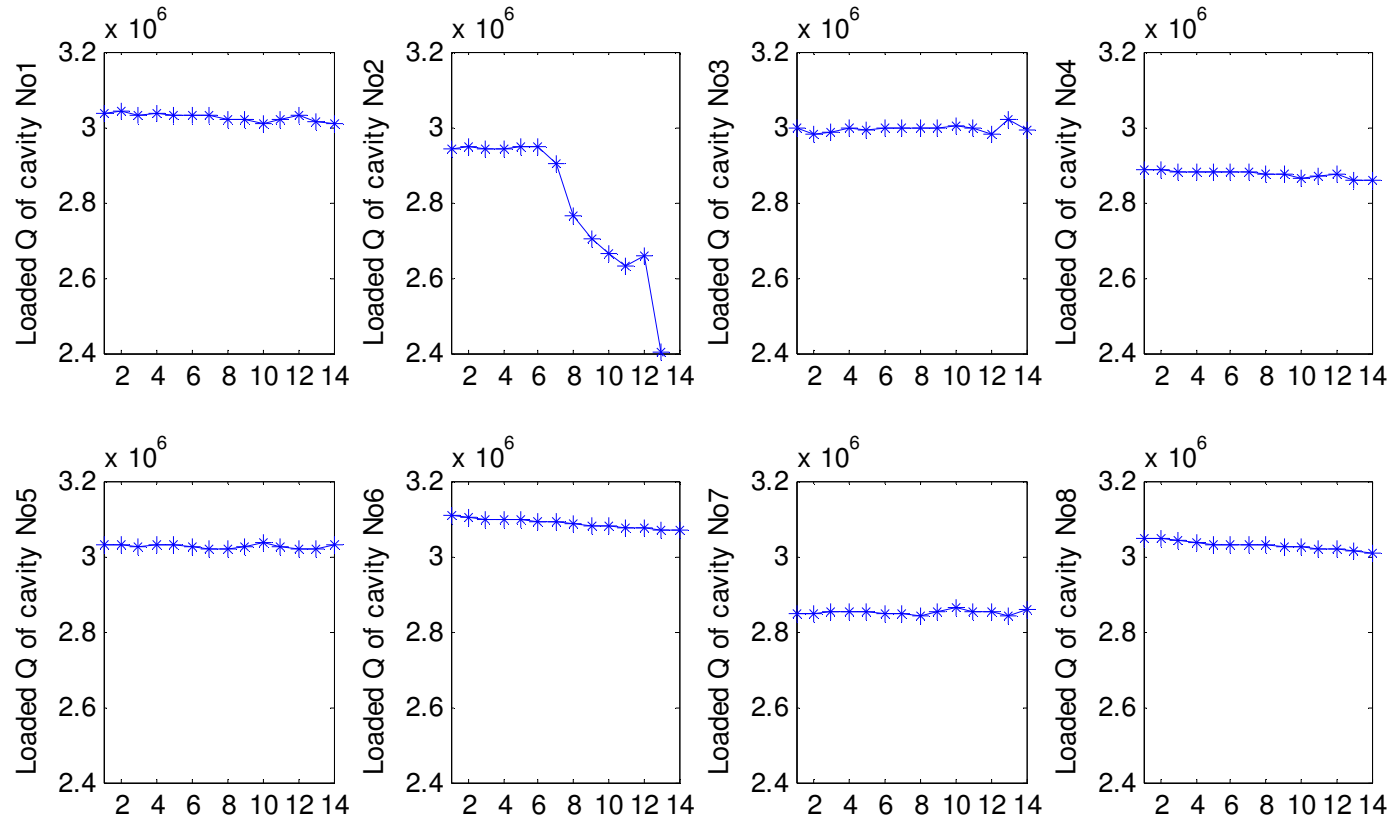

Loaded Q measurement at the RF decay part for each cavity of ACC1, the x number means 14 times measurement with different set point gradient (from 9.3MV/m to 10.6MV/m, 0.1MV/m as increment steps)



Test at ACC1 of FLASH

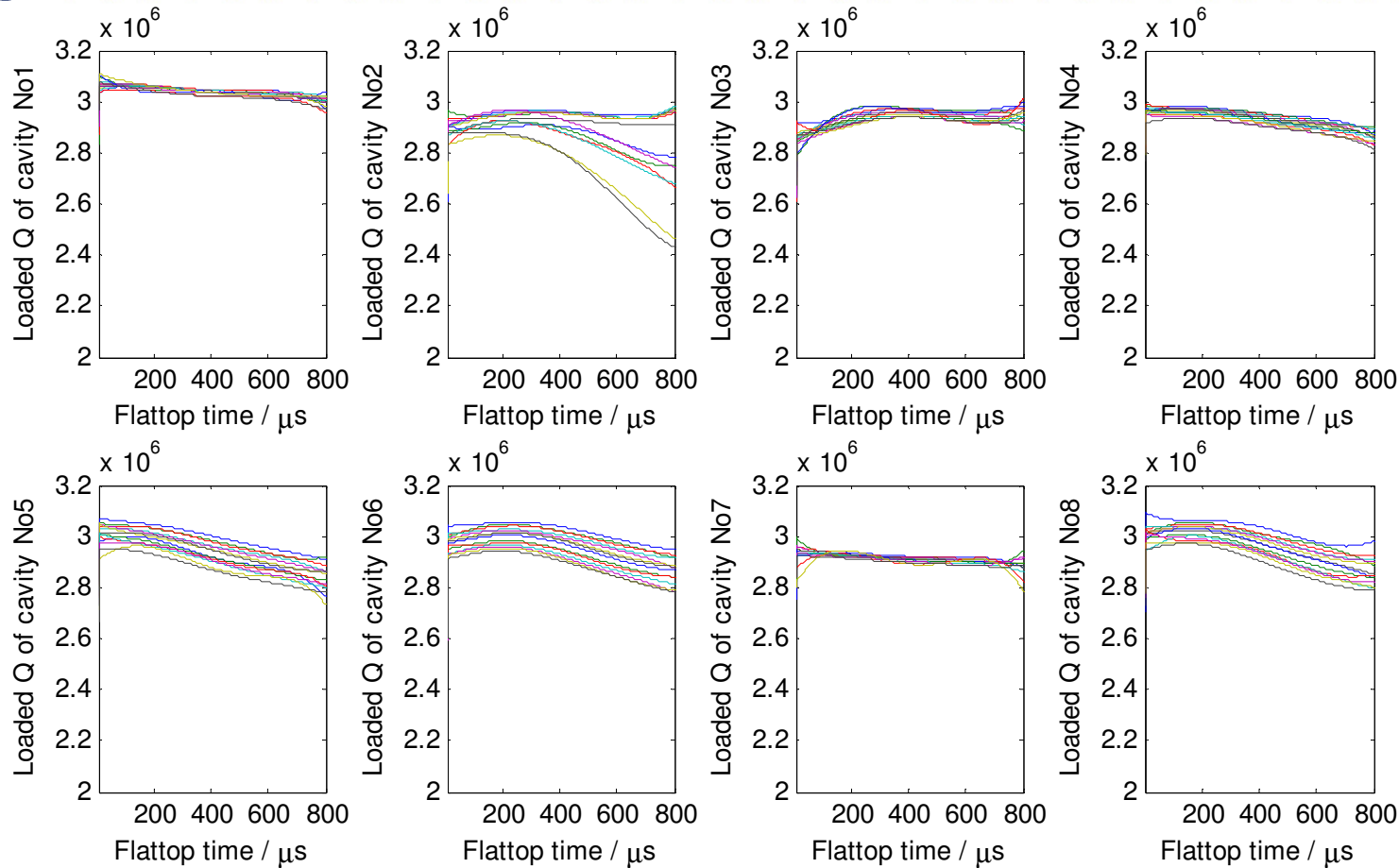

Loaded Q measurement during RF flattop for each cavity of ACC1, the curves for each cavity means 14 times measurement with different set point gradient (from 9.3MV/m to 10.6MV/m, 0.1MV/m as increment steps)



Test at ACC1 of FLASH

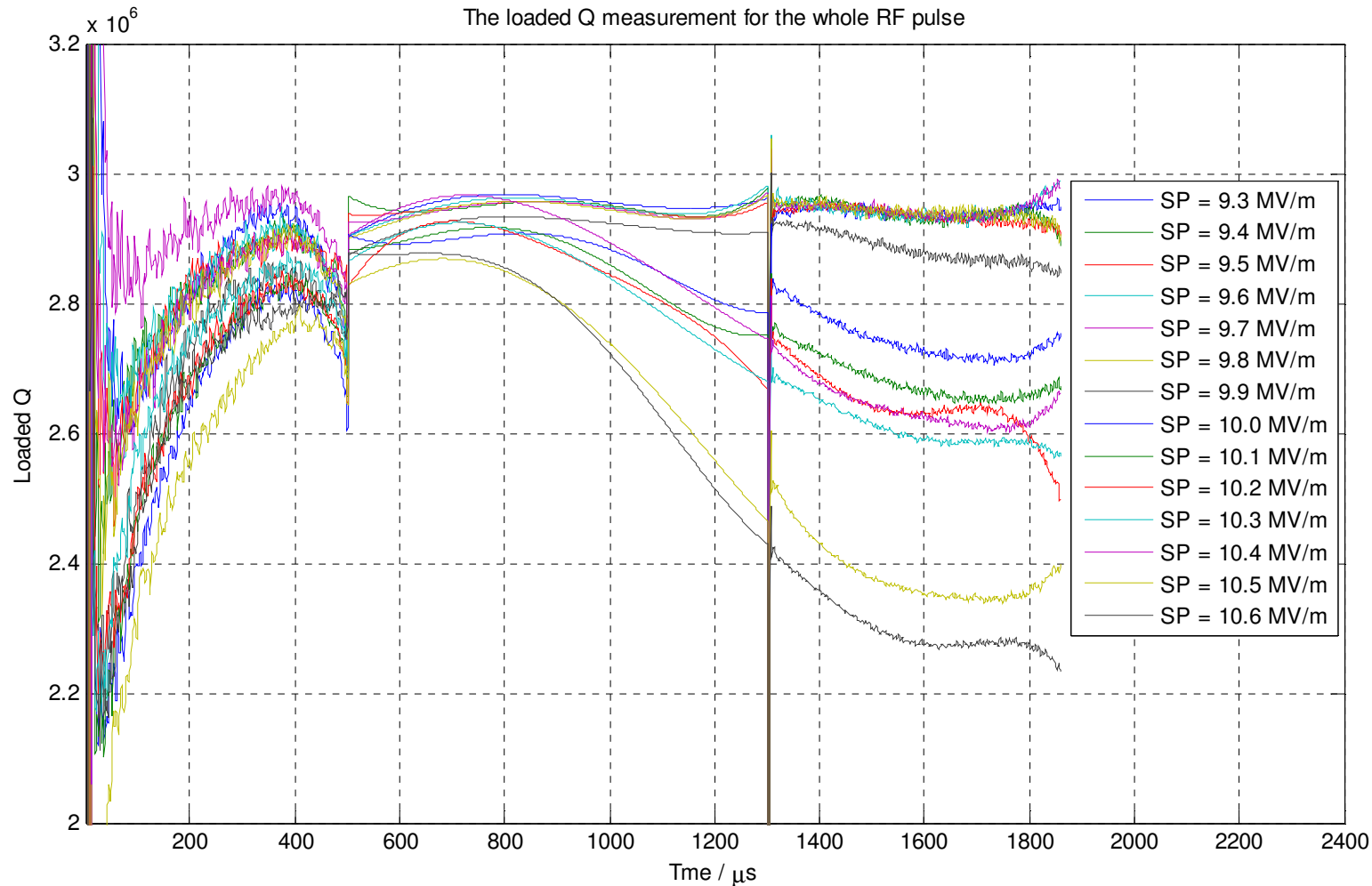

Loaded Q measurement of cavity No.2 at ACC1 during the RF pulse with different set point gradient



Summary

In this part, we have learnt that LLRF application software is important to support the LLRF system to reach performance specifications and be more robust.

Several examples for system identification, parameters optimization, system calibration and exception detection are introduced.

The functionalities that the applications should perform will strongly depend on the requirements to LLRF system, especially from the operation point of view.



Reference

- [1] T. Schilcher. Vector Sum Control of Pulsed Accelerating Fields in Lorentz Force Detuned Superconducting Cavities. Ph. D. Thesis of DESY, 1998
- [2] A. Brandt. Development of a Finite State Machine for the Automated Operation of the LLRF Control at FLASH. Ph.D. Thesis of DESY, 2007
- [3] A. Brandt, P. Pucyk. Field Estimation and Signal Calibration of RF Guns without Field Probe. TESLA-FEL 2007-01
- [4] E. Vogel, W. Koprek, et.al. FPGA Based RF Field Control at the Photo Cathod RF Gun of the DESY Vacuum Ultraviolet Free Electron laser. CARE-Report-2007-009-SRF
- [5] S. Simrock, V. Ayvazyan, et.al. Exception Detection and Handling for Digital RF Control Systems. LINAC2006, Knoxville, Tennessee USA



Appendix 1

- Vector Sum Driving Signal Calibration



Vector Sum Driving Signal Calibration

- The vector sum driving signal can be calculated by the measurement of the klystron output
- A complex coefficient is used to calibrate the gain and phase error caused by the unknown signal path

$$\vec{V}'_{for} = K_{kly} \vec{V}'_{kly}$$

$$\frac{d\vec{V}'_{sum}}{dt} + (\omega_{1/2} - j\Delta\omega)\vec{V}'_{sum} = C\sqrt{\omega_{1/2}} K_{kly} \vec{V}'_{kly}$$

- Calibration steps:
 - Measure the half bandwidth and detuning at the point just after the RF driving signal is switched off
 - Assume the cavity half bandwidth and detuning will not change around the point when the RF driving signal is switched off (subscript 0 means the values just before the RF off)

$$K_{kly} = \frac{1}{C\sqrt{\omega_{1/2,0}} \vec{V}'_{kly,0}} \left[\frac{d\vec{V}'_{c,0}}{dt} + (\omega_{1/2,0} - j\Delta\omega_0)\vec{V}'_{c,0} \right]$$



Vector Sum Driving Signal Calibration

- The amplitude and phase of the driving signal is always referred to the measured amplitude and phase of the vector sum

