



FLASH 9mA Experiment in the context of the TDR

John Carwardine

LCWS 2011, 27 September 2011



- **Recap of TD Phase goals and results to date**
- **Remaining study items and issues**
- **Goals for remainder of TDP**
- **Outlook beyond the TDP (Thursday's talk)**

TTF/FLASH 9mA Experiment (2009 layout)

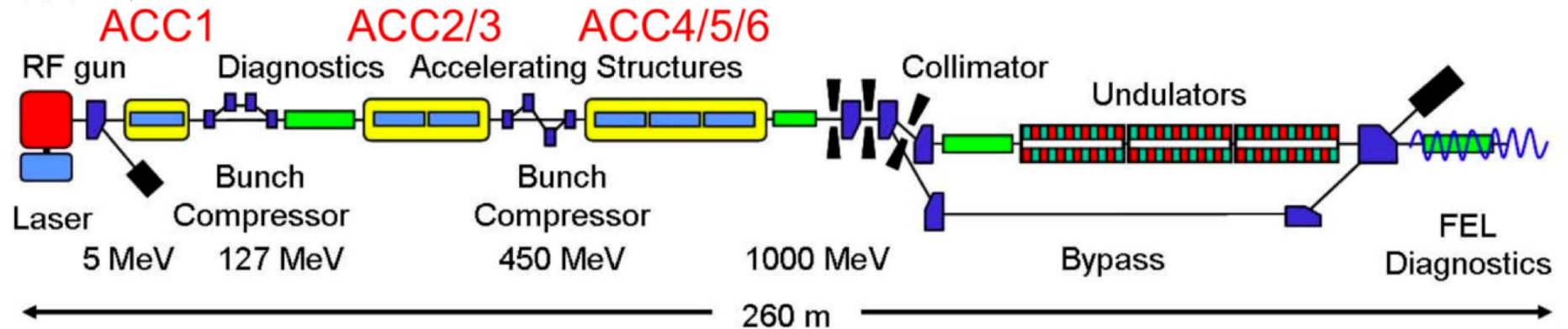

Comparison of machine parameters

		XFEL	ILC	FLASH design	9mA studies
Bunch charge	nC	1	3.2	1	3
Bunch rate	MHz	5	2.7	9	3
# bunches		3250	2625	7200	2400
Pulse length	μ s	650	970	800	800
Current	mA	5	9	9	9

Nominal experiment setup

- 3nC/bunch
- Bunch rates: 40kHz – 3MHz
- Laser #1: 40kHz – 1MHz; Laser #2: 3MHz
- RF systems operating nominally on crest
- BC magnets on, but no compression
- Beam through Bypass line to dump
- RF gun: 1.5 cell warm PC gun
- ACC1: 8 SC cavities
- ACC23: 2x 8 SC cavities
- ACC456: 3x 8 SC cavities
- LLRF: digital I/Q control of VS
- Piezo tuners: ACC3, ACC5, ACC6

Specific objectives for the 9mA study *(from 2008)*

“System Tests with ILC RDR beam parameters”

- **Long bunch-trains with high beam loading (9mA)**
 - 800 μ s pulse with 2400 bunches at 3MHz, 3nC per bunch
 - Vector Sum control of up to 24 cavities
 - +/- 0.1% energy stability
 - Cavity gradients approaching quench limits
 - Beam energy 700-1000MeV
 - HOM absorber studies (cryo-load)
- **Characterize operational limits**
 - Energy stability limitations and trade-offs
 - Cavity gradient overhead needed for LLRF control
 - Klystron power overhead needed for LLRF control
- **Operation close to limits, eg**
 - Robust automation of tuning, etc
 - Quench detection/recovery, exception handling
 - Beam-based adjustments/optimization

Establish ILC-like operating conditions

Studies under ILC-like operating conditions

High beam-loading long pulse operation (550 bunches at 1MHz, ~2.5nC / bunch at dump, 890MeV)

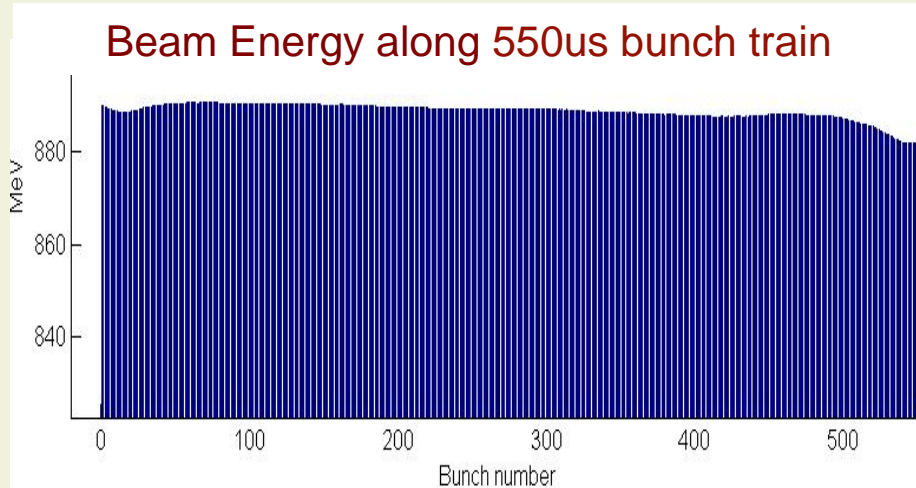

Long bunch trains:

- 450 bunches @ 1MHz
- 300 bunches @ 500KHz

... terminated early by vacuum incident in dump line

Biggest operational issue: minimizing beam losses

- High beam power (~6kW)
- Narrow energy aperture, sensitive to LLRF tuning
- Insufficient beam loss information from dump line

Long-pulse high current: achieved parameter space

800 bunches at 3mA for 15hrs

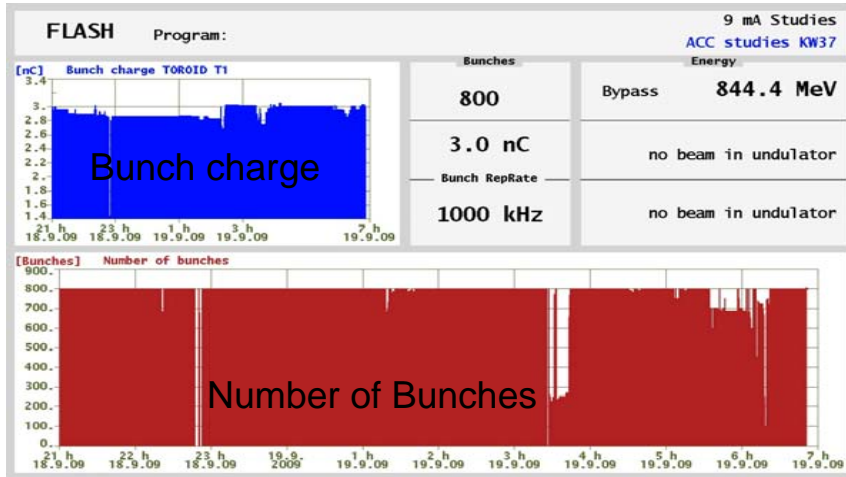

15hrs

Ramp-up in number of bunches @ 3MHz

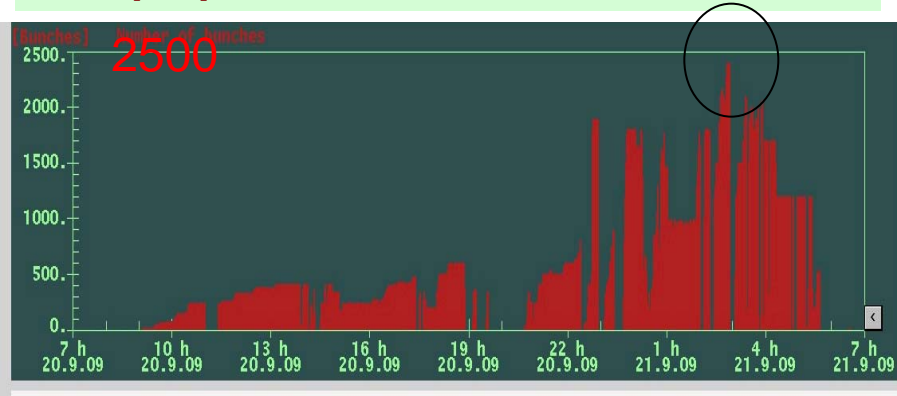

48hrs

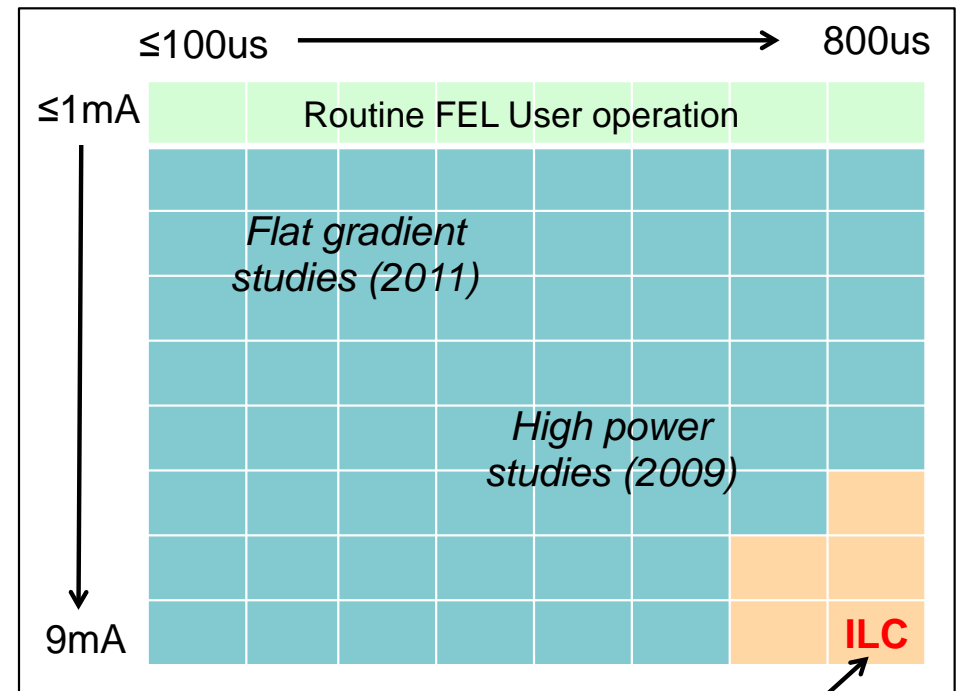

- Light green: Routine for FLASH FEL users
- Blue: Achieved during 9mA studies
- Orange: Not yet achieved stably

Achieved for short periods during tuning

Key 9mA R&D goal: HOM absorber studies

HOM absorber test setup at FLASH

2 Beam Tests in September 2008 and 2009

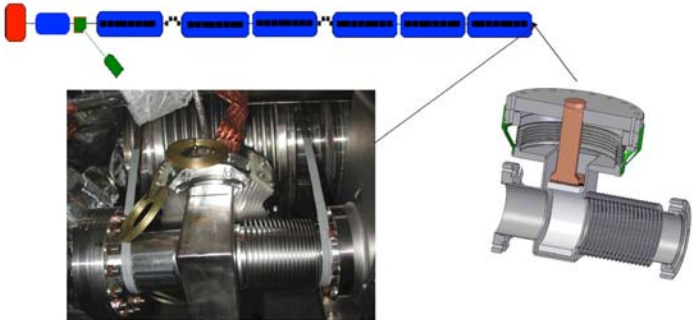

Computer modeling for the location of BLA should be absorbed in the BLA.

- **Very good results from HOM absorber studies**
- **Remarkable agreement between simulations and measurements**
- **Still to do: measurements at different bunch lengths**

Results from HOM absorber study

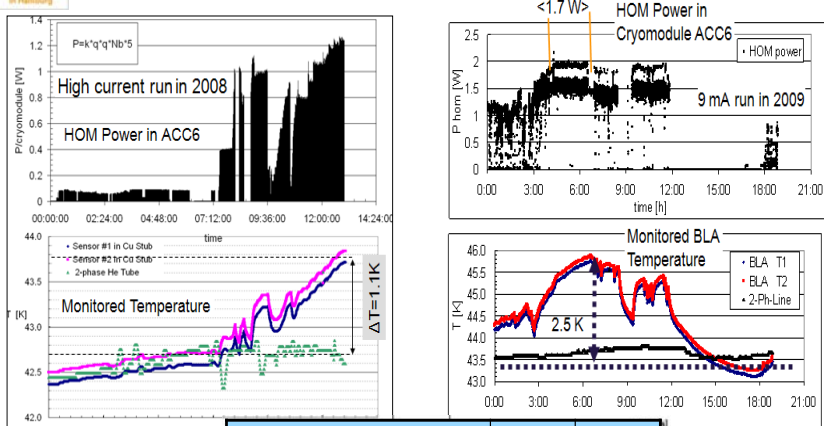

	Sept 08	Sept 09
Computed Absorbed Power [W]	0.180	0.255
Measured Absorbed Power [W]	0.143	0.325

J. Sekutowicz

Specific objectives for the 9mA study *(from 2008)*

“System Tests with ILC RDR beam parameters”

- **Long bunch-trains with high beam loading (9mA)**
 - 800 μ s pulse with 2400 bunches at 3MHz, 3nC per bunch
 - Vector Sum control of up to 24 cavities
 - +/- 0.1% energy stability
 - Cavity gradients approaching quench limits
 - Beam energy 700-1000MeV
 - HOM absorber studies (cryo-load)

Establish ILC-like operating conditions

- **Characterize operational limits**
 - Energy stability limitations and trade-offs
 - Cavity gradient overhead needed for LLRF control
 - Klystron power overhead needed for LLRF control
- **Operation close to limits, eg**
 - Robust automation of tuning, etc
 - Quench detection/recovery, exception handling
 - Beam-based adjustments/optimization

Studies under ILC-like operating conditions

Specific objectives for the 9mA study

(from 2008)

“System Tests with ILC RDR beam parameters”

- **Long bunch-trains with high beam loading (9mA)**
 - 800μs pulse with 2400 bunches at 3MHz, 3nC per bunch
 - Vector Sum control of up to 24 cavities
 - +/- 0.1% beam stability
 - Cavity gradient spread of +/- 20%
 - Beam-based control
 - HOM control

New since RDR: operate with gradient spread of +/-20% (!)

Establish ILC-like operating conditions

- **Characterize operational limits**
 - Energy stability limitations and trade-offs
 - Cavity gradient overhead needed for LLRF control
 - Klystron power overhead needed for LLRF control
- **Operation close to limits, eg**
 - Robust automation of tuning, etc
 - Quench detection/recovery, exception handling
 - Beam-based adjustments/optimization

Studies under ILC-like operating conditions

Main TDP R&D goal driving the 9mA studies in February 2011

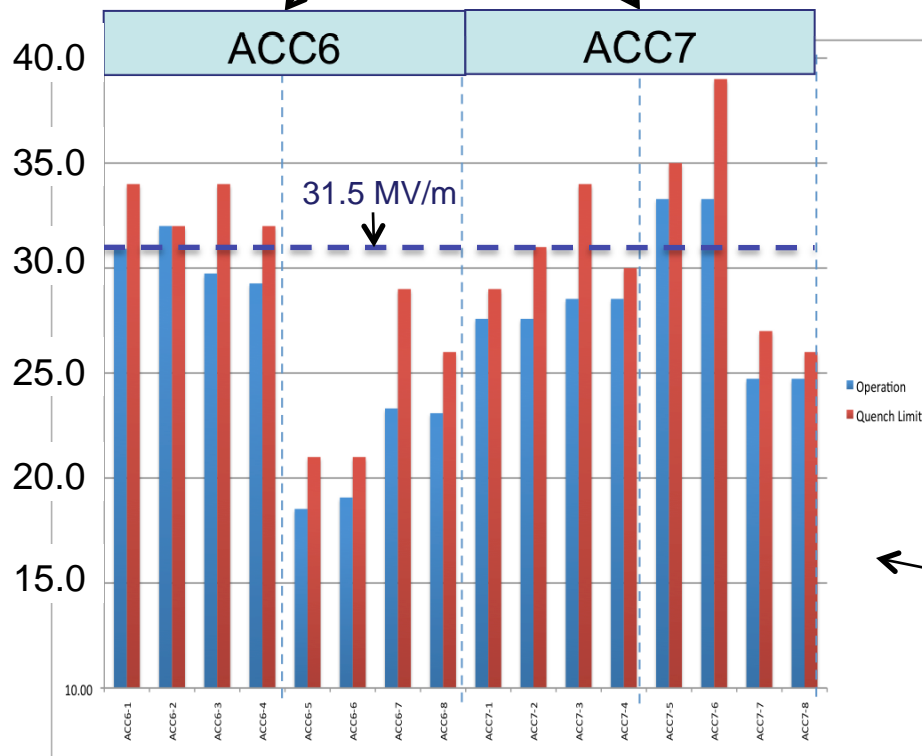
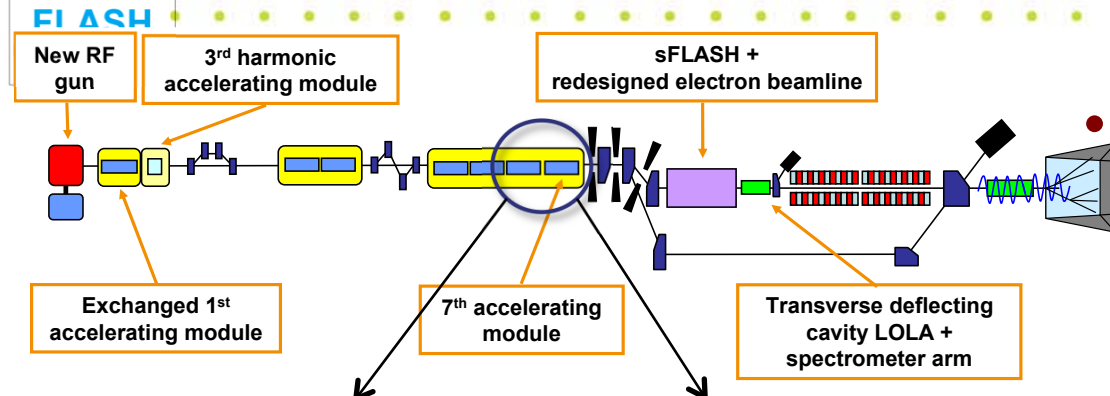

Operation with Gradient Spread

- From single RF source
- Specifically: achieving constant gradients for each individual cavity during beam pulse
 - to within few percent
 - close to gradient limits
 - 'Effective usable gradient'
- ACC67 modules at FLASH have operating gradient spread around +/-25%

Cavity gradient tilts from beam loading

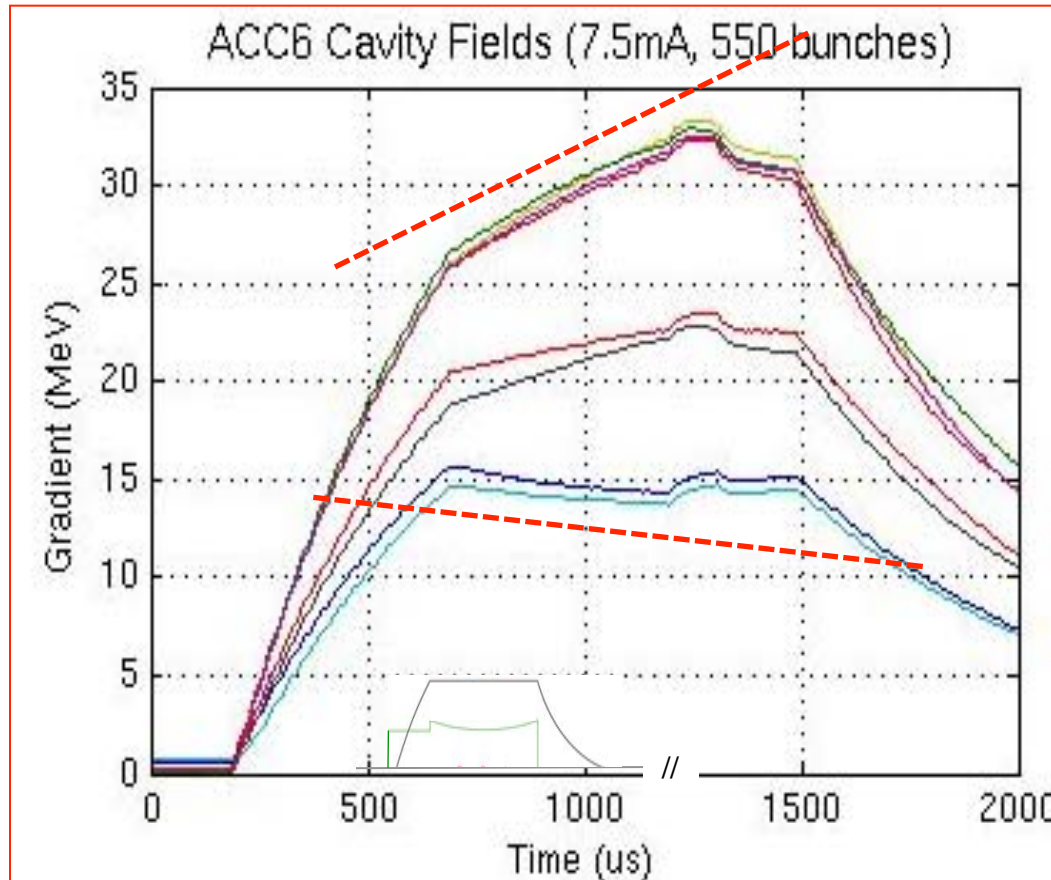

A 'feature' of running cavities with a spread of gradients from same RF source

Steady-state cavity voltage

$$V = \sqrt{P_{for} \left(\frac{r}{Q} \right) Q_{ext} - I_b \left(\frac{r}{Q} \right) Q_{ext}}$$

$$I_{matched} = \frac{V_k}{\left(\frac{r}{Q} \right) Q_{ext}}$$

Solution: adjust individual P_k s and Q_k s so each cavity is 'matched' to the same beam current

Flat gradient achieved at 360MV Vector Sum and beam current of 4.5mA (400us beam pulse)

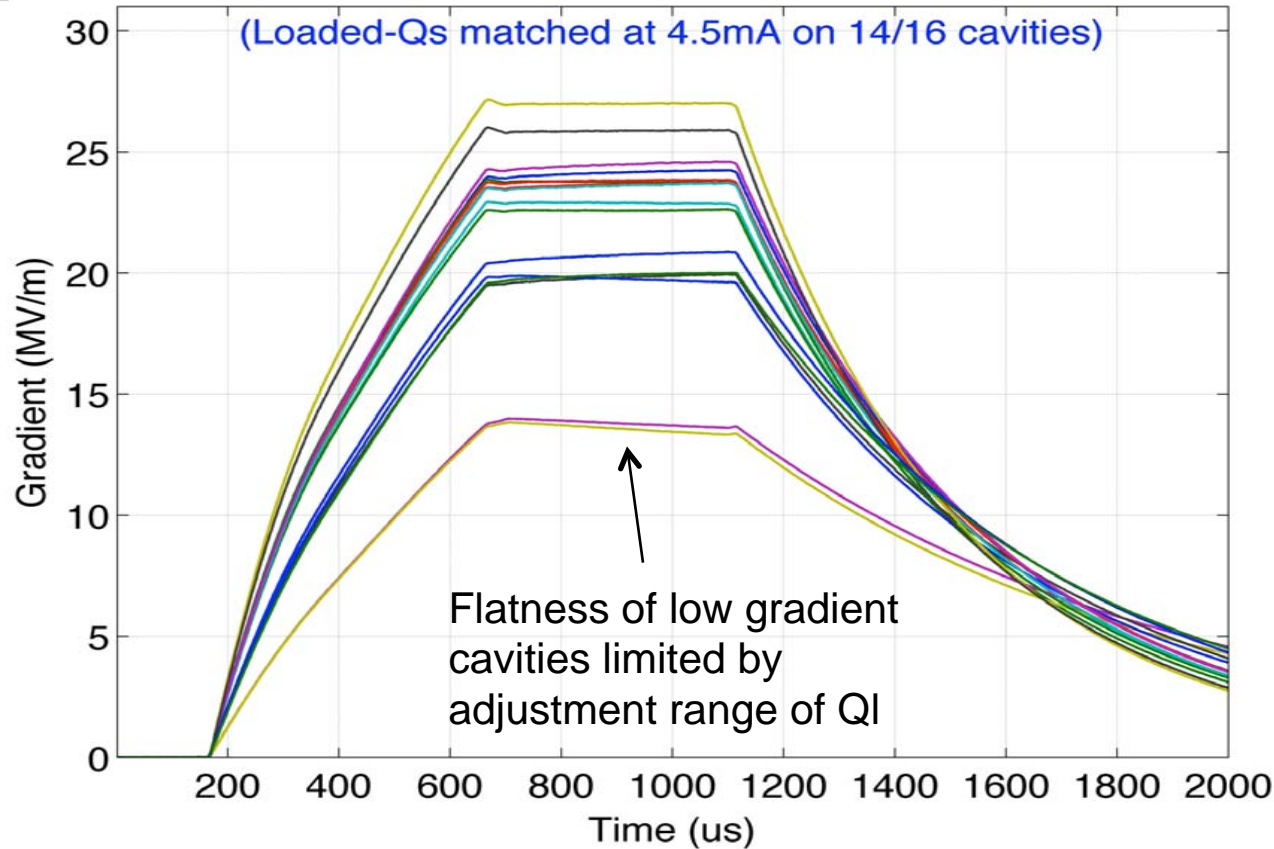

- **Proof of concept of 'Pk/QI' control was demonstrated during Feb 2011 studies**
- **Key part of study: piezo compensation of LFD**

Bounding sources of errors from beam current scans (Example of match at 3mA)

As the beam current is scanned, the tilt changes from negative to positive. At some current, the cavity tilt is zero

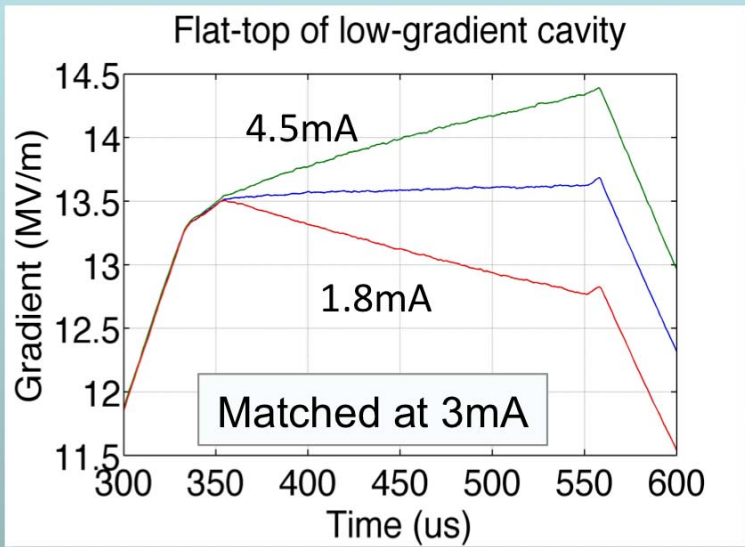

Should get insight into sources of error from the discrepancies in the currents where cavity gradient tilts were zero

Gradient Tilts vs Beam Current (ACC7)

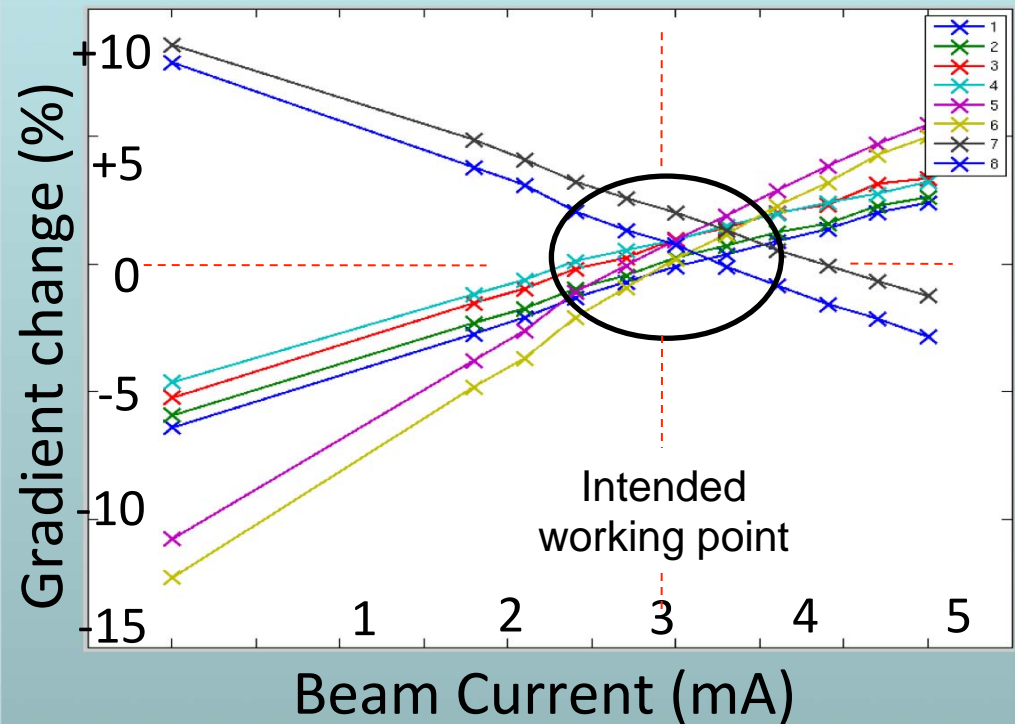



Beam scan examples

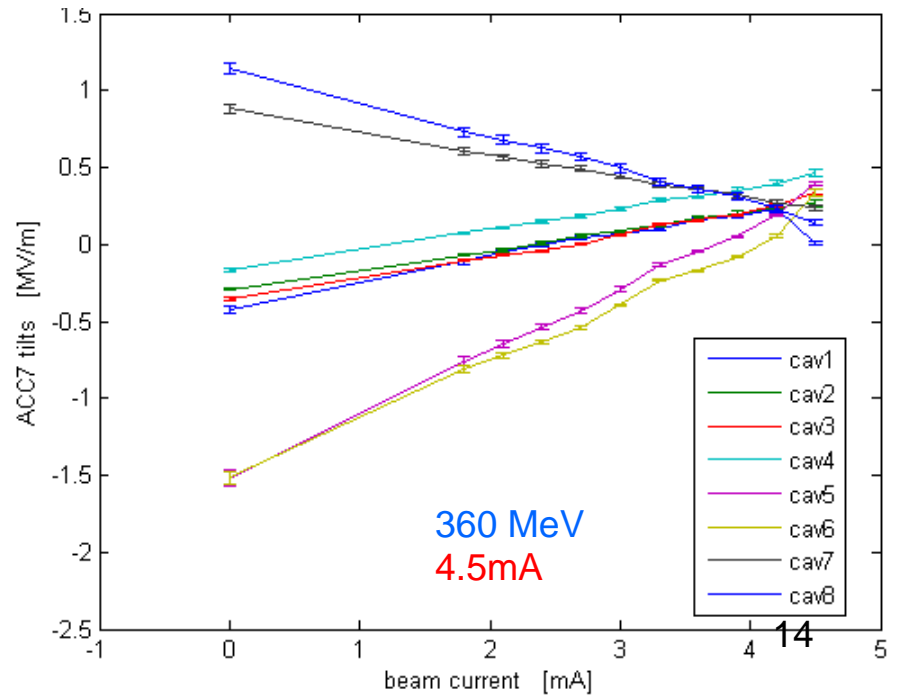
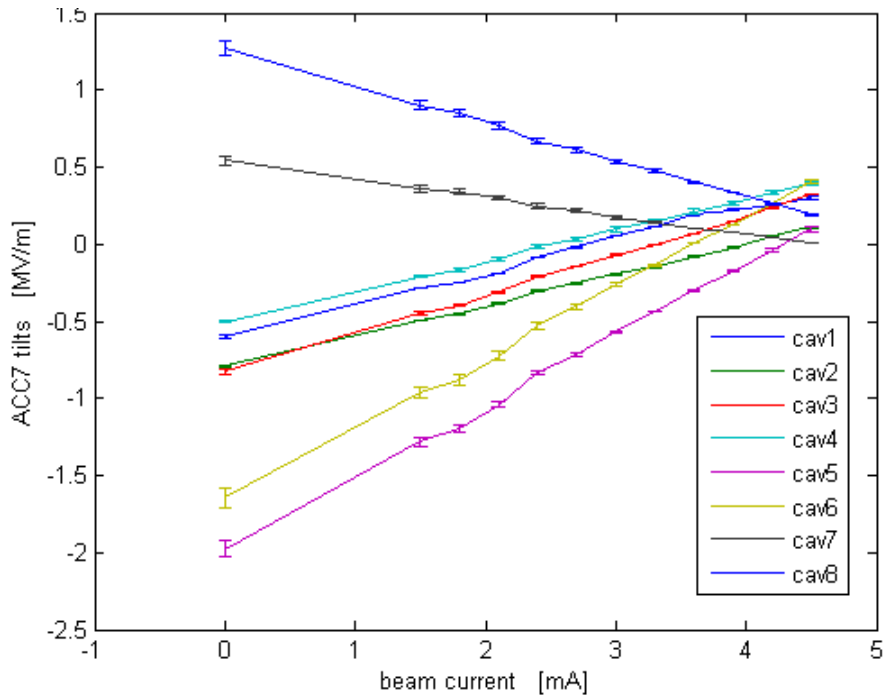
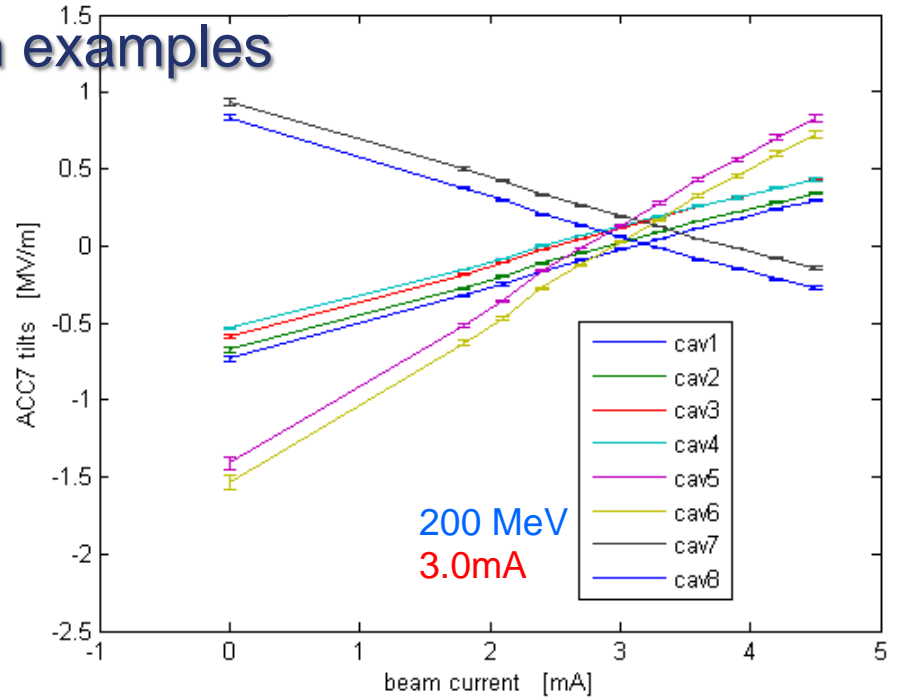
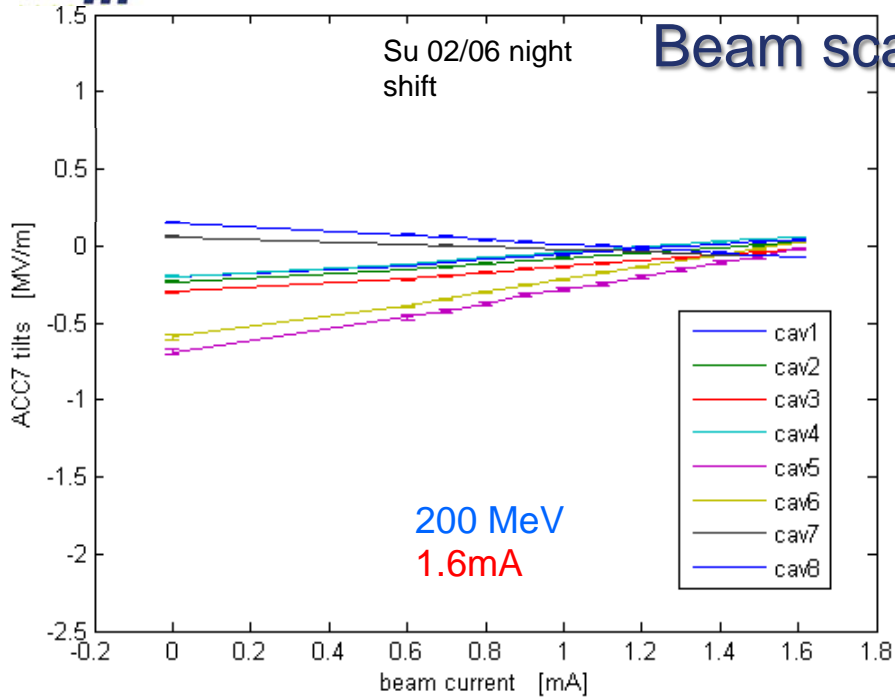

Achieved: flat cavity gradients to +/-few percent over a range of conditions

Matched current for 16 cavities	16-cavity Vector Sum	Approx. range of cavity gradients	Beam pulse length	RF flat-top length	Range for current scan
1.6mA	200MeV	7-24MV/m	400us	800us	0.6-1.6mA
3mA	200MeV	7-24MV/m	400us	800us	1.8-4.5mA
4.5mA	290MeV	10-20MV/m	400us	800us	1.5-4.5mA
4.2mA (14 of 16 cavities)	360MeV	17-27MV/m	400us	400us**	1.5-4.5mA

** RF flat-top length was reduced to prevent cavities quenching

- **QLs adjusted on ACC67 cavities to obtain flattest gradient profile over the duration of the bunch train**
- **Beam current scans used to evaluate the optimizations**

First-time demonstration of tailoring Pks/QLs to achieve flat gradients..?

9mA Experiment achievements to date

High beam power and long bunch-trains (Sept 2009)

Metric	ILC Goal	Achieved
• Macro-pulse current	9mA	9mA
• Bunches per pulse	2400 x 3nC (3MHz)	1800 x 3nC 2400 x 2nC
• Cavities operating at high gradients, close to quench	31.5MV/m +/-20%	4 cavities > 30MV/m

Gradient operating margins (Feb 2011)

Metric	ILC Goal	Achieved
• Cavity gradient flatness (all cavities in vector sum)	2% $\Delta V/V$ (800 μ s, 9mA)	2.5% $\Delta V/V$ (400 μ s, 4.5mA) "Methodology established"
• Gradient operating margin	All cavities operating within 3% of quench limits	(Focus of early 2012 run)
• Energy Stability	0.1% at 250GeV	<0.15% p-p (0.4ms, 4.5mA) <0.02% rms pulse-to-pulse

If we had to write the TDR today

- **Goal of stable operation with 9mA / 800us**
 - ‘Essentially done’
- **Goal of stable operation with +/-20% gradient spread and heavy beam loading**
 - ‘Very good first results, concept has been proven’
- **Goal of <0.1% energy stability with beam loading**
 - ‘Exceeds goal’
- **Still to be studied...**
 - Goal of operating close to quench
 - Goal of operating at limits of klystron output power

Key outstanding issue:
Beam operation close to gradient limits

What do we mean by operational gradient limit?



Selected terms (1):

Observed Gradient limit	The observed limit for steady superconducting operation in Vertical Low Power test, Horizontal test, cryomodule test and linac operation
Operational Gradient limit	Cavity should not be operated beyond this limiting voltage after installation in the linac; the limit may depend on duration/time
Cryomodule assembly Gradient limit change	The difference between the vertical test Observed Gradient limit and the cryomodule test Observed Gradient limit.
Matched Condition	Beam current and input power match – no reflected power
Gradient slope	Change in cavity voltage between the first bunch and the last bunch- typ P/P

Quenches during 800us RF pulses, no beam

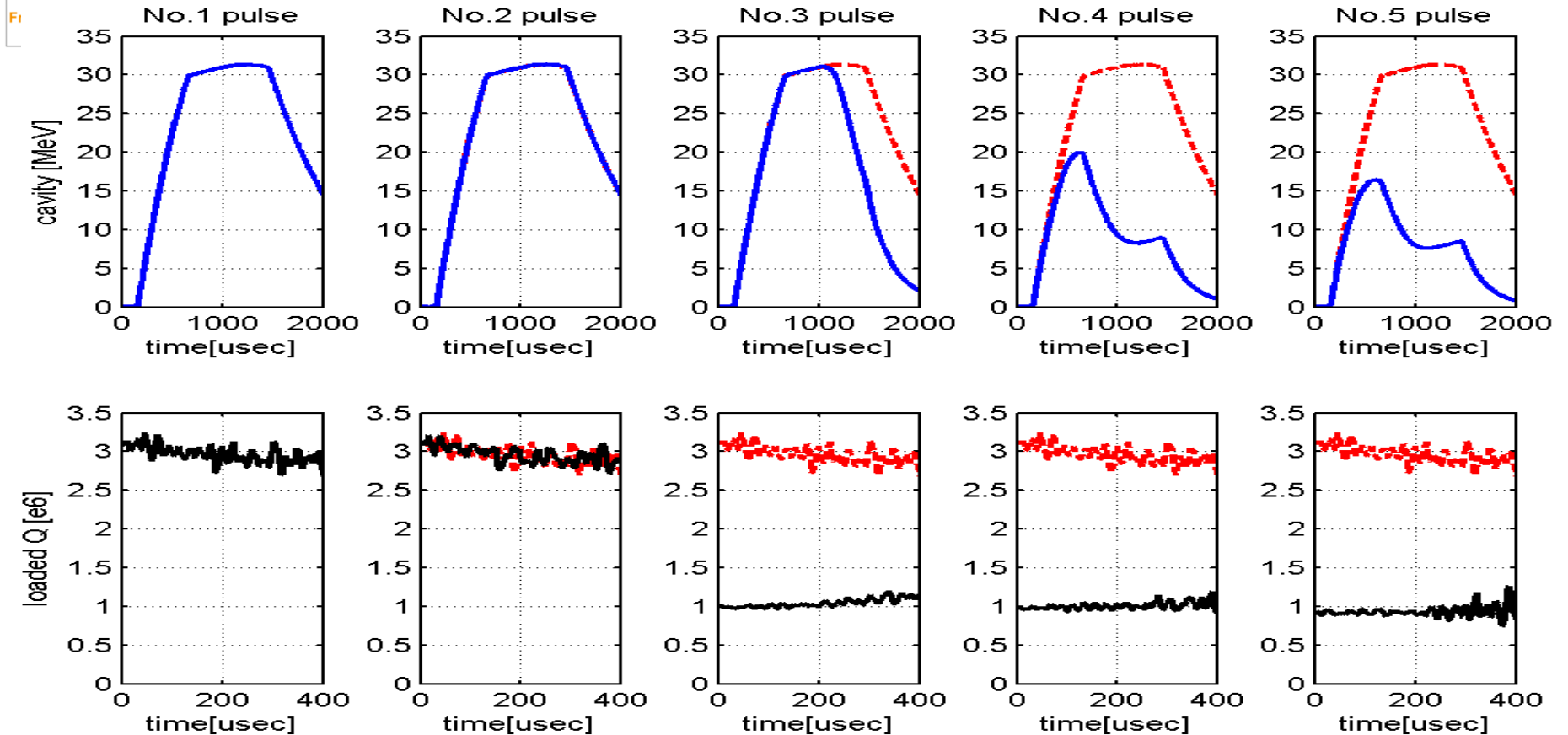

- At longer pulse (~800 us flattop), “quasi-quenches” were not observed.
- Once a quench took place, there was not a quick recovery, probably due to the larger energy deposited in the quenched area.

Other factors in assessing operational gradient limits

- **Operationally, three additional issues to take into account:**
 - Time-dependence of the onset of a quench: if a quench occurs 500us into a pulse, can we run at higher gradients with shorter pulses...?
 - Effect of Vector Sum control: the total voltage from module can be stabilized even during the onset of a quench
- ***How do these factors impact operational gradients...?***
- ***...to be studied***

Studying operational gradient limits at FLASH

Experimentally determined operational limits

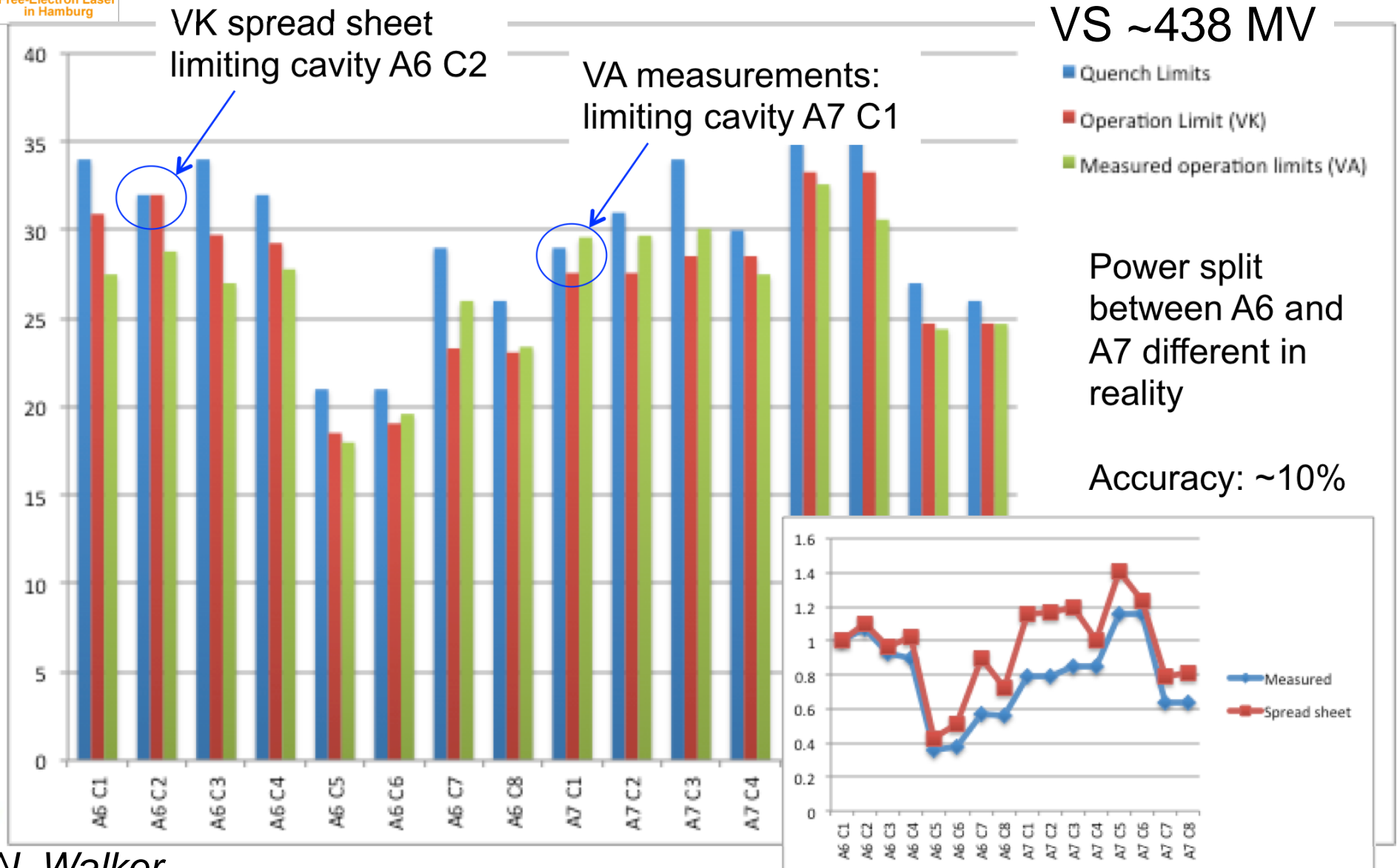

Flat Gradient Solutions (0.0 3.0 4.5 mA)

ACC6

ACC7

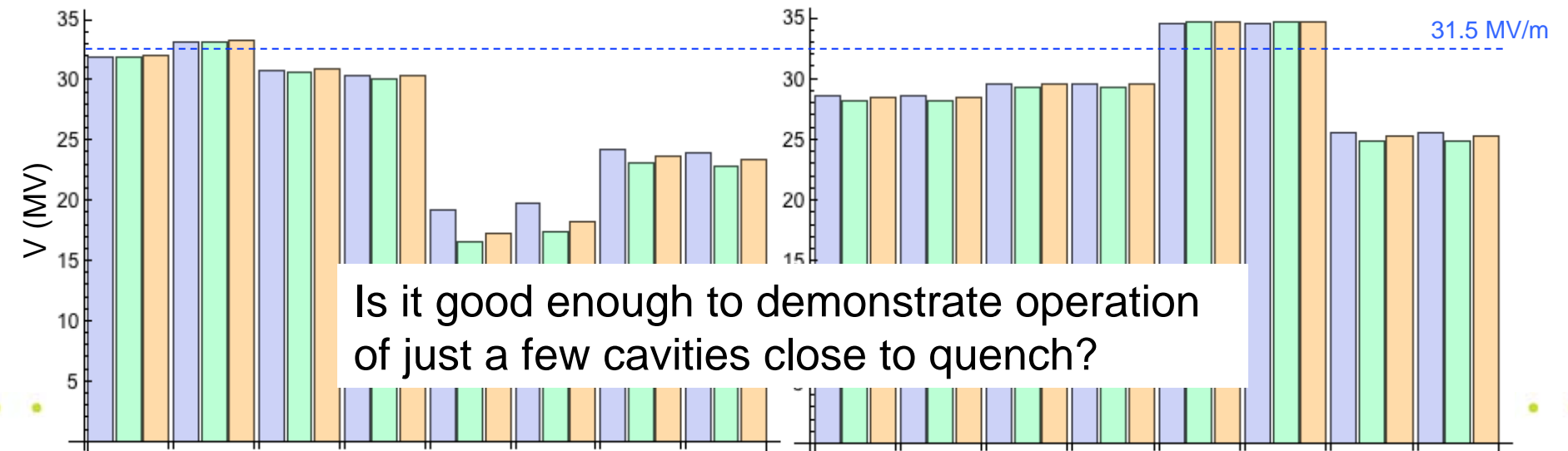
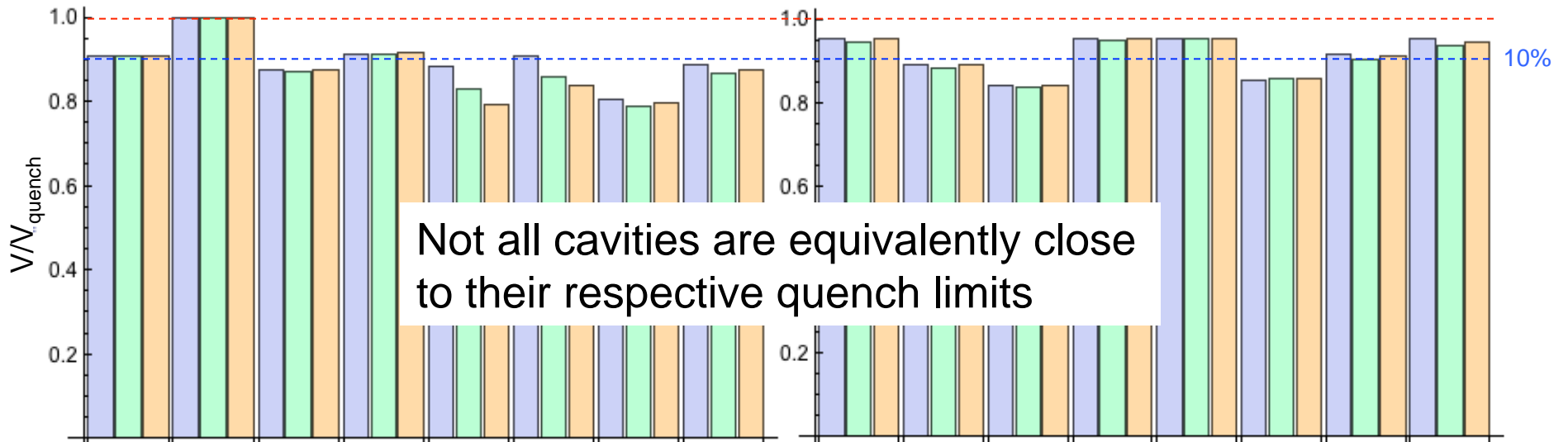

Limited range of Loaded-Q 'solution sets' to achieve flat gradients

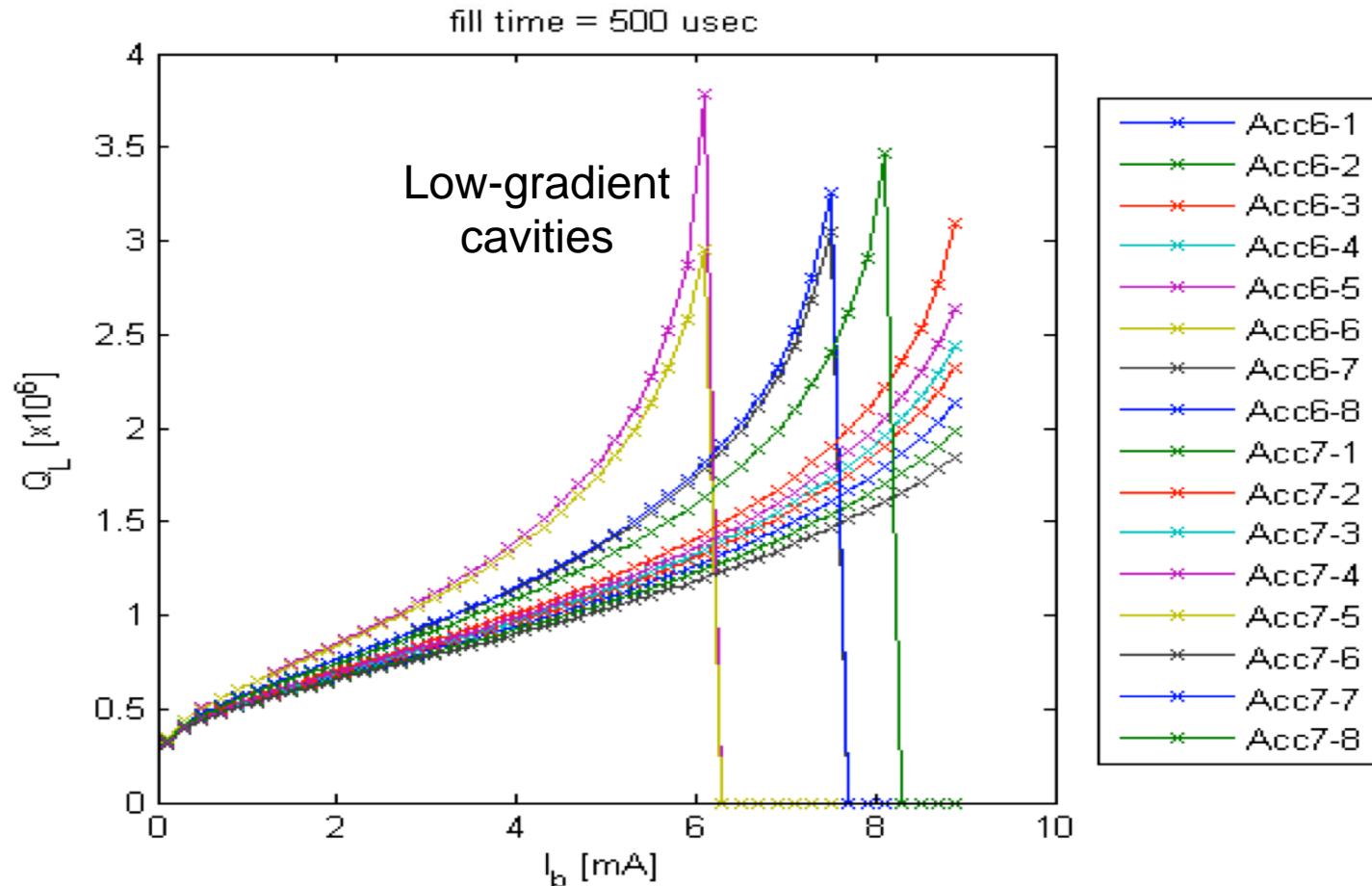

- Because of the wide gradient spread and fixed Pks, there are no 'flat-gradient' solutions above 6mA for all cavities

Feasibility of changing Pks? ACC7 Installation in FLASH tunnel

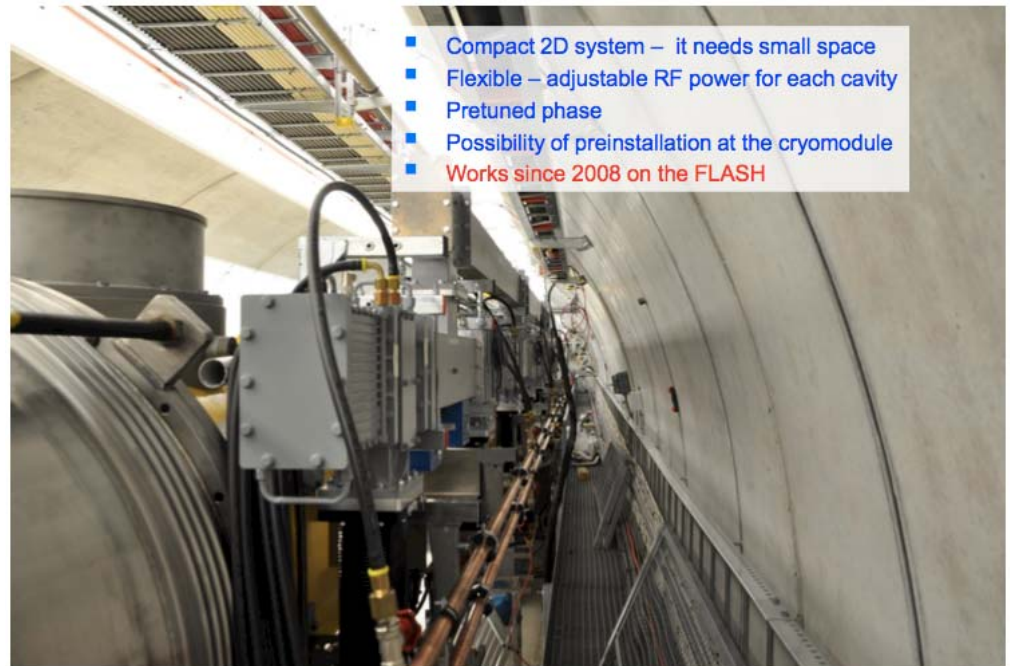

- Compact 2D system – it needs small space
- Flexible – adjustable RF power for each cavity
- Pretuned phase
- Possibility of preinstallation at the cryomodule
- Works since 2008 on the FLASH

In situ modification would be a challenge
(but not impossible.)

Option for addressing the limited solution space: Detune lowest gradient cavities

- Solution-space for flat gradients is limited in practice by range of adjustment of Loaded Qs
- If we had to demonstrate flat gradients at 9mA...
 - One option: detune lowest-gradient cavities

	16 cavities	14 cavities	12 cavities
Max gradient	32	32	32
Min gradient	18.5	23	24.7
Vector Sum	434	396	350
Avg. gradient	27	28	29
Gradient spread (%)	+18 / -32	+14 / -21%	+10 / -15%
Max current with flat-gradient solutions	4.5mA	6mA	9mA

The bootstrapping issue:
Getting to full current and full gradient
without quenching

Beam ON/OFF (800us RF flat-top, 400us bunch-train)

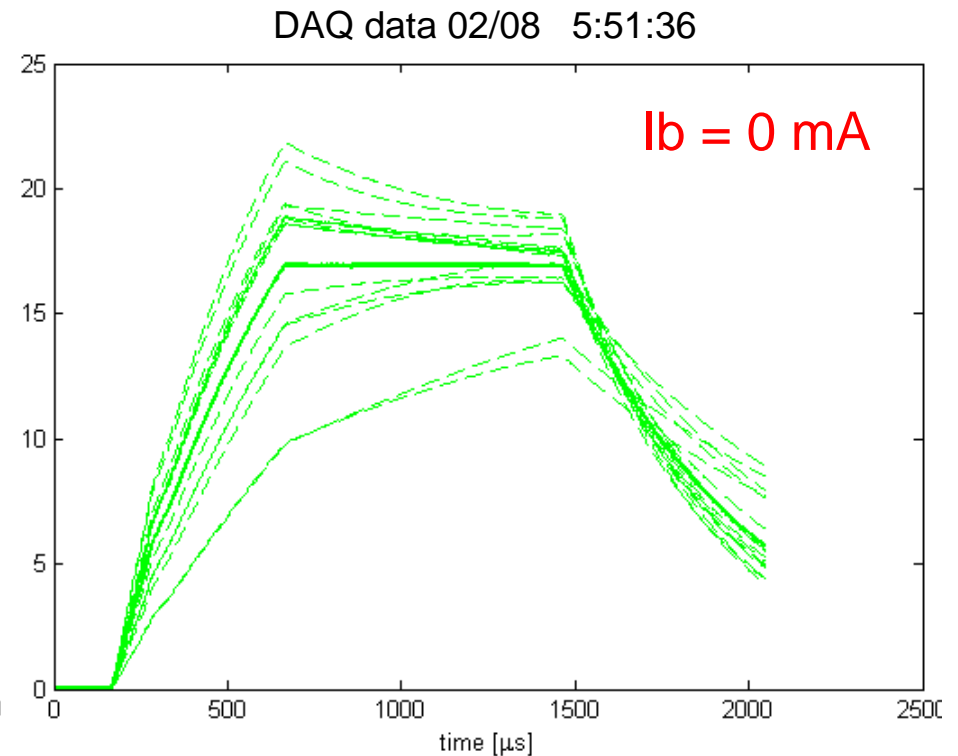
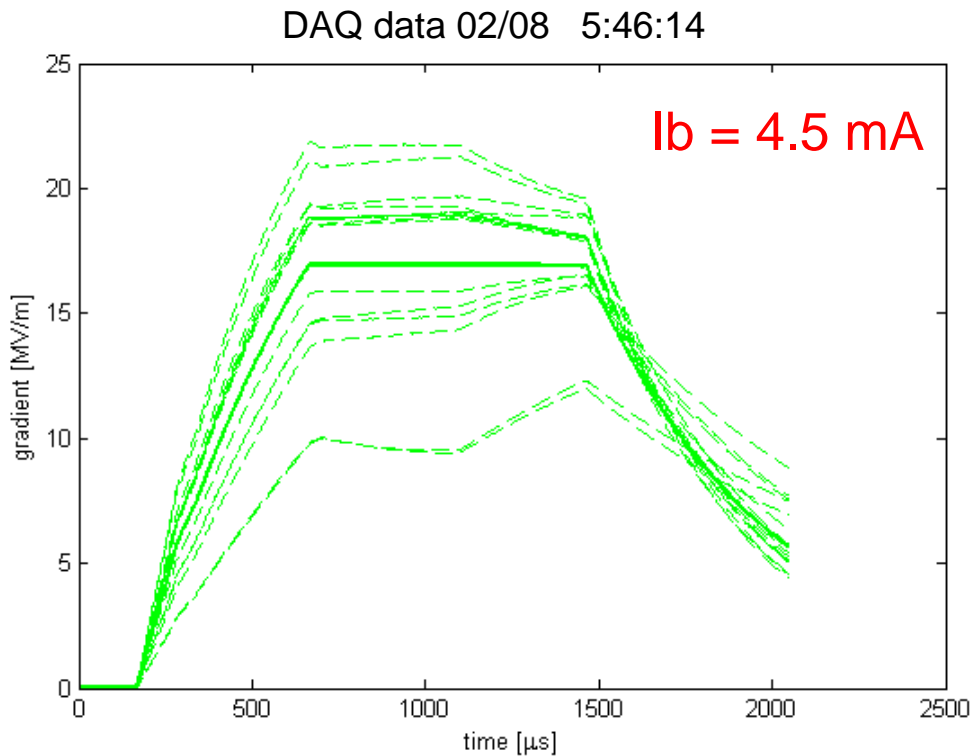

- Cavities **below** vector sum **rise** without beam
- Cavities **above** vector sum **drop** without beam
- Need for an **automatic** safety feature **to shorten RF pulse** to prevent quench

Bringing up a linac

Traditional approach (i.e. FLASH)

1. Make target gradient with FF
2. Turn FB on
3. Compensate for LFD
4. Send a couple of pilot bunches (~10)
(automated beam loading compensation)
5. Minimize losses
6. Gradually increase bunch length to full train
(while minimizing beam losses)
7. Learning feed forward

One “possible” scenario for flat gradients

1. Bring cavity to their nominal gradient
 - typically: quench gradient -2-3 MV/m
2. Adjust Q_L so cavities are flat with beam
 - cavity will quench (because no beam)
3. Shorten pulse length to avoid quench
 - typically <200 usec for high beam currents Q_L 's
 - can't see LFD effects (can't compensate for LFD)
 - can't walk pilot bunch across flat top
4. As you increase bunch length
 - increase flat top length
 - compensate for LFD
 - minimize losses
5. The LLRF quench monitoring system should
 - truncate the flat top length to prevent quenches
 - every time bunch train is shorter than expected

Other options?

Proposal - adjust detuning of low gradient cavities to reduce forward power ('pseudo Pk knob')

- **Detuning cavities by 180 Hz.**

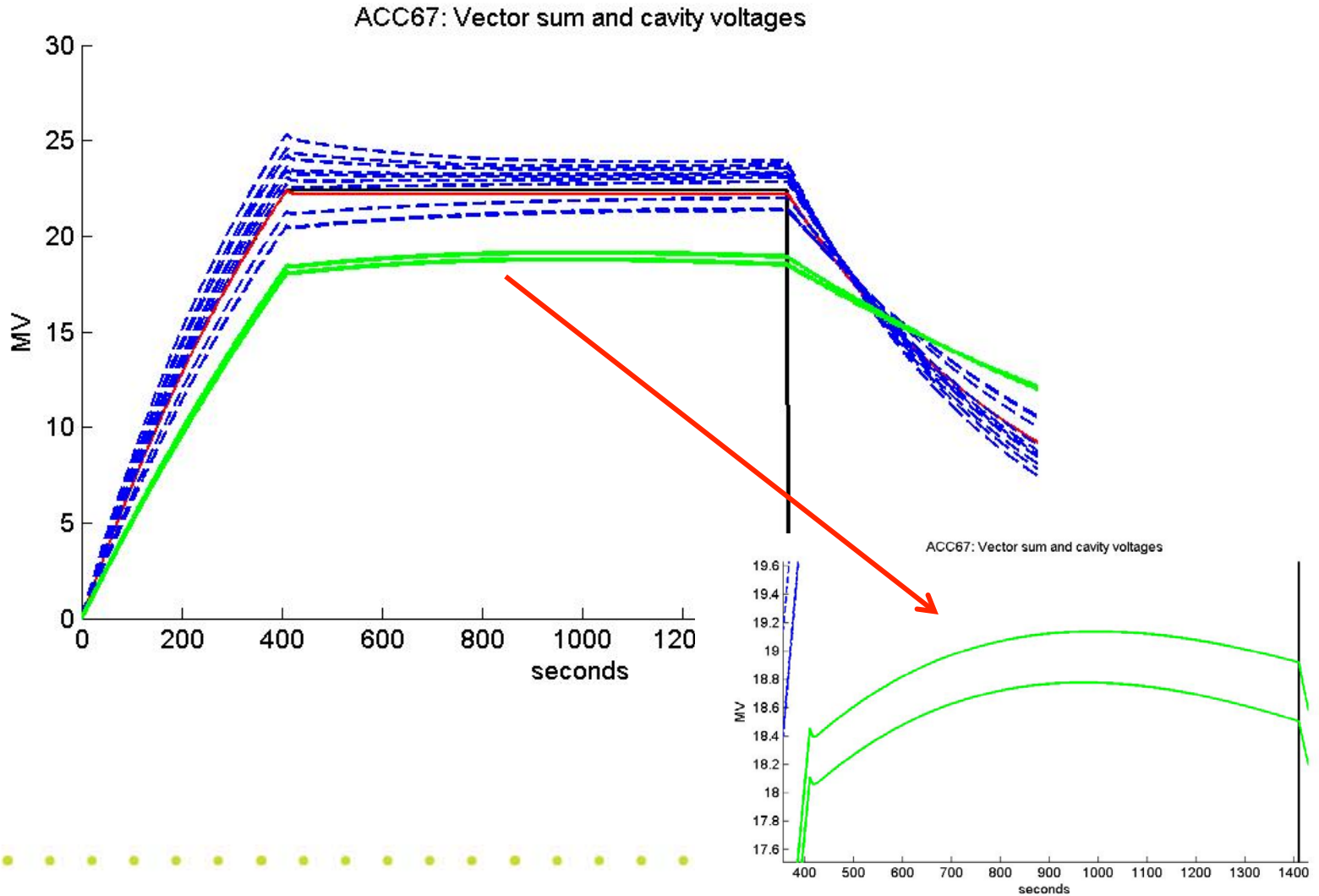

Extrapolating to ILC parameters

To answer in the TDR: how have we done with respect to the goals for 9mA Experiment

- **The goal is to achieve all criteria simultaneously ‘as written’**
 - i.e. stable operation with 9mA/800us, energy stability of <0.1%, a 20% spread in gradients, all cavities operating close to quench, and klystrons operating close to saturation
- **Unlikely we will achieve this by the end of 2012**
 - Will have achieved some of the criteria but not all at the same time
 - Other criteria may have been only partially achieved
- **To extrapolate, we must look at what changes when going to the full criteria and then understand the impact**

Simulators – expand to add random errors, systematics, etc

- **Valuable information about systematics and sensitivities could come from simulations**
- **But the simulators need to take into account more of the practical issues, eg**
 - Effects of random errors / differences from cavity to cavity, eg
 - Random deltas in detuning from cavity to cavity
 - Random differences in LFD coeffs and resonances
 - Measurement errors and noise (calibration)
 - Finite resolution / hysteresis in setting Loaded-Qs
 - Beam current variations
 - Realistic quenches (quenches are treated as go/no-go thresholds, rather than taking into account the time for a quench to develop)

Extrapolation to full parameters from studies data: Musings...to be explored, elaborated

- **If we want to emulate 9mA running at 4.5mA, does this mean that running within 3% of quench at 9mA translates to running within 1.5% of quench at 4.5mA?**
 - Or at least that we can control the tilts twice as well
- **The 'bootstrap' issue of getting from zero beam loading to full beam loading at full gradient without quenching**
 - Will get harder as we go up in gradient and current
- **If we run a few cavities within few percent of quench have we effectively shown it can be done for all cavities?**
 - Ideally would be cavities at the gradient extremes...

- **Should be in good shape with respect to TD Phase Goals**
- **One or two blocks of studies in 2012 (for ‘filling the gaps’)**
 - Almost certainly we will not have reached operation with every one of the criteria being met at the same time
 - Develop a risk register of key TDP issues requiring beam studies
 - Any gaps remaining at the end of 2012 will be addressed for the TDR through simulations and extrapolation of results
- **The urgent-most items for studies blocks in 2012**
 1. Establish a ‘boot-strapping’ methodology for high gradient operation
 2. Operation close to quench with progressively higher beam loading
 3. Operation with different bunch lengths for absorber studies
- **The System Tests program will continue beyond 2012**

Thank you for your attention