

Status of the ILD simulation models

Frank Gaede, DESY

ILDMeeting 2012

Fukuoka, Japan, May 23-25, 2012

Mokka developments since LOI

- major rewrite of some sub detector drivers :
 - SIT, SET, ETD - FTD - Muon
 - increased level of detail and realism (incl. services)
- made existing drivers more realistic:
 - TPC, AHCAL, Ecal, FCal,...
- new drivers (technology options):
 - SDHCAL, SciEcal
- added overall services and cables
- new models for DBD:

ILD_O1_v03 "ILD simulation reference Model for DBD using Analog HCal"

ILD_O2_v03 "ILD simulation reference Model for DBD using SD HCal"

ILD_O3_v03 "ILD simulation reference Model for DBD using SciW Ecal and Analog HCal"

- first part **ILD_OX** - read "ILD - Option X", refers to the choice of sub-detector technology options of the model
- second part **_vXX** refers to the software release version that describes this option for ILD

increased realism in ILD_OX models

- added cabling and services for TPC, ECal & Hcal (C.Clerc, G.Musat)
- including inner detector services as defined by R&D groups

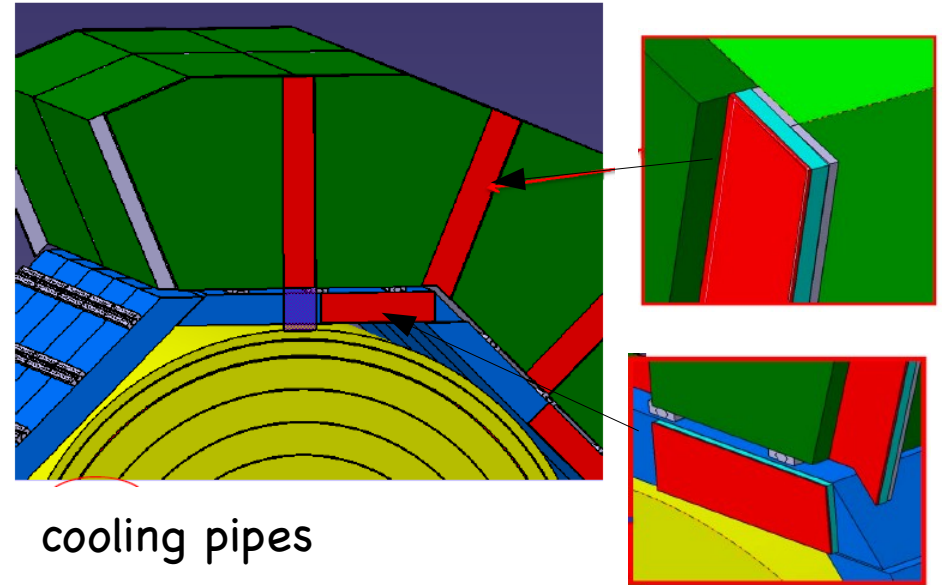
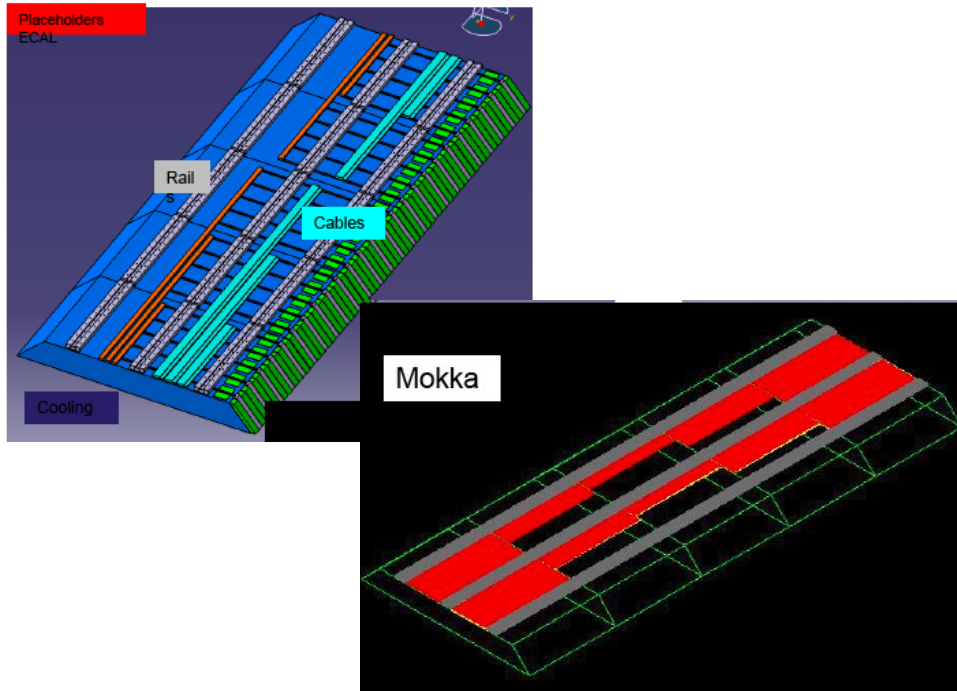

big step forward in increasing realism of ILD detector simulation !

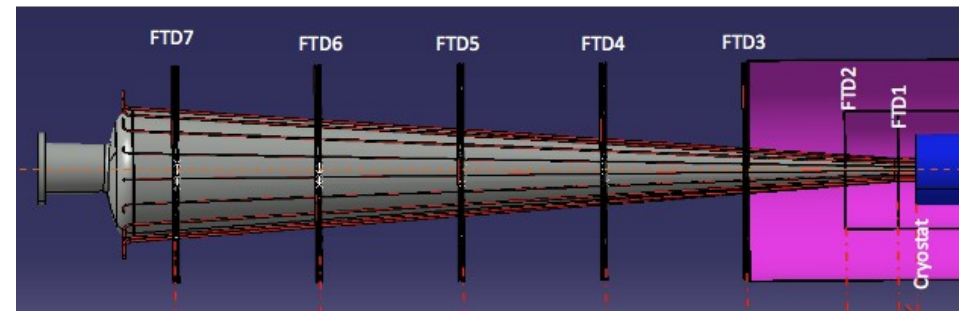

power supply cables

validation of Mokka ILD model(s)

- started validation process with volunteers nominated by the subdetector R&D groups, checking the Mokka drivers for:
 - overlaps, consistency w/ engineering model, hit production,..

detector	person
VXD	G.Voutsinas
SIT/SET	K.Androsov
FTD	J.Duarte
TPC	S.Aplin
ECal	D.Jeans
AHCal	Sh.Lu
SDHcal	G.Grenier
FCal	A.Rosca, B.Pawlik
Muon	V.Saveliev

start MC production, once all sub detectors are 'approved'

overall overlap checking: Ch.Grefe

VXD validation

Y.Voutsinas

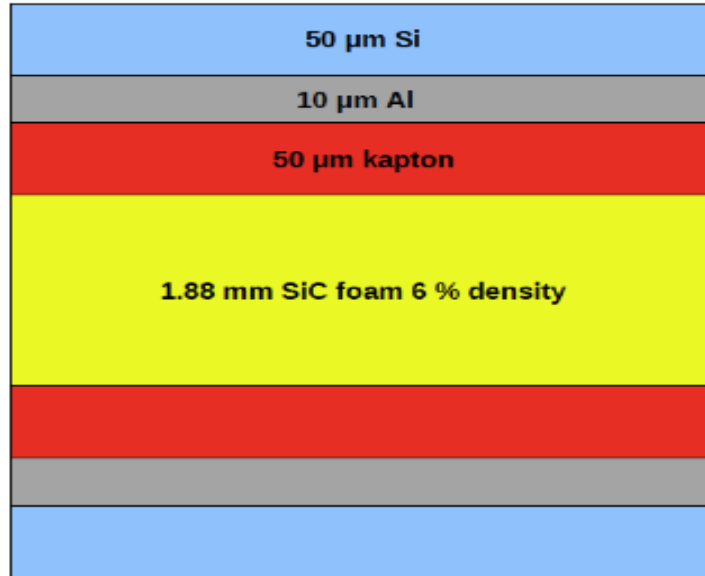

- 0.053 % x 2 +
- 0.011 % x 2 +
- 0.018 % x 2 +

- 0.130 % =

-
- 0.294 % X_0 per double layer

simplified in GEAR:
0.2% X_0 support
+ 0.1% X_0 sensitive
= 0.3% X_0 total

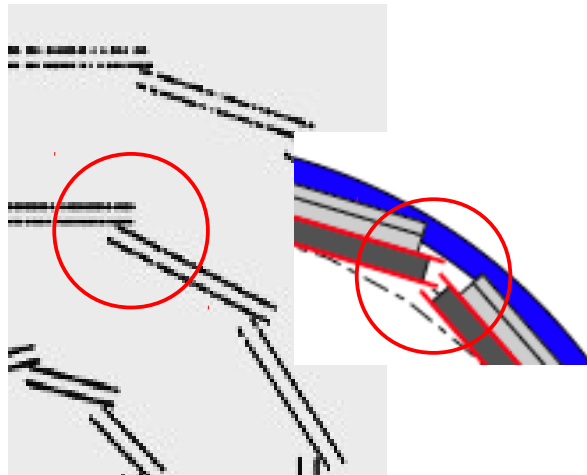

- inconsistency in geometry detected
- potential impact on track finding

=> fixed by Yorgos
=> VXD is validated

SIT/SET & FTD

K. Androsof, J. Duarte

- very detailed new simulation models had been developed for SIT/SET as well as for the FTD (ETD is not in simulation models)
- these models did not quite reach the level of maturity one would need for the DBD mass production
- slightly simplified have been developed in parallel in order to proceed with new C++ tracking code
- these models have planar wafers, ~realistic support material and work with new tracking
- have now been validated by R&D groups

=>SIT/SET validated
=> FTD validated

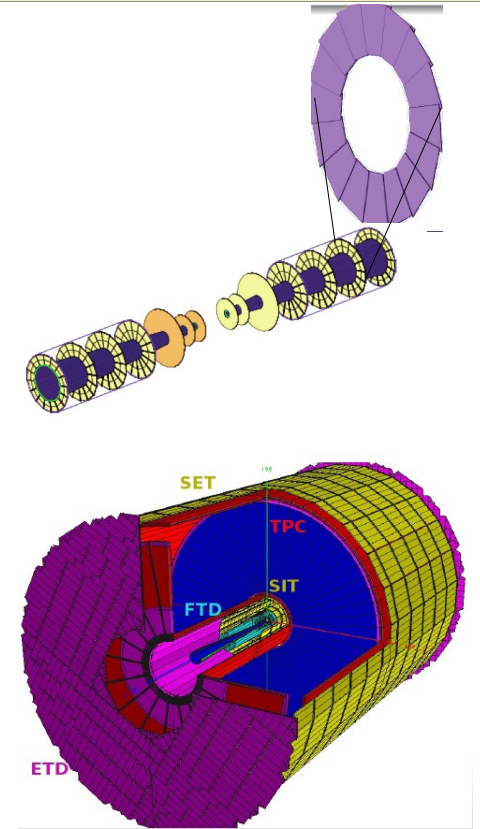

routing of SIT/FTD cables

SIT, two solutions

1. Along the beampipe : they have to run on backside of FTD2 and 3 , then :
 - huge amount of material around BP
 - Material in front of the other FTD
2. Run along the inner radius of TPC

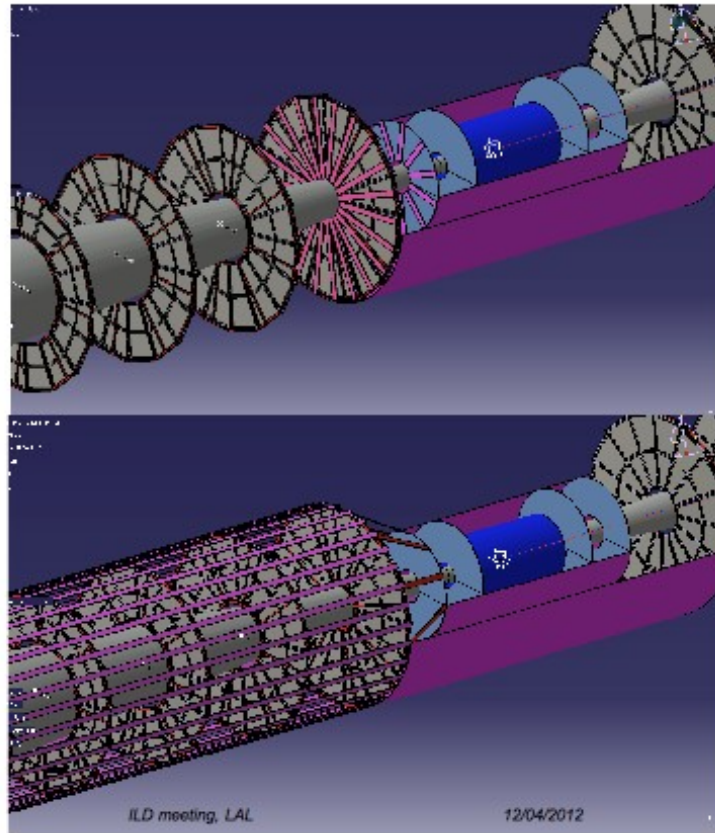

- less cables due to new powering scheme

- question of routing:
 1) along beam pipe !?
 (cables going out to SIT/SET missing ?)
 2) just inside TPC field cage
 => currently 2) in ILD_OX

ERC

C.Clerc

ILD meeting, LAL

12/04/2012

	Aluminum								
	position	FTD7	FTD6	FTD5	FTD4	FTD3	FTD 2	FTD 1	VTX
new values	eq Th of Al	0,85	0,99	1,22	1,54	2,18	2,76	2,00	0,67
	X0% FCPPD	0,95%	1,11%	1,37%	1,73%	2,45%	3,10%	2,25%	0,75%
old values	eq Th of Al	2,16	2,39	2,74	3,20	4,12	3,45	2,00	0,67
	X0% FCPPD	2,43%	2,68%	3,08%	3,60%	4,63%	3,87%	2,25%	0,75%

TPC validation

S.Aplin

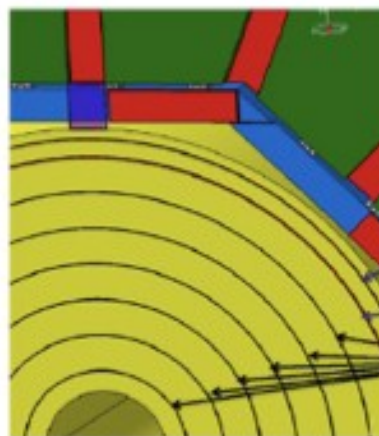
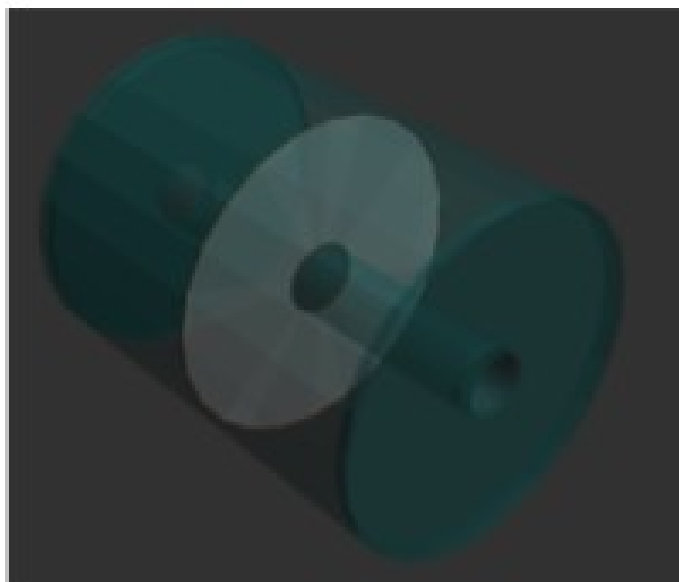

rings of equivalent thickness
in copper

Liquid supply ring $7 \times 2.7 \text{ mm}^2$

Vapor return ring $10 \times 2.8 \text{ mm}^2$

6 Cooling tubes $4 \times 1.9 \text{ mm}^2$

End-Plate modeled as discs of material representing components of the readout: GEM structure, Readout, and Support frame.

Cathode constructed from two thin discs, insulator and conductor, held by membrane grip.

Cooling modeled using rings attached to the outside of the end-plate.

Parameterised digitisation well established in the main reconstruction chain.

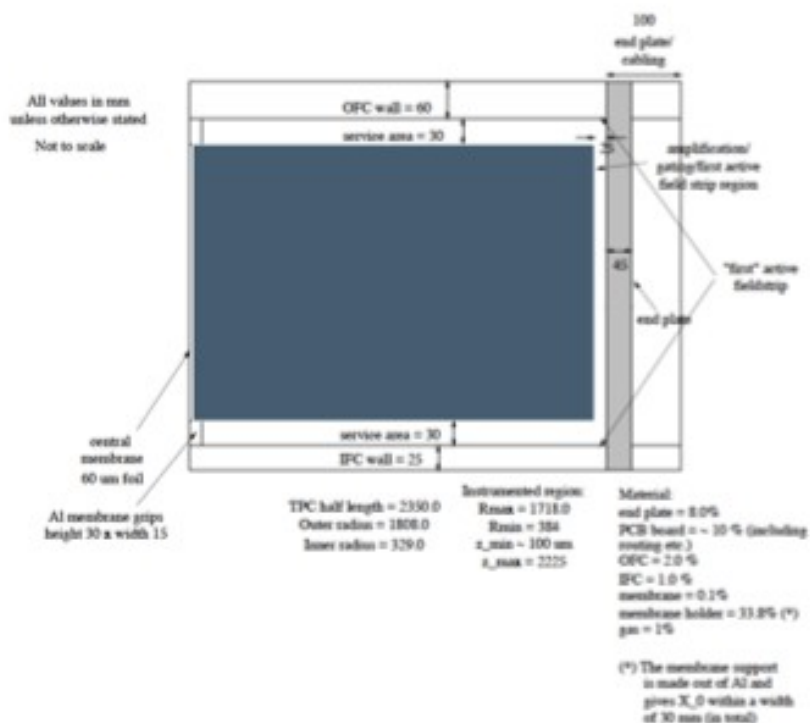

=> TPC is validated

SiW Ecal validation

D.Jeans

Engineering design dimensions:

Barrel: Rin=1843, Rout=2028, 1/2 length=2350

Endcap: Rin = 400 (square), Rout=2090 (octagon), Zin=2450, Zout=2635

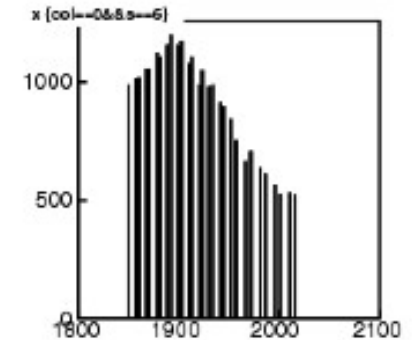
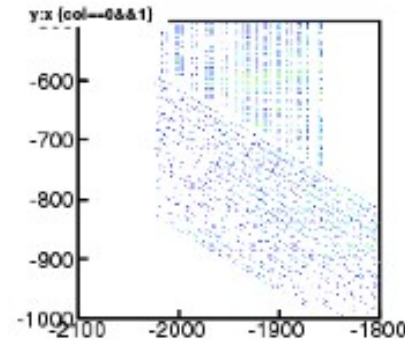
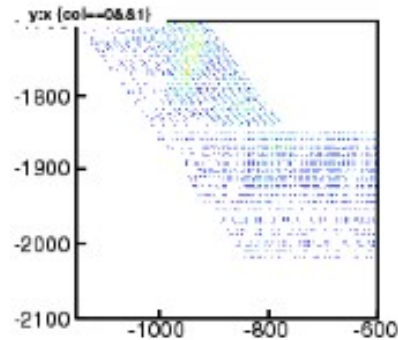
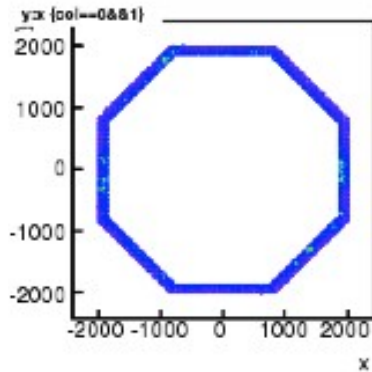

Step	Leng	NextVolume
	0	WorldPhysical
	3	BarrelEcalModule
	2.45	FirstSlab
	0.25	PCBCuShield
pcb	1.3	FirstSlab
	0.1	WaferSi
si	0.5	Ground
	0.1	BarrelEcalModule
cf	0.15	RadiatorSlab
w	2.1	BarrelEcalModule
cf	0.15	Ground
	0.1	WaferSi
si	0.5	SecondSlab
	0.1	PCBCuShield
pcb	1.3	SecondSlab
	0.25	BarrelEcalModule
cf	0.75	RadiatorStruct
w	2.1	BarrelEcalModule
cf	0.75	FirstSlab
	0.25	PCBCuShield
pcb	1.3	FirstSlab
	0.1	WaferSi

Conclusions

Hit positions consistent with engineering design

Decoded CellID behave as expected

No problems detected in ECAL structure (geantino)

=> Ecal is validated !

AHcal validation

Sh.Lu

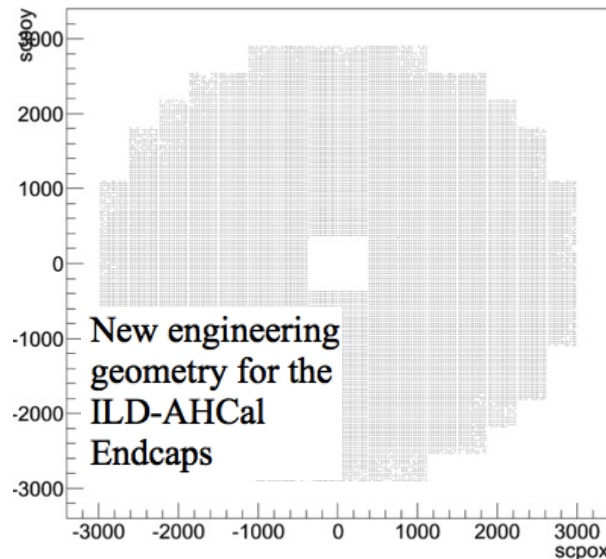
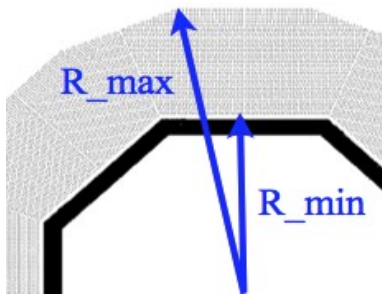
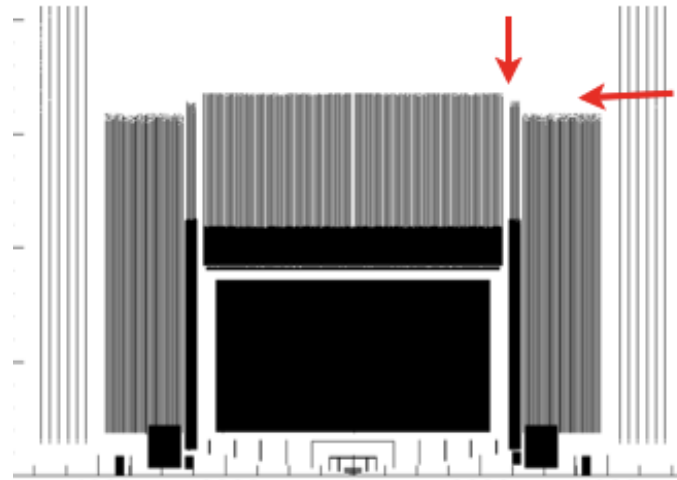
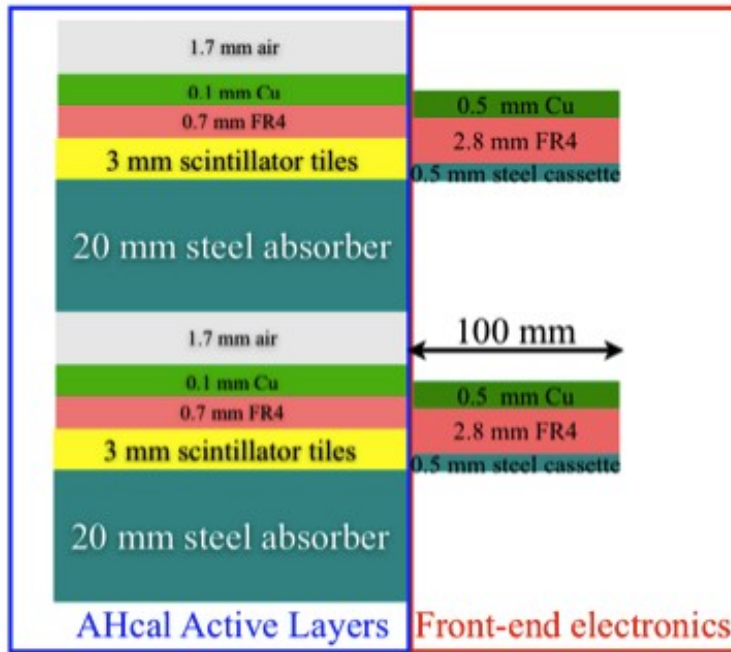

The Mokka drivers for the **Barrel** and the **Endcap** have been validated and synchronized with engineering design.
EndcapRing has been checked with engineering design too.

=> AHCal is validated

Fcal validation

A.Rodca, B.Pawlik

Simulation

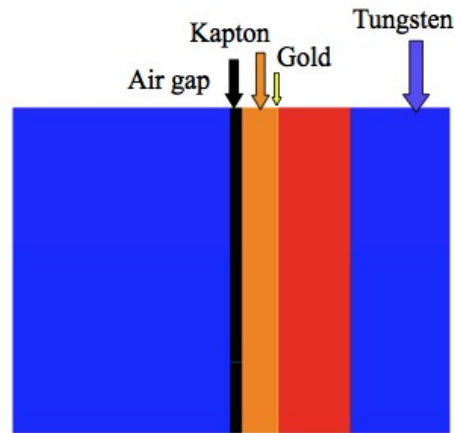
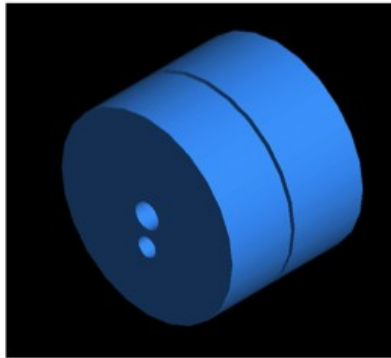

Geometry has been checked for overlaps
– No overlap found.

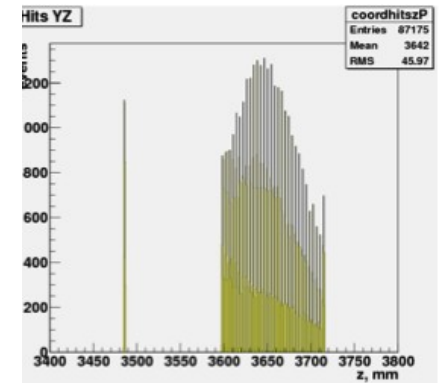
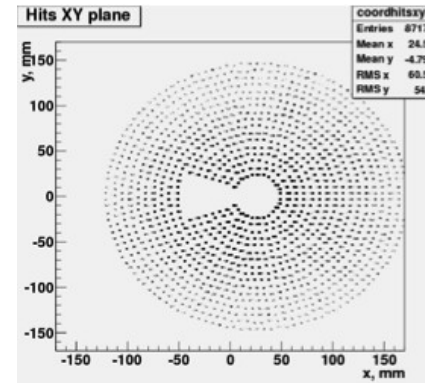

$Z_{in} = 3450$ mm in the engineering design and ~ 3600 mm in the simulation.

Implemented Geometry (according to official RD)

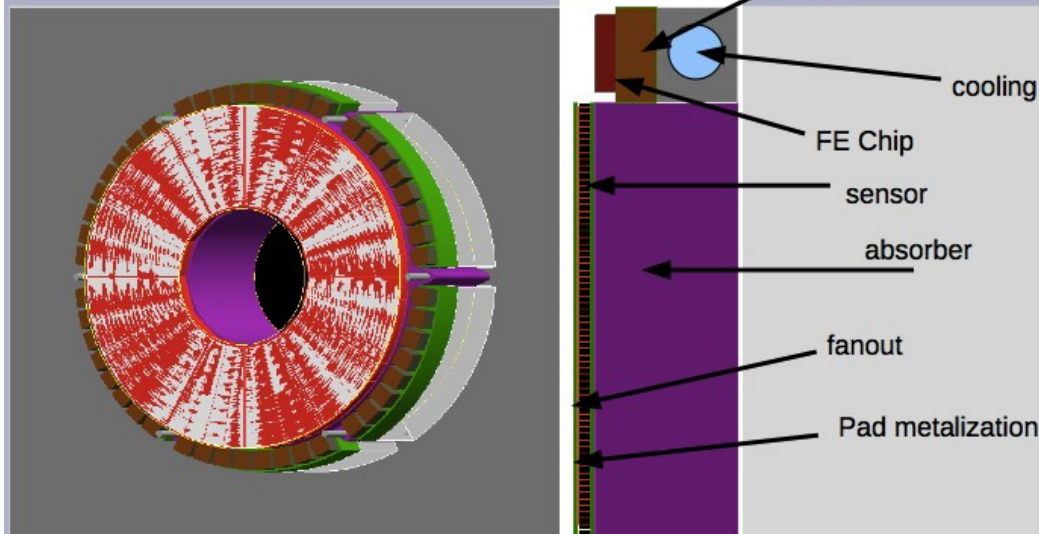

→ sorted out:
different z-pos was just
an optional proposal
⇒ simulation & engineering
models are in synch

⇒ BCal validated
⇒ LCal validated

Muon validation

V.Saveliev

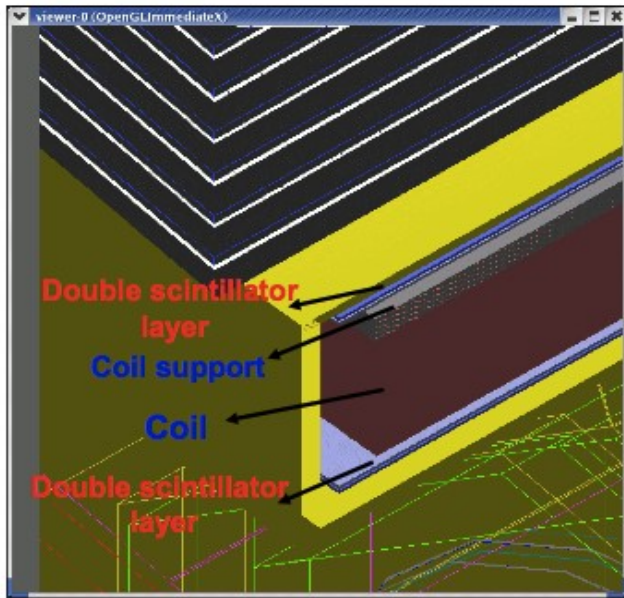

Cryostat: Detailed Geometry

- Instrumentation 2 Double Scintillator Layers

Coil: Detailed Geometry,

- Coil Segmentation

Yoke: Detailed Geometry based on Mechanical Design

- Barrel: $10 \times (100+40) + 3 \times (560+40)$ mm

- EndCup: $10 \times (100+40) + 2 \times (560+40)$ mm

-> no baseline
-> keep in simulation model
don't use in reconstruction !

various readout options exist

- 3x3cm scint. tiles ← used in LOI & Pandora implemented in ILD_OX
- issue w/ amplitude of hits !?
- 3xLcm scint. strip stereo ← proposed

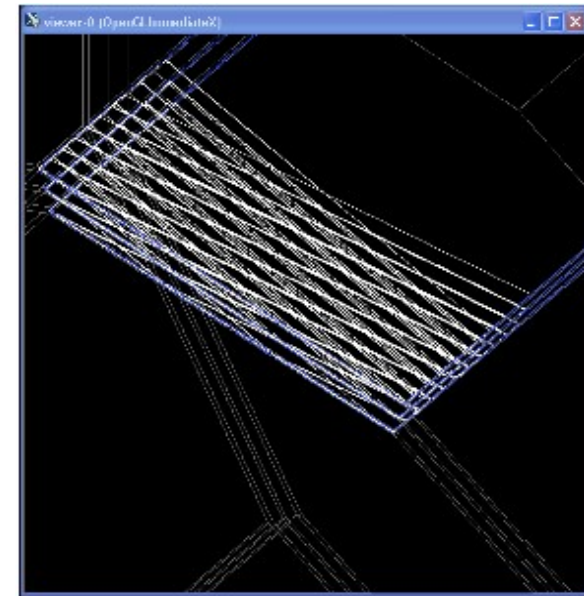

=> muon validation to be finalized soon

Overall Overlap checking

Ch.Grefe

/geometry/test/recursive_test

Gives detailed printout with coordinates of overlaps:

```
GeomTest Error: Overlapping daughter volumes
The volumes tube_IPOuterBulge[0] and tube_IPOuterBulge[0],
both daughters of volume WorldPhysical[0],
appear to overlap at the following point in global coordinates:
length (cm) ----- start position (cm) ----- end position (cm) -----
16.45      0      0      37.13      0      0      53.58
Which in the mother coordinate system is:
length (cm) ----- start position (cm) ----- end position (cm) -----
16.45      0      0      37.13      0      0      53.58
Which in the coordinate system of tube_IPOuterBulge[0] is:
length (cm) ----- start position (cm) ----- end position (cm) -----
16.45      0      0      -1.16      0      0      15.29
Which in the coordinate system of tube_IPOuterBulge[0] is:
length (cm) ----- start position (cm) ----- end position (cm) -----
16.45      0      0      -21.91      0      0      -5.46
```

Careful: can be false positives / false negatives
Still the best starting point

- World volume too small – **fixed**
- SIT overlaps with FTD – **fixed**
- Overlapping sensors in SIT and SET – **fixed**
- Overlaps in FTD – **fixed**
- Insulators overlap in TPCCathode (**fixed**)
- Overlaps in tube_IPinnerTube (**fixed**)
- Overlaps in tube_IPOuterBulge (**fixed**)
- YokeEndcap overlaps YokePlug – **fixed**
- Overlaps in HCalServices – **fixed**
- Chamber1 and Chamber2 overshoot YokeEndcap

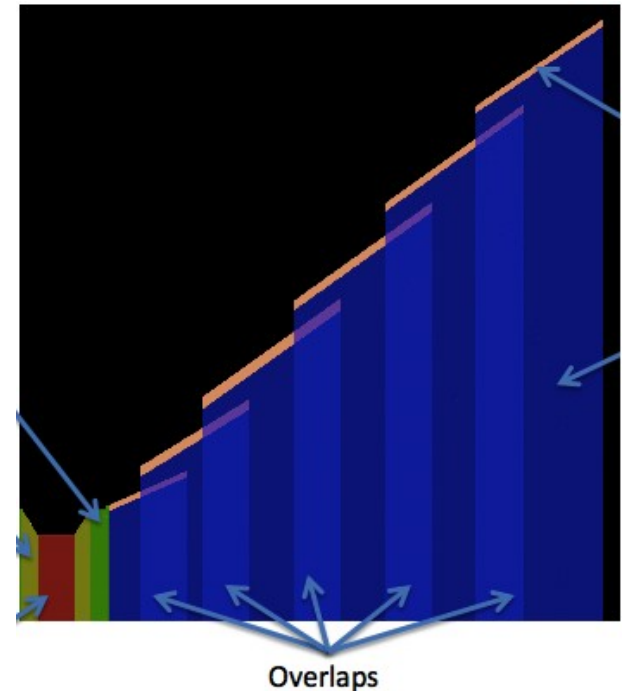

=> ILD_O1_v03 should be free of overlaps

validation of Mokka ILD model(s)

- started validation process with volunteers nominated by the subdetector R&D groups, checking the Mokka drivers for:
 - overlaps, consistency w/ engineering model, hit production,..

detector	person	status
VXD	G.Voutsinas	done
SIT/SET	K.Androsov	done
FTD	J.Duarte	done
TPC	S.Aplin	done
ECal	D.Jeans	done
AHCal	Sh.Lu	done
SDHcal	G.Grenier	to be done
FCal	A.Rosca, B.Pawlik	done
Muon	V.Saveliev	ongoing

start MC production w/
ILD_O1_vxx a.s.a.p.
- finalize muon readout
- finalize SIT cabling
- ... ?

overall overlap checking: Ch.Grefe

Summary & Outlook

- ILD simulation models in Mokka have been made **more realistic** wrt. to the version that was used for the LOI:
 - added electronics, cabling and services
 - introduced wavers and support for Si-Tracking
 - R&D groups have nominated people to **validate the corresponding drivers -> almost complete now**
 - **now known (major) discrepancy known between the simulation and the engineering models**
- will start Monte Carlo production for DBD very soon