



**Beam commission plan for  
the IPBPM system with  
reference cavities after  
October run**

Siwon Jang (KNU)



# Contents



- **New IP-BPM system**
  - 11cm low-Q IP-BPM
  - The electronics for IP-BPMs
  - Phase shifter with software
  - The reference cavity BPM for low-Q IP-BPM
  
- **Oct. beam commissioning of IP-BPM system**
  - Installation of IP-BPM system with alignment check
  - Phase shifter check with I-Q tuning
  - ADC system check
  - Basic beam test to check the resolution of IP-BPMs
  
- **Future beam commissioning plan of IP-BPMs**
  - IP-BPM resolution check with oscilloscope
  - IP-BPM resolution check with ADC
  
- **Summary**

# New IP-BPM system



## Contents

- 11cm low-Q IP-BPM
- The electronics for IP-BPMs
- Phase shifter with software
- The reference cavity BPM for low-Q IP-BPM



# 11cm Low-Q IP-BPM made by Aluminum

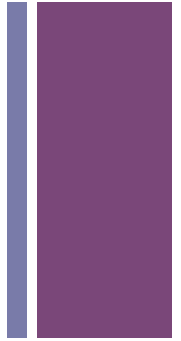

## ■ Motivation of 11cm Low-Q IP-BPM design

- More shorter decay time ~ 20ns
- More lighter BPM weight.
- Single BPM correspond to 1kg with 11cm x 11cm cavity size.

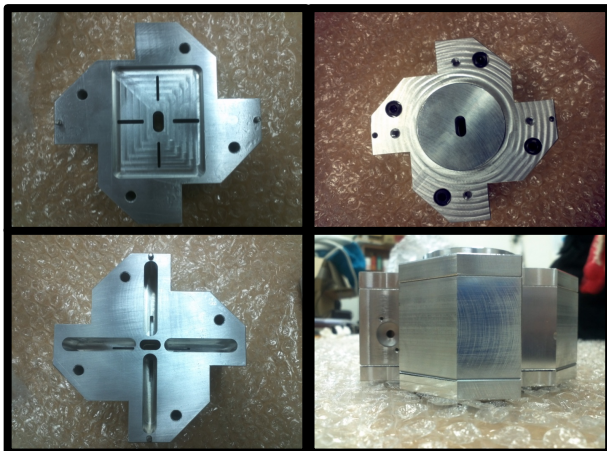
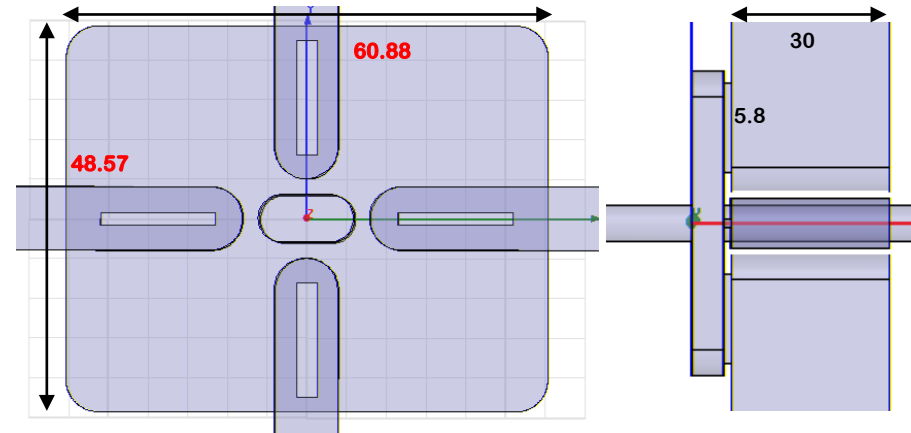

	Port	$f_0$ (GHz)	$\beta$	$Q_0$	$Q_{ext}$	$Q_L$	T (ns)	$V_{out}$ ( $\mu V/2nm$ )
Designed	X-port	5.713	5.6	4959	872	741	18.7	7.739
	Y-port	6.428	5.6	4670	821	698	17.2	7.448



# The electronics for IP-BPMs

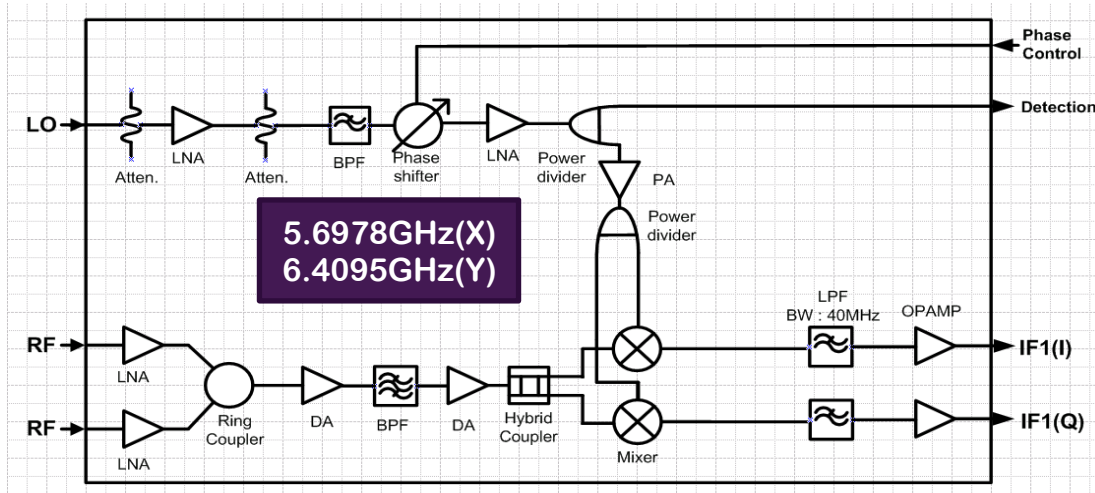

Simplified schematic of the IP-BPM signal processing electronics.

	New electronics
<b>BW of LPF</b>	<b>40MHz</b>
<b>Gain</b>	<b>54~44dB</b>
<b>Thermal Noise</b>	<b>-96.1dBm</b>
<b>Estimated Resolution due to thermal noise</b>	<b>2nm</b>
<b>Cascaded NF</b>	<b>1.88dB</b>
<b>RF P<sub>1in</sub>dB</b>	<b>-22dB</b>
<b>Estimated Latency</b>	<b>25ns</b>

- Conversion Gain : 54~44dB(X,Y)
- Variable OPAMP: 10dB
- BW of LPF : 40MHz
- Cascaded N.F : 1.88dB
- ▶ Remote phase shifter: 0 ~ 360 degree
- ▶ Estimated position resolution : 2nm
- ▶ Estimated Latency : 25ns

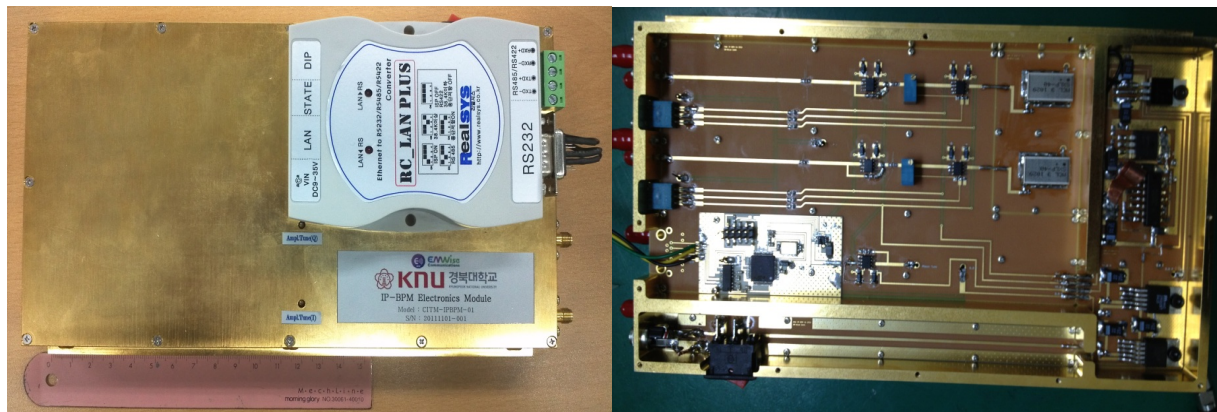



# Phase shifter with remote control software

- The phase shifter was connected to RC LAN plus to control due to digital signal. The LO signal phase was controlled from 0 degree to more than 360 degree.
- The control program software will be changed to run on the Linux system. (Now, Windows software)

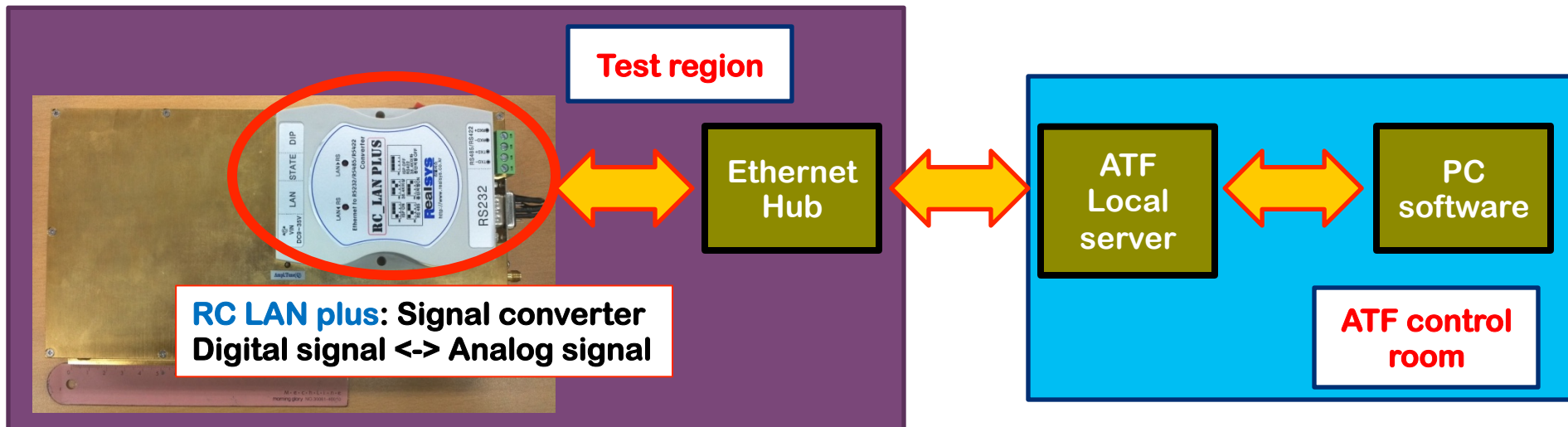



# Reference cavity BPM design

## ■ Cavity shape for HFSS simulation

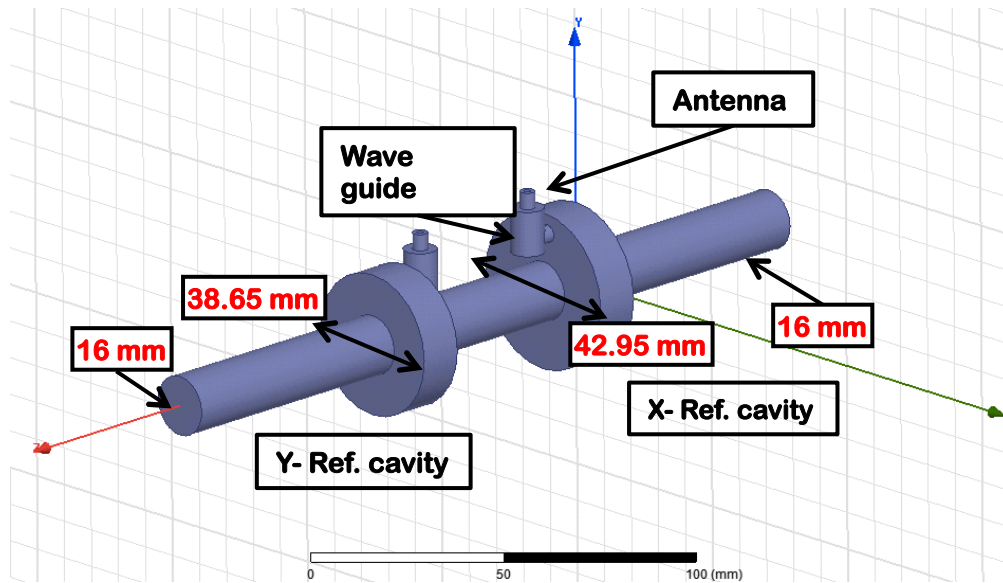

- Cavity size :  
42.95mm, 38.65mm
- Beam Pipe radius:  
**8 mm (circular pipe)**
- Material of BPM:  
**Stainless steel (SUS304)**

Output signal strength  
= **22 ~ 5dB** (1.6nC ~ 0.32nC)  
This output strength too strong  
to connect LO input. So, we  
add 20dB attenuator.

Port	$f_0$ (GHz)	Aim $f_0$	$\beta$	$Q_0$	$Q_{ext}$	$Q_L$	$\tau$ (ns)
X-port	5.7107	<b>5.6978</b>	0.00964	1201.20	124578	1189.73	33.157
Y-port	6.4148	<b>6.4095</b>	0.01528	1228.83	80421.2	1210.34	30.029



# Reference cavity BPM design



DN  
DWG  
KNU-RCB-0000

REV	DRN	CKD	DATE	REVISION & DESCRIPTION

Finally, the resonance frequency tuned with 3Mhz for both x and y direction.

Y-port:  $6.4095 \pm 3\text{MHz}$   
 X-port:  $5.6978 \pm 3\text{MHz}$

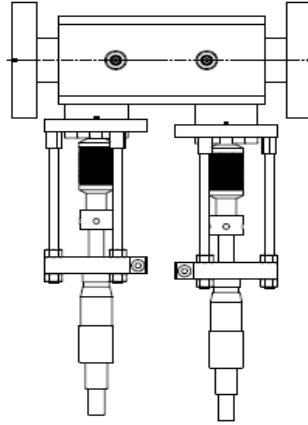

**Frequency tuning parts**

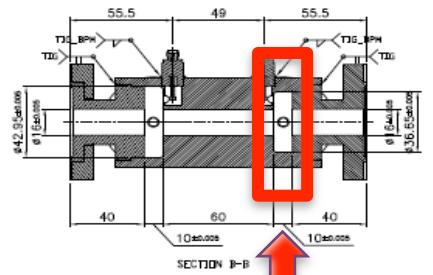
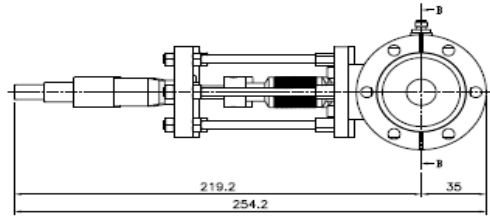
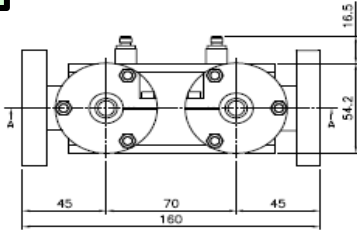
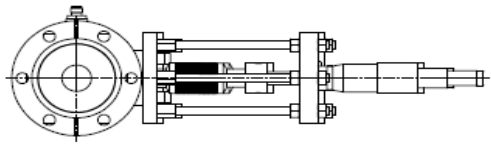
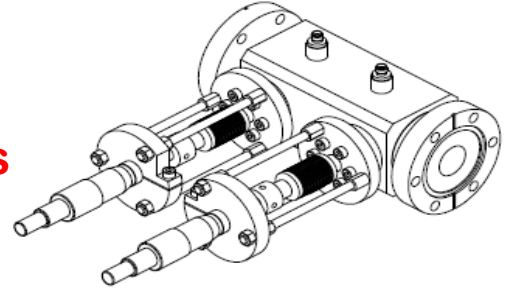

**Up & down tuning pin can control 70MHz frequency**

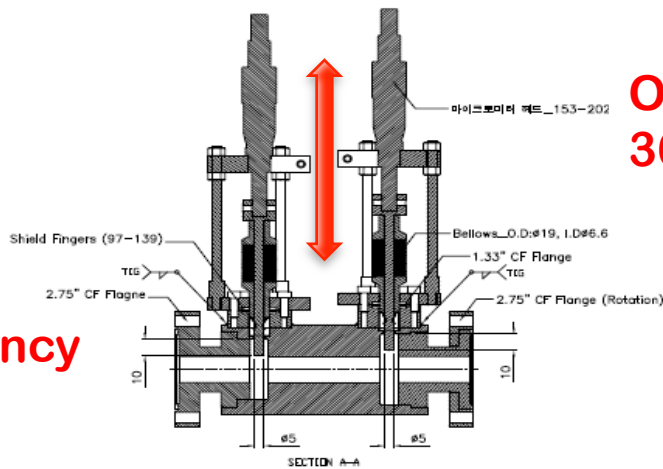

**Original 36.65mm → Check at 37.65mm → Change to 38.65mm**

SCALE  
1. Reference Cavity BPM Lay-out.

NO.	DWG NO.	DESCRIPTION	PER SET	TOTAL QUANTITY	MATERIAL	REMARKS
0			1	1		
SHOWN ON		UNLESS OTHERWISE SPECIFIED	Corporate Name		VACTRON	
DRN	SH KIM	X ±	TITLE Reference Cavity BPM Ass'y			
DATE	2013.09.04	JXX ±				
CHD		JXX ±				
DATE		ANGLE ±				
APPD		SCALE	None	DWG NO	KNU-RCB-0000	Rev A
DATE		UNIT	mm			



# Oct. beam commissioning of IP-BPM system



## Contents

- Installation of IP-BPM system with alignment check
- Phase shifter check with I-Q tuning
- ADC system check
- Basic beam test to check the resolution of IP-BPMs



# Installation of IP-BPM system with alignment check

## ■ The IP-BPM system installation

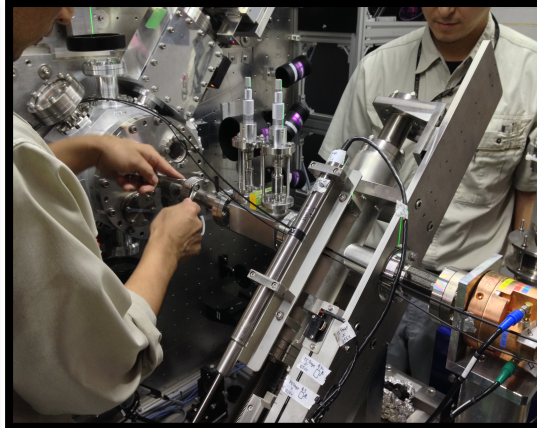
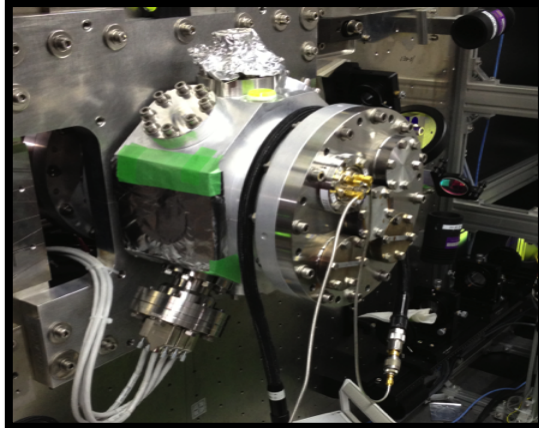
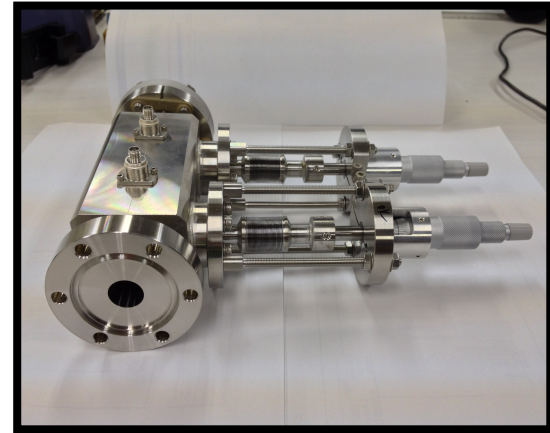
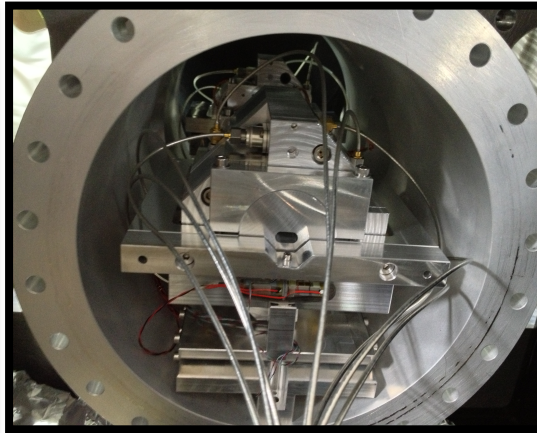



# Installation of IP-BPM system with alignment check

- All of the IP-BPM system was installed inside tunnel near the IP-region. The electronics, LO signal splitter, and variable attenuators( x8) are installed. The cable connection scheme was shown in the Left bottom figure.

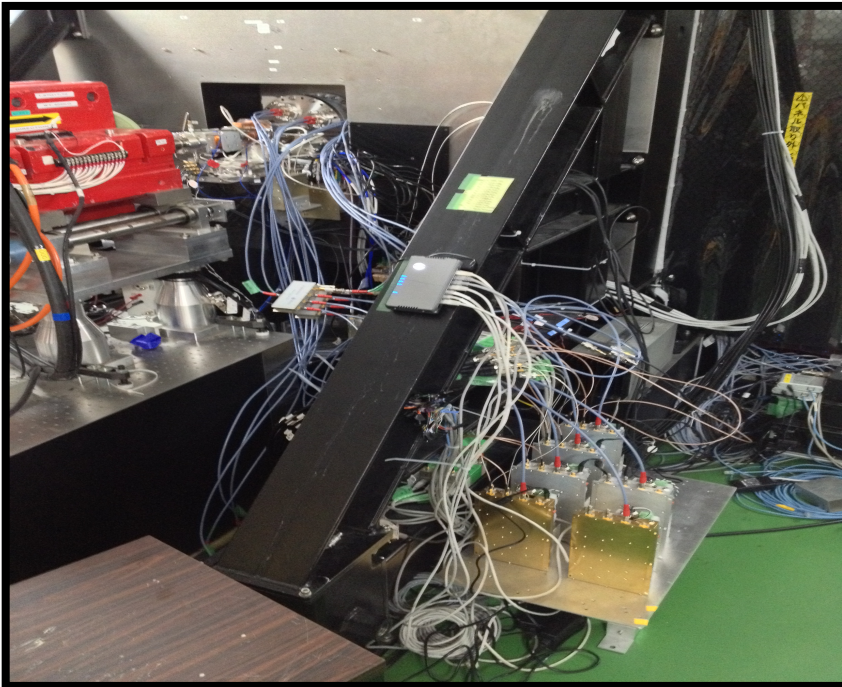

Electronics w/ cable connection

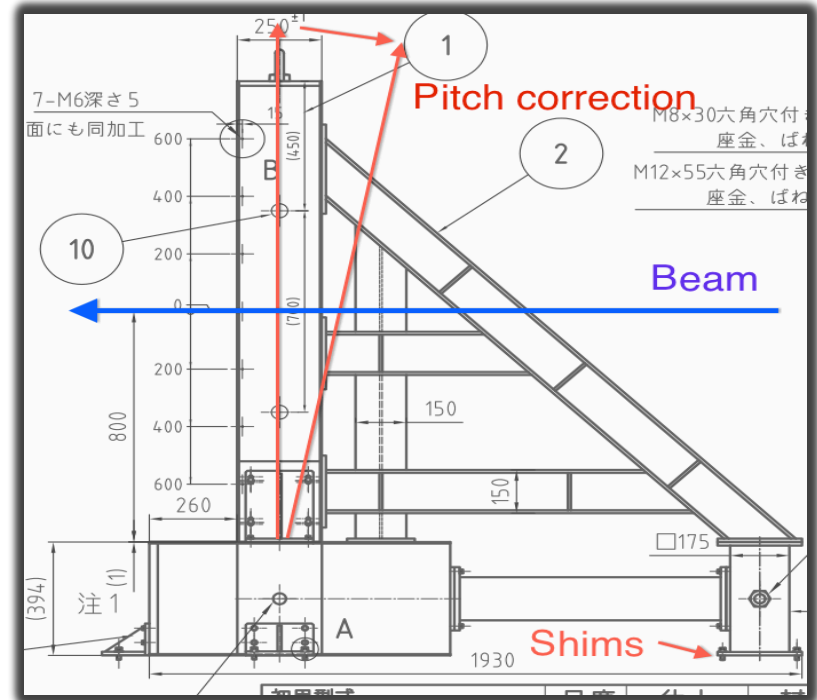

IP-chamber re-align by using IP-BPMs

# + Phase shifter check with I-Q tuning

- The phase shifter was controlled remotely.
- The phase between I and Q signal can be changed from 0 degree to more than 360 degree.
- The IPBPM mover control software also prepared by ATF people.
- I-Q tuning was well works with 20dB LO attenuator!

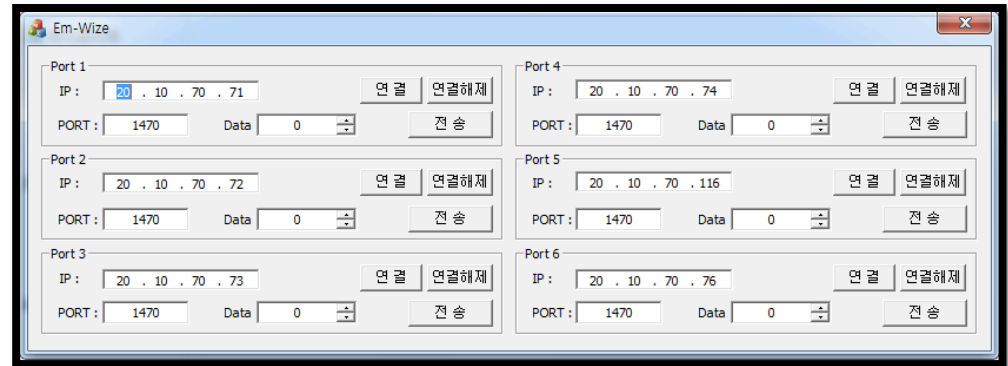

Phase shifter control software

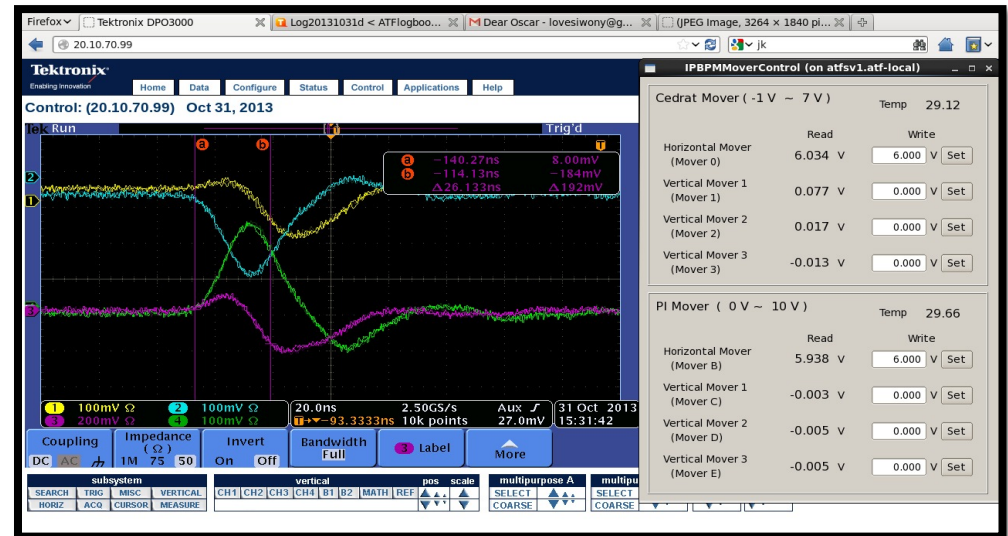

I-Q tuning with mover system



# Solving the problem of the bipolar waveform IF signals

- The IPBPM output signals shows as bipolar waveform during I-Q tuning. To fix this strange situation, we performed several studies. Finally, we found the solution of the problem of IP-BPM I-Q tuning with bipolar waveform. The output signal level of Ref. cavity BPM was too high than designed electronics input level. Therefore, the mixed I and Q signals shows very strange motion during I-Q tuning study. The designed L.O. input level was below 10dB level, but the input beam signal level was more than 20dBm. Thus, we attached 20dB attenuator in front of L.O. signal splitter. Then we got the very clear mixed I and Q signals until 0dB att. RF signal case.

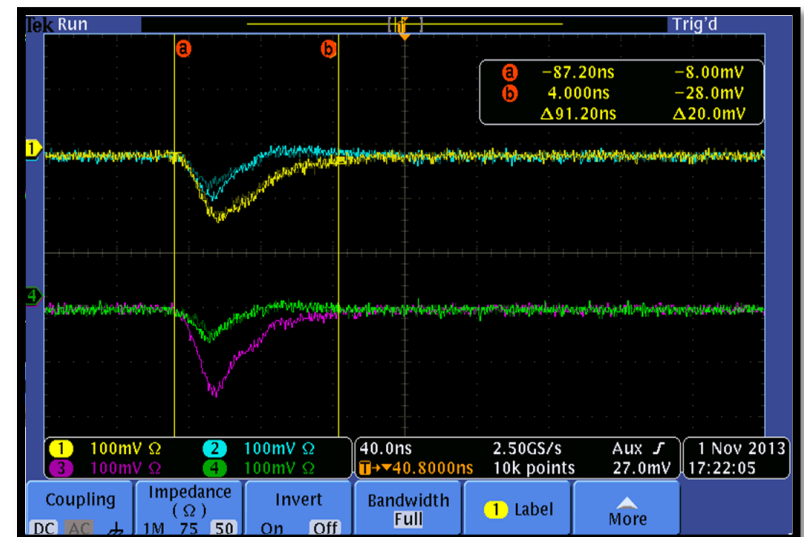
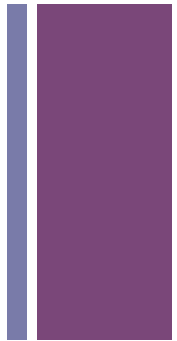

# + ADC system check



- ADC(c009h) pedestals were measured with 50ns gate time.
- An available measure range of ADC is -500mV square signal with 50ns. Which signals correspond to -500pC of limit of ADC.
- Thus, the measurable output voltage range will be 0mV to -500mV with square signal for c009h ADC.
- Therefore, the expected dynamic range for ADC was narrow than oscilloscope beam commissioning case.

	Electronics offset	Measured pedestal of ADC	Corresponded pC of ADC
IPBPM A YI	-50mV	1934 counts (+370 counts)	-60pC
IPBPM A YQ	-24mV	982 counts (+350counts)	-30pC

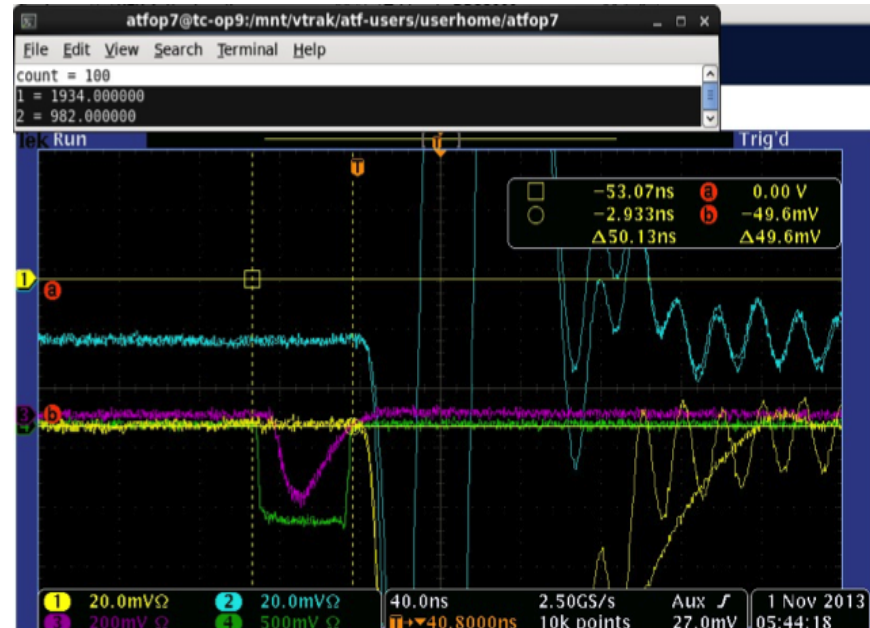



# Basic beam test to check the resolution of IP-BPMs (Calibration run with 30dB att.)

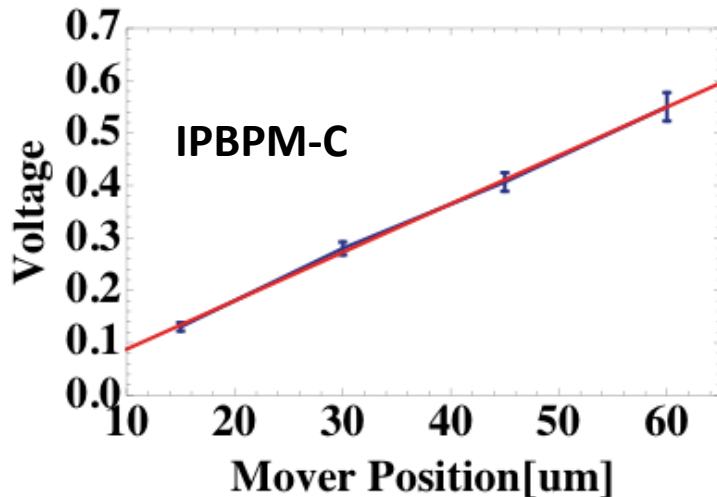
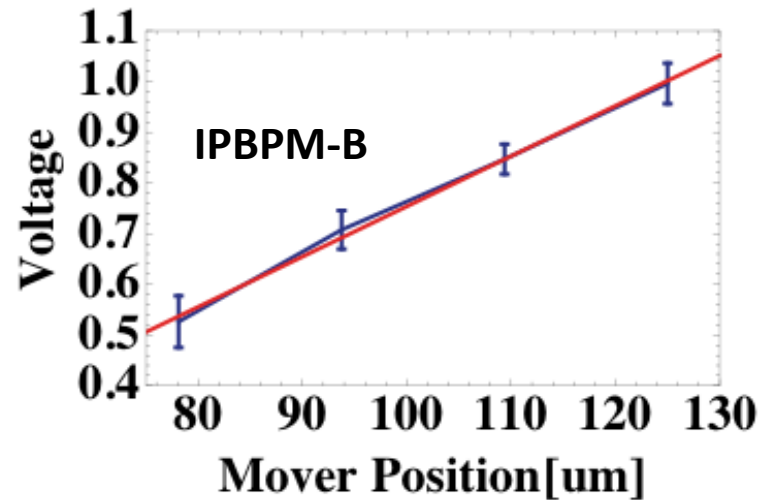
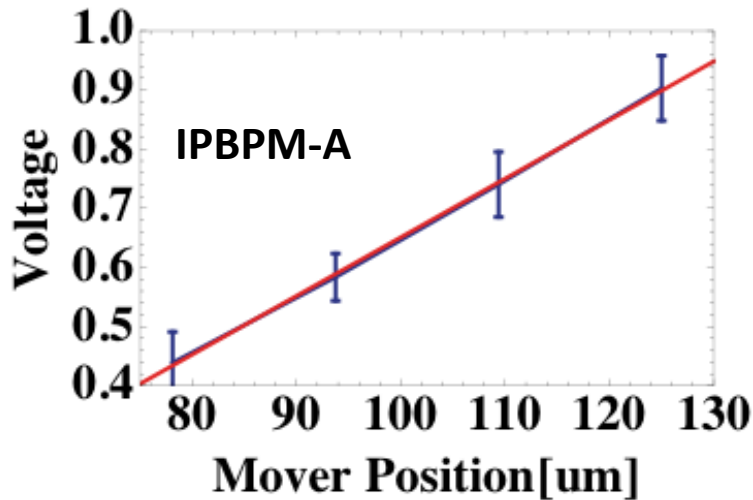

	IP-BPM A [uV/nm]	IP-BPM B [uV/nm]	IP-BPM C [uV/nm]
30dB att.	9.9113	9.9105	9.2349
0dB att.	313.42	313.39	292.03



# The method to calculate the residual of IP-BPMs

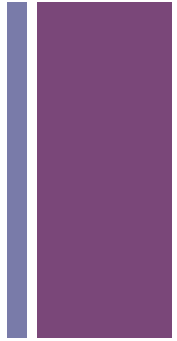

We take an extrapolating method by using geometrical relation between three IP-BPMs.

Differences are expressed by ;

$$f_1 = I_1 - \frac{I_2 Z_{13} - I_3 Z_{12}}{Z_{23}} = \frac{I_1 Z_{23} - I_2 Z_{13} + I_3 Z_{12}}{Z_{23}}$$

$$f_2 = I_2 - \frac{I_3 Z_{12} + I_1 Z_{23}}{Z_{13}} = \frac{-I_1 Z_{23} + I_2 Z_{13} - I_3 Z_{12}}{Z_{13}}$$

$$f_3 = I_3 - \frac{I_2 Z_{13} - I_1 Z_{23}}{Z_{12}} = \frac{I_1 Z_{23} - I_2 Z_{13} + I_3 Z_{12}}{Z_{12}}$$

$$f_0 \equiv I_1 Z_{23} - I_2 Z_{13} + I_3 Z_{12}$$

$$f_1 = \frac{f_0}{Z_{23}}, \quad f_2 = \frac{f_0}{Z_{13}}, \quad f_3 = \frac{f_0}{Z_{12}}$$

$$\frac{\partial f_0}{\partial I_1} = Z_{23}, \quad \frac{\partial f_0}{\partial I_2} = -Z_{13}, \quad \frac{\partial f_0}{\partial I_3} = Z_{12}$$

Residuals are expressed by ;

$$\begin{pmatrix} \Delta f_1^2 \\ \Delta f_2^2 \\ \Delta f_3^2 \end{pmatrix} = \begin{pmatrix} 1 & \left(\frac{Z_{13}}{Z_{23}}\right)^2 & \left(\frac{Z_{12}}{Z_{23}}\right)^2 \\ \left(\frac{Z_{23}}{Z_{13}}\right)^2 & 1 & \left(\frac{Z_{12}}{Z_{13}}\right)^2 \\ \left(\frac{Z_{23}}{Z_{12}}\right)^2 & \left(\frac{Z_{13}}{Z_{12}}\right)^2 & 1 \end{pmatrix} \begin{pmatrix} \sigma_1^2 \\ \sigma_2^2 \\ \sigma_3^2 \end{pmatrix} = A \begin{pmatrix} \sigma_1^2 \\ \sigma_2^2 \\ \sigma_3^2 \end{pmatrix}$$

Since det A is zero,  $\sigma_1 = \sigma_2 = \sigma_3 \equiv \sigma$

$$\sigma = \Delta f_1 / \sqrt{1 + \left(\frac{Z_{13}}{Z_{23}}\right)^2 + \left(\frac{Z_{12}}{Z_{23}}\right)^2} = \Delta f_2 / \sqrt{\left(\frac{Z_{23}}{Z_{13}}\right)^2 + 1 + \left(\frac{Z_{12}}{Z_{13}}\right)^2} = \Delta f_3 / \sqrt{\left(\frac{Z_{23}}{Z_{12}}\right)^2 + \left(\frac{Z_{13}}{Z_{12}}\right)^2 + 1}$$

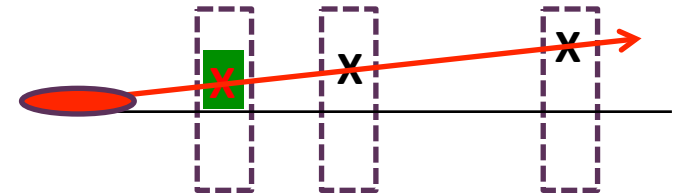

Beam position measurement and prediction

	IPBPM-A <small>(Interpolated by IPBPM-B and C)</small>	IPBPM-B <small>(Interpolated by IPBPM-A and C)</small>	IPBPM-C <small>(Interpolated by IPBPM-A and B)</small>
Geometrical factor	0.531065	0.802629	0.271567

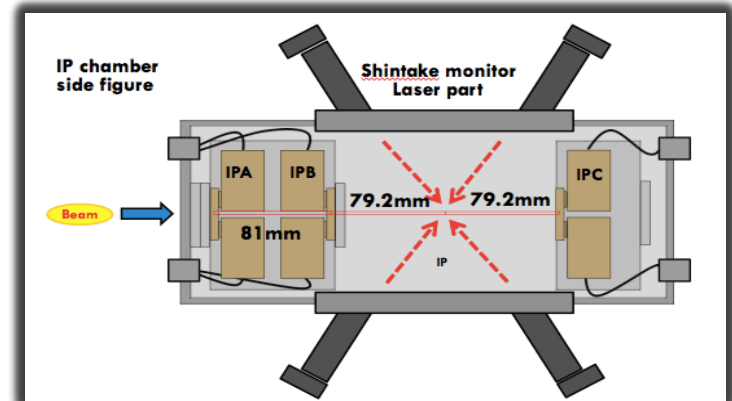





# Basic beam test to check the resolution of IP-BPMs (Resolution run of IPBPM-A with 0dB att.)

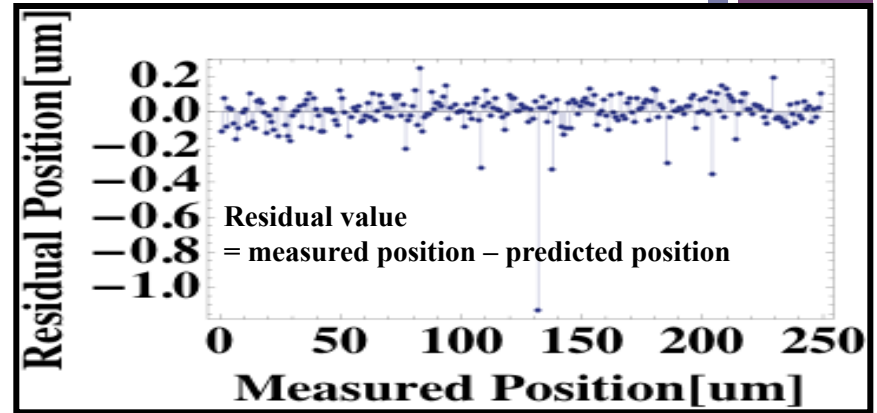
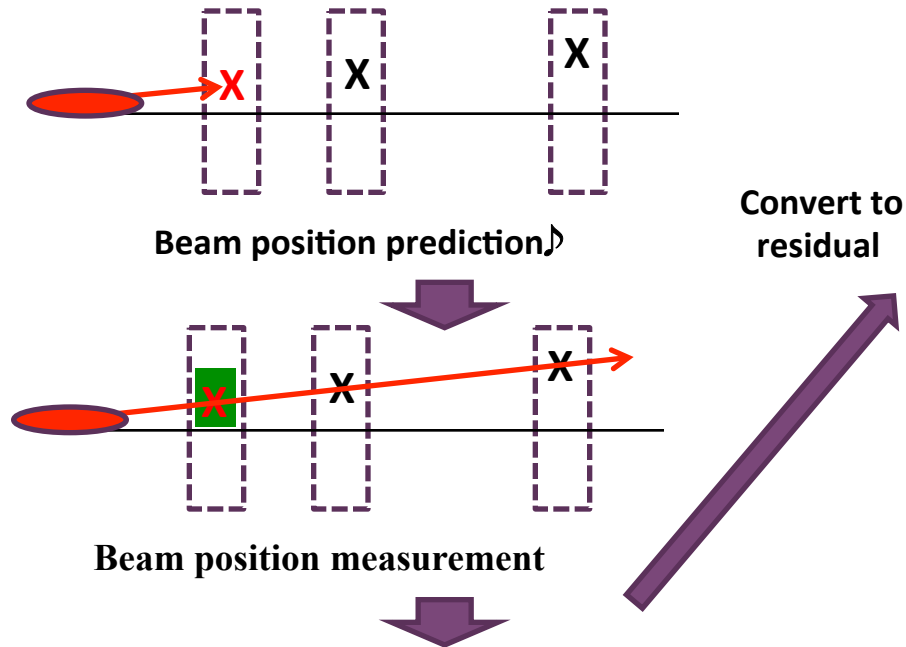

Residual Gaussian fitting

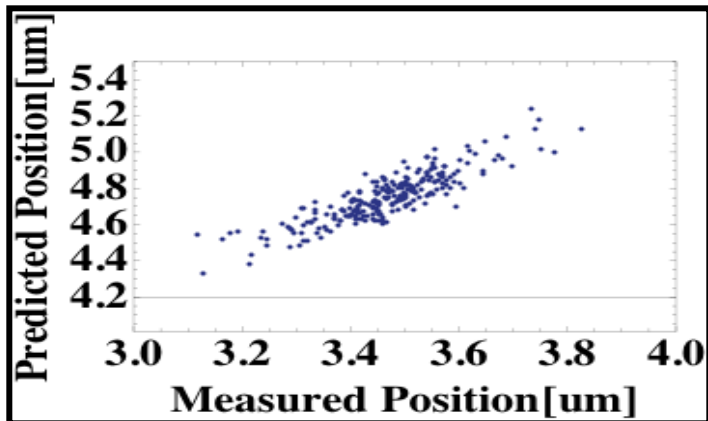
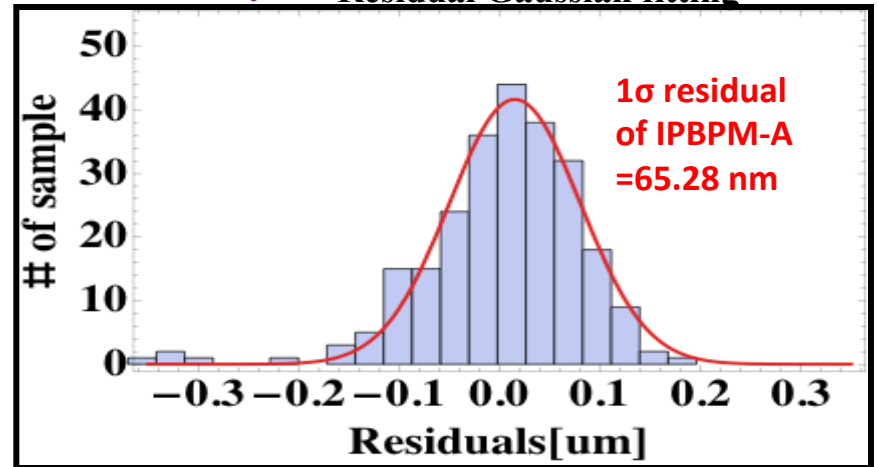

$$\text{Resolution} = G.\text{factor} \times \frac{\text{Residual}}{\text{Calibration factor}} = 34.60 \text{ nm}$$



# Basic beam test to check the resolution of IP-BPMs (Resolution run of IPBPM-B with 0dB att.)

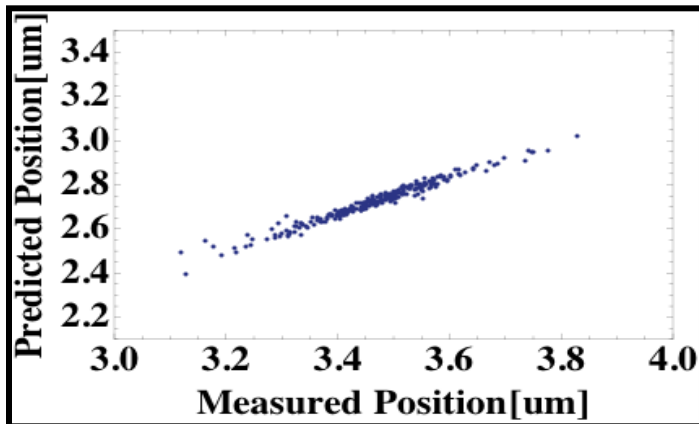
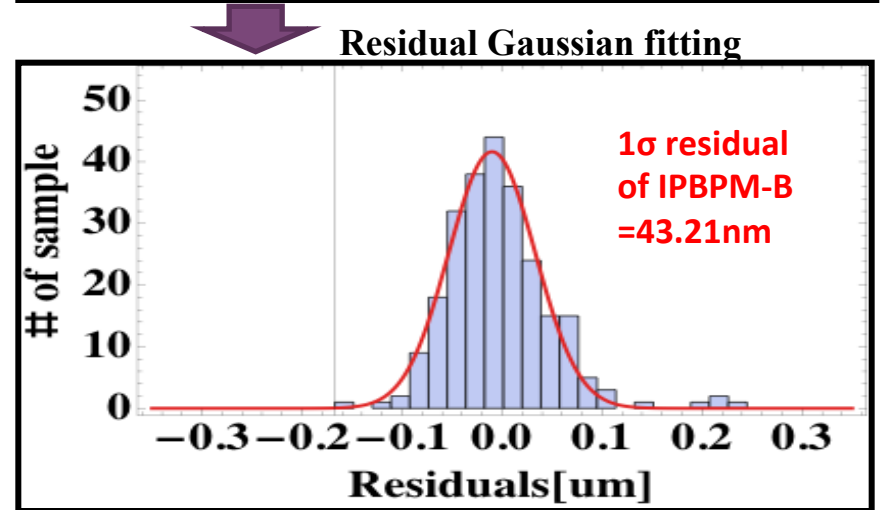
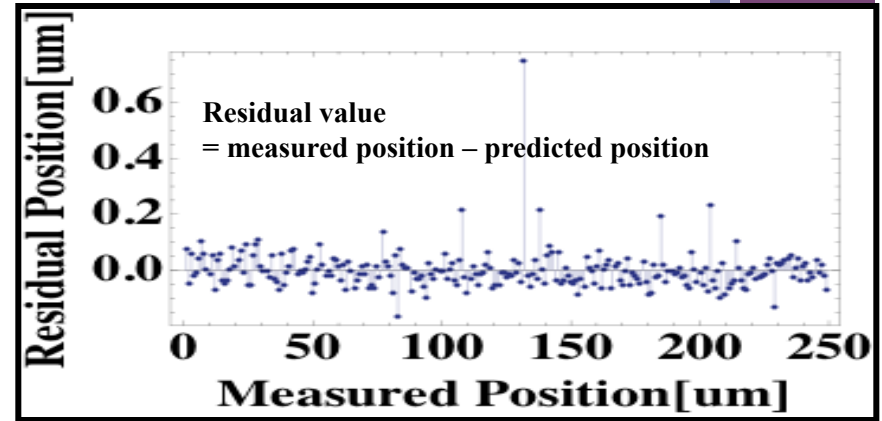
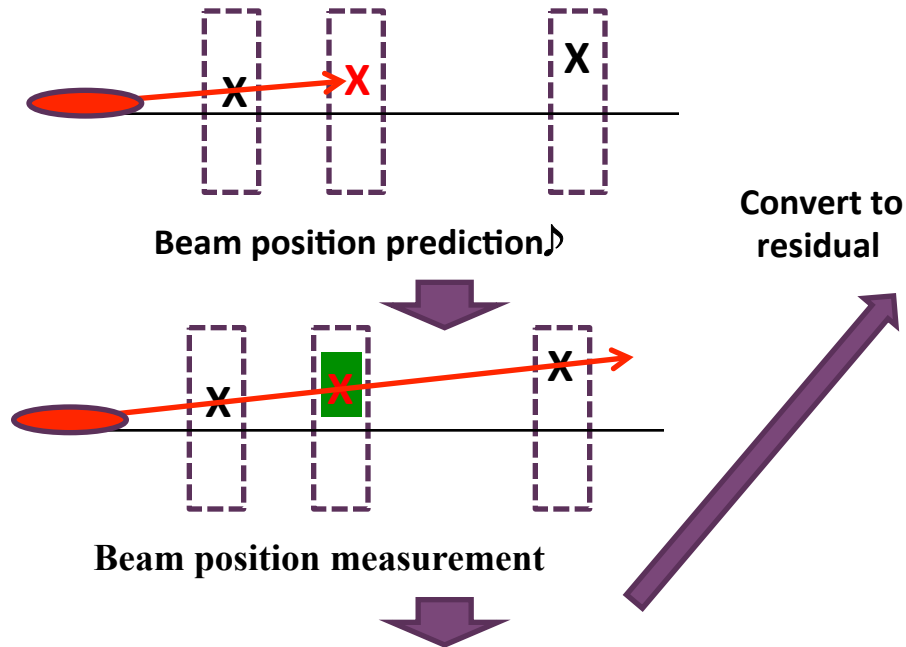

$$\text{Resolution} = G.\text{factor} \times \frac{\text{Residual}}{\text{Calibration factor}} = 34.57 \text{ nm}$$



# Basic beam test to check the resolution of IP-BPMs (Resolution run of IPBPM-C with 0dB att.)

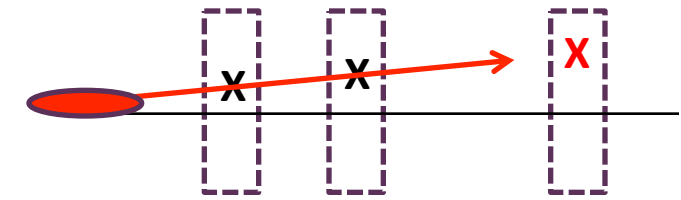

Beam position prediction

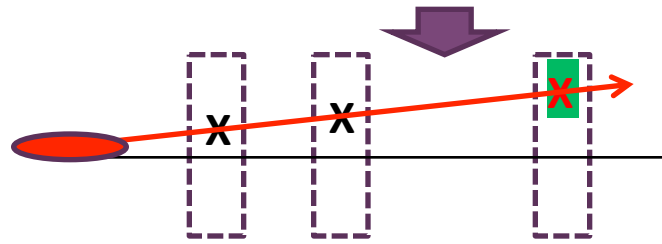

Beam position measurement

Convert to residual

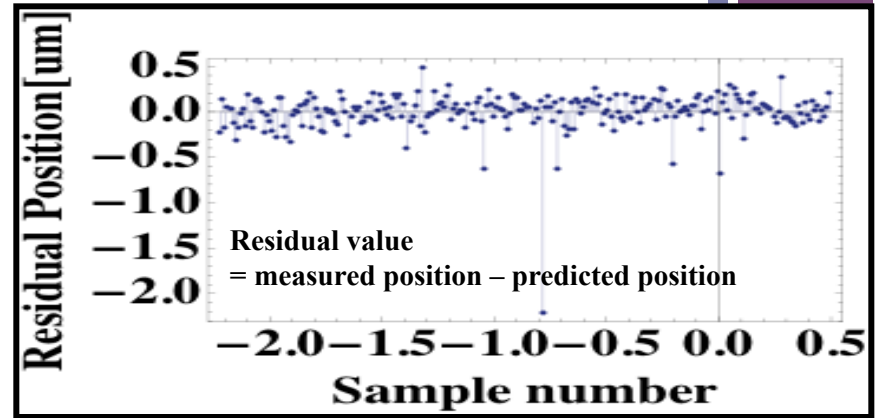
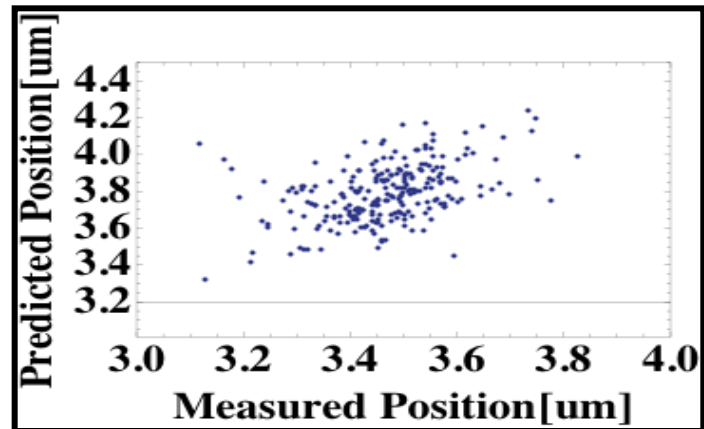

Residual Gaussian fitting

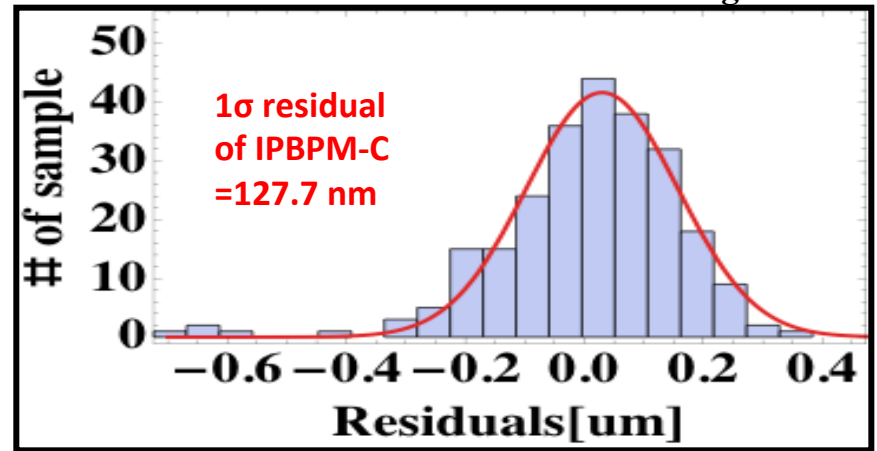

$$\text{Resolution} = G.\text{factor} \times \frac{\text{Residual}}{\text{Calibration factor}} = 34.47 \text{ nm}$$

# Future beam commissioning plan of IP-BPM system



## Contents

- IP-BPM resolution check with oscilloscope
- IP-BPM resolution check with ADC



# IP-BPM resolution check with oscilloscope and ADC



- IP-BPM resolution check with oscilloscope (2weeks in Nov.)
  - Re-calibration with out 10dB attenuator after electronics.
  - One by one synchronization of IP-BPM signal with ref. signal.
  - More perfect I-Q tuning by changing the IP-waist.
  - Ref. signal calibration by using oscilloscope.
- IP-BPM resolution check with ADC (2weeks in Dec.)
  - An available measurement dynamic range check with 0dB att.
  - Calibration run with ADC module.
  - Resolution run with ADC module.
- etc.



# Summary



- We installed all of IP-BPM system. The all of system works well.
- The basic software are prepared to test IP-BPM system.
- The first measurement results of IP-BPM resolution was 34nm with 0.69 x 1.6nC. If we change the beam condition to 1.6nC then we can expect 24nm level.
- During Nov. and Dec. beam commissioning, we will performed more detailed IP-BPM resolution test with oscilloscope and ADC module.