



# The Silicon TPC System

EUDET Extended SC meeting

11 September 2006

Jan Timmermans

NIKHEF

# JRA2 activity/task

- Silicon TPC readout (“SiTPC”)
  - development MediPix → TimePix chip
  - development diagnostic endplate module  
incl. DAQ

Purpose: a SiTPC based monitoring system

Partners:

ALU Freiburg, CEA Saclay, CERN, NIKHEF

Associate: Bucarest

# Goals in context of ILC

- **Gas multiplication** GEM or Micromegas foil(s)
- Charge collection with **granularity matching primary ionisation cluster spread**  
(this needs **sufficiently low diffusion gas**)
- Investigate measurement  $dE/dx$  using **cluster counting?**
  
- 2D “proof of principle” based on existing **Medipix2** readout chip: **achieved (2004, 2005) by NIKHEF/Saclay, Freiburg**
- Add 3<sup>rd</sup> coordinate: **Medipix2** → **TimePix** (→2006/2007)
- Integrate grid with pixel chip: **Ingrid** (first results 2005)

## SITPC Tasks:

- Develop the Timepix chip that allows to measure the 3<sup>rd</sup> coordinate (drift time)
- Implementation of Timepix together with GEM and Micromegas into diagnostic endplate system
- Performance measurements in test infrastructure at DESY
- Develop simulation framework
- Develop DAQ system and integrate in overall DAQ of EUDET infrastructure

# Micro Patterned Gaseous Detectors

- High field created by Gas Gain Grids
- Most popular: GEM & Micromegas

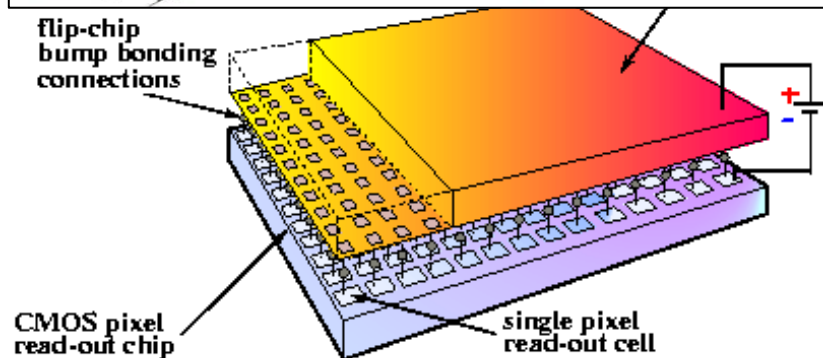
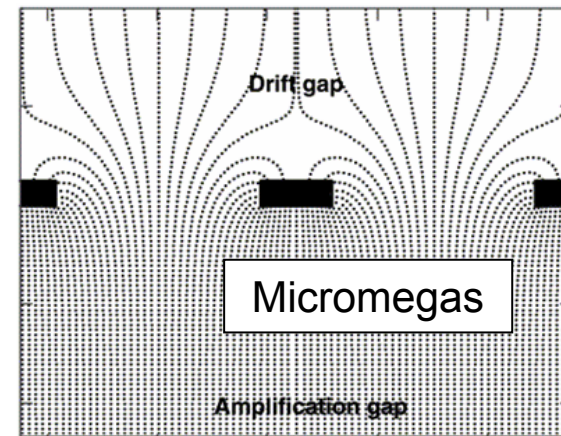
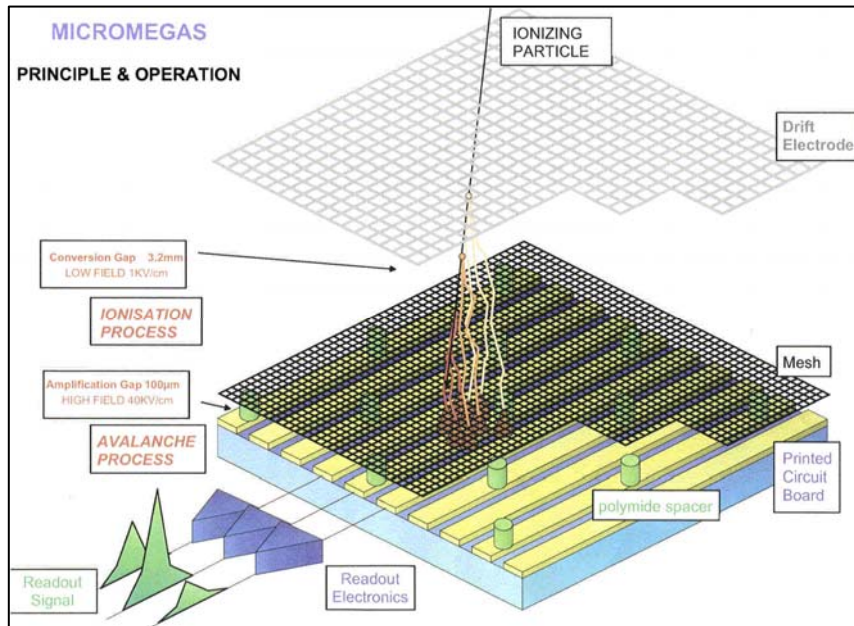
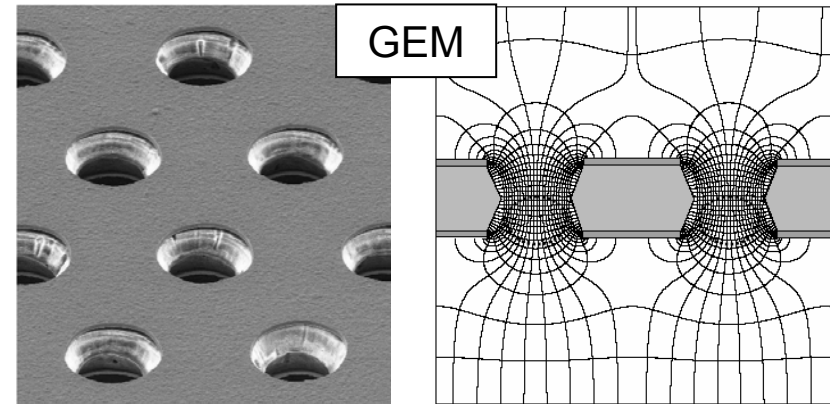

Use 'naked' CMOS pixel readout chip as anode

# Results pixel readout gas detectors

**NIKHEF-Saclay-CERN-Twente**

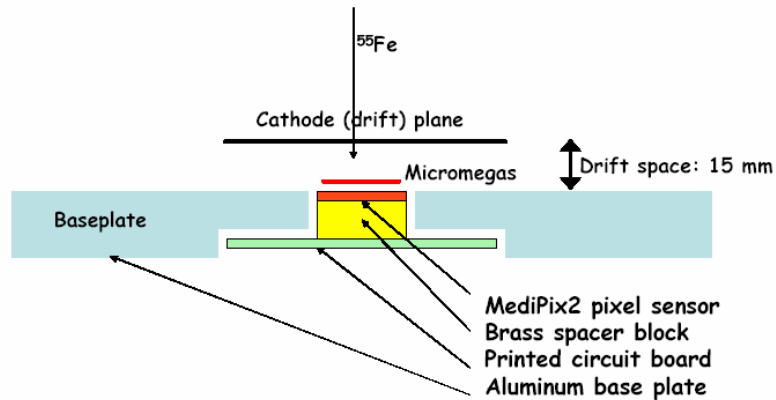

Very strong E-field above (CMOS) MediPix!

He/Isobutane  
80/20  
Modified MediPix

31 March 2004

Sensitive area:  
14 x 14 x 15 mm<sup>3</sup>

Drift direction:  
Vertical  
max = 15 mm

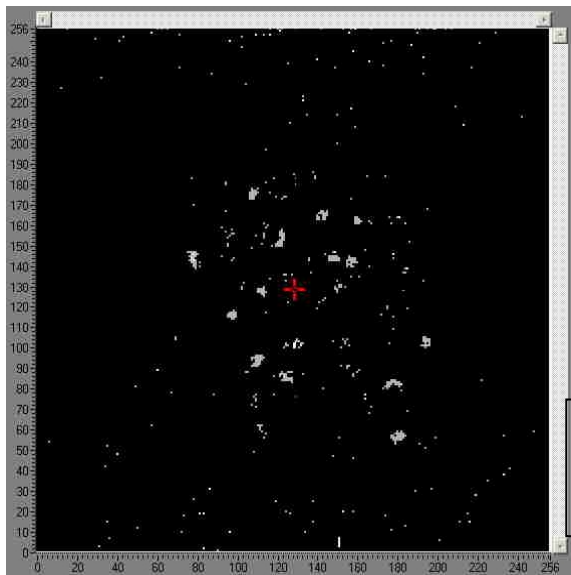
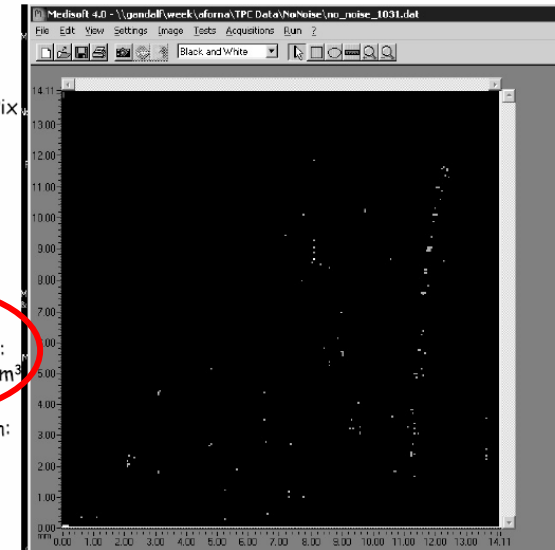

55x55  $\mu\text{m}^2$   
pixels

Ar/isobutane  
95/5

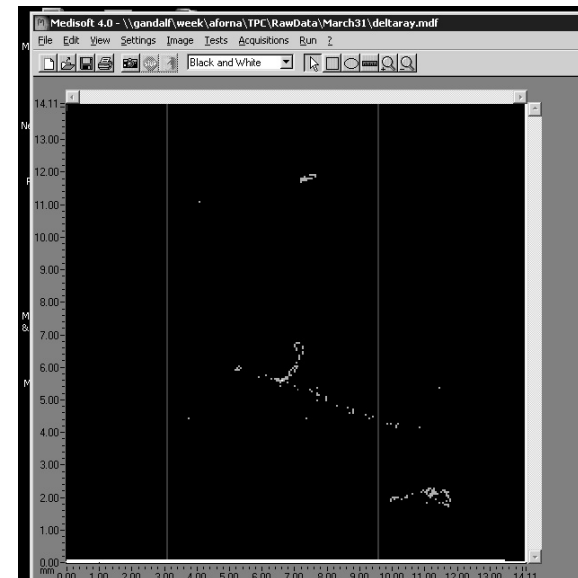

$\delta$  ray

Observation of min. ionising cosmic muons: high spatial resolution +

NIM A540 (2005) 295 (physics/0409048)

individual cluster counting !



# JRA2 GEM-TimePix Projekt

Institute of Physics, Albert-Ludwigs-Universität Freiburg

- Micro Pattern Gas Detectors (MPGD): high resolution readout and high rates
  - pixelated readout offers high resolution
- a TPC at the ILC needs excellent momentum resolution =>GEM-TimePix for end plate readout
  - Cluster counting as a goal

Digital Bubble Chamber

- a TPC at the ILC needs excellent momentum resolution =>GEM-TimePix for end plate readout

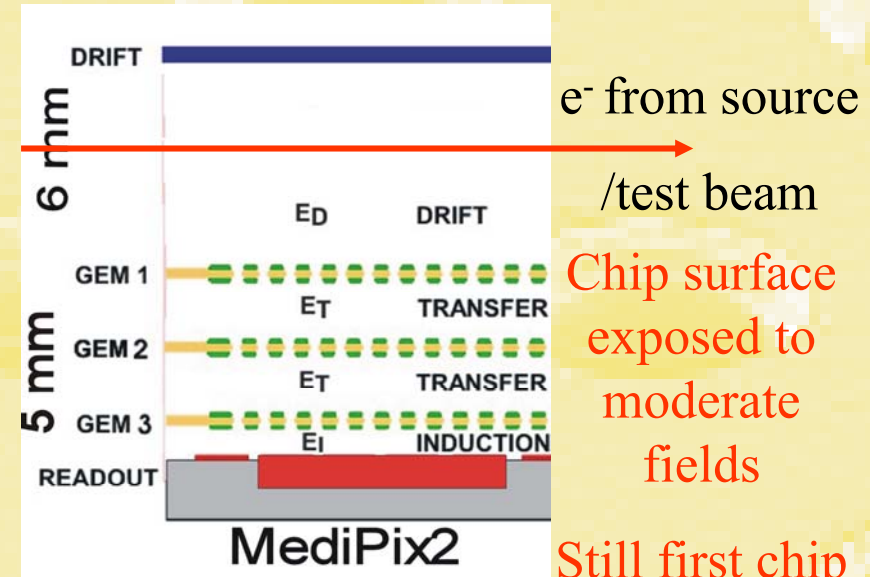

Still first chip since 1.5 y !

Results from MediPix Prototype setup:

For ArCO<sub>2</sub> and HeCO<sub>2</sub>: point/cluster resolution determined with different algorithms between 50 - 60 $\mu$ m

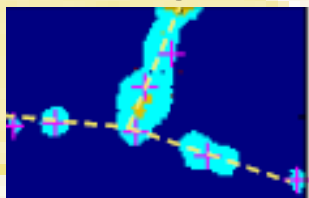

$\delta$ -electron in HeCO<sub>2</sub>

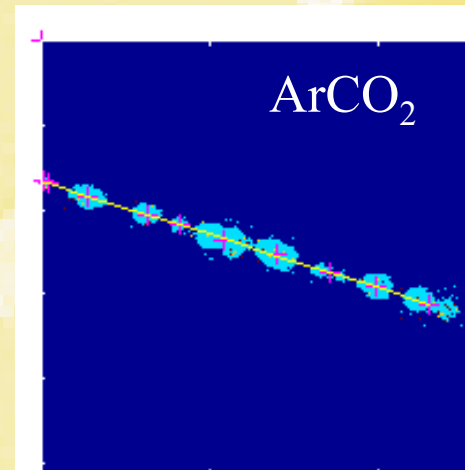

Charge deposition on the MediPix Chip electron track from <sup>106</sup>Ru source and straight line fit



# Some events with fits

(from Freiburg GEM+Medipix setup - Andreas Bamberger)

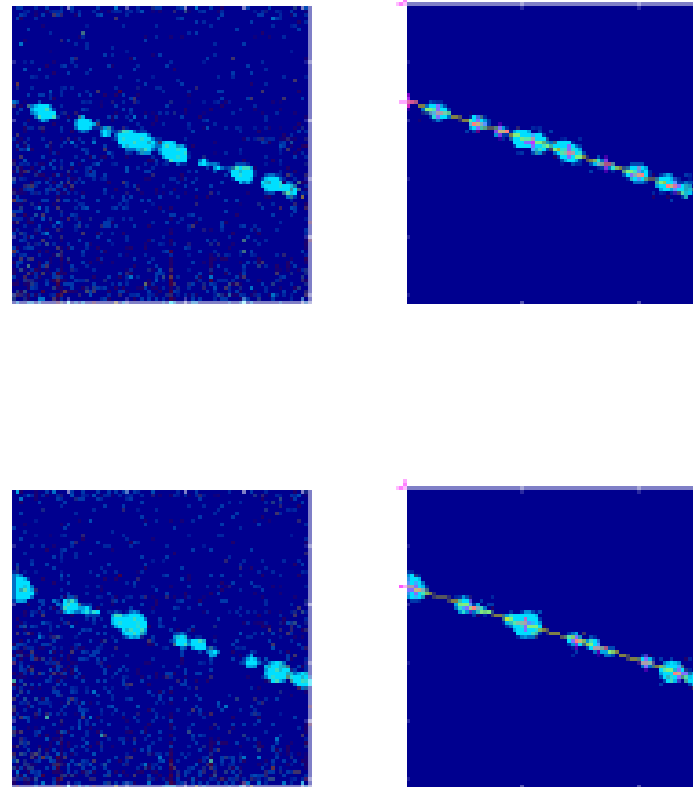

Difference between Micromegas and GEM setup understood (simulation Michael Hauschild)





# Results for point/cluster resolution

(from Freiburg GEM+Medipix setup)

	Ar/CO <sub>2</sub>	He/CO <sub>2</sub>
3-point method	58 ± 2 μm	53 ± 3 μm
$\sigma_{\text{corrected}}^*$	54 μm	53 μm

- **with few primary electrons per cluster !**
- \* multiple scattering correction to be checked for systematics



# Test beam event

multiple scattering negligible on MediPix scale

trigger counters  $\sim 8$  mm wide

Si telescope ( $\sim 20$   $\mu\text{m}$  precision)

$\text{diff}(1) = 36.6 \mu\text{m}$

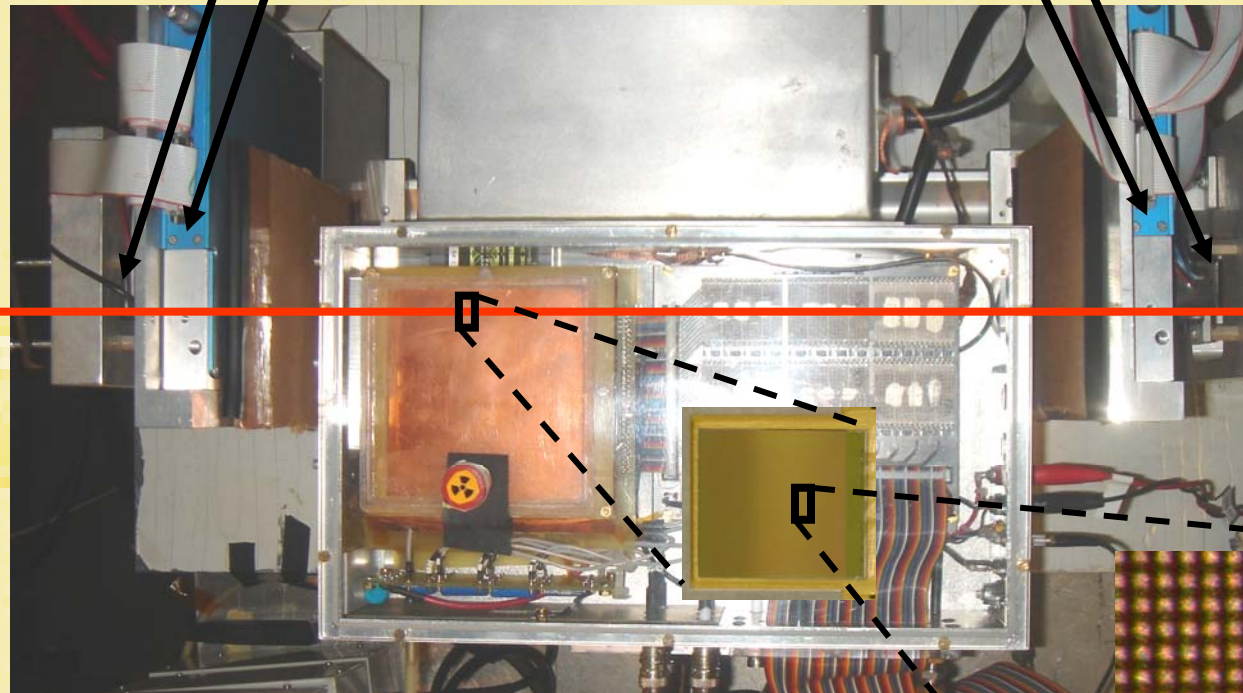
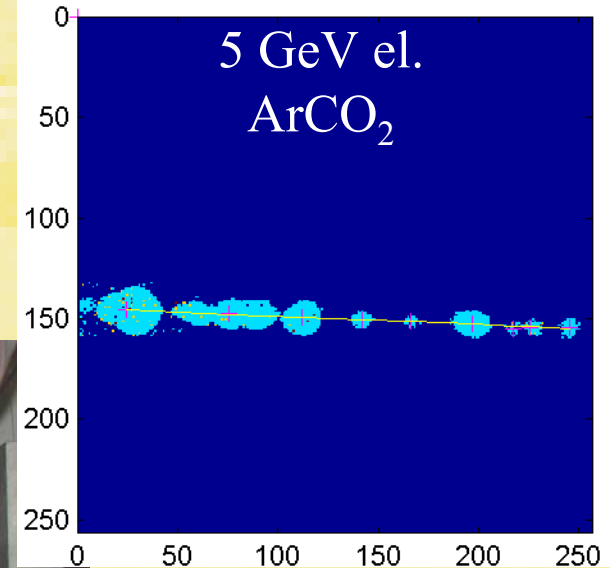

GEM stack of  
 $10 \times 10 \text{ cm}^2$

MediPix2  
chip  $14 \times 14$   
 $\text{mm}^2$

$e^-$  from PETRA



pitch of  
pixels

$55 \mu\text{m}$

# Simulations (M.Hauschild): Threshold Scan

**GEM**

detection thresholds per pixel (allow 10% variation):

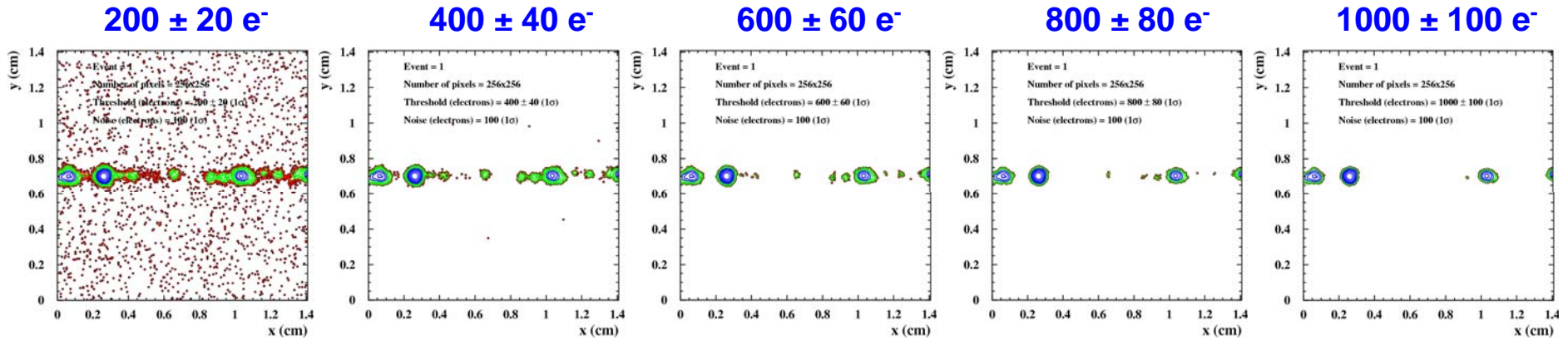

noise: 100 e<sup>-</sup>

**MicroMegas**

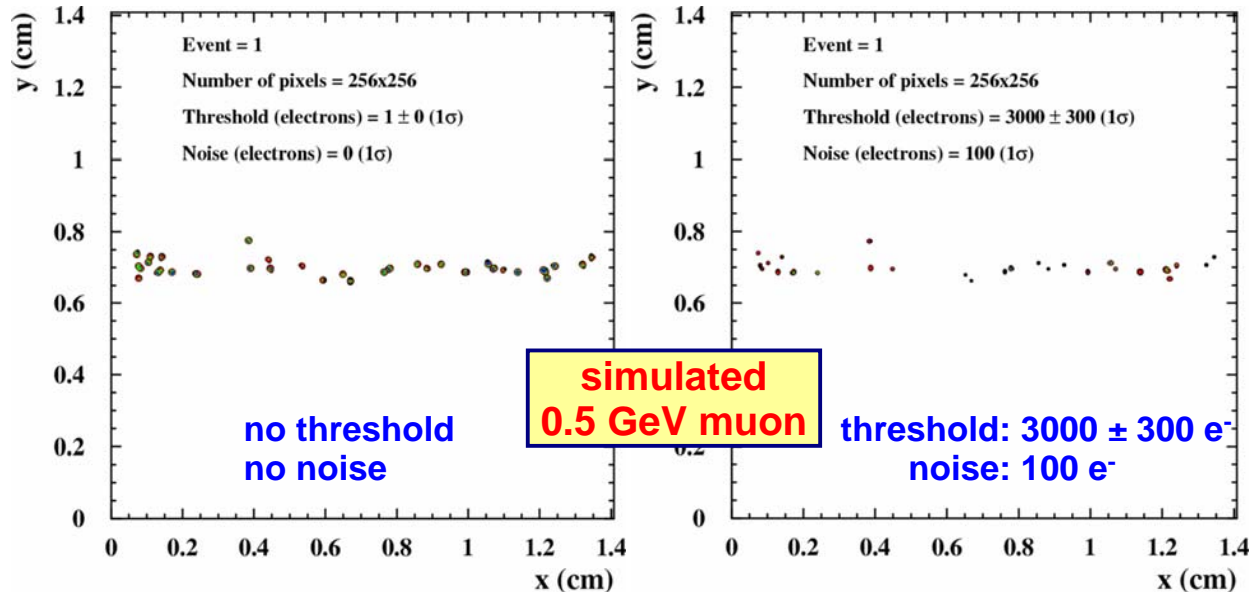
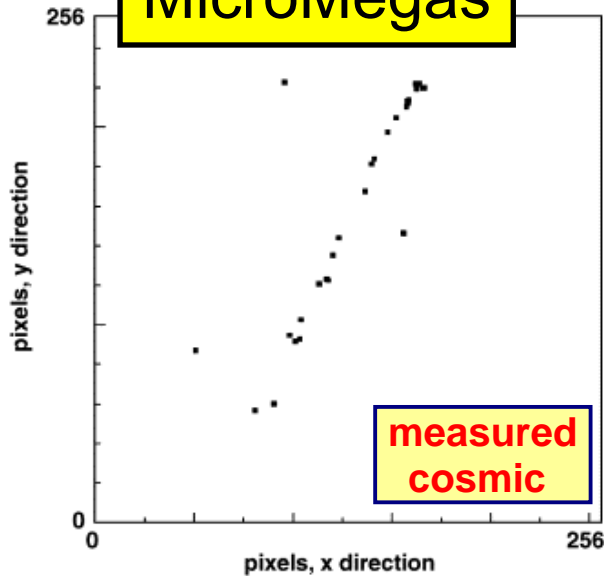

# TimePix1 (EUDET: Freiburg, Saclay, CERN, NIKHEF)



- Distribute clock to full 256x256 pixel matrix (50-**100**-160MHz)
- Enable counting by first hit after 'shutter' opens, until 'shutter' closes (**common stop**); also **time-over-threshold** possible
- Dynamic range  $2^{14} \times$  **10 ns** = 160  $\mu$ s
- (for the time being) no zero-suppress to remain fully compatible with Medipix2
- Shaping time  $\sim$ 200 ns
- Extra static discharge protection for the could be considered later
- **Keep same chip-size, pixel-size, readout protocol**
- **1st full reticle submit done July 2006**

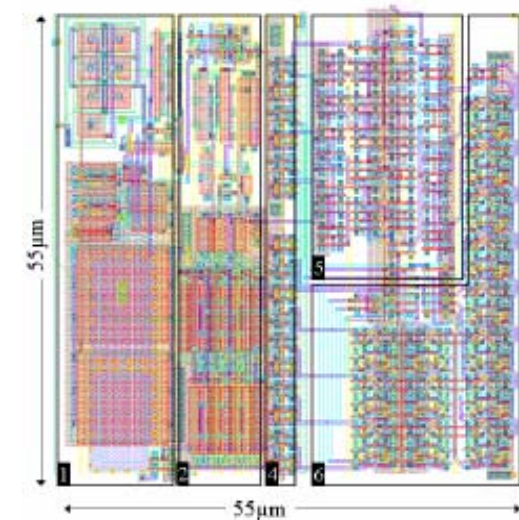



# Expected digital power vs frequency

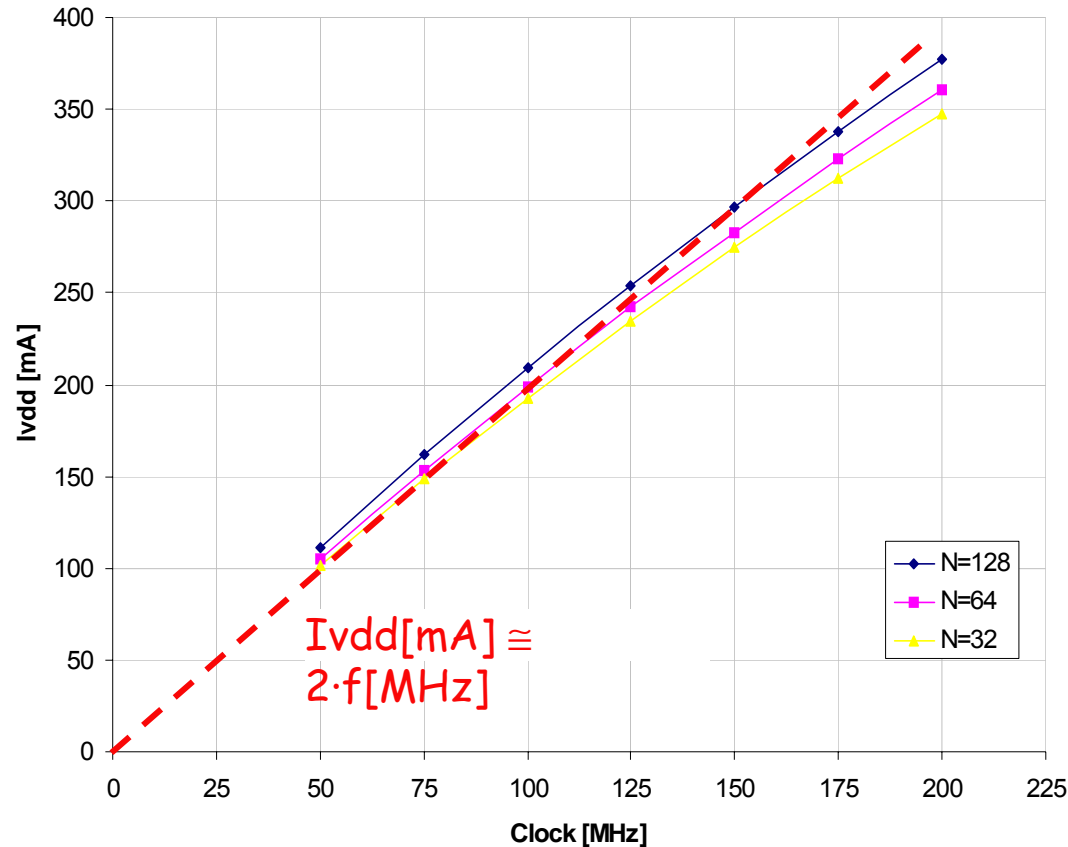

- ◆  $P_{vdd} = V^2 \cdot f \cdot C_{tot}$
- ◆ Simulation @  $V_{dd} = 2.2V$  but digital part could work to 1.8V (33% less power)



# Timepix

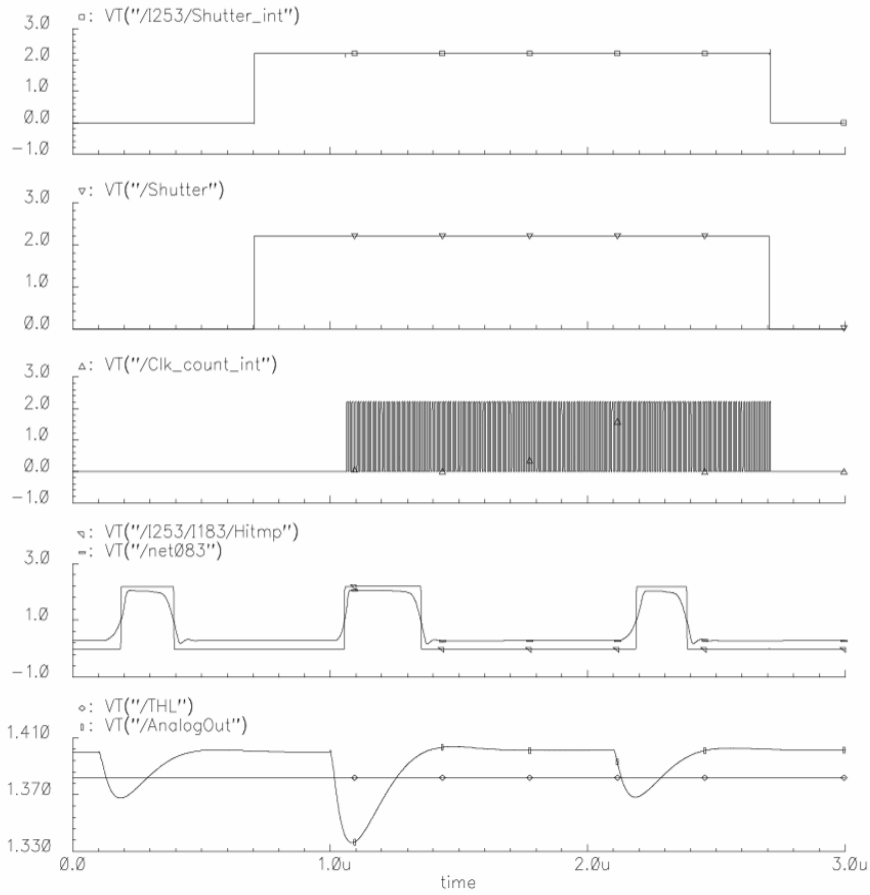

100MHz

# TOT

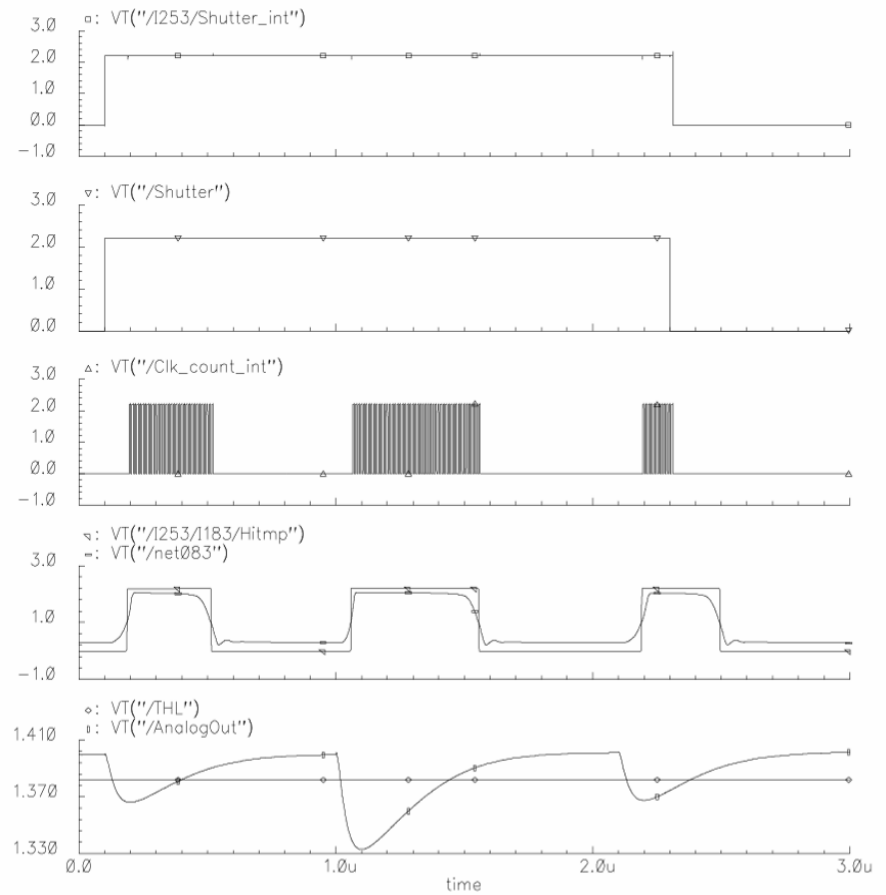

100MHz



# Mpix2MXR20 vs Timepix Layout

Mpix2MXR20 layout

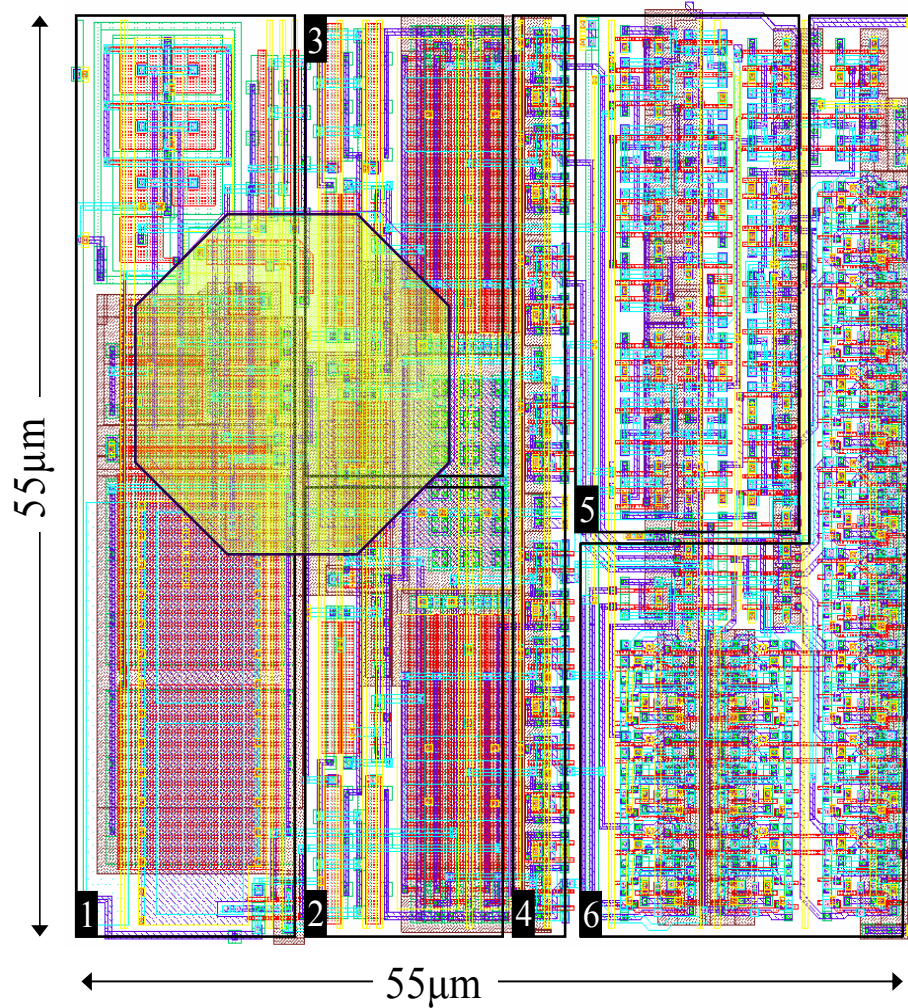

Timepix layout

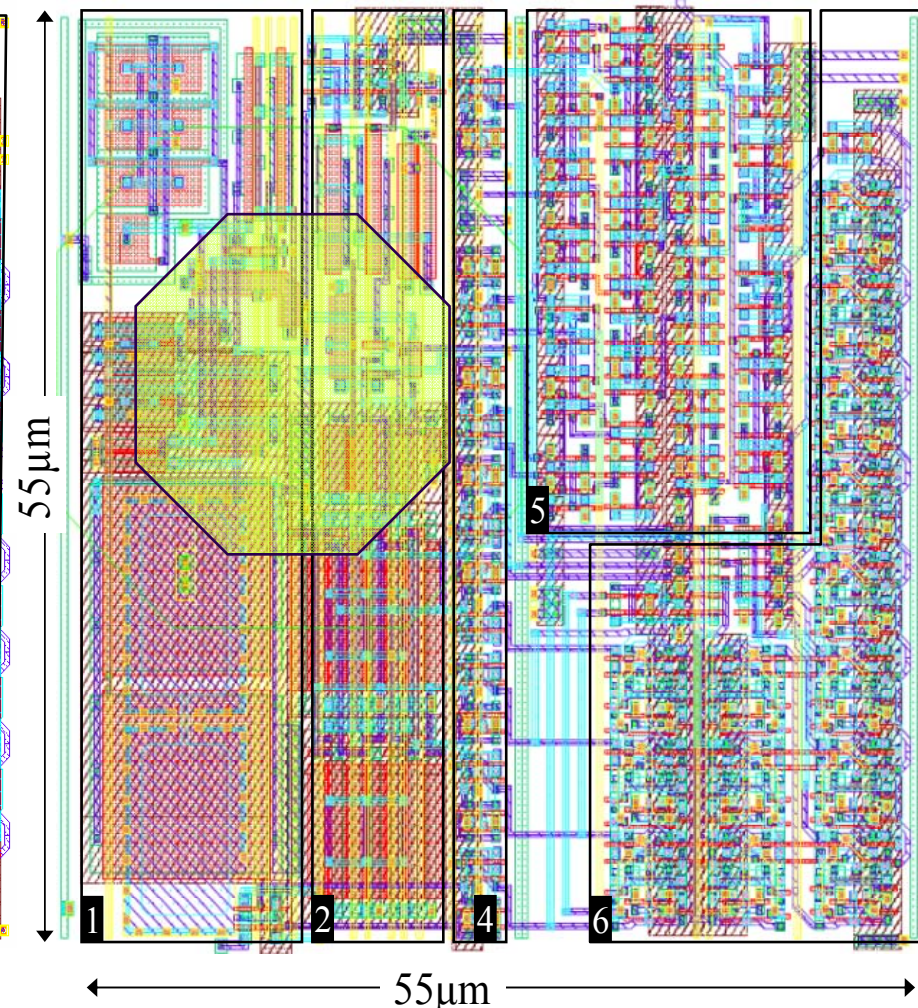



# Timepix summary

Physical dimensions	14.111 mm x 16.120 mm (like Mpix2MXR20)
IO PADS	127 (like Mpix2MXR20)
Charge collection	$e^-$ , $h^+$
Pixel functionality	PhotonCounting, TOT, Timepix
Amplifier Gain	$\sim 18\text{mV}/\text{Ke}^-$
Noise	$\sim 75e^-$
Linearity	Up to $50\text{Ke}^-$
Thresholds	1 (4bits adj)
$\sigma$ equalized	$\sim 25e^-$
Minimum Threshold	$\sim 500e^-$ (expected)*
Counter Depth/Overflow	14-bits/Yes
Max Analog power	$6.5\mu\text{W}/\text{pix}$ $420\text{mW}/\text{chip}$ (@2.2V Vdda)
Static Digital Power	$440\text{mW}@100\text{MHz}$ (@2.2V Vdd)
Readout	Serial/Parallel
Readout compatibility	95% (Clock active when shutter ON)





# Timepix: Next Steps

- ◆ Expected 12 wafers out of foundry by 19<sup>th</sup> of September ⇒ 25<sup>th</sup> to 30<sup>th</sup> September delivered at CERN
- ◆ Testing of the chip on wafer using the Medipix2 probecard in the Silicon Lab clean room
- ◆ First version of Timepix firmware for the Muros2.1 readout is already prepared
- ◆ 1-2 month of chip characterization and wafer probing expected

- MUROS arrived in Saclay
- Upgraded to the latest firmware of the Medipix2 USB Interface with a home-made cable : USB1.1 v1.0.6 -> USB1.1 v1.0.7
- Design of a small drift chamber for the chip
- Gain measurements using different gas mixtures with a Micromegas detector

# Drift chamber for a Medipix2 chip

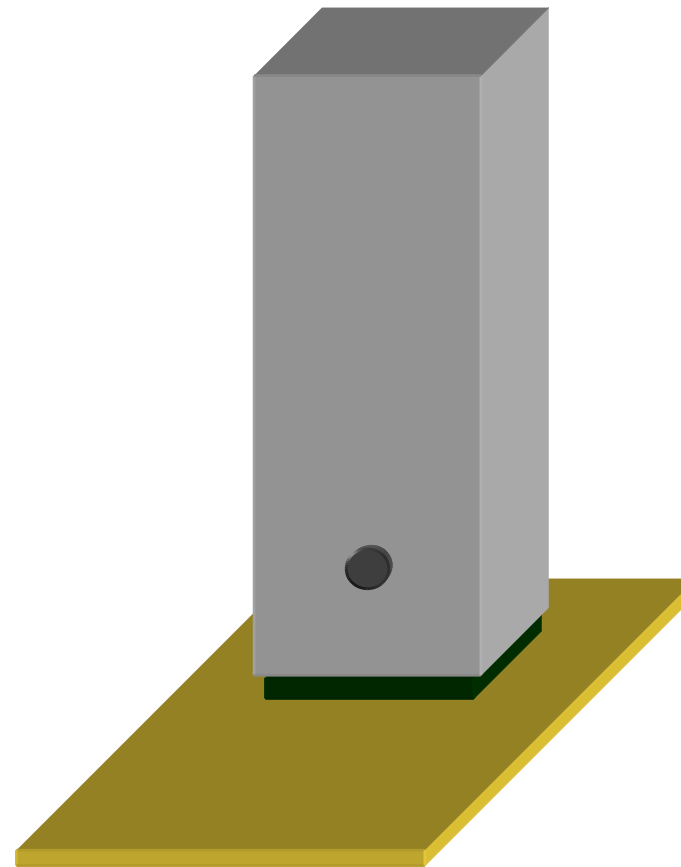
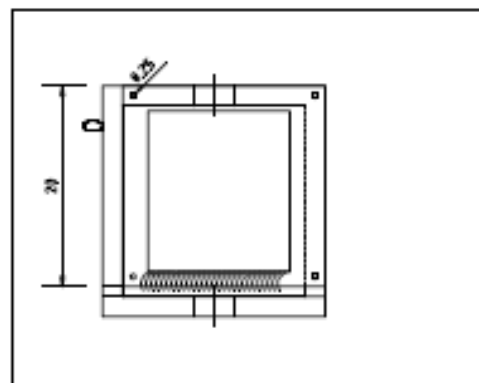
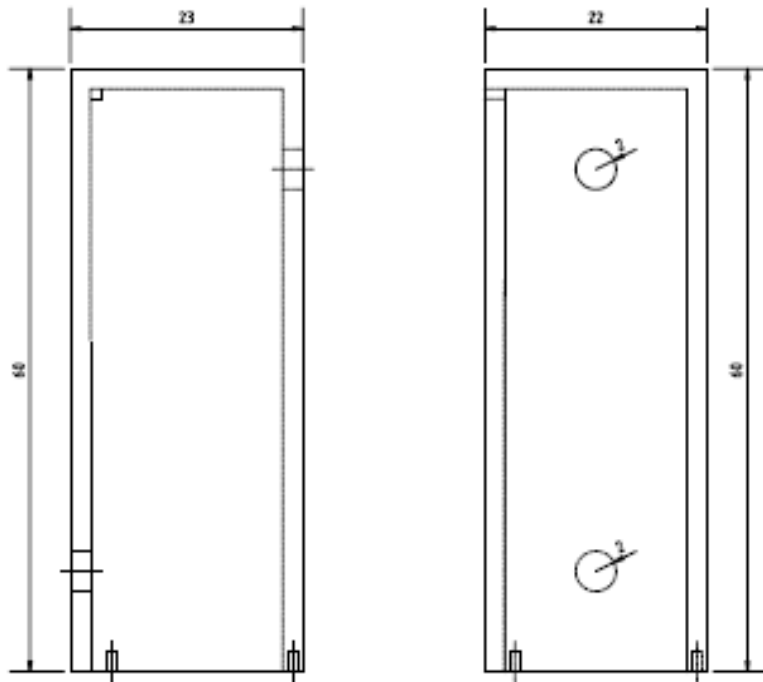

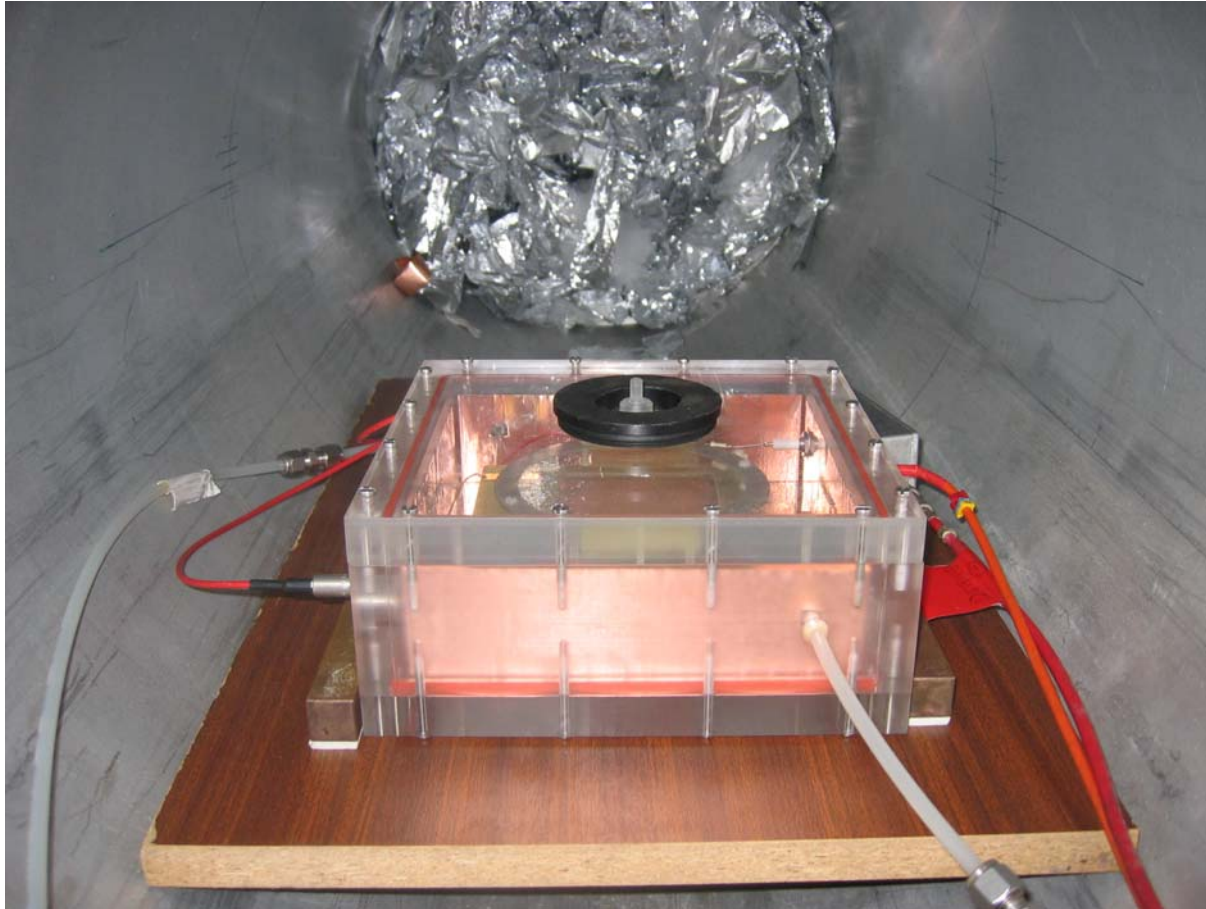

- Aim : find a gas with a comfortable gain margin

- Using the same detector

- Transparent plastic box of 25cm x 25cm x 5cm size

- Sources :

- Fe 55 (5.9 keV)

- COOL-X (8.1 keV)

- Student : Michal Was (ENS)

# Gain measurements : results

## Mixtures of gases containing argon

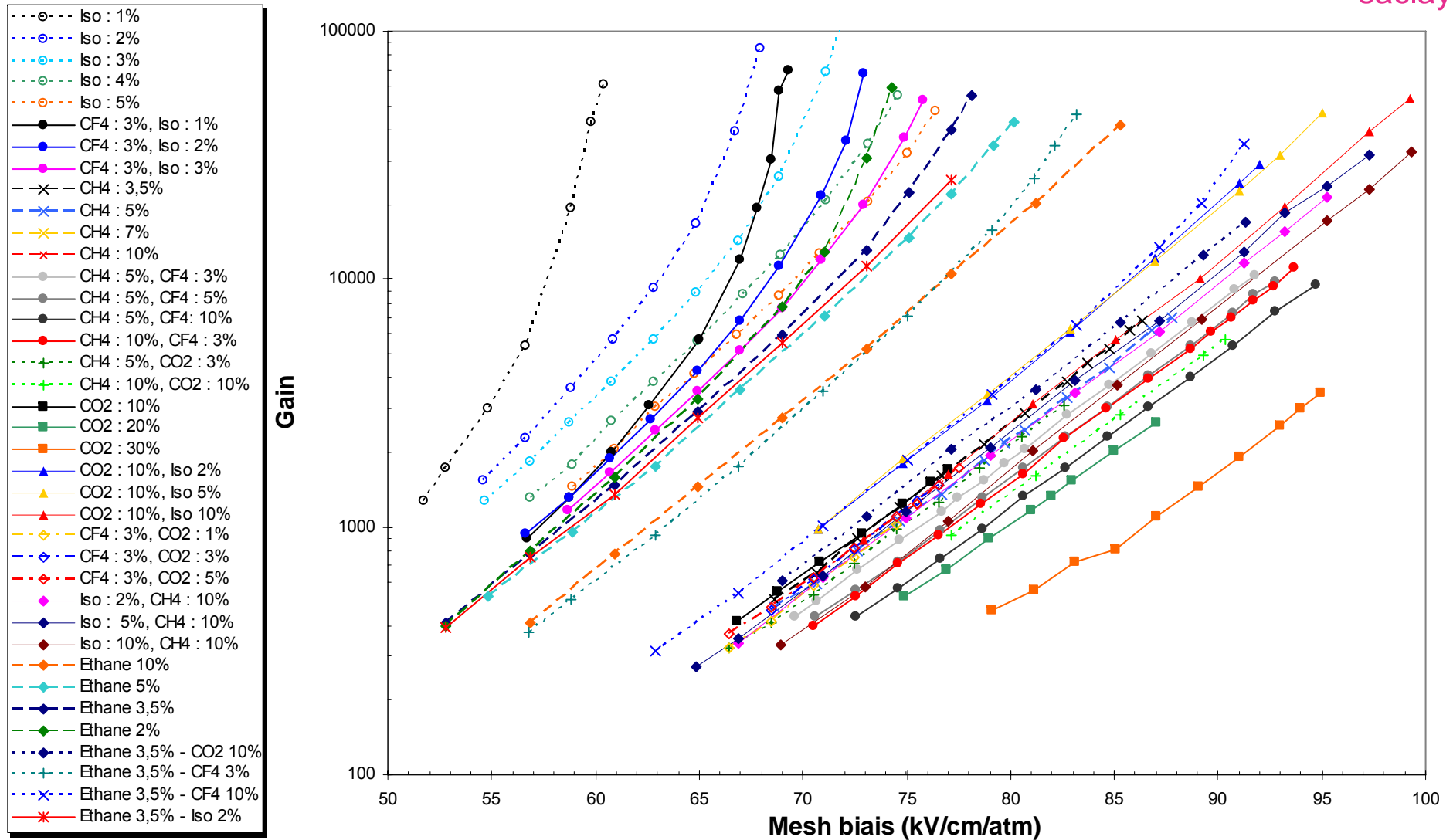

# Gain measurements : results

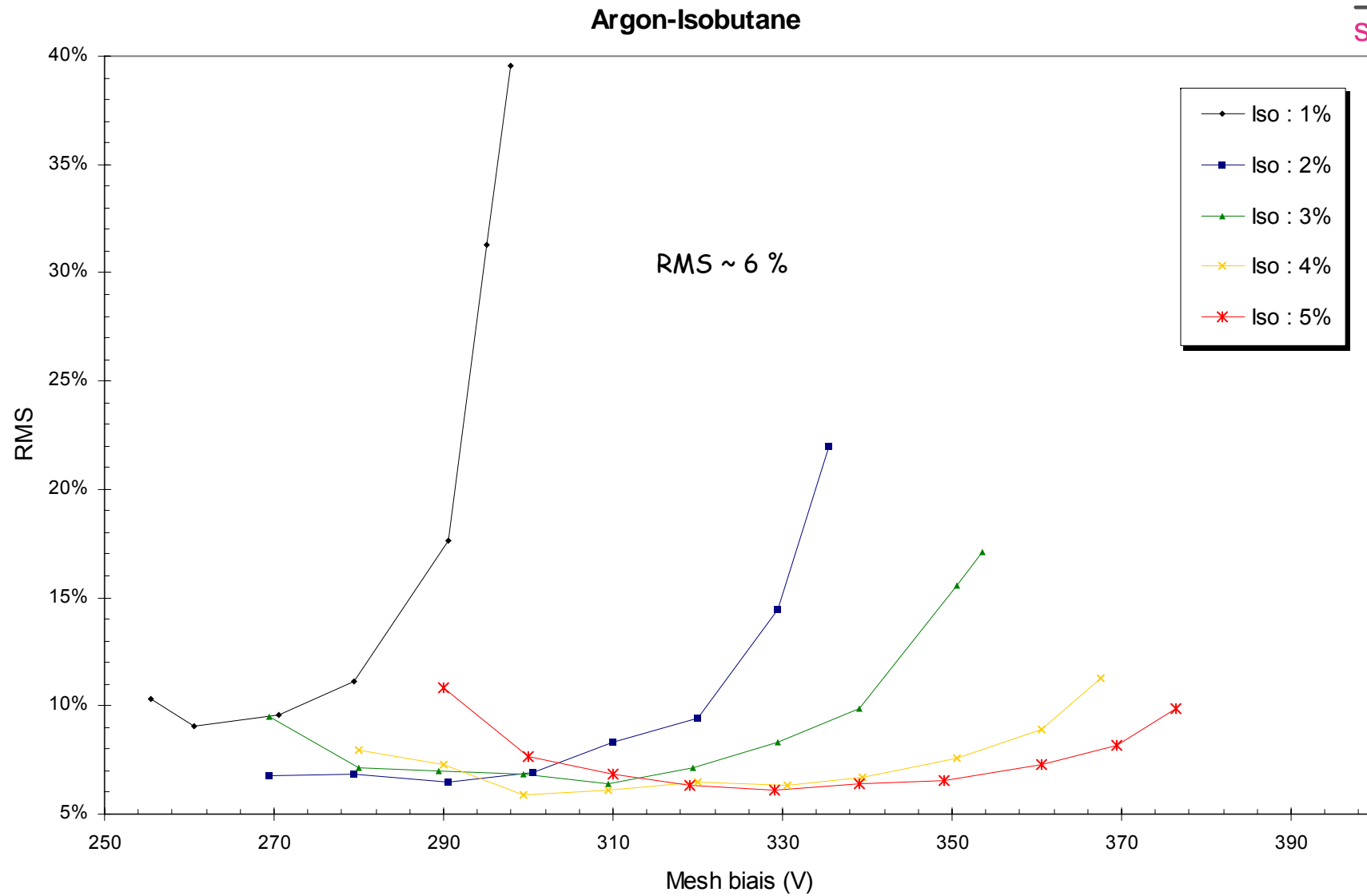

# Gain measurements : comparison with simulations

Comparison Simulation/Measurement: Argon-Methane

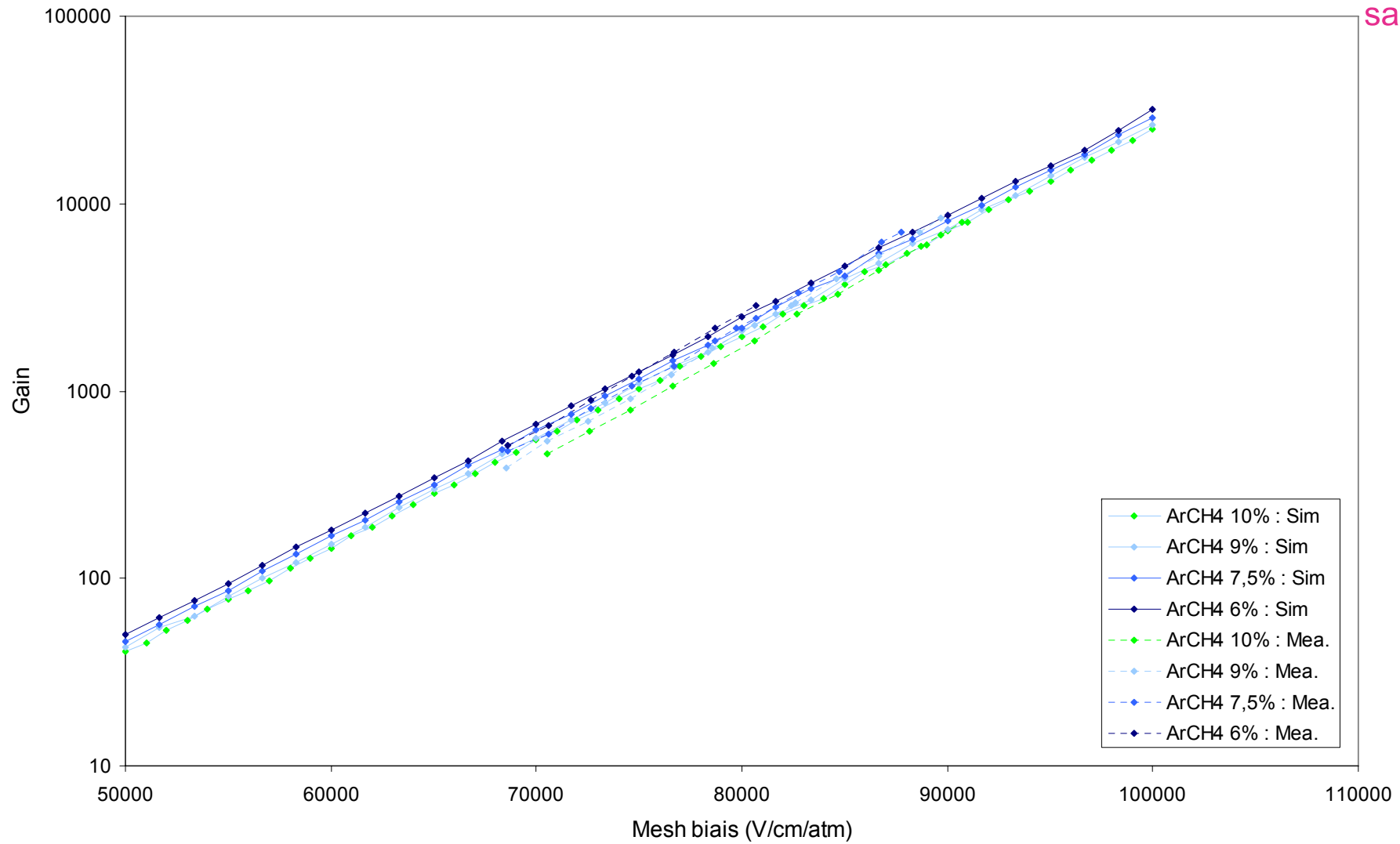

Simulations from GARFIELD/MAGBOLTZ

# Gain measurements : comparison with simulations

Comparison Simulation/Masurement: Argon-Ethane

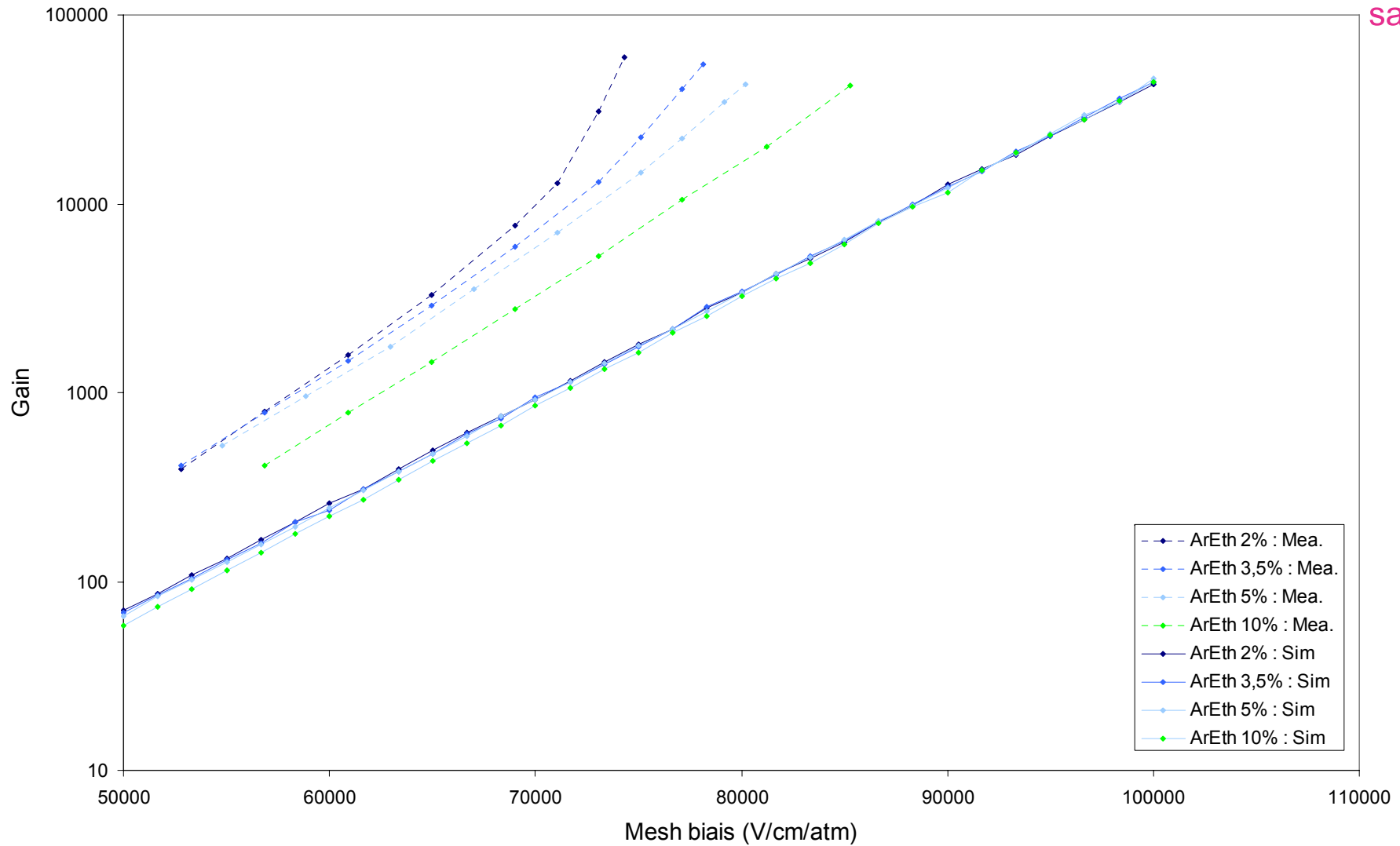

Simulations from GARFIELD/MAGBOLTZ



# NIKHEF/Twente: InGrid (Integrated Grid)

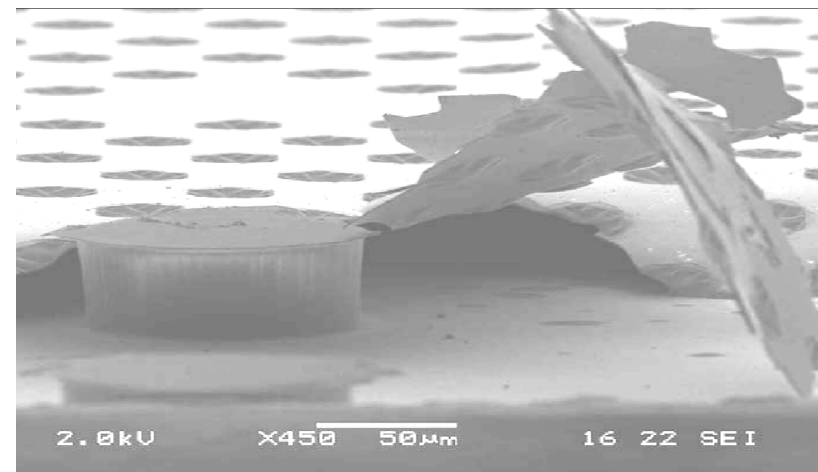
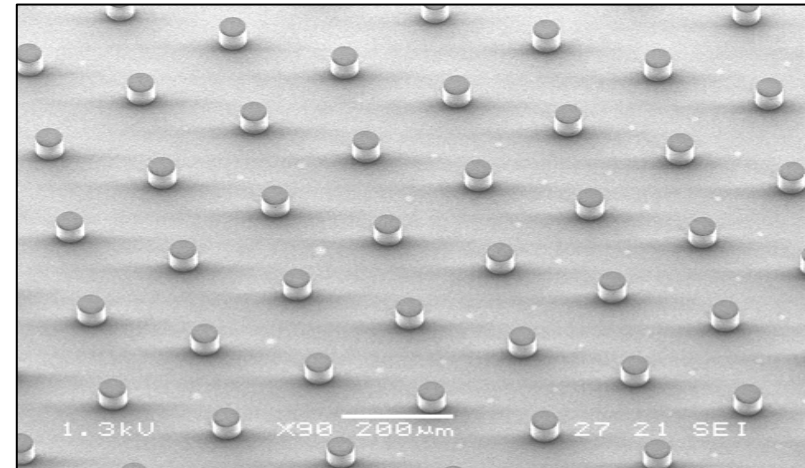
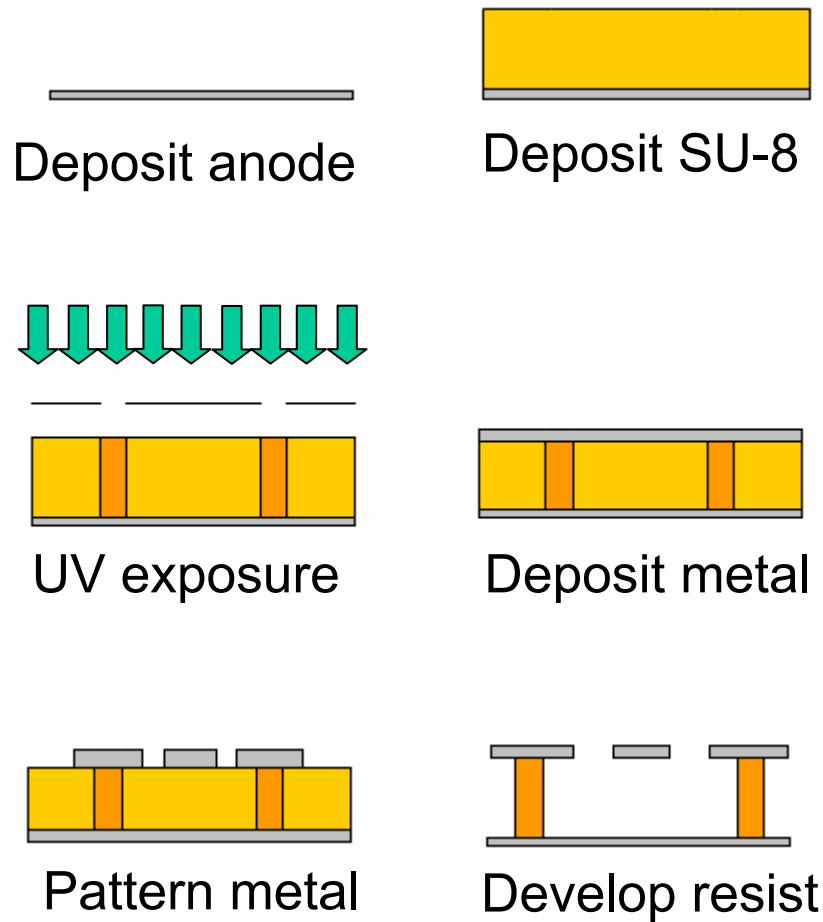

# Any field structure feasible

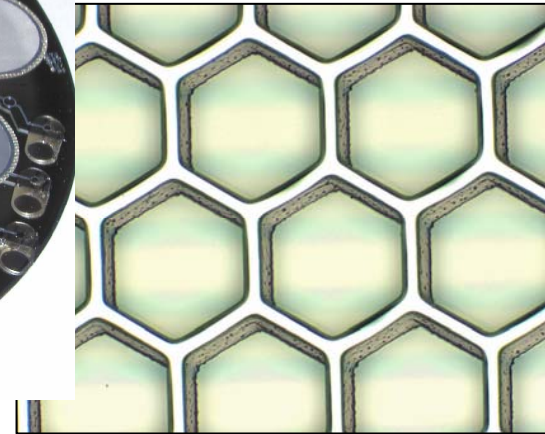
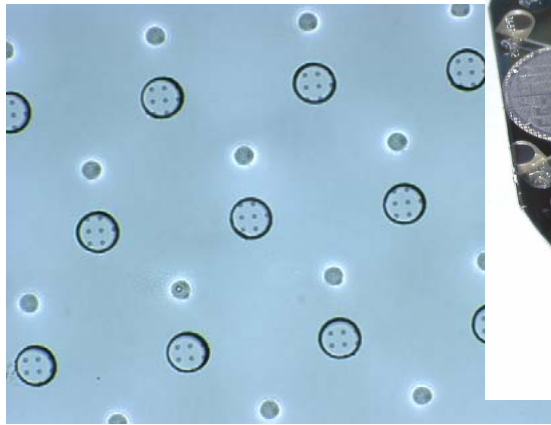
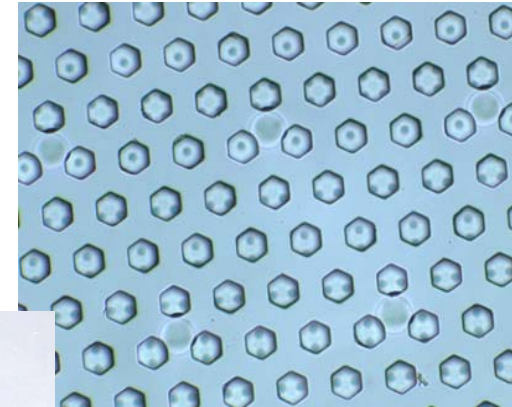
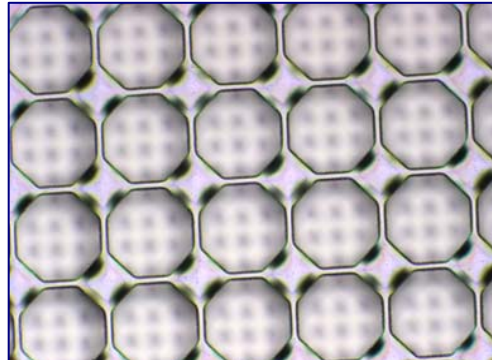
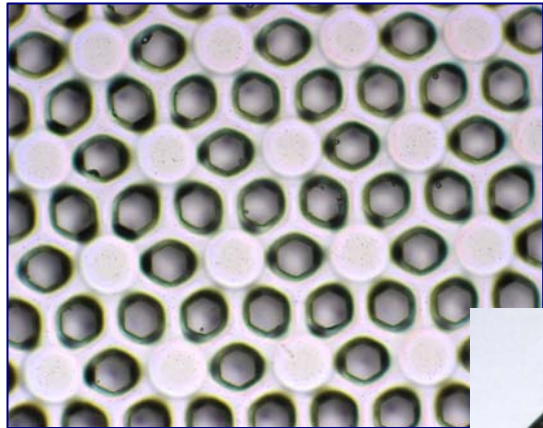

# Gain for different gap sizes

+ many other measurements (homogeneity, gain vs. hole size, energy resolution)

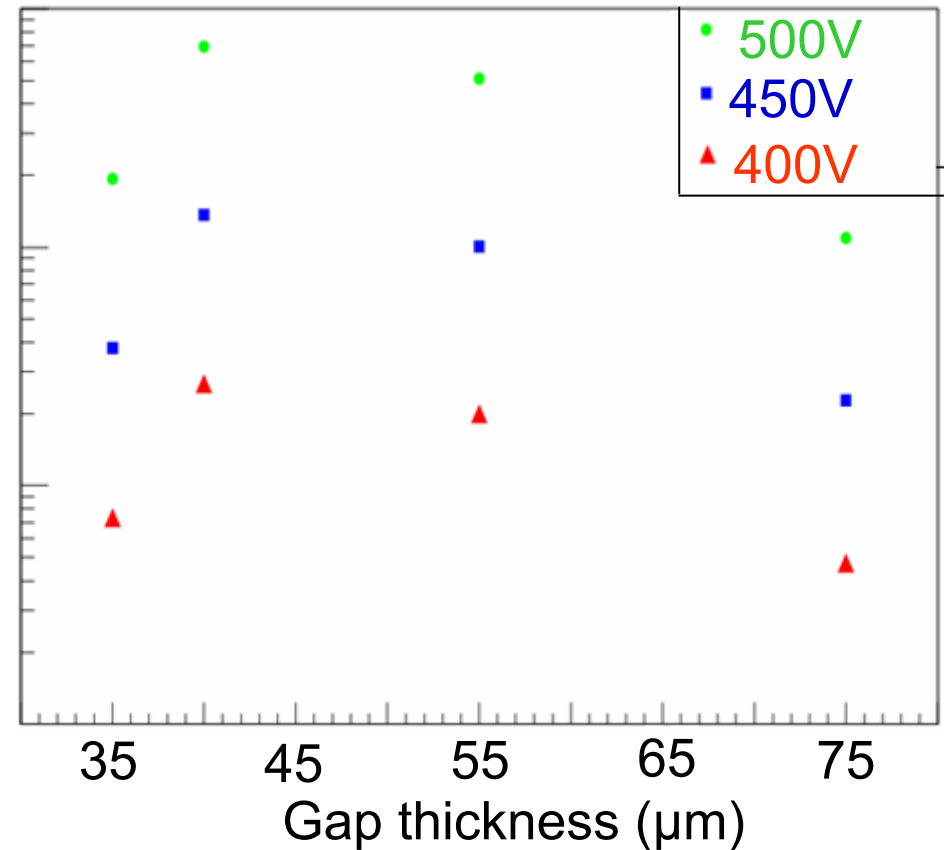
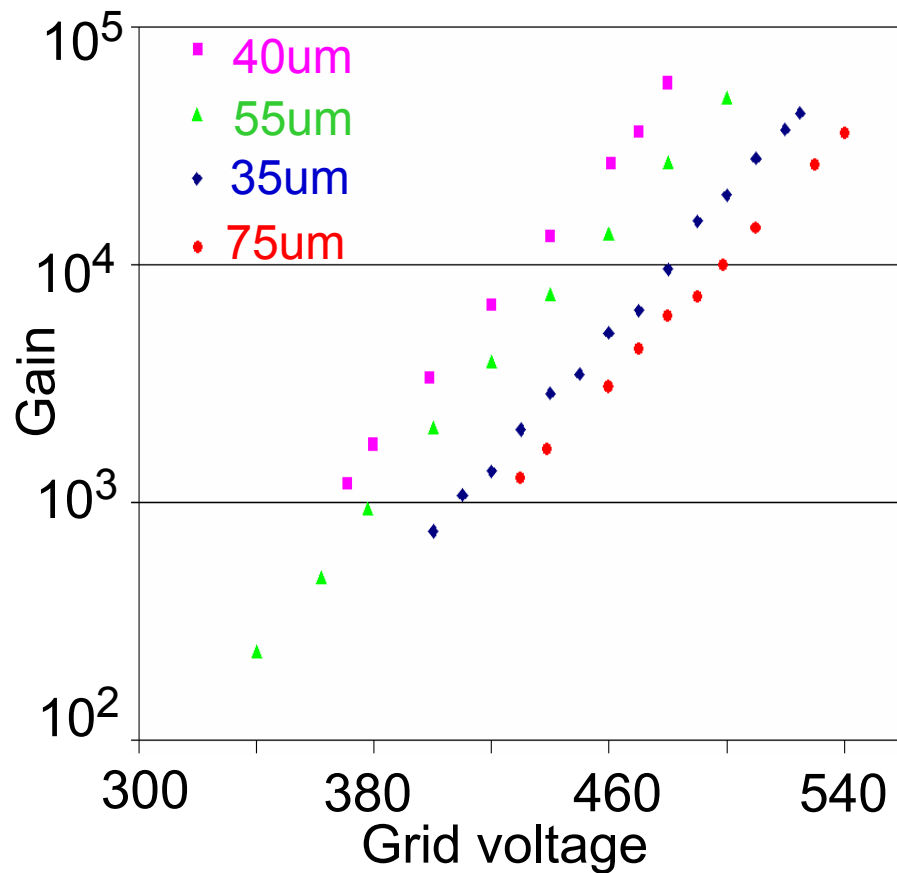

# Sparking

- Chip faces 80kV/cm with no protection (unlike the GEM setup)
- Degradation of the field, or total destruction of grid but also CMOS chip

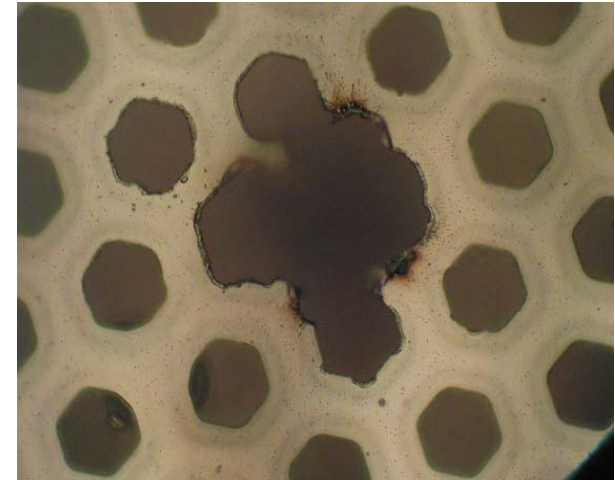
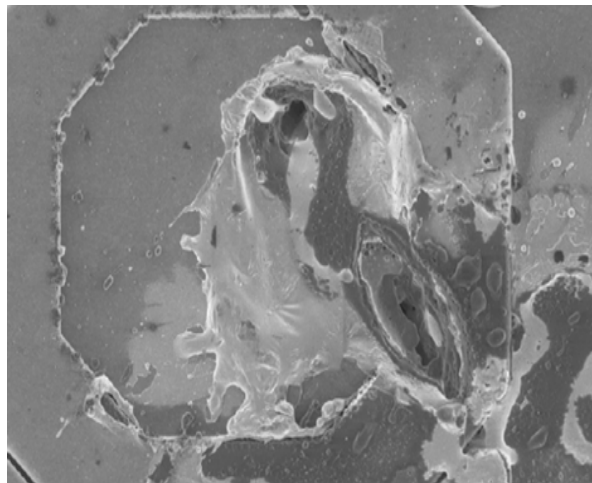
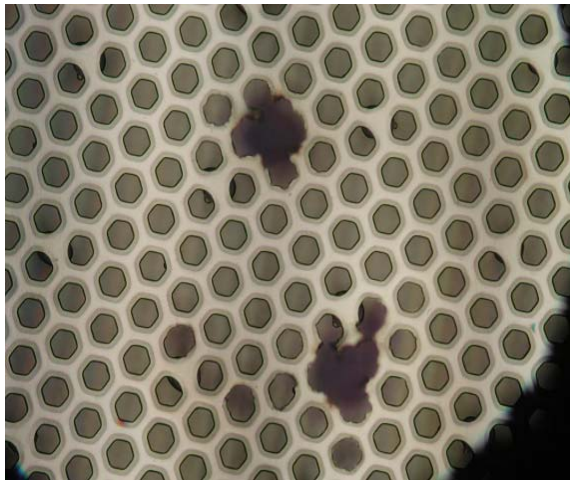

10 $\mu$ m

# Solution:high resistive layer

- Resistive plate chamber principle
- Amorphous silicon deposited
  - 4um thickness, resistivity  $\sim 10^{11}\Omega\cdot\text{cm}$ , temperature  $\sim 250\text{ }^\circ\text{C}$
- 2 fields with Micromegas: one protected, one unprotected
- First signals recorded; they look the same

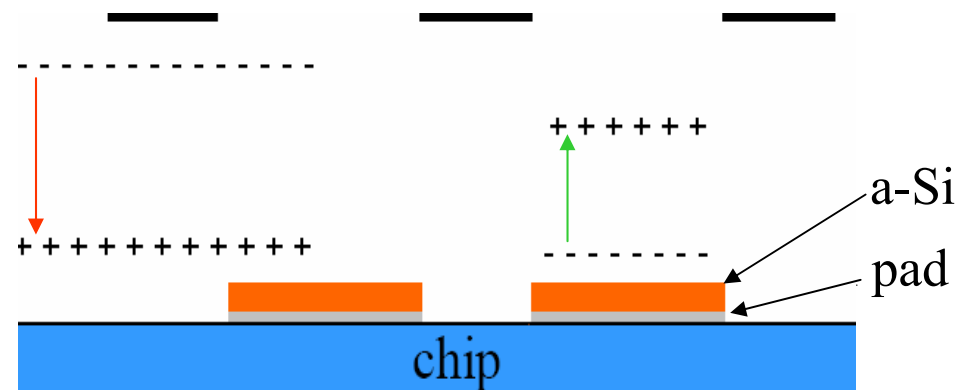
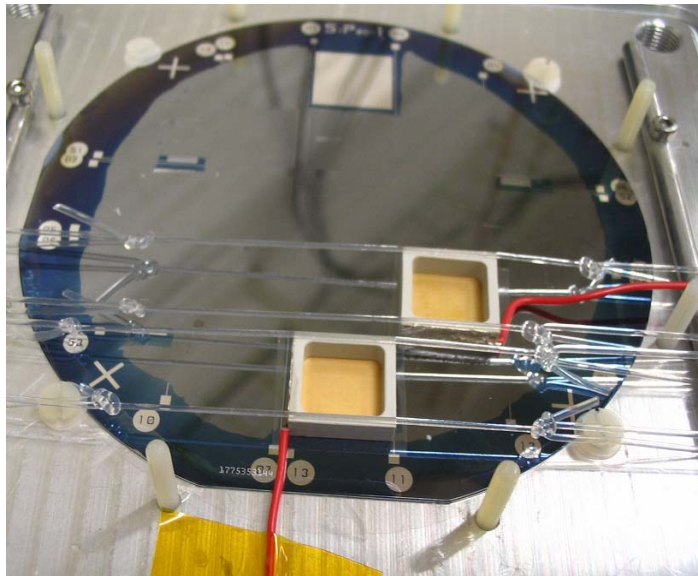

# First Twingrid's

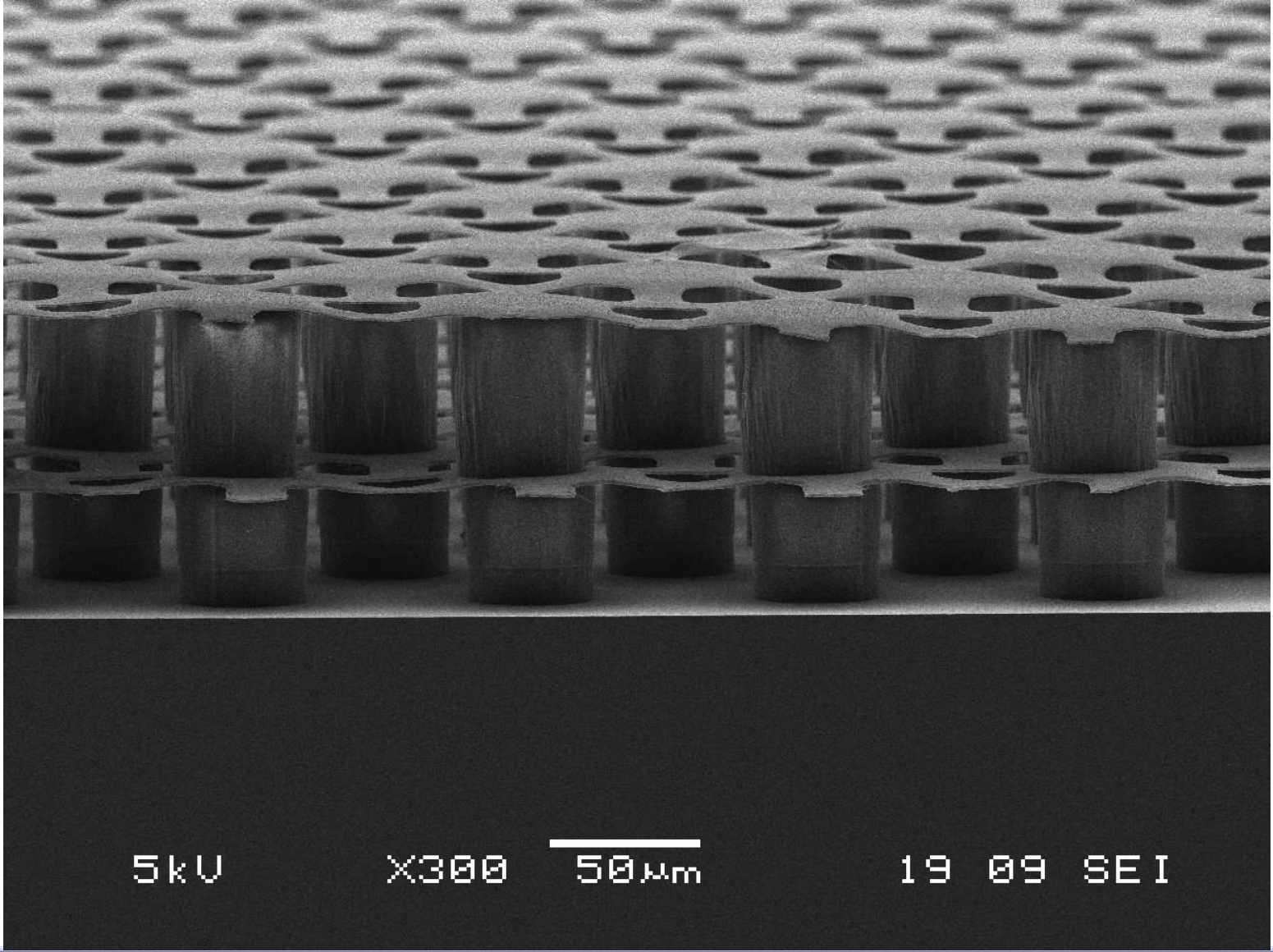

# Further Developments

RELAXD project (Dutch/Belgian)  
NIKHEF, Panalytical, IMEC, Canberra:

- **Chip tiling:** large(r) detector surfaces  
(2x2, 2x4 chips)
- **Through Si connectivity:** avoiding bonding wires
- **Fast readout technology**  
(~5 Gb/s)

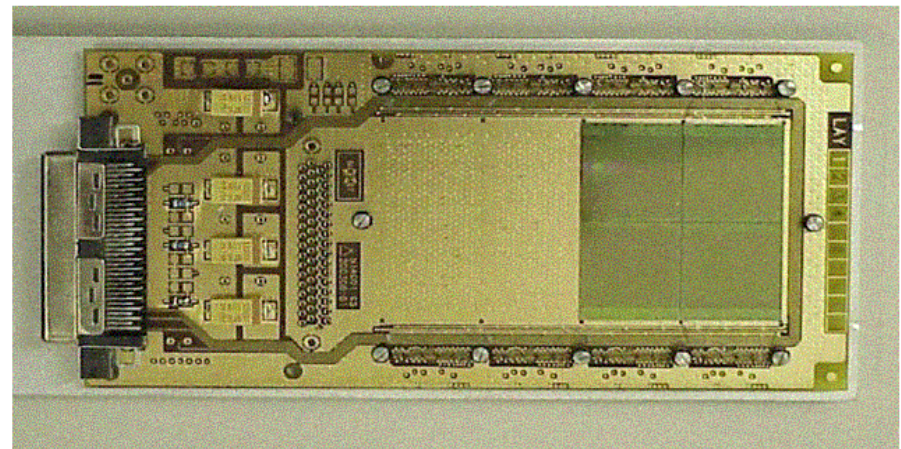

# In summary: timetable

- 1<sup>st</sup> version Timepix operational: 1/2007
- First m.i.p. signals with Timepix: ~4/2007
- Development 2<sup>nd</sup> iteration Timepix during 2007
- Endplate infrastructure: 1/2008
- Full SITPC infrastructure incl. DAQ available: 1/2009



FINANCES:	pers.	mat.	travel	total	
FREIBURG:	20.993	25.725	0.500	47.218	budget spent 2006
	11.885	41.000	3.000	65.885	
CEA Saclay:	48.333	32.300	3.000	83.633	
	34.236	32.300	3.000	69.536	
(comm.	60.000	~7.000		67.000)	
CERN:	60.450	21.000	2.000	83.450	
	(72.785	27.848		100.633	CERN table)
	(68.354	21.519		89.873	„ „ )
NIKHEF:	22.500	40.000	1.000	63.500	
	0.0	38.000	1.000	39.100	
(comm.	86.500	4.000		90.500)	