



The expected physics landscape in 2033-2035

Serguei GANJOUR

CEA-Saclay/IRFU, Gif-sur-Yvette, France

Réunion d'information ILC

*CEA/Saclay
April 9, 2018*

$$m_H \simeq 125 \text{ GeV}, \hat{\mu} \simeq 1$$

Precision measurements and reaching higher energy are the Frontiers of PP

$$\mathcal{B}(B_s \rightarrow \mu^+ \mu^-) = (3.0 \pm 0.7) \times 10^{-9}$$

No evidence of NP in range 200-3000 GeV depending on its type

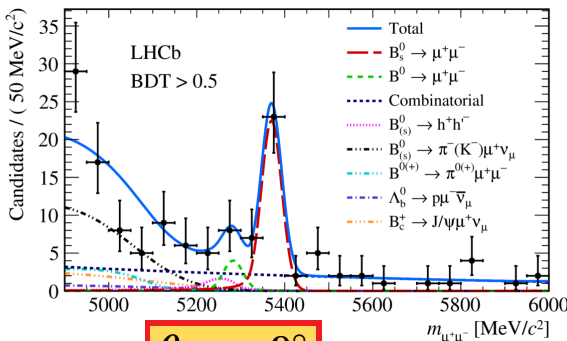
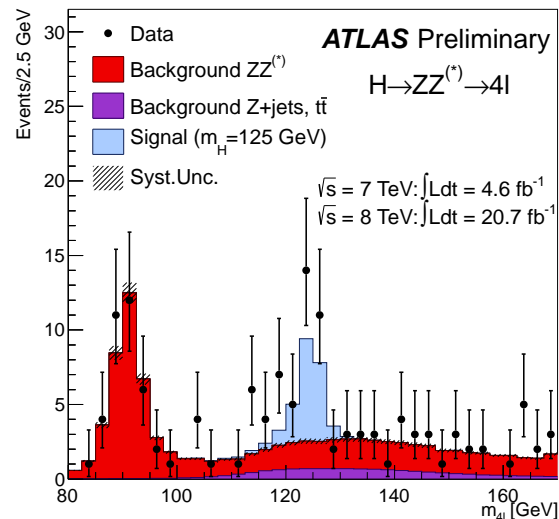
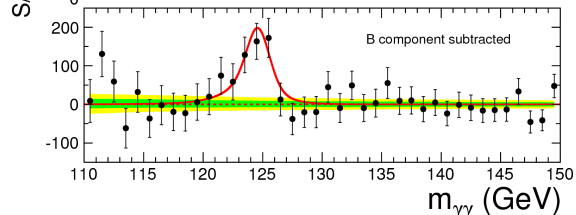
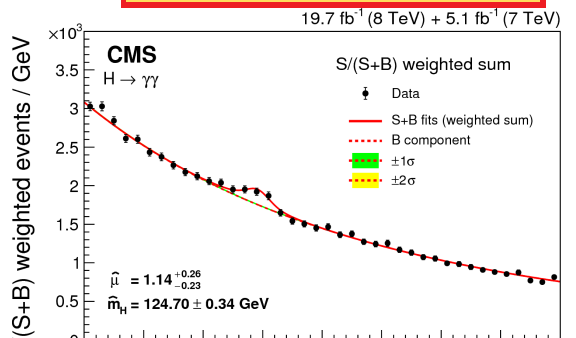

$$\theta_{13} \sim 9^\circ$$

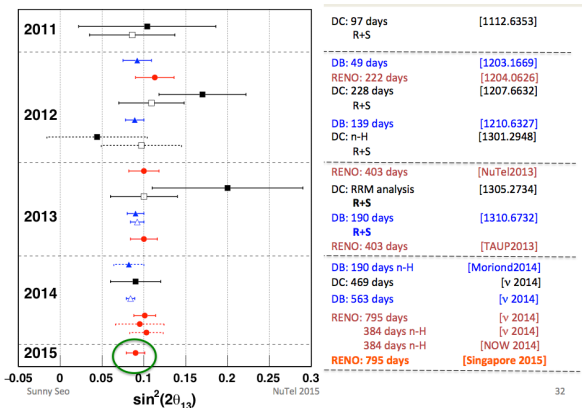

Model	Mass limit	Reference
ADD (M=1, n=1)	1.5 TeV	[1104.0401]
ADD (M=2, n=1)	1.5 TeV	[1104.0401]
ADD (M=3, n=1)	1.5 TeV	[1104.0401]
ADD (M=4, n=1)	1.5 TeV	[1104.0401]
ADD (M=5, n=1)	1.5 TeV	[1104.0401]
ADD (M=6, n=1)	1.5 TeV	[1104.0401]
ADD (M=7, n=1)	1.5 TeV	[1104.0401]
ADD (M=8, n=1)	1.5 TeV	[1104.0401]
ADD (M=9, n=1)	1.5 TeV	[1104.0401]
ADD (M=10, n=1)	1.5 TeV	[1104.0401]
ADD (M=11, n=1)	1.5 TeV	[1104.0401]
ADD (M=12, n=1)	1.5 TeV	[1104.0401]
ADD (M=13, n=1)	1.5 TeV	[1104.0401]
ADD (M=14, n=1)	1.5 TeV	[1104.0401]
ADD (M=15, n=1)	1.5 TeV	[1104.0401]
ADD (M=16, n=1)	1.5 TeV	[1104.0401]
ADD (M=17, n=1)	1.5 TeV	[1104.0401]
ADD (M=18, n=1)	1.5 TeV	[1104.0401]
ADD (M=19, n=1)	1.5 TeV	[1104.0401]
ADD (M=20, n=1)	1.5 TeV	[1104.0401]
ADD (M=21, n=1)	1.5 TeV	[1104.0401]
ADD (M=22, n=1)	1.5 TeV	[1104.0401]
ADD (M=23, n=1)	1.5 TeV	[1104.0401]
ADD (M=24, n=1)	1.5 TeV	[1104.0401]
ADD (M=25, n=1)	1.5 TeV	[1104.0401]
ADD (M=26, n=1)	1.5 TeV	[1104.0401]
ADD (M=27, n=1)	1.5 TeV	[1104.0401]
ADD (M=28, n=1)	1.5 TeV	[1104.0401]
ADD (M=29, n=1)	1.5 TeV	[1104.0401]
ADD (M=30, n=1)	1.5 TeV	[1104.0401]
ADD (M=31, n=1)	1.5 TeV	[1104.0401]
ADD (M=32, n=1)	1.5 TeV	[1104.0401]
ADD (M=33, n=1)	1.5 TeV	[1104.0401]
ADD (M=34, n=1)	1.5 TeV	[1104.0401]
ADD (M=35, n=1)	1.5 TeV	[1104.0401]
ADD (M=36, n=1)	1.5 TeV	[1104.0401]
ADD (M=37, n=1)	1.5 TeV	[1104.0401]
ADD (M=38, n=1)	1.5 TeV	[1104.0401]
ADD (M=39, n=1)	1.5 TeV	[1104.0401]
ADD (M=40, n=1)	1.5 TeV	[1104.0401]
ADD (M=41, n=1)	1.5 TeV	[1104.0401]
ADD (M=42, n=1)	1.5 TeV	[1104.0401]
ADD (M=43, n=1)	1.5 TeV	[1104.0401]
ADD (M=44, n=1)	1.5 TeV	[1104.0401]
ADD (M=45, n=1)	1.5 TeV	[1104.0401]
ADD (M=46, n=1)	1.5 TeV	[1104.0401]
ADD (M=47, n=1)	1.5 TeV	[1104.0401]
ADD (M=48, n=1)	1.5 TeV	[1104.0401]
ADD (M=49, n=1)	1.5 TeV	[1104.0401]
ADD (M=50, n=1)	1.5 TeV	[1104.0401]
ADD (M=51, n=1)	1.5 TeV	[1104.0401]
ADD (M=52, n=1)	1.5 TeV	[1104.0401]
ADD (M=53, n=1)	1.5 TeV	[1104.0401]
ADD (M=54, n=1)	1.5 TeV	[1104.0401]
ADD (M=55, n=1)	1.5 TeV	[1104.0401]
ADD (M=56, n=1)	1.5 TeV	[1104.0401]
ADD (M=57, n=1)	1.5 TeV	[1104.0401]
ADD (M=58, n=1)	1.5 TeV	[1104.0401]
ADD (M=59, n=1)	1.5 TeV	[1104.0401]
ADD (M=60, n=1)	1.5 TeV	[1104.0401]
ADD (M=61, n=1)	1.5 TeV	[1104.0401]
ADD (M=62, n=1)	1.5 TeV	[1104.0401]
ADD (M=63, n=1)	1.5 TeV	[1104.0401]
ADD (M=64, n=1)	1.5 TeV	[1104.0401]
ADD (M=65, n=1)	1.5 TeV	[1104.0401]
ADD (M=66, n=1)	1.5 TeV	[1104.0401]
ADD (M=67, n=1)	1.5 TeV	[1104.0401]
ADD (M=68, n=1)	1.5 TeV	[1104.0401]
ADD (M=69, n=1)	1.5 TeV	[1104.0401]
ADD (M=70, n=1)	1.5 TeV	[1104.0401]
ADD (M=71, n=1)	1.5 TeV	[1104.0401]
ADD (M=72, n=1)	1.5 TeV	[1104.0401]
ADD (M=73, n=1)	1.5 TeV	[1104.0401]
ADD (M=74, n=1)	1.5 TeV	[1104.0401]
ADD (M=75, n=1)	1.5 TeV	[1104.0401]
ADD (M=76, n=1)	1.5 TeV	[1104.0401]
ADD (M=77, n=1)	1.5 TeV	[1104.0401]
ADD (M=78, n=1)	1.5 TeV	[1104.0401]
ADD (M=79, n=1)	1.5 TeV	[1104.0401]
ADD (M=80, n=1)	1.5 TeV	[1104.0401]
ADD (M=81, n=1)	1.5 TeV	[1104.0401]
ADD (M=82, n=1)	1.5 TeV	[1104.0401]
ADD (M=83, n=1)	1.5 TeV	[1104.0401]
ADD (M=84, n=1)	1.5 TeV	[1104.0401]
ADD (M=85, n=1)	1.5 TeV	[1104.0401]
ADD (M=86, n=1)	1.5 TeV	[1104.0401]
ADD (M=87, n=1)	1.5 TeV	[1104.0401]
ADD (M=88, n=1)	1.5 TeV	[1104.0401]
ADD (M=89, n=1)	1.5 TeV	[1104.0401]
ADD (M=90, n=1)	1.5 TeV	[1104.0401]
ADD (M=91, n=1)	1.5 TeV	[1104.0401]
ADD (M=92, n=1)	1.5 TeV	[1104.0401]
ADD (M=93, n=1)	1.5 TeV	[1104.0401]
ADD (M=94, n=1)	1.5 TeV	[1104.0401]
ADD (M=95, n=1)	1.5 TeV	[1104.0401]
ADD (M=96, n=1)	1.5 TeV	[1104.0401]
ADD (M=97, n=1)	1.5 TeV	[1104.0401]
ADD (M=98, n=1)	1.5 TeV	[1104.0401]
ADD (M=99, n=1)	1.5 TeV	[1104.0401]
ADD (M=100, n=1)	1.5 TeV	[1104.0401]

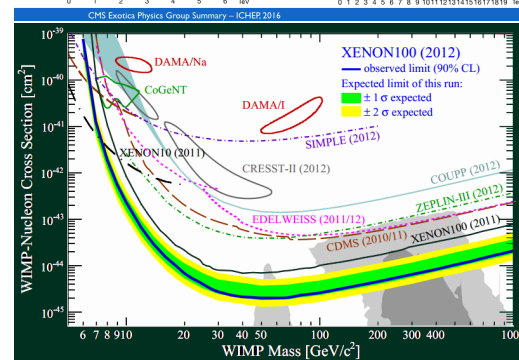
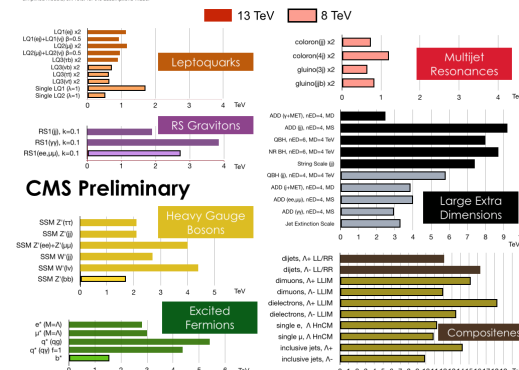

Data strongly favor the scalar 0^+ hypothesis

With the discovery of a Higgs boson the SM is now complete!

- ☞ Major questions of PP justified by experimental observations remain unresolved
 - ☞ DM points to new type particle
 - ☞ BAU requires \mathcal{B}, \mathcal{L} processes
 - ☞ Neutrino mass suggests sterile or Majorana neutrino

☞ Need new large scale accelerators

- ☞ Indirect searches through precision measurements (rare processes)
 - many BSM models predict $\Delta g_{\text{HXX}}/g_{\text{HXX}} \leq 1 - 10\%$
 - Is Higgs potential $\lambda(\mu)$ as expected? (check consistency)
- ☞ Direct Searches of NP
 - exploration of higher E-frontiers

The SM begins to unravel when probed much beyond the range of current accelerators

(unstable vacuum at the Plank scale!)

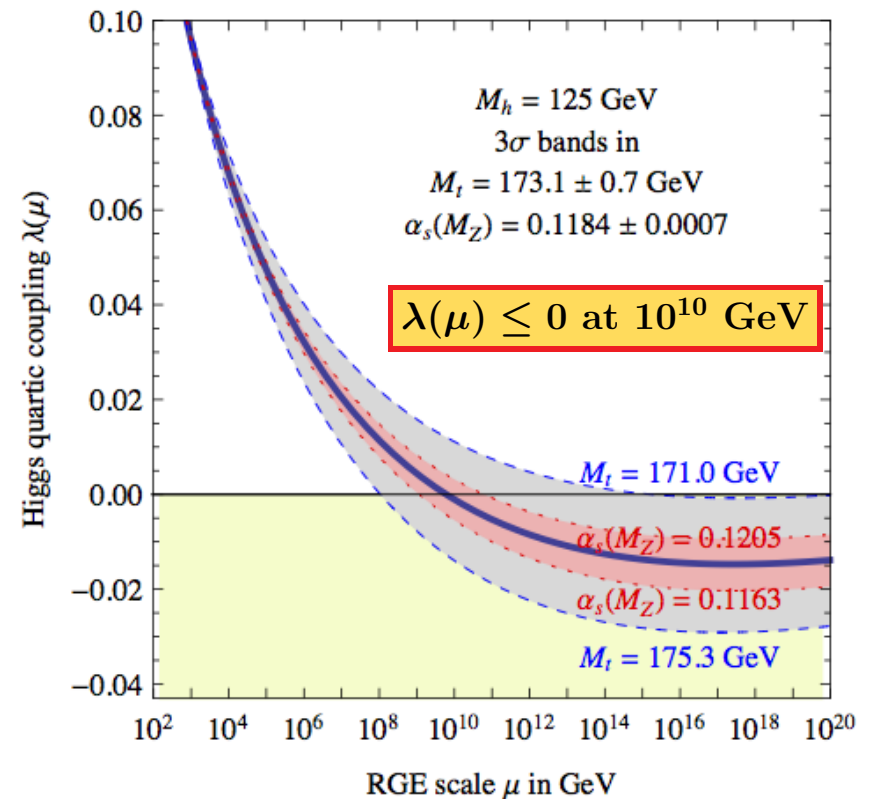

Everything proves that NP must exist, but... **At What Energy Scales?**

Interaction strength varies with E-scale and depends on quantum numbers and particle species

☞ E-scale of inflation (10^{16} GeV ?)

☞ associated with grand unification scale of fundamental interactions

☞ is it comparable with those when **3 non-gravitational forces** become about the same strength?

☞ Additional particles such as SUSY partners at E-scale of TeVs affect the running of coupling constants

☞ Physics at the highest E-scales:

☞ are forces indeed unified?

☞ how is gravity connected?

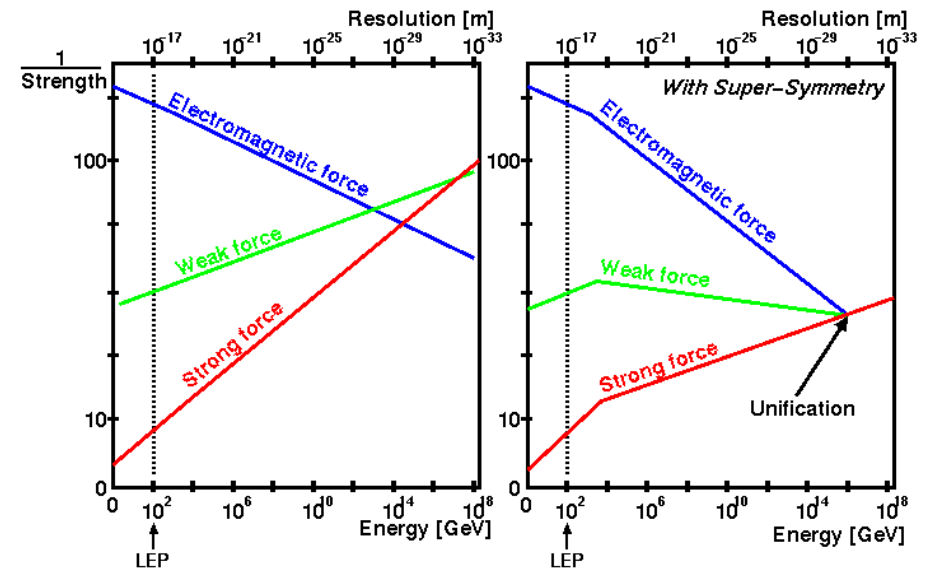
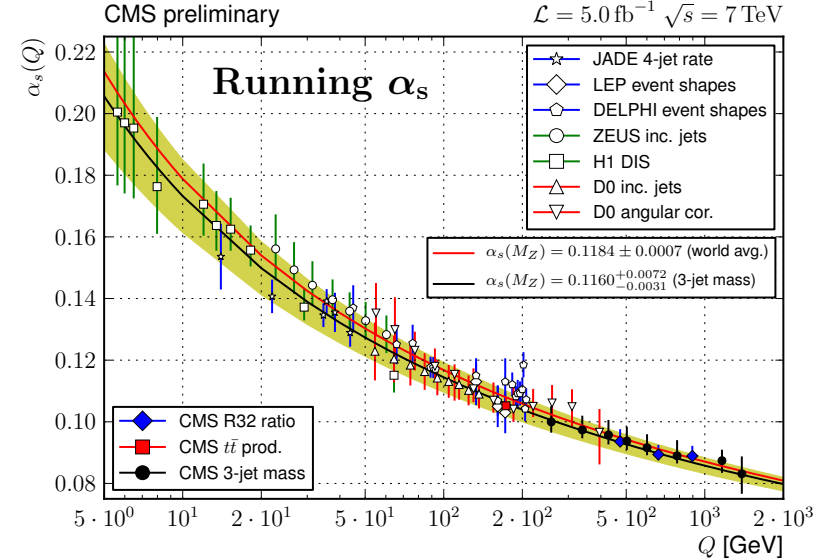

Need to explore new territory by pushing energies!

The exploitation of the full potential of the LHC is the highest priority of the Energy Frontier in both Europe and US

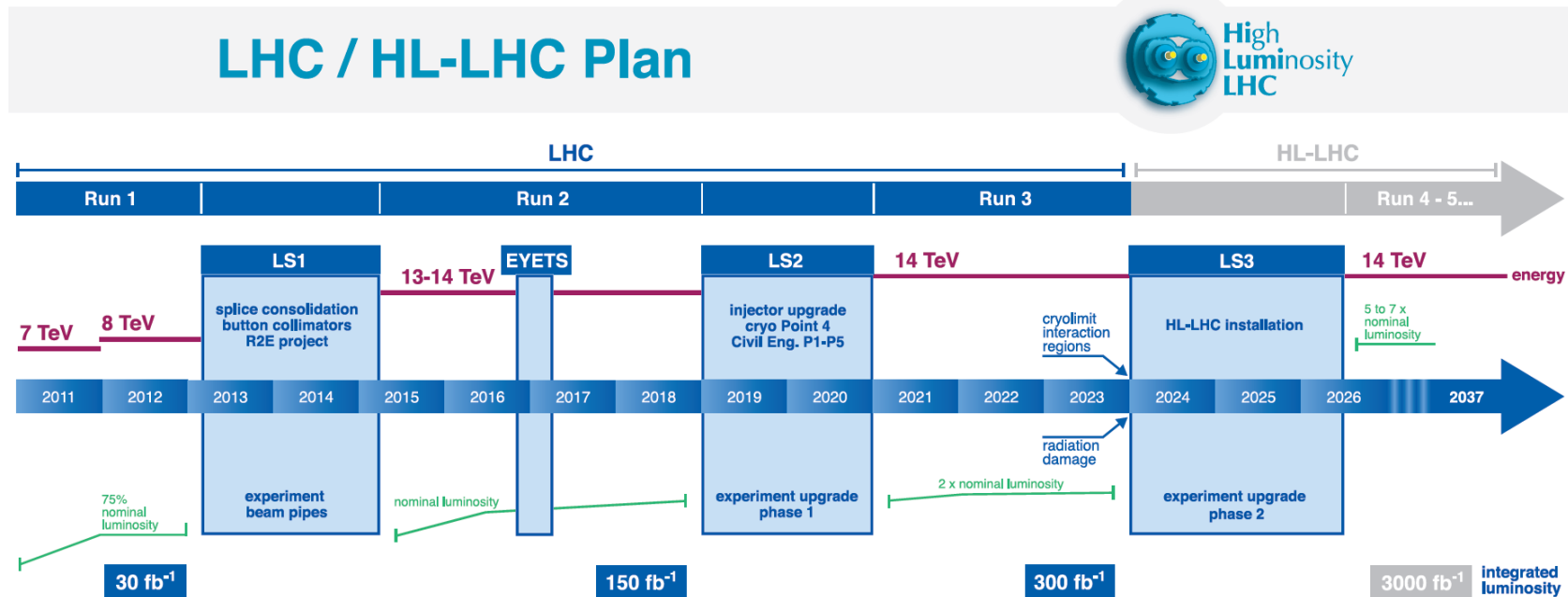

- ☞ LHC approved running to deliver 300 fb⁻¹ by 2023
- ☞ Phase II at $L = 5 \times 10^{34} \text{ cm}^{-2} \text{ s}^{-1}$
3000 fb⁻¹ over 10 years
 - ☞ major upgrades required on the LHC (replace more than 1.2 km)

- ☞ Experiments will undergo a series of detector and trigger upgrades
 - ☞ to cope with radiation damage and high pileup (140 PU events)
 - ☞ to maintain or enhance the current physics performance

HL-LHC is the benchmark Higgs factory

(a couple of Higgs per sec)

☞ Most of the exclusive final states are accessible

☞ 20K $H \rightarrow ZZ \rightarrow 4l$

☞ 30K $H \rightarrow \mu\mu$

☞ 50 $H \rightarrow J/\psi\gamma$

Channel	σ , pb (14 TeV)	Rate, Hz $L=50 \text{ pb}^{-1} \text{ s}^{-1}$ (14TeV)	Events, $L=3\text{ab}^{-1}$ (14TeV)	Events, $L=30 \text{ fb}^{-1}$ (8TeV)
ggH	50.4	2.52	150M	600K
VBF	4.2	0.21	13M	48K
WH	1.5	0.08	4.5M	21K
ZH	0.9	0.04	2.6M	12K
ttH	0.6	0.03	1.8M	4K

HL-LHC enable to probe most of the couplings including direct ttH observation

Systematics:

Scenario 1
unchanged
Scenario 2
scaled $1/\sqrt{L}$

CMS Projection

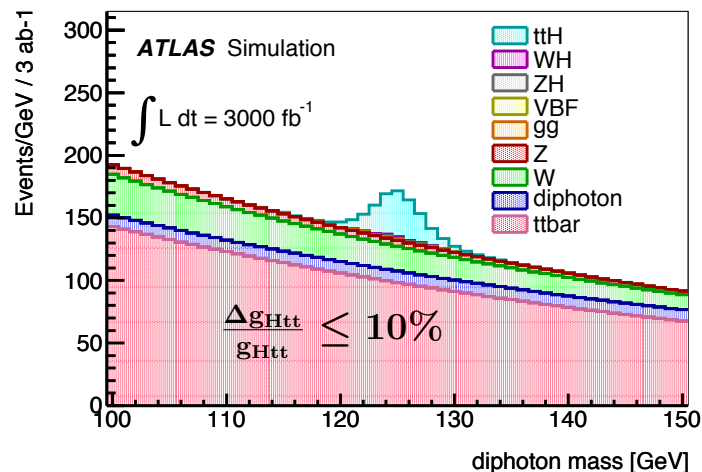
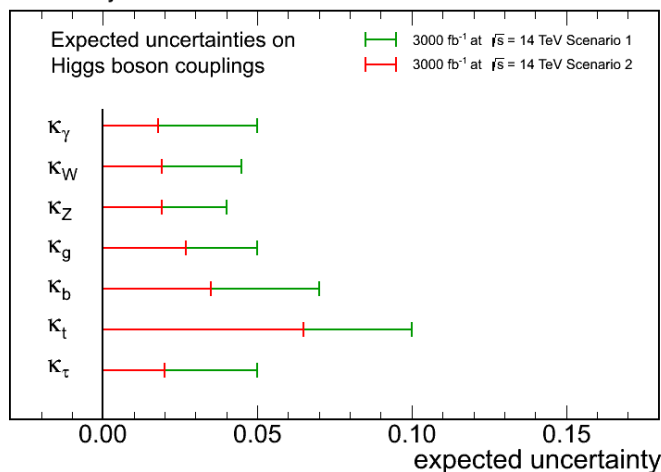

Theoretical uncertainties affects the ultimate precision achievable by LHC experiments (2-5%). Reducing them it is for sure worth the effort!

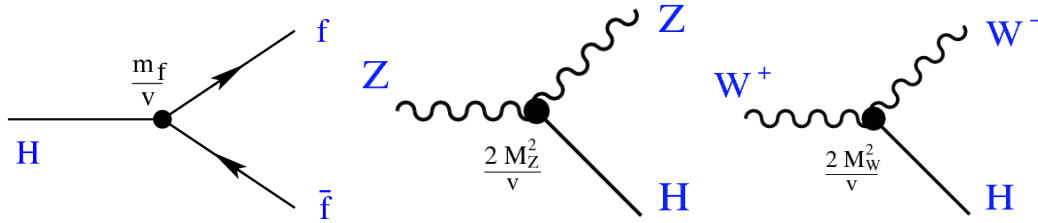

LHC potential to probe 3 generations

- ▮ a few % precision for 3rd generation
 - Higgs decays to fermions ($\tau\tau$, bb)
- ▮ access to 2nd generation fermions
 - possibly test lepton universality:

$$\sigma_{H \rightarrow \tau\tau} / \sigma_{H \rightarrow \mu\mu} = (m_\tau / m_\mu)^2$$
- ▮ 1st generation is out of LHC reach
 - 1 $H \rightarrow ee$ event is expected

Many models can be probed via the 1st and 2nd generations

- ▮ push energies and luminosity
- ▮ production through leptons requires high beam quality $\Delta E/E \leq 10^{-4}$

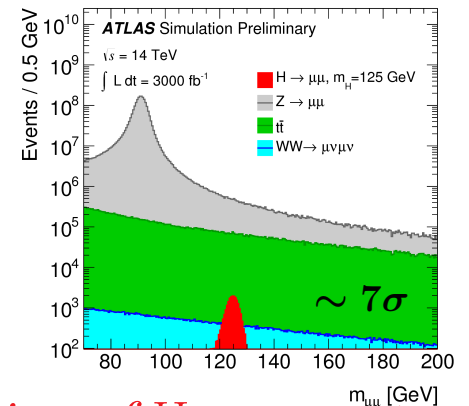
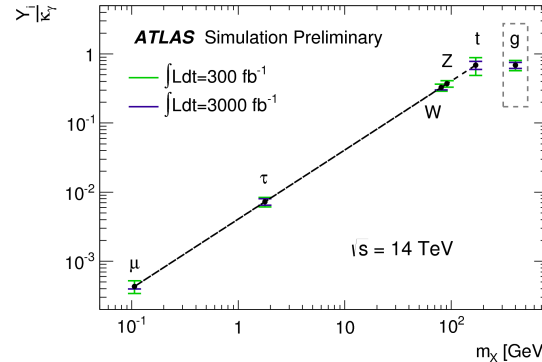
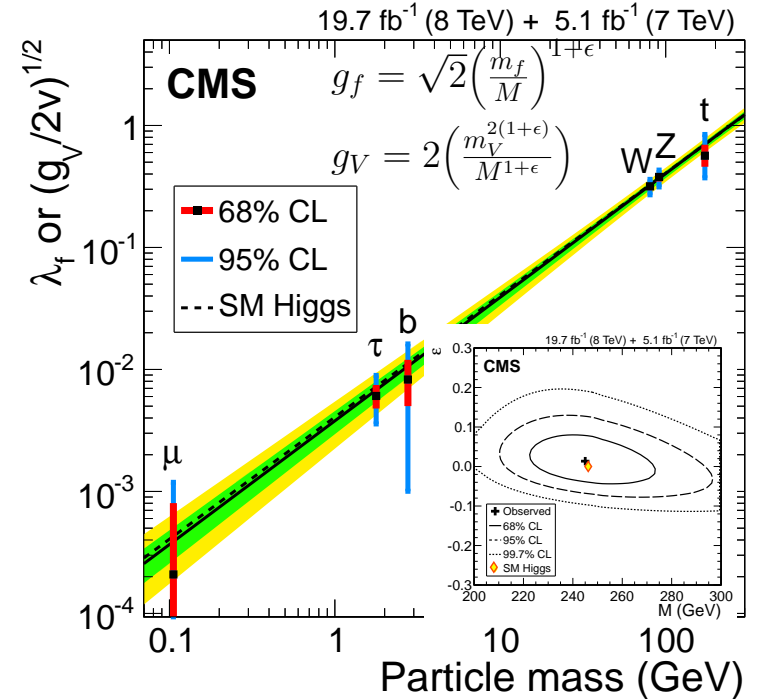

Even observation of $H \rightarrow \mu\mu$ at LHC is tough!

Several models predict SM-like Higgs but different physics at high energy

Direct access to EW theory in the unbroken regime ($\sqrt{s} \gg v = 246 \text{ GeV}$) is a crucial closure test of the SM

- does H(125) regularize the theory
- or is there any new dynamics: anomalous quartic couplings or resonances

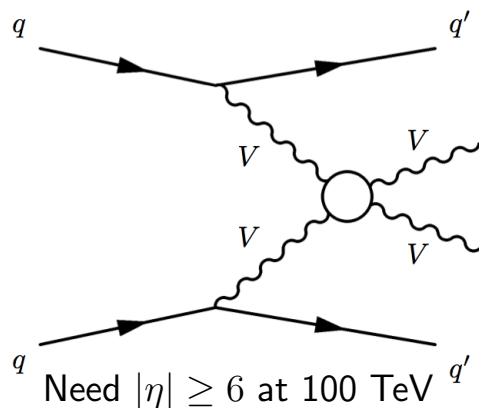

10% precision on the SM VBS cross-section (discovery if NP observed at 1 TeV) can be reached with HL-LHC

$V_L V_L \rightarrow V_L V_L$ violates unitarity at TeV scale without Higgs exchange diagram

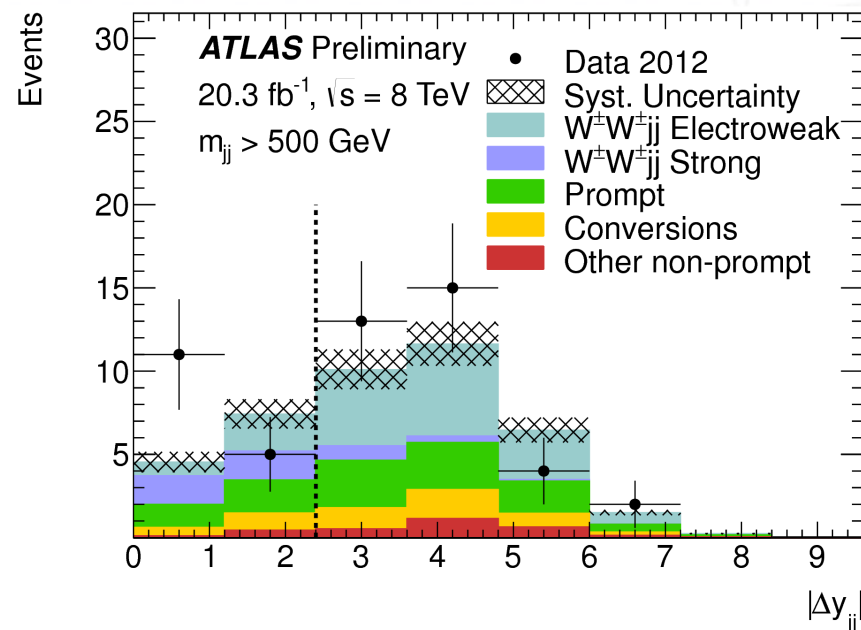
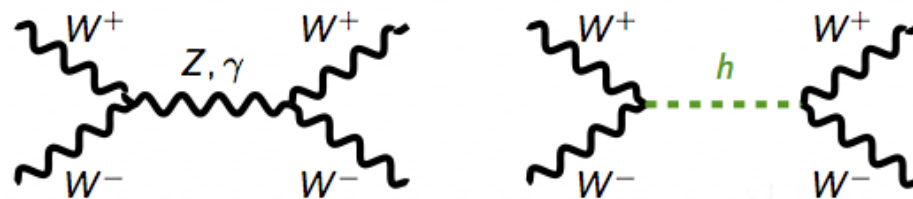

Evidence 3.6 σ for EW VBS having 2 same-sign leptons and 2 high mass forward jets

NP at TeV-scale are put under the pressure by the LHC limits

- ☞ LHC at 13 TeV explored a very vast range of signatures including $B_s \rightarrow \mu^+ \mu^-$
 - ▮ improved sensitivity on mass scale about x2 with respect to 8 TeV searches
 - ▮ modest improvement in limit from 1.2 TeV to 1.4 TeV with 10x luminosity at 14 TeV so far
- ☞ If NP exists at the TeV scale and is discovered at LHC
 - ▮ its mass spectrum is quite heavy
 - ▮ full spectrum is likely out of LHC reach

Whatever is found or not, pushing energy frontier is inevitable

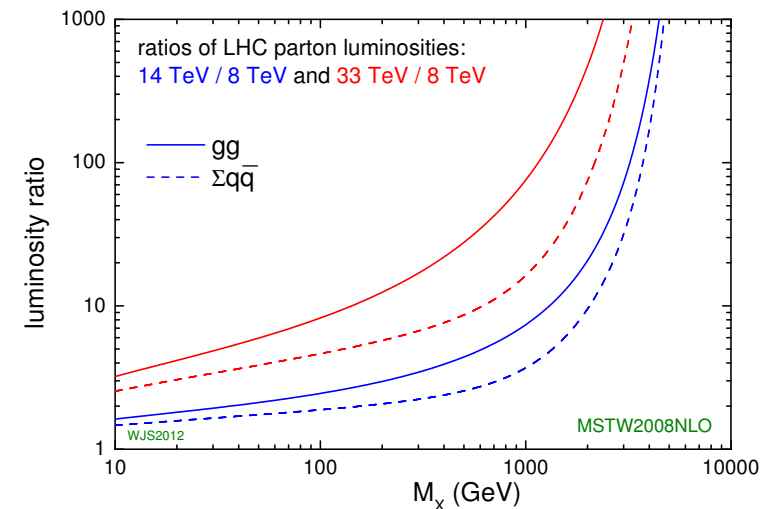
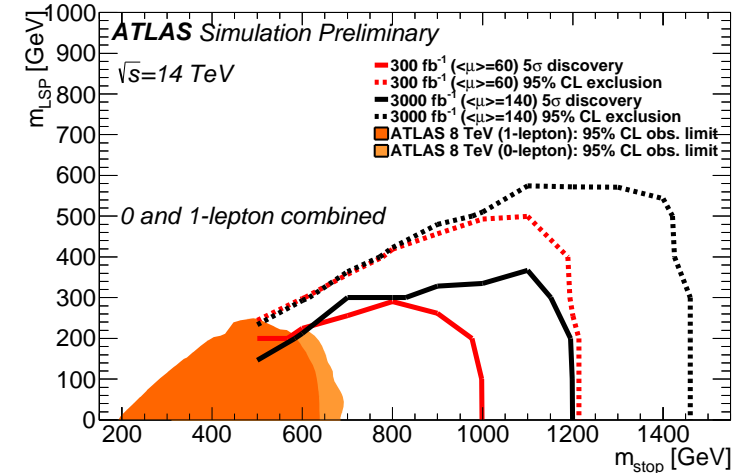

*Parton Luminosities:
 rise due to steep fall-off of the lower energy PDF at large x*

Possible High Energy Frontier Machines

☞ Next generation linear collider in Japan

☞ **International Linear Collider-ILC:**
 e^+e^- collisions at 250 GeV (staging)
 possible upgrade x2 lumi

☞ Post-LHC accelerator projects at CERN

☞ **Compact Linear Collider-CLIC:**
 e^+e^- collisions up to 3 TeV

☞ **Future Circular Collider-FCC:**
 FCC- e^+e^- (350 GeV), FCC-hh (100 TeV), possibly ep

☞ Circular Collider project in China

☞ **Circular Electron Positron Collider-CEPC:**
 CEPC e^+e^- (240 GeV), SppC pp collider (100 TeV)

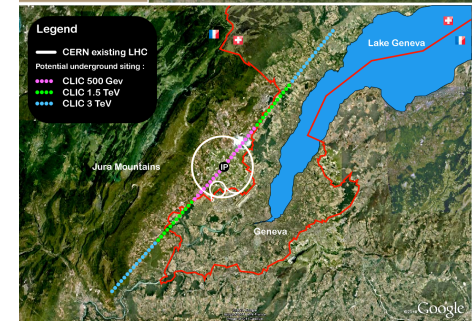
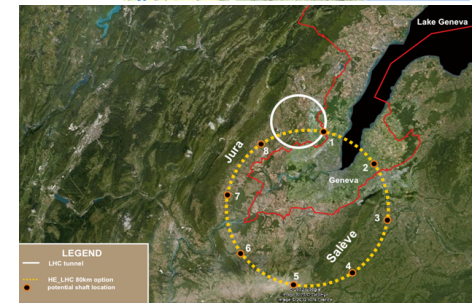
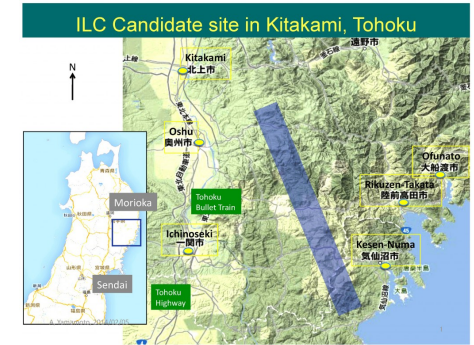

Maximum exploitation of CERN accelerator complex is Europe's top priority: injectors, LEP/LHC tunnel, infrastructure, etc

- ☞ Two possible cases toward higher energy
 - ☞ use existing LEP/LHC 27 km tunnel to reach 33 TeV collisions **HE-LHC**
 - ☞ build (or reuse) new 100 km tunnel to reach 100 TeV collisions **FCC-hh**

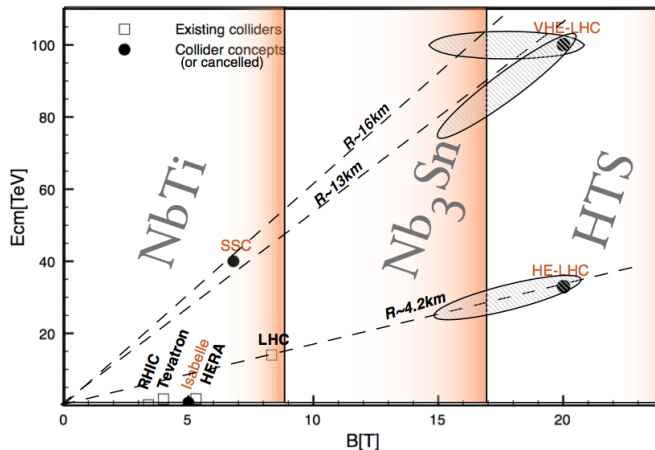
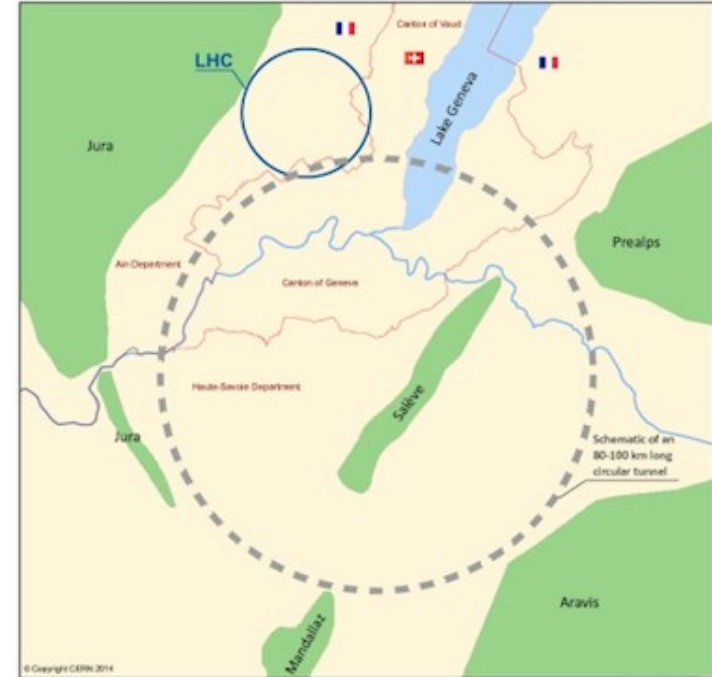

	Ring, km	Field, T	\sqrt{s} , TeV	$L, 10^{34}$
LHC	27	8.3	14	≤ 5
HE-LHC	27	16	26	5
HE-LHC	27	20	33	5
SppC-1	50	12	50	2
SppC-2	70	19	90	2.8
FCC-hh	80	8.3	42	–
FCC-hh	80	20	100	≥ 5
FCC-hh	100	16	100	≥ 5

Both cases require innovative SC R&D to build 16-20 Tesla magnets

Nb₃Sn up to 16 T; HTS needed for 20 T!

☞ Beam parameters are not too different from those for the HL-LHC

▣ the machine design looks feasible!

▣ 25 ns bunch spacing as baseline

→ 5 ns considered to mitigate PU

☞ Energy of each beam above 8 GJ
(Airbus 380 at 780 km/h)

▣ extremely demanding project for machine protection issue!

▣ collimation to protect experiments

▣ protection against quenches

▣ high radiation at IP (shielding)

☞ Approximately x1000 more SR

▣ significant power for cooling

FCC-hh is the most advanced project of 100 TeV proton collider including detector so far

Parameter	HL-LHC	FCC-hh
Energy c.m. (TeV)	14	100
Luminosity ($10^{34}\text{cm}^{-2}\text{s}^{-1}$)	5.0	5.0
Circumference (km)	27	100
Dipole Field (T)	8.3	16
Stored energy (MJ)	390	8400
E-loss/turn (keV)	7	5000
SR Power (kW)	3.6	5800
Bunch spacing (ns)	25	25 (5)
Bunch population (10^{11})	2.2	1(0.2)
Number of bunches	2808	10600(53000)
Pile-up/bx	140	170 (34)

Design takes a reasonable compromise between feasibility and some aggressive choices to avoid excessive cost

$$\Delta M_H^2 \sim \left[\text{Higgs self-energy} + \text{W loop} + \text{t loop} + \dots \mathcal{O}(E^2) \right]$$

- ☞ Search for new particles up to 10 TeV
 - ▮ no NP at 1 TeV \rightarrow 1% fine-tuning
 - ▮ no NP at 10 TeV \rightarrow 10^{-4} fine-tuning

Never seen 10^{-4} fine-tuning in PP!

- ☞ More precise SM measurements
 - ▮ top Yukawa: $\Delta g_{Htt} / g_{Htt} \sim 1\%$
 - ▮ self-coupling: $\Delta \lambda / \lambda \leq 10\%$
- ☞ Extend mass reach to verify that unitarity is preserved ($V_L V_L$ scattering)

Very high energy (≥ 50 TeV) hadron collider is needed to explore E-scale up to ~ 10 TeV

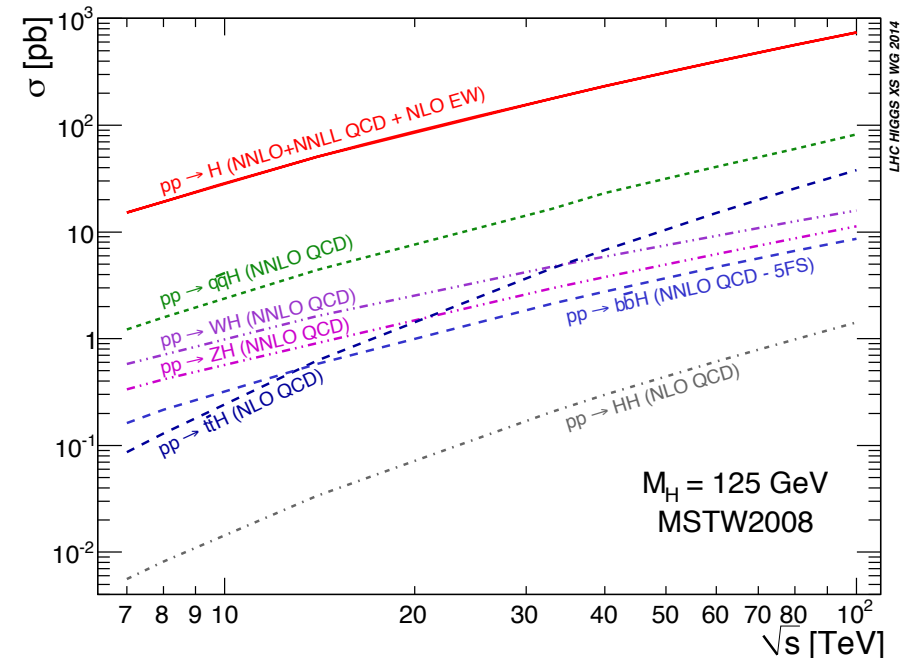
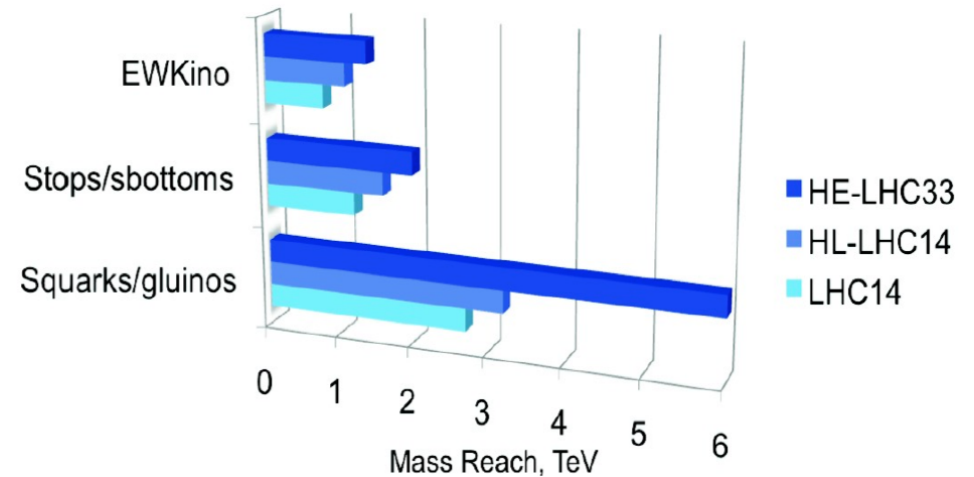

A 100 TeV pp collider is the most promising instrument to explore 10 TeV E-scale directly

3 ab⁻¹ provides very significant sensitivity to NP

Particle	σ (fb)	Limit (TeV)
Excited quark q^*	10^{-2}	50
Z' ($Z' \rightarrow l^+l^-$)	$4 \cdot 10^{-3}$	30
squark \tilde{q}	0.4	8
gluino \tilde{g}	2	13
stop \tilde{t}	0.2	6

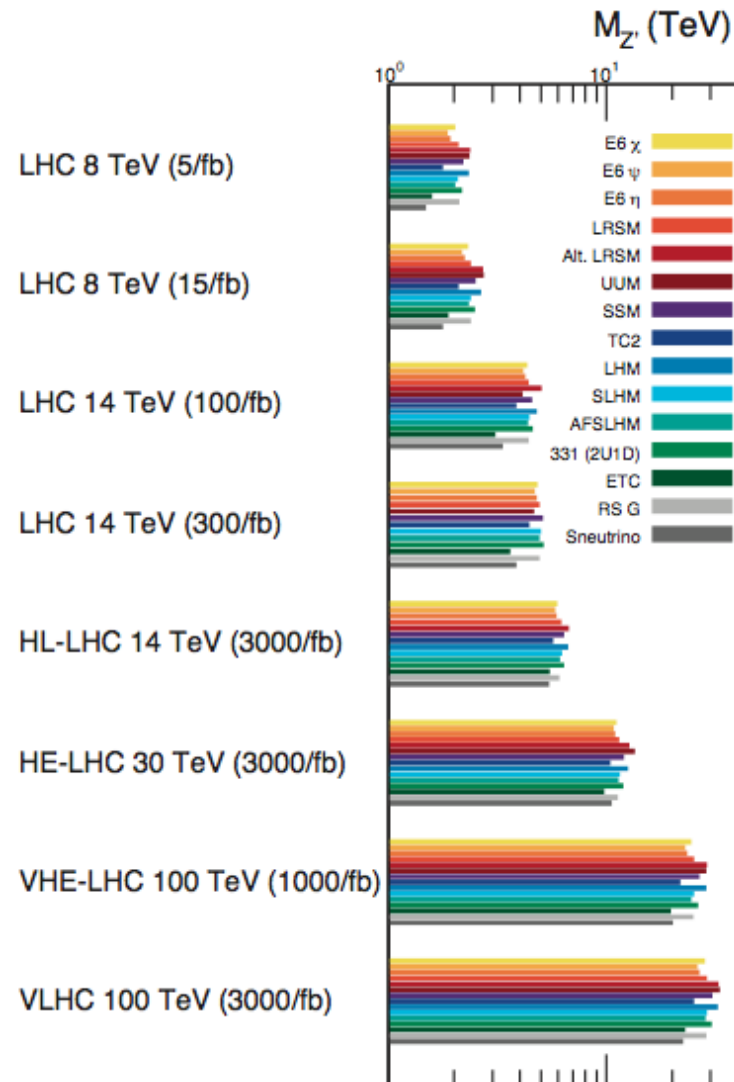
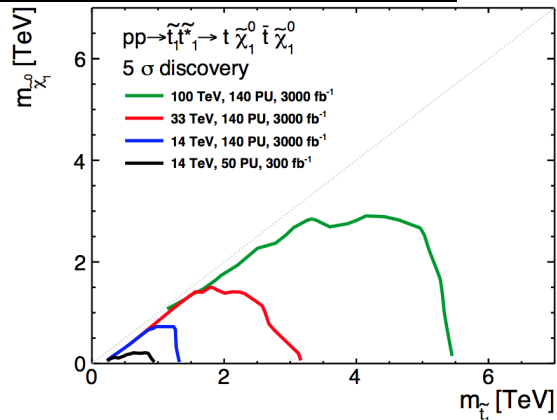
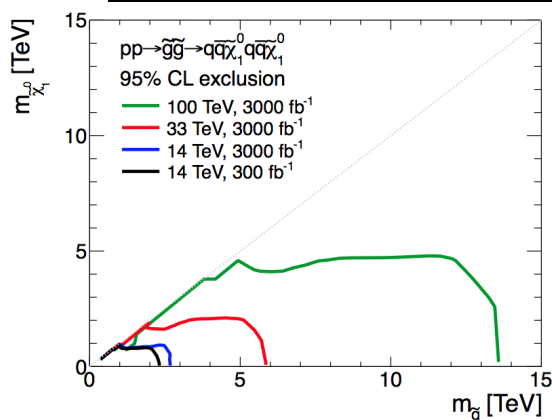

Extend mass reach up to 10 TeV to verify unitarity by probing $V_L V_L \rightarrow V_L V_L$

A linear collider (LC) is the way to push energy of lepton collisions

(circular e^+e^- colliders much beyond LEP energy are challenge!)

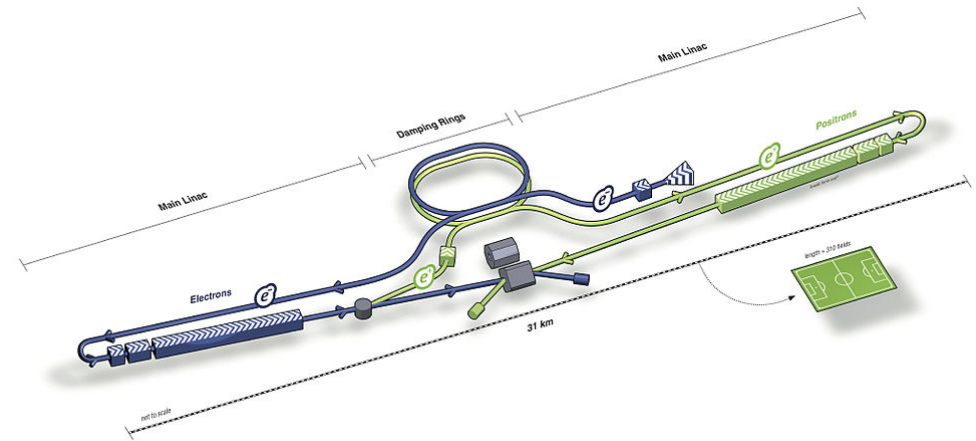

☞ Charged particles on bent trajectories emit synchrotron radiation (SR)

☞ energy loss per turn
(needs to be replaced by RF):

$$\Delta E_{turn} \propto \frac{E^4}{\rho}$$

☞ A LC has (almost) no radiation losses

☞ no bending magnets, lots of RF power
 ☞ accelerate particles in one shot
 ☞ costs scale linearly $EUR \sim E$

\sqrt{s} (GeV)	250
Luminosity ($10^{34} \text{cm}^{-2} \text{s}^{-1}$)	0.75
Beam size (σ_x/σ_y nm)	730/8
Cavity Gradient (MV/m)	14.7
Pulse duration (ms)	0.75
Bunch population (10^{10})	2
# bunches/train	1312
Frequency (Hz)	5
Total AC power (MW)	158

☞ ILC is planned with two experiments

☞ energy: **250 GeV** (staging)
(upgradeable to $f=10$ Hz)
 ☞ luminosity: 500 fb^{-1} (first 4 years)
 ☞ polarization: **80(30)%** for $e^- (e^+)$

Primary cost driver for the FCCee storage ring is the tunnel!

☞ Main instruments for PP of the past 50 years:

- ▮ very high luminosity
- ▮ multi-interaction region
- ▮ low beamstrahlung
- ▮ excellent E_{beam} knowledge

☞ Profit from LEP, PEP-II, KEKB

- ▮ super-KEKB has even more stringent requirements

☞ 2-rings option with crab-waist concept (multi-bunch mode)

- ▮ required for Z-pole and WW threshold operation

▮ E-range : 90-350 GeV

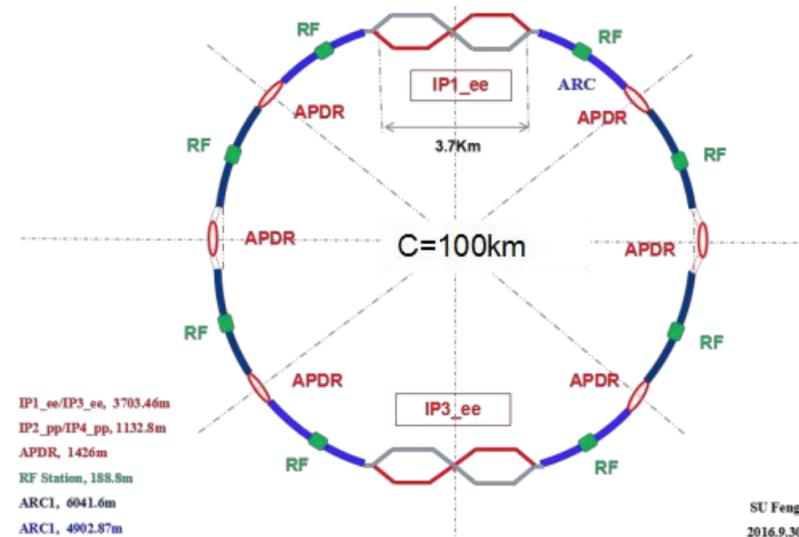
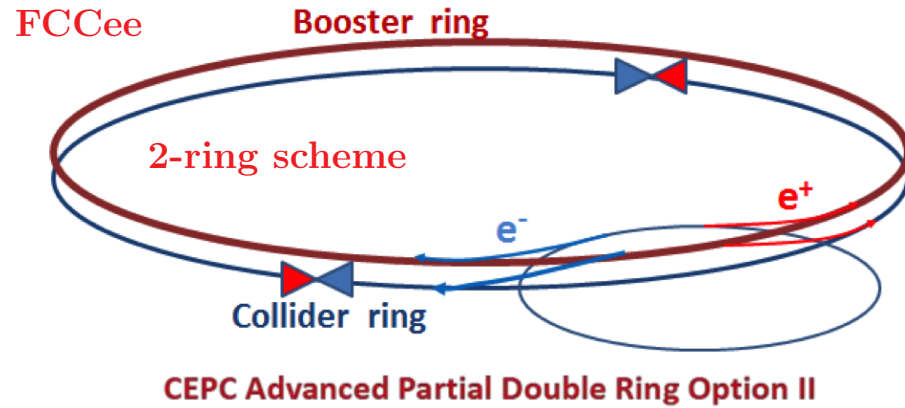

	FCCee-Z	FCCee-W	FCCee-H	FCCee-t	CEPC
\sqrt{s} (GeV)	90	160	240	350	240
L ($10^{34} \text{cm}^{-2} \text{s}^{-1}$)	230	32	8	1.5	2.9
# bunches	16640	2000	393	39	286
Total SR Power/beam (MW)	50	50	50	50	30

Characteristics of e^+e^- Machines

☞ ILC released TDR in 2013

☞ $\times 10^4$ of SLC performance

☞ FCC aims for a CDR in 2018

☞ 100 TeV pp: ultimate goal

☞ 90-350 GeV e^+e^- : first step

☞ 3.5-6 TeV ep: option

ILC is more advanced in R&D program aimed to demonstrate its feasibility

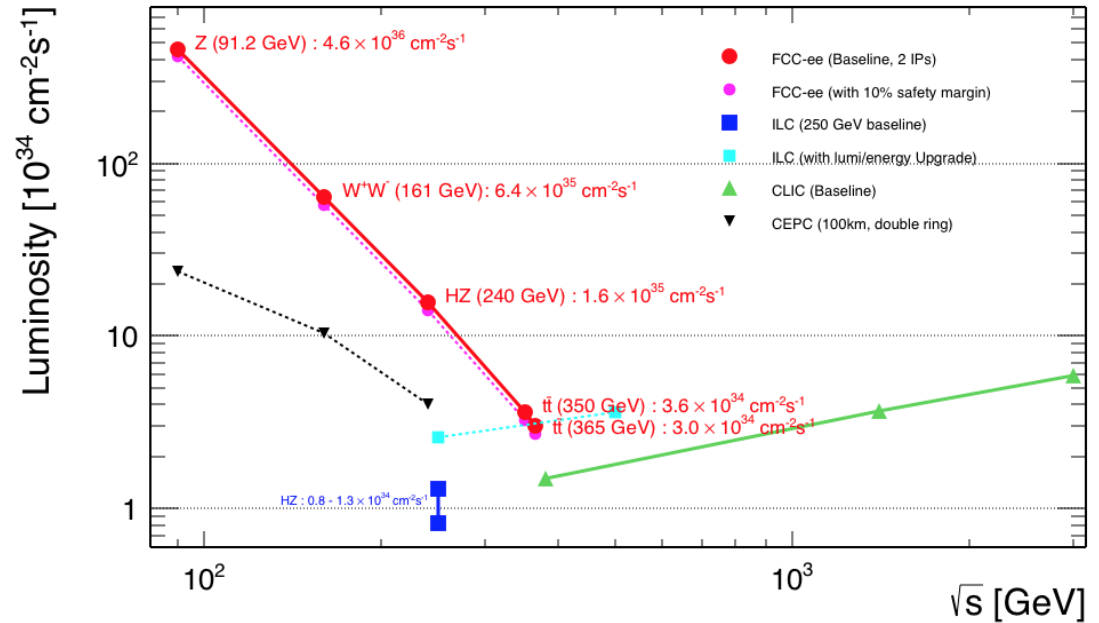

Param. units	Size km	\sqrt{s} GeV	RF MV/m	Lumi/IP 10^{34}	# IP	Rate Hz	σ_x μm	σ_y nm	Lumi 1% of \sqrt{s}	Polarization e^+/e^- , %	Cost estimate	Start approx.
FCC-ee	100	240	20	8	2	$2 \cdot 10^7$	22	45	$\geq 99\%$	≤ 161 GeV	tunnel 60%	≥ 2030
CEPC	100	240	20	2.9	2	$1.4 \cdot 10^7$	21	86	$\geq 99\%$	≤ 161 GeV	3 B\$	2028
ILC250	31	250	14.7	0.75	1	5	0.7	7.7	87%	80/30	5 B\$	≥ 2030
CLIC	48	3000	100	6	1	50	0.04	1.0	33%	80/possible	8+4 BCHF	≥ 2030

Indirect via precision measurements up to $\Lambda \sim \mathcal{O}(100)$ TeV,
Direct sensitivity to high-scale NP by search for new particles up to $m \sim \sqrt{s}/2$

☞ Point-like elementary particles

- ▣ well-defined and tunable energy
- ▣ uses full COM energy
- ▣ possible polarization of incoming particles

☞ Only EW interactions

- ▣ low SM background
- ▣ no selective trigger needed
- ▣ detectors designed for precision measurements (PFA concept)
- ▣ mostly fully reconstructed events

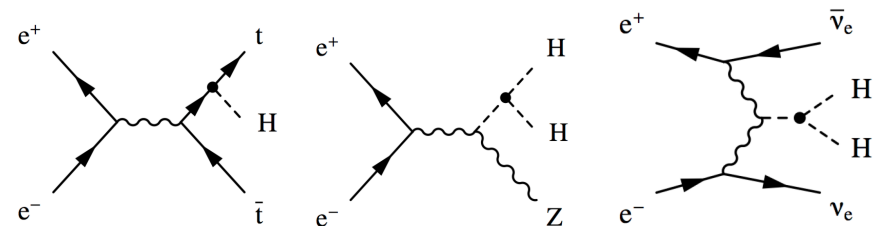
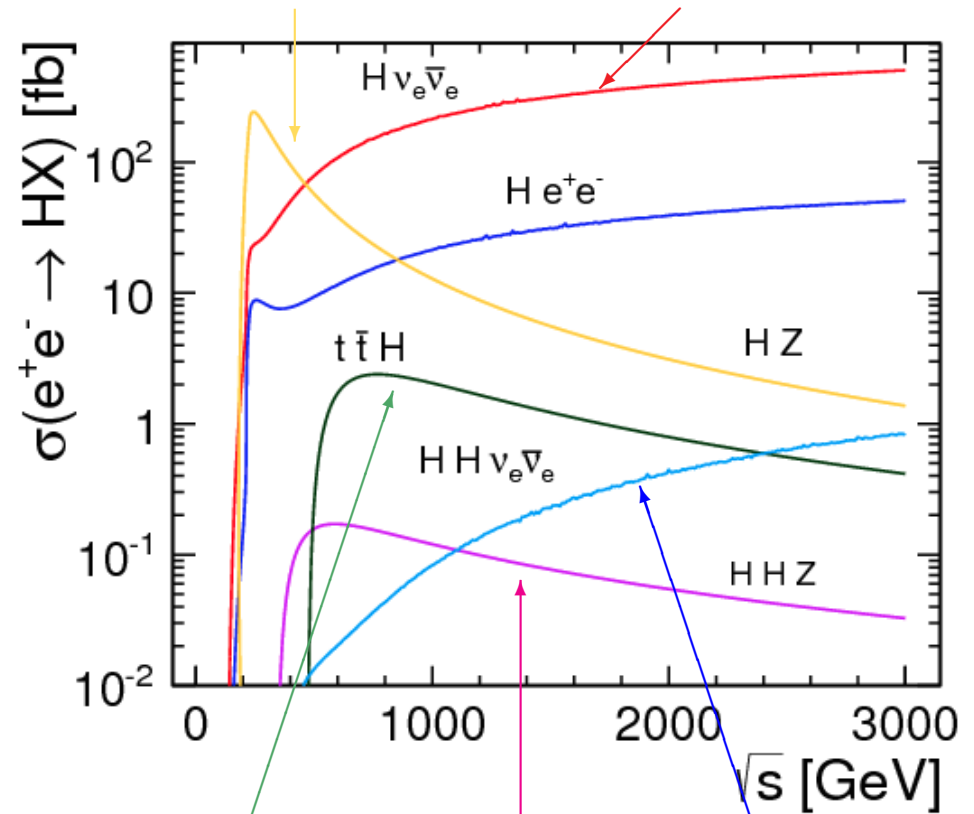
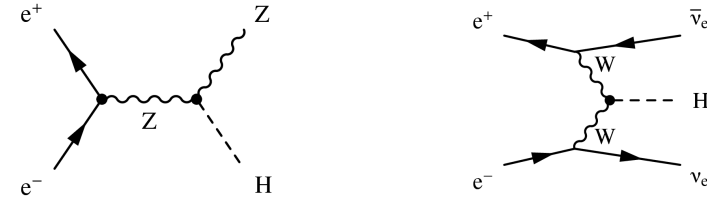

\sqrt{s} (GeV)	Physics program
90	Z-pole EW measurements beyond LEP
160	WW precision physics at threshold
250	precision Higgs couplings (HZ)
350	precision Higgs couplings (HZ, $H\nu\nu$) top precision physics at threshold
≥ 500	ttH, HH (self-couplings) direct searches for NP

Extracting Higgs couplings requires assumptions at LHC

e^+e^- machine provides a direct access to the Γ_H through the Z recoil

$$\sigma(e^+e^- \rightarrow ZH) \propto g_{HZZ}^2$$

$$\Gamma_H = \frac{\Gamma(H \rightarrow ZZ)}{\mathcal{B}(H \rightarrow ZZ)} \propto \frac{g_{HZZ}^2}{\mathcal{B}(H \rightarrow ZZ)}$$

Can also be measured with VBF process

$$\Gamma_H = \frac{\Gamma(H \rightarrow WW)}{\mathcal{B}(H \rightarrow WW)} = \frac{\sigma(\nu\nu H; H \rightarrow bb)}{\mathcal{B}(H \rightarrow WW)\mathcal{B}(H \rightarrow bb)}$$

Process	FCCee	ILC (4 years)
$e^+e^- \rightarrow ZH (H \rightarrow ZZ)$	3.1%	20%
$WW \rightarrow H (H \rightarrow bb)$ @250 GeV	2.4%	12%
$WW \rightarrow H (H \rightarrow bb)$ @350 GeV	1.2%	-
Combined $\Delta\Gamma_H/\Gamma_H$	1.0%	12%

FCC-ee is more powerful for overall Γ_H due to higher statistics $\mathcal{B}_{XX} \propto \sigma(HZ, H \rightarrow XX)$

Keyword: luminosity!

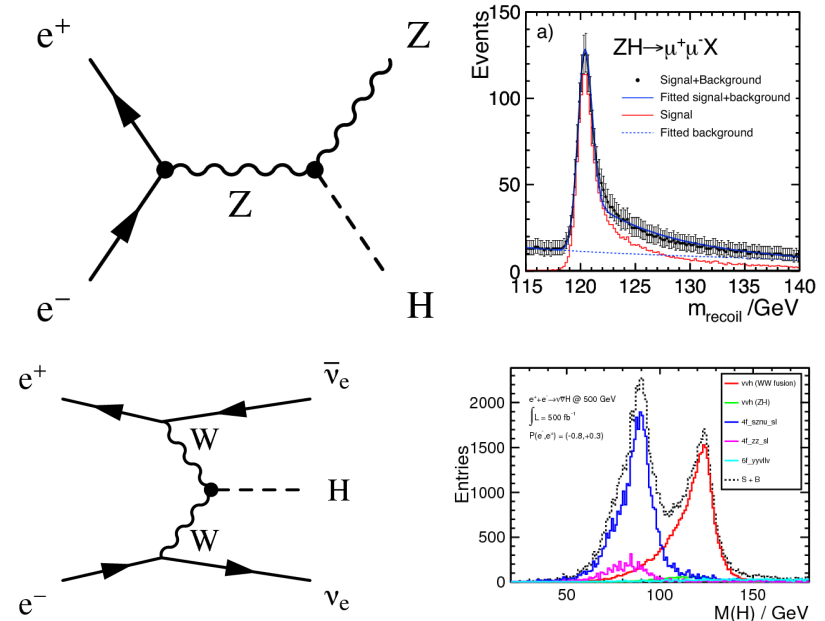

$$\sigma_{\nu\nu H} \times \mathcal{B}(H \rightarrow bb)$$

\sqrt{s} (GeV)	FCCee	ILC (4 years)
250	2.2%	10.5%
350	0.6%	-

ILC precision for VBF process is limited due to restriction of the project to 250 GeV energy

Effect of New Physics on couplings:

$$\Delta g_{\text{HXX}}/g_{\text{HXX}} \leq 5\% \times \left(\frac{1 \text{ TeV}}{\Lambda}\right)^2$$

- SUSY model modifies tree level couplings and predicts largest effect for b and τ

$$\frac{k_{b,\tau}}{k_{b,\tau}^{\text{SM}}} \simeq 1 + 40\% \left(\frac{200 \text{ GeV}}{m_A}\right)^2$$

- Loop induced couplings are modified due to a scalar top-partner contribution as

$$\frac{k_g}{k_g^{\text{SM}}} \simeq 1 + 1.4\% \left(\frac{1 \text{ TeV}}{m_T}\right)^2, \quad \frac{k_\gamma}{k_\gamma^{\text{SM}}} \simeq 1 - 0.4\% \left(\frac{1 \text{ TeV}}{m_T}\right)^2$$

- Compositeness models reduce couplings according to compositeness scale ($\xi^{\text{SM}} = 0$)

$$\frac{k_V}{k_V^{\text{SM}}} = \sqrt{1 - \xi}, \quad \frac{k_f}{k_f^{\text{SM}}} = \frac{1 - (1 + n)\xi}{\sqrt{1 - \xi}}, \quad n = 0, 1, 2$$

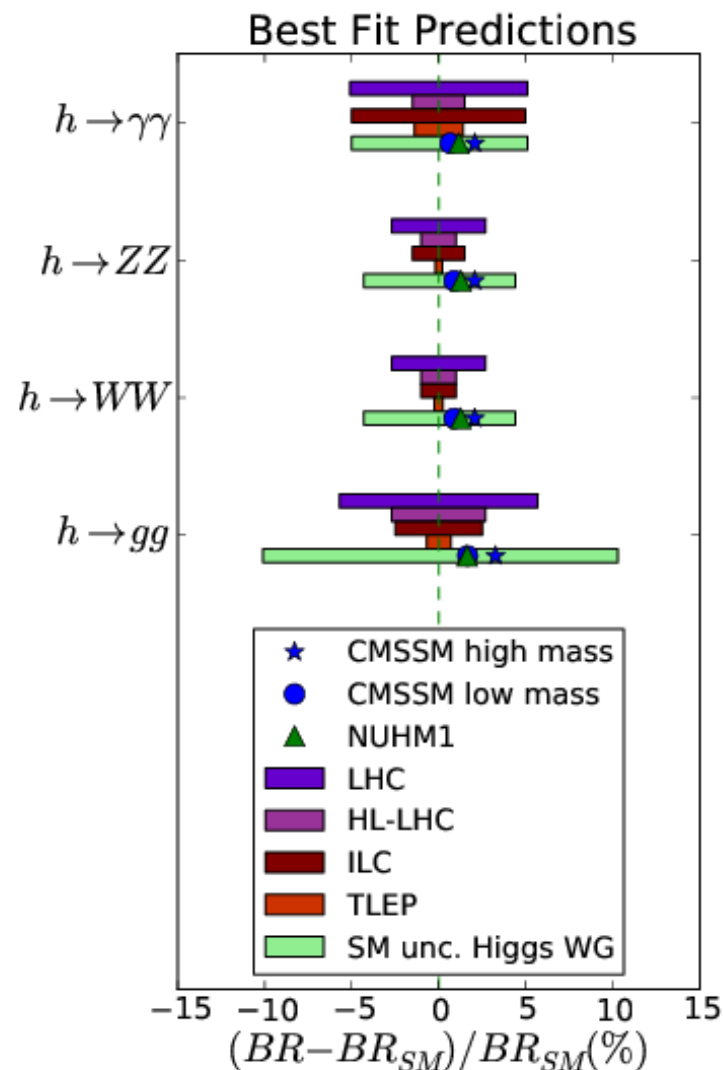

$\Delta k/k \simeq 0.1-1\%$ precision is needed for discovery!

HL-LHC can ultimately reach 2-5% for most of couplings and observe couplings to μ and top, but assumes SM Γ_H (model dependent)

Coupling	HL-LHC	FCCee	ILC(500)	ILC(1000)	CLIC(3000)
\sqrt{s} , GeV	14000	240+350	250+500	+1000	++3000
L, ab^{-1}	3+3	10+2.6	0.25+0.5	0.25+0.5+1	0.5+1.5+2
k_W	2-5%	0.19%	1.2%	1.2%	2.1%
k_Z	2-4%	0.15%	1.0%	1.0%	2.1%
k_g	3-5%	0.8%	2.3%	1.6%	2.2%
k_γ	2-5%	1.5%	8.4%	4.0%	5.9%
k_μ	7%	6.2%	–	16	5.6%
k_c	–	0.71%	2.8%	1.8%	2.2%
k_τ	2-5%	0.54%	2.3%	1.7%	2.5%
k_b	4-7%	0.42%	1.6%	1.3%	2.1%
k_t	$\sim 5\%$	13%(indir.)	14%	3.1%	4.5%
λ	$\sim 30\%$	(indirect?)	83%	21%	10%
BR_{inv}	$\leq 10\%$	$\leq 0.2\%$	0.9%	0.9%	NA
Γ_{tot}	–	1.0%	5.0%	4.6%	NA

FCC-hh:

$$k_t \sim 1\%,$$

$$\lambda \sim 8\%$$

FCC-he:

$$k_b \sim 1\%,$$

$$\lambda \leq 10\%$$

(absence of PU)

e^+e^- colliders can go much beyond HL-LHC and perform model independent Γ_H measurement and access to all decay modes

Best precision (few 0.1%) at circular colliders (thanks to luminosity), except for heavy states (ttH and HH) where high energy (LC, FCC-hh) are required

The facilities
being discussed

e^+e^- Linear Colliders
HE e^+e^- Storage Rings
HE pp Colliders

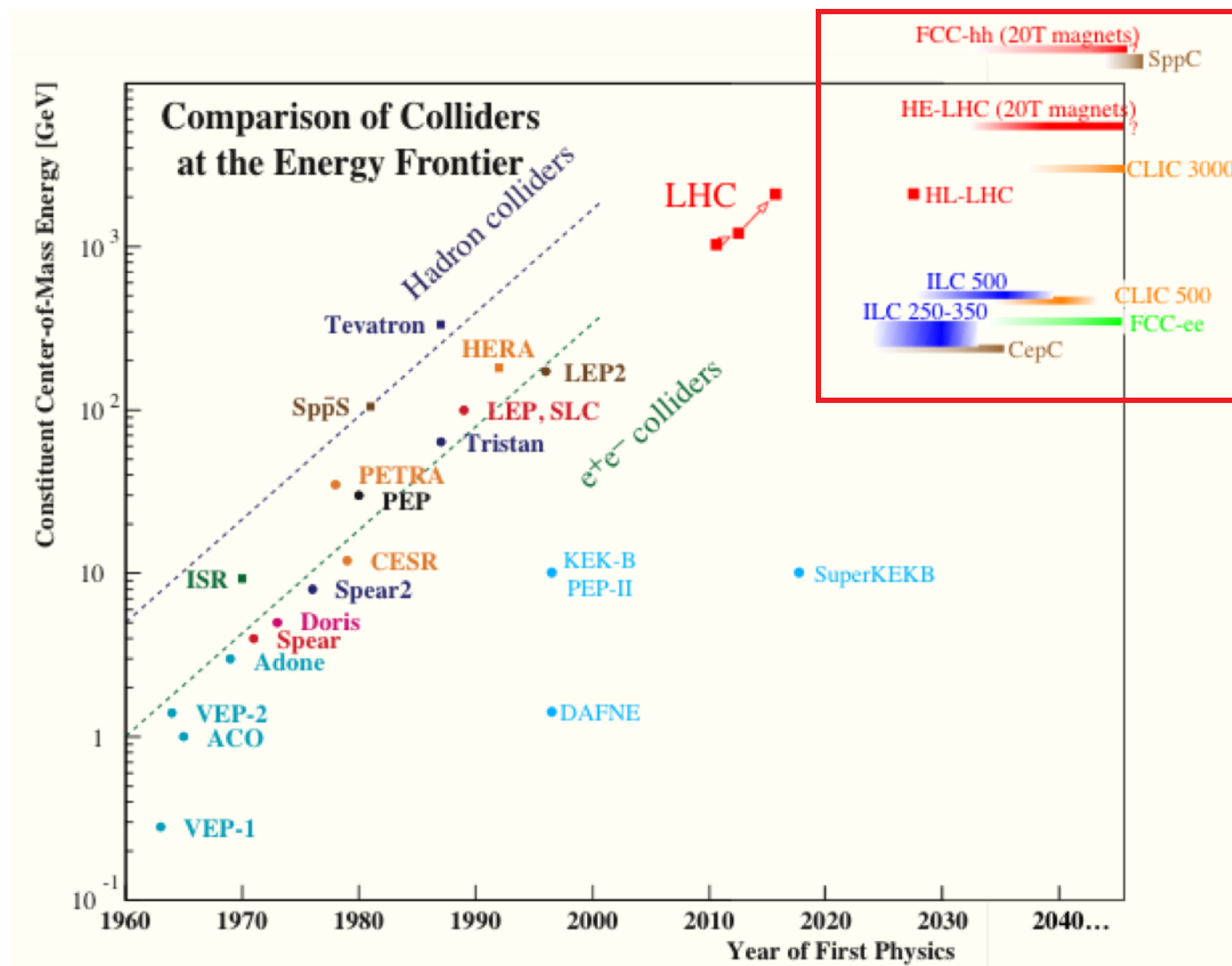

LHC remains a main source of information and will continue to drive initial observations in the coming years

☞ HL-LHC is the **highest-priority near-term large project** supported by both Europe and US

☞ The discovery of a Higgs boson completed the SM, but major questions remain

☞ **Powerful high energy frontier accelerators** will be needed to address them

☞ cutting edge technologies are vital to pursuit the realization of our ambitious vision

☞ mitigation of technological risks would probably let the cost go up, but ...

☞ **LHC has proven, one can firmly risk to advance our knowledge!**

☞ **the international participation** is a must for any of the future projects

☞ With the Higgs discovery the **known path is over**, we do not know what is beyond

☞ we will probably keep all options open by the time when physics results from LHC running at 14 TeV will be available

A wise strategy is an opportunity for all possibilities and not a restraint in a few choices

Backup

- ☞ SM is self-consistent model accounting all PP phenomena at energy of current accelerators
- ☞ with m_H all parameters of SM are known
- ☞ m_W is a fundamental parameter of the SM

$$m_W = \sqrt{\frac{\pi\alpha}{G_F\sqrt{2}} \frac{1}{\sin\theta_W\sqrt{1-\Delta R}}}$$

Radiative corrections $\Delta R \sim 4\%$:

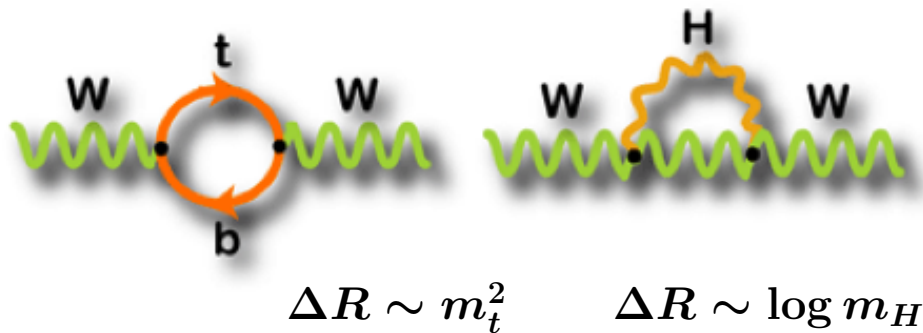

$m_W = 80385 \pm 15 \text{ MeV}$, $m_t = 173.2 \pm 0.9 \text{ GeV}$
 current p-value for $(\text{data}|\text{SM}) = 0.2$
 (need to improve m_W , m_t and m_H)

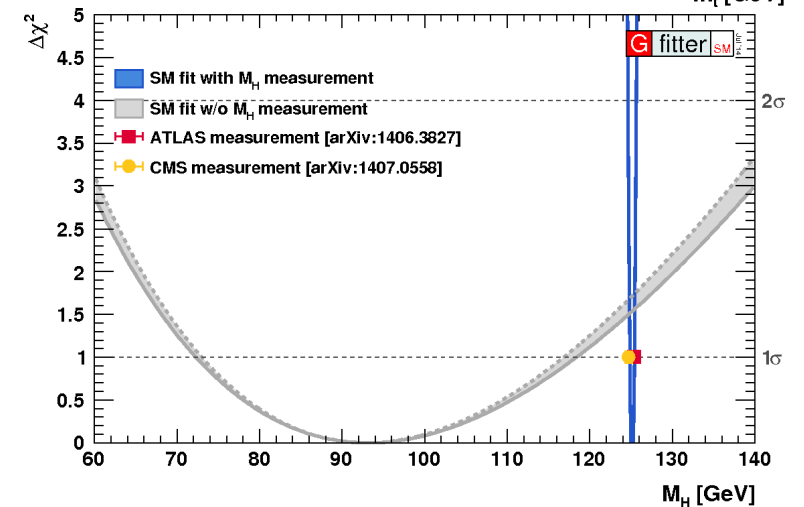
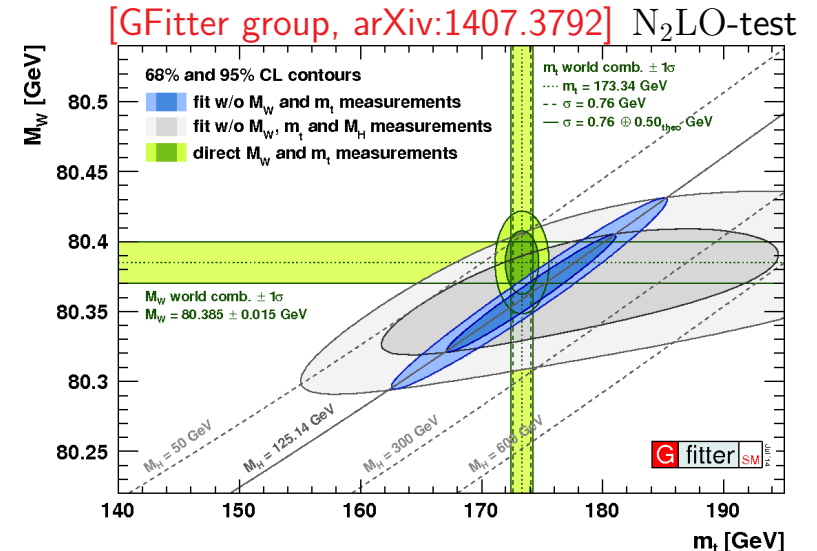

Precision tests of further consistency of the SM are mandatory!

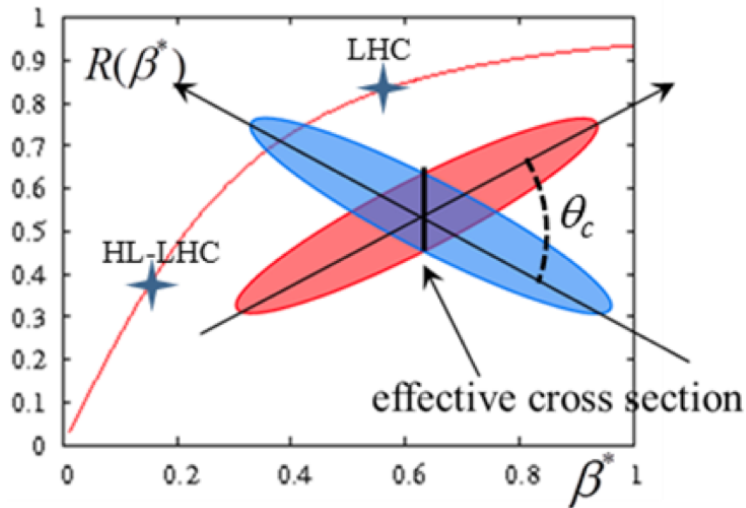

$$R = \frac{1}{\sqrt{1 + \left(\frac{\theta_c \sigma_z}{2\sigma_x}\right)^2}}$$

- ☞ HTS links (2x100 kA, 500m) to protect DFBX
- ☞ Reduce beam size: IR-quads, triplets 13T, 8m
- ☞ Increase I_{beam} : 8 T \rightarrow 11 T Nb_3Sn dipoles
- ☞ Crab crossing improves further the luminosity by maximizing overlap of the 2 beams (technology pioneered successfully on KEKB, Japan)
 - ☛ also help to mitigate the harsh PU conditions

29 distinct vertices have been reconstructed corresponding to 29 distinct collisions within a single crossing of the LHC beam

Thanks to Nb_3Sn technology successful magnet R&D is ongoing

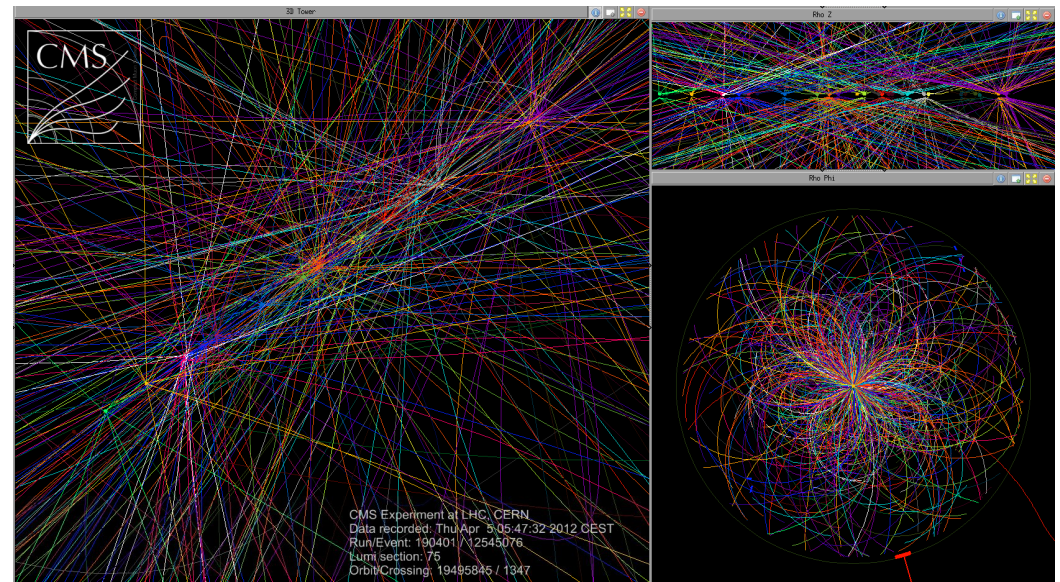

Dipole design uses forefront multiple SC material technology (cost is critical!)

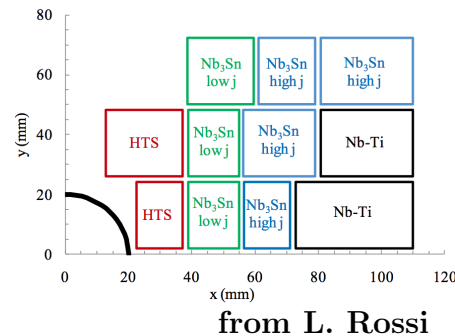
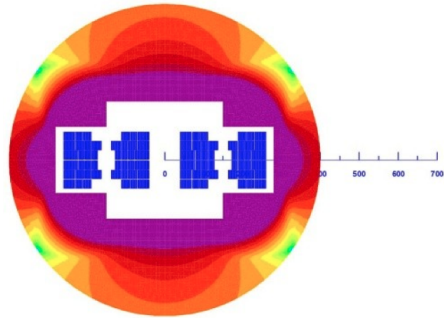

Material	No turns	Coil fraction (%)	Peak field (T)	J_{overall} (A/mm ²)
Nb-Ti	41	27	8	380
Nb ₃ Sn (high J_c)	55	37	13	380
Nb ₃ Sn (low J_c)	30	20	15	190
HTS	24	16	20.5	380

Vigorous R&D program is needed to demonstrate the viability of HTS-based cables and magnet engineering design

- ☞ A 20 T dipole poses big challenges:
 - ☞ obtain with compact coil
 - ☞ shield it with limited dimensions iron
 - ☞ manage the stresses to avoid degradation of the conductor

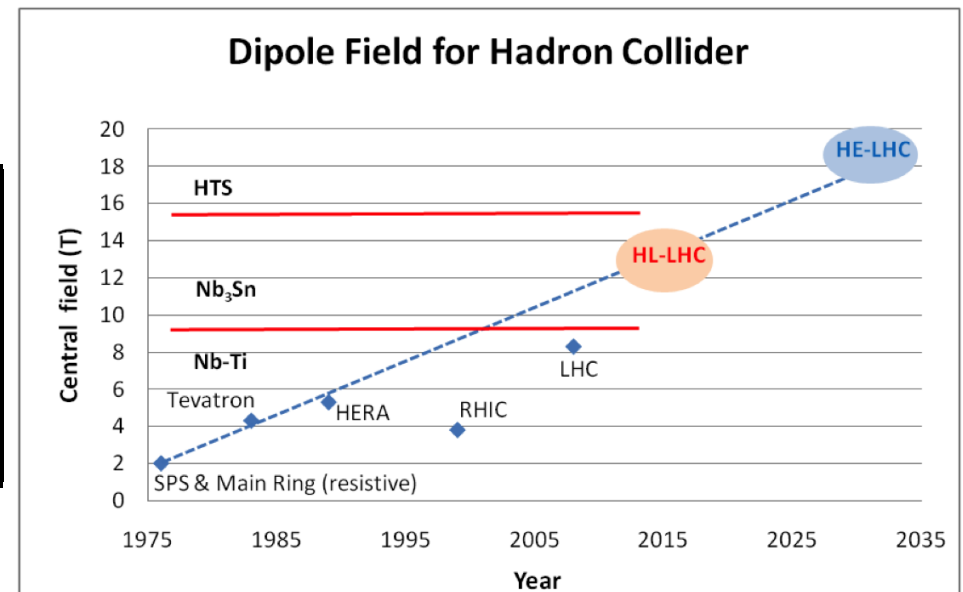

Magnets for HL-LHC is an indispensable first step!

Detector designed for radiation hardness and pile-up rejection

Major challenges (few examples):

- ▮ ultra-granular, fast, rad-hard, low power
- ▮ calorimeter coverage over $|\eta| \geq 6$
- ▮ CMS inspired design: $15\text{m}^3 \sim 120\text{kTons}$ ($\geq \text{EUR}250\text{M}$ raw material) of iron
 - $B_{\text{in}} = 8.3\text{ T}$ main solenoid with active shield $B_{\text{out}} = 2.3\text{ T}$
 - combination of solenoid and torroids

50% of signal at $\sqrt{s} = 100\text{ TeV}$ has jets with $|\eta| \geq 5$ (ATLAS, CMS: $|\eta| \leq 5$)

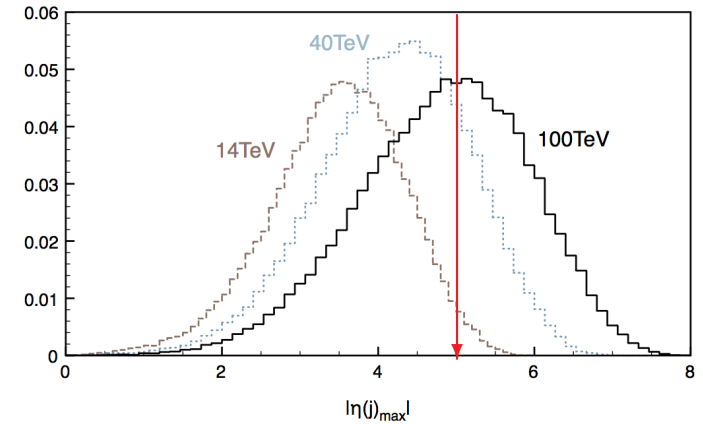

Very high forces
(optimization is needed!)

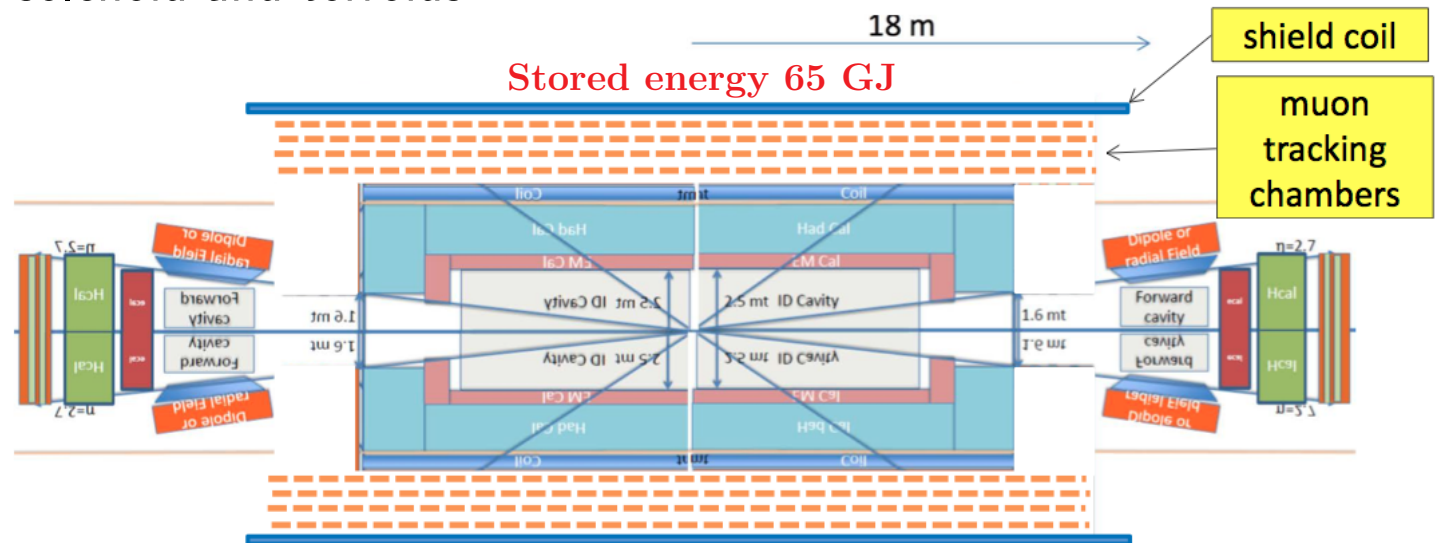

High electric field gradients are realized by 9-cell superconducting (SC) niobium cavities, cooled by 2 K Helium (needs mass production ~ 15000)

- ☞ SC cavities absorbs little power
 - ▮▮▮ reach higher gradient (1.3 GHz)
 - ▮▮▮ need high efficiency
- ☞ Low rate requires squeezing beams to nm size: $L \propto 1/\sigma_y \propto \sqrt{E}$
 - ▮▮▮ low emittance damping rings
 - ▮▮▮ large beamstrahlung
- ☞ Industrialization of technology
 - ▮▮▮ 17.5 GeV prototype: XFEL facility at DESY is about 5% of ILC
 - ▮▮▮ ATF2 operating at KEK, currently achieved $\sigma_y = 45 \pm 3\text{nm}$
- ☞ Demonstration of e^+ -source feasibility

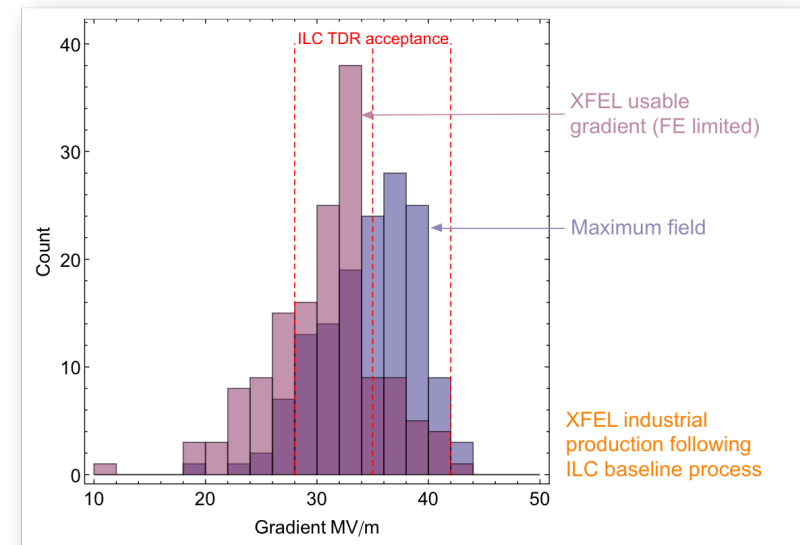
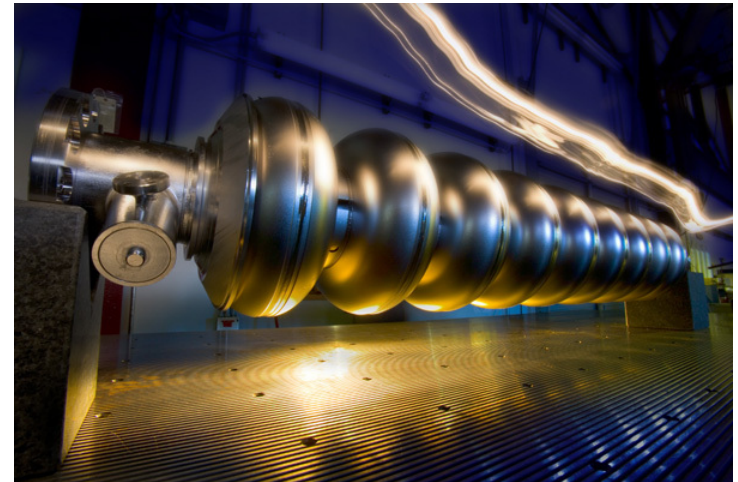

Cavity gradient performance is not uniform, but satisfactory!

Luminosity increases at low energy!

☞ The maximum SR power is set to

$$P_{\text{SR}} = 50 \text{ MW/beam}$$

- ☞ drive the machine design
- ☞ determine the maximum beam current at each energy ($\rho_{\text{arc}} \simeq 11\text{km}$) (SR limits number of bunches to be accelerated for given RF power)
- ☞ aiming for SC RF cavities with 20 MV/m gradient
 - RF frequency of 400 MHz

☞ Large bunch population and beamstrahlung at IP limit $\tau_{\text{beam}} \sim 20\text{-}15$ minutes at high energy

The beams must be topped up continuously!

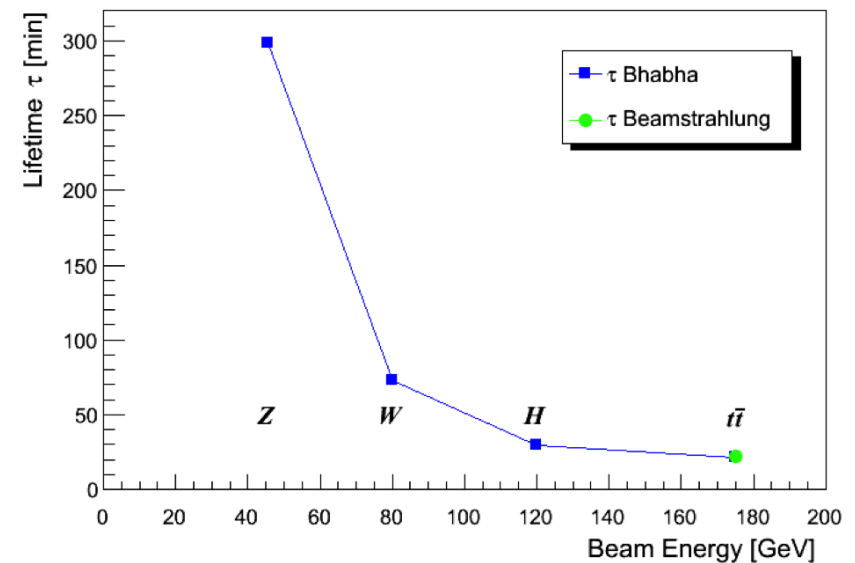
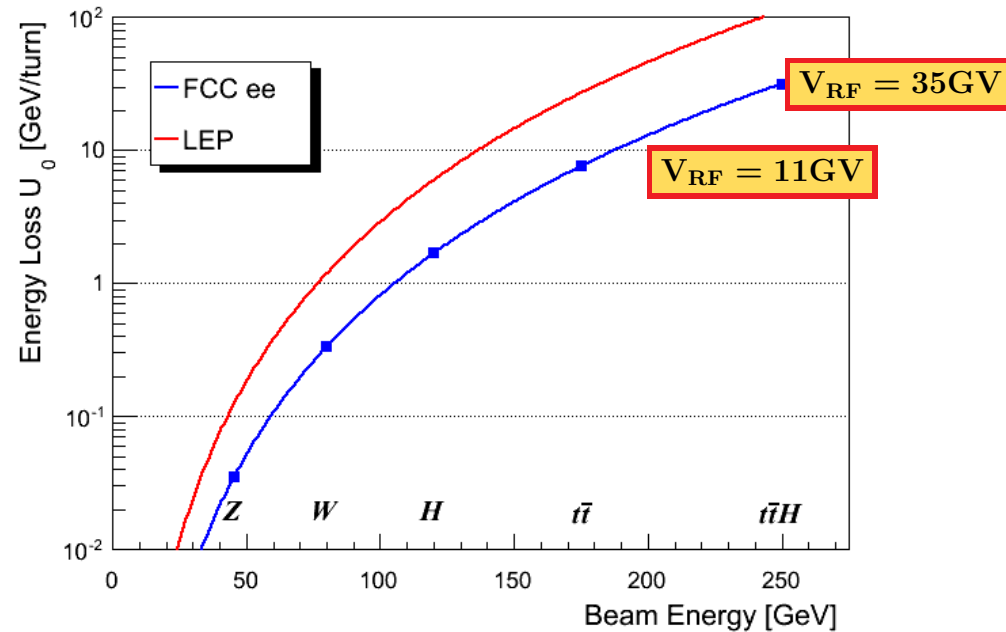

	\sqrt{s} (TeV)	L (ab^{-1})	N_H (10^6)	N_{ttH}	N_{HH}
FCCee	0.24+0.35	10	2	—	—
ILC(500)	0.25+0.5	0.75	0.2	1000	100
ILC(1000)	0.25+0.5+1	1.75	0.5	3000	400
CLIC(3000)	0.35+1.4+3	3.5	1.5	3000	3000

HL-LHC	14	3+3	180	3600 $tt\gamma\gamma$	250
FCC-hh	100	3	5400	12000 $tt4l$	20000

☞ FCC-ee Tera-Z factory:

- ☞ **10^{12} Z:** LEP1 dataset every 15'
 10^{13} Z possible with crab sextupoles scheme
 [Phys.Rev.ST Accel.Beams 17, 041004 (2014)]
- ☞ **$5 \cdot 10^7$ WW** $\Rightarrow \Delta m_W \leq 1\text{MeV}$
- ☞ **10^6 tt** $\Rightarrow \Delta m_t \leq 10\text{MeV}$

☞ Polarization is possible up to WW

- ☞ energy calibration at $\Delta E \simeq 0.1\text{MeV}$
- ☞ physics with longitudinal polarization

Detector design for e^+e^- colliders profit from 15 years dedicated R&D program of LC experiments (ILD, SiD, CLIC)

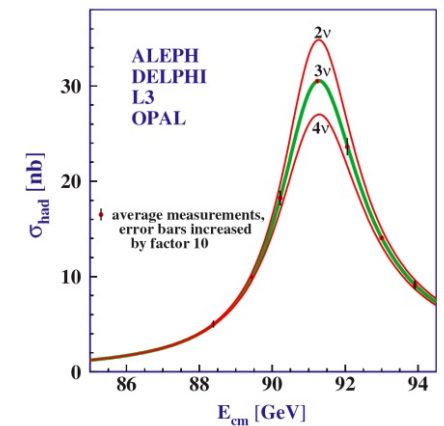
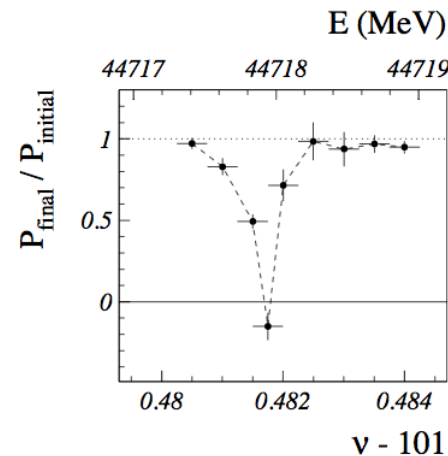

Double Higgs production among the main objectives of HL-LHC, but this process is very challenging

☞ Low rate makes high demands on detectors and integrated luminosity

☞ self coupling diagrams interferes destructively with double Higgs processes

→ look for a deficiency in a small signal

☞ $\sigma_{HH}(100 \text{ TeV}) / \sigma_{HH}(14 \text{ TeV}) \simeq 40$

	LHC	FCCee	ILC 1000	ILC upgrade	CLIC 3000	FCChh
$\Delta\lambda/\lambda$	~30%	indirect?	21%	13%	10%	~8%

One of the most difficult measurement both hadron and e^+e^- machines, push energies is pivotal!

Hadron Machines

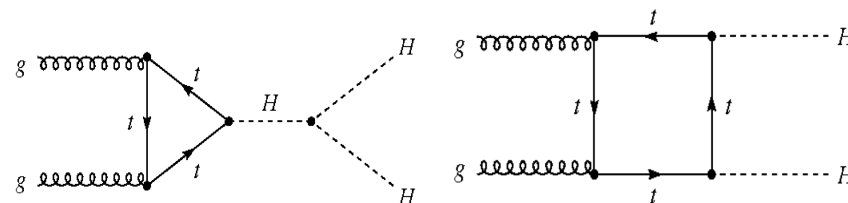

Higgs self coupling

SM Double Higgs

e^+e^- Machines

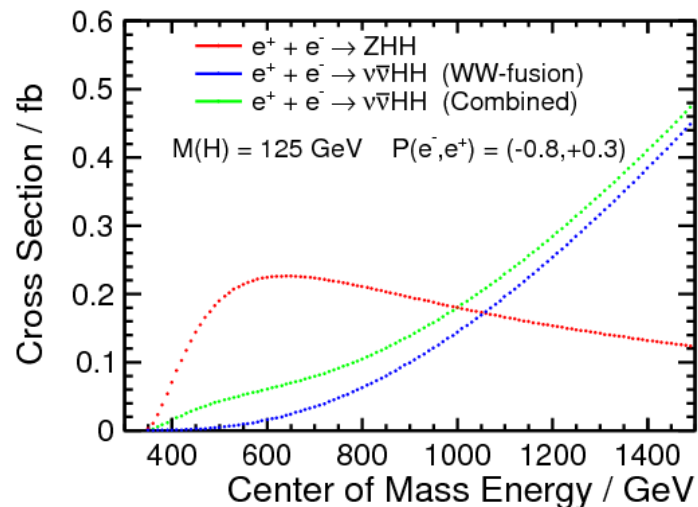
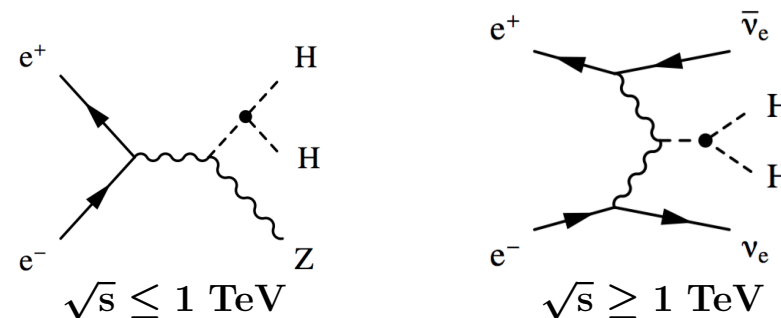

- ☞ Determine tt-threshold lineshape for σ_{tt} , p_{tt}^{\max} , A_{FB} observables
- ☞ multi-parameter fit to m_{top} , Γ_{top} and g_{Htt}
- ☞ ILC cross section is higher due to polarizaiton
- ☞ FCCee has precise beam-energy knowledge

	m_{top}	Γ_{top}	g_{Htt}
TLEP	10 MeV	11 MeV	13%
ILC	31 MeV	34 MeV	40%

- ☞ Present δm_t and δm_Z are responsible for dominant parametric uncertainty on Δm_W

	LHC		ILC		FCCee	
	exp.	th.	exp.	th.	exp.	th.
Δm_W (MeV)	10	4	7	1.0	0.5	1.0
Δm_{top} (MeV)	600	250	34	100	10	100
Δm_H (MeV)	100		35		7	
Δm_H (GeV) (EWK fit)	19	9.0	6.6	2.4	1.8	2.8

Circular colliders can profit from precision measurement of α_s at Tera-Z and Oku-W

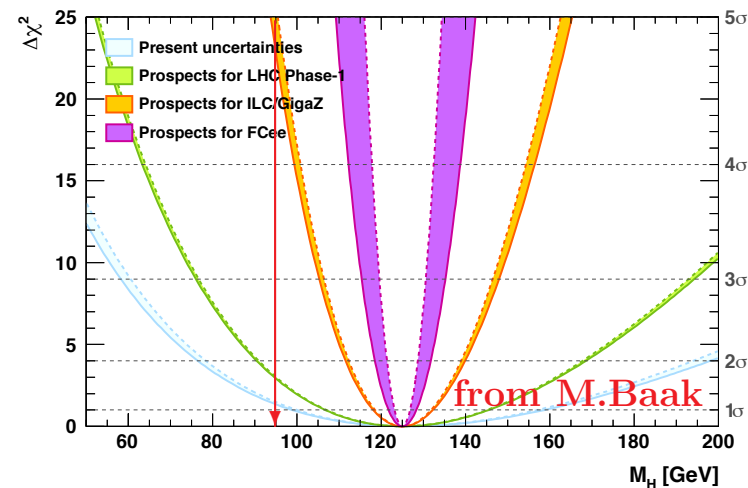
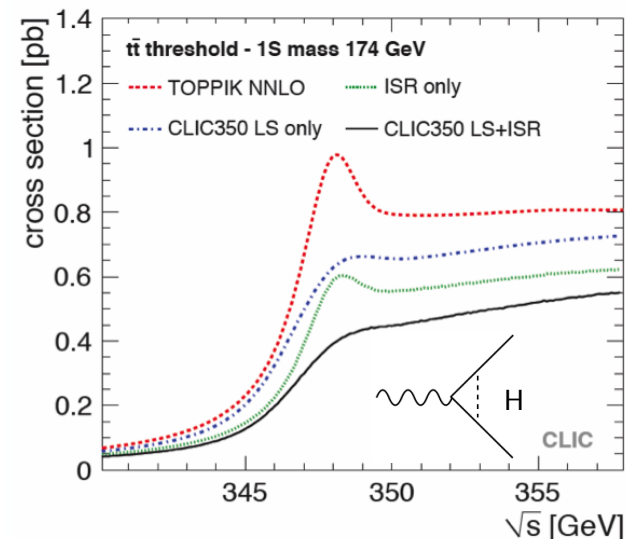

Theoretical efforts are needed to match present and future precision on EW observables

CP-violation generated by the SM in quark sector is too small to explain BAU

- ☞ Large mixing θ_{13} points to sizable CP-violation in lepton sector (needs very high intensity ν -beam!)
- ☞ Possible solution for neutrino mass term
 - ▮ 3 families of massive right-handed (sterile) neutrinos (ν MSSM)
 - ▮ also explains DM and BAU
- ☞ Manifestation of sterile neutrinos would be a sign of NP
 - ▮ possibly measurable in colliders if mixing with EW sector is sizable
 - deficit in Z invisible decay width
 - LEP: $N_\nu = 2.984 \pm 0.008$ (close to the systematic limit)

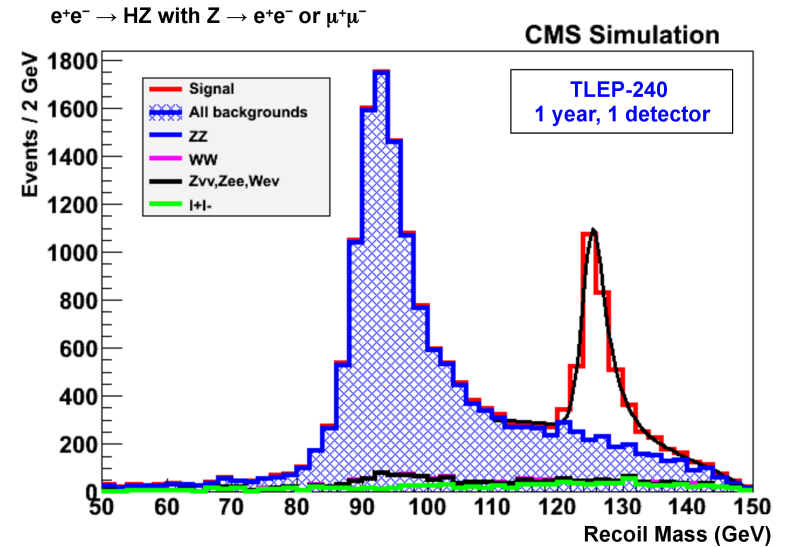

- ☞ FCC-ee opens new possibility for ν counting in $Z\gamma$, ZZ and ZH

$$N_\nu = \frac{N(XZ_{\text{inv}})}{N(XZ_{ee,\mu\mu})} / \left(\frac{\Gamma_{\nu_1}}{\Gamma_1}\right)_{\text{SM}}$$

Statistical sensitivity of $\delta N_\nu \leq 0.001$ could be achievable and perhaps better if run at 126 GeV is considered

Definitive measurement at future Neutrino Factories (NF)

Muon accelerator facility can address outstanding questions spanning both Neutrino and Higgs sectors

- ☞ SR is strongly suppressed in muon rings
 - ▮ reach multi-TeV collision energy
 - ▮ high quality colliding beams (direct Higgs production via s-channel)

☞ Important impact:

- ▮ short lifetime ($2.2\mu\text{s}$ at rest) limits acceleration and storage time
- ▮ deal with decay background (new!)

☞ Concept of ν /Higgs-Factory:

- ▮ provide equal fractions of ν_e and ν_μ at very high intensity 10^{21} /year



☞ P5: the US effort is ramping down

Muon collider goes beyond a NF Facility and requires innovative accelerator R&D (6D Cooling)

Parameters	H-Factory	Multi-TeV
Energy c.m. (GeV)	126	3.0
Luminosity ($\text{cm}^{-2}\text{s}^{-1}$)	10^{32}	$5 \cdot 10^{34}$
Circumference (km)	0.3	4.4
Beam size (μm)	75	3
Bunch population	$4 \cdot 10^{12}$	$2 \cdot 10^{12}$
Number of bunches	1	1
Frequency (Hz)	15	12
Energy Spread (%)	0.003	0.1
P-Driver Power (MW)	4	4

First stage: Neutrino Factory (NF)

Parameters	ν STORM	NuMAX	NuMAX+
Intensity (ν /year)	$3 \cdot 10^{17}$	$1.8 \cdot 10^{20}$	$5.0 \cdot 10^{20}$
Stored (μ /year)	$8 \cdot 10^{17}$	$4.7 \cdot 10^{20}$	$1.3 \cdot 10^{21}$
Ring momentum (GeV)	3.8	5.0	5.0
Circumference (m)	480	737	737
Bunch population	$6.9 \cdot 10^9$	$2.6 \cdot 10^{10}$	$3.5 \cdot 10^{10}$
Number of bunches	-	60	60
Frequency (Hz)	-	30	60
6D Cooling	No	Initial	Initial
P-Driver Power (MW)	0.2	1	2.75

Muon based facility will require development of demanding technologies and innovative concepts (MAP program)

Neutrino Factory (NuMAX)

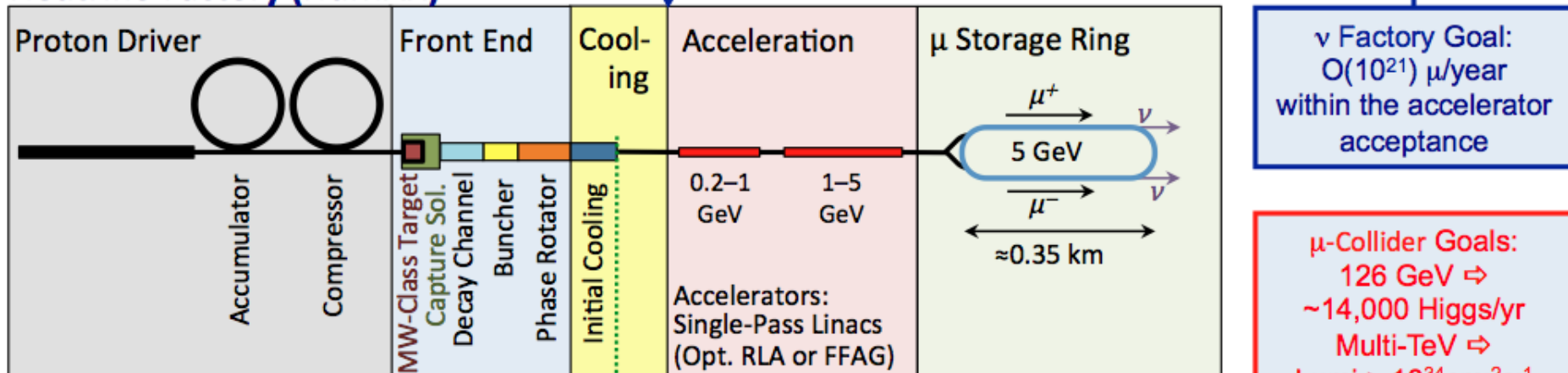

Share same complex

Muon Collider (Muon Accelerator Staging Study)

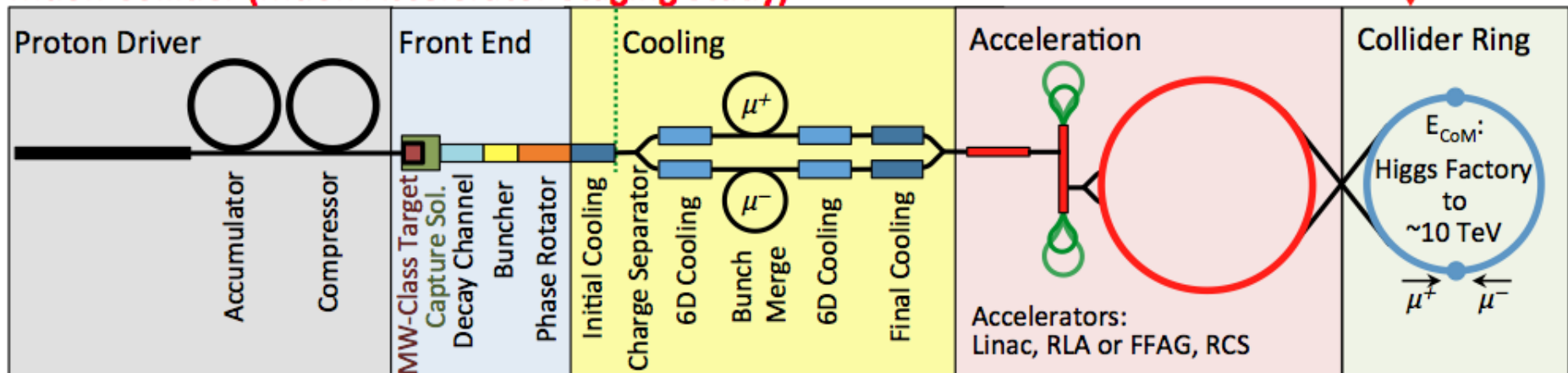

☞ ν STORM project is a critical step toward muon based accelerator complex

- ▮ no new technologies required
- ▮ test muon storage ring
- ▮ $3 \cdot 10^{17}$ decays per year
- ▮ precision ν_e xsection (systematics issue for long baseline experiments)
- ▮ P5: the US effort is ramping down

☞ Demonstration of cooling – MICE

- ▮ ionization cooling:
 - 10% emittance reduction
- ▮ needs for a full 6D cooling:
 - 100 RF cavities (15MV/m)
 - 100 SC 0.15 m coils (2.8 T)

☞ Multi-MW proton driver

- ▮ high gradient SC cavities

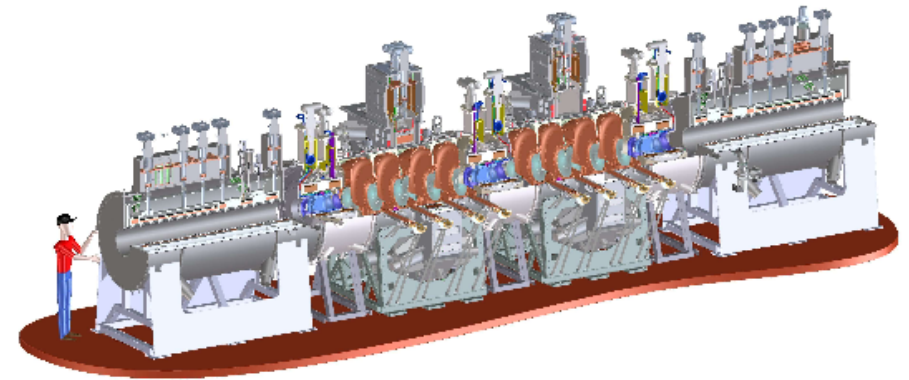
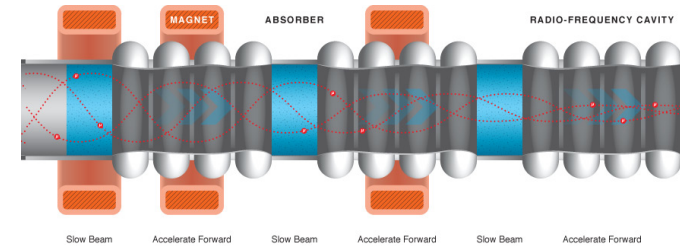

- ☞ 6D phase space cooling: reduction by 10^6 needed for muon collider
 - ▮ very high field solenoids (~ 20 T)
 - ▮ high gradient cavities operating in multi-Tesla field

Higgs Factory and Multi-TeV colliders are long term facilities beyond NF

- ☞ Energy spread $\delta E/E \leq 10^{-5}$
 - ☛ direct Higgs production via s-channel (Γ_H measurement from natural scan)
 - ☛ precision measurements at threshold
- ☞ Multi-TeV capability (≤ 10 TeV)
 - ☛ very compact machine!
 - ☛ measure self-coupling $\leq 10\%$
 - ☛ route to direct NP production via leptons beyond LC energy reach
- ☞ Feasible at FCC-ee due to exceptionally high luminosity at $\sqrt{s} = 126$ GeV
 - ☛ unique possibility to access g_{Hee}

Possible observation with $1(10)ab^{-1}$
if $\mathcal{B}/\mathcal{B}_{SM} \leq 4.6(1.4)$

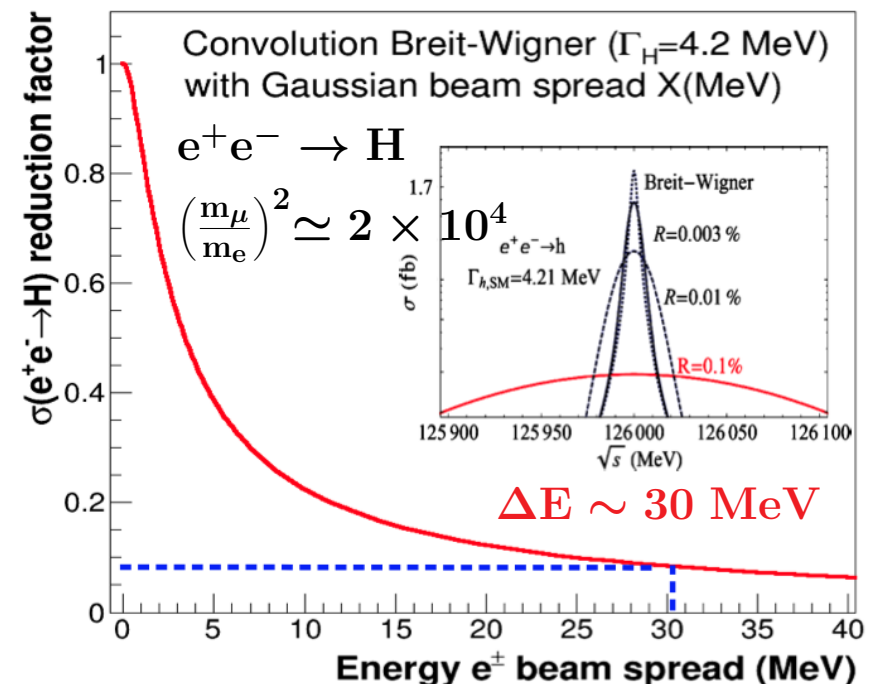
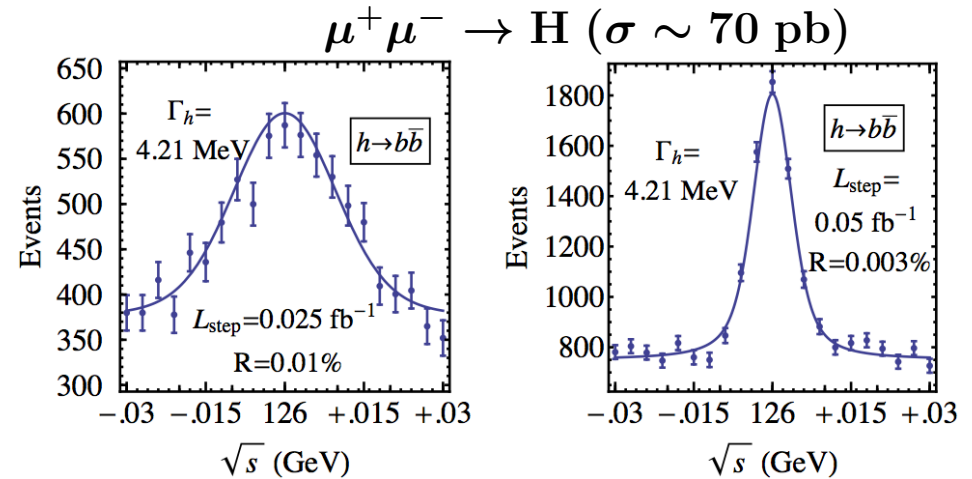

Additional 40% reduction due to ISR



Extracting Higgs couplings requires assumptions at LHC

$$\sigma\mathcal{B}(ii \rightarrow H \rightarrow ff) \sim \frac{\Gamma_{ii}\Gamma_{ff}}{\Gamma_H} = \sigma_{SM} \cdot \mathcal{B}_{SM} \frac{k_i^2 \cdot k_f^2}{k_H^2}$$

- ☞ Total width $\Gamma_H \propto k_H^2$ is not measurable (zero width approximation!)
 - ▮ assumed $k_H = \sum k_i BR_i$, only for i in SM
 - no contributions from BSM
 - ▮ ratios of couplings are model independent
- ☞ Γ_H is measurable directly at a e^+e^- collider!
- ☞ Most couplings will reach systematic limit at LHC
 - ▮ experimental uncertainties are scaled with luminosity... but how?
 - ▮ theoretical uncertainties affects the ultimate precision

Reducing theoretical uncertainties it is for sure worth the effort!

ATLAS Simulation

$\sqrt{s} = 14$ TeV: $\int Ldt=300 \text{ fb}^{-1}$; $\int Ldt=3000 \text{ fb}^{-1}$

$\int Ldt=300 \text{ fb}^{-1}$ extrapolated from 7+8 TeV

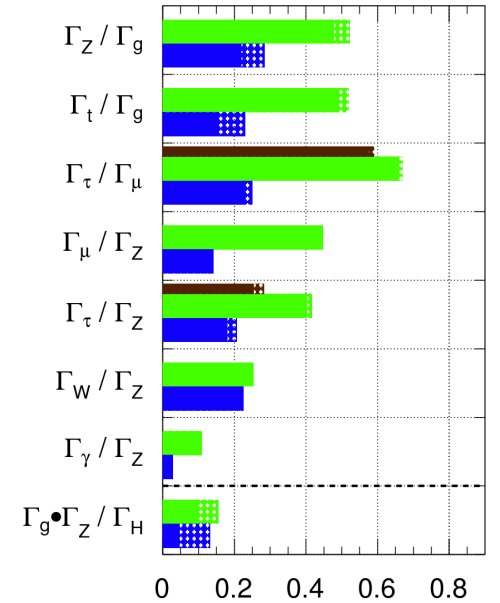

$$\frac{\Delta(\Gamma_X/\Gamma_Y)}{\Gamma_X/\Gamma_Y} \sim 2 \frac{\Delta(\kappa_X/\kappa_Y)}{\kappa_X/\kappa_Y}$$

CMS Projection

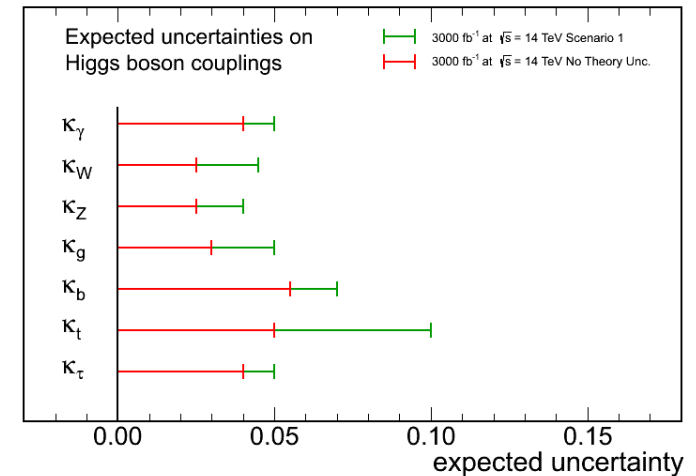

Extracting Higgs couplings requires assumptions at LHC

- ☞ Total width $\Gamma_H \sim k_H^2$ is not measurable
 - ☞ not possible to measure directly a production cross section as at a e^+e^- collider
- ☞ Follow recommendations and fit models described in Yellow Report 3 [\[arXiv:1307.1347\]](https://arxiv.org/abs/1307.1347)
 - ☞ assumed $k_H = \sum k_i BR_i$, only for i in SM
 - total width controlled by $H \rightarrow bb$
 - $H \rightarrow cc$ is a 5% inaccessible contribution (assumed to scale with bb)
 - no contributions from BSM
- ☞ Global fits targeting the k factors
 - ☞ do not resolve loops, effective coupling instead (k_γ , k_g and $k_{Z\gamma}$)

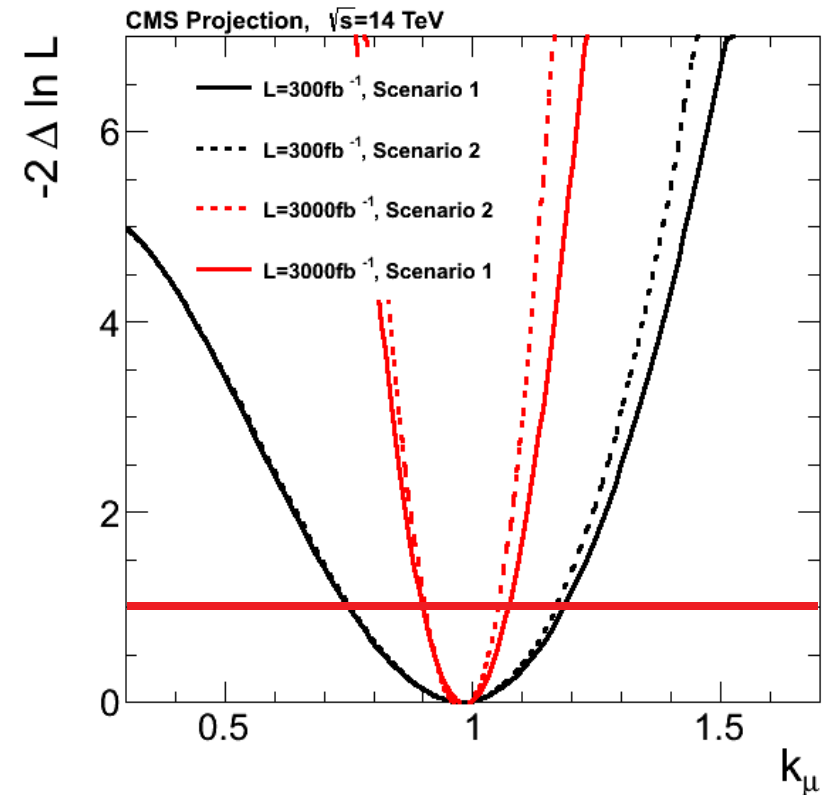

Results reported in terms of 68% uncertainties ($-2\Delta \ln L=1$) on k

[FTR-13-024]

Many BSM models have extra doublet (H, A, H⁺, H⁻)

- ☞ Search additional Higgs fields at high masses
- ☞ Performed full MC analysis of $H \rightarrow ZZ$ and $A \rightarrow Zh$ resonances in Type I and II 2HDM's
 - ☛ type II includes MSSM
 - ☛ constrained 2HDM parameter space of $\tan \beta$ and $\cos(\beta - \alpha)$
 - ☛ indirect constrain from coupling fits favor $\cos(\beta - \alpha) \rightarrow 0$ (the SM Higgs boson)
 - ☛ H/A decays have tt threshold effect
 - discovery potential $m_{H/A} < 2m_t$ (type II)

Direct search can probe region close to the alignment limit, that may still be allowed by coupling fits

