

doc. numbers:
DESY, FERMILAB, IFIC, IRFU
JLAB, KEK, PNNL-SA-160884, SLAC,
and more ...

October 19, 2021

The International Linear Collider: Report to Snowmass 2021

THE ILC INTERNATIONAL DEVELOPMENT TEAM AND THE ILC COMMUNITY

ABSTRACT

The International Linear Collider (ILC) is on the table now as a new global energy-frontier accelerator laboratory taking data in the 2030's. The ILC addresses key questions for our current understanding of particle physics. It is based on a proven accelerator technology. Its experiments will challenge the Standard Model of particle physics and will provide a new window to look beyond it. This document brings the story of the ILC up to date, emphasizing its strong physics motivation, its readiness for construction, and the opportunity it presents to the US and the global particle physics community.

Contents

1	Introduction	9
1.1	Context for the ILC	9
1.2	Outline	11
2	Outline of the ILC Physics Case	13
3	Route to the ILC	17
3.1	International Design Team	17
3.2	ILC Pre-Lab	17
3.3	ILC Laboratory	17
3.4	Timeline for ILC Detectors	17
4	ILC Accelerator	19
4.1	ILC accelerator design	19
4.1.1	Design evolution since the TDR	22
4.1.2	Superconducting RF Technology	23
4.1.3	Accelerator design	33
4.1.4	Civil engineering and site	43
4.1.5	Cost and schedule	44
4.2	ILC staging up to 1 TeV	47
4.2.1	Introduction	47
4.2.2	Parameters	48
4.2.3	Luminosity upgrade	48

4.2.4	Energy upgrade	49
4.2.5	Positron source	51
4.2.6	RTML	51
4.2.7	Beam Delivery System (BDS)	52
4.2.8	Polarization upgrade	52
4.2.9	Summary	52
4.3	ILC Scope beyond 1 TeV	53
4.3.1	Gradient status for the ILC baseline 250 GeV	53
4.3.2	High Gradient (45 MV/m) SRF for Upgrade Paths to 1 TeV	55
4.3.3	Toward 60 MV/m - Advanced Shape Cavities	56
4.3.4	Nb ₃ Sn	60
4.4	ILC Accelerator technical preparation plan	62
4.5	Opportunities for US contributions	68
4.5.1	Superconducting Linac	69
4.5.2	Electron and Positron Sources	71
4.5.3	Damping Ring, Beam Delivery System, and Beam Dump	71
4.5.4	Summary	71
5	General Aspects of the ILC Physics Environment	73
5.1	Key Standard Model Processes	73
5.2	Energy and Luminosity	73
5.3	Beam Polarization	73
6	ILC Detectors	75
6.1	Detector Requirements for the Physics Program	75
6.2	The ILD Detector	76
6.2.1	Science with ILD	84
6.2.2	Integration of ILD into the experimental environment	85
6.2.3	The ILD Concept Group	86
6.2.4	Conclusion and Outlook	86

6.3	The SiD Detector	87
6.3.1	Detector description and capabilities	87
6.3.2	R&D issues for the SiD design	94
6.4	New Technologies for ILC Detectors	96
6.4.1	Tracking	96
6.4.2	Calorimetry	96
6.4.3	Vertex Detector	96
6.4.4	Forward Detectors	96
6.4.5	Muon System	96
6.4.6	Timing Elements	96
7	ILC Detector Simulation	101
7.1	ILC Fast Simulation Frameworks	101
7.1.1	Delphes for ILC	101
7.1.2	SGV	101
7.2	ILCSOFT Framework	102
7.3	ILC SM Background Samples	102
8	ILC Physics Measurements at 250 GeV	103
8.1	Higgs – Conventional Decays	103
8.1.1	Zh cross-section and Higgs mass	104
8.1.2	Hadronic decays	105
8.1.3	Leptonic decays	106
8.1.4	EW-boson decays	106
8.1.5	CP properties	106
8.2	Higgs – Exotic Decays	107
8.3	W Boson	110
8.4	4-Fermion Processes	111
8.5	Precision QCD	111
8.6	Dark Sector	111

9	ILC Precision Electroweak Measurements	113
9.1	Introduction	113
9.2	Radiative Return to the Z	115
9.3	Measurement of Di-fermion cross sections	115
9.3.1	Strategy	116
9.3.2	Outlook	118
9.4	W and Z Boson Masses	119
9.5	W Boson Branching Fractions	119
10	ILC Physics Measurements at 350, 500, and 1000 GeV	121
10.1	Top Quark	121
10.1.1	Top Quark Mass	121
10.1.2	Top Quark Electroweak Couplings	123
10.1.3	FCNC searches	125
10.1.4	Unexplored areas	125
10.2	Higgs	125
10.2.1	WW fusion	125
10.2.2	Higgs Self-Coupling	126
10.2.3	Top Quark Yukawa Coupling	127
10.3	W Boson	127
10.4	4-Fermion Processes	127
10.5	New Particle Searches – TeV Scale	128
10.6	New Particle Searches – Dark Sector	128
11	ILC Fixed-Target Program	131
11.1	ILC Facilities for Fixed-Target Experiments	131
11.2	Beam-Dump Experiments	132
11.3	Dedicated Secondary-Beam Experiments	132
11.4	Nuclear and Hadron Physics with Electron and Positron Beams	132
11.5	ILC as an Accelerator Test-Bed	132

12 Precision Tests of the Standard Model	133
12.1 Precision Standard Model Theory for ILC	133
12.2 Frameworks for Effective Field Theory	134
12.3 Expectations from a Unified SMEFT Analysis	134
12.4 Expectations for CP-Violating Operators	134
12.5 Expectations for Heavy-Quark Operators	134
13 Big Physics Questions Addressed by ILC	135
13.1 Can the Standard Model be exact to very high energies?	136
13.2 Why is there more matter than antimatter?	138
13.3 What is the dark matter of the universe?	139
13.4 What is the energy scale of new physics?	141
13.5 Why is electroweak symmetry broken?	144
14 ILC Probes of the Big Questions	147
14.1 ILC and dark matter	147
14.2 ILC and supersymmetry	147
14.3 ILC and composite Higgs fields	148
14.4 ILC and CP violation	148
14.5 ILC and flavor	148
14.6 The Higgs Inverse Problem	148
15 Long-Term Future of the ILC Laboratory	149
15.1 Future Accelerators in the ILC Tunnel	149
15.1.1 Very High Gradient Superconducting RF	149
15.1.2 Very High Gradient Copper Accelerators	157
15.1.3 Plasma, Laser, and Structure Wakefield Accelerators	158
15.2 Physics Opportunities at Multi-TeV	160
15.3 Physics Opportunities at Multi-10 TeV	160
16 Conclusions	161

Chapter 1

Introduction

[3 pages; corresponding editor: Hitoshi Murayama (hitoshi@berkeley.edu)]

The ILC is a proposed next-generation e^+e^- collider. It starts with $\sqrt{s} = 250$ GeV as the Higgs factory, which provides typically an order of magnitude improvement in precision Higgs measurements beyond the HL-LHC. Such precision measurements will provide guidance to the next energy scale for future facilities. At the same time, it provides numerous searches for new physics with monophoton or invisible and exotic Higgs decays, for example into a light dark sector. It can host ancillary experiments with beam dump and/or near IP detectors to search for long-lived and invisible particles. It is technologically mature with a well-understood cost that is about the same as the LHC. The linear design allows for extensions to upgrade energies. The next steps would likely be the $t\bar{t}$ threshold and open $t\bar{t}$ as well as $t\bar{t}H$ production at 500–550 GeV. The site was specifically chosen to allow for an upgrade up to 1 TeV with the same technology, for the Higgs self-coupling measurement and many new physics searches. Superconducting RF cavity technology has an ample room for improvements, allowing for even a 3–4 TeV collider in the same tunnel. Future technologies such as plasma wakefield or dielectric laser accelerators may go into the tens of TeV energy range.

Below we describe the context for the ILC as it has evolved over half a century of development in particle physics.

1.1 Context for the ILC

The ILC stands at the end of a long history. The need for a linear collider was recognized already in 1960's given the energy loss due to unavoidable synchrotron radiation from beams in circular colliders. To achieve power-efficient acceleration, the development of superconducting radio frequency (SCRF) cavities started in earnest in the 1980's. Over four decades, intensive research and development achieved much higher acceleration gradients and reduced the costs of SCRF by more than an order of magnitude. SCRF provides better tolerances compared to room-temperature klystron-based designs, and was chosen as the ILC technology in 2005 by the International Tech-

nology Recommendation Panel chaired by Barry Barish (2017 Nobel Laureate in Physics). The International Committee for Future Accelerators, a body created by the International Union of Pure and Applied Physics in 1976 to facilitate international collaboration in the construction and use of accelerators for high energy physics, recommended the launch of the Global Design Effort (GDE) to produce a Technical Design Report (TDR) for the ILC as an international project. The GDE successfully produced the TDR in 2013 with a purposely site-independent design [1, 2, 3, 4, 5].

There is also a long history of discussions on the scientific merit for the ILC. The energy scale of the weak interaction, which makes the Sun burn and allows the synthesis of the chemical elements, was pointed out to be around 250 GeV in 1933 by Enrico Fermi. The need to reach this energy scale has been obvious since then, though the precise target energy was not clear. Early discussions for linear colliders called for 1000 GeV as a safe choice for guaranteed science output. The GDE focused on 500 GeV for the study of the Higgs boson based on the precision electroweak data of early 2000's. It was only in 2012 that the Higgs boson was discovered at the Large Hadron Collider (LHC) at CERN. This provided a clear target energy for the ILC at 250 GeV. In the same year, the Japanese Association of High-Energy Physicists (JAHEP) issued a report expressing interest in hosting the ILC in Japan with 250 GeV center-of-momentum energy as its first phase. The European Strategy for Particle Physics updated in 2013 highlighted “*the ILC, based on superconducting technology, will provide a unique scientific opportunity at the precision frontier.*” This was followed by the report of the US Prioritization Panel for Particle Physics Projects (P5) that listed “*Use the Higgs boson as a new tool for discovery*” as the first among the science drivers for particle physics and stated “*As the physics case is extremely strong, all (funding) Scenarios include ILC support*”.

Intense discussions ensued worldwide how to realize the ILC. Japanese government instituted a multitude of committees looking into the scientific and societal merit of hosting the ILC in Japan as well as its technological feasibility and costs. The US government encouraged Japan to host the ILC, with letters from the Secretary of Energy and the Deputy Secretary of State to Japanese Ministers. The 2020 update of the European Strategy for Particle Physics stated “*An electron-positron Higgs factory is the highest-priority next collider*” and added “*The timely realisation of the electron-positron International Linear Collider (ILC) in Japan would be compatible with this strategy and, in that case, the European particle physics community would wish to collaborate.*” Following this update, ICFA created the International Development Team (IDT) in August 2020 to prepare for the creation of prelab towards the realization of the ILC. The IDT is hosted by KEK, the national laboratory for high-energy accelerators in Japan.

Since its launch, IDT has collected information, worked with ICFA, interacted with the community, consulted the funding agencies, to formulate what is required of the ILC Pre-Lab. The Pre-Lab is envisioned to be a four-year process, finalizing the Engineering Design Report for the ILC in a site-specific fashion for the Kitakami mountain range in northern Japan, forging agreements among international partners, and recommending specific experiments for the ILC.

1.2 Outline

This report will update the documents prepared by ILC for the European Strategy for Particle Physics. These include a comprehensive review of the ILC up to 2019 [6] and a review of the ILC capabilities for precision measurement [7]. A comprehensive bibliography for the ILC, up to mid-2020, can be found in [8].

The outline of this report is the following: Chapter 2 will present the most important points of the physics case for the ILC. In Chapter 3, we will present the current plan and timeline for the realization of the ILC in Japan.

Chapter 4 will present the current state of the ILC accelerator design, including details of the various ILC energy stages up to a CM energy of 1 TeV. This chapter will also discuss the prospects for extension of the ILC to even higher energies and other issues for ILC accelerator R&D. It will conclude with a discussion of the opportunities and tentative plans for US contributions to the ILC accelerator.

Chapter 5 will review the basic aspects of the physics environment of the ILC—the major physics processes, the plan for stage-by-stage improvement in the energy and luminosity, and the key role played in the experimental program by electron and positron beam polarization.

Chapter 6 will describe the ILC detectors. We will begin with descriptions of the two current proposed detectors ILD and SiD, including the expected measurement capabilities and issues for which further R&D is needed. The chapter will conclude with a survey of new technologies that offer the promise of further improvements in the detector capabilities. Chapter 7 will describe the simulation framework used in studying the detector capabilities and projecting the measurement accuracy of physical observables.

Chapter 8 will describe the planned physics measurements at a CM energy of 250 GeV. These include measurements on the Higgs boson and the W boson, measurements of 2-fermion production, the ILC program in precision QCD, and descriptions of a number of relevant new particle searches.

Chapter 9 will describe the ILC program in precision electroweak measurements. This includes improvements of the precision electroweak parameters of the Z boson, both at 250 GeV through the radiative return reaction $e^+e^- \rightarrow \gamma Z$ and through a dedicated program of running at the Z resonance. It also includes high-precision measurements of the W boson mass and width and improved measurements of these properties for the Z boson.

Chapter 10 will describe the planned physics measurements at CM energies of 350 GeV and above, up to 1 TeV. The topics here include the ILC program of precision measurements of the top quark, the completion of the measurement of the Higgs boson profile, including the measurements of the Higgs self-coupling and the top quark Yukawa coupling, and the ultimate capabilities of the ILC in triple gauge boson couplings and new particle searches.

Chapter 11 will describe the fixed-target program that the intense, high-energy electron and positron beams of the ILC will make available.

Chapters 12-14 will address the interpretation of the ILC measurements. Chapter 12 will begin

with a review of the status of precision SM theory for ILC processes. It will then discuss the network of tests of the SM available at the ILC. This chapter will present a unified description of these tests using Standard Model Effective Field Theory (SMEFT), reviewing the conceptual basis of this approach and demonstrating its power in providing a unified interpretation of the full set of ILC experimental measurements. Chapter 13 will present a theoretical context for the expectation that the ILC will discover deviations from the SM predictions and the relation of such deviations to the most important question now being asked in particle physics. Chapter 14 will bring these two lines of analysis together, quantifying the ability of the ILC to overturn the SM and to provide evidence of the more correct underlying model for particle physics.

Finally, Chapter 15 will lay out some possible futures for the ILC laboratory with accelerators at still higher energies offering multi-TeV and multi-10-TeV electron, positron, and photon collisions.

Chapter 2

Outline of the ILC Physics Case

[4 pages; corresponding editor: Michael Peskin (mpeskin@slac.stanford.edu)]

The physics motivation for constructing the ILC is very strong. The flagship program of the ILC is the study of the Higgs boson at a much higher level of precision than has been possible at the LHC. The ILC will also carry out precision measurements of the other heavy and still-mysterious particle in the Standard Model, the top quark. It will carry out a program of specific searches for postulated new particles in regions that are very difficult for the LHC to access. Beyond these specific targets, the ILC will greatly improve the level of our understanding of the full set of electroweak processes in the region up to its final CM energy. In the context of Standard Model Effective Field Theory (SMEFT), these measurements will work together to strongly challenge the Standard Model. In this chapter, we will introduce each of these points and prepare the ground for a more detailed discussion later in this report.

We begin with the 125 GeV Higgs boson. This particle is the centerpiece of the SM, yet still we know little about it. From the LHC experiments, we now know that the couplings of the Higgs boson agree with those predicted in the SM, at the level of 20% accuracy for the major decay modes. However, this is not nearly sufficient to distinguish the minimal SM description of the Higgs boson from those of competing models. According to SMEFT, the deviations of Higgs couplings from SM predictions are parametrically of the order of m_h^2/M^2 , where M is the mass scale of additional new particles. Given the constraints from particle searches at the LHC, these deviations are expected to be at most of order 5-10%, and, to claim discovery of new physics, the deviations must be measured with high significance. This calls for a dedicated program to measure the full suite of couplings of the Higgs boson, and to push the precision of those measurements to the 1% level and below. This requires an e^+e^- collider such as the ILC.

The ILC is well-positioned to carry out this program of measuring the complete profile of the Higgs boson couplings. At 250 GeV, the ILC accesses the reaction $e^+e^- \rightarrow Zh$, producing about half a million Higgs bosons, each tagged by a recoil Z boson at the lab energy of 110 GeV. Looking in the opposite hemisphere, we will measure all of the branching ratios of the Higgs boson down to values of order 10^{-4} . These include 10 different modes of Higgs decay predicted in the SM, and also, possibly, invisible, partially-invisible, flavor changing, and other exotic modes of Higgs

decay. By counting recoil Z bosons, we will obtain an absolute measurement of the cross section for $e^+e^- \rightarrow Zh$, which can then be translated into absolute normalizations of the various partial widths.

At the second stage of the ILC at 500 GeV, the W fusion reaction $e^+e^- \rightarrow \nu\bar{\nu}h$ opens up. This reaction offers an event sample of about 1 million Higgs boson events in which the only visible signals in the event are from Higgs decay. This will not only allow new measurements to complement the 250 GeV data but also improved characterization of such issues as $h \rightarrow b\bar{b}/gg/c\bar{c}$ separation, angular distributions in $h \rightarrow WW^*$, and CP violation tests in $h \rightarrow \tau^+\tau^-$. The combination of the 250 and 500 GeV programs will give high confidence in any deviations from the SM detected in the Higgs boson data.

Running at 500 GeV and above also gives access to two important Higgs couplings that cannot be probed directly in Higgs decays, the Higgs coupling to $t\bar{t}$ and the Higgs self-coupling. Our studies of the ILC capabilities at 1 TeV predict truly archival measurements of these quantities, with errors below 2% and 10%, respectively.

Different models of new physics beyond the SM affect the various Higgs couplings differently. Since the ILC program can determine each Higgs coupling of the large set available, individually and without ambiguity, it will provide a pattern of deviations from the predictions of the SM that can distinguish different hypotheses about the underlying model.

The ILC program of experimental measurements on the Higgs boson will be described in Chapter 8 and 10 of this report, and the interpretation of these measurements will be discussed in some detail in Chapters 12 and 14.

The 500 GeV ILC will also give an excellent setting for the measurement of the mass and properties of the top quark. The mass of the top quark will be determined from the position of the sharp threshold in $e^+e^- \rightarrow t\bar{t}$. The threshold shape is determined by the short-distance top quark mass, so that the mass defined in this way, which is needed for high-precision predictions in and beyond the SM, is determined from the data without ambiguity. At e^+e^- colliders, the electroweak form factors of the top quark, which contain crucial information about the role of the top quark in electroweak symmetry breaking, determine the primary top quark pair production cross section. Thus, very high precision measurements of these form factors are possible. The ILC program of measurements on the top quark will be discussed in Chapter 10 of this report.

Beyond these SM particles, the ILC has the potential to access new particles predicted in models beyond the SM. The LHC experiments have given powerful access to proposed new particles with couplings to QCD, but their capability to discover particles with only electroweak couplings is limited. All LHC searches come with footnotes concerning the sizes of electroweak cross sections, the expected decay patterns, the amount of missing energy, and other features. Searches at the ILC will allow these footnotes to be eliminated, giving access to systems with large missing energy and other challenging features, in particular, to supersymmetry partners of the Higgs boson and to dark matter in models with compressed spectra. These issues will be described in Sections 8 and 10 of this report.

The ILC will dramatically improve the precision of our understanding of electroweak reactions.

The reaction $e^+e^- \rightarrow W^+W^-$, with strong dependence on both initial- and final-state polarizations, will allow us to dissect the structure of the triple-gauge-boson coupling. The reactions $e^+e^- \rightarrow f\bar{f}$ allow searches for additional electroweak resonances that access the 10-TeV mass range and are flavor- and helicity-specific. The study of radiative-return events ($e^+e^- \rightarrow \gamma Z$) at 250 GeV will already improve our precision knowledge of Z -fermion couplings beyond that obtained at LEP. A dedicated ILC “Giga- Z ” run at the Z resonance ($5 \times 10^9 Z$ s) will improve the precision of most electroweak observables by more than an order of magnitude. These measurements and others are described in Chapters 8, 9, and 10.

The simplicity of hadronic final states in e^+e^- annihilation also allows not only higher precision tests of QCD but also new observables that give insight into features such as jet substructure that have come to light at the LHC. This new program of QCD measurements will be described in Chapter 8.

The ILC will also make available the most intense and highest-energy electron and positron beams for beam dump and dedicated fixed-target experiments targeting light weakly-interacting particles. This program will be described in Chapter 11.

These measurements are very powerful already when they are considered separately, but they take on increased power when they are combined to stress-test the SM in coherent way. This becomes particularly clear when the full set of SM tests is analyzed using SMEFT. In this approach, corrections to the SM are described by contributions to an effective Lagrangian from operators of dimension 6 and higher invariant under the well-tested SM gauge symmetries. There is only one Lagrangian; its higher-dimension operators generally contribute to many electroweak reactions and so receive an array of experimental constraints. We will describe this method in detail and give examples of its powerful use in Chapter 12.

There is one more important point that we should make concerning the program of measurements of the ILC. The goal of testing the SM is not simply to improve the error bars. It is widely appreciated that the Standard Model of particle physics (SM), though it is very successful in describing the results of experiments, is not adequate as a complete theory of elementary particles. Thus, the goal of the ILC experiments must be to *prove that the SM is incomplete*, and to show the path to a better understanding of nature.

One way to prove the inadequacy of the SM is to discover a new resonance that the SM does not account for. This was the primary goal of the LHC experiments. So far, no such resonance has appeared. There is still considerable room to discover a new resonance at the HL-LHC, but that window is closing. It is important to open a new, complementary window, and this is what the ILC’s capability for precision tests of the SM will make available.

It is not straightforward, though, to demonstrate a deviation from the SM through precision measurements. First, of all, the deviation must be observed with high statistical significance. Second, the possible systematic errors that could mimic the deviation must be under complete control. This calls for multiple cross-checks on the sources of error and, if possible, measurements with different sources of systematic errors that can be compared. Finally, the view provided by precision measurements cannot be one-dimensional; rather, it should be part of a collective program that has the power to show a pattern of discrepancies. In the best case, a pattern of well-established

deviations from the SM can point to a common origin and thus indicate the nature of the true underlying theory.

The experimental program of the ILC is well-equipped to address these points. The general simplicity and cleanliness of e^+e^- annihilation provides an excellent starting point in the quest for precision. This environment allows the construction of detectors with high segmentation and very low material budget, allowing collider event measurements of unprecedented quality. In the energy region of the ILC, electroweak cross sections have a large and well-understood dependence on beam polarization. With both electron and positron beam polarization, the ILC will provide four distinct event samples at each energy to use in understanding measurements and backgrounds. As we have noted above for the Higgs boson program, changes in the center of mass energy can also bring in new physics processes that access and cross-check the variables targetted in precision measurements. The enabling features of the ILC experimental environment will be discussed in Chapter 5. The capabilities of detectors for the ILC and strategies for further improvement will be discussed in Chapter 6. Throughout the succeeding chapters, you will see these elements at work to insure the high quality of the ILC measurements.

The ILC thus offers a new approach to the discovery of physics beyond the SM, one of great capability and robustness. These experiments must be carried out. They have the power to lead us to a new stage in our understanding of fundamental physics.

Chapter 3

Route to the ILC

[8 pages; corresponding editor: Tatsuya Nakada, Hitoshi Murayama (hitoshi@berkeley.edu)]

(The organization, schedule, and prospects for the ILC will be explained in this chapter. These will be clearer after the ILC Pre-Lab is set up, a development expected in 2022. The current state of the ILC organization was presented by Tatsuya Nakada and others in the Monday plenary session of the LCWS 2021 workshop, <https://indico.cern.ch/event/995633/> .)

3.1 International Design Team

3.2 ILC Pre-Lab

3.3 ILC Laboratory

3.4 Timeline for ILC Detectors

Chapter 4

ILC Accelerator

[general corresponding editor: Shinichiro Michizono (shinichiro.michizono@kek.jp)]

4.1 ILC accelerator design

[10 pages; corresponding editor: Benno List (benno.list@desy.de)]

The International Linear Collider (ILC) is a 250 GeV (extendable up to 1 TeV) linear e^+e^- collider, based on 1.3 GHz superconducting radio-frequency (SCRF) cavities. It is designed to achieve a luminosity of $1.35 \cdot 10^{34} \text{ cm}^{-2}\text{s}^{-1}$ and provide an integrated luminosity of 400 fb^{-1} in the first four years of running. The electron beam will be polarised to 80 %, and positrons with 30 % polarization will be provided if the undulator based positron source concept is employed.

Its parameters have been set by physics requirements first outlined in 2003, updated in 2006, and thoroughly discussed over many years with the physics user community. After the discovery of the Higgs boson it was decided that an initial energy of 250 GeV provides the opportunity for a precision Standard Model and Higgs physics programme at a reduced initial cost [9]. Some relevant parameters are given in Tab. 4.1. This design evolved from two decades of R&D, described in Sec. 1, an international effort coordinated first by the GDE under ICFA mandate and since 2013 by the LCC.

The fundamental goal of the design of the ILC accelerator is a high energy-efficiency. The ILC design limits the overall power consumption of the accelerator complex during operation to 129 MW at 250 GeV and 300 MW at 1 TeV, which is comparable to the power consumption of CERN [11]. This is achieved by the use of SCRF technology for the main accelerator, which offers a high RF-to-beam efficiency through the use of superconducting cavities, operating at 1.3 GHz, where high-efficiency klystrons are commercially available. At accelerating gradients of 31.5 to 35 MV/m this technology offers high overall efficiency and reasonable investment costs, even considering the cryogenic infrastructure needed for the operation at 2 K.

The underlying TESLA technology is mature, with a broad industrial base throughout the

Quantity	Symbol	Unit	Initial	\mathcal{L} Upgrade	TDR	Upgrades	
Centre of mass energy	\sqrt{s}	GeV	250	250	250	500	1000
Luminosity	\mathcal{L}	$10^{34}\text{cm}^{-2}\text{s}^{-1}$	1.35	2.7	0.82	1.8/3.6	4.9
Polarisation for e^-/e^+	P_-/P_+	%	80/30	80/30	80/30	80/30	80/20
Repetition frequency	f_{rep}	Hz	5	5	5	5	4
Bunches per pulse	n_{bunch}	1	1312	2625	1312	1312/2625	2450
Bunch population	N_e	10^{10}	2	2	2	2	1.74
Linac bunch interval	Δt_b	ns	554	366	554	554/366	366
Beam current in pulse	I_{pulse}	mA	5.8	5.8	8.8	5.8	7.6
Beam pulse duration	t_{pulse}	μs	727	961	727	727/961	897
Average beam power	P_{ave}	MW	5.3	10.5	10.5	10.5/21	27.2
Norm. hor. emitt. at IP	$\gamma\epsilon_x$	μm	5	5	10	10	10
Norm. vert. emitt. at IP	$\gamma\epsilon_y$	nm	35	35	35	35	30
RMS hor. beam size at IP	σ_x^*	nm	516	516	729	474	335
RMS vert. beam size at IP	σ_y^*	nm	7.7	7.7	7.7	5.9	2.7
Luminosity in top 1%	$\mathcal{L}_{0.01}/\mathcal{L}$		73%	73%	87.1%	58.3%	44.5%
Beamstrahlung energy loss	δ_{BS}		2.6%	2.6%	0.97%	4.5%	10.5%
Site AC power	P_{site}	MW	129		122	163	300
Site length	L_{site}	km	20.5	20.5	31	31	40

Table 4.1: Summary table of the ILC accelerator parameters in the initial 250 GeV staged configuration (with TDR parameters at 250 GeV given for comparison) and possible upgrades. A 500 GeV machine could also be operated at 250 GeV with 10 Hz repetition rate, bringing the maximum luminosity to $5.4 \cdot 10^{34} \text{cm}^{-2}\text{s}^{-1}$ [10]. *UPDATE POWER NUMBERS*

world, and is in use at a number of free electron laser facilities that are in operation (E-XFEL at DESY, Hamburg), under construction (LCLS-II at SLAC, Stanford) or in preparation (SHINE in Shanghai) in the three regions Asia, Americas, and Europe that contribute to the ILC project. In preparation for the ILC, Japan and the U.S. have founded a collaboration for further cost optimisation of the TESLA technology. In recent years, new surface treatment technologies utilising nitrogen during the cavity preparation process, such as the so-called nitrogen infusion technique, have been developed at Fermilab, with the prospect of achieving higher gradients and lower loss rates with a less expensive surface preparation scheme than assumed in the TDR (see Sec. 4.3).

When the Higgs boson was discovered in 2012, the Japan Association of High Energy Physicists (JAHEP) made a proposal to host the ILC in Japan [12, 13]. Subsequently, the Japanese ILC Strategy Council conducted a survey of possible sites for the ILC in Japan, looking for suitable geological conditions for a tunnel up to 50 km in length (as required for a 1 TeV machine), and the possibility to establish a laboratory where several thousand international scientists can work and live. As a result, the candidate site in the Kitakami region in northern Japan, close to the larger cities of Sendai and Morioka, was found to be the best option. The site offers a large, uniform granite formation with no currently active faults and a geology that is well suited for tunnelling. Even in the great Tohoku earthquake in 2011, underground installations in this rock formation were essentially unaffected [14], which underlines the suitability of this candidate site.

This section starts with a short overview over the changes of the ILC design between the publication of the TDR in 2013 and today, followed by a description of the SCRF technology, and an description of the overall accelerator design and its subsystems. Thereafter, possible upgrade options are laid out, the Japanese candidate site in the Kitakami region is presented, and costs and schedule of the accelerator construction project are shown.

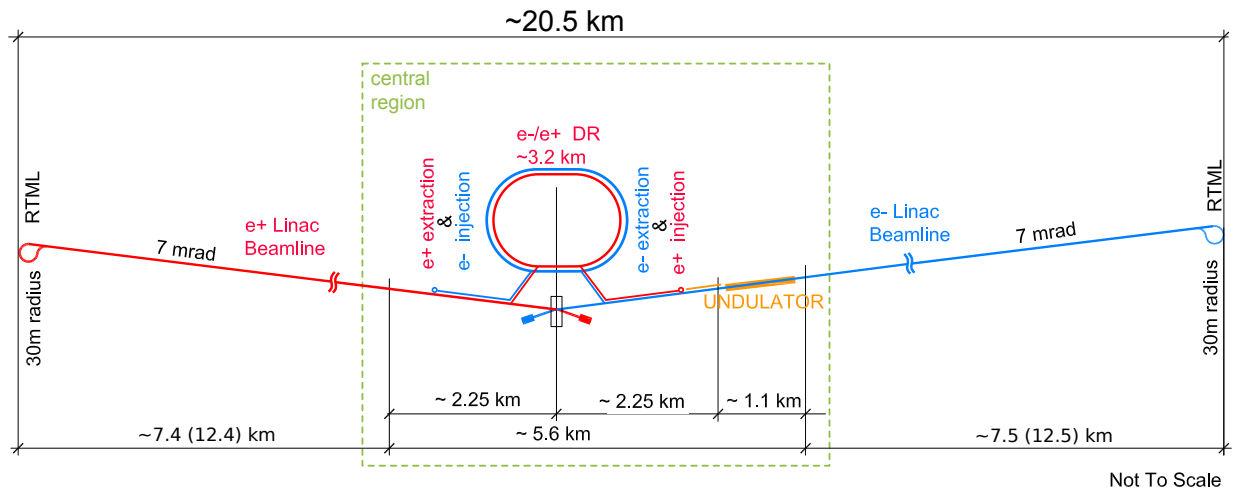

Figure 4.1: Schematic layout of the ILC in the 250 GeV staged configuration.

4.1.1 Design evolution since the TDR

Soon after the discovery of the Higgs boson, the Technical Design Report (TDR) for the ILC accelerator was published in 2013 [3, 4] after 8 years of work by the Global Design Effort (GDE). The TDR design was based on the requirements set forth by the ICFA mandated parameters committee [15]:

- a centre-of-mass energy of up to 500 GeV,
- tunability of the centre-of-mass energy between $\sqrt{s} = 200$ GeV and 500 GeV,
- a luminosity sufficient to collect 500 fb^{-1} within four years of operation, taking into account a three-year ramp up. This corresponds to a final luminosity of 250 fb^{-1} per year and an instantaneous luminosity of $\mathcal{L} = 2 \cdot 10^{34} \text{ cm}^{-2} \text{ s}^{-1}$,
- an electron polarisation of at least 80 %,
- the option for a later upgrade to energies up to 1 TeV.

The accelerator design presented in the TDR met these requirements (see Tab. 4.1), at an estimated construction cost of 7,982 MILCU for a Japanese site, plus 22.9 Mh (million hours) of labour in participating institutes [4, Sec. 15.8.4]. Costs were expressed in ILC Currency Units ILCU, where 1 ILCU corresponds to 1 US\$ at 2012 prices.

In the wake of the Higgs discovery, and the proposal by the Japan Association of High Energy Physicists (JAHEP) to host the ILC in Japan [12] with its recommendation to start with a 250 GeV machine [13], plans were made for a less expensive machine configuration with a centre-of-mass energy of $\sqrt{s} = 250$ GeV, around the maximum of the Zh production cross section, half the TDR value. Various options were studied in the TDR [4, Sect. 12.5] and later [16]. This resulted in a revised proposal [9] for an accelerator with an energy of 250 GeV and a luminosity of $\mathcal{L} = 1.35 \cdot 10^{34} \text{ cm}^{-2} \text{ s}^{-1}$, capable of delivering about 200 fb^{-1} per year, or 400 fb^{-1} within the first four years of operation, taking into account the ramp-up.

Several other changes of the accelerator design have been approved by the ILC Change Management Board since 2013, in particular:

- The free space between the interaction point and the edge of the final focus quadrupoles (L^*) was unified between the ILD and SiD detectors [17], facilitating a machine layout with the best possible luminosity for both detectors.
- A vertical access shaft to the experimental cavern was foreseen [18], allowing a CMS-style assembly concept for the detectors, where large detector parts are built in an above-ground hall while the underground cavern is still being prepared.
- The shield wall thickness in the Main Linac tunnel was reduced from 3.5 to 1.5 m [19], leading to a significant cost reduction. This was made possible by dropping the requirement for personnel access during beam operation of the main linac.

- Power ratings for the main beam dumps, and intermediate beam dumps for beam aborts and machine tuning, were reduced to save costs [20].
- A revision of the expected horizontal beam emittance at the interaction point at 125 GeV beam energy, based on improved performance expectations for the damping rings and a more thorough scrutiny of beam transport effects at lower beam energies, lead to an increase of the luminosity expectation from 0.82 to $1.35 \cdot 10^{34} \text{ cm}^{-2} \text{ s}^{-1}$ [21].
- The active length of the positron source undulator has been increased from 147 to 231 m to provide sufficient intensity at 125 GeV beam energy [22].

These changes contributed to an overall cost reduction, risk mitigation, and improved performance expectation.

Several possibilities were evaluated for the length of the initial tunnel. Options that include building tunnels with the length required for a machine with $\sqrt{s} = 350 \text{ GeV}$ or 500 GeV , were considered. In these scenarios, an energy upgrade would require the installation of additional cryomodules (with RF and cryogenic supplies), but little or no civil engineering activities. In order to be as cost effective as possible, the final proposal (see Figure 1), endorsed by ICFA [23], does not include these empty tunnel options.

While the length of the main linac tunnel was reduced, the beam delivery system and the main dumps are still designed to allow for an energy upgrade up to $\sqrt{s} = 1 \text{ TeV}$.



Figure 4.2: A 1.3 GHz superconducting niobium nine-cell cavity.

4.1.2 Superconducting RF Technology

The heart of the ILC accelerator consists of the two superconducting Main Linacs that accelerate both beams from 5 to 125 GeV. These linacs are based on the TESLA technology: beams are accelerated in 1.3 GHz nine-cell superconducting cavities made of niobium and operated at 2 K (Fig. 4.2). These are assembled into cryomodules comprising nine cavities or eight cavities plus a quadrupole/corrector/beam position monitor unit, and all necessary cryogenic supply lines (Fig. 4.3). Pulsed klystrons supply the necessary radio frequency power (High-Level RF HLRF) to the cavities by means of a waveguide power distribution system and one input coupler per cavity.

This technology was primarily developed at DESY for the TESLA accelerator project that was proposed in 2001. Since then, the TESLA technology collaboration [24] has been improving this

technology, which is now being used in several accelerators in operation (FLASH at DESY [25, 26], E-XFEL in Hamburg [27]), under construction (LCLS-II at SLAC, Stanford, CA [28]) or planned (SHINE in Shanghai [29, 30]).

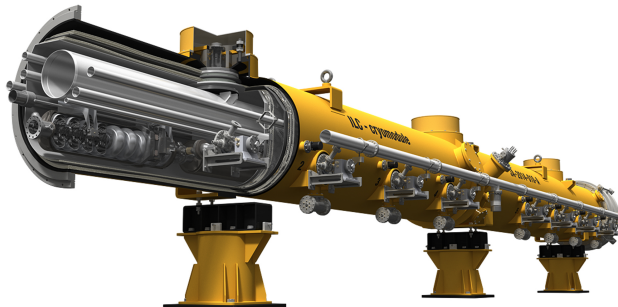

Figure 4.3: An ILC type cryomodule. ©Rey.Hori/KEK.

The quest for high gradients

The single most important parameter for the cost and performance of the ILC is the accelerating gradient g . The TDR baseline value is an average gradient $g = 31.5$ MV/m for beam operation, with a $\pm 20\%$ gradient spread between individual cavities. Recent progress in R&D for high gradient cavities raises the hope to increase the gradient by 10% to $g = 35$ MV/m, which would reduce the total cost of the 250 GeV accelerator by about 6%. To achieve the desired gradient in beam operation, the gradient achieved in the low-power vertical test (mass production acceptance test) is specified 10% higher to allow for operational gradient overhead for low-level RF (LLRF) controls, as well as some degradation during cryomodule assembly (few MV/m). Figure 4.17 shows how the achievable gradients have evolved over the past 50 years.

Gradient impact on costs: To the extent that the cost of cavities, cryomodules and tunnel infrastructure is independent of the achievable gradient, the investment cost per GeV of beam energy is inversely proportional to the average gradient achieved. This is the reason for the enormous cost saving potential from higher gradients. This effect is partially offset by two factors: the energy stored in the electromagnetic field of the cavity, and the dynamic heat load to the cavity from the electromagnetic field. These grow quadratically with the gradient for one cavity, and therefore linearly for a given beam energy. The electromagnetic energy stored in the cavity must be replenished by the RF source during the filling time that precedes the time when the RF is used to accelerate the beam passing through the cavity; this energy is lost after each pulse and thus reduces the overall efficiency and requires more or more powerful modulators and klystrons. The overall cryogenic load is dominated by the dynamic heat load from the cavities, and thus operation at higher gradient requires larger cryogenic capacity. Cost models that parametrise these effects indicate that the minimum of the investment cost per GeV beam energy lies at 50 or more GeV,

depending on the relative costs of tunnel, SCRF infrastructure and cryo plants, and depending on the achievable Q_0 [31]. Thus, the optimal gradient is significantly higher than the value of approximately 35 MV/m that is currently realistic; this emphasises the relevance of achieving higher gradients.

It should be noted that in contrast to the initial investment, the operating costs rise when the gradient is increased, and this must be factored into the cost model.

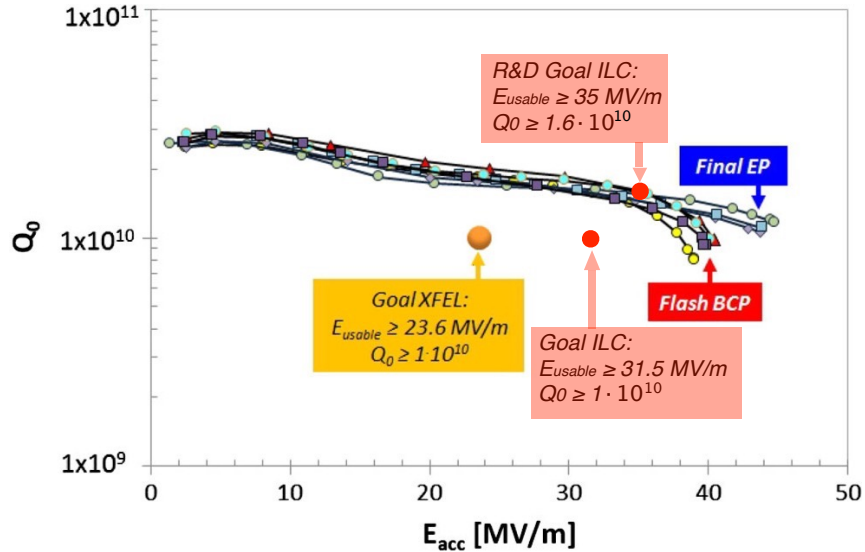

Figure 4.4: Examples of the $Q_0(E_{acc})$ curves of some of the best cavities, either treated at RI using “EP final”, or at EZ using “BCP flash.” [32, Fig. 19]. Vendor “RI” employs a production process that closely follows the ILC specifications, with a final electropolishing step. The ILC gradient / Q_0 goals are overlaid.

Results from E-XFEL cavity production: The production and testing of 831 cavities for the E-XFEL [32, 33] provides the biggest sample of cavity production data so far. Cavities were acquired from two different vendors, RI and EZ. Vendor RI employed a production process with a final surface treatment closely following the ILC specifications, including a final electropolishing (EP) step, while the second vendor EZ used buffered chemical polishing (BCP). The E-XFEL specifications asked for a usable gradient of 23.6 MV/m with a $Q_0 \geq 1 \cdot 10^{10}$ for operation in the cryomodule; with a 10% margin this corresponds to a target value of 26 MV/m for the performance in the vertical test stand for single cavities. Figure 4.4 shows the Q_0 data versus accelerating gradient of the best cavities received, with several cavities reaching more than 40 MV/m, significantly beyond the ILC goal, already with Q_0 values that approach the target value $1.6 \cdot 10^{10}$ that is the goal of future high-gradient R&D.

E-XFEL production data, in particular from vendor RI, provide excellent statistics for the cavity performance as received from the vendors, as shown in Fig. 4.5. For vendor RI, the yield for

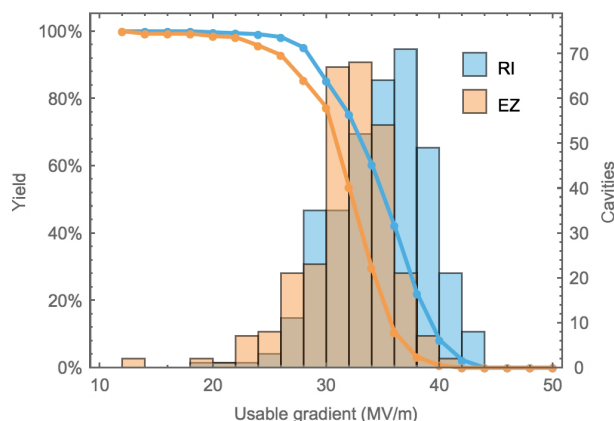

Figure 4.5: Distribution and yield of the “as received” maximum gradient of cavities produced for the E-XFEL, separated by vendor [33, Fig. 33]. Vendor RI employs a production process that closely follows the ILC specifications, with a final electro polishing step.

cavities with a maximum gradient above 28 MV/m is 85 %, with an average of 35.2 MV/m for the cavities that pass the cut.

Since the E-XFEL performance goal was substantially lower than the ILC specifications, cavities with gradient below 28 MV/m, which would not meet ILC specifications, were not generally re-treated for higher gradients, limiting our knowledge of the effectiveness of re-treatment for large gradients. Still, with some extrapolation it is possible to extract yield numbers applicable to the ILC specifications [34].

The E-XFEL data indicate that after re-treating cavities with gradients outside the ILC specification of $35 \text{ MV/m} \pm 20 \%$, *i.e.*, below 28 MV/m, a yield of 94 % for a maximum gradient above 28 MV/m can be achieved, with an average value of 35 MV/m, meeting the ILC specification. Taking into account limitations from Q_0 and the onset of field emission, the usable gradient is lower. This gives a 82 (91) % yield and an average usable gradient of 33.4 MV/m after up to one (two) re-treatments. The re-treatment and testing rate is significantly higher than assumed in the TDR, but the E-XFEL experience shows that re-treatment can mostly be limited to a simple high-pressure rinse (HPR) rather than an expensive electropolishing step.

Overall, the E-XFEL cavity production data prove that it is possible to mass-produce cavities meeting the ILC specifications as laid out in the TDR with the required performance and yield.

Basic parameters

The choice of operating frequency is a balance between the higher cost of larger, lower-frequency cavities and the increased cost at higher frequency associated with the lower sustainable gradient from the increased surface resistivity. The optimum frequency is in the region of 1.5 GHz, but during the early R&D on the technology, 1.3 GHz was chosen due to the commercial availability of

high-power klystrons at that frequency.

Cavities

The superconducting accelerating cavities for the ILC are nine-cell structures made out of high-purity niobium (Fig. 4.2), with an overall length of 1.25 m. Cavity production starts from niobium ingots which are forged and rolled into 2.8 mm thick niobium sheets that are individually checked for defects by an eddy current scan and optical inspection [3]. Cavity cells are produced by deep-drawing the sheets into half cells, 18 of which are joined by electron beam welding with two end groups to form the whole structure. This welding process is one of the most critical and cost-intensive steps of the cavity manufacturing procedure. Utmost care must be taken to avoid irregularities, impurities and inclusions in the weld itself, and deposition of molten material at the inner surface of the cavity that can lead to field emission.

After welding, the inner surface of the cavity must be prepared. The process is designed to remove material damage incurred by chemical procedures during the fabrication process, chemical residues from earlier production steps, hydrogen in the bulk niobium from earlier chemical processing, and contamination from particles. In a last step, the cavity is closed to form a hermetically sealed structure ready for transport. The treatment steps involve a series of rinses with ethanol or high pressure water, annealing in a high purity vacuum furnace at 800°C and 120°C, and electropolishing or buffered chemical polishing. The recipe for the surface preparation has been developed over a long time. Still, it remains subject to optimisation, since it is a major cost driver for the cavity production and largely determines the overall performance and yield of the cavities. In particular the electropolishing steps are complicated and costly, as they require complex infrastructure and highly toxic chemicals. One advantage of nitrogen infusion (see Sec. 4.1.2) is that the final electropolishing step is omitted.

Careful quality control during the production process is of high importance. At the E-XFEL, several quality controls were conducted by the manufacturer during production, with nonconformities reported to the institute responsible for the procurement, where a decision was made whether to accept or reject a part [32]. With this “build to print” approach, in which the manufacturer guarantees that a precise production process will be followed but does not guarantee a specific performance, procurement costs are reduced, because the manufacturer does not carry, and does not charge for, the performance risk.

Upon reception from the manufacturer, cavities are tested in a vertical cryostat (“vertical test”), where Q_0 is measured as a function of the gradient. Cavities that fall below the specified gradient goal are re-treated by an additional (expensive) electropolishing step or a comparatively simple high-pressure rinse. After retreatment, the vertical test is repeated.

Re-treatment and tests constitute a major cost driver in cavity production. For the ILC TDR, it was assumed that 25% of the cavities would fall below the 28 MV/m gradient threshold and undergo re-treatment and a second vertical test. E-XFEL data from the vendor “RI” that followed the ILC production recipe indicate that 15% to 37% of the cavities fall below 28 MV/m, depending on whether the maximum or the “usable” achieved gradient is considered [34]. However, E-XFEL

experience also shows that, in most of the cases, a high-pressure rinse is sufficient as re-treatment to remove surface defects, which is a cost saving compared to the electropolishing assumed in the TDR.

After successful testing, prior to installation in the cryomodule, cavities are equipped with a magnetic shield and the frequency tuner, which exerts mechanical force on the cavity to adjust the resonant frequency to the frequency of the external RF field [4, Sect. 3.3].

Power coupler

The power coupler transfers the radio frequency (RF) power from the waveguide system to the cavity. In the ILC, a coupler with a variable coupling is employed; this is realised using a movable antenna. Another role of the coupler is to separate the cavity vacuum from the atmospheric pressure in the waveguide, and to insulate the cavity at 2 K from the surrounding room temperature. Thus, the coupler has to fulfill a number of demanding requirements: transmission of high RF power with minimal losses and no sparking, vacuum tightness and robustness against window breaking, and minimal heat conductivity. As a consequence, the coupler design is highly complex, with a large number of components and several critical high-tech manufacturing steps.

The baseline coupler design was originally developed in the 1990s for the TESLA Test Facility (TTF, now FLASH) at DESY, and has since been modified by a collaboration of LAL and DESY for use in the E-XFEL. About 840 of these couplers (depicted in Fig. 4.6) were fabricated by three different companies for the E-XFEL [35], where 800 are now in operation. A lot of experience has been gained from this production [36].

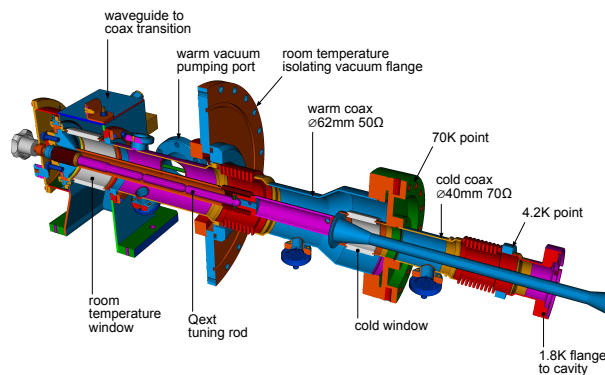

Figure 4.6: An E-XFEL type coupler.

Cryomodules

To facilitate transportation, installation and operation, 8 or 9 cavities are integrated into a 12.6 m long cryomodule (Fig. 4.3), which houses the cavities, thermal insulation, and all necessary supply tubes for liquid and gaseous helium at 2 – 80 K temperature.

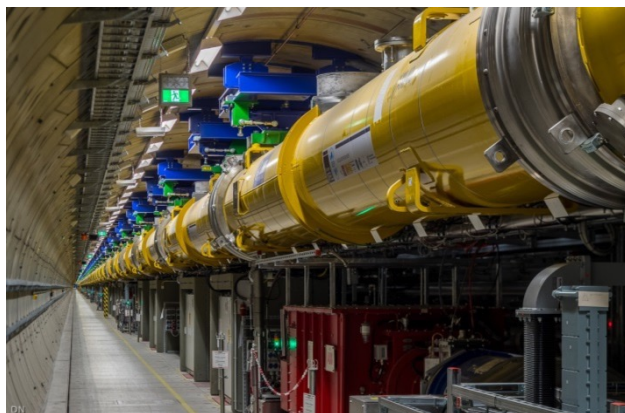

Figure 4.7: View of installed cryomodules in the tunnel of the E-XFEL [37].

Nine of these cryomodules are connected in the tunnel to form a cryostrapping with a common liquid helium supply. RF for one such string is provided by two klystrons. No separate helium transfer line is necessary, as all helium transport lines are integrated within the modules. A quadrupole / beam position monitor / corrector magnet unit is mounted instead of the 9th cavity in every third module. Figure 4.7 shows installed cryomodules in the tunnel of the E-XFEL [37].

Cryomodule assembly requires a dedicated facility with large clean rooms, especially trained, experienced personnel, and thorough quality control [38]. The cryomodules are certified for liquid helium pressure of up to 2 bar. Thus they must conform to the applicable pressure vessel codes, which brings with it very stringent documentation requirements for all pressure bearing parts [39].

For the E-XFEL project, 103 cryomodules were assembled in a facility built and operated by CEA [40, 38] and industrial partners, demonstrating the successful industrialization of the assembly process, with a final throughput of one cryomodule every four working days. This production rate is close to the rate envisaged for a possible European contribution of 300 cryomodules to a 250 GeV ILC in Japan.

While the design gradient for E-XFEL accelerator modules of 23.6 MV/m is significantly lower than the aim of 31.5 – 35 MV/m for the ILC, a number of cryomodules have been built around the world that come close or reach the ILC TDR specification of 31.5 MV/m: An E-XFEL prototype module at DESY reached 30 MV/m [41], Fermilab has demonstrated cryomodule operation at the ILC specification of 31.5 MV/m [42], and KEK has reported stable pulsed operation of a cryomodule at 36 MV/m [43].

Figure 4.8 shows the average cavity gradients per cryomodule for the E-XFEL serial-production cryomodules [44]. In the tests, the gradients were limited administratively to 31 MV/m; the true maxima might be higher. For almost all of the modules, the cavity gradients are significantly above the E-XFEL specification of 23.6 MV/m.

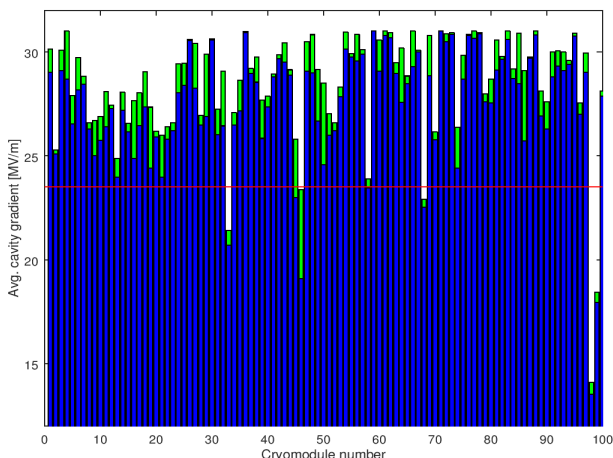

Figure 4.8: Average of the operating (blue) and maximum (green) gradient for cavities in each E-XFEL serial-production cryomodule. The specification of 23.6 MV/m is marked by a red line [44]. Modules 98 and 99 were assembled from the lowest-performing cavities.

Plug-compatible design

In order to allow various designs of sub-components from different countries and vendors to work together in the same cryomodule, a set of interface definitions has been internationally agreed upon. This “plug-compatible” design ensures that components are interchangeable between modules from different regions and thus reduces the cost risk. Corresponding interface definitions exist for the cavity, the fundamental-mode power coupler, the mechanical tuner and the helium tank. The “S1Global” project [45] has successfully built a single cryomodule from several cavities equipped with different couplers and tuners, demonstrating the viability of this concept.

High-level radio-frequency

The high-level radio-frequency (HLRF) system provides the RF power that drives the accelerating cavities. The system comprises modulators, pulsed klystrons, and a waveguide power distribution system.

Modulators: The modulators provide the short, high-power electrical pulses required by the pulsed klystrons from a continuous supply of electricity. The ILC design foresees the use of novel, solid state Marx modulators. These modulators are based on a solid-state switched capacitor network, where capacitors are charged in parallel over the long time between pulses, and discharged in series during the short pulse duration, transforming continuous low-current, low voltage electricity into short high-power pulses of the required high voltage of 120 kV at a current of 140 A, over 1.65 ms. Such Marx modulators have been developed at SLAC [46] and successfully tested at KEK [47]. However, long-term data about the required large mean time between failures (MTFB)

are not yet available.

Klystrons: The RF power to drive the accelerating cavities is provided by 10 MW L-band multi-beam klystrons. Devices meeting the ILC specifications were initially developed for the TESLA project, and later for the E-XFEL. They are now commercially available from two vendors (Thales and Toshiba), both of which provided klystrons for the E-XFEL. The ILC specifications ask for a 65 % efficiency (drive beam to output RF power), which are met by the existing devices.

Recently, the High Efficiency International Klystron Activity (HEIKA) collaboration [48, 49] has been formed that investigates novel techniques for high-efficiency klystrons. Taking advantage of modern beam dynamic tools, methods such as the Bunching, Alignment and Collecting (BAC) method [50] and the Core Oscillation Method (COM) [51] (Fig. 4.9) have been developed that promise increased efficiencies up to 90 % [52]. One advantage of these methods is that it is possible to increase the efficiency of existing klystrons by equipping them with a new electron optics, as was demonstrated retrofitting an existing tube from VDBT, Moscow. This increased the output power by almost 50 % and its efficiency from 42 % to 66 % [53].

To operate the ILC at an increased gradient of 35 MV/m would require that the maximum klystron output power is increased from 10 to 11 MW. It is assumed that this will be possible by applying the results from this R&D effort to high-efficiency klystrons.

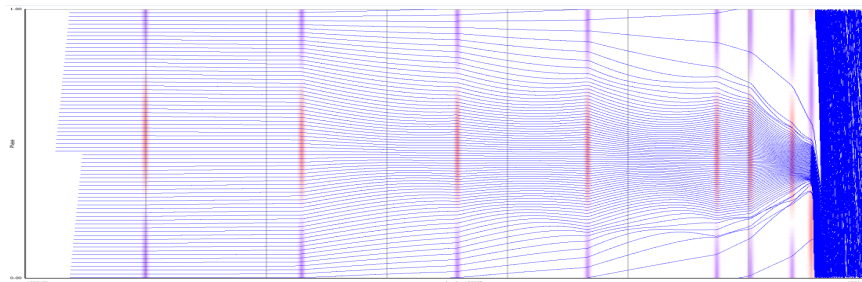

Figure 4.9: Electron phase profile of an 800 MHz klystron employing the Core Oscillation Method (COM) [51].

Local Power-Distribution System (LPDS): In the baseline design, a single RF station with one modulator and klystron supplies RF to 39 cavities, which corresponds to 4.5 cryomodules [4, Sec. 3.6.4]. Then 2 klystrons drive a 9 cryomodule cryo-string unit. The power is distributed by the LPDS, a system of waveguides, power dividers and loads. All cavities from a 9-cavity module and half of a 8-cavity module are connected in one LPDS, and three such LPDS units are connected to one klystron. This arrangement allows an easy refurbishment such that a third klystron can be added to a cryo-string, increasing the available power per cavity by 50 % for a luminosity upgrade (cf. Sec. ??).

The LPDS design must provide a cost-effective solution for the distribution of the RF power with minimal losses, and at the same time provide the flexibility to adjust the power delivered to

each cavity by at least $\pm 20\%$ to allow for the specified spread in maximum gradient. The LPDS design therefore contains remotely controlled, motor-driven Variable Power Dividers (VPD), phase shifters, and H-hybrids that can distribute the power with the required flexibility. This design allows one to optimise the power distribution during operation, based on the cavity performance in the installed cryomodule, and thus to get the optimum performance out of the system. It does not require a measurement of the individual cavity gradients after the module assembly, and is thus compatible with the ILC production scheme, where only a fraction of the cryomodules are tested. This is a notable difference from the scheme employed at the E-XFEL, where 100% of the modules were tested, and the power distribution for each module was tailored to the measured cavity gradients, saving investment costs for the LPDS but making the system less flexible.

Cryogenics

The operation of the large number of superconducting cryomodules for the main linacs and the linacs associated with the sources requires a large-scale supply of liquid helium. The cryomodules operate at 2 K and are cooled with superfluid helium, which at 2 K has a vapour pressure of about 32 mbar.

The accelerator is supplied with liquid helium by several cryogenic plants [4, Sec. 3.5] of a size similar to those in operation at CERN for the LHC, at Fermilab, and DESY, with a cooling capacity equivalent to about 19 kW at 4.5 K. The 2 K and 4.5 K helium refrigerators are located in an underground access hall [54] that is connected to the surface, where the helium compressors, gas tanks and further cryogenic infrastructure are located. The total helium inventory is approximately 310000 liquid litres or about 41 metric tonnes, about one third of the LHC's helium inventory. A factor 2 more helium is needed for 500 GeV operation.

Series production and industrialisation

Due to the construction of the E-XFEL, the industrial basis for the key SCRF components is broad and mature. In all three regions (Europe, America, Asia), several vendors for cavities have been qualified for ILC type cavities, and provided cost estimates in the past. RF couplers have also been successfully produced by European and American vendors for the E-XFEL and LCLS-II projects.

ILC/TESLA type cryomodules have been built in laboratories around the world (DESY, CEA in Europe, FNAL and JLAB in America, KEK in Asia). Series production has been established in America at Fermilab and JLAB for LCLS-II. The largest series production was conducted by CEA in France, again for the E-XFEL, with the assembly of 103 cryomodules in total by an industrial partner under the supervision of CEA personnel, with a final throughput of one cryomodule produced every four working days.

ILC type, pulsed 10 MW klystrons are commercially available from two vendors in Japan and Europe.

4.1.3 Accelerator design

Electron and positron sources

The electron and positron sources are designed to produce 5 GeV beam pulses with a bunch charge that is 50% higher than the design bunch charge of 3.2 nC ($2 \cdot 10^{10}$ e), in order to have sufficient reserve to compensate any unforeseen inefficiencies in the beam transport. In the baseline design, both sources produce polarized beams with the same time structure as the main beam, *i.e.*, 1312 bunches in a 727 μ s long pulse.

The electron source design [4] is based on the SLC polarized electron source, which has demonstrated that the bunch charge, polarisation and cathode lifetime parameters are feasible. The long bunch trains of the ILC do require a newly developed laser system and powerful preaccelerator structures, for which preliminary designs are available. The design calls for a Ti:sapphire laser impinging on a photocathode based on a strained GaAs/GaAsP superlattice structure, which will produce electron bunches with an expected polarisation of 85%, sufficient for 80% beam polarization at the interaction point, as demonstrated at SLAC [55].

The positron source poses a larger challenge.

In the baseline design, hard gamma rays are produced in a helical undulator driven by the main electron beam, which are converted to positrons in a rotating target. Positrons are captured in a flux concentrator or a quarter wave transformer, accelerated to 400 MeV in two normal conducting preaccelerators followed by a superconducting accelerator very similar to the main linac, before they are injected into the damping rings at 5 GeV. The helical undulators produce photons with circular polarisation, which is transferred to the positrons produced in the target, which are longitudinally polarised as a result. The positron polarisation thus achieved is 30%. The E-166 experiment at SLAC has successfully demonstrated this concept [56], albeit at intensities much lower than foreseen for the ILC. Technological challenges of the undulator source concept are the target heat load, the radiation load in the flux concentrator device, and the dumping of the high intensity photon beam remnant.

As an alternative, an electron-driven positron source concept has been developed. In the electron-driven scheme, a 3 GeV electron beam from a dedicated normal conducting linac produces positrons in a rotating target. The electron drive beam, being independent from the main linac, has a completely different time structure. Positrons are produced in 20 pulses at 300 Hz with 66 bunches each. With this scheme, it takes about 67 ms to produce the positrons needed for a single Main Linac pulse with its 1312 bunches, compared to 0.8 ms for the undulator source. This different time structure spreads the heat load on the target over a longer time, allowing a target rotation speed of only 5 m/s rather than 100 m/s, which reduces the engineering complexity of the target design, in particular the vacuum seals of the rotating parts. Although not free from its own engineering challenges, such as the high beam loading in the normal conducting cavities, the electron driven design is currently considered to be a low risk design that is sure to work.

Aside from the low technical risk, the main advantage of the electron driven design is the independence of positron production and electron main linac operation, which is an advantage for

accelerator commissioning and operation in general. In particular, electron beam energies below 120 GeV for operation at the Z resonance or the WW threshold would be no problem. The undulator source, on the other hand, offers the possibility to provide beams at the maximum repetition rate of 10 Hz given by the damping time in the damping rings of 100 ms, whereas the electron driven scheme is limited to 6 Hz due to the additional 66 ms for positron production. The main difference between the concepts is the positron polarisation offered by the undulator source, which adds significantly to the physics capabilities of the machine. The physics implications of positron polarization is discussed later in the report, in Sec. 5.3.

Both concepts have been reviewed recently [22] inside the ILC community, with the result that both source concepts appear viable, with no known show stoppers, but they require some more engineering work. The decision on the choice will be taken once the project has been approved, based on the physics requirements, operational aspects, and technological maturity and risks.

Beam polarisation and spin reversal At the ILC, the electron beam and potentially the positron beam are longitudinally polarised at the source, *i.e.*, the polarisation vector is oriented parallel or antiparallel to the beam direction. Whenever a longitudinally polarised beam of energy E_{beam} is deflected by an angle θ_{bend} , the polarisation vector undergoes a precession through an angle $\theta_{\text{pol}} = \gamma a \theta_{\text{bend}}$ [57], with the Lorentz factor $\gamma = E_{\text{beam}}/m_e$ and the electron's anomalous magnetic moment $a = (g - 2)/2$. To preserve the longitudinal beam polarisation during the long transport from the source through the damping rings to the start of the main linac, which involves many horizontal bends, the beam polarisation vector is rotated into the transverse plane, perpendicular to the damping ring plane, before the beam is transferred to the damping rings, and rotated back to a longitudinal direction by a set of spin rotators at the end of the RTML (see Sec. 4.1.3). Through the use of two rotators, it is possible to bring the polarisation vector into any desired direction, and compensate any remaining net precession between these spin rotators and the interaction point, so that any desired longitudinal or transverse polarisation at the IP can be provided.

To control systematic effects, fast helicity reversal is required. This is helicity reversal of each beam independently, on a pulse to pulse basis, which must be achieved without a change of the magnetic fields of the spin rotator magnets. For the electron beam, a fast helicity reversal is possible through a flip of the cathode laser polarisation. For the undulator-based positron source, the photon polarisation is given by the undulator field. Two parallel sets of spin rotators in front of the damping rings are used that rotate the polarisation vector either to the $+y$ or $-y$ direction. With this scheme, fast kickers can select a path through either of the two spin rotators and thus provide a fast spin reversal capability [57, 58].

Damping rings

The ILC includes two oval damping rings of 3.2 km circumference, sharing a common tunnel in the central accelerator complex. The damping rings reduce the horizontal and vertical emittance of the beams by almost six orders of magnitude¹ within a time span of only 100 ms, to provide the

¹The vertical emittance of the positrons is reduced from $\epsilon_y \approx 0.8 \mu\text{m}$ to 2 pm.

low emittance beams required at the interaction point. Both damping rings operate at an energy of 5 GeV.

The damping rings' main objectives are

- to accept electron and positron beams at large emittance and produce the low-emittance beams required for high-luminosity production.
- to dampen the incoming beam jitter to provide highly stable beams.
- to delay bunches from the source and allow feed-forward systems to compensate for pulse-to-pulse variations in parameters such as the bunch charge.

Compared to today's fourth generation light sources, the target value for the normalized beam emittance ($4\ \mu\text{m}/20\ \text{nm}$ for the normalised horizontal / vertical beam emittance) is low, but not a record value, and it is thus considered to be a realistic goal.

The main challenges for the damping ring design are to provide

- a sufficient dynamic aperture to cope with the large injected emittance of the positrons.
- a low equilibrium emittance in the horizontal plane.
- a very low emittance in the vertical plane.
- a small damping time constant.
- damping of instabilities from electron clouds (for the positron DR) and fast ions (for the electron DR).
- a small (3.2 – 6.4 ns) bunch spacing, requiring very fast kickers for injection and ejection.

Careful optimization has resulted in a TME (Theoretical Minimum Emittance) style lattice for the arcs that balances a low horizontal emittance with the required large dynamic aperture [4, Chap. 6]. Recently, the horizontal emittance has been reduced further by lowering the dispersion in the arcs through the use of longer dipoles [21]. The emittance in the vertical plane is minimised by careful alignment of the magnets and tuning of the closed orbit to compensate for misalignments and field errors, as demonstrated at the CESR-TA facility [59].

The required small damping time constant requires large synchrotron radiation damping, which is provided by the insertion of 54 wigglers in each ring. This results in an energy loss of up to 7.7 MV per turn and up to 3.3 MW RF power to store the positron beam at the design current of 390 mA. This actually exceeds the average beam power of the accelerated positron beam, 2.6 MW at a 250 GeV.

Electron cloud (EC) and fast ion (FI) instabilities limit the overall current in the damping rings to about 400 – 800 mA, where the EC limit that affects the positrons is assumed to be more stringent. These instabilities arise from electrons and ions being attracted by the circulating beam

towards the beam axis. A low base vacuum pressure of 10^{-7} Pa is required to limit these effects to the required level. In addition, gaps between bunch trains of around 50 bunches are required in the DR filling pattern, which permits the use of clearing electrodes to mitigate EC formation. These techniques have been developed and tested at the CESR-TA facility [60]

In the damping rings, the bunch separation is only 6.4 ns (3.2 ns for a luminosity upgrade to 2625 bunches). Extracting individual bunches without affecting their emittance requires kickers with rise/fall times of 3 ns or less. Such systems have been tested at ATF [61].

The damping ring RF system will employ superconducting cavities operating at half the Main Linac frequency (650 MHz). Klystrons and accelerator modules can be scaled from existing 500 MHz units in operation at CESR and KEK [4, Sec. 6.6].

Low emittance beam transport: ring to Main Linac (RTML)

The Ring to Main Linac (RTML) system [4, Chap. 7] is responsible for transporting and matching the beam from the Damping Ring to the entrance of the Main Linac. Its main objectives are

- transport of the beams from the Damping Rings at the center of the accelerator complex to the upstream ends of the Main Linacs,
- collimation of the beam halo generated in the Damping Rings,
- rotation of the spin polarisation vector from the vertical to the desired angle at the IP (typically, in longitudinal direction).

The RTML consists of two arms for the positrons and the electrons. Each arm comprises a damping ring extraction line transferring the beams from the damping ring extraction into the main linac tunnel, a long low emittance transfer line (LTL), the turnaround section at the upstream end of each accelerator arm, and a spin rotation and diagnostics section.

The long transport line is the largest, most costly part of the RTML. The main challenge is to transport the low emittance beam at 5 GeV with minimal emittance increase, and in a cost-effective manner, considering that its total length is about 14 km for the 250 GeV machine.

In order to preserve the polarisation of the particles generated in the sources, their spins are rotated into a vertical direction (perpendicular to the Damping Ring plane) before injection into the Damping Rings. A set of two rotators [62] employing superconducting solenoids allows to rotate the spin into any direction required.

At the end of the RTML, after the spin rotation section and before injection into the bunch compressors (which are considered part of the Main Linac, not the RTML [63]), a diagnostics section allows measurement of the emittance and the coupling between the horizontal and vertical plane. A skew quadrupole system is included to correct for any such coupling.

A number of circular fixed-aperture and rectangular variable-aperture collimators in the RTML provide betatron collimation at the beginning of the LTL, in the turn around and before the bunch compressors.

Bunch compressors and Main Linac



Figure 4.10: Artist's rendition of the ILC Main Linac tunnel. The shield wall in the middle has been removed. ©Rey.Hori/KEK.

The heart of the ILC are the two Main Linacs, which accelerate the beams from 5 to 125 GeV. The linac tunnel, as depicted in Figs. 4.10 and 4.11, has two parts, separated by a shield wall. One side (on the right in Fig. 4.10) houses the beamline with the accelerating cryomodules as well as the RTML beamline hanging on the ceiling. The other side contains power supplies, control electronics, and the modulators and klystrons of the High-Level RF system. The concrete shield wall (indicated as a dark-grey strip in in Fig. 4.10) has a thickness of 1.5 m [19]. The shield wall allows access to the electronics, klystrons and modulators during operation of the klystrons with cold cryomodules, protecting personnel from X-ray radiation emanating from the cavities caused by dark currents. Access during beam operation, which would require a wall thickness of 3.5 m, is not possible.

The first part of the Main Linac is a two-stage bunch compressor system [4, Sec. 7.3.3.5], each consisting of an accelerating section followed by a wiggler. The first stage operates at 5 GeV, with no net acceleration, the second stage accelerates the beam to 15 GeV. The bunch compressors reduce the bunch length from 6 to 0.3 mm.

After the bunch compressors, the Main Linac continues for about 6 km with a long section consisting entirely of cryomodules, bringing the beam to 125 GeV.

RF distribution: Each cryomodule contains 9 cavities, or for every third module, 8 cavities and a package with a superconducting quadrupole, corrector magnets, and beam position monitor. Nine

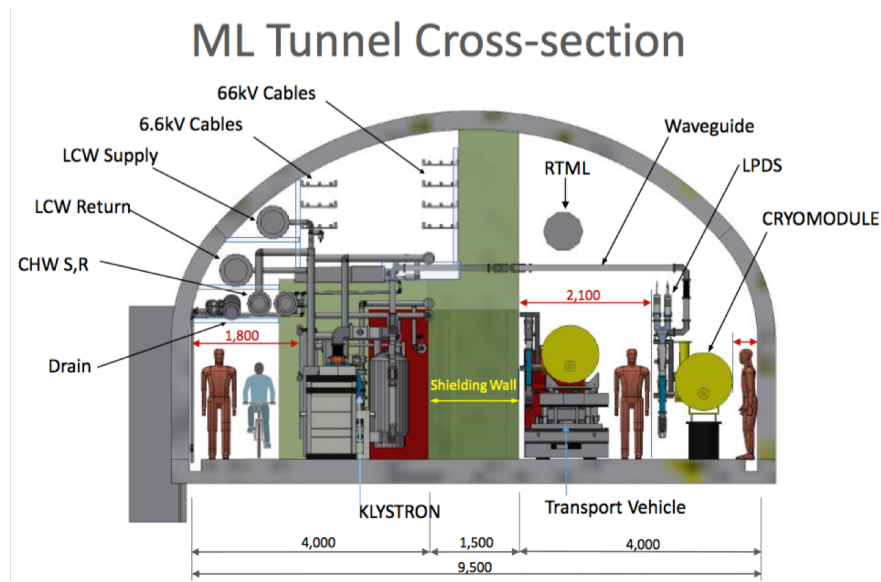

Figure 4.11: Cross section through the Main Linac tunnel.

such modules, with a total of 117 cavities, are powered by 2 klystrons and provide 3.83(4.29) GeV at a gradient of 31.5(35) MV/m. Table 4.2 gives an overview over the units that form the linacs. The waveguide distribution system allows an easy refurbishment to connect a third klystron for a luminosity upgrade. The 50% RF power increase would allow 50% higher current through smaller bunch separation, and longer beam pulses because of a reduced filling time, so that the number of bunches per pulse and hence the luminosity can be doubled, while the RF pulse duration of 1.65 ms stays constant.

Cryogenic supply: A 9 module unit forms a cryo string, which is connected to the helium supply line with a Joule-Thomson valve. All helium lines are part of the cryomodule, obviating the need for a separate helium transfer line. Up to 21 strings with 189 modules and 2.4 km total length can be connected to a single plant; this is limited by practical plant sizes and the gas-return header pressure drop.

Cost reduction from larger gradients: Figure 4.12 shows the layout of the cryogenic supply system for the 250 GeV machine. At the top, the situation is depicted for the gradient of 31.5 MV/m with a quality factor of $Q_0 = 1.0 \cdot 10^{10}$, as assumed in the TDR [4]. In this case, the access points PM±10 would house two cryogenic plants, each supplying up to 189 cryomodules or an equivalent cryogenic load. In this configuration 6 large plants in the access halls plus 2 smaller plants in the central region would be needed. The bottom picture shows the situation for a gradient of 35 MV/m with $Q_0 = 1.6 \cdot 10^{10}$, as could be expected from successful R&D. The increased gradient would allow reduction of the total number of cryomodules by roughly 10% from 987 to 906. The increased quality factor would reduce the dynamic losses such that 4 cryo plants would provide

Unit	Comprises	Length	Voltage
Cavity	1.038 m active length	1.25 m	32.6/36.2 MV
Cryomodule	$8^{2/3}$ cavities	12.65 m	282/314 MV
RF Unit	4.5 cryomodules	58.2 m	1.27/1.41 GV
Cryostring	2 RF units	116.4 m	2.54/2.82 GV
Cryounit	up to 21 cryostrings	2454 m	53.4/39.3 GV

Table 4.2: Units that make up the main linacs. The voltage takes into account that the beam is 5° shifted in phase (“off crest”) for longitudinal stability, and is given for an average gradient of 31.5/35 MV/m. A RF unit is powered by one klystron, each cryostring is connected by a valve box to the liquid helium supply, and a cryounit is supplied by one cryogenic plant. Total lengths include additional space between components.

sufficient helium.

In general, the accelerator is designed to make good use of any anticipated performance gain from continued high gradient R&D, in the case that raising the gradient is seen to be beneficial from an economical point of view, without incurring unwanted technology risk.

Beam delivery system and machine detector interface

The Beam Delivery System (BDS) transports the e^+/e^- beams from the end of the main linacs, focuses them to the required small beam spot at the Interaction Point (IP), brings them into collision, and transports the spent beams to the main dumps [4, Chap. 8]. The main functions of the BDS are

- measuring the main linac beam parameters and matching it into the final focus.
- protecting beamline and detector from mis-steered beams ².
- removing large amplitude (beam-halo) and off-momentum particles from the beam to minimize background in the detector.
- accurately measuring the key parameters energy and polarisation before and after the collisions.

The BDS must provide sufficient diagnostic and feedback systems to achieve these goals.

The BDS is designed such that it can be upgraded to a maximum beam energy of 500 GeV; components such as the beam dumps, that are not cost drivers for the overall project but would be cumbersome to replace later, are dimensioned for the maximum beam energy from the beginning. In other places, such as the energy collimation dogleg, those components necessary for 125 GeV beam operation are installed and space for a later upgrade is reserved.

²On the electron side, the protective fast beam abort system is actually located upstream of the positron source undulator.

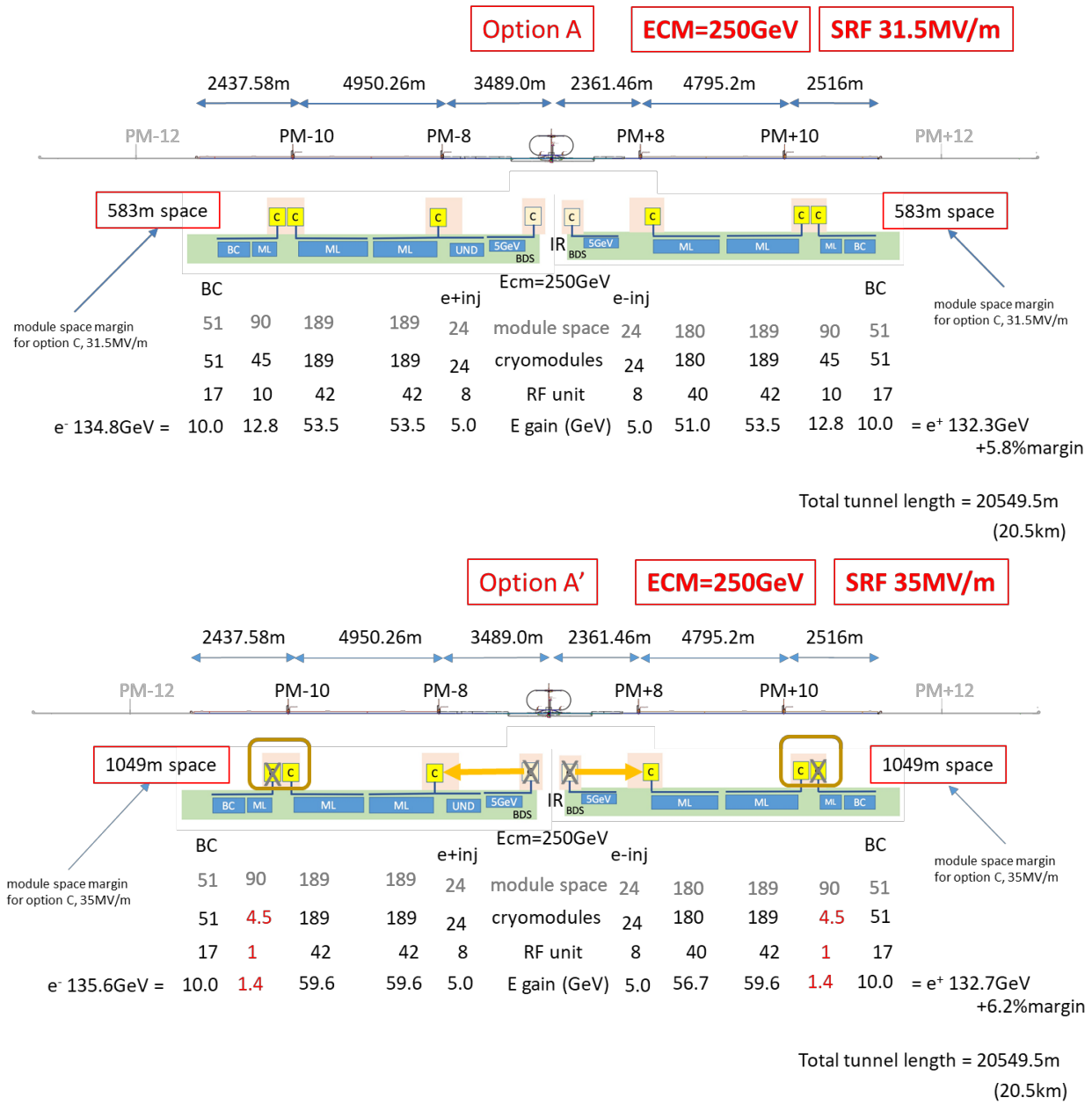

Figure 4.12: Cryogenic layout for a gradient of 31.5 MV/m (top) and 35 MV/m (bottom) [9]. “Module space” indicates how many cryomodules can be physically installed, “cryomodules” and “RF unit” indicates the number of actually installed modules and klystrons (one klystron per 4.5 cryomodules). “E gain” indicates the energy gain in GeV. “BC”, “ML”, “e+ inj”, “e- inj” and “UND” refer to the sections with need for liquid helium: bunch compressor, main linac, 5GeV boosters in the positron and electron source, and the positron source undulator section, respectively. PM±8, 10, 12 refer to access hall locations, “C” to cryo plants; meter numbers on top indicate the length of the corresponding section.

Overall, the BDS is 2254 m long from the end of the main linac (or the undulator and target bypass insert of the positron source on the electron side, respectively) to the IP.

Diagnostics and collimation section: The BDS starts with a diagnostics section, where emittance, energy and polarisation are measured and any coupling between the vertical and horizontal planes is corrected by a set of skew quadrupoles. The energy measurement is incorporated into the machine protection system and can, *e.g.*, extract off-momentum bunches caused by a klystron failure in the main linac that would otherwise damage the machine or detector. An emergency dump [20] is dimensioned such that it can absorb a full beam pulse at 500 GeV, sufficient for 1 TeV operation.

The diagnostics section is followed by a collimation system, which first removes beam halo particles (betatron collimation). Then, off-momentum particles are removed. In this energy collimation section, sufficient dispersion must be generated by bending the beam in a dogleg, while avoiding excessive synchrotron radiation generation in dispersive regions that leads to an increase of the horizontal emittance. This emittance dilution effect grows as E_{beam}^6 at constant bending radius for the normalised emittance, and determines the overall length of the energy collimation section for a maximum 500 GeV beam energy to about 400 m.

Final focus with feedback system and crab cavities: The final focus system demagnifies the beam to the required spot size of $516 \times 7.7 \text{ nm}^2$ by means of a final quadrupole doublet. Even the relatively small energy spread of $\approx 0.1\%$ leads to a significant spread of the focal length of the doublet and requires a correction to achieve the desired beam size, which is realised by a local chromaticity correction scheme [64].

To bring the beams to collision with the necessary nanometre accuracy requires a continuous compensation of drift and vibration effects. Along the ILC, the pulse length and bunch separation (727 μs and 554 ns, respectively) are large enough to allow corrections between pulses as well as within a bunch train (intratrain feedback). Beam-beam offsets of a fraction of the beam size lead to a measurable deflection of the outgoing beams, and these measurements are used to feed fast stripline kickers that stabilize the beam. Finally, the 3.9 GHz crab cavities close to the interaction point are incorporated that rotate the bunches to compensate for the 14 mrad beam crossing angle [4, Sect. 8.9].

Test results from ATF2: The Accelerator Test Facility 2 (ATF2) was built at KEK in 2008 as a test bench for the ILC final focus scheme [3, Sec. 3.6]. Its primary goals were to achieve a 37 nm vertical beam size at the interaction point (IP), and to demonstrate beam stabilisation at the nanometre level [65, 66]. After scaling for the different beam energies (ATF2 operates at $E_{\text{beam}} = 1.3 \text{ GeV}$), the 37 nm beam size corresponds to the TDR design value of $\sigma_y^* = 5.7 \text{ nm}$ at 250 GeV beam energy. As Fig. 4.13 shows, this goal has been reached within 10% [67] by the successive application of various correction and stabilisation techniques, validating the final focus design, in particular the local chromaticity correction [68].

The fifth generation FONT5 feedback system [69] for the ILC and CLIC has also been tested

at the ATF2, where a beam stabilisation to 41 nm has been demonstrated [70].

Since November 2016, intensity-dependence effects on the ATF2 beam size have been studied extensively. They show a degradation of the beam size with increasing intensity that is compatible with the effect of wakefields. Simulations and experiments in ATF2 show that the effect is not important when scaled to ILC. Also, it could be mitigated by including a dedicated “wakefield knob” in the routine tuning procedure.

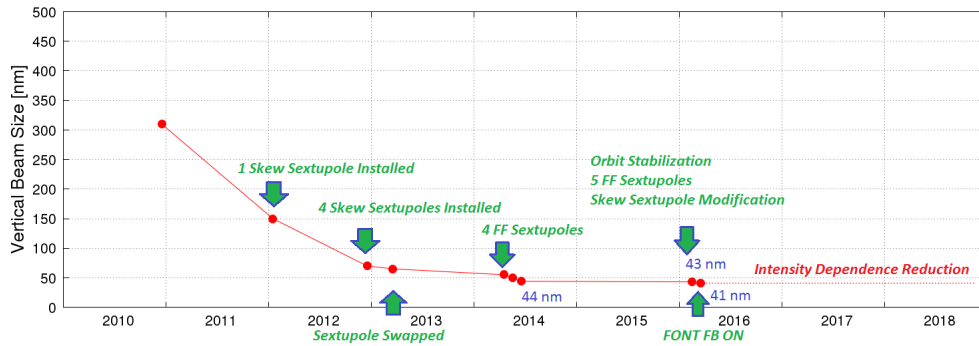

Figure 4.13: Beamsizes achieved at the Accelerator Test Facility 2 (ATF2) as a function of time [71]. The latest result (41 nm [67]) is within 10 % of the goal beam size of 37 nm.

Machine detector interface (MDI): The ILC is configured to have two detectors that share one interaction point, with one detector in data taking position at any time, in a so-called “push–pull” operation [3, Sec. 8.4]. Both detectors are mounted on movable platforms that allow an exchange of the detectors within approximately 24 hours.

In the push–pull scheme, the innermost final focus quadrupole “QD0”, a slim, superconducting magnet package combined with a sextupole for local chromaticity correction, is installed within the detectors. The other part of the final focus doublet (“QF1”) is located outside the detector on a bridge, and does not move with the detector. Since the TDR, the free space L^* between interaction point and the QD0 edge has been harmonised to a common value of $L^* = 3.5$ m [17], which facilitates the design of a final focus optics that delivers optimal and equal performance to both detectors.

The detectors are located in an underground cavern. In contrast to the TDR design, it is foreseen to have a large vertical access shaft [18], which permits a CMS–style detector installation concept, in which the detectors are assembled in large modules in a surface hall and lowered into the hall by means of a gantry crane capable of lowering pieces up to 4000 t. As the CMS experience shows, this concept significantly reduces the schedule risk associated with the experimental hall, since the cavern needs to be available for detector installation only one or two years prior to commissioning.

Main dump: The main beam dumps [4, Sect. 8.8] are rated for a maximum beam power of 17 MW [20], enough for a 1 TeV upgrade of the accelerator. The main dump design is based on the

successful SLAC 2.2 MW beam dump [72]. It utilises water at 10 bar pressure (to prevent boiling) as absorber medium. The main engineering challenges lie in the safe recombination of the produced oxyhydrogen gas and in the safe containment and disposal of radioisotopes, in particular tritium and ^7Be produced from spallation processes. The entry window is another component that has to be carefully designed.

Measurement of beam energy, luminosity, and beam polarisation: Two energy spectrometers, one located 700 m upstream of the IP, the other 55 m downstream, provide independent and complementary measurements of the beam energy with an accuracy of 100 ppm [73].

The luminosity is measured to 10^{-3} accuracy from low angle Bhabha scattering in the so-called LumiCal (see Sect. 6.3.1) at polar angles from 30 to 90 mrad. Additional calorimeters (BeamCal) in the region 5 to 30 mrad provide a fast signal that is sensitive to the beam sizes and offsets of the colliding beam, and that can thus be used for their tuning, as part of an intra-beam feedback system (see Sec. 4.1.3).

Beam polarisation is measured with 0.25 % accuracy by means of Compton scattering: electrons that scatter off green or infrared light laser photons lose enough energy that they can be detected in a spectrometer; their momentum spectrum is used to fit the beam polarisation [74]. Two such polarimeters are located 1800 m upstream and 150 m downstream of the IP, which allows to interpolate the precise polarisation at the IP and control the systematics, including effects from precession of the polarisation vector by transverse fields and depolarising effects in the interaction, which lead to a sizeable variation of the polarisation within the bunch during the collision (see Sec. 5.3).

4.1.4 Civil engineering and site

In 2014, the ILC Strategy Council announced the result of its candidate site evaluation for the best possible ILC site in Japan [75]. The evaluation was conducted by a number of Japanese experts from universities and industry, and reviewed by an international committee. It considered technical as well as socio-environmental aspects, and concluded that the candidate site in the Kitakami region is best suited for the ILC.

The site (Fig. 4.14) is located in the Japan's northern Tohoku region, not far from Sendai with its international airport, in the prefectures of Iwate and Miyagi. The closest cities are Ichinoseki, Oshu, and Kitakami, which all offer Shinkansen (bullet train) access to Sendai and Tokyo. The closest harbour is in the city of Kesen-Numa. The coastal region in this area was severely hit by the great Tohoku earthquake in 2011. Both prefectures are supportive of the ILC project and view it as an important part of their strategy to recover from the earthquake disaster.

The Kitakami site was largely selected because of its excellent geological condition. The proposed ILC trajectory lies in two large, homogeneous granite formations, the Hitokabe granite in the north and Senmaya granite to the south. The site provides up to 50 km of space, enough for a possible 1 TeV upgrade or more, depending on the achievable accelerating gradient. Extensive geological surveys have been conducted in the area, including boring, seismic measurements, and

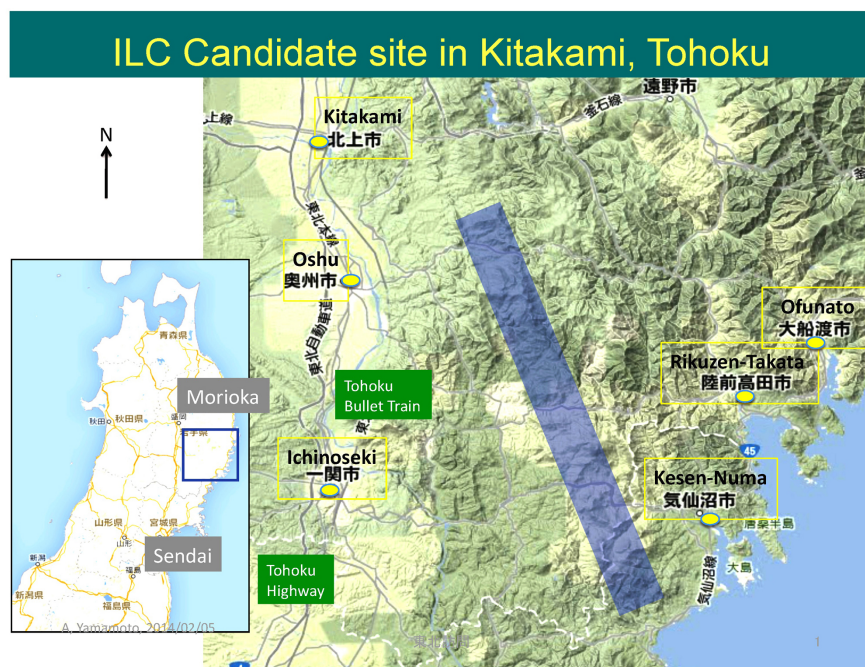

Figure 4.14: The Kitakami candidate site for the ILC [76].

electrical measurements [77], as shown in Fig. 4.15. The surveys show that the rock is of good quality, with no active seismic faults in the area.

Earthquakes are frequent throughout Japan, and the accelerator and detectors need proper supports that isolate them from vibrations during earthquakes and micro tremors [78]. Proven technologies exist to cope with all seismic events, including magnitude 9 earthquakes such as the great Tohoku earthquake.

Vibration measurements taken during the construction of a road tunnel show that accelerator operation would be possible during the excavation of a tunnel for an energy upgrade [79].

4.1.5 Cost and schedule

For the Technical Design Report, the construction cost of the ILC accelerator was carefully evaluated from a detailed, bottom-up, WBS (Work Breakdown Structure)-based cost estimation [4, Sect. 15]. The TDR estimate distinguishes two cost categories: Value accounts for materials and supplies procured from industry and is given in ILCU (ILC Currency Unit, where 1 ILCU = 1 US\$ in 2012 prices), and Labour accounts for work performed in the participating institutions and is given in person-hours or person-years³.

The Value of acquired goods reflects its worth in the local currency of the purchasing institution.

³One person-year corresponds to 1700 working hours.

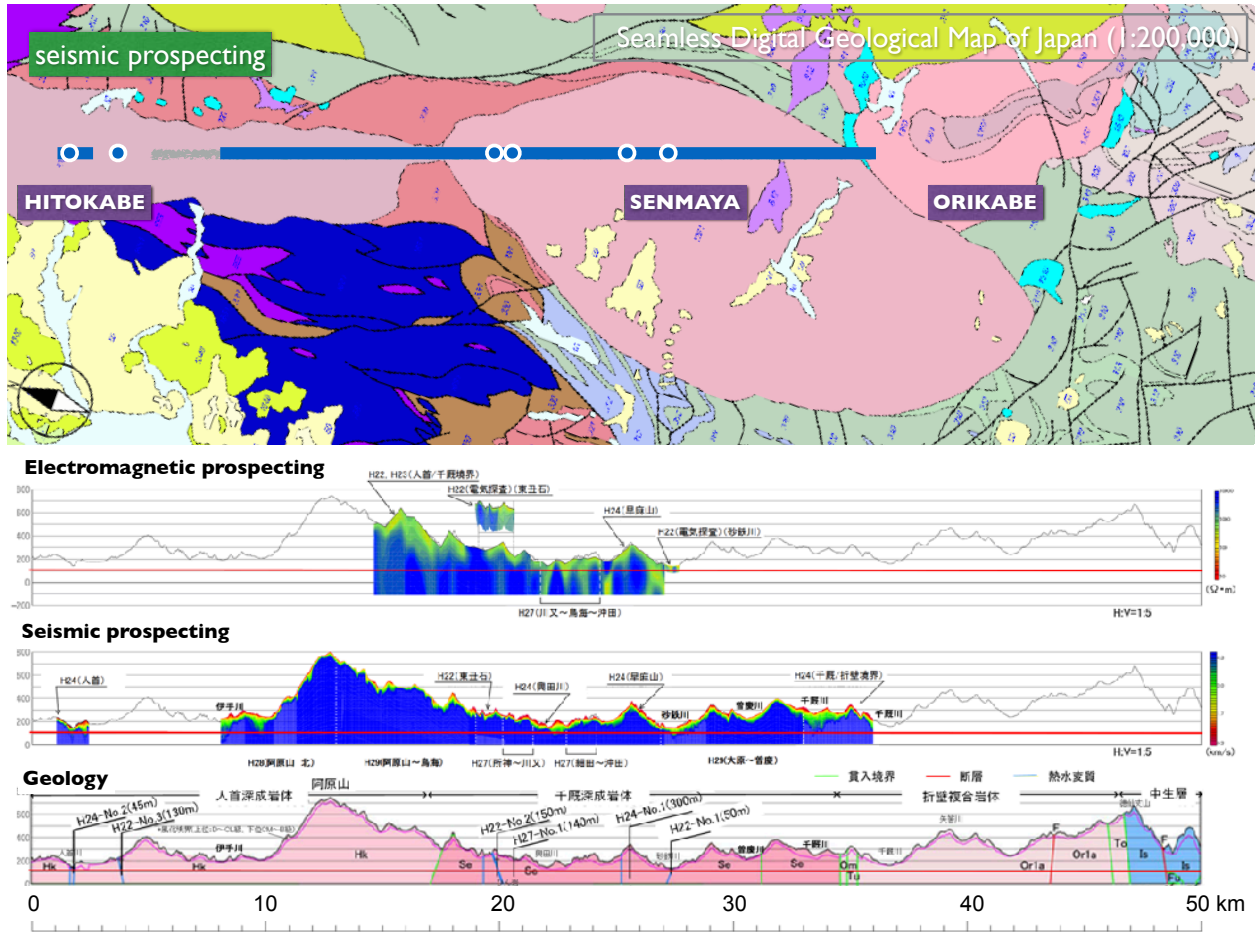

Figure 4.15: Geological situation at the Kitakami site.

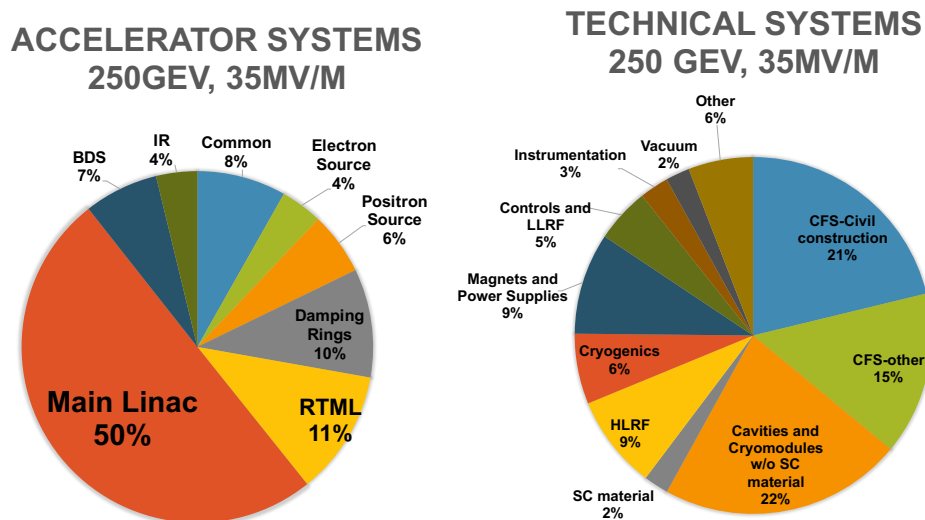

Figure 4.16: Breakdown of Value costs into accelerator systems (left) and technical systems (right) for the 250 GeV ILC accelerator, assuming that cost reduction measures are successful and a gradient of 35 MV/m can be reached.

Therefore, conversion of Value between currencies is performed based on Purchasing Power Parities (PPP), which are regularly evaluated and published by the OECD [80, 81], rather than currency exchange rates. The PPP values reflect local price levels and thus depend on the type of goods and the country, but fluctuate significantly less than currency exchange rates. Therefore, conversions from ILCU to other currencies cannot not be made on the basis of exchange rates to the U.S. dollar, but on PPP values.

The TDR estimate covers the cost of the accelerator construction, assumed to last 9 years plus one year of commissioning. It includes the cost for the fabrication, procurement, testing, installation, and commissioning of the whole accelerator, its components, and the tunnels, buildings *etc.*, and the operation of a central laboratory at the site over the construction period. It does not, however, cover costs during the preparation phase preceding the start of construction work (“ground breaking”), such as design work, land acquisition, infrastructure (roads, electricity, water) for the site.

Based on the TDR cost estimate, an updated cost estimate was produced for the 250 GeV accelerator. This updated cost estimate includes the cumulative effect of the changes to the design since the TDR (see Sect. 4.1.1), and evaluates the cost for the reduced machine by applying appropriate scaling factors to the individual cost contributions of the TDR cost estimate.

The resulting Value estimate for the ILC accelerator at 250 GeV is 4,780 – 5,260 MILCU [9] in 2012 prices, where the lower number assumes a cavity gradient of 35 MV/m, while the higher number is based on the TDR number of 31.5 MV/m. In addition, 17,165 kh (thousand person-hours) are required of institutional Labour.

In 2018, the ILC Advisory Panel of the Japanese Ministry of Education, Culture, Sports, Science and Technology (MEXT) concluded its review of the ILC [82]. For this review, costs were evaluated in Japanese Yen in 2017 prices, taking into account the local inflation for goods and construction costs. For the purpose of this estimate, also the Labour costs were converted to Yen to yield 119.8 G¥, resulting in a total range of the accelerator construction cost of 635.0 – 702.8 G¥, where the range covers uncertainties in the civil construction costs (18 G¥) and of the gradient (49.8 G¥). For this estimate, conversion rates of 1 US\$ = 100 JP¥ and 1 € = 1.15 US\$ were assumed.

Operation costs of the accelerator and the central laboratory are estimated to be 36.6 – 39.2 G¥ (about 318 – 341 M€) per year.

4.2 ILC staging up to 1 TeV

[6 pages; corresponding editor: Alex Aryshev (alar@post.kek.jp)]

[this section should include a table of accelerator parameters at the various stages for easy reference]

4.2.1 Introduction

The requirements for ILC physical characteristics [83] define a continuous range of center-of-mass energy from 92 GeV (Z-pole [84]) to 500 GeV with the possibility of additional upgrading to a center-of-mass energy of 1 TeV. The GDE has focused on providing a reliable design and cost estimation for the 200 – 500 GeV base machine. The design is a price-performance optimized solution for a given energy range. The center-of-mass energy of 250 GeV can be realized with a straight machine 20 km long, and the energy of 500 GeV can be achieved if it is expanded to 30 km. To be as cost-effective as possible, the final ILC proposal approved by ICFA [85] does not include empty tunnel options for future upgrades. Despite the fact that the length of the main tunnel of the linear accelerator has been reduced, the beam delivery system and main dumps are designed to allow for an energy upgrade up to 1 TeV.

The development of accelerator structures with higher acceleration gradients can lead to a significant increase in energy while maintaining a compact infrastructure. To date, significant progress has been made in the development of structures with a gradient well above the 31.5 MV/m required for the ILC, and even above the 45 MV/m as required for the 1 TeV ILC [86, 87]. In the longer term, structures with an alternative shape or with a thin-film Nb_3Sn coating or multilayer coating can significantly improve the performance of linear particle accelerators [88]. Newer acceleration schemes can achieve even higher gradients as discussed in Sect. 4.3 ILC Scope Beyond 1 TeV. Finally, the emergence of acceleration schemes based on plasma wake field acceleration or other advanced concept could open up the ILC energy regime up to 30 TeV. Thus, the ILC laboratory has the potential to turn into higher energies electron-positron collider. The ability to increase energy levels makes the Linear Collider a very flexible tool, allowing to respond for a new discoveries at the LHC. There are several options for upgrading the ILC in terms of energy, luminosity and beam polarization.

The level of developments detail of the staging and upgrade scenarios is significantly less mature than the baseline. In particular, the TeV upgrade parameters and associated conceptual design represent a relatively simple and straightforward scaling of the base machine based on straight assumptions about higher achievable operating parameters for SCRF technology with an average acceleration gradient of 45 mV/m with $Q_0 = 2 \times 10^{10}$. Achieving these values requires further research and development beyond the basic technology. It is anticipated that this R&D will continue in parallel with both construction and operation of the base machine, so that the expansion of the core linear accelerators required to increase particle energy will benefit from improved technology. In addition, accelerator research and development should continue to dramatically increase particle collision energy in preparation for future experimental efforts that may indicate the existence of new particles and new phenomena on a higher energy scale.

Both luminosity enhancement and low-energy staging are based on existing technology and do not require additional research and development. For upgrades to TeV energies, a design approach that has minimal impact on the operation of the ILC should also be discussed. The presented two sets of parameters for upgrading to TeV (the so-called low and high beamstrahlung) were obtained after careful consideration of the physical impact.

It should be emphasized that the flexibility in the choice of beam parameters remains one of the key advantages of the ILC. It can be adjusted whenever new ideas and discoveries either from (HL-) LHC or from the ILC itself set new requirements. In particular, the center-of-mass energy of the ILC can always be reduced from the nominal maximum energy without loss of efficiency, as long as the electron beam energy remains high enough to produce positrons.

4.2.2 Parameters

Table 4.1 shows the main ILC parameters for center-of-mass energy of 250 GeV, an increased luminosity of 500 GeV and two possible sets of parameters for the energy 1 TeV. The parameters for the first stage of the 250 GeV machine are identical to the baseline parameters set for this energy.

4.2.3 Luminosity upgrade

The ILC luminosity can be improved by increasing the luminosity per bunch (or by the charge of the bunch) or by increasing the number of bunches per second [89]. Increasing the brightness per bunch requires a smaller vertical beam size, which can be achieved by tighter focusing and / or lower beam emittance. However, this approach invariably involves high perturbation of the beam, resulting in the risk of luminosity loss due to improper beam steering. Thus, a very accurate feedback system is required. The ILC design also allows the number of bunches to collide per second to be increased by doubling the number of bunches per pulse and possibly increasing the pulse repetition rate. Doubling the number of bunches per pulse from the base number of 1312 to 2625 will require a decrease in the time separation between bunches from 554 ns to 366 ns, which will lead to an increase in the beam current from 5.8 mA to 8.8 mA, which will require installation of 50% more klystrons and modulators. Since the RF pulse duration of 1.65 ms will not change, the cryogenic

load will also not change. The beam pulse duration increases from 714 μs to 961 μs . The choice of the distance between bunches is consistent with both the harmonic number of the damping ring and the duration of the RF pulse of the main linear accelerator. Doubling the number of bunches would double the beam current in the damping rings. For a positron ring, this may exceed the limitations associated with the electron cloud instability. To reduce this risk, the damping ring tunnel is large enough to accommodate a third damping ring so that the positron current can be distributed over the two rings. The pulse repetition rate (5 Hz in the base configuration) is limited by the available cryogenic power, the damping time in the rings, and the target heat load in the positron source target. The rings are rated for the time for damping of 100 ms and thus can have a repetition rate of up to 10 Hz, which is double the nominal. Operation at an increased repetition rate will be possible if, after upgrading the energy, the machine is operated at energies below the maximum or if additional cryogenic power is installed. Basic schematics for electron and positron sources are specified to produce more bunches needed for upgrades. RTML, and in particular the SCRF RF linear accelerator sections for beam compressors - are already compatible with a large number of bunches.

The invasive nature of the additional cryogenic power installation requires a shutdown, during which all additional RF power supply must be installed. This will also include additional water cooling and the required AC power, although pipe sizes are already specified for the additional baseline load and do not need upgrades. In particular, the 25% increase in cryogenic load (mainly due to high power coupler losses and HOM losses due to higher current) is within the base specification. All beam position monitors (and other instruments) are compatible with shorter beam spacing. Beam dynamics problems (multi-bunch effects) are also acceptable, and high power couplers and HOM couplers/absorbers are specified in the baseline for higher beam currents.

4.2.4 Energy upgrade

An obvious advantage of a linear collider is the possibility of its energy upgrade. In principle, the main linear accelerator can be expanded at a constant cost for the added beam energy with some additional costs of moving the turnarounds and compressors. Additional costs arise when the beam delivery system (BDS), including the beam dumps has to be expanded to cope with the increased beam energy. The current ILC BDS is designed to be easily modified to operate at center-of-mass energies up to 1 TeV at minimal cost. Depending on the actual gradient achieved during the construction of the ILC, maximum 162 cryomodules can be installed in addition to those required to reach 250 GeV, which will increase the center of mass energy by approximately 50 GeV to about 300 GeV, and two additional cryogenic plants may need to be installed. Further increases in energy will require the expansion of the tunnel. As noted above, accelerator with a total length of at least 50 km can be placed on the Kitakami site, which is more than enough for center-of-mass energy of 1 TeV. Any expansion of the accelerator system can be accomplished by adding new cryomodules at the low energy (upstream) ends of the accelerator without the need to move already installed modules.

The upgrade can take place in two phases: a preparation phase, when the accelerator is still running and producing data, and an installation phase, when the accelerator stops. During the

preparation phase, the necessary components will be purchased and manufactured, in particular cryomodules, klystrons and modulators. At the same time, civil engineering will continue to excavate new access tunnels, underground halls and the main tunnel. Recent research shows that the level of vibration caused by tunneling will bring new tunnels closer to existing ones before machine operation is impacted [90], minimizing the required shutdown time. During the installation phase, the newly built tunnels will be connected to the existing ones, the beam lines at the turnarounds and wiggler sections of the bunch compressors will be dismantled, and new cryomodules and a new turnaround and bunch compressors will be installed. In doing so, any necessary changes can be made to the positron source and the final focus of the machine. Since the cryomodules are ready for installation at the beginning of the shutdown period, it is anticipated that the shutdown could be limited to about a year for an energy upgrade

The choice of beam parameters and luminosity increase for the TeV upgrade is also based on direct scaling from a set of base parameters, but more limited by additional considerations related to higher energy and average beam power:

1. the total AC power required for the modified machine must be below some realistic limit (assumed to be 300 MW);
2. the beam current and pulse duration must be compatible with injectors, damping rings and the main linear accelerator of the basic design;
3. energy losses due to beamstrahlung should be acceptable, and the maximum pair-production angle should be limited at the maximum luminosity per bunch crossing.

Limiting the total AC power requires reducing the repetition rate from 5 Hz to 4 Hz, while the need to maintain the RF pulse length in the original main linear accelerator at approximately 1.6 ms and the choice of the damping ring harmonic number limits the number of bunches to 2450. The limits of beamstrahlung, depend on physics, therefore, for the study of physical and detector groups, two sets of parameters were proposed: a set of parameters for low beamstrahlung with $\delta_{BS} \sim 5\%$ and a luminosity of $3.02 \times 10^{34} \text{ cm}^{-2}\text{s}^{-1}$, equal to the increased luminosity value for the 500 GeV baseline and the second set with high beamstrahlung radiation with $\delta_{BS} \sim 10\%$ and, accordingly, a higher luminosity $5.11 \times 10^{34} \text{ cm}^{-2}\text{s}^{-1}$. Both of these parameter sets are based on the reduced charge of one bunch (1.7×10^{10}), shorter bunch length ($250\mu\text{m}$ and $225\mu\text{m}$ for low and high δ_{BS} , respectively), and increased horizontal beam size for controlling beamstrahlung and pair-production angle, while the vertical beta function at the interaction point (IP) is further reduced to increase the luminosity per bunch crossing [91]. The bunch lengths and IP beta functions are within the range of bunch compressor and final focusing systems. It is relatively easy to adjust the machine parameters between these beamstrahlung parameter sets.

Increasing the beam energy will require the expansion of the main SCRF linear accelerators to provide an additional 250 GeV per beam. The beam current for the TeV upgrade (7.6 mA) is higher than the baseline (5.8 mA) but less than that for luminosity upgrade (8.8 mA), suggesting some level of modification. Assuming the luminosity upgrade is the first to occur; the injectors (sources and damping rings) will be reused unchanged. Compressor sections along with the RTML

will be moved to the beginning of the extended linear accelerators. It is also necessary to lengthen the 5 GeV long-transfer line from the damping ring to the turn-around. The beam delivery system will require the installation of additional dipoles to provide the required higher integrated field strength. The cost and schedule of the upgrade is entirely dependent on the expansion of the main linear accelerators. One of the key cost considerations is the choice of an accelerating gradient. Ongoing R&D for high gradient SCRF is expected to continue in parallel with the construction and operation of the base machine. With this in mind, it is assumed that when the linear accelerator technology is upgraded, a higher gradient and quality factor is incorporated. The actual choice of these options will clearly depend on the state-of-the-art at the time of the upgrade. However, for the purposes of this discussion, an average acceleration gradient of 45 MV/m with $Q_0 = 2 \times 10^{10}$ will be assumed. Using the existing baseline linear accelerator in this way has three key consequences for the upgrade:

1. The beam current and pulse length must be compatible with the existing RF installation and cryogenic refrigeration capacity.
2. The existing linear accelerator lattice, which was originally designed to transfer beam energies from 15 to 250 GeV, should now transfer beam energies from 265 to 500 GeV. This will require replacing the first 10 GeV of the original linear accelerator, since these quadrupoles will not be able to transport a higher energy beam (from 265 to 500 GeV, not 15 to 250 GeV).
3. The rest of the original linear accelerator will use the *FoFoDoDo* lattice as opposed to the basic *FoDo* lattice, which will result in weaker focusing and larger beta function values. Simulation of the beam dynamics showed that the growth of the vertical emittance can be kept within acceptable limits.

4.2.5 Positron source

The undulator-based positron source must be compatible with the initial energy of the electron beam of 500 GeV. The solution is to replace the baseline helical undulator with a shorter one, with a longer period and a smaller field. The upgraded undulator will provide a photon beam similar to the baseline so that the same target and capture device can be used without modification [92]. One of the important considerations is the opening angle of photons, which is doubled for higher beam energy; this makes collimating photons for polarization more challenging. Currently, a conservative estimate of 20% polarization is considered acceptable, but higher values may be possible, provided that a suitable solution is found for collimating photons with a smaller aperture [93]. The baseline design geometry of the target-bypass dogleg for the high-energy electron beam already accommodates the 500 GeV beam transport with a few percent horizontal emittance growth [94], although additional dipole magnets will need to be installed.

4.2.6 RTML

The two-stage compressor system will need to be “relocated” to a new location upstream. This scenario assumes that a new two-stage compressor will be installed, as well as a new turnaround

and an extended transport line. Also, during the shutdown for the final installation of the warm wiggler base sections and cryomodules, the most upstream sections of the main linear accelerator will be updated as discussed in the “Energy upgrade” subsection. The original turnaround will be disconnected and bypassed by a new long transport line. It is likely that the space between the original and the upgraded linac will also be used for additional diagnostic and dump systems, including an emergency extraction dump to protect the machine, similar to the one found at the linac exit (BDS entrance).

4.2.7 Beam Delivery System (BDS)

The BDS geometry (length and average bend radius) is already compatible with the transport of a 500 GeV beam with an acceptable increase in the emittance generated by synchrotron radiation [92]. Additional dipoles are required (as well as appropriate power supplies and cooling) to be installed in drift spaces provided in the base grid. The main high power dumps have already been designed for higher average beam powers to avoid the need to replace them during modernization (dumps will become radioactive after several years of operation).

4.2.8 Polarization upgrade

It is assumed that at center-of-mass energies up to 500 GeV, ILC beams will have at least 80% of the electron polarization at IP in combination with a positron polarization of 30% for an undulator positron source. At 1 TeV, the positron polarization will reach at least 20%. As an upgrade option, the positron polarization can be increased to 60% for a center-of-mass energy of about 500 GeV, as discussed in Sec. 4.5.2 Electron and Positron Sources. The design of the accelerator includes sets of spin rotators, which, in principle, make it possible to form any desired direction of the polarization vectors at the IP. However, in the detailed scenarios, we only take into account the longitudinal polarization. At a beam energy above 125 GeV, the flux of undulator photons increases rapidly. Photon polarization is maximal at zero angle of radiation emission; it reduces and even inverts at large angles. Thus, collimation of the excess photon flux at large radiation angles increases the net polarization. Present research studies show that 60% polarization of positrons at IP can be possible at a center-of-mass energy of 500 GeV with the addition of a photon collimator.

4.2.9 Summary

These chapters examined incremental upgrade and upgrade options other than the 500 GeV baseline scheme and demonstrates the greater design flexibility and capabilities of the ILC installation. The basic design already contains minimal support to simply increase luminosity by doubling the average beam power (50% increase in average RF power). The parameters and scope of future upgrades to center-of-mass energy of 1 TeV were presented, based on the expansion of the main linear accelerators with minimal impact on the existing (baseline) machine. The construction of the extended machine, in principle, could proceed in parallel with the physical launch, with minimal interruption for connecting the baseline and modernized linear accelerators and the subsequent commissioning

of the machine. The physical parameters (luminosity) for retrofitting to TeV energies represent a compromise between the physical requirements of the beam-beam (limiting bremsstrahlung and pair-production angle) and the desire to limit the total required AC power to about 300 MW.

4.3 ILC Scope beyond 1 TeV

[5 pages; corresponding editor: Hasan Padamsee (hsp3@cornell.edu)]

The ability to operate the ILC accelerator beyond 1 TeV depends on the possibility of incorporating SCRF cavity with accelerating gradients much higher than the ILC standard 31.5 MeV/m. In this section, we report on the progress toward higher-gradient SCRF and the implications for higher-energy operation of the ILC.

4.3.1 Gradient status for the ILC baseline 250 GeV

Figure 4.17 shows the steady progress in single and multicell cavity gradients [95] over the last 3+ decades coming from high purity, high RRR Nb, electropolishing, 800 C furnace treatment for H removal, 100 atm. high pressure water rinsing for removal of field emission particulates, and final baking at 120 C for removal of the high field Q-slope. These procedures establish a standard ILC cavity preparation and treatment recipe from which cavity gradients of 35 MV/m are expected, as observed from the EXFEL production run. More than 40 “best” cavities from the EXFEL production run showed 40–45 MV/m [96], as shown in Fig. 4.18. At DESY, two large grain 9-cell cavities reached 45 MV/m [97].

Key areas of further development over the last 5 years have been for higher Q values at medium gradients (16–22 MV/m) for CW operation with the invention of new techniques of Nitrogen doping [98, 99]. Nitrogen doping for high Q has already been applied to the construction of a large (4–8 GeV) new accelerator, LCLS-II, and its high energy upgrade LCLS-II-HE. For LCLS-II-HE, ten 1.3 GHz 9-cell N-doped cavities have reached average 3.5×10^{10} at 25.7 MV/m.

Further improvements can be expected from exciting developments [100] that show $Q = 5 \times 10^{10}$ at 30 MV/m by baking at 300 C (mid-T baking) to dissolve the natural oxide (and other surface layers) into the bulk, but not exposing the cavity to air or water before RF measurements. It is interesting to note how the Q rises with field, as seen for N-doping (Fig. 4.19(a)). After exposure to air, followed by HPR, the Q dropped to 2×10^{10} at 30 MV/m. Surface analysis of similarly treated samples show a Nitrogen peak at a few nm below the surface, suggesting that N is present at the surface and has diffused into the Nb to give the doping effect. IHEP in China followed up on these encouraging results with several 9-cell TESLA cavities with exciting results [101], as shown in Fig. 4.19(b). After mid-T (300 C) furnace bake, and HPR, all the 9-cell cavities demonstrate high Q in the range of $3.5\text{--}4.4 \times 10^{10}$ at the gradient between 16–24 MV/m, as shown in Fig. 4.19(b). These cavities have all exceeded the specification of LCLS-II HE (2.7×10^{10} at 21MV/m). KEK is also pursuing the mid-T baking option. Although in its early stages, the mid-T baking procedure shows the potential of Nb for high gradients with high Qs.

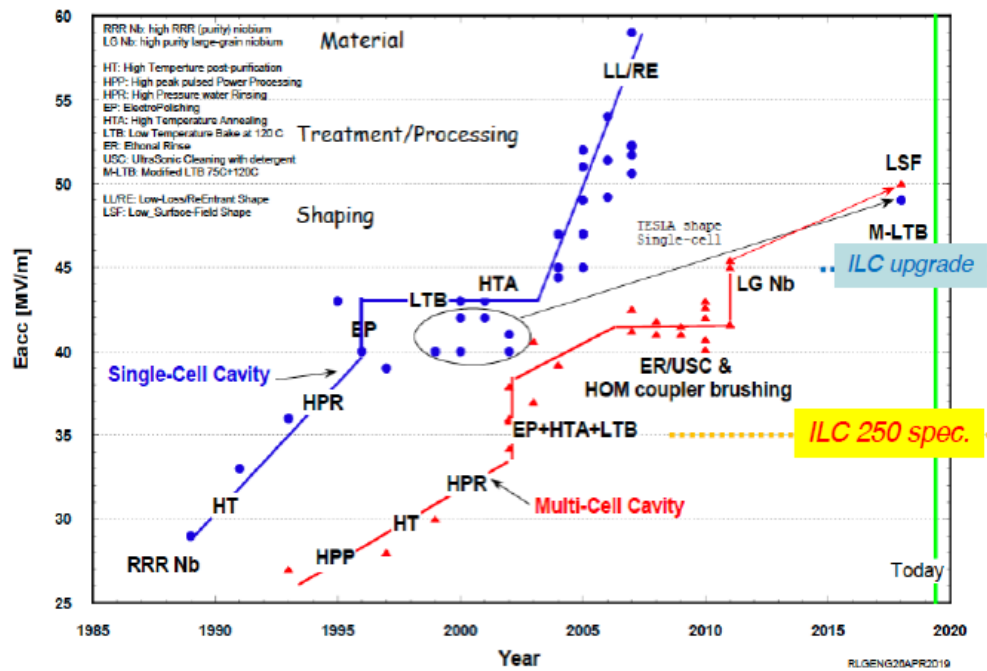

Figure 4.17: Steady progress in single and multi-cell cavity gradients over 3+ decades [95].

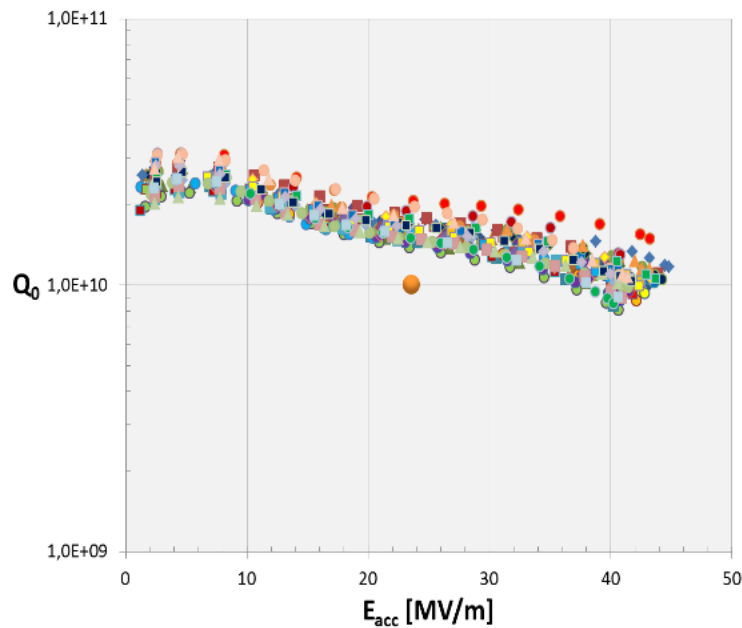

Figure 4.18: 9-cell test results from DESY on > 40 cavities produced and treated by Research Instruments (RI) [96].

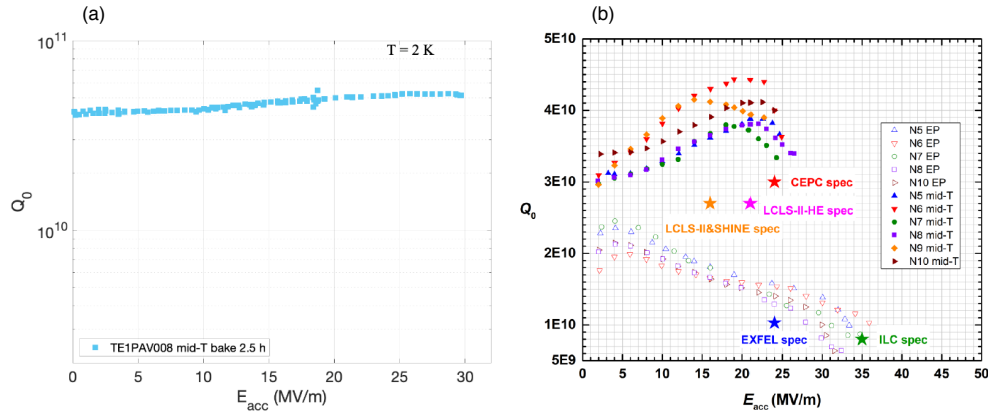

Figure 4.19: (a) $Q = 5 \times 10^{10}$ at 30 MV/m by baking at 300 C to dissolve the natural oxide (and other surface layers) into the bulk, but not exposing the cavity to air or water before RF measurements. (b) IHEP (China) results on mid-T baking for 9-cell cavities compared to results on the same cavities with the standard ILC treatment [101].

4.3.2 High Gradient (45 MV/m) SRF for Upgrade Paths to 1 TeV

Section 4.2 discusses ILC energy upgrade paths from 250 GeV to 380 GeV (Top Factory), 500 GeV and 1000 GeV. For the 1000 GeV upgrade (Scenario B), the 2013 ILC TDR uses a gradient of 45 MV/m with $Q_0 = 2 \times 10^{10}$ for the additional linac from 500 GeV to 1000 GeV. The SRF parameters are chosen on the forward-looking assumptions of advances in SRF technology derived from R&D which will continue in parallel to both construction and operation of ILC 250 GeV to 1000 GeV. Such extrapolations in SRF performance are reasonably based on expectations from proof-of-principle results already in hand. As discussed further below, single cell cavities with improved treatment reach 49 MV/m, and single cell cavities with improved shapes that reach 52–59 MV/m.

Nitrogen Infusion

On the high gradient frontier (with higher Q 's), the invention of Nitrogen infusion [87], stemming from Nitrogen-doping, demonstrates gradients of 40–45 MV/m as shown in Fig. 4.20, and compared to the performance of cavities prepared with the standard ILC recipe. JLAB has shown success with infusion[102], but KEK [103] and DESY [104] have found the technique to be sensitive to the quality of the infusion furnace, and difficult to implement.

Two-Step Baking and Cold Electropolishing

In another new development, extraordinarily high quench fields for 1.3 GHz niobium TESLA-shaped SRF cavities, some near 50 MV/m have been achieved with the 75/120 C bake surface treatment

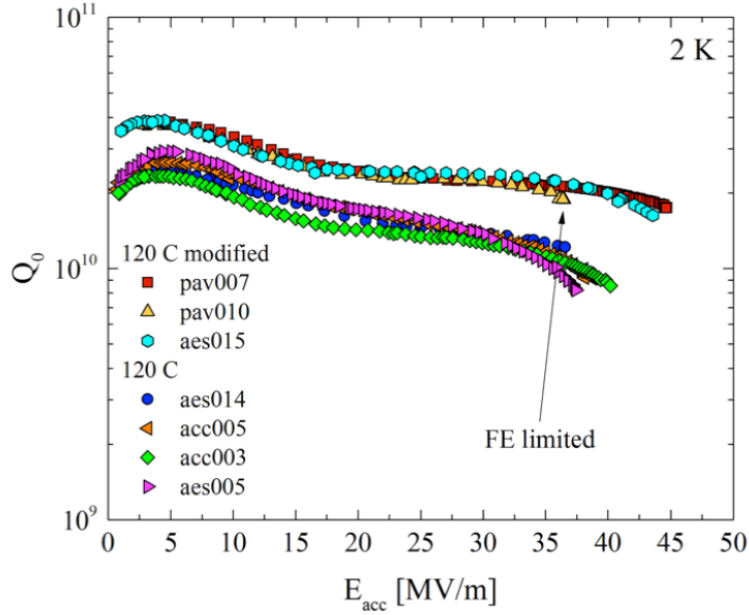

Figure 4.20: Comparison of the performance of several 1-cell cavities from N-infusion with cavities prepared by the standard ILC recipe of EP and 120 C baking.

developed at FNAL, as shown in Fig. 4.21(a). Two-Step baking with Cold Electropolishing [86] show gradients in the range of 40–50 MV/m (average 45 MV/m), as depicted in Fig. 4.21(b). Note that 3 cavities that quench below 28 MV/m were found to have physical defects that likely limited the performance.

4.3.3 Toward 60 MV/m - Advanced Shape Cavities

Continuing along the gradient frontier, multicell cavities of Re-entrant [105, 106], Low-Loss [107] and ICHIRO [108] shapes (Fig. 4.22(b)) have been introduced to lower H_{pk}/E_{acc} 10 - 20% by rounding the equator to expand the surface area of the high magnetic field region, and by allowing E_{pk}/E_{acc} to rise by about 20%. The Re-entrant shape has an Ω -like profile with $H_{pk}/E_{acc} = \text{Oe}/35.4/(\text{MV}/\text{m})$, $E_{pk}/E_{acc} = 2.28$ (for 60 mm aperture) as compared to 42.6 Oe/(MV/m) and $E_{pk}/E_{acc} = 2.0$ for the standard TESLA shape (70 mm aperture). The GR/Q value for the re-entrant shape is about 34% higher than the TESLA shape, which reduces cryogenic losses. The 20% increase in E_{pk} makes cavities with the new shapes more susceptible to field emission, but we can expect progress in field emission reduction with cleaner surface preparation developments over the coming decades.

The motivation in trying the new shape was that quench, governed by H_{pk} , is a hard limit, whereas field emission, governed by E_{pk} , can be improved by better engineering. The Low-Loss shape with 60 mm aperture has $H_{pk}/E_{acc} = 36.1 \text{ Oe}/(\text{MV}/\text{m})$, and $E_{pk}/E_{acc} = 2.36$, and a 23% higher GR/Q than the TESLA shape. The ICHIRO shape is a variant of the Low-Loss shape. A

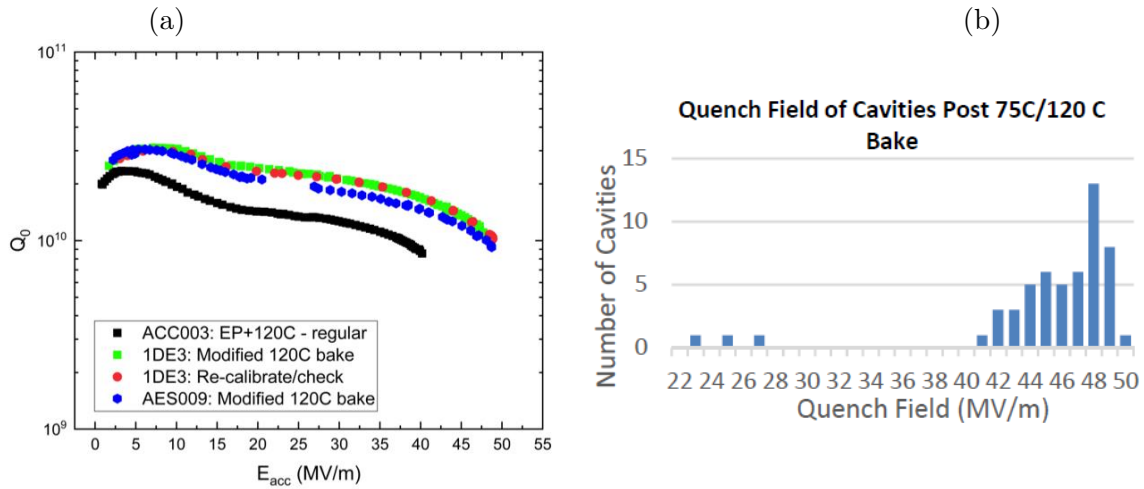

Figure 4.21: (a): Q vs. E curve of 1-cell cavity reaching 49 MV/m from Cold EP/optimized baking (75/120 C) compared to the curve of a cavity prepared by the standard ILC recipe. (b) Histogram of gradients of a large number of single cell cavities prepared by Cold EP/optimized baking (75/120 C).

relative newcomer to the advanced shape effort is the LSF shape [109] which obtains $H_{pk}/E_{acc} = 37.1$ Oe/(MV/m) without raising E_{pk}/E_{acc} ($= 1.98$). It has a small refinement of the Low-Loss shape.

Many single cell cavities with the advanced shapes were built, prepared with the standard ILC recipe, and tested to demonstrate gradients of 50 – 54 MV/m with Q_0 values above 10^{10} [110, 111], as shown in Fig. 4.22(a). A record field of 54 MV/m at Q about 10^{10} was set by a single cell Re-entrant cavity with 60 mm aperture, and 59 MV/m at Q about 3×10^9 (see Fig. 4.22(c) [112]) for the same cavity. However, the best multi-cell cavities of the new shapes have only reached 42 MV/m [113], mostly due to the dominance of field emission. A 5-cell cavity of the LSF shape recently tested at JLAB showed 50 MV/m gradient in three of the five cells [114] by exciting several modes of the fundamental pass-band.

As we have seen earlier, the newly developed, two-step bake procedure has demonstrated a gradient of 49 MV/m in TESLA shape 1-cell cavities. Combining the two-step bake with one of the advanced shape cavities has the potential of improving the gradients toward 60 MV/m. For example, the Low-Loss shape has the potential for 18% improvement from 49 to 58 MV/m. But no laboratory has attempted such combined efforts as yet.

Cost reduction efforts

The energy upgrades would also benefit from cost saving measures under exploration, such as niobium material cost reduction (15-25%) for sheet production directly from ingots (with large grains), and/or from seamless cavity manufacturing from tubes using hydroforming, or spinning,

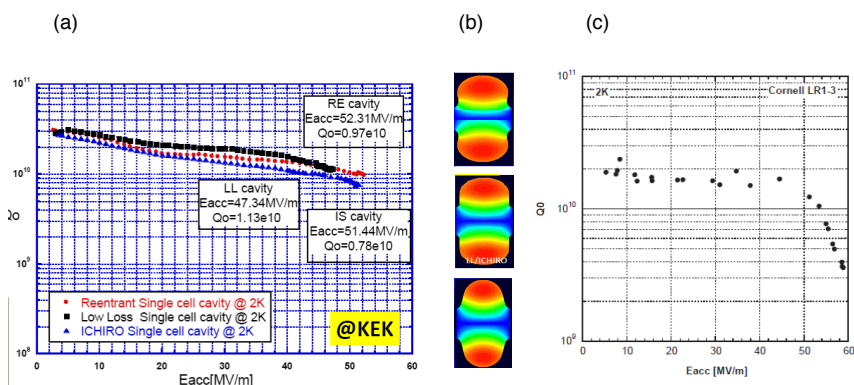

Figure 4.22: (a) Gradients greater than 50 MV/m demonstrated in single cell cavities of various improved shapes. (b) Comparison of Reentrant-top, Low Loss/Ichiro-middle and TESLA-bottom cavity cell shapes, color is magnetic field intensity, red highest, blue lowest. (c) Record gradient near 59 MV/m demonstrated with the re-entrant shape (60 mm aperture).

instead of the expensive machining and electron beam welding procedures now in practice. Cost-reducing avenues for cryomodules [115] are to connect cryomodules in continuous, long strings similar to cryostats for long strings of superconducting magnets, saving the cost for the expensive ends. The elimination of the external cryogenic transfer line by placing all cryogenic supply and return services in the cryomodule also reduce costs, not only directly for the cryogenic components, but also by reducing tunnel space required. Additional cost reductions and efficiency improvements (not included in the TDR 1 TeV estimate) can be also expected from improved klystron and modulator technology. In Sec. 15.1.1, we discuss the ILC upgrade path from 1 TeV to 2 TeV based on gradients/ Q of 55 MV/m/ 2×10^{10} obtained by the best new treatments, such as the two-step bake/Cold EP, applied to advanced shape structures, such as the Low-Loss structure, built from Niobium. This section also provides tables summarizing the main parameters of the 2 TeV ILC upgrade path to be compared to CLIC 1.5 TeV and the 70–80 MV/m SRF upgrade paths to 3 TeV. As discussed in Sec. 15.1.1, we consider the ILC upgrade path from 1 TeV to 3 TeV based on very high gradient SRF opened by R&D underway on two fronts:

1. Optimized travelling wave (TW) superconducting structures [116, 117, 118] with effective gradients up to 70 MV/m, along with 100% increase in R/Q - which reduces the dynamic heat load by 100%, and
2. 80 MV/m/ 1×10^{10} gradient/ Q potential for Nb₃Sn [118] at 4.2 K, based on extrapolations from high power pulsed measurements on single cell Nb₃Sn cavities.

Travelling wave structures

Travelling wave (TW) structures offer several main advantages compared to standing wave (SW) structures: substantially lower peak magnetic (H_{pk}/E_{acc}), lower peak electric field (E_{pk}/E_{acc})

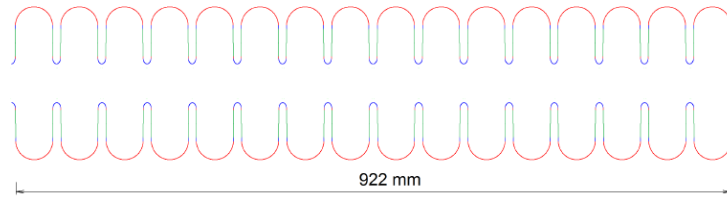

Figure 4.23: A segment of a one-meter TW structure.

ratios, together with substantially higher R/Q (for lower cryogenic losses). The emphasis for future design is to lower H_{pk}/E_{acc} , as much as possible, since H_{pk} presents a hard ultimate limit to the performance of Nb cavities via the critical superheating field. But, as Fig 4.23 shows, the TW structure requires twice the number of cells per meter as for the SW structure in order to provide the proper phase advance (about 105 degrees), as well as a feedback waveguide for redirecting power from the end of the structure back to the front end of accelerating structure, which avoids high peak surface fields in the accelerating cells. The feedback requires careful tuning to compensate reflections along the TW ring to obtain a pure traveling wave regime at the desired frequency.

As discussed in Sec. 15.1.1, to obtain a luminosity comparable to CLIC 3 TeV, the beam bunch charge for the 3 TeV upgrade can be 3 x lower than the bunch charge for 0.5 TeV. Hence it is possible to lower the cavity aperture (from 70 mm to 50 mm) without severe penalty in wake-fields to obtain an overall 48% reduction in H_{pk}/E_{acc} , and factor of 2 gain in R/Q over the TESLA standing wave structure. Accordingly, we examine the impact of 70 MV/m for the 3 TeV ILC upgrade to obtain a luminosity comparable to CLIC 3 TeV. Section 15.1.1 provides tables summarizing the main parameters of the 70 MV/m ILC upgrade path as compared to CLIC 3 TeV, including capital costs, AC powers, energy spreads and backgrounds at the IP. Modelling and optimization calculations are underway for TW structure optimization [118]. Table 4.3 shows one set of optimized parameters for optimized cell shape, phase advance, and 50 mm aperture that yield $H_{pk}/E_{acc} = 28.8$ Oe/(MV/m) with $E_{pk}/E_{acc} = 1.73$. Since H_{pk}/E_{acc} is 42.6 Oe/MV/m and $E_{pk}/E_{acc} = 2$ for the TESLA structure, the TW structure has reduced the critical parameter H_{pk}/E_{acc} by 48%! The geometrical parameters for the cell shape are defined in the inset figure accompanying Table 4.3. If results for the best single cell TESLA shape cavities prepared today ($E_{acc} = 49$ MV/m, $H_{pk} = 209$ Oe) can be reached in such a TW structure it will be possible to reach $E_{acc} = 72.5$ MV/m. The 100% R/Q increase lowers the dynamic heat load and cryogenic power needed for high gradients.

The high group velocity in the TW mode also increases the cell-to-cell coupling from 1.8% for the TESLA structure to 2.3%. Thus TW structures have less sensitivity to cavity detuning errors, making tuning easier, despite the larger number of cells. Studies [118] show that the cell shape can be fine tuned to avoid multipacting, without increasing H_{pk} more than 1%. HOM damping is under study. Preliminary results show that the first 10 monopole modes up to 7 GHz show no trapping.

Many significant challenges must still be addressed along the TW development path. High circulating power in the feedback waveguide must be demonstrated. Cavity fabrication and sur-

Optimization	
Phase advance θ , deg	
A , mm	
B , mm	
a , mm	
b , mm	
E_{pk}/E_{acc}	
B_{pk}/E_{acc} , mT/(MV/m)	
R_{sh}/Q , Ohm/m	
α , degrees	
l , mm	
R_{eq} , mm	
v_{gr}/c	
E_{acc}^* , MV/m	
$E_{acc}^* \cdot 2L$, MV	

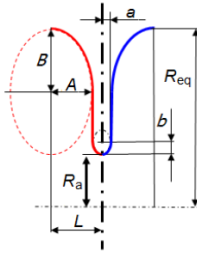

Table 4.3: Parameters of optimized cells with limiting surface fields: $E_{pk} = 120$ MV/m and $B_{pk} = 200$ mT, aperture radius $R_a = 25$ mm. E_{acc} is the accelerating rate when the limiting surface fields are achieved. $2L$ is the cell length = 57.55 mm. An 18-cell structure (1.036 m) will have the nearly same active length as the TESLA structure (1.061 m). (from [106], Table 5, column 2).

face processing procedures and fixtures must deal with (roughly) double the number of cells per structure.

First structure fabrication and testing efforts have started for TW cavity development [116, 117]. With the relatively easier BCP treatment only, the first single cell TW cavity (Fig. 4.24(a)) with recirculating waveguide achieved 26 MV/m accelerating gradient, limited by the high field Q-slope, as expected for BCP. This result is very encouraging for a first attempt. A 3-cell Nb TW structure with recirculating waveguide (Fig. 4.24(b)) was designed and fabricated but has not yet been tested.

In Sec. 15.1.1, we consider the ILC upgrade path from 1 TeV to 3 TeV based on 70 MV/m TW Nb cavities to be compared to CLIC 3 TeV. The Section provides tables summarizing the main parameters of the 3 TeV ILC with CLIC 3 TeV.

4.3.4 Nb₃Sn

A15 compounds are intermetallic and brittle in the bulk form, so SRF structures are produced as a thin layer on the inner surface of an already formed structure. Nb₃Sn is the most explored compound with the best results [119, 120, 121], but does not as yet give as good performance as with Nb cavities. The A15 phase is in the composition range of 18–25 at% Sn. The superconducting properties T_c , Δ , and H_c , depend strongly on the Sn content [122]. Perfect ordering in the stoichiometric phase is achieved close to stoichiometry (at 24.5 at%) where H_{sh} is 0.42 mT as compared to Nb's H_{sh} of 0.22 mT at 0 K. Accordingly, we can expect the upper limit of the gradient to be 400 mT or near 95 MV/m.

A few microns thick Nb₃Sn films can be deposited on the inner surface of Nb cavities exposed to Sn vapor (10^{-3} mbar) in an UHV furnace at temperatures between 1050 C and 1250 C. In general,

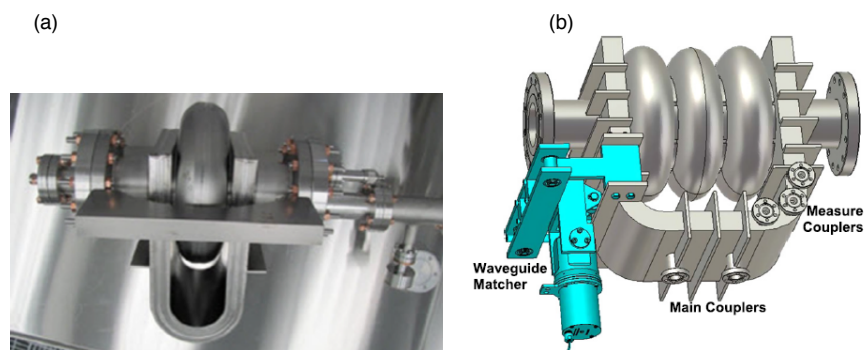

Figure 4.24: (a) 1-cell TW Niobium structure with return waveguide, treated by BCP and tested to reach 26 MV/m. (b) 3-cell TW structure built but not yet tested.

the Nb_3Sn films produced exhibit good material quality with Sn content of about 25%, T_c from 16 to 18 K, Δ from 2.7 to 3.2 meV [123]. Coating results are typically reproducible for the same Nb cavity substrate, but have been seen to vary between different cavities.

Some of the limitations of Nb_3Sn arise from the sensitivity of the thermodynamic critical field H_c (and therefore the superheating field) to the exact Sn concentration. For example, a Sn depletion of 3% reduces H_c by 75%. Other difficulties are the high surface roughness at Nb_3Sn grain boundaries possibly causing local field enhancement. Somewhat thinner (1 μm) layers give smoother surfaces and best results (Fig. 4.25).

Most practitioners of Nb_3Sn have encountered a Q-slope problem and with gradient limits. Progress has continued. The best case of a flat Q vs E curve out to 23 MV/m has been achieved at Fermilab [119, 120, 121]. The performance at 4.2 K is also very attractive showing $Q_0 > 10^{10}$ at gradient of 18 MV/m. Latest films have smaller surface roughness (by a factor of 2), smaller thickness (1 μm vs 2–3 μm) and smaller grain size (0.7 μm vs 1.2 μm). Careful material science is yet required to understand and confidently control the Nb_3Sn crystal growth dynamics so as to produce low-loss surfaces.

High power pulsed RF measurements (Fig. 4.25(b)) at Cornell on a Nb_3Sn cavity show encouraging trends for very high gradients [119]. At high temperature ($T > 15$ K), the results track the high superheating field, extrapolating to 300 mT ($E_{acc} \approx 80$ MV/m) at zero temperature. But at lower temperature, thermal limitations take over to limit the highest field to about 100 mT (24 MV/m) which is close to the CW result of 22 MV/m.

In Sec. 15.1.1 ILC upgrade beyond TDR, we consider the ILC upgrade path from 1 TeV to 3 TeV based on Nb_3Sn cavities with gradients/Q of 80 MV/m/ 1×10^{10} . The Section provides Tables summarizing the main parameters of the 3 TeV ILC to be compared to CLIC 3 TeV, and also discusses the potential benefits from 80 MV/m Nb_3Sn .

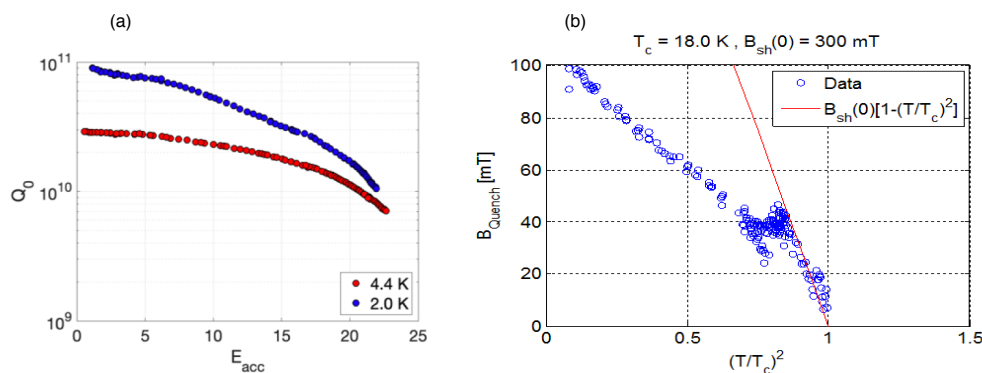

Figure 4.25: (a) Record CW behavior for Nb₃Sn coated at Fermilab showed $E_{acc} = 23$ MV/m. (b) Measurements of the critical RF field of Nb₃Sn using high power pulsed RF. The high temperature results extrapolate to a maximum surface magnetic field of 300 mT, which would translate to $E_{acc} = 85$ MV/m for a Low-Loss shape cavity.

4.4 ILC Accelerator technical preparation plan

[5 pages; corresponding editor: Shinichiro Michizono (shinichiro.michizono@kek.jp)]

Although much work has already been done to establish the ILC design and technical readiness, a number of issues remain to be studied to prepare the final design of the ILC. The technical basis for the ILC was fully documented ten years ago in the ILC Technical Design Report and its Addendum [3, 4]. Still, three sets of issues need to be studied anew. First, it is necessary to revisit all of the items to understand whether any updates are called based on more recent R&D results (including the past ten years of SRF cost reduction R&D) and consistency with the ILC staging plan [9]. Second, because the TDR work was done without a specific site in view, issues related to the site must be addressed again for the specific candidate site in the Tohoku region of Japan. Finally, the MEXT advisory panel and the Science Council of Japan have called attention to some remaining technical issues that need to be resolved during the ILC preparation period [124, 125].

There is now a plan for technical preparations to be carried out in the ILC Pre-Lab period. A full description of these activities is given in the document “Technical Preparation and Work Packages (WPs) during ILC Pre-lab” [126]. In this section, we will briefly review this plan.

The Work Packages (WPs) for the technical preparation activities include:

- **Main Linac (ML) and SRF production:** Cavity and Cryomodule (CM) global production readiness will be demonstrated through the fabrication of roughly 40 cavities in each of the 3 regions, the requirement of RF performance achieved with $\geq 90\%$ success demonstrated with sufficient statistics by using a part (about a half) of the 40 cavities in each region, and the fabrication of 2 CMs in each of the three regions using 40% of the cavities fabricated.
- **ML global integration:** The program of global CM transfer will be conducted to demonstrate that the CM production satisfies high-pressure gas safety (HPGS) regulations,

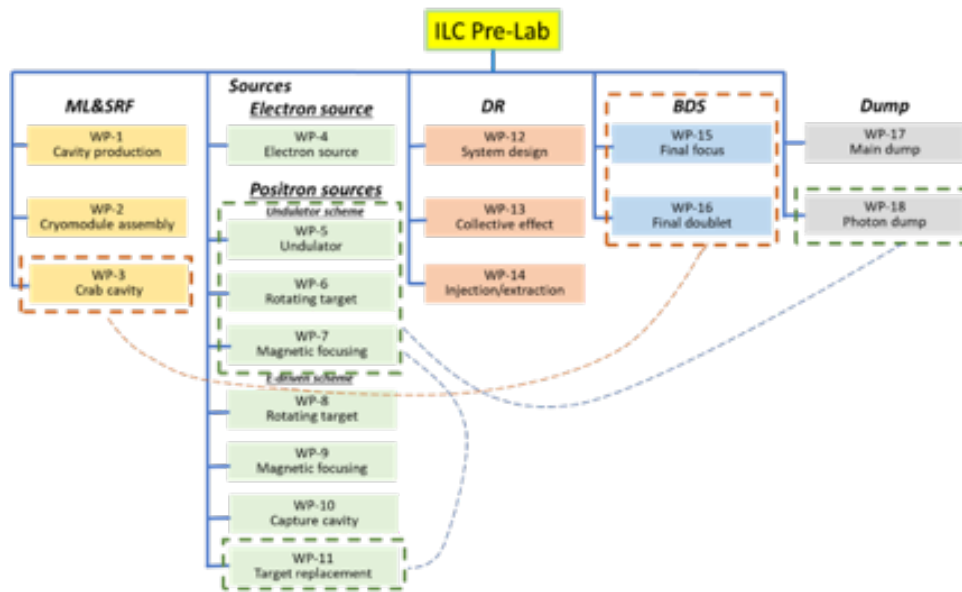

Figure 4.26: Summary of the Work Packages for the technical preparations that will be carried out during the ILC Pre-Lab period.

safe transport across oceans, and the qualification of the CM performance after shipping from Europe and the Americas to Japan across the oceans. One of the two CMs in each region will be used for this purpose. We plan to accomplish this goal with two steps. In the first step, if transport-test CMs (fully constructed but not suitable for use in the linac) are available from LCLS-II and/or European XFEL, those will be used to test simple transportation and to gather important information about stress, acceleration, *etc.*, excluding the HPGS regulation process. In the second step, the ILC prototype CM developed during the ILC Pre-lab phase will be shipped to Japan, including the HPGS regulation process and the full CM quality assurance program within the ILC Pre-lab phase period.

- **Positron source** : The final design will be selected from either the an undulator-driven or the electron-driven option and its technology readiness will be demonstrated.
- **Damping Ring (DR) and Beam Delivery System (BDS)**: Readiness of the nanobeam technology for the DR, based on work at the ATF3 and related facilities, and the BDS systems will be demonstrated, particularly including the fast kicker and feedback controls.
- **Beam dump**: A system design will be established, including beam window handling, cooling water circulation, and safety assurance.

A total of 18 WPs (3 ML&SRF, 8 Sources, 3 DR, 2 BDS, and 2 Dumps) are proposed as illustrated in Fig. 4.26 and summarized in an extended list below. The classification of some items should be clarified. The crab cavity (WP-3) will be installed in the BDS area, but is classified as ML&SRF since the crab cavity uses SRF technology. The photon dump (WP-18) will be used for

the undulator positron source. However, this WP-18 is classified as dump due to its specialty. The target replacement (WP-11) is a common WP for undulator and e-driven positron sources. These relationships are also shown in Fig. 4.26.

The explicit tasks of the WPs are as follows:

- **WP-1 (ML&SRF):** Cavity Industrial Production Readiness (3×40 Cavities)
 - Cavity industrial production readiness to be demonstrated, including cavities with He tank + magnetic shield for cavity, high-pressure-gas regulation, surface-preparation/heat treatment (HT)/Clean-room work, partly including the 2nd pass, vertical test (VT)
 - Plug compatibility, Nb material, and recipe for surface treatment to be reconfirmed/decided
 - Cavity Production Success yield to be confirmed (before He tank jacketing)
 - Tuner baseline design to be established

Note: Infrastructure for surface treatment, HT, VT, pre-tuning, *etc.*, is the responsibility of each region.

- **WP-2 (ML&SRF):** Cryomodule (CM) Assembly, Global Transfer and Performance Assurance (3×2 CMs)
 - Coupler production readiness to be demonstrated, including preparation/RF processing (3×20 Couplers)
 - Tuner production readiness to be demonstrated, including reliability verification (3×20 Tuners)
 - Superconducting Magnet (SCM: Q+D combined) production readiness to be demonstrated (3×3 SCMs, 1 prototype + 2 in each region)
 - CM production readiness to be demonstrated including high-pressure-gas, vacuum vessel (VV), cold-mass, and assembly (cavity-string, coupler, tuner, SCM, *etc.*)
 - CM test including degradation mitigation (in 2-CM joint work, *etc.*) at assembly site before ready for CM transportation
 - CM Transportation cage and shock damper to be established
 - Ground transportation practice, using mockup-CM
 - Ground transportation test, using production-CM longer than Eu-XFEL
 - Global transport of CM by sea shipment (requiring longer container)
 - Performance assurance test after CM global transport (at KEK)
 - Returning transport of CM back to home country (by sea shipment)

Note: Infrastructure for coupler conditioning: klystron, baking furnace, and associated environment is the responsibility of each region. Also, hub-lab infrastructure for the CM production, assembly, and test is the responsibility of each region.

- **WP-3 (ML&SRF):** Crab Cavity (CC) for BDS (2 CCs + 1 for SRF validation)

- Decision of installation location with cryogenics/RF location accelerator tunnel
- Confirmation of the complete CC system specifications
- Development of CC cavity/coupler/tuner integrated design (ahead of Preliminary CC technology Down-selection)
- Preliminary CC technology down-selection (2 cavity options)
- CC Model-work and Prototype production and high-power validation of CC cavity/coupler/tuner integrated system for two primary candidates (ahead of final CC technology Down-selection)
- Harmonized operation of the two prototype cavities in a vertical test to verify ILC synchronization performance (cryo insert development and commercial optical RF synchronization system)
- Final CC technology down-selection
- Preliminary Crab CM design – confirming dressed cavity integration and compliance with beam-line specification
- Final CM engineering design prior to production
- Infrastructure for CC development and test in each region
- Additional ML&SRF tasks beyond the Pre-Lab (1 CM)
 - Cavity (incl He tank) production (incl couplers and tuner), magnetic shield for CM, high-pressure gas regulation, EP/HT/Clean work, including VT
 - Input coupler production including preparation/RF processing readiness (excluding klystron, baking furnace, clean room)
 - Prototype CM production including High-pressure gas, vacuum vessel, cold-mass, and assembly (cavity-string, coupler/tuner, SCM and tooling, *etc.*)
 - Prototype CM test including harmonized operation with two cavities
 - Prototype CC-CM transport cage and shock damper design and manufacture
 - Prototype CC-CM transport tests
 - Infrastructure for CM development and testing in each region
- **WP-4 (Sources):** Electron Source
 - Drive laser system
 - HV Photogun
 - GaAs/GaAsP Photocathodes
- **WP-5 (Sources):** Undulator Positron Source
 - Simulation (field errors, masks, alignment)
- **WP-6 (Sources):** Undulator Positron Source rotating target
 - Design finalization, partial laboratory test, mock-up design

- Magnetic bearings: performance, specification, test
- Full wheel validation, mock-up
- **WP-7 (Sources):** Undulator Positron Source magnetic focusing system
 - OMD design finalization with yield calculation
 - OMD with fully assembled wheel
- **WP-8 (Sources):** Electron-Driven Positron Source rotating target
 - Target stress calculation with FEM
 - Vacuum seal
 - Target module prototyping
- **WP-9 (Sources):** Electron-Driven Positron Source rotating target
 - Target stress calculation with FEM
 - Vacuum seal
 - Target module prototyping
- **WP-10 (Sources):** Electron-Driven Positron Source capture system
 - APS cavity for the capture linac
 - Capture linac beam loading compensation and tuning method
 - Capture linac operation and commissioning
 - Power unit prototyping
 - Solenoid prototyping
 - Capture linac unit prototyping
- **WP-11 (Sources):** Positron Source target maintenance
 - Target Maintenance (a common issue for the undulator and electron-driven sources)
- **WP-12 (Damping Rings):** System Design
 - Optics optimization, simulation of the dynamic aperture with magnet model
 - Magnet design : Normal conducting magnet and SC wiggler
 - Magnet design : Permanent magnet
 - Prototyping of permanent magnet
- **WP-13 (Damping Rings):** Evaluation of collective effects in the ILC damping ring
 - Simulation : Electron cloud instability
 - Simulation : Ion-trapping instability
 - Simulation : Fast ion instability (FII)

- System design : Fast FB for FII
- Beam test : Fast FB for FII
- **WP-14 (Damping Rings):** System design of ILC DR injection/extraction kickers
 - Fast kicker: System design of DR and LTR/RTL optics optimization
 - Fast kicker: Hardware preparation of drift fast step recovery diode pulser
 - Fast kicker: System design and prototyping of induction kicker
 - Fast kicker: Long-term stability test at ATF
 - E-driven kicker: System design,including induction kicker development
- **WP-15 (BDS):** System design of ILC final focus beamline
 - ILC-FFS system design: Hardware optimization
 - ILC-FFS system design: Realistic beam line driven / IP design
 - ILC-FFS beam tests: Long-Term stability
 - ILC-FFS beam tests: High-order aberrations
 - ILC-FFS beam tests: R&D complementary studies
- **WP-16 (BDS):** Final doublet design optimization
 - Re-optimization of TDR FF design considering new coil winding technology and IR design advances
 - Assembly of QD0 prototype, connection to Service Cryostat and measurement of warm/cold vibration stability with a sensitivity of a few nanometers
- **WP-17 (Beam Dump):** System design of the main beam dump
 - Engineering design of water flow system
 - Engineering design and prototyping of components; vortex flow in the dump vessel, heat exchanger, hydrogen recombiner
 - Engineering design and prototyping of window sealing and remote exchange
 - Design of the countermeasure for failures / safety system
- **WP-18 (Beam Dump):** System design of the photon dump for the undulator positron source
 - System design and component test of an open-window water dump
 - System design and component test of a graphite dump

The cost and required human resources required for the WPs are estimated in [126]. The values given are initial estimates. The actual numbers will depend on the laboratories that will take the responsibility for the deliverables, so these estimates will be re-evaluated later. Infrastructure associated with the series of items mentioned above will need to be newly prepared and/or improved

with each region taking responsibility for implementation and financial support. The technical readiness scoped in each WP needs to be verified through periodical reviews conducted by the ILC Pre-Lab. The ILC technical design will need to be updated reflecting the progress on the WPs, and these updates will be implemented/added to the engineering documents. Stability and tuning issues in some WPs will also need to be coordinated with the start-to-end accelerator design that will be done as part of the "engineering design and documentation" activities of the Pre-Lab. These linkages will be carried out as a part of the ILC Pre-Lab responsibility.

We expect these activities can be completed within a four-year preparation period. We divide the timeline into two categories: "Technical Preparation and Readiness" and "Engineering documentation". Here is a plan showing how the WP activities fit into the timeline, using the SRF and Positron Source work as examples:

Year	Technical preparation	Engineering documentation
1	Continue cost-reduction R&D for SRF cavities Start pre-series production of SRF cavities in cooperation with industry Continue e^+ source development	Start review and update of TDR cost estimates by an international team
2	Complete cost-reduction R&D Determine production yield Start assembling cavities into cryomodules Review e^+ source designs	Conduct a review on the progress for technical work and cost estimation by an internal panel
3	Demonstrate overseas shipment of cryomodules taking all the safety and legal aspects into account Select e^+ source design and start prototyping and cost issues of critical items, <i>e.g.</i> , the e^+ target	Complete cost estimate and conduct internal and external review Complete risk analysis for the technical and cost issues Complete a draft of the Engineering Design Report
4	Evaluate cryomodules after shipment and demonstrate the quality assurance procedure Establish regional organization for the ILC component production Continue prototype work for critical components of the e^+ source, <i>e.g.</i> , the e^+ target	Complete and publish the Engineering Design Report Start producing specification documents and drawings of large items for tendering

Progress in technical preparation activities will be monitored and evaluated through periodic reviews. The activities will be also synchronized with the engineering documentation.

4.5 Opportunities for US contributions

[8 pages; corresponding editor: Sam Posen (sposen@fnal.gov)]

US laboratories host world-class infrastructure and expertise in technology that is relevant for particle accelerators. This presents a number of opportunities for the US to make important contributions to the ILC accelerator that leverage existing capabilities. These contributions would

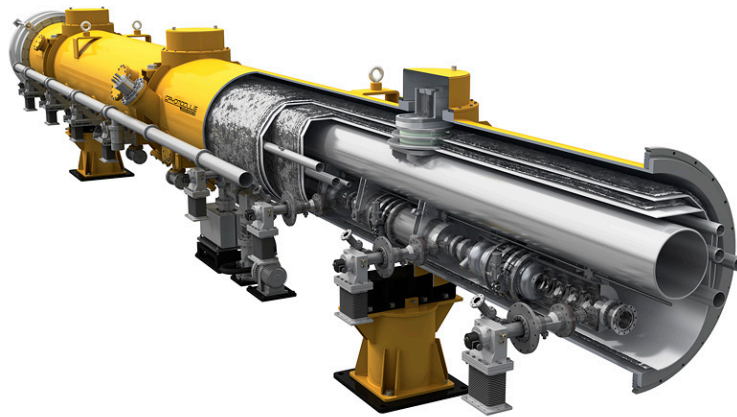

Figure 4.27: Cutaway view of an ILC cryomodule. (Image by Rey Hori [127].)

help the project to go forward and position the US well for strong participation in ILC-based experiments.

4.5.1 Superconducting Linac

The superconducting linear accelerator that drives the ILC requires 1000 cryomodules to reach a center of mass energy of 250 GeV. Each cryomodule (see Fig. 4.27) contains 8 \sim 1 meter long superconducting radiofrequency (SRF) cavities, which generate large amplitude electric fields to accelerate the beam. They also contain liquid-helium-based cryogenics to keep the cavities at 2 K, magnets, RF power couplers, frequency tuners, vacuum valves, and instrumentation. US labs have substantial experience with these sophisticated components from US-based accelerator projects including CEBAF, SNS, LCLS-II, and PIP-II. Large scale production facilities exist at Fermilab and at Jefferson Lab for assembling SRF cryomodules (see Fig. 4.28). These facilities include large cleanrooms for making vacuum connections between cavities while minimizing the risk of generating particulates that can cause field emission, large fixtures for connecting cavity strings to cold masses and inserting cold masses into cryomodules, and equipment for welding, RF diagnostics, and coupler assembly. Fermilab and JLab also have existing cryomodule test facilities, which require 2 K refrigerators, dedicated radiation areas, and RF systems. These facilities have very recently been used for the mass production of cryomodules for LCLS-II, for which the cryomodule design was largely based on ILC. As such the production facilities have already been recently tested with a very relevant system, though ILC would require approximately 5 times as many modules to be produced as the entire production of LCLS-II and its high energy upgrade LCLS-II-HE combined. However, the Fermilab and JLab and the teams would take on the larger production with enthusiasm and experience. The vast majority of the infrastructure is already in place, with some modifications required for the higher throughput required to meet the 1 cryomodule per week target for the Americas region at peak production.

In addition to Fermilab and JLab, there are also SRF facilities at Argonne, Cornell, and FRIB,



Figure 4.28: View of some of the cryomodule assembly facilities at Fermilab (left) and Jefferson Lab (right).

which are less specialized towards production of ILC-like cryomodules, but could be leveraged for example for cavity treatment. SLAC's expertise in high power RF sources could be leveraged for driving the cavities as well as RF distribution. SLAC is also planning a relevant cryomodule test facility that could be used. Berkeley's expertise in low level RF could be leveraged for cavity control, particularly for resonance control at high accelerating gradients.

Fig. 4.28: View of some of the cryomodule assembly facilities at Fermilab (left) and Jefferson Lab (right).

US expertise can also contribute to advanced performance for ILC cryomodules. Since the 2012 TDR, significant progress has been made in SRF R&D, including new procedures developed by researchers from US labs for reaching high gradients. Some of these developments could be implemented in ILC cryomodules to push performance by 10%, either resulting in fewer cryomodules required to reach the design center of mass energy, or else as a safety margin on top of the nominal energy and beginning towards first energy upgrades. The relevant new technologies include cold electropolishing [128] and the two step bake [86].

Advances from US labs can also contribute to some of the auxiliary systems of the cryomodules. The tuner used in LCLS-II was an evolution of previous designs and is well suited to the short beamtubes of the ILC, while maintaining minimal backlash [129]. The quadrupole magnet used in LCLS-II is also an evolution of previous designs, with conduction cooling and a split design to allow it to be assembled outside of the cleanroom [130]. A system and procedure for plasma processing of SRF cavities was developed at ORNL [131] and later adapted to 9-cell cavities by FNAL [132], which may be useful for reducing effects such as field emission in some cases.

US labs are expected to also play a leading role in developing technologies for energy upgrades to the ILC to reach the 380 GeV-1 TeV energy range beyond the baseline ILC and the multi-TeV energy range in the future. This includes SRF R&D, such as development of advanced superconductors including Nb₃Sn for cavities [133], advanced geometries [117], and a plasma accelerator that leverage the SRF-based ILC baseline system. For more details on these upgrades, see Sec. 15.

4.5.2 Electron and Positron Sources

Many US labs have capabilities in sources from their own facilities. The plan for ILC has a polarized positron source, which can be accomplished in different ways. One of these employs superconducting undulators, the other targets, and both subjects have expertise at a number of US labs.

4.5.3 Damping Ring, Beam Delivery System, and Beam Dump

US accelerator scientists have extensive experience also in the technologies needed for the damping ring, beam delivery system, and beam dump.

The damping ring is expected to be similar to multiple US facilities, such as the APS upgrade at Argonne, CESR at Cornell, and NSLS-II at Brookhaven.

For beam dynamics and lattice development, researchers at nearly all US labs with accelerators have substantial relevant experience as well as specialized tools and codes such as ACE3P, ELEGANT, and BLAST.

Expertise in superconducting magnets at labs such as FNAL, Berkeley, and BNL can be applied to the magnets needed for the final focus at the interaction point. A similar task is ongoing at US labs for production of magnets for the high luminosity upgrade of the LHC.

For research and development related to plasma-accelerator-based multi-TeV upgrades to ILC, US labs host multiple accelerator facilities that could be used for relevant R&D including AWA at Argonne, FACET at SLAC, ATF at BNL, BELLA at LBL, and FAST at Fermilab.

4.5.4 Summary

The US National Laboratories are anticipating a wide range of contributions to the ILC accelerator. These contributions are synergistic, both from past programs—*i.e.*, they leverage existing infrastructure and expertise in US labs—and for developments for the future—*i.e.*, much of the needed R&D for the US contribution to ILC has application to other accelerator projects that the laboratories are involved in.

By virtue of this, there is a broad interest among all of the US National Laboratories invested in accelerator physics in participating in ILC. In addition to synergies with US labs, there is also synergy with US industry. A substantial part of the US funds for ILC construction will be put towards procurements from US companies for high-tech components that will be used in cryomodules and other accelerator elements.

Chapter 5

General Aspects of the ILC Physics Environment

[5 pages; corresponding editors: Daniel Jeans (daniel.jeans@kek.jp), Jenny List (jenny.list@desy.de), Michael Peskin (mpeskin@slac.stanford.edu)]

5.1 Key Standard Model Processes

(This section will contain an orientation to the SM processes at the ILC: e^+e^- annihilation to fermions, $e^+e^- \rightarrow WW, ZZ$, multi-particle final state, γe and $\gamma\gamma$ reactions. It will give examples of background processes for various interesting reactions, and will emphasize the relative simplicity and well-understood nature of these backgrounds.)

5.2 Energy and Luminosity

(This section will describe the energy and luminosity evolution of the ILC, following the plan described in Sec. 4.2.)

5.3 Beam Polarization

(This section will give an orientation to the physics of beam polarization at e^+e^- linear colliders. It will describe the effective polarization in e^+e^- annihilation and its influence on cross sections and angular distributions. Then it will discuss the use of separate electron and positron polarization to isolate specific physics effects and to control sources of systematic error.)

Chapter 6

ILC Detectors

[general corresponding editors: James Brau (jimbrau@uoregon.edu), Jan Strube (jan.strube@pnnl.gov), Maxim Titov (maxim.titov@cea.fr), Andrew White (awhite@uta.edu)]

6.1 Detector Requirements for the Physics Program

The ILC accelerator design allows for one interaction region, equipped for two experiments. The two experiments are swapped into the Interaction Point within the so-called “push-pull” scheme. The experiments have been designed to allow fast move-in and move-out from the interaction region, on a timescale of a few hours to a day. In 2008 a call for letters of intent was issued to the community. Following a detailed review by an international detector advisory group, two experiments were selected in 2009 and invited to prepare more detailed proposals. These are the SiD detector and the ILD detector described in this section. Both prepared detailed and costed proposals which were scrutinised by the international advisory group and included in the 2013 ILC Technical Design Report [5]. These specific detector designs have been critical input to the design of the ILC itself. A future process is expected in which detector designs will be reconsidered, with optimisations of these two designs and alternative designs which are proposed. In this chapter the two TDR detector proposals are described.

The ILC detectors have been designed to make precision measurements on the Higgs boson, W , Z , t , and other particles. They are able to meet the requirements for such measurements, first, because the experimental conditions are naturally very much more benign than those at the LHC, and second, because the detector collaborations have developed technologies specifically to take advantage of these more forgiving conditions.

An e^+e^- collider gives much lower collision rates and events of much lower complexity than a hadron collider, and detectors can be adapted to take advantage of this. The radiation levels at the ILC will be modest compared with the LHC, except for the special forward calorimeters very close to the beamline, where radiation exposure will be an issue. This allows the consideration of a wide range of materials and technologies for the tracking and calorimeter systems. The generally

low radiation levels allow the innermost vertex detector elements to be located at very small radii, significantly enhancing the efficiency for short-lived particle identification. More generally, the relatively benign ILC experiment environment permits the design of tracking detectors with minimal material budget. This allows the detectors to meet the stringent requirement on the track momentum resolution which is driven by the need to precisely reconstruct the Z mass in the Higgs recoil analysis. This requirement translates into a momentum resolution nearly an order of magnitude better than achieved in the LHC experiments.

At the same time, although they are studying electroweak particle production, it is essential that the ILC detectors have excellent performance for jets. At an e^+e^- collider, W and Z bosons are readily observed in their hadronic decay modes, and the study of these modes plays a major role in most analyses. To meet the requirements of precision measurements, the ILC detectors are optimized from the beginning to enable jet reconstruction and measurement using the particle-flow algorithm (PFA). This drives the goal of 3% jet mass resolution at energies above 100 GeV, a resolution about twice as good as has been achieved in the LHC experiments.

Finally, while the LHC detectors depend crucially on multi-level triggers that filter out only a small fraction of events for analysis, the rate of interactions at the ILC is sufficiently low to allow running without a trigger. The ILC accelerator design is based on trains of electron and positron bunches, with a repetition rate of 5 Hz, and with 1312 bunches (and bunch collisions) per train. The 199 ms interval between bunch trains provides ample time for a full readout of data from the previous train. While there are background processes arising from beam-beam interactions, the detector occupancies arising from these have been shown to be manageable.

The combination of extremely precise tracking, excellent jet mass resolution, and triggerless running gives the ILC, at 250 GeV and at higher energies, a superb potential for discovery.

To meet these goals an ambitious R&D program has been pursued for more than a decade to develop and demonstrate the needed technologies. The results of this program are described in some detail in Ref. [134]. The two experiments proposed for the ILC, SiD and ILD, utilise and rely on the results from these R&D efforts.

Since the goals of SiD and ILD in terms of material budget, tracking performance, heavy-flavor tagging, and jet mass resolution are very demanding, it is important to provide information about the level of detailed input that enters our performance estimates. These are best discussed together with the event reconstruction and analysis framework that we will present in Chapter 7. In that section, we will present estimates of detector performance as illustrations at the successive stages of event analysis.

6.2 The ILD Detector

The International Large Detector, ILD, is a detector proposal for the International Linear Collider, ILC. The ILD concept is supported by a broad and international community of scientists, and has been subjected to a number of international reviews.

A central role in ILD plays the concept of particle flow, an idea to reconstruct complex events at

a collider with unprecedented precision. ILD decided early on to adopt particle flow as the central guiding principle for its detector concept, and developed the ILD design around this paradigm. For a review on particle flow, see e.g. [135].

The ILD concept has been documented in a number of documents. The basic concept and its validation were first discussed in the ILD detector baseline document in 2013 [5]. Recently ILD published an update of this document, the Interim Design Report, IDR [?].

The ILD detector design: requirements

The science which will be done at the ILC has been summarised earlier in this document. It is strongly dominated by the quest for ultimate precision in measurements of the properties of key particles like the Higgs boson, the weak gauge bosons, and, once the center-of-mass energy is beyond its production threshold, the top quark (see for example [136] or [137] for recent summaries).

The anticipated precision physics program drives the requirements for the detector. Many final states which will be analysed are hadronic final states, with many jets. Thus a precise reconstruction of jets is essential, which translates into an excellent jet energy resolution. Several studies that investigated the reconstruction of W and Z bosons suggest that a jet energy resolution of about 3% is needed to fully exploit the power of the collider. Such a resolution is almost two times more precise than the ATLAS and CMS detectors at the LHC have achieved. The concept of particle flow is currently believed to be the only practical approach through which this level of precision can be reached. Particle flow requires the reconstruction of charged and neutral particles with excellent efficiency over a large solid angle. A tracker with outstanding efficiency is an essential ingredient, combined with a calorimeter capable of reconstructing neutral particles with high efficiency. For ILD the choice has been made to combine a large volume hybrid tracking system, with an excellent silicon detector part and a large gaseous tracker - which promises excellent efficiency combined with low material - and a highly granular calorimeter both in the electromagnetic and the hadronic sections. To ease linking between the tracker and the calorimeter, the calorimeter should be inside the coil.

A number of highly relevant physics processes require the precise reconstruction of exclusive final states containing heavy flavour quarks. This translates into the need for very precise reconstruction of the decay vertices of long lived particles, and thus implies a high resolution vertexing system close to the interaction region.

The excellent performance of the detector system depends critically on the amount of material in the inner part of the ILD detector. The total material budget in front of the calorimeter should be below 10% of a radiation length, for the barrel part of the detector acceptance.

The whole detector should be operated without a hardware trigger, to maximise the sensitivity to new physics signals. This in turn put stringent requirements on the readout electronics, in terms of speed and power consumption. The integration of ILD is faced with the additional complexity to allow for a rapid movement of the detector in and out of the interaction region, the so-called push-pull scheme. This scheme will allow the operation of two separate and complementary experiments in one interaction region at the ILC.

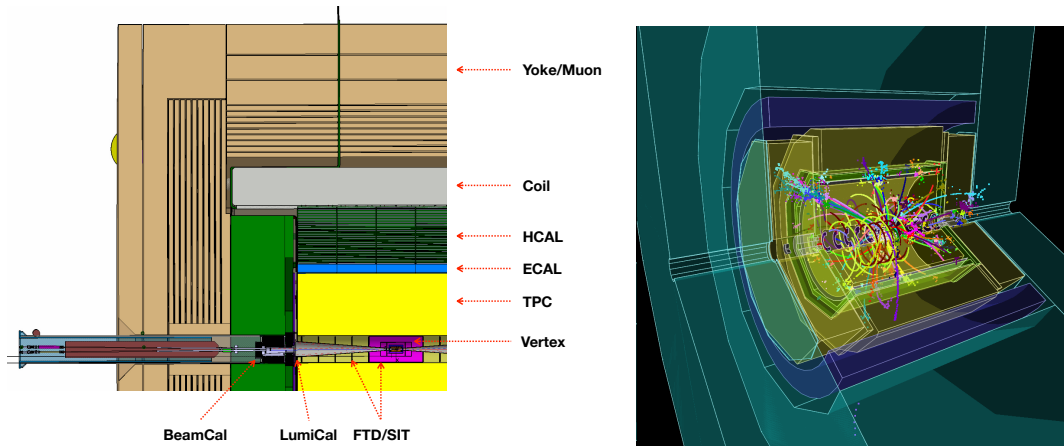

Figure 6.1: Left: Single quadrant view of the ILD detector. Right: Event display of a simulated hadronic decay of a $t\bar{t}$ event in ILD. The colouring of the tracks show the results of the reconstruction, each colour corresponding to a reconstructed particle.

The design drivers of the ILD detector can thus be summarized by the following requirements:

- **Impact parameter resolution:** An impact parameter resolution of $5 \mu\text{m} \oplus 10 \mu\text{m}/[p \text{ (GeV}/c) \sin^{3/2} \theta]$ has been defined as a goal, where θ is the angle between the particle and the beamline.
- **Momentum resolution:** An inverse momentum resolution of $\Delta(1/p) = 2 \times 10^{-5} \text{ (GeV}/c^{-1}/)$ asymptotically at high momenta should be reached with the combined silicon - TPC tracker. Maintaining excellent tracking efficiency and very good momentum resolution at lower momenta will be achieved by an aggressive design to minimise the detector's material budget.
- **Jet energy resolution:** Using the paradigm of particle flow a jet energy resolution $\Delta E/E = 3\%$ for light flavour jets should be reached. The resolution is defined in reference to light-quark jets, as the R.M.S. of the inner 90% of the energy distribution.
- **Readout:** The detector readout will not use a hardware trigger, ensuring full efficiency for all possible event topologies.
- **Powering** To allow a continuous readout, and, at the same time, minimize the amount of dead material in the detector, the power of major systems will be cycled between bunch trains.

Implementation of the ILD detector

The ambitious requirements of the ILC detectors sparked a world-wide R&D program to develop and demonstrate the different technologies needed [138]. The R&D was mostly coordinated and executed within so-called R&D collaborations, which concentrated on particular technologies and

sub-detector systems. These collaborations operated outside the ILD concept group, serving, in many cases, several detector concept groups. The ILD concept group from its beginning has collaborated very closely with these R&D groups, and has organised the needed R&D work through and with the R&D collaborations.

The ILD detector as it has been documented in the ?? has been the result of a decade-long effort. A three-dimensional rendering of the detector model is shown in figure ?. A quadrant view of the large detector model is shown in figure 6.1 (left), together with an event display in this detector of a top event figure 6.1 (right).

The ILD concept from its inception has been open to new technologies. No final decision on subdetector technologies has been taken at this time, and in many cases several options are currently under consideration. ILD is actively inviting new groups to join the effort and propose new ideas or improvements to the current concept.

The main parameters of the ILD detector are summarised in table 6.1, together with the different technological options under consideration.

In the following paragraphs, the different components of the ILD concept are introduced and discussed.

Vertexing system

The system closest to the interaction region is a pixel detector designed to reconstruct decay vertices of short lived particles with great precision. ILD has chosen a system consisting of three double layers of pixel detectors. The innermost layer is only half as long as the others to reduce the exposure to background hits. Each layer will provide a spatial resolution around $4\ \mu\text{m}$ at a pitch of about $22\ \mu\text{m}$, and a timing resolution per layer of around $2\text{--}4\ \mu\text{s}$. R&D is directed towards improving this even further, to a point which would allow hits from individual bunch crossings to be resolved.

Over the last 10 years the CMOS pixel technology has matured close to a point where all the requirements (material budget, readout speed, granularity) needed for an ILC detector can be met. The technology has seen a first large scale use in the STAR vertex detector [139], and more recently in the upgrade of the ALICE vertex detector. To minimize the material in the system, sensors are routinely thinned to $50\ \mu\text{m}$.

Other technologies under consideration for ILD are DEPFET, which is also currently being deployed in the Belle II vertex detector [140], fine pitch CCDs [141], and also less mature technologies such as SOI (Silicon-on-insulator) and Chronopix [138]. Very light weight support structures have been developed, which bring the goal of 0.15% of a radiation length per layer within reach. Such structures are now used in the Belle II vertex detector.

In figure 6.2 the purity of the flavour identification in ILD is shown as a function of its efficiency. The performance for b-jet identification is excellent, and charm-jet identification is also good, providing a purity of about 70% at an efficiency of 60%. The system also allows the accurate determination of the charge of displaced vertices, and contributes strongly to the low-momentum

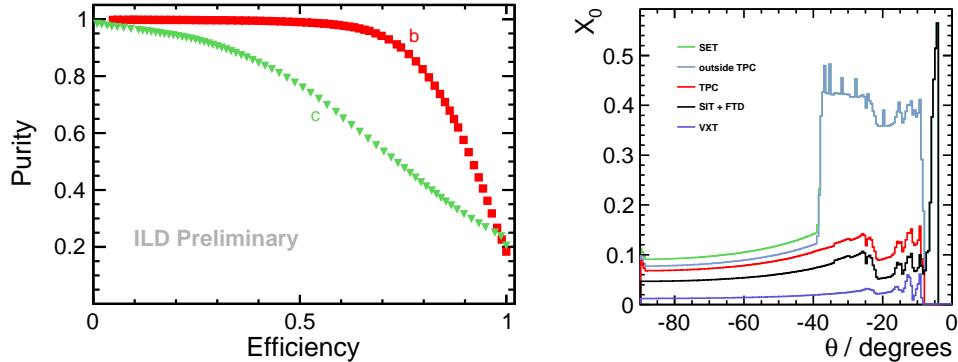

Figure 6.2: Left: Purity of the flavour tag as a function of the efficiency, for different flavours tagged. Right: Cumulative material budget in ILD up to the calorimeter, in fraction of a radiation length (figures from [142]).

tracking capabilities of the overall system, down to a few 10s of MeV. An important aspect of the system leading to superb flavour tagging is the small amount of material in the tracker. This is shown in figure 6.2 (right).

Tracking System

ILD has decided to approach the problem of charged particle tracking with a hybrid solution, which combines a high resolution time-projection chamber (TPC) with a few layers of strategically placed strip or pixel detectors before and after the TPC. The time-projection chamber will fill a large volume about 4.6 m in length, spanning radii from 33 to 180 cm. In this volume the TPC provides up to 220 three dimensional points for continuous tracking with a single-hit resolution of better than 100 μm in $r\phi$, and about 1 mm in z . This high number of points allows a reconstruction of the charged particle component of the event with high accuracy, including the reconstruction of secondaries, long lived particles, kinks, etc.. For momenta above 100 MeV, and within the acceptance of the TPC, greater than 99.9% tracking efficiency has been found in events simulated realistically with full backgrounds. At the same time the complete TPC system will introduce only about 10% of a radiation length into the detector [143].

Inside and outside of the TPC volume a few layers of silicon detectors provide high resolution points, at a point resolution of $10\mu\text{m}$. Combined with the TPC track, this will result in an asymptotic momentum resolution of $\delta p_t/p_t^2 = 2 \times 10^{-5} ((\text{GeV}/c)^{-1})$ for the complete system. Since the material in the system is very low, a significantly better resolution at low momenta can be achieved

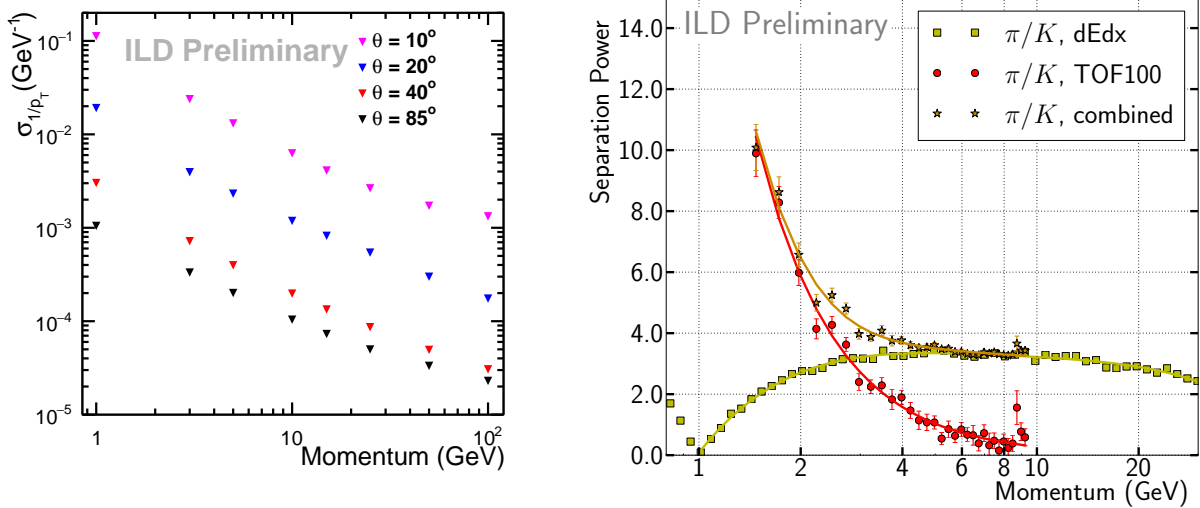

Figure 6.3: Left: Simulated resolution in $1/p_t$ as a function of the momentum for single muons. The different curves correspond to different polar angles. Right: Simulated separation power (probability for a pion to be reconstructed as a kaon) between pions and kaons, from dE/dx and from timing, assuming a 100 ps timing resolution of the first ECAL layer (figures from [142]).

than is possible with a silicon-only tracker. The achievable resolution is illustrated in figure 6.3, where the $1/p_t$ -resolution is shown as a function of the momentum of the charged particle. In the forward direction, extending the coverage down to the beam-pipe, a system of two pixel disks (point resolution $5\mu\text{m}$) and five strip disks (resolution $10\mu\text{m}$ outside of the TPC, and $5\mu\text{m}$ inside the TPC) provide tracking coverage down to the beam-pipe.

The time-projection chamber also enables the identification of the particle type by the measurement of the specific energy loss, dE/dx , for tracks at intermediate momenta [144]. The achievable performance is shown in figure 6.3 (right). If the inner and/or outer silicon layers can in addition provide timing with 100 ps resolution, time of flight measurements can provide additional information, which is particularly effective in the momentum regime which is problematic for dE/dx , as it is shown in figure 6.3 (right).

The design and performance of the TPC has been the subject of intense R&D over the last 15 years. A TPC based on the readout with micro-pattern gas detectors has been developed, and tested in several technological prototypes. The fundamental performance has been demonstrated, and solutions to construct a TPC with the required low mass have been developed. Most recently the performance of the specific energy loss, dE/dx , has been validated in test beam data. Based on these results, the TPC technology is sufficiently mature for use in the ILD detector, and can deliver the required performance (see e.g. [145, 146]).

Calorimeter System

A very powerful calorimeter system is essential to the performance of a detector designed for particle flow reconstruction. Particle flow stresses the ability to separate the individual particles in a jet, both charged and neutral. This puts the imaging capabilities of the system at a premium, and pushes the calorimeter development in the direction of a system with very high granularity in all parts of the system. A highly granular sampling calorimeter is the chosen solution to this challenge [147]. The conceptual and technological development of the particle flow calorimeter have been largely done by the CALICE collaboration (for a review of recent CALICE results see e.g. [148]).

ILD has chosen a sampling calorimeter readout with silicon diodes as one option for the electromagnetic calorimeter. Diodes with pads of about (5×5) mm² are used, to sample a shower up to 30 times in the electromagnetic section. In 2018 a test beam experiment demonstrated the large scale feasibility of this technology, by showing not only that the anticipated resolution can be reached. A very similar system has been adopted by the CMS experiment for the upgrade of the endcap calorimeter, and will deliver invaluable information on the scalability and engineering details of such a system.

As an alternative to the silicon based system, sensitive layers made from thin scintillator strips are also investigated. Orienting the strips perpendicular to each other has the potential to realize an effective cell size of 5×5 mm², with the number of read-out channels reduced by an order of magnitude compared to the all silicon case.

For the hadronic part of the calorimeter of the ILD detector, two technologies are studied, based on either silicon photo diode (SiPM) on scintillator tile technology [149] or resistive plate chambers [150]. The SiPM-on-tile option has a moderate granularity, with 3×3 cm² tiles, and provides an analogue readout of the signal in each tile (AHCAL). The RPC technology has a better granularity, of 1×1 cm², but provides only 2-bit amplitude information (SDHCAL). For both technologies, significant prototypes have been built and operated. Both follow the engineering design anticipated for the final detector, and demonstrate thus not only the performance, but also the scalability of the technology to a large detector. As for the ECAL the SiPM-on-tile technology has been selected as baseline for part of the upgrade of the CMS hadronic end-cap calorimeter, and will thus see a major application in the near future.

The simulated particle flow performance is shown in figure 6.4 (right).

The iron return yoke of the detector, located outside of the coil, is instrumented to act as a tail catcher and as a muon identification system. Several technologies are possible for the instrumented layers. Both RPC chambers and scintillator strips readout with SiPMs have been investigated. Up to 14 active layers, located mostly in the inner half of the iron yoke (see table 6.1 and figure 6.1 for more details) could be instrumented.

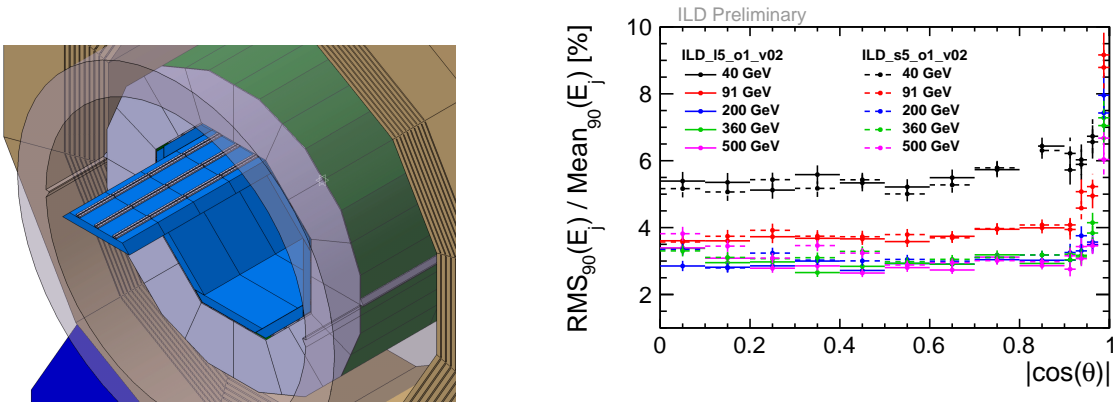

Figure 6.4: Left: Three-dimensional rendering of the barrel calorimeter system, with one ECAL module partially extracted. Right: Particle flow performance, measured as the energy resolution in two-jet light flavour events, for different jet energies as a function of $\cos(\theta)$. The resolution is defined as the rms of the distribution truncated so that 90% of the total jet energy is contained inside the distribution. The data are shown for the large (L) and the small (S) version of the ILD detector. (figures taken from [142])

The Forward System

Three rather specific calorimeter systems are foreseen for the very forward region of the ILD detector [151]. LumiCal is a high precision fine sampling silicon tungsten calorimeter primarily designed to measure electrons from Bhabha scattering, and to precisely determine the integrated luminosity [152]. The LHCAL (Luminosity Hadronic CALorimeter) just outside the LumiCal extends the reach of the endcap calorimeter system to smaller angles relative to the beam, and closes the gap between the inner edge of the ECAL endcap and the luminosity calorimeter, LumiCal. Below the LumiCal acceptance, where background from beamstrahlung rises sharply, BeamCal, placed further downstream from the interaction point, provides added coverage and is used to provide a fast feedback on the beam position at the interaction region. As the systems move close to the beam-pipe, the requirements on radiation hardness and on speed become more and more challenging. Indeed this very forward region in ILD is the only region where radiation hardness of the systems is a key requirement.

Detector Integration and Costing

One of the major goals of the ILD concept group was from the beginning to develop the detector concept from a collection of technological ideas to a real detector that can actually be built, commissioned, and operated within given engineering and site-dependent constraints. The effort, driven by dedicated working groups, resulted in an engineering model of ILD that describes the mechanical setup of the detector structures themselves as well as the detector services such as cabling, cooling, gas systems, and cryogenics. The technical description of ILD is based on Interface Control Documents and is documented on the ILC-EDMS system with a web-based front-end [153].

A detailed CAD model of ILD exists and can be accessed at the same location.

The main mechanical structure of the ILD detector is the iron yoke that consists of three barrel rings and two endcaps. The yoke provides the required shielding for radiation and magnetic fields to allow access to the outside of the detector during data taking. The central yoke ring supports the cryostat for the detector solenoid and the barrel detectors, calorimeters and tracking system. The yoke endcaps carry the detectors in the forward direction and can be opened to allow access to the inner detector. The mechanical concept of ILD has been designed and tested in simulations for seismic conditions that can be expected at the foreseen ILC site in northern Japan.

A common concept for the detector services such as cables, cooling, gases and cryogenics has been developed. The requirements are in many cases based on engineering prototypes of the ILD sub-systems.

The main detector solenoid is based on CMS experience and can deliver magnetic fields up to 4 T. A correction system for the compensation of the crossing angle of the ILC beam, the Detector Integrated Dipole, has been designed and can be integrated into the main magnet cryostat.

The cost of the ILD detector has been estimated at the time of the ILD detailed baseline report and confirmed for the IDR. The total detector cost is about 390 Million ILCU in 2012 costs. One ILCU has been defined to be approximately equal to 1 Dollar or 0.97 Euros in 2013. The cost of the detector is strongly dominated by the cost of the calorimeter system and the yoke, which together account for about 60% of the total cost. The total cost of ILD scales weakly with the overall size of the detector.

6.2.1 Science with ILD

ILD has been designed to operate with electron-positron collisions between 90 GeV and 1 TeV. The science goals of the ILC have been described in detail in [137], and will not be repeated here. It should be pointed out that the analyses which have been performed within the ILD concept group are based on fully simulated events, using a realistic detector model and advanced reconstruction software, and in many cases includes estimates of key systematic effects. This is particularly important when estimating the reach the ILC and ILD will have for specific measurements. Determining, for example, the branching ratios of the Higgs at the percent level depends critically on the detector performance, and thus on the quality of the event simulation and reconstruction.

In many cases the performance used in the physics analyses has been tested against prototype experiments. The key performance numbers for the vertexing, tracking and calorimeter systems are all based on results from test beam experiments. The particle flow performance, a key aspect of the ILD physics reach, could in the absence of a large scale demonstration experiment not be fully verified, but key aspects have been shown in experiments. This includes the single particle resolution for neutral and charged particles, the particle separation in jets, the linking power between tracking and calorimetry, and key aspects of detailed shower analyses important for particle flow.

While the physics case studies are based on the version of the ILD detector presented in the detector volume of the ILC DBD [154], ILD has recently initiated a systematic benchmarking

effort to study the performance of the ILD concept, and to determine in particular the correlations between science objectives and detector performance. The list of benchmark analyses which are under study is given in table 6.2. Even if the ILC will start operation at a center-of-mass energy of 250 GeV, the ILD detector is being designed to meet the more challenging requirements of higher center-of-mass energies, since major parts of the detector, e.g. the coil, the yoke and the main calorimeters will not be replaced when upgrading the accelerator. Therefore, most of the detector benchmark analyses are performed at a center-of-mass energy of 500 GeV, and one benchmark even at 1 TeV. The assumed integrated luminosities and beam polarisation settings follow the canonical running scenario [155]. In addition to the well-established performance aspects of the ILD detector, the potential of new features not yet incorporated in the existing detector prototypes, e.g. time-of-flight information, is being evaluated.

The results of these studies are expected to become available in 2019 and will be published in the ILD Design Report [156]. They will form the basis for the definition of a new ILD baseline detector model, which will then be used for a new physics-oriented Monte-Carlo production for 250 GeV. Such a production is planned with the most recent beam parameters of the accelerator [9] and significantly improved reconstruction algorithms, and is expected to lead to further improvements of the expected results of the precision physics program of the ILC [137].

6.2.2 Integration of ILD into the experimental environment

ILD is designed to be able to work in a push-pull arrangement with another detector at a common ILC interaction region. In this scheme ILD sits on a movable platform in the underground experimental hall. This platform allows for a roll-in of ILD from the parking position into the beam and vice versa within a few hours. The detector can be fully opened and maintained in the parking position.

The current mechanical design of ILD assumes an initial assembly of the detector on the surface, similar to the construction of CMS at the LHC. A vertical shaft from the surface into the underground experimental cavern allows ILD to be lowered in five large segments, corresponding to the five yoke rings.

ILD is designed to fully cope with the ILC beam conditions. The expected levels of beam induced backgrounds have been simulated and are seen to be at tolerable levels, e.g. for the vertex detectors. Judiciously placed shielding keep scattered backgrounds under control. The design of the interaction region and the collimation system of the collider has been defined so as to keep the external background sources at levels below the detector requirements.

ILD is self-shielding with respect to radiation and magnetic fields to enable the operation and maintenance of equipment surrounding the detector, e.g. cryogenics. Of paramount importance is the possibility to operate and maintain the second ILC push-pull detector in the underground cavern during ILC operation.

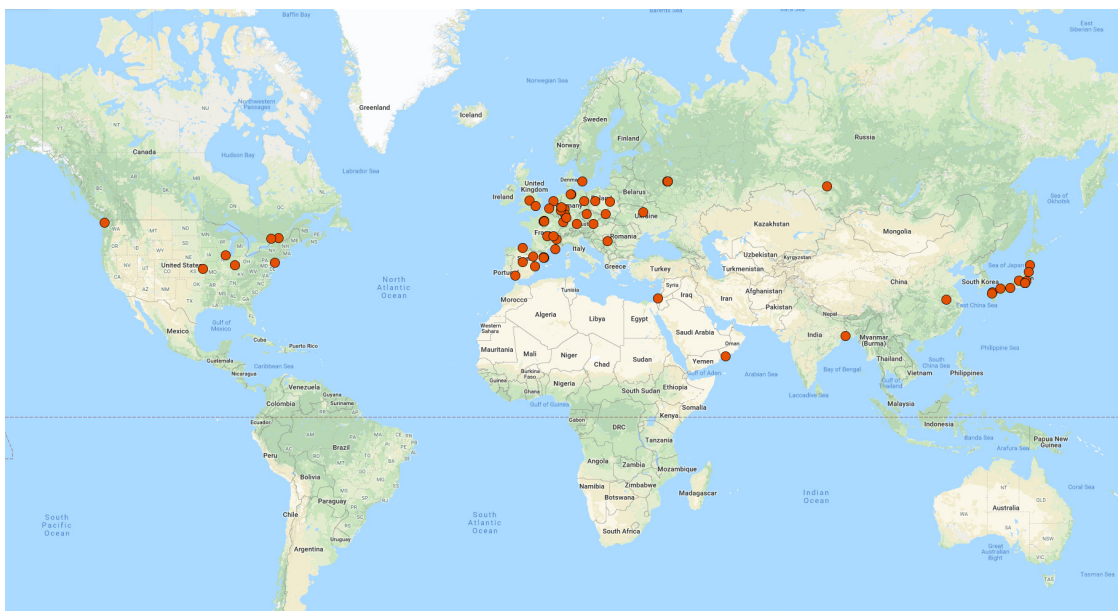

Figure 6.5: Map with the location of the ILD member institutes indicated.

6.2.3 The ILD Concept Group

As described above, the ILD collaboration initially started out as a fairly loosely organised group of scientists interested to explore the design of a detector for a linear collider like the ILC. With the delivery of the DBD in 2013, the group re-organised itself more along the lines of a traditional collaboration. The group gave itself a set of by-laws, which governs the function of the group, and defines rules for the membership in ILD. Groups who want to be members of ILD must sign a memorandum of participation, a first step towards an eventual memorandum of understanding to construct ILD, as soon as the ILC has been approved.

In total 65 groups from 30 countries signed the letter of participation in 2015. In 2018 the list of groups had grown to 72. A map indicating the location of the ILD member institutes is shown in figure 6.5.

6.2.4 Conclusion and Outlook

The ILD detector concept is a well developed integrated detector optimised for use at the electron-positron collider ILC. It is based on advanced detector technology, and driven by the science requirements at the ILC. Most of its major components have been fully demonstrated through prototyping and test beam experiments. The physics performance of ILD has been validated using detailed simulation systems. A community interested in building and operating ILD has formed over the last few years. It is already sizeable, encompassing 72 institutes from around the world. The community is ready to move forward once the ILC project receives approval.

[8 pages; corresponding editor: Ties Behnke (ties.behnke@desy.de)]

6.3 The SiD Detector

[8 pages; corresponding editor: Andrew White (awhite@uta.edu)]

6.3.1 Detector description and capabilities

The SiD detector concept is a general-purpose experiment designed to perform precision measurements at the ILC. It satisfies the challenging detector requirements resulting from the full range of ILC physics processes. SiD is based on the paradigm of particle flow, an algorithm by which the reconstruction of both charged and neutral particles is accomplished by an optimised combination of tracking and calorimetry. The net result is a significantly more precise jet energy measurement than that achieved via conventional methods and which results in a di-jet mass resolution good enough to distinguish between W s and Z s. The SiD detector (Fig. 6.6) is a compact detector based on a powerful silicon pixel vertex detector, silicon tracking, silicon-tungsten electromagnetic calorimetry, and highly segmented hadronic calorimetry. SiD also incorporates a high-field solenoid, iron flux return, and a muon identification system. The use of silicon sensors in the vertex, tracking, and calorimetry enables a unique integrated tracking system ideally suited to particle flow.

The choice of silicon detectors for tracking and vertexing ensures that SiD is robust with respect to beam backgrounds or beam loss, provides superior charged particle momentum resolution, and eliminates out-of-time tracks and backgrounds. The main tracking detector and calorimeters are “live” only during a single bunch crossing, so beam-related backgrounds and low-pT backgrounds from $\gamma\gamma$ processes will be reduced to the minimum possible levels. The SiD calorimetry is optimised for excellent jet energy measurement using the particle flow technique. The complete tracking and calorimeter systems are contained within a superconducting solenoid, which has a 5 T field strength, enabling the overall compact design. The coil is located within a layered iron structure that returns the magnetic flux and is instrumented to allow the identification of muons. All aspects of SiD are the result of intensive and leading-edge research aimed at achieving performance at unprecedented levels. At the same time, the design represents a balance between cost and physics performance. Nevertheless, given advances in technologies it is now appropriate to consider updates to the SiD design as discussed below. First, we describe the baseline SiD design for which the key parameters are listed in Table 6.3.

Silicon-based tracking

The tracking system (Fig. 6.7) is a key element of the SiD detector concept. The particle flow algorithm requires excellent tracking with superb efficiency and two-particle separation. The requirements for precision measurements, in particular in the Higgs sector, place high demands on the momentum resolution at the level of $\delta(1/p_T) \sim 2 - 5 \times 10^{-5}/\text{GeV}/c$.

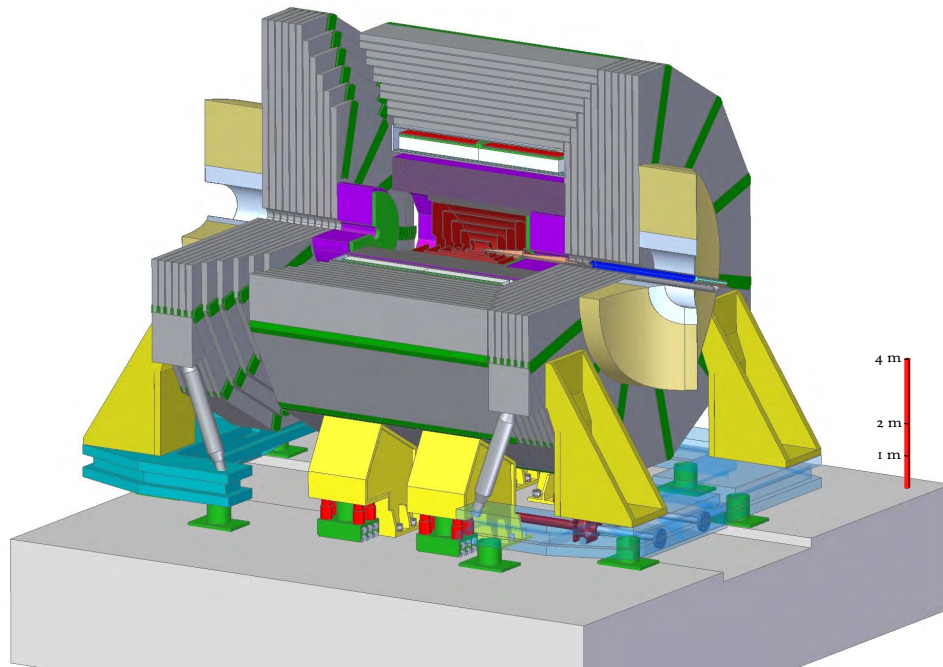

Figure 6.6: The SiD detector concept.

Highly efficient charged particle tracking is achieved using the pixel detector and main tracker to recognise and measure prompt tracks, in conjunction with the ECAL, which can identify short track stubs in its first few layers to catch tracks arising from secondary decays of long-lived particles. With the choice of a 5 T solenoidal magnetic field, in part chosen to control the e^+e^- -pair background, the design allows for a compact tracker design.

Vertex detector

To unravel the underlying physics mechanisms of new observed processes, the identification of heavy flavours will play a critical role. One of the main tools for heavy flavour identification is the vertex detector. The physics goals dictate an unprecedented spatial three-dimensional point resolution and a very low material budget to minimise multiple Coulomb scattering. The running conditions at the ILC impose the readout speed and radiation tolerance. These requirements are normally in tension. High granularity and fast readout compete with each other and tend to increase the power dissipation. Increased power dissipation in turn leads to an increased material budget. The challenges on the vertex detector are considerable and significant R&D is being carried out on both the development of the sensors and the mechanical support. The SiD vertex detector uses a barrel and disk layout. The barrel section consists of five silicon pixel layers with a pixel size of $20 \times 20 \mu\text{m}^2$. The forward and backward regions each have four silicon pixel disks. In addition, there are three silicon pixel disks at a larger distance from the interaction point to provide uniform coverage for the transition region between the vertex detector and the outer tracker. This

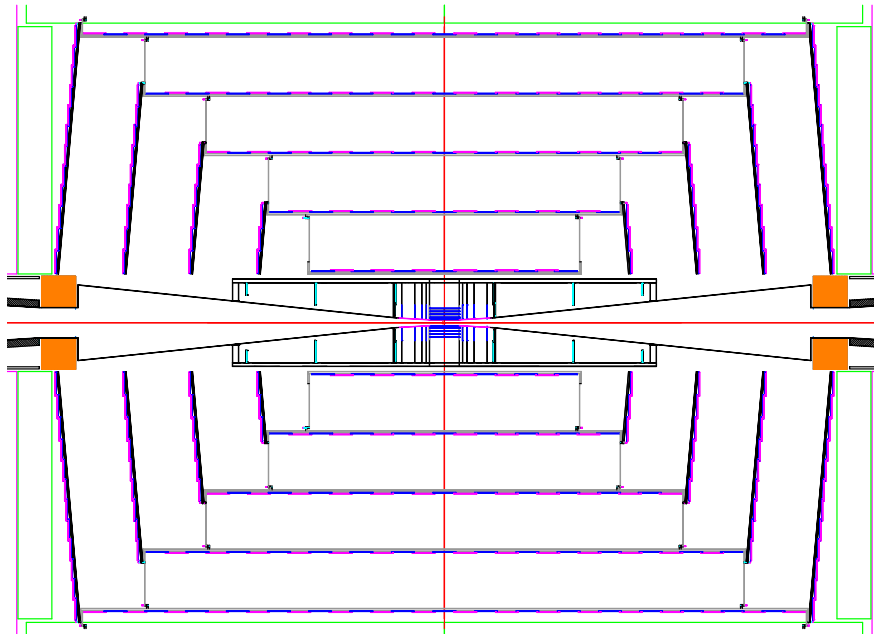

Figure 6.7: r-z view of vertex detector and outer tracker.

configuration provides for very good hermeticity with uniform coverage and guarantees excellent charged-track pattern recognition capability and impact parameter resolution over the full solid angle. This enhances the capability of the integrated tracking system and, in conjunction with the high magnetic field, makes for a very compact system, thereby minimising the size and costs of the calorimetry.

To provide for a very robust track-finding performance the baseline choice for the vertex detector has a sensor technology that provides time-stamping of each hit with sufficient precision to assign it to a particular bunch crossing. This significantly suppresses backgrounds.

Several vertex detector sensor technologies are being developed. One of these is a monolithic CMOS pixel detector with time-stamping capability (Chronopixel [157]), being developed in collaboration with SRI International. The pixel size is about $10 \times 10 \mu\text{m}^2$ with a design goal of 99% charged-particle efficiency. The time-stamping feature of the design means each hit is accompanied by a time tag with sufficient precision to assign it to a particular bunch crossing of the ILC – hence the name Chronopixel. This reduces the occupancy to negligible levels, even in the innermost vertex detector layer, yielding a robust vertex detector which operates at background levels significantly in excess of those currently foreseen for the ILC. Chronopixel differs from the similar detectors developed by other groups by its capability to record time stamps for two hits in each pixel while using standard CMOS processing for manufacturing. Following a series of prototypes, the Chronopixel has been proven to be a feasible concept for the ILC. The three prototype versions were fabricated in 2008, in 2012, and in 2014. The main goal of the third prototype was to test possible solutions for a high capacitance problem discovered in prototype 2. The problem was traced to the TSMC 90 nm technology design rules, which led to an unacceptably large value

of the sensor diode capacitance. Six different layouts for the prototype 3 sensor diode were tested, and the tests demonstrated that the high capacitance problem was solved.

With prototype 3 proving that a Chronopixel sensor can be successful with all known problems solved, optimal sensor design would be the focus of future tests. The charge collection efficiency for different sensor diode options needs to be measured to determine the option with the best signal-to-noise ratio. Also, sensor efficiency for charged particles with sufficient energy to penetrate the sensor thickness and ceramic package, along with a trigger telescope measurement, needs to be determined. Beyond these fundamental measurements, a prototype of a few cm^2 with a final readout scheme would test the longer trace readout resistance, capacitance, and crosstalk.

A more challenging approach is the 3D vertical integrated silicon technology, for which a full demonstration is also close.

Minimising the support material is critical to the development of a high-performance vertex detector. An array of low-mass materials such as reticulated foams and silicon-carbide materials are under consideration. An alternative approach that is being pursued very actively is the embedding of thinned, active sensors in ultra low-mass media. This line of R&D explores thinning active silicon devices to such a thickness that the silicon becomes flexible. The devices can then be embedded in, for example, Kapton structures, providing extreme versatility in designing and constructing a vertex detector.

Power delivery must be accomplished without exceeding the material budget and overheating the detector. The vertex detector design relies on power pulsing during bunch trains to minimise heating and uses forced air for cooling.

Main tracker

The main tracker technology of choice is silicon strip sensors arrayed in five nested cylinders in the central region and four disks following a conical surface with an angle of 5 degrees with respect to the normal to the beamline in each of the end regions. The geometry of the endcaps minimises the material budget to enhance forward tracking. The detectors are single-sided silicon sensors, approximately $10 \times 10 \text{ cm}^2$ with a readout pitch of $50 \mu\text{m}$. The endcaps utilise two sensors bonded back-to-back for small angle stereo measurements. With an outer cylinder radius of 1.25 m and a 5 T field, the charged track momentum resolution will be better than $\delta(1/p_T) = 5 \times 10^{-5}/(\text{GeV}/c)$ for high momentum tracks with coverage down to polar angles of 10 degrees. A plot of the material budget as a function of polar angle is shown in Fig. 6.8.

The all-silicon tracking approach has been extensively tested using full Monte-Carlo simulations including full beam backgrounds. Besides having an excellent momentum resolution it provides robust pattern recognition even in the presence of backgrounds and has a real safety margin, if the machine backgrounds will be worse than expected.

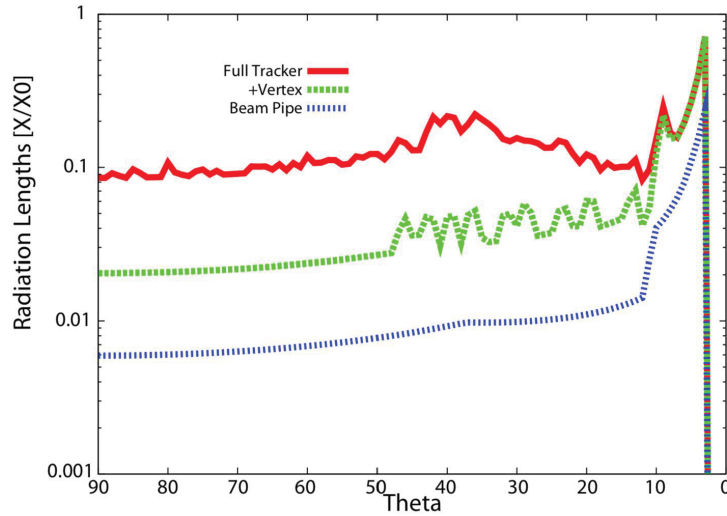

Figure 6.8: Material in the SiD detector, in terms of fractions of a radiation length, as a function of the polar angle.

Main calorimeters

The SiD baseline design incorporates the elements needed to successfully implement the PFA approach. This imposes a number of basic requirements on the calorimetry. The central calorimeter system must be contained within the solenoid in order to reliably associate tracks to energy deposits. The electromagnetic and hadronic sections must have imaging capabilities that allow both efficient track-following and correct assignment of energy clusters to tracks. These requirements imply that the calorimeters must be finely segmented both longitudinally and transversely. In order to ensure that no significant amount of energy can escape detection, the calorimetry must extend down to small angles with respect to the beampipe and must be sufficiently deep to prevent significant energy leakage. Since the average penetration depth of a hadronic shower grows with its energy, the calorimeter system must be designed for the highest-energy collisions envisaged.

In order to ease detector construction the calorimeter mechanical design consists of a series of modules of manageable size and weight. The boundaries between modules are kept as small as possible to prevent significant non-instrumented regions. The detectors are designed to have excellent long-term stability and reliability, since access during the data-taking period will be extremely limited, if not impossible.

The combined ECAL and HCAL systems consist of a central barrel part and two endcaps, nested inside the barrel. The entire barrel system is contained within the volume of the cylindrical superconducting solenoid.

SiD's reliance on particle flow calorimetry to obtain a jet energy resolution of $\sim 3\%$ demands a highly segmented (longitudinally and laterally) electromagnetic calorimeter. It also calls for a minimized lateral electromagnetic shower size, by minimizing the Moliere radius to efficiently

separate photons, electrons and charged hadrons [?].

The SiD ECal design employs thirty longitudinal layers, the first twenty each with 2.50 mm tungsten alloy thickness and 1.25 mm readout gaps, and the last ten with 5.00 mm tungsten alloy. The total depth is 26 radiation lengths, providing good containment of electromagnetic showers.

Simulations have shown the energy resolution for electrons or photons to be well described by $0.17 / \sqrt{E} \oplus 0.009$, degrading a bit at higher energies due to changes in sampling fraction and a small leakage.

The baseline design employs tiled, large, commercially produced silicon sensors (currently assuming 15 cm wafers). The sensors are segmented into pixels that are individually read out over the full range of charge depositions. The complete electronics for the pixels is contained in a single chip, the KPiX ASIC [158], which is bump bonded to the wafer. The low beam-crossing duty cycle (10^{-3}) allows reducing the heat load using power pulsing, thus allowing passive thermal management within the ECal modules.

Bench tests of the KPiX bonded sensor with a cosmic ray telescope trigger yielded a Landau distribution with a peak of the signal at about 4 fC is consistent with our expectation for minimum-ionizing particles (MIP) passing through the fully-depleted 320 μm thick sensors. Crosstalk between channels has been managed and the noise distribution shows an RMS of 0.2 fC, well below the 4 fC MIP signal, and exceeding the ECal requirement.

The overall mechanical structure of the ECal barrel has been designed for minimal uninstrumented gaps. Input power and signals are delivered with Kapton flex cables. The KPiX chip has an average power less than 20 mW, resulting in a total heat load that is managed with a cold plate and water pipes routed into the calorimeter.

A first SiD ECal prototype stack of nine (of thirty) layers has been constructed and was exposed to a 12.1 GeV electron beam at the SLAC End Station Test Beam Facility. This data collection demonstrated good measurements of multiple particle overlap and reconstruction of overlapping showers [159]. Comparison of the deposited energy distribution in each of the nine layers also agrees well with simulations. An algorithm developed to count the number of incident electrons in each event was used to assess the ability of the calorimeter to separate two showers as a function of the separation of the showers, achieving 100% for separations of >10 mm.

The hadronic calorimeter has a depth of 4.5 nuclear interaction lengths, consisting of alternating steel plates and active layers. The baseline choice for the active layers is scintillator tiles read out via silicon photomultipliers. For this approach SiD is closely following the analog hadron calorimeter developments within the CALICE collaboration. In this context, the simulated HCAL energy resolution has been shown to reproduce well the results from the CALICE AHCAL prototype module exposed to pion beams.

Forward calorimeters

Two special calorimeters are foreseen in the very forward region: LumiCal for a precise luminosity measurement, and BeamCal for the fast estimation of the collision parameters and tagging

of forward-scattered beam particles. LumiCal and BeamCal are both compact cylindrical electromagnetic calorimeters centered on the outgoing beam, making use of semiconductor-tungsten technology. BeamCal is placed just in front of the final focus quadrupole and LumiCal is aligned with the electromagnetic calorimeter endcap.

LumiCal makes use of conventional silicon diode sensor readout. It is a precision device with challenging requirements on the mechanics and position control, and must achieve a small Moliere radius to reach its precision targets. Substantial work has been done to thin the silicon sensor readout planes within the silicon-tungsten assembly. Dedicated electronics with an appropriately large dynamic range is under development.

BeamCal is exposed to a large flux of low-energy electron-positron pairs originating from beamstrahlung. These depositions, useful for a bunch-by-bunch luminosity estimate and the determination of beam parameters, require radiation hard sensors. The BeamCal has to cope with 100% occupancies, requiring dedicated front-end electronics. A challenge for BeamCal is to identify sensors that will tolerate over one MGy of ionizing radiation per year. Sensor technologies under consideration include polycrystalline chemical vapor deposition (CVD) diamond (too expensive to be used for the full coverage), GaAs, SiC, Sapphire, and conventional silicon diode sensors. The radiation tolerance of all of these sensor technologies has been studied in a high-intensity electron beam.

For SiD, the main activities are the study of these radiation-hard sensors, development of the first version of the so-called Beam readout chip, and the simulation of BeamCal tagging for physics studies. SiD coordinates these activities through its participation in the FCAL R&D Collaboration.

Magnet coil

The SiD superconducting solenoid is based on the CMS solenoid design philosophy and construction techniques, using a slightly modified CMS conductor as its baseline design. Superconducting strand count in the coextruded Rutherford cable was increased from 32 to 40 to accommodate the higher 5 T central field.

Many iron flux return configurations have been simulated in two dimensions so as to reduce the fringe field. An Opera 3D calculation with the Detector Integrated Dipole (DID) coil has been completed. Calculations of magnetic field with a 3D ANSYS program are in progress. These will have the capability to calculate forces and stress on the DID as well as run transient cases to check the viability of using the DID as a quench propagator for the solenoid. Field and force calculations with an iron endcap HCAL were studied. The field homogeneity improvement was found to be insufficient to pursue this option.

Conceptual DID construction and assembly methods have been studied. The solenoid electrical power system, including a water-cooled dump resistor and grounding, was established. Significant work has been expended on examining different conductor stabiliser options and conductor fabrication methods. This work is pursued as a cost- and time-saving effort for solenoid construction.

Muon system

The flux-return yoke is instrumented with position sensitive detectors to serve as both a muon filter and a tail catcher. The total area to be instrumented is very significant – several thousand square meters. Technologies that lend themselves to low-cost large-area detectors are therefore under investigation. Particles arriving at the muon system have seen large amounts of material in the calorimeters and encounter significant multiple scattering inside the iron. Spatial resolution of a few centimetres is therefore sufficient. Occupancies are low, so strip detectors are possible. The SiD baseline design uses scintillator technology, with RPCs as an alternative. The scintillator technology uses extruded scintillator readout with wavelength shifting fibre and SiPMs, and has been successfully demonstrated. Simulation studies have shown that nine or more layers of sensitive detectors yield adequate energy measurements and good muon detection efficiency and purity. The flux-return yoke itself has been optimised with respect to the uniformity of the central solenoidal field, the external fringe field, and ease of the iron assembly. This was achieved by separating the barrel and end sections of the yoke along a 30 degree line.

The machine-detector interface

A time-efficient implementation of the push-pull model of operation sets specific requirements and challenges for many detector and machine systems, in particular the interaction region (IR) magnets, the cryogenics, the alignment system, the beamline shielding, the detector design and the overall integration. The minimal functional requirements and interface specifications for the push-pull IR have been successfully developed and published [160, 161]. All further IR design work on both the detectors and machine sides are constrained by these specifications.

6.3.2 R&D issues for the SiD design

Monolithic Active Pixel Sensors

MAPS technology is being actively studied for the SiD tracking and electromagnetic calorimeter systems. For larger-scale objects like a full tracker or an ECAL sensor, larger structures than the usual full-reticle size (roughly $2.5 \times 2.5\text{cm}^2$) units are required. Reticles would be stitched together with balcony circuitry on one or two (opposing) edges.

In terms of general MAPS R&D required for SiD, mastering of the stitching technology is required, as for such large areas - $O(\sim 100\text{m}^2)$ for the tracker and $O(\sim 1000\text{m}^2)$ for the ECAL - yield becomes an issue. The distribution of power and data over such a large area sensor will be a challenge as well and dedicated R&D is needed.

Given the timescales involved for the construction of an ILC detector like SiD with the mainstay of construction happening at the end of decade, investment into new processes are needed, as the presently available processes will most likely not be available anymore. The most probable technology for a next-generation MAPS process are the $\sim 65\text{nm}$ CMOS processes that are just becoming available to the community. As CMOS processes use larger wafers (ten or twelve inch

wafers) as well as taking advantage of a fully industrial process, the move to MAPS also has clear advantages in terms of a cost reduction for both the tracker and the ECAL.

Hadron Calorimeter

Extensions to and optimization of the hadron calorimeter design will also address the following:

- inclusion of timing layers to assist the particle flow algorithm in separating the delayed shower components from slow neutrons from the prompt components.
- potential cost saving by making some of the outer layers thicker if there is no significant degradation in energy resolution.
- optimization of the boundary region between the ECAL and the HCAL and optimization of the first layers of the HCAL to best assist with the measurement of electromagnetic shower leakage into the HCAL.
- reconsideration of the effects of projective cracks between modules. There is some indication from earlier studies that projective cracks have no negative effect on energy resolution, but this needs further verification.
- exploration of alternative layouts for HCAL sectors in the end-caps.
- optimization of the boundary between the HCAL barrel and end-caps.

Muon system

- Optimization of number of instrumented layers, barrel and end-caps.
- Optimization of strip lengths, mainly for barrel system.
- Design for muon endcaps - twelve-fold geometry.
- Occupancies at inner radius of muon end-caps versus strip widths.
- Role of muon system as tail-catcher for HCAL. Consideration and implications of CALICE ECAL + HCAL + Tail-catcher test beam results.
- Potential for use of muon system in search for long-lived particles; timing and pointing capabilities.

Forward Calorimeters

Tasks remaining for the forward calorimeters, with participation in the FCAL R&D Collaboration, include:

- LumiCal: complete development of large dynamic range readout electronics.
- LumiCal: develop and demonstrate the ability to position and maintain the position of the calorimeter, particularly at the inner radius, in view of the steep dependence of the rate of Bhabha events on polar angle.
- BeamCal: continue the search for and testing of suitable sensor technology(s) capable of sustained performance in the very high radiation environment.
- BeamCal: continue the study of recognizing single electron shower patterns for tagging for physics studies in the face of high radiation background.

6.4 New Technologies for ILC Detectors

(We hope that any group developing a new technology potentially useful at ILC will contribute to the appropriate subsection below. Please send a summary of your work (hopefully citing a Snowmass contributed paper) to the corresponding editors of this chapter.)

[10 pages]

6.4.1 Tracking

6.4.2 Calorimetry

6.4.3 Vertex Detector

6.4.4 Forward Detectors

6.4.5 Muon System

6.4.6 Timing Elements

Technology	Detector	Start (mm)	Stop (mm)	Comment
pixel detectors	Vertex	$r_{in} = 16$	$r_{out} = 58$	3 double layer pixels
	Forward tracking SIT	$z_{in} = 220$ $r_{in} = 153$	$z_{out} = 371$ $r_{out} = 303$	2 Pixel disks 2 double layer els
Silicon strip	Forward tracking SET	$z_{in} = 645$ $r_{in} = 1773$	$z_{out} = 2212$ $r_{out} = 1776$	5 layers of Si 1 double layer strips
Gaseous tracking	TPC	$r_{in} = 329$	$r_{out} = 1770$	MPGD read points along t
Silicon tungsten calorimeter	ECAL option	$r_{in} = 1805$	$r_{out} = 2028$	30 layers of 5 pixels
	ECAL EC option	$z_{in} = 2411$	$z_{out} = 2635$	30 layers of 5 pixels
	Luminosity calorimeter	$r_{in} = 83$ $z_{in} = 2412$	$r_{out} = 194$ $z_{out} = 2541$	30 layers
Diamond tungsten or GaAs calorimeter	Beam calorimeter	$r_{in} = 18$ $z_{in} = 3115$	$r_{out} = 140$ $z_{out} = 3315$	30 layers
SiPM-on-Tile	ECAL alternative	$r_{in} = 1805$	$r_{out} = 2028$	30 layers, 5 m crossed
	ECAL EC alternative	$z_{in} = 2411$	$z_{out} = 2635$	30 layers, 5 m crossed
	HCAL option	$r_{in} = 2058$	$r_{out} = 3345$	48 layers, 3 × els
	HCAL EC option	$z_{in} = 2650$	$z_{out} = 3937$	48 layers, 3 × els
RPC	HCAL option	$r_{in} = 2058$	$r_{out} = 3234$	48 layers, 1 × els
	HCAL EC option	$z_{in} = 2650$	$z_{out} = 3937$	48 layers, 1 × els
SiPM on scintillator bar	Muon Muon EC	$r_{in} = 4450$ $z_{in} = 4072$	$r_{out} = 7755$ $z_{out} = 6712$	14 layers up to 12 layer

Table 6.1: Key parameters of the ILD detector. All numbers from [5]. “Star” and “Stop” refer to the minimum and maximum extent of subdetectors in radius and/or z -value .

Measurement	Main physics question	main issue addressed
Higgs mass in $H \rightarrow b\bar{b}$	Precision Higgs mass determination	Flavour tag, jet energy resolution, lepton momentum resolution
Branching ratio $H \rightarrow \mu^+\mu^-$	Rare decay, Higgs Yukawa coupling to muons	High-momentum p_t resolution, μ identification
Limit on $H \rightarrow$ invisible	Hidden sector / Higgs portal	Jet energy resolution, Z or recoil mass resolution, hermeticity
Coupling between Z and left-handed τ	Contact interactions, new physics related to 3rd generation	Highly boosted topologies, τ reconstruction, π^0 reconstruction
WW production, W mass	Anomalous triple gauge couplings, W mass	Jet energy resolution, leptons in forward direction
Cross section of $e^+e^- \rightarrow \nu\nu qqqq$	Vector Bosons Scattering, test validity of SM at high energies	W/Z separation, jet energy resolution, hermeticity
Left-Right asymmetry in $e^+e^- \rightarrow \gamma Z$	Full six-dimensional EFT interpretation of Higgs measurements	Jet energy scale calibration, lepton and photon reconstruction
Hadronic branching ratios for $H \rightarrow b\bar{b}$ and $c\bar{c}$	New physics modifying the Higgs couplings	Flavour tag, jet energy resolution
A_{FB}, A_{LR} from $e^+e^- \rightarrow b\bar{b}$ and $t\bar{t} \rightarrow b\bar{b}qqqq/b\bar{b}qq\nu$	Form factors, electroweak coupling	Flavour tag, PID, (multi-)jet final states with jet and vertex charge
Discovery range for low ΔM Higgsinos	Testing SUSY in an area inaccessible for the LHC	Tracks with very low p_t , ISR photon identification, finding multiple vertices
Discovery range for WIMPs in mono-photon channel	Invisible particles, Dark sector	Photon detection at all angles, tagging power in the very forward calorimeters
Discovery range for extra Higgs bosons in $e^+e^- \rightarrow Zh$	Additional scalars with reduced couplings to the Z	Isolated muon finding, ISR photon identification.

Table 6.2: Table of benchmark reactions which are used by ILD to optimize the detector performance. The analyses are mostly conducted at 500 GeV center-of-mass energy, to optimally study the detector sensitivity. The channel, the physics motivation, and the main detector performance parameters are given.

SiDBarrel	Technology	In rad	Out rad	z extent
Vtx detector	Silicon pixels	1.4	6.0	\pm 6.25
Tracker	Silicon strips	21.7	122.1	\pm 152.2
ECAL	Silicon pixels-W	126.5	140.9	\pm 176.5
HCAL	Scint-steel	141.7	249.3	\pm 301.8
Solenoid	5 Tesla SC	259.1	339.2	\pm 298.3
Flux return	Scint-steel	340.2	604.2	\pm 303.3
SiDEndcap	Technology	In z	Out z	Out rad
Vtx detector	Silicon pixels	7.3	83.4	16.6
Tracker	Silicon strips	77.0	164.3	125.5
ECAL	Silicon pixel-W	165.7	180.0	125.0
HCAL	Scint-steel	180.5	302.8	140.2
Flux return	Scint/steel	303.3	567.3	604.2
LumiCal	Silicon-W	155.7	170.0	20.0
BeamCal	Semicond-W	277.5	300.7	13.5

Table 6.3: Key parameters of the baseline SiD design. (All dimension are given in cm).

Chapter 7

ILC Detector Simulation

[5 pages; corresponding editor: Frank Gaede (frank.gaede@desy.de)]

7.1 ILC Fast Simulation Frameworks

As a first step to get started with ILC physics one can use fast simulation tools that can be used to quickly generate substantial samples of simulated and reconstructed events. Situations where this is desirable include detector optimisation and new physics searches. In these cases, similar processes need to be simulated and reconstructed at a, possibly very large, number of different conditions. In the first case, one needs to modify various aspects of the detector in steps, in the latter, one needs to explore the entire allowed parameter space of a theory for new physics. In addition to these cases, fast simulation is also an asset for simulating high cross section SM processes, such as $\gamma\gamma$ processes, where the investment in processor power and intermediate storage might be prohibitively large to attain the goal that simulation statistics should be a negligible source of systematic uncertainty. The ILC community uses two tools for fast simulation that are described in the following:

7.1.1 Delphes for ILC

... describe ILC delphes card and some performance plots ...

7.1.2 SGV

The SGV program[162] used at ILC has a more sophisticated way of simulating the response to charged particles than the Delphes program described above. The time to simulate and reconstruct an event is similar to the time it takes to generate it ($\sim 1 - 10$ ms). The response of the detector is as far as possible calculated from the detector design (so there is no need to parametrise pre-existing full simulation results). SGV has been shown to compare well both with full simulation

and with real data [?].

The program uses a simplified “*cylinders-and-discs*” description of the detector, which is used to calculate the Kalman-filtered track-helix covariance matrix of each generated charged particle. By Cholesky decomposition of the covariance matrix, the track-parameters are simulated in a way such that all correlations are respected. The calorimetric response is calculated from the expected single-particle performance of the different components of the calorimetric system, for each particle impinging on it. Optionally, the effects of shower-confusion can be included. To reduce the needed storage for a Giga-event size sample, event filtering can be applied at different steps of the processing, directly after generation, after the detector response is known, or after higher-level event analysis is done. Events passing all filters are output in LCIO DST-format, and can seamlessly be further analysed within the Marlin framework.

(This section will describe the ILC fast simulation frameworks used for SiD, ILC, and Snowmass projects; see [8].)

7.2 ILCSoft Framework

(This section will describe the ILCSoft Framework used for full-simulation studies of ILC experiments.)

7.3 ILC SM Background Samples

(This section will describe the method of generation of SM event samples for ILC studies.)

Chapter 8

ILC Physics Measurements at 250 GeV

[15 pages; general corresponding editors: Daniel Jeans (daniel.jeans@kek.jp), Jenny List (jenny.list@desy.de), Michael Peskin (mpeskin@slac.stanford.edu)]

(This chapter will review experimental studies of the various ILC reactions available at 250 GeV. The ILD group is now preparing a new high-statistics sample of 250 GeV events. Thus, we expect new analyses of many of these processes to be ready for Snowmass, in particular, a new analysis of $e^+e^- \rightarrow W^+W^-$ at 250 GeV.)

8.1 Higgs – Conventional Decays

[corresponding editor: Daniel Jeans (daniel.jeans@kek.jp)]

The precise measurement of “conventional” Higgs decay branching ratios is key to probing virtual effects of new physics. Many models of new physics at the TeV scale lead to variations in Higgs couplings, typically leading to few-% variations of Standard Model Higgs couplings. The measurement of these couplings is one of the major aims of the Higgs program at high energy electron–positron colliders such as the ILC.

Higgs production in electron–positron collisions at 250 GeV is dominated by the associated production of Higgs and Z bosons (“Higgs-strahlung”), as shown in fig 8.1. Thanks to the initial state of well-defined four-momentum, this process allows the identification of Higgs bosons by considering the mass recoiling against an identified Z boson, without any reference to the decay products of the Higgs itself. A typical reconstructed recoil mass distribution is shown in fig 8.1. A sample of Higgs bosons identified in this way can be almost unbiased with respect to the Higgs decay mode, when the Z boson decays to hadrons or charged leptons. Higgs-strahlung events with Z decays to neutrinos provide significant additional statistics, although the bias-free identification of the Higgs bosons is not possible.

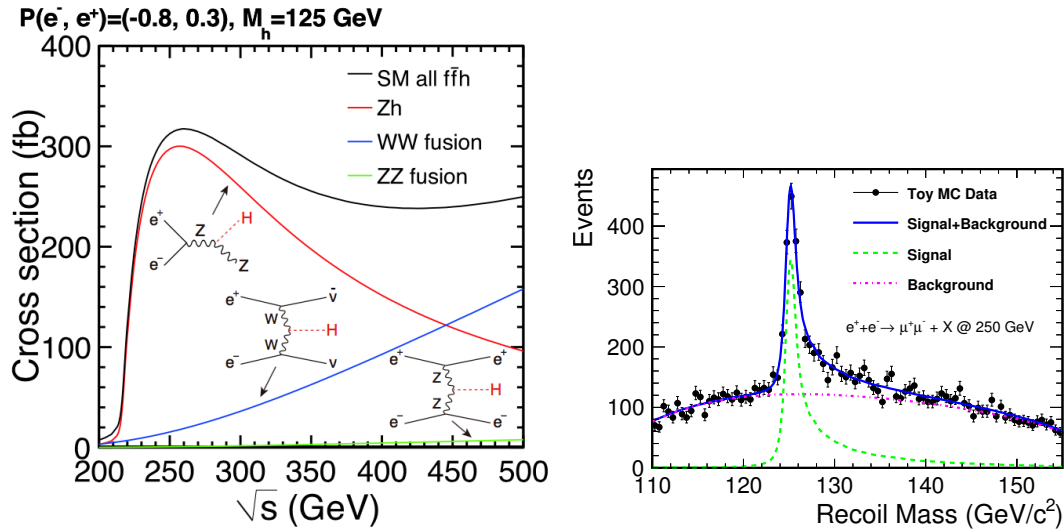

Figure 8.1: Left: Cross sections for the three major Higgs production processes as a function of center of mass energy [2]. The Zh “Higgs-strahlung” process dominates at 250 GeV. Right: Recoil mass spectrum against $Z \rightarrow \mu^+\mu^-$ for signal $e^+e^- \rightarrow Zh$ and SM background at 250 GeV [163].

The mass of the Higgs boson is another key parameter to be extracted. Its precise value has a significant effect on the branching ratio to WW and ZZ, in which the final state includes an off-shell boson, and is therefore closely linked to the interpretation of the measured branching ratios in terms of coupling strengths. ILC also presents an opportunity to probe the Higgs boson’s CP properties, a key to understanding the potential for baryogenesis at the electro-weak scale, in its interaction both with tau leptons and massive vector bosons.

Projections for the experimental precisions attainable at ILC are based on full simulation studies which take into account experimental conditions such as beam energy spread and beam background processes.

8.1.1 Zh cross-section and Higgs mass

The recoil distribution can be used to extract the Zh production cross-section, by consideration of the area of the signal peak, and the Higgs mass by using the position of the same peak. The cross-section will be measured in both beam polarisation combinations, with dominantly left-handed electrons/right-handed positrons, and vice versa. The cross-section in each polarisation combination will be measured with a precision of around 2 %. The asymmetry between the measurements in different polarisation combinations offers an additional important input to a global understanding of Higgs couplings. The precision on the Higgs mass is expected to reach 14 MeV using the recoil mass method at ILC-250 [163].

The Higgs mass can also be directly reconstructed from its decay products, providing comple-

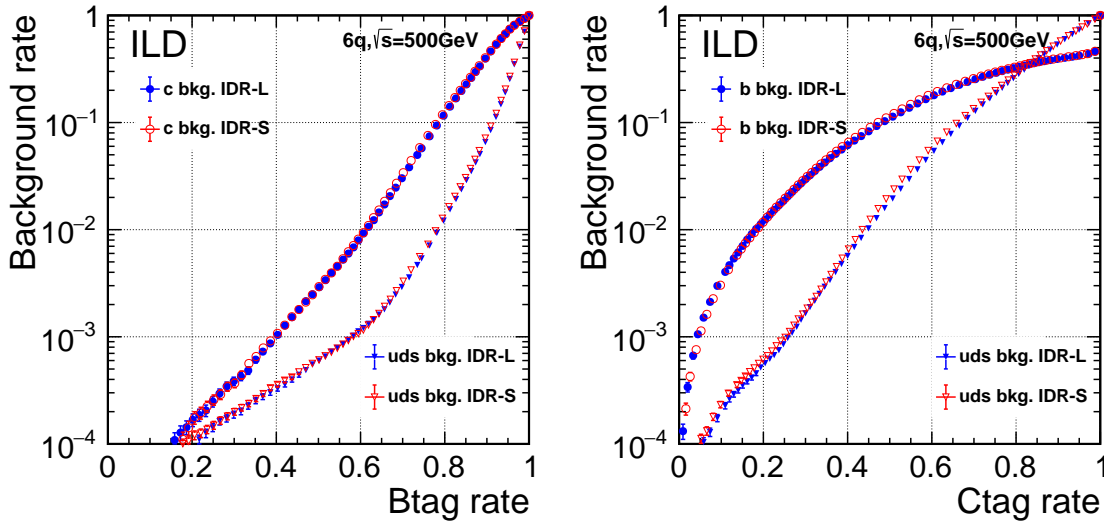

Figure 8.2: B-tag (left) and c-tag (right) performance in full-simulation studies of two variants of the ILD concept, IDR-L and IDR-S (figure from [166]).

mentary measurements. A demonstration in the case of the dominant Higgs decay to beauty can be found in [164], while rare Higgs decays to final states which can be very precisely measured, such as two or four electrons and/or muons, can also provide very competitive precision despite the limited number of events [165].

8.1.2 Hadronic decays

Identifying Higgs decays to different quark types relies on the ability to distinguish jet flavour. In the SM, we expect hadronic Higgs decays to be mostly to b-quarks, c-quarks, and gluons. The keys to distinguishing jet flavor are the identification of displaced vertices produced in the decay of meta-stable particles, of leptons within hadronic jets originating from massive hadron decays, and the flavour identification of experimentally-stable hadrons, in particular of kaons.

The reconstruction of displaced vertices is aided by the tiny ILC interaction region ($8 \text{ nm} \times 500 \text{ nm} \times 300 \mu\text{m}$), and the vertex detector, with first layer placed only $\sim 15 \text{ mm}$ from the IP, and its few-micron hit position resolution. Figure 8.2 shows the b- and c-tagging performance achieved by the LCFIplus algorithm in full simulation studies of the ILDC concept at ILC.

Applying the LCFIplus algorithm to hadronically decaying Higgs bosons produces at ILC250, the partial cross-sections $\sigma_{Zh} \times BR(H \rightarrow bb, cc, gg)$ can be measured to precisions of 1.3%, 8.3%, and 7.0%, respectively [167].

The identification of $H \rightarrow s\bar{s}$ decays presents a significant experimental challenge due to its subtle experimental signature and small branching ratio. Studies are in progress to understand how the identification of hadron species, particularly kaons, can contribute to this measurement; potentially useful techniques include measurement of the specific energy loss dE/dx of charged

particles, the identification of K-short mesons, and of particle identification by time-of-flight.

8.1.3 Leptonic decays

Regarding the leptonic decays of the Higgs boson, the measurement of decays to taus and muons are feasible at ILC supposing that the branching fractions are SM-like. The decay branching ratio to tau leptons is relatively large in the SM, which, together with the suitability of the ILC experimental conditions to the identification of tau lepton decays, results in a precision at ILC250 of 3.2% in the measurement of the partial cross-section $\sigma_{Zh} \times BR(H \rightarrow \tau\tau)$ [168].

The small branching ratio to muons limits the statistics available at ILC. The predicted precision on $BR(H \rightarrow \mu\mu)$ is 23% at ILC250, which can be improved to 17% after the ILC run at 500 GeV [169].

Direct observation of the Higgs coupling to electrons is essentially impossible at ILC if the branching fraction is that predicted by the SM. The final state can in principle be well reconstructed, so if this channel is significantly enhanced, for example to a similar level as the decay to muons, it can be observed at ILC.

8.1.4 EW-boson decays

The measurement of the Higgs branching ratios to WW^* and ZZ^* play an important role in the global probing of the Higgs sector, since these same couplings are involved in Higgs production via WW -fusion and Higgs-strahlung, respectively. These therefore allow direct extraction of the total Higgs decay width $\Gamma_h = \Gamma_{WW/ZZ}/BR_{WW/ZZ}$.

The large number of different final states make for a complex analysis. A recent example of the measurement of ZZ decays can be found in [170], in which a precision of 5-6% on $\sigma_{Zh} \times BR(H \rightarrow ZZ)$ in the different polarisation stages of ILC-250, considering a variety of Z and h decays modes. At ILC-250, overall precisions of at least 4.6% (18%) on $\sigma_{Zh} \times BR(H \rightarrow WW(ZZ))$ are expected.

Rare loop-induced Higgs decays to $\gamma\gamma$ and γZ can also be searched for at ILC-250, although SM-level branching ratios will be difficult to observe due to limited statistics. In the case of $\gamma\gamma$, a precision of 34% on the partial cross-section is expected, while for γZ an upper limit corresponding to xx times the SM cross-section can be set.

8.1.5 CP properties

CP properties of the Higgs boson can be probed in its decays to tau leptons [171], or in its coupling to the EW bosons W and Z (Ogawa et al.).

In the tau decay channel, the tau decay products act as polarimeters, providing an estimate of the spin orientation. The correlation between the two taus' polarimeter components perpendicular to the tau momentum direction is sensitive to their CP state.

The identification of tau leptons is a key performance metric of detectors being developed for the ILC. The ability to reconstruct with excellent precision nearby charged hadrons and photons is an essential ingredient to such an analysis. The measurement of the impact parameters of charged tau decay products can also provide information of the event kinematics, allowing reconstruction of the tau neutrino momentum in events with hadronic tau decays. This is enabled by the small ILC beam-spot and the small distance to the innermost vertex layer and its excellent single-hit precision.

A full simulation study has shown that the admixture of even and odd CP components can be resolved with a precision of 75 mrad at ILC250, when using just a limited number of tau decay modes. There is likely significant room for improvement in this precision.

The coupling of the Higgs to W and Z bosons, either in decay or production, also provides a sensitive probe of CP violation effects. Limits of order (BLAH BLAH) on CP violating terms in the H-V-V coupling can be achieved at ILC250, with further improvement to YY at ILC500. [172].

8.2 Higgs – Exotic Decays

[corresponding editor: Zhen Liu (zliuphys@umn.edu)]

Higgs exotic decays provide unique opportunities probe to a broad class of new physics models [173]. Studying the Higgs exotic decay precision would help reveal new physics, especially hidden sector dynamics through this generic Higgs portal. The physics we can learn from the Higgs exotic decay program is also complementary to the Higgs coupling precision measurements. An survey of lepton collider sensitivities to Higgs exotic decays into final states that are challenging at hadron colliders has been initially carried out in Ref. [174], showing the promising sensitivities at lepton colliders.

As a first attempt, let us focus on two-body Higgs decays into BSM particles, dubbed as X_i , $h \rightarrow X_1 X_2$, which are allowed to decay further, up to four-body final states. The cascade decay modes are classified into four cases, schematically shown in Fig. 8.3. These processes are motivated by a large class of BSM physics, such as singlet extensions, two-Higgs-doublet-models, SUSY models, Higgs portals, gauge extensions of the SM [173, 175, 174].

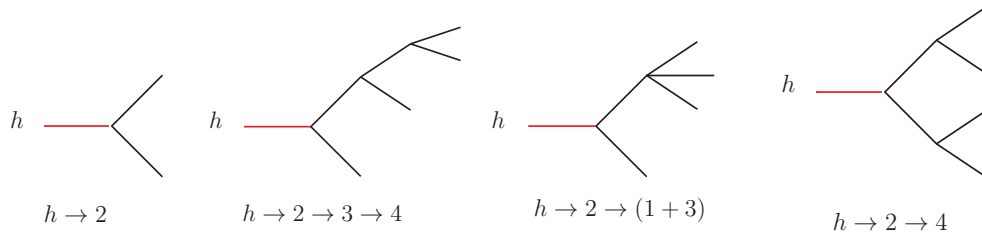

Figure 8.3: Representative topologies of the Higgs exotic decays.

For ILC running at the center of mass energy 250 GeV, the essential Higgs production mechanism is Z-Higgs associated production $e^+e^- \rightarrow Z^* \rightarrow Zh$. The Z boson with visible decays enables

Higgs tagging using the “recoil mass” technique. A cut around the peak of the recoil mass spectrum would remove the majority of the SM background. To demonstrate a typical Higgs exotic search at ILC, we show benchmark processes from our analysis, $h \rightarrow jj + \cancel{E}_T$. In the last part of this section, we present the summary for Higgs exotic decay physics potential at ILC for an integrated luminosity of 2 ab^{-1} and provide an outlook for future studies and improvements.

For numerical analyses, we generate both the signal and the background events for a 240 GeV electron-positron collider with `MadGraph5` at parton level [176]. We describe our parameter choices for the detector effects and our pre-selection cuts that are universal for the analyses for all Higgs exotic decay modes. All of the visible particles in the final state are required to have $|\cos\theta| < 0.98$, or equivalently $|\eta| < 2.3$. The final state particles are required to be well-separated with $y_{ij} \equiv 2 \min(E_i^2, E_j^2) (1 - \cos\theta_{ij}) / E_{vis}^2 \geq 0.001$. We only study the case where the Z boson decays into $\ell^+\ell^-$ where $\ell^\pm = e^\pm, \mu^\pm$. The signal events are required to contain at least a pair of opposite-sign, same-flavor charged leptons with an opening angle greater than 80° , and satisfy $E_\ell > 5 \text{ GeV}$ and $|m_{\ell\ell} - m_Z| < 10 \text{ GeV}$, where $m_{\ell\ell}$ is the invariant mass of the di-lepton system. The recoil mass is defined as $m_{\text{recoil}}^2 \equiv s - 2\sqrt{s}E_{\ell\ell} + m_{\ell\ell}^2$ where $E_{\ell\ell} = E_{\ell^+} + E_{\ell^-}$. The recoil mass is required to satisfy $|m_{\text{recoil}} - m_h| < 5 \text{ GeV}$. To suppress the ISR contribution to the backgrounds¹, for Higgs exotic decay modes without missing energy, we require the events to have the total visible energy $E_{vis} > 225 \text{ GeV}$. We mimic the detector resolution effect by adding Gaussian smearing effects on the four-momentum of the particles, detailed in Ref. [174].

$$h \rightarrow jj + \cancel{E}_T$$

The SM-like Higgs boson decays into X_2X_1 with $X_2 \rightarrow X_1jj$ through an off-shell intermediate state gives rise to this exotic decay mode. Beyond the pre-selection cut and the recoil mass cut, we require that there are two additional jets that satisfy $E_j > 10 \text{ GeV}$ and $|\cos\theta_j| < 0.98$. The dominant background after the recoil mass cut will be the Higgsstrahlung process with $h \rightarrow ZZ^* \rightarrow q\bar{q}\nu\bar{\nu}$.

We use the likelihood function of the $m_{jj}\text{-}\cancel{E}_T$ distribution to derive the exclusive limit. The results are shown in Fig. 8.4 in the plane of X_1 , mass m_1 , and the mass splitting between X_2 and X_1 , $m_2 - m_1$ for $h \rightarrow jj + \cancel{E}_T$. The exclusion limits on the branching fraction in the bulk region of the parameter space reach $3 \times 10^{-4} \sim 8 \times 10^{-4}$ for $h \rightarrow jj + \cancel{E}_T$. We can see that when the mass splitting $m_2 - m_1$ is around 80 GeV, the future lepton colliders have the strongest sensitivities on these Higgs exotic channels, reaching around 4.3×10^{-4} for $h \rightarrow jj + \cancel{E}_T$. When X_1 is light and $m_2 - m_1$ is large, the energy is shared by the two jets and the X_1 . Consequently, when the mass splitting $m_2 - m_1$ is around 80 GeV, the dijet invariant mass will be around 40~60 GeV, falling in the “valley” of low SM background as shown in the left panel of Fig. 8.4. For heavier X_1 , the MET will be lower due to less momentum available for the LSP.

¹Corrections from beamstrahlung effect [177] and ISR effect [178] need to be carefully taken into account for certain processes relying on a precise reconstruction of the recoil mass.

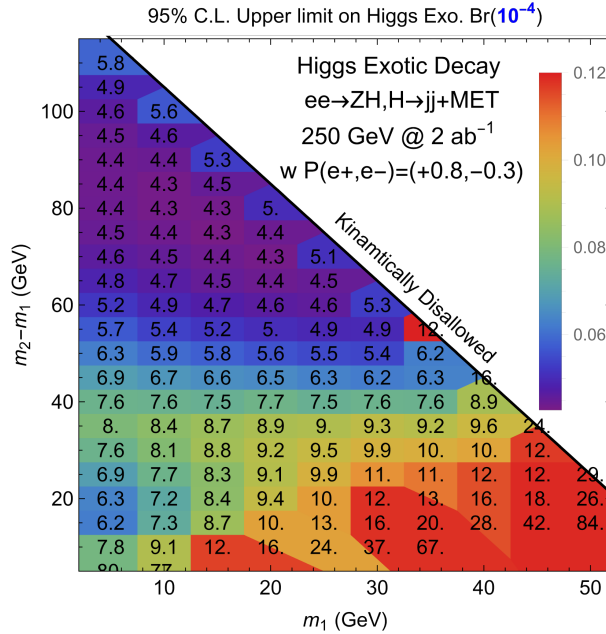

Figure 8.4: The 95% C.L. upper limit on the Higgs exotic decay branching fractions into $jj + \cancel{E}_T$ for various lightest detector-stable particle mass m_1 and mass splittings $m_2 - m_1$.

Summary and outlook

We summarize the set of Higgs exotic decays in Fig. 8.5 for ILC with 2 ab^{-1} integrated luminosity. We also include projected LHC sensitivity in gray bars. We use the up-to-date projected sensitivities for the LHC constraints, but many do not exist or are very conservative. We emphasize that LHC does provide complementary sensitivities in many channels that involve electroweak states, such as photons and charged leptons.

In the summary Fig. 8.5, the exotic Higgs decay channels are selected such that they are hard to be constrained at the LHC. The improvements on the limits of the Higgs exotic decay branching fractions vary from one to four orders of magnitude for these channels. This great advantage benefits a lot from low QCD background and the Higgs tagging from the recoil mass technique at future lepton colliders. As for the Higgs exotic decays without missing energy, the improvement varies between two to three orders of magnitude, except for the one order of magnitude improvement for the $(\gamma\gamma)(\gamma\gamma)$ channel. Reconstructing the Higgs mass from the final state particles at the LHC provides additional signal-background discrimination power. Hence, the improvement from ILC on Higgs exotic decays without missing energy is less impressive than for those with missing energy. Furthermore, as discussed earlier, leptons and photons are relatively clean objects at the LHC, and the sensitivity at the LHC on these channels will be very good. ILC complements the HL-LHC for hadronic channels and channels with missing energy.

Many new and interesting channels remain open for assessment. Higgs exotic decays of $H \rightarrow XX \rightarrow 4f$ where the intermediate resonant particle X mass is below 10 GeV is one of such channels.

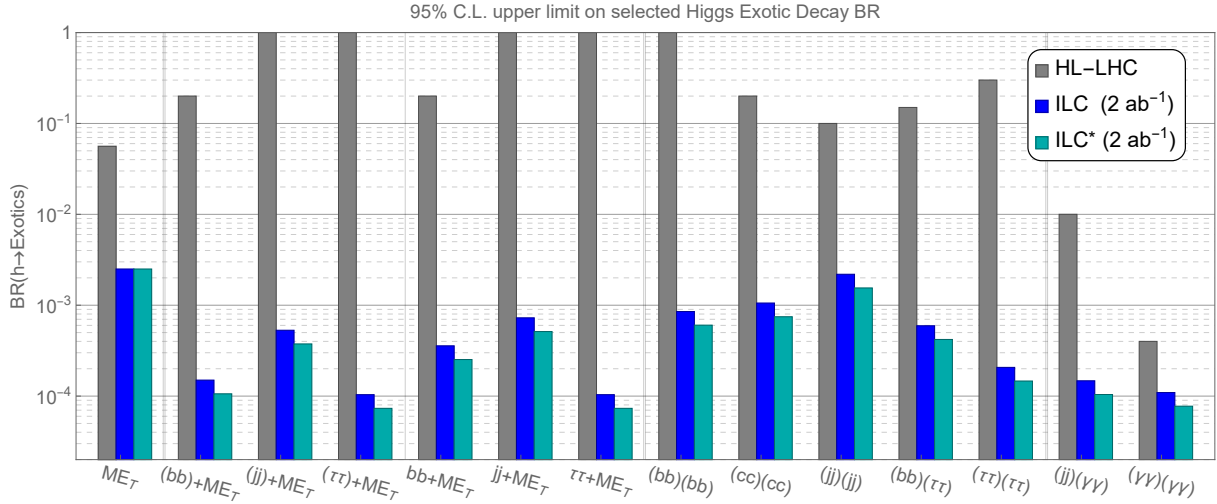

Figure 8.5: The 95% C.L. upper limit on selected Higgs exotic decay branching fractions at HL-LHC and ILC, based on Ref [174]. The ILC curves are derived using results from Ref [174] with leptonic decaying Z boson in the $e^-e^+ \rightarrow ZH$ process. The ILC* scenario further utilizes the hadronically decaying Z boson and includes an estimated (indicative) improvement of 40%. We put several vertical lines in this figure to divide different types of Higgs exotic decays.

This scenario is particularly motivated by recent discussion about Higgs exotic decay connections to strongly first order electroweak phase transition [179, 180]. In this region, the particle X can also be easily long-lived, we can consider to extend the study into long-lived particle regime [181]. Another example is the Higgs decay into dark shower, where the showered hidden mesons² can either decay promptly or long-lived, and their decay channel back to the SM can be either hadronic or leptonic. The phenomenological study for this class of models are basically widely open due to the challenges of trigger and background at the LHC. The process is motivated by generic considerations of hidden sector strong dynamics. A more familiar example is the discussion of neutral naturalness [183], but on the other hand, the current studies have been focusing on the Higgs decays into a pair of twin glueballs [184, 185, 181, 186], which is only a subclass of the generic Higgs decays into these final states. Furthermore, this dark shower channel is also motivated by variance of the class of models with large number of light scalar embedded, e.g., NNaturalness [187], EW scale as a trigger [188], electroweak symmetry delayed- or non-restoration [189, 190, 191, 192], etc.

8.3 W Boson

[corresponding editor: Jenny List (jenny.list@desy.de)]

²It can also be fermions, for instance, composite neutrinos [182].

8.4 4-Fermion Processes

[corresponding editor: Taikan Suehara (suehara@phys.kyushu-u.ac.jp)]

8.5 Precision QCD

[corresponding editor: Ian Mould (imould@slac.stanford.edu)]

(This section will describe not only the precision measurement of α_s from jets at ILC, but also new observables sensitive to jet substructure and other detailed features of QCD. See, for example, [193, 194],)

8.6 Dark Sector

[corresponding editor: Maxim Perelstein (m.perelstein@cornell.edu)]

(This section will describe dark sector searches in $e^+e^- \rightarrow \gamma + X$ and related processes at 250 GeV. More dark sector material appears in Sec. 8.2 above and in Chap. 10 and 11.)

Chapter 9

ILC Precision Electroweak Measurements

[5 pages; corresponding editors: Graham Wilson (gwwilson@ku.edu), Roman Pöschl (poeschl@lal.in2p3.fr)]

9.1 Introduction

The ILC facility with thousand-fold larger accumulated data-sets than prior e^+e^- experiments, polarized beams, and the potential to take data at a wide range of center-of-mass energies will provide the opportunity to advance greatly knowledge of the precision electroweak (PEW) sector. The measurement precision will far exceed the precision achieved in the legacy measurements from LEP/SLC near the Z -pole [195] and from LEP at higher center-of-mass-energies up to 208 GeV [196]. The underlying assets are much higher statistics, really precise modern detectors with much improved reconstruction of particle and jet momenta, and improved theoretical modeling.

An important aspect for fully exploiting the potential is adequate control of systematic uncertainties. This includes aspects such as detector calibration and alignment, determination of the center-of-mass energy, differential luminosity, integrated luminosity, and the polarization of the beams. These need to be maintained over years of accelerator operation and are a critical pre-requisite for extracting the most physics out of potential dedicated physics runs at special center-of-mass energies such as the WW threshold and especially at the Z -pole. Such running is already feasible with the initial 250 GeV ILC accelerator described in Chapter 4 as discussed in [197].

It is obviously not feasible to run the ILC in the single configuration best adapted to measuring each individual PEW observable with the highest precision while still delivering on aspects such as the Higgs, top, and Higgs self-coupling programs. The various ILC data-taking configurations will impact the knowledge gained for each PEW observable in different ways. Having several measurement methods for the same observable with complementary systematic uncertainties should lead to improved knowledge. An important goal for the next years is to further explore these

possibilities to better understand their relative merit and inform accelerator and detector design work.

Examples of the configurations under consideration are:

- Running synergistic with the core physics program. A good example is a LEP2-style measurement of the W mass that is well suited to exploiting data collected at the center-of-mass energy of 250 GeV.
- Complementary methods enabled by high energy running such as measurement of Z properties using radiative return events.
- Dedicated physics run using a polarized scan near the Z -pole accumulating a data sample of 100 fb^{-1} and up to 4 BZs.
- Short few day pilot runs near the Z -pole accumulating at least 10M hadronic Z s at a time for detector calibration and alignment, and for physics; each such sample would be roughly comparable to the whole LEP-1 program, and would permit calibration of the tracker momentum-scale to a statistical uncertainty of 2.5 ppm.
- Dedicated physics run with a polarized scan near the WW threshold.

After describing some of the measurement techniques and prospects, we will revisit these issues more quantitatively. For now let us summarize our overall take:

1. An accelerator built for running above ZH threshold should be exploited as much as possible using Higgs production compatible data. So a clear case needs to be made for the added benefit of dedicated extensive runs at lower energies.
2. The opportunities to make large improvements in the Z observables with a dedicated scan are obvious and warrant dedicated exploitation once the accelerator has been upgraded. In order to evaluate better the eventual reach and required running time, the Z pilot runs should be used early in the ILC program to gain valuable experience. They will also serve as a rich physics sample, a valuable resource for calibration and alignment for the higher energy running, and a high statistics benchmark for the tuning of hadronization models.
3. The W mass can already be measured rather well with the standard ILC program likely obviating the need for substantial time investment in a dedicated run near threshold. Nevertheless, the potential for such a dedicated run with as high as possible beam polarizations should be retained given the perceived uniqueness of the threshold-based observable.

9.2 Radiative Return to the Z

9.3 Measurement of Di-fermion cross sections

In general electroweak di-fermion production in the process $e^+e^- \rightarrow f\bar{f}$, with $f \neq e$, i.e s-channel production in the following, is driven by the coupling $Q_\gamma^{e,f}$ of the initial and final state particles to the photons and the by the couplings $Q_{L,Z}^{e,f}$, $Q_{R,Z}^{e,f}$ of fermions with left-handed and right-handed helicity to the Z boson and a potential Z' Boson of new physics. In a general form the couplings can be expressed as.

$$Q_{eifj} = Q_e^\gamma Q_f^\gamma + \frac{g_{e_i}^Z g_{f_j}^Z}{\sin^2 \theta_W \cos^2 \theta_W} \frac{s}{s - M_Z^2 + i\Gamma_Z M_Z} + \sum \frac{g_{e_i}^{Z'} g_{f_j}^{Z'}}{\sin^2 \theta_W \cos^2 \theta_W} \frac{s}{s - M_{Z'}^2 + i\Gamma_{Z'} M_{Z'}} \quad (9.1)$$

with $i, j = L, R$, $Q_{e,f}^\gamma$ the electromagnetic charges and θ_W being the weak mixing angle at Born level. The first part of the equation describes the electromagnetic couplings to the photon. The second part describes the couplings of the fermions to the Z boson. This second term may be affected by $Z - Z'$ mixing as for example suggested in [198]. The third term takes into account couplings to new vector bosons of e.g. type Z' as for example heavy Kaluza-Klein recurrences included in Randall Sundrum Models with warped extra dimensions. The relative importance of the contributions is determined by the Breit-Wigner functions.

In a general form the differential cross section of the process $e^+e^- \rightarrow f\bar{f}$ for relativistic polarised electron, with polarisation \mathcal{P}_{e^-} and positron beams, with polarisation \mathcal{P}_{e^+} , can be written as [195, 199, 200].

$$\frac{d\sigma}{d\cos\theta} = \frac{3}{4}(1 + |\mathcal{P}_{e^-}| |\mathcal{P}_{e^+}|)(1 - \mathcal{P}_{\text{eff}} A_{LR}) \left(\frac{1}{2} \sigma_{0,HC}(1 + \cos^2\theta) + (\sigma_{0,HV}/\gamma_f) \sin^2\theta \right) + [\sigma_0(1 + |\mathcal{P}_{e^-}| |\mathcal{P}_{e^+}|)((A_{FB})_0 - \mathcal{P}_{\text{eff}} A_{LRFB})] \cos\theta \quad (9.2)$$

with $\cos\theta$ or $\sin\theta$ being the cosine and sine of the polar angle of the final state fermions, $\mathcal{P}_{\text{eff}} = (\mathcal{P}_{e^-} - \mathcal{P}_{e^+})/(1 + |\mathcal{P}_{e^-}| |\mathcal{P}_{e^+}|)$ being the effective polarisation and γ_f being the boost of the final state fermions.

The differential cross section contains four linearly independent quantities.

- The total unpolarised cross section σ_0 split into a helicity-conserving, $\sigma_{0,HC}$, and a helicity-violating part $\sigma_{0,HV}$. In the Standard Model the helicity violating part vanishes at relativistic energies of the final state fermion. In practice the actual cross-section for a given fermion is often normalised to the total hadronic cross section σ_{had} yielding $R_q = \sigma_q/\sigma_{had}$ and $1/R_\ell = \sigma_\ell/\sigma_{had}$ in case of final state quarks and leptons, respectively;
- The unpolarised forward backward asymmetry $(A_{FB})_0$;
- The left-right asymmetry A_{LR} ;

- The left-right-forward-backward asymmetry A_{LRFB} .

The quantities depend on the combinations $Q_{e_i f_j}$ defined in Eq. 9.1. These or similar quantities derived from Eq. 9.2 can be used to determine independently four different individual couplings or the four combinations. In all observables the couplings to the Z enter linearly for centre-of-mass energies away from the Z -Pole due to the γ/Z interference, which allows for determining the actual sign of the couplings. The two asymmetries A_{LR} and A_{LRFB} are only available with polarised beams. In the Standard Model these are of the form $(g_{e_L}^Z - g_{e_R}^Z) \times A(Q_e^\gamma, Q_f^\gamma, g_{e_{L,R}}^Z, g_{f_{L,R}}^Z)$ in case of A_{LR} and $\beta_f(g_{f_L}^Z - g_{f_R}^Z) \times A'(Q_e^\gamma, Q_f^\gamma, g_{f_{L,R}}^Z, g_{e_{L,R}}^Z)$, with $\beta_f = \sqrt{(\gamma_f^2 - 1)}/\gamma_f^2$, in case of A_{LRFB} . In addition $(A_{FB})_0$ is of the form $\beta_f(g_{f_L}^Z - g_{f_R}^Z)(g_{e_L}^Z - g_{e_R}^Z)\hat{A}(Q_e^\gamma, Q_f^\gamma, g_{f_{L,R}}^Z, g_{e_{L,R}}^Z)$. All asymmetries thus vanish close to the production threshold of the fermions yielding reduced sensitivity to the weak part of the interaction. On the Z -Pole (A_{LR}) depends only on the couplings of the electrons while A_{LRFB} depends only of the final state fermion (A_{LRFB}) to the Z . On the Z -Pole this separation allows for a model independent determination of the initial and final state couplings or, equivalently, of the weak mixing angle. The argumentation before relies heavily on the availability of initial state beam polarisation. In principle the electroweak couplings can also be extracted by analysing the final state polarisation. This is readily possible for τ leptons and t quarks for which the polarisation can be derived from the decay particles. At the ILC the analysis of the final state polarisation could be useful as an independent cross-check.

9.3.1 Strategy

The ILC program will comprise a running on the Z -Pole (GigaZ). Supposing that the couplings to the photon are fixed by QED, this program can be used to fix the couplings to the Z boson eventually discovering the presence of a Z' that mixes with the Z . The figure 9.1 shows the precision that can be expected for key quantities at the ILC at the Z -pole.

This translates into precision on the couplings at the Z pole.

In recent years the community has carried detailed studies of the processes $e^+e^- \rightarrow b\bar{b}$ and $e^+e^- \rightarrow c\bar{c}$ at $\sqrt{s} = 250$ GeV. The polar angle distribution for $e^+e^- \rightarrow b\bar{b}$ is given in Fig. 9.2 [201]. It illustrates very clearly that the two combinations of beam polarisation yield different sensitivities for the underlying electroweak couplings.

The result makes use of the correct determination of the charge of the final state quark and is therefore an important benchmark for detector optimisation in terms of measuring secondary vertices and particle ID. A careful analysis of systematic errors has been carried out that includes systematic errors on the hadronic 2-jet cross section as the normalisation in R_q , the beam polarisation and the influence of initial state radiation. The latter implies the detection of the ISR photon among the two jet final state, which advocates the availability of highly granular calorimeters that allow for efficient particle separation. Overall the statistical and systematic errors on key are of the order of 1-3 per mil. This precision would yield high sensitivity to new physics as for example proposed in Grand Higgs Unification models, see Fig. 9.3.

As is pointed out in Ref. [204] it is important to measure di-fermion production for all fermions

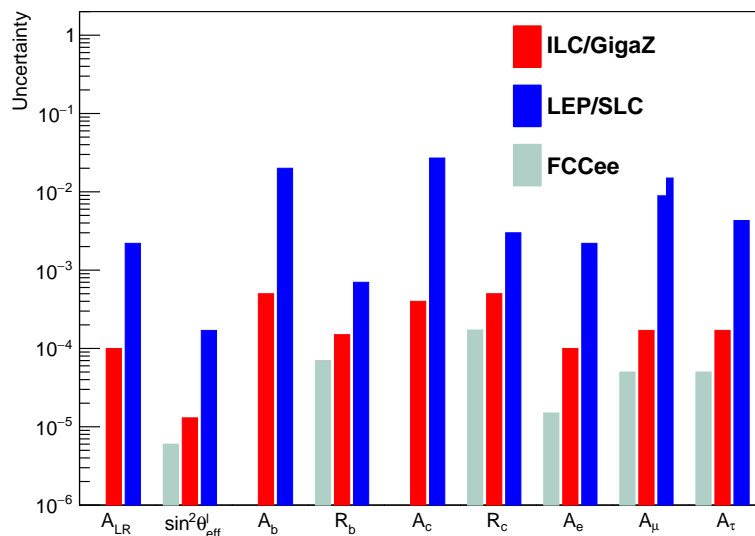

Figure 9.1: Summary of the precision achievable for ILC Z-Pole running compared with LEP/SLC results [195] and FCCee projections [?] for observables and derived quantities that are described in the text.

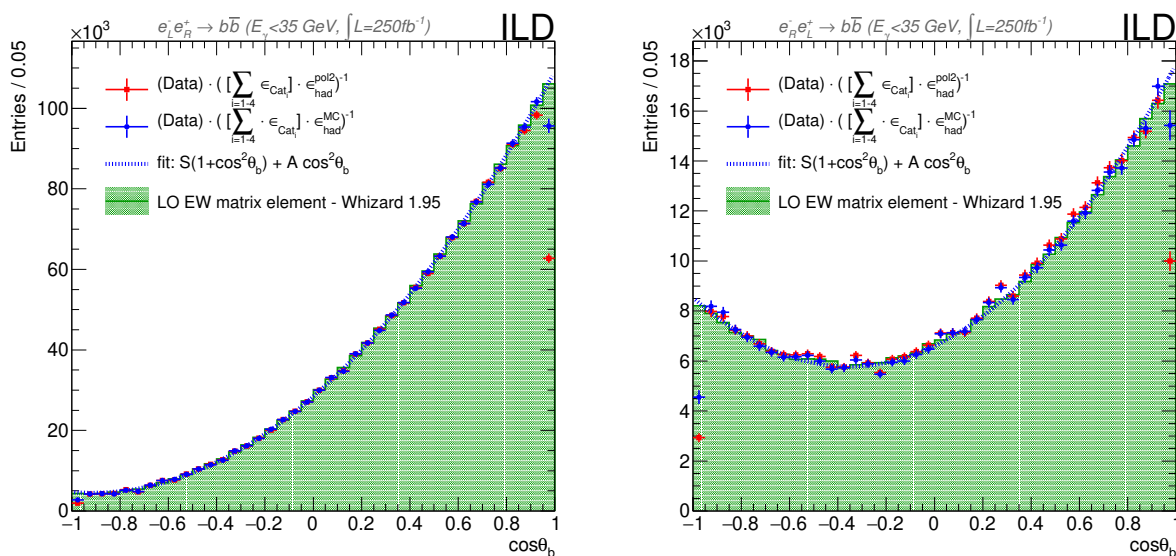

Figure 9.2: $\cos \theta_b$ distributions obtained for $e_L^- e_R^+$ (left) and $e_R^- e_L^+$ (right). The generator distribution is the green histogram and the red and blue dots show the reconstructed distributions after correction charge for charge migration and two different methods for the correction for efficiency and acceptance.

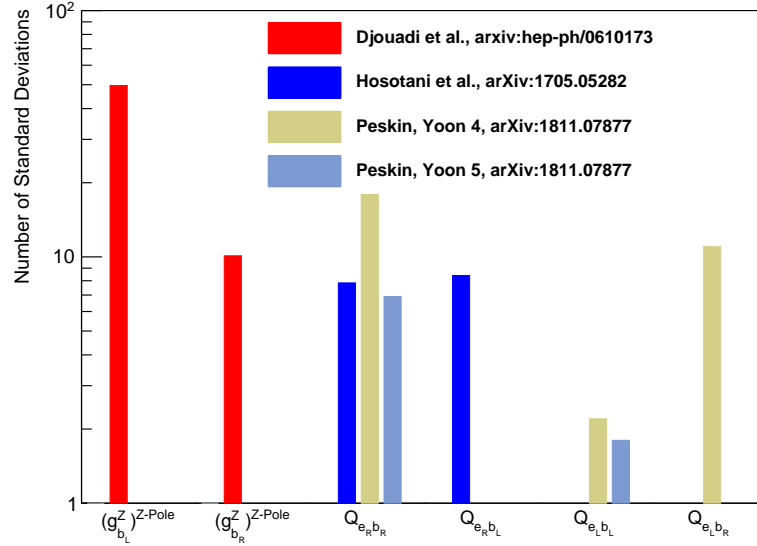

Figure 9.3: Visibility of deviations from the SM predictions in $g_{b_j}^Z$, $g_{b_j}^Z$ (to do: still missing in this plot) and the helicity amplitudes $Q_{e_i b_j}$, in standard deviations, from combined ILC250/Z-Pole running, expected from new physics models with Randall-Sundrum extra dimensions [198, 202, 203].

and different centre-of-mass energies since the effect of new Z' bosons will increase with increasing beam energy.

9.3.2 Outlook

The previous paragraphs focused on results obtained for the production of bottom or charm quark pairs. These studies will be complemented during the Snowmass process by a study of the process $e^+e^- \rightarrow s\bar{s}$. The set of results for bottom, charm and strange-quark pair production may then allow for estimating also the precision on the measurement of electroweak for the lightest quarks u, d. For a complete picture of di-fermion production the precision on electroweak couplings for final state leptons will have to be evaluated. For this, studies presented in [205] will have to be carried out in more detail or existing results would have to be extended [206]. The precision expected for the Z-Pole running are based on extrapolations from full simulation studies at a centre of mass energy of 250 GeV. Given the high precision it will be very important to carry out the studies for Z pole running with full simulation.

9.4 *W* and *Z* Boson Masses

9.5 *W* Boson Branching Fractions

Chapter 10

ILC Physics Measurements at 350, 500, and 1000 GeV

[15 pages; general corresponding editors: Daniel Jeans (daniel.jeans@kek.jp), Jenny List (jenny.list@desy.de), Michael Peskin (mpeskin@slac.stanford.edu)]

10.1 Top Quark

[corresponding editors: Roman Pöschl (poeschl@lal.in2p3.fr), Frank Simon (fsimon@mpp.mpg.de), Marcel Vos (vos@ific.uv.es)]

10.1.1 Top Quark Mass

The top quark mass is one of the fundamental parameters of the Standard Model that must be determined experimentally. Direct measurements at hadron colliders based on Monte Carlo template fits to the reconstructed top quark decay products reach a precision down to 600 MeV at the LHC [207, 208] and the Tevatron [209]. Combinations can further improve [210, 208]. Extractions of the top quark pole mass from measured cross sections using first-principle, fixed-order calculations have reached GeV precision [211, ?].

Top quark mass measurements at the HL-LHC [212] are expected to reach an experimental precision of a few hundred MeV [213], while work is ongoing to improve Monte Carlo generators [214, 215] and to provide a robust interpretation of the Monte Carlo mass parameter in a field-theoretical mass scheme [216, 217, 218]. A complete and recent review can be found in Ref. [219].

An electron-positron collider with sufficient energy to produce top quark pairs has excellent potential to measure the top quark mass with even better precision and a rigorous interpretation. It was realized even before the discovery of the top quark that a scan of the center-of-mass energy of the collider through the top quark pair production threshold yields a very precise top quark

mass measurement [220, 221], with a rigorous interpretation. Since then, the theory predictions for the threshold scan have reached NNNLO precision [] and an NNLL resummation [222] has been performed. The threshold mass that is most naturally extracted from a comparison to the theory can be converted to the \overline{MS} scheme (or any other scheme) at four-loop accuracy [223], with an intrinsic uncertainty due to missing higher orders of $\mathcal{O}(10 \text{ MeV})$ and a parametric uncertainty of $\mathcal{O}(50 \text{ MeV})$ with the current α_s world average [210].

Phenomenological studies of the threshold scan in realistic conditions have been performed by several groups [224, 225, 226, 227]. Fits are performed on pseudo-experiments with an integrated luminosity of 100-200 fb^{-1} divided over up to 10 center-of-mass energies. Apart from the top quark mass, the strong coupling constant, the top quark Yukawa coupling and the top quark width are floated in the fits. Importantly, recent studies take into account the theory uncertainty [228, 229], that is expected to be the dominant source of uncertainty for a top quark mass measurement in a threshold scan at an e^+e^- collider. The statistical uncertainty can be reduced to approximately 20 MeV, depending on the number of free parameters and the number and range of the energy points [230]. The systematic uncertainty from missing higher orders in the prediction and the parametric uncertainty due to the strong coupling constant add up to approximately 50 MeV, with the current state-of-the-art calculations and world average for α_s .

While the threshold is generally considered to be the "golden" top quark mass determination, alternative methods have been studied by several groups. A direct mass measurement can be performed at any center-of-mass energy above the top quark pair production threshold and may provide important information on the interpretation of the MC mass parameter. A statistical uncertainty of 30 MeV (40 MeV) is expected in the l +jets (all-hadronic) channel after the CLIC run that collects 500 fb^{-1} at $\sqrt{s} = 380 \text{ GeV}$ [224].

A measurement of the differential cross section of radiative $e^+e^- \rightarrow t\bar{t}\gamma$ events, where the top quark pair is produced in association with a hard photon from Initial State Radiation (ISR) can yield a top quark mass determination [231]. The measurement of the photon energy gives an event-by-event determination of the effective center-of-mass energy and allows to map out the $t\bar{t}$ threshold with data collected at any center-of-mass energy below $\sim 1 \text{ TeV}$. The expected precision is approximately 110 MeV for CLIC380 (1 ab^{-1} at $\sqrt{s} = 380 \text{ GeV}$ and approximately 150 MeV for ILC500 (4 ab^{-1} at $\sqrt{s} = 500 \text{ GeV}$), including theoretical and experimental systematic uncertainties. This approach is competitive compared to HL-LHC expectation, and the method maintains flexibility in and control over the field-theoretical mass scheme. A combination with the mass obtained from the threshold scan moreover enables a study of the scale dependence ("running") of the top quark mass, testing the evolution predicted by the Renormalization Group Equation (RGE).

Operation of the ILC at the top mass threshold and beyond can hence provide a top quark mass with a precision well beyond what is achievable at hadron colliders and a rigorous interpretation in terms of a field-theoretical mass scheme.

10.1.2 Top Quark Electroweak Couplings

In many extensions of the Standard Model, the top quark plays a special role. Composite Higgs models, for instance, generally predict sizeable deviations for the top quark electro-weak couplings [232]. Precise measurements of top electro-weak couplings can therefore constrain broad classes of composite Higgs scenarios [192].

As the top quark escaped scrutiny at the previous generation of electron-positron colliders, its interactions with the neutral gauge bosons of the Standard Model are relatively poorly constrained. Studies of top quark pair production at hadron colliders have characterized the strong interaction of the top quark in detail, and single top quark production and top quark decay are a sensitive probe of the charged-current interaction. The interactions with the photon and Z -boson have only become accessible with the observation of rare associated production processes, such as $pp \rightarrow t\bar{t}X$ and $pp \rightarrow tXq$, with $X = \gamma, Z$ (and H , of course; a discussion of the interaction of the top quark with the Higgs boson is left for ??). Recent comparisons of cross section measurements to SM predictions have reached a precision of 10-15%, with statistical, experimental and theoretical uncertainties contributing with roughly equal weight [233].

The ILC offers a unique opportunity to measure the electro-weak couplings of the top quark [234, 235], and these measurements are among the prime targets of the ILC top physics programme. The pair-production process in e^+e^- collisions probes the $t\bar{t}Z$ and $t\bar{t}\gamma$ vertices directly. The contributions from the photon and Z -boson are disentangled by using the two polarization configurations. The ILC prospects to constrain the D6 EFT operator coefficients that shift the top and bottom quark EW couplings are compared to current bounds from the LHC and LEP and an extrapolation to HL-LHC in Figure 10.1. The measurements of top quark production rates at the ILC improve the measurement of the EW couplings and the corresponding bounds on the relevant EFT operator coefficients by two orders of magnitude with respect to the current LHC results, and by well over an order of magnitude with respect to HL-LHC expectations. Data above the top quark pair production threshold are clearly required to provide tight bounds on the operator coefficients that affect the top quark couplings.

Measurements at two center-of-mass energies above the $t\bar{t}$ threshold allow to disentangle contributions of the relevant two-fermion and four-fermion operators in the SMEFT [236]. The prospects for constraints on the $e^+e^-t\bar{t}$ four-fermion operators re. With the 1 TeV run envisaged at the ILC the 68% CL bounds of order $C/\Lambda^2 \sim 10^{-3}TeV^{-2}$ [236] and form a powerful test for scenarios with composite (right-handed) top quarks [192] for compositeness scales well beyond the center-of-mass energy.

Dedicated CP-odd observables yield powerful constraints on CP violation in the top sector [237]. Other processes, such as single top quark production and vector-boson-fusion production at high energy provide complementary information [224].

There is a subtle interplay between the Higgs and top physics programmes, as top quark couplings affect the loop diagrams for $gg \rightarrow H$ production at the LHC and $H \rightarrow \gamma\gamma$ and $H \rightarrow Z\gamma$ decays at the LHC and ILC [240]. Precise measurements of top quark couplings are required to fully constrain all degrees of freedom of the Higgs EFT [241]. A further discussion is presented in

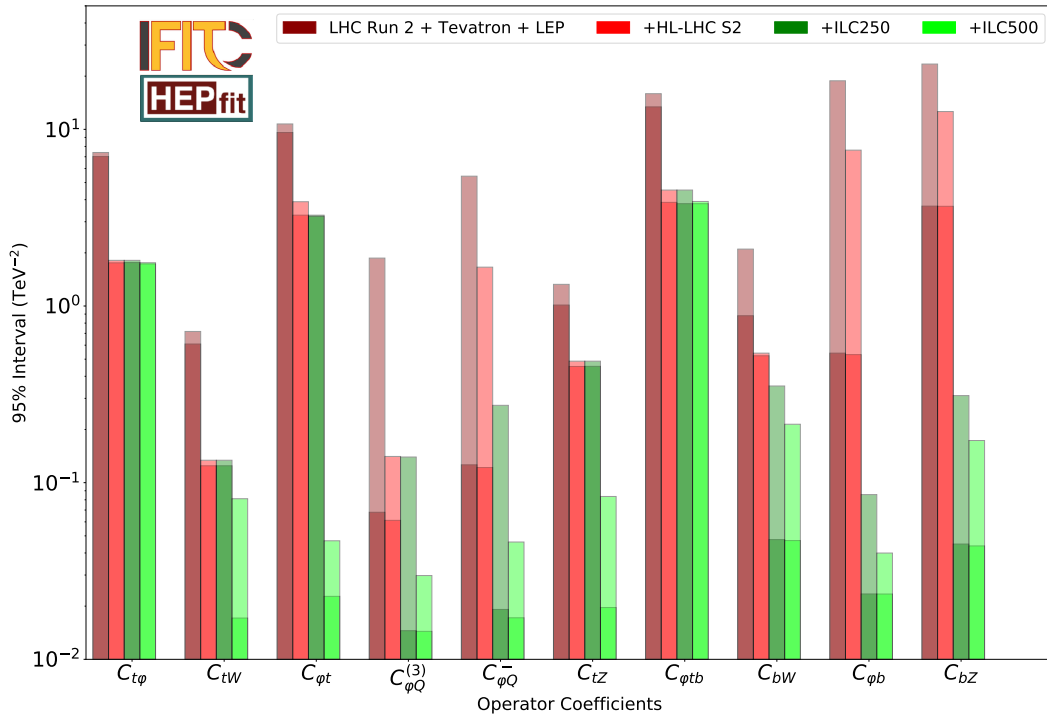

Figure 10.1: Comparison of current 95% CL bounds on the two-fermion Wilson coefficients of the SMEFT that affect the top and bottom quark EW couplings. The LHC bounds correspond to the results of Ref. [233], the HL-LHC S2 projection follows Ref. [238] and the HL-LHC Higgs report [239], while the ILC prospects are based on Ref. [236].

section 12.1.

10.1.3 FCNC searches

Processes with flavour-changing neutral currents (FCNC) are forbidden at tree level in the SM and are strongly suppressed at higher orders by the Glashow-Iliopoulos-Maiani (GIM) mechanism. The branching fractions for top quark FCNC decays $t \rightarrow qX$, where $q = u, c$ and $X = \gamma, g, Z, H$, are of the order of 10^{-12} – 10^{-16} . Extensions of the SM predict a strong enhancement of the FCNC top quark decay rates, increasing the branching fraction up to 10^{-4} in some models[review].

The search for FCNC interactions of the top quark at the LHC has reached excellent sensitivity for tqX . The current 95% CL bounds based on searches for top decays and single top production with the partial run 2 data are equivalent to branching fractions of 10^{-3} – 10^{-4} and are expected to improve significantly with the HL-LHC data [213, 242, 243].

An e^+e^- collider has a very specific role in the search programme for FCNC couplings. The LEP bounds from searches for $e^+e^- \rightarrow tXq$ remain competitive for tqZ and $tq\gamma$ and in particular the $tqll$ operators [244]. The 250 GeV phase of a Higgs factory is expected to improve the LEP bounds by one to two orders of magnitude [245], yielding competitive results in comparison with the full HL-LHC prospects. The higher-energy stages of the ILC are particularly relevant for the bounds on four-fermion operators e^+e^-tq . The sensitivity to these operators increases very strongly with the higher-energy operation [246]. Taking into account the luminosity increase with center-of-mass energy, the bound are expected to scale roughly as $s^{-3/2}$.

The current 95% CL bounds on the equivalent branching fractions are compared to the prospects of the HL-LHC (3 ab^{-1} at 14 TeV), and three energy stages of the ILC (2 ab^{-1} at 250 GeV, 4 ab^{-1} at 500 GeV and 8 ab^{-1} at 1 TeV) in Table 10.1.

	current	HL-LHC	ILC250	ILC500	ILC1000
$\Gamma(t \rightarrow qH)$					
$\Gamma(t \rightarrow qZ)$					
$\Gamma(t \rightarrow qe^+e^-)$					

Table 10.1: Equivalent branching ratios for FCNC interactions of the top quark.

10.1.4 Unexplored areas

10.2 Higgs

10.2.1 WW fusion

[corresponding editor: Daniel Jeans (daniel.jeans@kek.jp)]

The WW fusion process becomes the dominant source of Higgs production at energies about

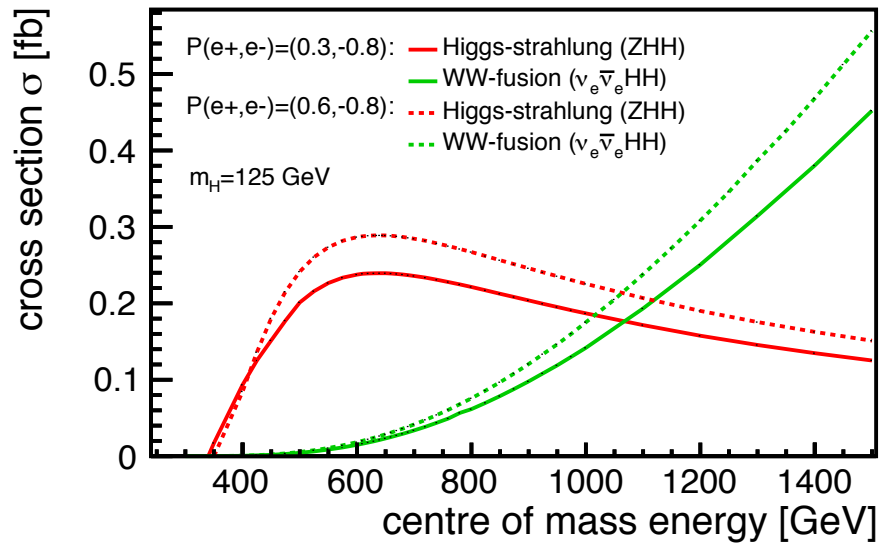

Figure 10.2: Cross-sections for double Higgs production via Higgs-strahlung and WW fusion as a function of the center-of-mass energy [247].

around 400 GeV. It thereby provides higher-precision measurements of Higgs properties, even if the "recoil" methods used to analyse Higgs-strahlung are not applicable here.

Since the process involves the H-W-W coupling, it is particularly sensitive to potential non-SM properties of this vertex.

10.2.2 Higgs Self-Coupling

[corresponding editor: Jenny List (jenny.list@desy.de) — do we need some more general motivation here, or will this be given in the overall introduction? Where will the possibility of large deviations be introduced?]

At center-of-mass energies of at least 500 GeV, the self-interaction of the Higgs boson, in particular the triple-Higgs coupling λ , can be probed directly by studying the production of Higgs boson pairs. The cross-sections of the two relevant di-Higgs production processes double Higgs-strahlung, $e^+e^- \rightarrow ZHH$, and di-Higgs production in WW fusion, $e^+e^- \rightarrow \nu\bar{\nu}HH$, are shown as a function of the center-of-mass energy in Fig. 10.2. While the WW fusion becomes important at and above 1 TeV, the cross-section for double Higgs-strahlung reaches a maximum around 500 – 600 GeV, rendering this energy range, which among the future colliders only the ILC proposes to study, quite special. The importance of studying double Higgs-strahlung becomes evident when studying the effect of deviations of the self-coupling from the value predicted by the SM. Figure 10.3 shows that the cross-section of the different di-Higgs production mechanisms shows a non-trivial dependence on λ (here normalised to its SM value). This is due to the fact that several Feynman diagrams contribute to di-Higgs production, and only some of them actually contain the triple-Higgs vertex.

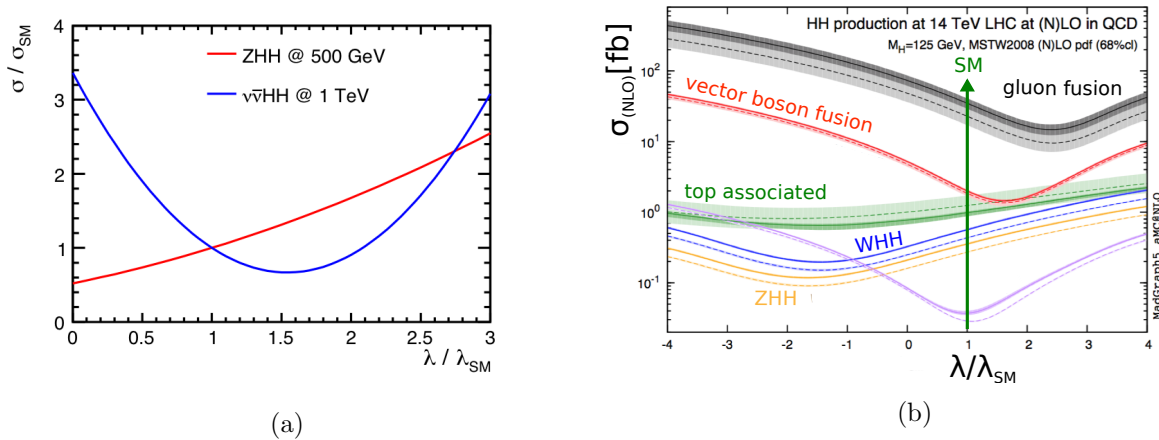

Figure 10.3: (a) Cross-sections for double Higgs production via Higgs-strahlung (at $\sqrt{s} = 500$ GeV) and WW fusion (at 1 TeV) as a function of the triple-Higgs coupling (normalised to its SM value) [247]. (b) Analogous graphs for double-Higgs production modes at the LHC [248]. Fusion-type processes exhibit qualitatively the same behaviour in pp as in e^+e^- collisions, and the same similarity between pp and e^+e^- can be observed for the strahlungs-like processes. Note that at LHC, double-Higgs-strahlung is burried by many orders of magnitude below fusion-type processes.

10.2.3 Top Quark Yukawa Coupling

[corresponding editor: Marcel Vos (vos@ific.uv.es)]

Brief discussion of relevance, state of the art, and HL-LHC prospects

Potential of the ILC, direct vs. indirect

Optimization of the high-energy operating scenario

10.3 *W* Boson

[corresponding editor: Jenny List (jenny.list@desy.de)]

10.4 4-Fermion Processes

[corresponding editor: Taikan Suehara (suehara@phys.kyushu-u.ac.jp)]

10.5 New Particle Searches – TeV Scale

[corresponding editor: Mikael Berggren (mikael.berggren@desy.de)]

10.6 New Particle Searches – Dark Sector

[corresponding editor: Maxim Perelstein (m.perelstein@cornell.edu)]

Many extensions of the Standard Model contain fields that do not carry any SM gauge charges. Such fields are said to belong to the “dark sector”. From observational point of view, such singlet fields are motivated by the existence of dark matter, while from theoretical side, they appear frequently in models of gauge unification, string theory compactifications, *etc.* Dark sector fields may still have non-gauge couplings to the SM, allowing them to be produced and detected in collider experiments. The ILC will search for dark sector particles in two ways. First, experiments at the beam dump will provide sensitivity to such states in the mass range below a few GeV. This is discussed in section ... Second, experiments at the main IP will be able to directly search for particles with masses up to the kinematic threshold. This is the subject of this section.

The field content of the dark sector and the structure of its interactions with the SM are not strongly constrained by theoretical considerations or by data, and a large variety of viable models are possible. Focusing on *renormalizable* couplings between dark sector and SM fields provides a useful set of benchmark models to explore this physics scenario. Below, we outline the ILC potential to search for each of these benchmarks:

- **Dark Photon Portal:** If the dark sector contains an Abelian gauge group $U(1)_D$, its gauge field can couple to the SM via the “kinetic mixing” term $\mathcal{L} = \epsilon F_D^{\mu\nu} F_{Y\mu\nu}$, where F_Y and F_D are the $U(1)_D$ and the SM hypercharge field-strength tensors. The kinetic mixing induces a coupling of A' , the gauge boson of $U(1)_D$, to the SM. If $m(A') \ll M_Z$, it simply couples to the electromagnetic current, while a heavier A' acquires parity-violating couplings (the latter scenario is often described as a “dark Z”).

The dark photon can be produced at the ILC through $e^+e^- \rightarrow A' + \gamma$. Once produced, A' may decay to pairs of SM particles, or into other light dark sector states charged under $U(1)_D$. In the latter case, A' decay is invisible and it produces a missing energy/momentum signature in the ILC detector. The reach of the ILC in the case of visible dark photon decays is shown in **figure**. ILC can extend the LHC reach for dark Z masses above 200 GeV or so. Moreover, the ILC will be able to provide a precise determination of the dark Z couplings, including their chiral structure. This is illustrated in **figure**.

- **Higgs Portal:** If the dark sector contains a scalar field S , couplings $S|H|^2$ or $S^2|H|^2$ are possible.
- **Neutrino Portal:** A right-handed neutrino is the SM singlet, and as such may be considered to belong to the dark sector, coupled to the SM through the neutrino Yukawa coupling.

It is customary to add another benchmark to this list, which involves dimension-5 couplings but is very well motivated from theory:

- **Axion Portal:** A pseudo-scalar singlet a can be coupled to the SM via $aF\tilde{F}$, where F is the EM (or other gauge) field strength tensor. This coupling is allowed if a is a Nambu-Goldstone boson, such as the axion. While the original motivation comes from the “QCD axion” solution to the strong CP problem, phenomenological studies also consider a more general possibility of “Axion-Like Particle” (ALP), whose mass and couplings are not constrained by the QCD axion model.

Chapter 11

ILC Fixed-Target Program

[7 pages; corresponding editor: Stefania Gori (sgori@ucsc.edu)]

In addition to its central collider, the ILC accelerator can host a number of additional detectors, including detectors for fixed-target experiments and beam dump experiments and remote detectors observing collider events. These can provide the setting for a multi-faceted program. The main purpose of these experiments will be to search for dark sector particles interacting only feebly with the Standard Model, as motivated by many dark matter models, as well as by models addressing the baryon-anti baryon asymmetry problem, the strong CP problem, and the hierarchy problem. The intense and high-energy electron and positron beams that the ILC makes available also have uses in nuclear and hadron physics and in studies of strong-field QED. They can also provide resources for developing advanced electron and positron accelerators.

Dark sector particles could communicate with the SM in a number of ways, via a dark photon A'_μ interacting through the gauge portal $\epsilon A'_{\mu\nu} F^{\mu\nu}$, via a dark scalar interacting through the Higgs portal $\kappa |S|^2 |H|^2$, through a dark fermion interaction through the neutrino portal, $yNLH$, or through a pseudo-Goldstone boson interacting through the axion portal $(a\Lambda)F_{\mu\nu}\tilde{F}^{\mu\nu}$. We have already described ILC probes of these interactions in Chapter 8 and 10. But all of the portals can also be explored powerfully in the fixed-target program, using a variety of different experimental approaches.

In this chapter, we will present the variety of fixed-target and remote experiments that could be mounted at the ILC site and estimate their potential both for dark sector searches and for other issues.

11.1 ILC Facilities for Fixed-Target Experiments

A tour of the ILC design, with possible locations of fixed-target and remote detectors, was given by Kaoru Yokoya at the LCWS 2021 [<https://indico.cern.ch/event/995633/>]. A fully developed plan will be given in this section.

11.2 Beam-Dump Experiments

Dark sector particles could be produced from the interactions of either the e^- or the e^+ beam with the corresponding beam dump. These particles could be long-lived enough to decay back to SM particles after the beam dump. They could be probed by detectors located 50–100 m away from the beam dump and behind the muon shield, searching for visible decay products (e.g. signatures involving two or more leptons, or two or more photons). In this section, we will compare the discovery prospects of dark particles either at a e^- or at a e^+ ILC beam dump experiment.

Dark sector particles could also be produced from Higgs exotic decays. In fact, the combination of the very narrow width of the SM Higgs boson, and the facility of the Higgs to couple to New Physics makes Higgs exotic decays one of the best ways to test dark sector particles. If long-lived enough, the dark particle could be detected at a detector searching for decays of LLPs produced at the interaction point (IP) placed 50-200 m from the IP. In this section, we will discuss the corresponding discovery prospects and compare them to the detection prospects at other experiments, including the main ILC experiments.

11.3 Dedicated Secondary-Beam Experiments

It is feasible to extract the electron beam upstream of the IP at times outside of the collider program. This could provide, for example, an electron beam of more than double the energy and about 10^3 higher intensity compared to the SLAC experiments of the 1990's. There are many interesting applications for such a beam, which we will explore in this section and the next. At a lower intensity, this beam could also provide, a missing-momentum experiment a la LDMX. In this setup, the electron beam is passed through a thin target, which is surrounded on both sides by tracking material. The energy and momentum of individual beam particles are measured on both sides of the target, unveiling the possible production of an invisible dark particle.

11.4 Nuclear and Hadron Physics with Electron and Positron Beams

11.5 ILC as an Accelerator Test-Bed

[corresponding editor: Kaoru Yokoya (kaoru.yokoya@kek.jp)]

Chapter 12

Precision Tests of the Standard Model

[12 pages; corresponding editors: Junping Tian (tian@icepp.s.u-tokyo.ac.jp), Christophe Grojean (christophe.grojean@desy.de), Michael Peskin (mpeskin@slac.stanford.edu)]

12.1 Precision Standard Model Theory for ILC

[corresponding editor: Ayres Freitas (afreitas@pitt.edu)]

To achieve the goals described in sections 8 and 9, precise predictions for the Standard Model (SM) expectations of the relevant observables are needed. A detailed discussion of the required theory work for studies at $\sqrt{s} \approx 91$ GeV, 160 GeV and 250 GeV can be found in Ref. [249] and references therein. The necessary improvement can be split into three categories:

- Fixed-order calculations: For the Z -pole program, electroweak N³LO corrections as well as leading N⁴LO corrections for the effective Z -fermion vertices are needed. Here “leading” refers to corrections enhanced by powers of the top Yukawa coupling and/or QCD strong coupling. For the 250-GeV program and physics at the WW threshold, NNLO electroweak corrections for $2 \rightarrow 2$ scattering processes are mandatory. In addition, calculations of Higgs decay amplitudes must be completed to NNLO order, in particular, for the Higgs decay $H \rightarrow 4f$. Higher-order QCD corrections to $H \rightarrow gg$ and $H \rightarrow b\bar{b}$ are also needed.
- To study effects of detector acceptance and background subtraction, Monte-Carlo tools need to be created with the precision of the expected measurements. This requires an accurate treatment of multi-photon initial state radiation and awareness of beam polarization. Furthermore, the Monte-Carlo programs must be matched to the fixed-order calculations discussed in the previous bullet point. Beyond the leading order QCD and electroweak corrections must be merged in an appropriate way. For a more detailed discussion of QED effects, see Ref. [250].
- Theoretical predictions for the precision observables within the SM also require a range of SM parameters as inputs, most notably the top and bottom quark mass, $m_{t,b}$, the strong

coupling α_s , and the running electromagnetic coupling at the weak scale, $\alpha(M_Z)$. m_t can be measured with high precision at the ILC, but its extraction from the data required resummed higher-order QCD corrections computed in an effective field theory framework. More precise determinations of m_b , α_s and $\alpha(M_Z)$ may be possible with improved lattice QCD calculations.

Instead of running on the Z -pole, ILC can also produce high-precision measurements of Z -boson properties by using the radiative return method at $\sqrt{s} = 250$ GeV, as described in section 9.2. A detailed study of the theoretical needs for this program is still lacking. It will require the evaluation of multiple emissions of collinear initial state photons, see e.g. Ref. [251], as well as full SM corrections to the process $e^+e^- \rightarrow \gamma Z$. A closer look at the required theory calculations and tools within the Snowmass process would be highly desirable.

12.2 Frameworks for Effective Field Theory

(This section will discuss the theoretical issues for the interpretation of ILC measurements using Effective Field Theory. In the ILC literature, global fits are done using SMEFT with dimension-6 operators only. There are alternative frameworks. What model-dependence does this choice bring in? Can invisible and exotic Higgs decays be included in these global fits? These issues will be discussed in some detail at Snowmass, and we hope to incorporate insights from that discussion.)

12.3 Expectations from a Unified SMEFT Analysis

(This section will apply various SMEFT frameworks to the LHC+ILC data set, explain how the SMEFT coefficients are determined, and discuss the difference between these approaches.)

12.4 Expectations for CP-Violating Operators

(This section will include the inclusion of CP-violating operators within the context of SMEFT. What processes constrain the coefficients of these operators. How much redundancy is there in the ILC determinations?)

12.5 Expectations for Heavy-Quark Operators

(The list of dimension-6 SMEFT operators expands greatly when operators that specifically involve heavy-quark fields are included. This section will discuss the relation more standard form-factor descriptions of BSM corrections to top quark properties to a full SMEFT analysis. What experiments are required to resolve all of the ambiguities?)

Chapter 13

Big Physics Questions Addressed by ILC

[10 pages; corresponding editors: Nathaniel Craig (ncraig@physics.ucsb.edu), Mihoko Nojiri (mihoko.nojiri@kek.jp), Maxim Perelstein (m.perelstein@cornell.edu), Michael Peskin (mpeskin@slac.stanford.edu)]

The discovery of the 125 GeV Higgs boson poses even more questions that it answers. Within the SM, the Higgs boson explains the the origin of all particle masses through the Higgs mechanism. The 125 GeV boson seems to fulfill this role, but still there remain many questions both about this boson and about the SM itself. Is this boson solely responsible for the breaking of electroweak symmetry and the generation of mass? Is it a singleton, or is it merely the first of several Higgs bosons? What sets the mass parameter for this boson? Can we explain electroweak symmetry breaking in physical terms, with a theory in which that mass is computable? If the SM is correct up to very high scales and the its parameters are equal to the current central values, the vacuum we see is unstable. Is this the true situation, and, either way, what is the true behavior of the vacuum of the universe far in the future? In addition, the discovery of the Higgs boson sharpens questions that have been asked since the SM was first formulated. What is the origin of flavor and the fermion generations? Why is there more matter than antimatter? What is the nature of dark matter? What other types of new matter exist in nature?

Through its comprehensive set of precision measurements of the couplings of the 125 GeV Higgs boson, and through its larger program of measurements of electroweak reactions at the weak-interaction scale, the ILC has the power to give insight into all of these questions. In this chapter, we will outline these questions in more detail and describe their relation to ILC measurements. In the next chapter, we will illustrate the insights from the ILC in a complementary way, through quantitative comparison of the ILC projected measurements with the predictions of models of physics beyond the SM.

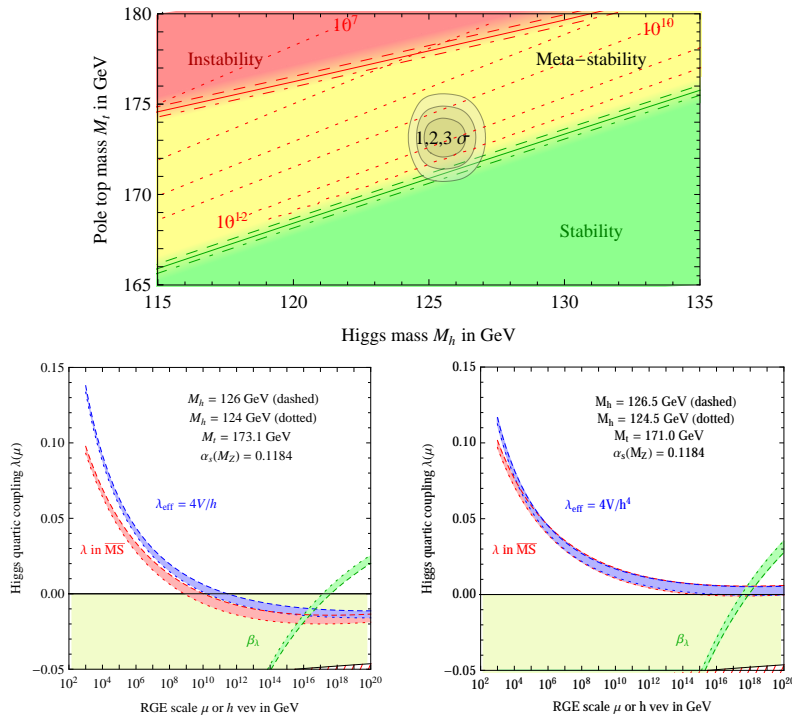

Figure 13.1: top: Regions of stability, metastability, and instability of the SM vacuum, shown as a function of m_H and m_t , showing the current best values in the region of metastability. bottom: Renormalization-group evolution of the Higgs quartic coupling to large Q assuming $m_t = 173.1$ GeV (left) and $m_t = 171.0$ GeV (right). From DeGrassi, *et al.* [252].

13.1 Can the Standard Model be exact to very high energies?

At TeV energies, the Higgs field quartic coupling increases with energy due to renormalization-group running. However, it is a prediction of the SM that this coupling turns over and begins to decrease at very high energies. For the current central values of SM parameters, the Higgs quartic coupling becomes negative at about 10^{11} GeV, leading to a vacuum instability, assuming that the SM is still exact at those energies. Within the SM, the outcome depends sensitively on the values of the Higgs boson mass and the top quark mass. We do not know today what the SM predicts for our universe.

Precision measurements of these two quantities to the accuracy projected for the ILC will resolve this. The nature of the SM vacuum state as a function of the top quarks and Higgs boson masses is shown in Fig. 13.1 [252]. As is shown in the bottom graphs in this figure, a change of 2 GeV in the central value of the top quark mass brings us from eventual instability to stability. Since the calculation uses the short-distance value of the top quark mass, the uncertainty must include the error in converting the top quark mass as measured in experiment (*e.g.*, the pole mass) to a short-distance value (*e.g.*, the \overline{MS} mass). Thus, this calculation, within the SM, requires very precisely understood inputs at the energy of the electroweak scale. We have seen above that the

ILC will determine the Higgs boson mass to a precision of 15 MeV and the short-distance top quark mass to a precision of 40 MeV, well within the requirements for a definitive statement.

If the future experiment proves the SM vacuum metastable, two possibilities arise. On the one hand, the SM could be exactly correct up to the scale of the instability. In that case, we will need to understand how the universe before the electroweak phase transition settled down to the metastable vacuum of today. Alternatively, new physics may arise below the energy scale of 10^{10} GeV, where the value of the four-point interaction of the Higgs boson becomes negative, and this could change the physics of the Higgs potential in such a way as to make the vacuum state stable. Such new physics may exist above the scale of 1 TeV or so, which is directly or indirectly explored in current particle experiments, but it may also occur at lower scales, since the nature of the Higgs boson remains largely unexplored.

Another intriguing possibility is that the Higgs boson and top quark masses are such that the balance point toward instability is moved just to Planck scale, as indicated in the right-hand graph in Fig. 13.1. In this case, it is possible to arrange that the Higgs field is the inflaton which is responsible for generating cosmic structure [253, 254].

We do not know whether the Standard Model is correct up to high energy scales. If we relax this assumption, there are relatively straightforward extensions of the Standard Model that can make the vacuum stable. For example, in a model where singlet scalar fields interact with the Higgs boson, the vacuum can be stable for some parameter regions of the model. It is even possible that such extension of the SM can accommodate dark matter by requiring Z_2 symmetry. The Higgs boson couplings can be different from the standard model ones, and such deviations may be detected by the precision measurement of the Higgs bosons. These models can contain additional first-order phase transitions. In this case, significant gravitational waves may be produced by a phase transition in the early universe and observed as a background in low-frequency gravitational wave observations.

It is also possible that the Higgs sector is stabilized by high symmetry. Such a symmetry would require many new particles to completely change the Higgs boson interaction and its high-energy behavior. An example of such a scenario is the supersymmetric model. In the supersymmetric model, all bosons have partner fermions and vice versa due to the symmetry of the theory. The model also relates Higgs four-point couplings to the fourth power of gauge couplings so that the scalar potential is bounded from below. The supersymmetric models have at least two Higgs doublets, namely, five Higgs bosons. In addition, the down-type quarks leptons can have large Yukawa coupling. The Higgs boson decay can receive significant corrections detectable by the Higgs factories if the masses of the additional Higgs bosons are around TeV. In addition to that, the predicted partners can be directly searched at linear collider or through the measurement of oblique corrections.

The other new physics possibility between the Planck scale to the weak scale is the change of space-time. In the warped extra-dimensional model, the Higgs boson can be the field in the IR brane. Yukawa coupling to the fermions is determined by the overlap of the fermion wave function in 5 dim to the Higgs boson on the brane. The effective field theory involving Higgs boson higher-order terms can express the physics picture, and the precision study of Higgs interaction can provide crucial information.

It is quite generally true that the high-precision measurement of Higgs boson and top quark masses can give profound insight into all of these possibilities. The measurement must be carried out with a high degree of confidence and control of experimental and theoretical systematic errors. That is possible uniquely at an e^+e^- collider such as the ILC.

13.2 Why is there more matter than antimatter?

The origin of matter is no less compelling a mystery than the origin of mass. Assuming inflationary cosmology, the universe began in a state with equal amounts of matter and antimatter. From this starting point, the abundance of matter over anti-matter can be explained starting from symmetric initial conditions if some epoch in the early universe satisfies the Sakharov conditions— B violation, C and CP violation, and loss of thermal equilibrium. These ingredients seem suggestively present in the quark sector of the SM itself, but, quantitatively, the asymmetry generated is too small by 10 orders of magnitude. The problem is that the quarks that are sensitive to the CP-violating CKM angles are very light compared to the Higgs vacuum expectation value. So it is possible to generate the observed baryon asymmetry in simple extensions of the Standard Model in which there are new particles and new sources of CP violation at or above the weak interaction scale. These models must also include a mechanism for taking the universe out of thermal equilibrium, such as a first-order phase transition or late-decaying particles. Models in which the out-of-equilibrium events take place at or below the TeV scale can be directly tested at the ILC. A prominent class of models is that in which the electroweak transition itself becomes first-order due to the coupling of the Higgs boson to other new particles. Another interesting class of model involves dark sector particles or heavy neutrinos that would be revealed at the ILC.

In the SM, the electroweak phase transition (EWPT) is predicted to be a second-order, or nearly so. A first-order phase transition, necessary for electroweak baryogenesis, requires a substantial modification of the SM Higgs potential at finite temperature. Generically, this is only possible if new particles with substantial couplings to the Higgs boson, and with masses below the TeV scale, are present. Such particles can be searched for directly at the LHC, and some possibilities (for example, top quark partners in supersymmetric models) are already strongly constrained. However, other options, such as new gauge-singlet scalar fields coupled to the Higgs, remain wide open. Precision Higgs measurements at the ILC will be sensitive to such scenarios. In particular, the $e^+e^- \rightarrow Zh$ cross section will be measured at the level sensitive to generic one-loop corrections to the Higgs propagator. This measurement will probe a wide range of first-order EWPT models, including those with a gauge-singlet scalar. Likewise, models with a first-order EWPT typically predict significant deviations in the Higgs cubic coupling, which can be discovered at the 500 GeV or 1 TeV ILC upgrade.

An illustrative scan of the parameter space of a model with a single real scalar mixing with the SM Higgs boson is shown in Fig. 13.2 [255]. The blue points represented models with a strongly first-order electroweak phase transition. In this class of models, the Higgs self-coupling is enhanced almost by a factor of 2, and the Higgs couplings to ZZ is has a relatively large correction (about 5%) compared to the SM prediction. With the precisions explained in previous sections, uncertainties of 23% on the Higgs self-coupling and 0.4% on the HZZ coupling after the 500 GeV stage, the ILC

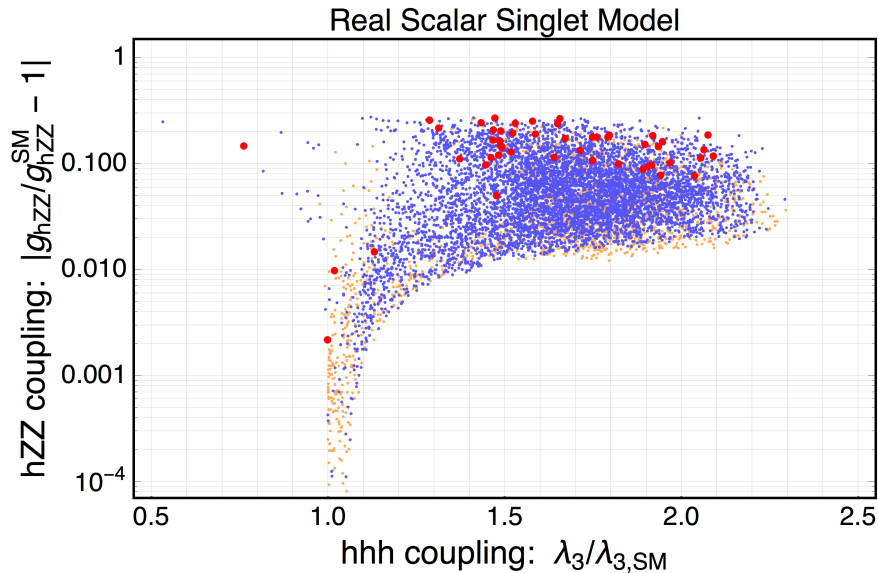

Figure 13.2: Scan of the parameter space for a model of baryogenesis at the electroweak scale with one new electroweak singlet Higgs field mixing with the SM Higgs doublet, from Huang, Long, and Wang [255]. Blue points represent models with a strong first-order electroweak phase transition, required for successful baryogenesis.

will be able to discover these effects with high confidence.

The exploration of models of electroweak baryogenesis will also include tests for CP violation in Higgs boson and top quark decays. There is an alternative class of baryogenesis models, called “leptogenesis”, in which the CP violation and the out-of-equilibrium dynamics occurs in the neutrino sector. This can also be tested at the ILC if the relevant heavy neutrinos are at the weak scale. We will discuss both these issues in the following chapter.

13.3 What is the dark matter of the universe?

Perhaps the most compelling evidence for physics beyond the Standard Model comes from the sky, with a host of concordant observations indicating that baryons comprise only a fraction of the matter in the universe. Although viable dark matter candidates span many decades in mass, the near-coincidence of dark matter and baryon abundances suggests a non-gravitational mechanism to connect the two. This singles out dark matter candidates at or below the weak scale that interact with the Standard Model through one of several possible portals. We have discussed in Chapters 8, 10, and 11 that these models often have special difficulties for the discovery of new particles at hadron colliders, difficulties that can be overcome at the ILC.

Famously, a particle with a mass in the GeV-TeV range, coupled to the SM via weak-scale interactions, naturally has the right relic density to explain the observed DM. Such Weakly-Interacting

Massive Particles (WIMPs) can be pair-produced at colliders. Once produced, WIMPs escape the detector, leading to a missing energy signature. The reach of the ILC to WIMPs in the model-independent γ +MET channel is shown in **figure**. The ILC is sensitive to the lepton (specifically, electron) coupling of the WIMP, making the ILC search complementary to those at hadron colliders and nuclear-recoil direct detection searches which are primarily sensitive to WIMP coupling to quarks and gluons.

At the ILC, WIMPs can also be produced in decays of other, heavier BSM particles. A well-studied example of this production mechanism occurs in supersymmetric models, where the lightest supersymmetric particle (LSP) can play the role of WIMP dark matter. In many models, the LSP is nearly degenerate in mass with other electroweak-ino states, while strongly-interacting superpartners are much heavier. Such models pose difficulties for searches at hadron colliders due to small cross sections and soft visible energy deposits. The democratic production and clean environment in the ILC collisions allow for efficient searches for this physics. **(Make connection to SUSY section)**

While WIMP paradigm is attractive, there are many alternative scenarios for microscopic origin of dark matter. The ILC will be able to shed light on many of these alternatives. For example, the DM may reside in a “dark sector”, a set of fields with no SM gauge interactions (but potentially rich structure of interactions among themselves). Such dark sectors are connected to the SM via a “portal” interaction. A simple and natural portal to DM can be provided by a dark photon, a new $U(1)$ gauge boson which couples both to the SM (via kinetic mixing with the SM $U(1)$ gauge group) and to the dark sector. The ILC will be able to search for the dark photon in two ways. First, it can be produced at the main interaction point, and detected either through its decays back to the SM or the missing-mass peak in the spectrum of the associated SM photon. **figure** Second, an additional detector placed 10-50 m downstream of the ILC beam dump can exploit the high current end energy of the ILC beams to extend the sensitivity to sub-GeV dark photons. **(Make connection to fixed-target section)**

Another natural candidate for a portal to the dark sector is the Higgs boson. Higgs decays into dark-sector states can provide a window into the dark sector. Such decays may result in an invisible Higgs decay signature, which can be accessed at the ILC with sensitivity a factor of 20 better than that expected at HL-LHC. Alternatively, some of the produced dark-sector states can decay back to SM particles, lead to exotic multi-particle final states in Higgs decays. For example, in models of asymmetric dark matter consisting of bound states of a confining gauge group (similar to QCD) in the dark sector, Higgs decays may produce events known as “dark showers”, characterized by multiple displaced vertices. Thanks to the large sample of Higgs bosons that will be collected and clean environment with low track multiplicity, the ILC offers unparalleled opportunities to search for such phenomena.

If a signature of the dark matter particle (or an associated mediator particle) is discovered, either at the ILC or in another experiment, the ILC can play a crucial role in determining the properties of this particle such as its mass and spin, as well as strength and structure of its couplings to the SM. Such measurements are often challenging at hadron colliders. In contrast, the ILC offers a precisely controlled initial state, including polarized beams that may help disentangle the chiral structure of the couplings. **(Some examples: figure)** In some models, the ILC may even provide

enough information to calculate the relic abundance of the discovered stable particle(s), and to test whether it is indeed responsible for the observed dark matter.

We will bring together all of the ILC approaches to the search for dark sector particles and summarize their sensitivity in the next chapter.

13.4 What is the energy scale of new physics?

The Higgs boson is an exquisitely sensitive barometer for new physics, with any deviation in its properties from the Standard Model prediction providing a smoking gun indication of new physics. If new physics enters at or above the weak scale, these deviations can be systematically captured in effective field theory extensions of the Standard Model that encode the energy scale of new physics. In this section we interpret the SMEFT projections of section 12 in terms of motivated scenarios for new physics, translating ILC precision into qualitative lessons about the nature of the Higgs boson, its potential, and its coupling to other Standard Model particles.

In the next chapter, we will describe the relation between the levels of precision that will be reached in the ILC experiments and the predictions of specific models of new physics. We will demonstrate that the ILC is robustly sensitive to the predictions of these models, and that the pattern of deviations of the Higgs couplings from the SM predictions gives insight into the nature of new physics responsible for those deviation. Here, we will discuss a higher-level issue: What does the high-precision study of the Higgs boson tell us in general about the scale of new physics? Can we use this information to make fundamental tests of the SMEFT framework and of the quantum field theory description of the Higgs boson more generally?

The scale of new physics: The observation of any deviation from Standard Model predictions would be an unambiguous indicator of new physics. As we have discussed in the previous chapter, this can then be interpreted within the SMEFT framework, in terms of nonzero Wilson coefficients c_i/Λ^2 for a set of irrelevant operators. If such deviations can be well-described by dimension-6 operators in SMEFT, their size would allow us to infer the ratio of the couplings and masses of new physics. At the ILC, the anticipated sensitivity to Wilson coefficients of dimension-6 operators ranges from the few percent to per-mil level, depending on both the nature and number of operators in question. If new particles interact with the Standard Model at tree level with generic $\mathcal{O}(1)$ couplings, this could provide indirect evidence for particles as heavy as tens of TeV. If new particles instead interact only at loop level, the ILC remains sensitive to new particles between the weak scale and the TeV scale. Such particles need not carry Standard Model quantum numbers, in which case they would have remained undetected at the LHC.

Constraints on Wilson coefficients coming from null results at the ILC would provide strong evidence for a mass gap between the weak scale and the TeV scale, though the strength of the inferred bounds varies from model to model. It should be noted that constraints on dimension-6 operators do not generally provide an unambiguous exclusion of new physics, since contributions from different UV degrees of freedom to a given Wilson coefficient may partially or wholly cancel. As we will discuss shortly, constraints on dimension-8 operators can provide an unambiguous exclusion

of new physics up to the corresponding scale due to positivity bounds that forbid cancellations among different UV contributions.

The “size” of the Higgs: A key higher-dimension SMEFT operator of broad significance is

$$\mathcal{O}_H = \frac{1}{2\Lambda^2} (\partial_\mu |H|^2)^2, \quad (13.1)$$

the leading nontrivial form factor for the Higgs field. The scale Λ associated with \mathcal{O}_H encodes the effective “size” of the Higgs boson, which may arise due to quantum corrections from new particles or compositeness of the Higgs itself. The leading effect of \mathcal{O}_H on Higgs properties is to generate a universal shift in Higgs couplings relative to their Standard Model values. This shift necessarily drops out of ratios of branching ratios typically measured at hadron colliders. We can be sensitive to this parameter only if we can measure the Higgs partial width in absolute terms. Thus, the direct measurement of the Zh cross section at the ILC using the recoil Z boson as a tag allows the first unambiguous probe of \mathcal{O}_H .

Among other things, bounds on (or measurement of) \mathcal{O}_H quantify the extent to which the observed Higgs boson is an elementary or composite scalar. A sharp target is provided by the ratio of the Higgs’ size to its Compton wavelength. This ratio is of order unity for fully composite scalars, while smaller values correspond to increasingly elementary scalars. To date the neutral pion is the most elementary-seeming (pseudo)scalar yet observed in nature, with a ratio of size to Compton wavelength on the order of $\sim 1/6$. LHC measurements of Higgs properties do not yet probe pion-like levels of compositeness, and retain some degree of model-dependence. At the ILC, observation of \mathcal{O}_H would provide compelling evidence for the compositeness of the Higgs, while sufficiently stringent bounds would ultimately indicate that the Higgs is the most elementary scalar observed to date.

The Higgs self-coupling: A second key operator at dimension 6 is $\mathcal{O}_6 = \frac{1}{\Lambda^2} |H|^6$, which gives the leading correction to the Higgs self-coupling in the SMEFT framework. The anticipated precision of the ILC’s constraint on \mathcal{O}_6 is sufficient to unambiguously establish the non-zero self-interaction of the Higgs boson. This would, in turn, be the first observation of a self-interacting particle whose interaction preserves all of its internal quantum numbers. Conversely, if the ILC measures a nonzero value of \mathcal{O}_6 , this would immediately indicate new physics below the TeV scale.

Positivity tests of analyticity and unitarity: In local, unitary quantum field theories, the basic assumption of relativistic causality implies that amplitudes are analytic functions of their kinematic variables. This analyticity in turn implies positivity bounds in the space of SMEFT couplings [256]. On one hand, these may be viewed as theoretical constraints that sharpen the interpretation of experimental results by narrowing the space of allowed couplings and precluding cancellations between different UV contributions. On the other hand, they may be viewed as an opportunity for direct experimental tests of the axiomatic principles of quantum field theory such as analyticity, unitarity, and locality [257]. Experimental probes of positivity bounds are challenging because the vast majority apply to operators at dimension eight and higher on account of the

energy growth required to impose UV-insensitive bounds. The effects of dimension-8 operators are typically subleading to those of dimension-6 operators, which are generally not subject to generic positivity bounds.

Nonetheless, there are a number of observables for which dimension-8 operators provide the leading contributions, enabling tests of positivity bounds at colliders. At the LHC, diboson production allows for sharp tests of positivity bounds on anomalous quartic gauge couplings [258, 259]. But the ILC is particularly well-positioned to test positivity bounds on account of its clean environment and the ability to make measurements at multiple well-defined center-of-mass energies, which can be used to disentangle contributions from operators with different scaling dimensions. Two particularly promising channels for testing positivity bounds at the ILC include $e^+e^- \rightarrow e^+e^-$ scattering [260] and $e^+e^- \rightarrow \gamma\gamma$ [261]. In both cases, ILC sensitivity to dimension-8 operators is sufficient to give unambiguous tests of positivity bounds, even in the presence of dimension-6 operators. In e^+e^- annihilation to vector bosons, the assumption that deviations from the SM arise from dimension-6 operators leads to specific predictions, such as relations between the γWW and ZWW trilinear couplings and the absence of corrections to $e^+e^- \rightarrow ZZ$, that can be tested with detailed measurements of the differential cross sections. Deviations from these predictions must be attributed to dimension-8 contributions. Through these analyses, the ILC can probe bedrock principles of quantum field theory, and, in the event of null results, can unambiguously exclude new physics in the relevant channels.

The linear realization of electroweak symmetry: Although the $SU(2)_L \times U(1)_Y$ -symmetric Standard Model EFT (SMEFT) is currently the preferred effective field theory extension of the Standard Model, it is not the only possibility. As we have already described, it is an assumption in SMEFT that any additional sources of electroweak symmetry breaking beyond the observed Higgs boson are associated with large mass scales that can be cleanly integrated out. If there are additional sources of electroweak symmetry breaking below 1 TeV or if there are heavy particles that still acquire most of their mass from the Higgs field, this would require using a different, more inclusive effective field theory. A logical candidate is the $U(1)_{\text{em}}$ -symmetric Higgs EFT (HEFT) [262], in which the Higgs field belongs to a nonlinear realization of weak-interaction $SU(2)$. At present, it is possible for either SMEFT or HEFT to describe deviations from the Standard Model, leaving unresolved whether electroweak symmetry is linearly or non-linearly realized by the known fundamental particles. This question is unlikely to be answered decisively at the LHC, leaving a compelling open question for the ILC.

If precision measurements of Higgs couplings at the ILC are not well-fit by SMEFT operators at dimension 6, HEFT may provide the more appropriate description. This would suggest that electroweak symmetry is not linearly realized by the particles of the Standard Model and signal the presence of non-decoupling new physics between the weak scale and a few TeV. On the other hand, consistency of ILC precision measurements with Standard Model predictions—and, in particular, verification of the Higgs coupling constant relations predicted by SMEFT—would significantly narrow the types of UV physics associated with HEFT. Future energy upgrades of the ILC could decisively determine whether electroweak symmetry is linearly realized by the known fundamental particles by probing scattering processes at the \sim few TeV scale.

13.5 Why is electroweak symmetry broken?

Behind all of these questions, there is another very important one. All of the questions that we have discussed in this section eventually point back to mysteries about the Higgs boson.

The structure of the SM is such that the interactions of gauge bosons and fermions are specified completely by their quantum numbers and the values of the $SU(3) \times SU(2) \times U(1)$ gauge couplings. These couplings are dimensionless. For energies above a few GeV, all three of these couplings are weak. This part of the SM is easy to understand and has been tested in great detail through precision electroweak measurements and measurements of quark and gluon reactions at the LHC.

Any property of the SM that goes beyond this—including the basic mass scale of the model, the mass spectrum of quarks and leptons, and the origin of CP violation—necessarily involves the Higgs boson. The explanation that the SM gives for these aspects comes in the form of renormalizable parameters, the Higgs field mass and quartic terms and the Higgs-fermion Yukawa couplings. These are adjustable inputs to the quantum field theory. These input parameters are subject to some general phenomenological constraints, but attempt to compute these parameters from first principles have always led to paradoxes (such as the Gauge Hierarchy Problem). This is why the SM is often described as an effective theory that represents a more fundamental theory at higher energies. We are now at the point where we need to know how that more fundamental theory is constructed.

A basic physics question that we can ask about that more fundamental theory is, why is the $SU(2) \times U(1)$ symmetry of SM spontaneously broken? Like the values of the fermion masses, spontaneous symmetry breaking is an input to the SM. It comes in the assignment of a negative value to the Higgs field mass parameter μ^2 . This value cannot be determined from first principles. The connection between the physical and the “bare” value of μ^2 is not well-defined and these quantities can easily have different signs. This is a symptom of the fact that the SM is only a phenomenological theory. It cannot answer the why questions, not this one, not any of the others that we have listed above.

This situation stands in sharp contrast to our knowledge about spontaneous symmetry breaking acquired from the study of superconductivity, magnetism, and other condensed matter phenomena, pairing in nuclear physics, and even chiral symmetry breaking in low-energy QCD. In each case, there is a fascinating story that explains the why of the broken symmetry state. Some theorists are dismissive of similar explanations in “fundamental” physics. We disagree. It is true that any explanation of EWSB requires new physics beyond the SM. But, to us, this means that there is an opportunity to discover new fundamental forces now unknown. We ought to be grasping for it.

Models that explain the phenomenon of electroweak symmetry breaking (EWSB), require structure beyond the SM, but this can come in one of many forms. The theoretical literature contains a large number of different types of models that address this question. It is useful to divide these models roughly into categories. New theoretical ideas can give rise to new categories, but always with the imperative to explain the mass parameter of EWSB, the Higgs field vacuum expectation value $v = 246$ GeV. In the following, we will refer to physics at the “TeV scale”, with new particles of mass from 100 GeV to a few TeV, the “10 TeV scale”, with new particles in the range 5–50 TeV,

and a “very high scale”, with new particles above 10^9 GeV and possibly up to the Planck scale.

Here is a sampling of models found in the literature:

- **Models with a fundamental scalar field at the TeV scale:** Here the Higgs field is a fundamental field. To avoid the conceptual problems of the SM and to allow the Higgs potential to be computable, this the Higgs field must be supplemented by additional fields providing add structure. An example is the Minimal Supersymmetric Standard Model. Here, the Higgs potential can be computed in terms of the masses and couplings of supersymmetric particles, which in principle can be measured independently by experiments. The negative value of μ^2 can be generated by a loop diagram involving \tilde{t}_L, \tilde{t}_R , and the Higgs field Φ_u , and this mechanism is testable after observation of these particles.
- **Models with a scalar field composite at the TeV scale:** Here EWSB is due to new strong interactions at the TeV scale, as in the original Technicolor models. These models do not include a light Higgs boson doublet, but they may include a Higgs “imposter”, for example, a light scalar dilaton. These models are allowed by the current LHC data only with considerable tuning [263] (recently updated to 2021 in v3).
- **Models with a scalar field composite at the 10 TeV scale:** Here EWSB is due to new strong interactions at a higher scale, with the Higgs field mass term protected by symmetry. For example, the Higgs doublet field can appear as a set of Goldstone bosons of the strong interaction theory. Little Higgs models are examples of models of this type. In these models, additional new TeV-scale particles such as vectorlike top quark partners are needed to build computable models of EWSB. These partners can be evade LHC constraints by being heavier than the limits or by being color-singlet, a class of models called “neutral naturalness”.
- **Models with extra dimensions:** In such models, the Higgs doublet field can arise as the 5th component of a 5- or higher-dimensional gauge field. Randall-Sundrum models fall into this class. The higher-dimensional field excitations (“Kaluza-Klein excitations”) play an essential role in the computation of the Higgs potential and EWSB.
- **Models with fundamental scalar fields from very high scales:** Here the Higgs doublet is a fundamental scalar field arising at very high energy scales. For example, in the Relaxion model, the Higgs potential evolves on cosmological time scales along with the early expansion of the universe. Another example is Nnaturalness, in which the fundamental theory at the Planck scale contains a large number N of copies of the Higgs doublet with random μ^2 values, of which one has a mass at the TeV scale [187]. In these models, the presence of the fundamental scalar field is given and the mechanism only serves to solve the Gauge Hierarchy Problem. Often, extreme parameter values are needed. For example, in Nnaturalness, one requires $N \sim 10^{60}$.

The type of model dictates whether the model has the power to solve other questions about the SM such as the values of the fermion masses. In supersymmetry, these values are set by the values of Yukawa couplings at the scale of Grand Unification. In models in which the Higgs field is a Goldstone boson or an extra-dimensional vector field component, there is a possibility that the fermion Yukawa couplings can be generated dynamically at the TeV or 10 TeV mass scale.

Though some of these models, especially those of the last class, can be very difficult to test with colliders, all of the classes contain models with new particles at the TeV scale, plausibly within the reach or just beyond the reach of the LHC. These particles can also give tree-level or radiative corrections to the properties of the Higgs boson at the 5% level that can be discovered in a program of precision Higgs measurements. The very different physics origins of EWSB in these classes of models implies that the predictions for new particles and anomalous Higgs coupling are very different from one class of models to another. This gives the possibility that both direct and indirect effects of new particles can distinguish the classes and set us on the road to understanding correctly the origin of EWSB

In the next chapter, we will see how all of the issues described in this chapter can be addressed by measurements that the ILC will make possible.

Chapter 14

ILC Probes of the Big Questions

[8 pages; corresponding editors: Nathaniel Craig (ncraig@physics.ucsb.edu), Mihoko Nojiri (mihoko.nojiri@kek.jp), Maxim Perelstein (m.perelstein@cornell.edu), Michael Peskin (mpeskin@slac.stanford.edu)]

In this chapter, we will bring together the ILC capabilities for measurements and new particle searches discussed in Chapters 8–12 and the predictions of various models of new physics. This will allow us to discuss quantitatively the power of the ILC to access these models and address the issues they raise.

14.1 ILC and dark matter

In this section, we will review the probes available at ILC into the dark sector, including direct searches at the ILC CM energies, searches for exotic Higgs decays, and searches using the ILC beam dump and fixed target facilities.

14.2 ILC and supersymmetry

In this section, we will review the probes available at the ILC to investigate the predictions of models of supersymmetry, including direct searches and deviations in Higgs boson couplings. We will give attention to the parameter regions suggested by the possibility of light Higgsino missed by LHC and the parameter regions suggested by the muon ($g - 2$) deviation.

14.3 ILC and composite Higgs fields

In this section, we will review ILC probes for models with composite Higgs boson or extra dimensions, emphasizing especially the ability of precision top quark measurements to access this physics.

14.4 ILC and CP violation

In this section, we will review the various probes of new CP violation mechanisms available at the ILC, including measurements of Higgs decays, $e^+e^- \rightarrow W^+W^-$, and top quark production and decay.

14.5 ILC and flavor

In this section, we will review the ability of ILC to measure the Higgs Yukawa couplings of the second generation of quarks and leptons and the implications of those measurements for models.

14.6 The Higgs Inverse Problem

In this section, we will discuss the relation of deviations from the SM Higgs coupling predictions to the space of possible underlying new physics models. Can we infer the model from the pattern of deviations?

Chapter 15

Long-Term Future of the ILC Laboratory

[general corresponding editor: Michael Peskin (mpeskin@slac.stanford.edu)]

15.1 Future Accelerators in the ILC Tunnel

15.1.1 Very High Gradient Superconducting RF

[5 pages; corresponding editor: Hasan Padamsee (hsp3@cornell.edu)]

In this section we consider ILC upgrade paths beyond 1 TeV using Superconducting RF cavities with improved performance. We will discuss extensions in energy (1) to 2 TeV and (2) to 3 TeV, depending on the needs of high energy physics. When costs are estimated, these are quoted in ILC currency units, 1 ILCU = \$ 1 US using 2012 prices (see Sec. 4.1.5).

1. From 1 TeV to 2 TeV, the design will be based on:
 - (a) Gradient advances of Nb cavities to 55 MV/m anticipated from on-going SRF R&D on Nb structures discussed in Sec. 4.3.
 - (b) Radically new travelling wave (TW) superconducting structures [116, 117, 118] optimized for effective gradients of 70+ MV/m, along with a 100% increase in R/Q (discussed in more detail in Sec. 4.3.). The large gain in R/Q has a major beneficial impact on the refrigerator heat load, the RF power, and the AC operating power.
2. From 1 TeV to 3 TeV based on
 - (a) Radically new travelling wave (TW) superconducting structures [116, 117, 118] optimized for effective gradients of 70+ MV/m, along with 100% increase in R/Q . The large gain in R/Q has a major beneficial impact on heat load, RF power, and the AC operating power.

- (b) 80 MV/m gradient potential for Nb₃Sn [120] with a Q of 1×10^{10} , based on extrapolations from high power pulsed measurements on single cell Nb₃Sn cavities. Further, the operating temperature is 4.2 K instead of 2 K.

All paths will require intense SRF R&D to realize the very high gradient and high Q performance. But there are several decades of R&D ahead to accomplish those goals before the time for a 2 TeV or 3 TeV upgrade is indicated by physics. We are optimistic that the Snowmass process will stimulate funding for these avenues for high energies.

Path 1a (for 2 TeV) requires the development of multi-cell structures of advanced shapes, for example the Low-Loss shape, and the translation of the best 1-cell results today to full-scale structures. Path 1b for 2 TeV and path 2a for 3 TeV require development of radically new Nb Travelling Wave (TW) structures with performance comparable to the best 1-cell Nb cavities of today. No new material development is required for paths 1a and b, or path 2a. Path 2b for 3 TeV require major improvement of Nb₃Sn performance for TESLA-like structures from 23 MV/m for the best 1-cells today to 80 MV/m in the future at a Q of 1×10^{10} , but operating at 4.2 K.

AC Power Demands for 2 TeV and 3 TeV

ILC Energy upgrades beyond 1 TeV (except path 2b) require 300–400 MW AC power for operation, which reflects the major advantage of the SRF technology. We can expect further reductions in AC power from on-going developments under the Green-ILC program [264] paramount in importance. Efforts under this umbrella are preparing to explore multiple paths to make ILC and its upgrades environmentally sustainable. Wind power is one avenue following the example of ESS in Sweden [265]. A 30–40 unit wind turbine farm is capable of providing 100 MW at a cost of 150 MEuro. Combined heat and power production using bioenergy or solar photovoltaic cells integrated in the buildings are other examples. New ways of recycling low heat water (below 50°C) would also enable agricultural use of recycled heat, such as greenhouse heating.

Anticipated Cost Reductions

The 1 TeV upgrade discussion in the TDR does not apply any learning curve cost reduction to cavity, cryomodule or klystrons. Between the baseline ILC at 0.25 TeV and the upgrade options to 2 TeV and 3 TeV the total number of cavities increases by a factor of 5 from 8000 to about 40,000, and the total number of klystrons increases by a factor of 5.6 from 250 to 1500. Accordingly, we apply a 25% cost reduction for cavities and klystrons for 2.5 doublings, using the 90% learning curve in the TDR. We further assume that due to RF power developments, the efficiency of klystrons will improve from 65% (TDR) to 85%. Taking into account modulator and distribution efficiencies of 90% each, we use 65% efficiency for newly installed RF systems for 1 TeV, 2 TeV and 3 TeV upgrades but continue to use 50% efficiency for RF systems installed for the first 0.5 TeV. We expect further cost reductions from several areas of R&D already started. Among the areas under exploration are niobium material cost reduction (25%) for sheet production directly from ingots (large grains), and/or from seamless cavity manufacturing from tubes with hydroforming or spinning to reduce

the number of electron beam welds and weld preparations (15 - 20%). Based on the above ideas, we use an overall cost reduction of 50% in the cost of large productions of SW cavities. After including these reductions, we expect the cost of TW cavities will be 30% higher, leading to 15% increase in the cost of CM for TW structures.

Cost-reducing features for cryomodules [115] are to connect cryomodules in continuous, long strings similar to cryostats for long strings of superconducting magnets, saving the cost for the expensive ends. The elimination of the external cryogenic transfer line by placing all cryogenic supply and return services in the cryomodule also reduce costs, not only directly for the cryogenic components, but also by reducing tunnel space required. We estimate that by this method the filling factor from cavities to “linac tunnel length” will improve from 0.7 to 0.75.

Path 1a: 2 TeV Upgrade with 55 MV/m Nb

Scenario B of the ILC TDR [3] assumes a gradient/ Q of 45 MV/m/ 2×10^{10} for the upgrade from 500 GeV to 1 TeV. Recall that the gradient/ Q for the first 500 GeV is 31.5 MV/m/ 1×10^{10} . We expect that R&D in SRF technology will continue in parallel to both construction and operation of the earlier ILC stages to reach 45 MV/m/ 2×10^{10} .

For the 2 TeV upgrade Option 1a we consider advances in SRF performance (as discussed in Sec. 4.3) to gradients/ Q of 55 MV/m/ 2×10^{10} based on the best new treatments applied to advanced shape structures such as the Re-entrant, Low-Loss, or Low-Surface-Field (LSF) candidates for which gradients of 52–59 MV/m have already been demonstrated with 1-cell cavities using the standard ILC recipe. New recipes under exploration over the last 5 years should give even higher gradients. The new shapes were developed to reduce H_{pk}/E_{acc} 15–20% below that of the TESLA shape. In addition, the R/Q for the advanced shapes is about 20% higher to help reduce the RF power, dynamic heat load and AC power.

Today the best result for a 1-cell cavity of standard TESLA shape given the best new treatment is 49 MV/m, confirmed by retesting at many labs, and by about 50 tests on many 1-cell cavities. Therefore, applying the best new treatments to the advanced shapes we can optimistically expect gradients from 56–59 MV/m with successful R&D.

The strategy adopted for path 1a is to replace the lowest gradient (31.5 MV/m) 0.5 TeV section of cavities/cryomodules, re-using the tunnel, RF and Refrigeration of this section, keep the 0.5 TeV section with 45 MV/m gradient (11,000 cavities), running with the slightly lower bunch charge (Table 15.2), and add 1.5 TeV with 55 MV/m and $Q = 2 \times 10^{10}$. With this approach it is possible to keep the total linac length to 52 km well below the currently expected 65 km site limit. Note: If we just add the full one TeV (24 km) to the existing 1 TeV (38km), the total linac length comes too close to 65 km.

Table 15.1 shows high level parameters for the 2 TeV upgrade as compared to 1 TeV in the ILC TDR. The luminosity is 7.9×10^{34} which is higher than the 3.75×10^{34} for CLIC 1.5 TeV [266]. Table 15.2 gives more detail parameters for beam and accelerator. The number of particles per bunch is slightly lower than for the 1 TeV case, but the number of bunches and rep rate are the same. The peak beam current is therefore slightly lower. The total beam power for two beams

increases from 27 MW to 47 MW. Other beam parameters are adjusted so that the spot size at collision is reduced to 1.6 nm (from 2.7 nm).

As shown in Table 15.2, the total number of new cavities at 55 MV/m required for 1.5 TeV is 27,000, spanning a linac length of 36 km, of which 22 km can be installed into the empty tunnel (from the removed 0.5 TeV), leaving 14 km of new tunnel to be installed. Adding in the length (16 km) of the 0.5 TeV section remaining with 45 MV/m cavities, the total linac length will be 52 km, below the expected site limit of 65 km. There are savings from cryomodule parts if the tear down and replacement are staged so that some of the removed cryomodule parts are re-used. From 1600 CM removed from the 0.5 TeV section, we estimate the parts savings to be in the range of 0.5 B provided the removal and production of CMs are properly staged. For the new 1.5 TeV section, the cavity loaded Q is 6.7×10^6 , the input power per cavity will be 365 kW, with RF pulse length 2.0 ms, similar to the RF pulse length for 1 TeV. The total number of klystrons required is 1150 of which 360 klystrons are re-used from the 0.5 TeV removed section, and 65 klystrons are available from the 0.5 TeV remaining section (which operates with the new, lower bunch charge), leaving 725 new klystrons to be added. We use 65% efficiency for RF systems installed for 1 TeV and above, and 50% efficiency for the RF system installed for the first 0.5 TeV, to give an average efficiency of 60%. The total 2 K refrigeration required will be 66 kW, of which 33 kW is re-used, leaving 33 kW new refrigeration to be installed. We assume a cryoload safety factor and RF power overhead of 20% each for the new installations. The damping ring and positron source will be same as for 1 TeV, due to the same number of bunches, but the beam dump cost will increase. Summing all the cost components outlined, the additional cost for the 2 TeV upgrade will be 6.0 B. The AC power to operate 2 TeV will be 345 MW, making ILC with SRF attractive for 2 TeV.

Path 1b: 2 TeV Upgrade from 1 TeV with 70 MV/m TW Nb structures

As discussed in Sec. 4.3, TW structures offer several advantages compared to standing wave (SW) structures: substantially lower peak magnetic (H_{pk}/E_{acc}) and lower peak electric field (E_{pk}/E_{acc}) ratios, together with substantially higher R/Q (for lower cryogenic losses, lower RF power and lower AC power). Instead of using the TESLA shape for the cells, the Low-Loss type shape further reduces the peak surface magnetic field. In addition, it becomes possible to lower the cavity aperture (from 70 mm to 50 mm) without incurring the penalty of higher wakefields since the beam bunch charge for the 2 TeV upgrade is lower than the bunch charge for 0.5 and 1 TeV stages (Table 15.1), while the luminosity for 2 TeV is still 2 times greater than for CLIC 1.5 TeV. By combining these steps, it becomes possible to obtain an overall 48% reduction in H_{pk}/E_{acc} and factor of 2 gain in R/Q over the TESLA standing wave structure. Sec. 4.3 discusses the challenges to develop the TW structures. The TW cavity development effort has started. We expect the cost of TW SRF cavities will be 30% higher, leading to 15% increase in the cost of CM for TW structures.

The first strategy adopted in this option is again to remove the lowest gradient (31.5 MV/m) 0.5 TeV section, re-use the tunnel, RF and Refrigeration of this section, keep the 0.5 TeV section (11,000 cavities) with 45 MV/m gradient (running with the slightly lower bunch charge for 2 TeV), and add 1.5 TeV with TW SRF cavities at 70 MV/m/ $Q = 2 \times 10^{10}$ and R/Q 2 times higher than SW Nb cavities. With this approach it is possible to keep the total linac length to 44 km, well

		ILC 1 TeV	ILC 2 TeV	ILC 2 TeV	ILC 3 TeV	ILC 3 TeV	CLIC 3 TeV
	units	TDR	path 1a	path 1b	path 2a	path 2b	[266]
Energy	TeV	1	2	2	3	3	3
Luminosity	10^{34}	4.9	7.9	7.9	6.1	6.1	5.9
AC Power	MW	< 300	345	315	400	525	590
Cap. Cost	B ILCU	+ 5.5	+6.0	+4.9	+11.8	+11.0	
(total)		13.3	19.3	18.2	25.1	24.3	24.2 BCHF
Gradient	MV/m	45	55	70	70	80	72 / 100
(new linac)							
Q new linac	10^{10}	2	2	2	2	2 (4.2 K)	
CM unit cost	M ILCU	1.85	1.15	1.32	1.32	1.15	

Table 15.1: High level parameters for ILC energy upgrades. Costs (given in ILC currency units) do not include Detector and Manpower.

below the currently expected 65 km site limit.

As shown in Table 15.2, the total number of new TW cavities at 70 MV/m required is 21,000, spanning a linac length of 28 km, of which 22 km can be installed into the empty tunnel (from the removed 0.5 TeV), requiring 6 km of new tunnel to be installed. Adding in the length (16 km) of the 0.5 TeV section remaining, the total linac length will be 44 km, well below the expected site limit of 65 km. For 1600 CMs removed from the 0.5 TeV section, we estimate the savings in re-used parts to be in the range of 0.5B, provided the removal and production of CMs are properly staged. For the new 1.5 TeV section, the cavity loaded Q is 5×10^6 , the input power per cavity will be 460 kW, with RF pulse length 1.76 ms. The total number of klystrons required is 1180, of which 360 klystrons are re-used from the 0.5 TeV removed section, and 65 klystrons are available from the 0.5 TeV remaining section (because it operates with the lower bunch charge than for 1 TeV), leaving 755 new klystrons to be added. The average RF power efficiency of new RF systems will be 65% and the existing RF systems from the first 0.5 TeV installation will be 0.5, giving an overall RF efficiency of 61%. The total 2 K refrigeration required will be 37 kW, of which 33 kW is re-used, leaving 4 kW new refrigeration to be installed. We assume a cryoload safety factor and RF power overhead of 20% each for the new installations. The damping ring and positron source will be same as for 1 TeV, due to the same number of bunches, but the beam dump cost will increase. Summing all the cost components outlined, the additional cost for the 2 TeV upgrade will be 4.9 B. The AC power to operate 2 TeV will be 315 MW, making this path attractive for the improved environmental impact. Note the substantial benefit to the AC power due to the 2 times higher R/Q of the TW cavities. If we follow the alternative path of removing the entire 1 TeV linac, keeping the RF, tunnel and Refrigerator, to install a brand new linac using 70 MV/m TW cavities, we will need to populate the existing 38 km of tunnel with 28,000 TW cavities (no new tunnel needed), and use the existing Refrigeration (no new refrigeration needed), adding 755 klystrons. Savings from re-using CM parts from > 3000 CM from the 1 TeV section is estimated to be 1 B. The additional capital cost for this path will be 5.2 B, comparable to the path above, and the AC power will be 240 MW, less than the path above. The shorter tunnel and lower AC power may dominate the

		ILC 1 TeV	ILC 2 TeV	ILC 2 TeV	ILC 3 TeV	ILC 3 TeV	CLIC 3 TeV
	units	TDR	path 1a	path 1b	path 2a	path 2b	[266]
Energy	TeV	1	2	2	3	3	3
particles/bunch	10^{10}	1.74	1.5	1.5	0.65	0.65	0.37
bunches/train		2450	2450	2450	4900	4900	312
bunch spacing	nsec	366	366	366	250	150	0.5
pulse current	mA	7.6	6.6	6.6	4.16	4.16	3
rep. rate	Hz	4	4	4	4	4	50
RF pulse length (added linac)	ms	1.94	2.0	1.76	2.6	2.6	0.00024
Beam power (2 beams)	MW	27.2	47	47	61	61	28
ϵ_x/ϵ_y	10^{-8} m	500/3	500/2	500/2	500/2	500/2	66/2
β_x/β_y (m)	10^{-3} m	22/0.23	22/0.23	22/0.23	16/0.15	16/0.15	
σ_x/σ_y (m)	10^{-9} m	335/2.7	237/1.6	237/1.6	165/1.0	165/1.0	40/1
σ_z	10^{-3} m	0.225	0.225	0.225	0.1	0.1	0.044
Ψ (beamstr. parameter)		0.21	0.5	0.5	1/045	1.045	5
δ (RMS energy spread)	%	10.5	20	20	16	16	35
Luminosity	10^{34}	4.9	7.9	7.9	6.1	6.1	5.9
photons/electron		1.95	2.1	2.1	1.2	1.2	2.2
coherent pairs @ IP		0	2×10^4	2×10^4	7.9×10^5	7.9×10^5	6.8×10^8
incoh. pairs @ IP		383	49	49	5	5	3×10^5
No. of klystrons (new + existing)	10^3	460 + 320 = 820	820 + 460 = 1280	755 + 425 = 1180	690 + 820 = 1500	1680 + 820 = 2500	
No. of cavities (new + existing)	10^3	11 + 16 = 27	27 + 11 = 38	21 + 11 = 32	43 + 0 = 43	37.5 + 0 = 37.5	160 (0.25 m)
Q_L (new cavities)	10^6	5.6	8	5	8	10	
input power (new cavities)	kW	350	365	460	300	550	
linac length (new + existing)	km	16 + 22 = 38	14 + 38 = 52	6 + 38 = 44	19 + 38 = 57	12 + 38 = 50	42

Table 15.2: Detailed parameters for the proposed ILC energy upgrades compared with CLIC 3 TeV.

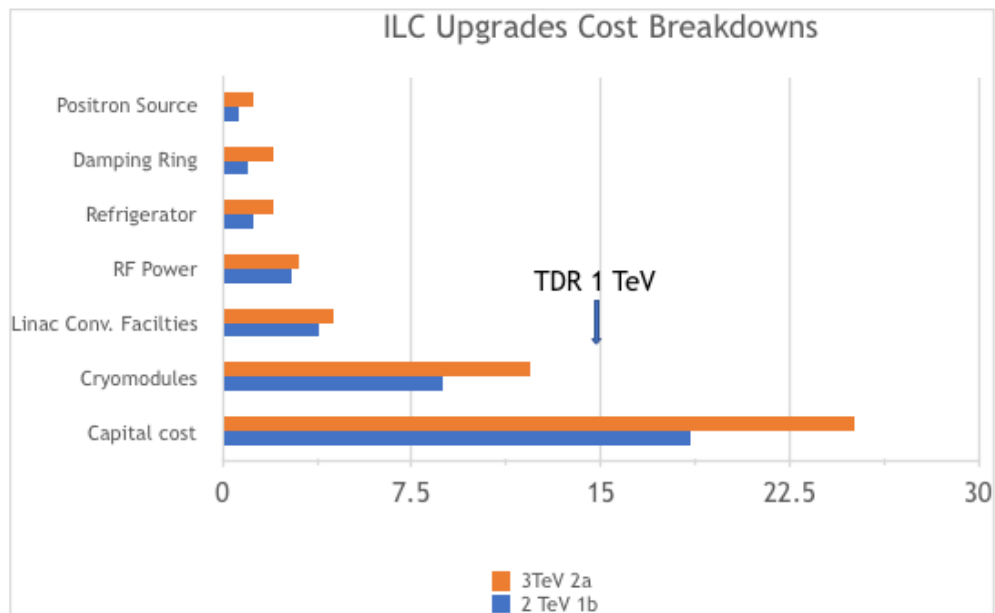

Figure 15.1: Cost breakdowns for some of the major systems for ILC 2 TeV (path 1b) and 3 TeV (path 2a) upgrades beyond 1 TeV. The bars show the TOTAL costs for (1 TeV +2 TeV) OR (1 TeV + 3 TeV). The added costs over 1 TeV are 4.9 B and 11.8 B. The ILC TDR estimates the capital cost for 0.5 TeV as 7.8 B and the added cost for upgrading from 500 GeV to 1000 GeV to be 5.5 B. All costs are given in ILC currency units ILCU, given by 1 ILCU = \$ 1 US using 2012 prices.

choice of this path.

Path 2a: 3 TeV Upgrade from 1 TeV with 70 MV/m TW Nb structures

The beam bunch charge for the 3 TeV upgrade is chosen to be 3 times lower than the bunch charge for 0.5 TeV stage to obtain a luminosity comparable to CLIC 3TeV [266]. The lower bunch charge helps with wakefields and with IP backgrounds. The number of bunches per RF pulse is doubled to 4900, and the bunch spacing is lowered due to the lower bunch charge (see Table 15.2).

The option adopted here is to remove ALL of the installed cryomodules for 1 TeV and replace them with new 70 MV/m TW cavities/cryomodules, plus add new linac sections to reach 3 TeV energy. We would re-use the existing RF and Refrigeration and CM parts from the removed 1 TeV section. As shown in Table 15.2, a total of 43,000 TW cavities will be required, so that with the (cavity to linac tunnel) filling factor of 0.75, the total length of the 3 TeV linac will be 57 km, under the expected site limit of 65 km. 38 km of tunnel would already be present from the 1 TeV removed, requiring 19 km of new linac tunnel. The total number of klystrons required will be 1500, of which 820 are available from the 1 TeV installation. The RF system cost will be higher due to the longer RF pulse length. Also, the existing 820 klystrons and RF system will have to be upgraded to provide longer RF pulses, which will incur a cost of about 0.4 B. The efficiency of the first RF system installed with 360 klystrons for 0.5 TeV is 50%, and for the later installed RF system for the next 0.5 TeV with 460 klystrons it is 65%. Hence the average RF system efficiency used is 61%. The input power per cavity will be 300 kW due to the high gradient. The loaded Q will be 8×10^6 . The total 2 K refrigeration requirement will be 95 kW of which 51 kW is already present, leaving a balance of 44 kW to be installed. Add in the cost of needed damping rings, positron source and beam dump for increasing the number of bunches from 2450 to 4900. The total additional capital cost for 3 TeV (from 1 TeV) will be 11.8 B, shown in Table 15.1 The total AC power to run 3 TeV will be 400 MW, with substantial benefit from the 100% higher R/Q of TW structures.

A lower cost alternative is to only replace the cavities/cryomodules in the first 0.5 TeV of the baseline stage which has relatively low performance (31.5 MV/m), as for the 2 TeV case above. The total number of new cavities installed will be 36,000, to require a tunnel length of 48 km plus 16 km of existing 0.5 TeV to make the total tunnel length of 64 km which is too close to the expected site limit. Therefore, this option is not preferred. Table 15.2 gives detailed parameters (for beam and accelerator) for ILC 3 TeV (Option 2a) with 70 MV/m TW structures as compared to CLIC 3 TeV. Note that the backgrounds at the IP for the ILC 3 TeV are much lower than for CLIC, and final beamstrahlung energy spread is 16% compared to 35% for CLIC. To reach the desired luminosity, the beam power is 61 MW with twice the number of bunches (4900) spaced closer together in the linac (250ns instead of 366 for 1 TeV) as allowed by the lower bunch charge. The peak beam current is 4.16 mA. The final vertical spot size is 1 nm, comparable to the CLIC case. Figure 15.1 shows the rough breakdowns for the costs of various systems: Cryomodules, RF, Refrigeration, Conventional Facilities, Damping Rings and Positron Sources for the two upgrade paths (1b and 2a) from 1 TeV (TDR) to 2 TeV and from 1 TeV to 3 TeV.

Path 2b: 3 TeV Upgrade with 80 MV/m Nb₃Sn structures at 4.2 K

Option 2b for 3 TeV is to consider 80 MV/m Standing Wave Nb₃Sn TESLA-like structures at 4.2 K with Q values of 1×10^{10} . In this case the challenge is to develop high performance Nb₃Sn. Due to the combined improvement of Carnot and technical efficiency at 4.2 K over 2 K, the ratio: AC power/cryo power improves from 730 to 230. We assume that the capital cost of 4.2 K refrigeration will be a factor 3 lower than for 2 K, and that the refrigerator units installed for 1 TeV are designed so that 1 watt of cooling at 2 K would be later equivalent to 3 watts of cooling at 4.2 K when the conversion is made for the 3 TeV upgrade at 4.2 K.

Our plan would be to install Nb₃Sn cavities for 3 TeV, removing all of the cryomodules for 1 TeV and replacing them with new 80 MV/m/ $Q = 1 \times 10^{10}$ cavities/cryomodules, plus install new linac sections to reach 3 TeV energy. We will re-use the RF, Refrigeration and CM parts of the removed 1 TeV section, converting the 2 K refrigeration to remove heat load at 4.2 K. A total of 37,500 Nb₃Sn cavities will be required, so that with the filling factor (cavity to tunnel length) of 0.75, and the total length of the 3 TeV linac will be 50 km, well under the expected Japan site constraint of 65 km. 38 km of tunnel has already been installed for 1 TeV, so that 12 km of new linac will be required. The total number of klystrons required will be 2500, of which 820 are available from the removed 1 TeV installation. The existing klystrons and RF system will have to be upgraded to provide longer RF pulses (2.6 ms), which will incur a cost of about 0.4 B. The number of new klystrons required is 1680. The average efficiency of old and new RF systems will be 63%. The input power per cavity will be 550 kW, at a loaded Q of 1×10^7 , so couplers will need to be improved. The total 4.2 K refrigeration required will be 352 kW of which 51 kW (at 2 K) is already present for 1 TeV, equivalent to 150 kW at 4.2 K. The balance of 200 kW at 4.2 K needs to be installed. Add in the cost of needed damping rings, positron source and beam dump for increasing the number of bunches from 2450 to 4900. The total additional capital cost for 3 TeV will be 11.0 B, as shown in Table 15.1. The total AC power to run 3 TeV will 525 MW.

An alternative path is to install 2.5 TeV with Nb₃Sn cavities, keep the 0.5 TeV upgrade section (at 45 MV/m) and remove the 0.5 TeV section (at 31.5 MV/m). In this case, the total length of the 3 TeV linac will be 58 km, much closer to the expected 65 km limit. The capital cost will be smaller, 10.5 B, and the AC power will be larger, 560 MW. Operating the remaining 0.5 TeV section with Q_L of 1.6×10^7 , and RF pulse length of 3.7 ms will be very challenging.

Incidentally, if the path considered is to install Nb₃Sn cavities for 2.5 TeV, leaving 16 km of the 0.5 TeV linac with 45 MV/m gradient in place, the total number of new cavities installed will be 31,000, to require a tunnel length of 41 km. Of this, 22 km is available and 19 km will be new tunnel. Therefore the total linac length will become $16 + 41 = 57$ km, quite close to the expected site limit of 65 km. Thus, this path not preferred—despite the 0.5 B cost savings due to fewer cavities.

15.1.2 Very High Gradient Copper Accelerators

[corresponding editor: Emilio Nanni (nanni@slac.stanford.edu)]

Status	e^- Source	Positron acceleration	Drive complex	Interstage coupling	Plasma medium
Conventional	Damping Ring	posi	Pulsed RF	Warm magnets	Laser-ionized
Upgraded	Photoinjector	posi	CW RF	Warm magnets and plasma lenses	Laser-ionized
Advanced	Plasma injector	posi	CW High-Q	Combined function plasma	Beam-ionized

Table 15.3: Upgrade table for plasma-based linear collider.

15.1.3 Plasma, Laser, and Structure Wakefield Accelerators

[5 pages; corresponding editor: Spencer Gessner (sgess@slac.stanford.edu)]

As a long-term goal, we envision upgrading the ILC with advanced accelerator technologies that not only deliver extremely high-energy beams, but do so in a highly-efficient manner to achieve high luminosities.

There are many challenges on the path to a PLC. May be able to solve some, but not all challenges. Develop notion of an Upgrade Matrix:

Beam-Driven Plasma Linear Collider

Research on beam-driven plasma wakefield acceleration is motivated by the ultimate goal of creating a linear collider that is affordable, highly-efficient, and operates at the highest possible energies. There are many challenges on the path to a plasma-based upgrade to the ILC, but the field has shown steady progress on multiple fronts since the last Snowmass in 2013. Amongst many highlights are the first demonstration of highly-efficient plasma acceleration of electron beams [?], acceleration of positron beams in the non-linear regime [?], proton beam-driven acceleration [?], staged laser-plasma acceleration [?], plasma photocathodes for generating ultralow-emittance beams [?], and emittance preservation in an active plasma lens [?].

The remaining challenges associated with the development of a PLC have been identified in a variety of papers, workshops, and strategy sessions [?, ?, ?, ?, ?, ?, ?, ?]. We enumerate some of them here:

1. High-efficiency, high-quality acceleration in a single plasma stage.
2. Coupling between plasma stages.
3. Positron acceleration in plasma.
4. Preservation of beam polarization.
5. High repetition-rate plasma acceleration and energy deposition in the plasma source.
6. Final focusing and alignment of beams at the collision point.

Experiments to demonstrate high-efficiency, high-quality electron acceleration in plasma are currently underway at FLASHForward at DESY and preparing to start at FACET-II at SLAC. These experiments will demonstrate the viability of PWFA technology and establish the tolerances for producing high-quality beams. Experiments at FLASHForward will also study high-repetition rate PWFA, while experiments at FACET-II will cover positron acceleration in plasma and beam focusing based on thin plasma lenses. Both FLASHForward and FACET-II need to be modified in order to demonstrate staged PWFA, which is a high priority for the field.

ILC Upgrade to multi-TeV using Laser Wakefield Accelerators

[1 page; corresponding authors: C. Schroeder, C. Geddes, E. Esarey (LBNL)]

Laser wakefield accelerators (LWFAs) [267] rely on an intense, ultrashort laser pulses to resonantly excite large amplitude electron plasma waves with relativistic phase velocities. The accelerating fields of the plasma wave, or wakefields, are 1-10 GV/m, orders of magnitude larger than conventional accelerating structures, enabling compact acceleration of charged particle beams. LWFA technology provides an opportunity to upgrade the ILC to higher beam energy using the planned ILC main linac tunnel, site power, and infrastructure. An LWFA-based linac arm would consist of multiple plasma stages, each stage yielding a few GeV/stage energy gain, driven by a multi-J, short pulse laser [268, 269]. Laser drivers are highly flexible, and plasma mirror technology enables compact coupling of the laser driver into the plasma accelerating cells. The multi-Joule-class laser systems, potentially based on fiber laser combination, occupy an area of a few m² and both the drive lasers and plasma accelerating stages may be placed in the ILC Main Linac tunnel. LWFAs accelerate short bunches, of order 10 micron, and the resulting beamstrahlung reduction at the IP yields significant power savings for a given target luminosity. To reach $E_{CM} = 1$ TeV, an LWFA-based linac requires potentially only 0.2 km in each linac arm, and 100 MW of power for both beams to reach a luminosity of 10^{34} cm⁻²s⁻¹. This could be upgraded to $E_{CM} = 3$ TeV with luminosity of 10^{35} cm⁻²s⁻¹, requiring a 0.65 km LWFA linac in each linac arm and 300 MW of power for both beams. The LWFA beam power for 1 TeV and 3 TeV would be 4 MW and 12 MW, respectively, and are within the power rating of the planned ILC beam dump. The unused main linac tunnel length could be employed to extend the BDS system to accommodate $E_{CM} = 3$ TeV, as well as space for linear cooling sections to further reduce the beam emittance. The bunch structure employed is one bunch each 20 μ s, and additional bunch compressors would be required to achieve the short, 10-micron-scale, bunch length. Furthermore, achieving high beam energies ($E_{CM} > 3$ TeV) is straightforward by adding additional LWFA stages, although the required increased luminosity would require site power beyond the planned ILC design. This provides a long-term upgrade path to continue realizing new physics reach in realistic stages using the infrastructure of a linear collider. Significant R&D is required to realize an LWFA-based linac, and, in particular, further development of high average power, short-pulse laser systems operating at tens of kHz repetition rates [270].

Structure Wakefield Accelerators

John Power (ANL), Chunguang Jing (ANL, Euclid) and Philippe Piot (ANL, NIU):

Structure Wakefield Acceleration (SWFA) has been proposed as the backbone for a high-gradient and high-efficiency accelerator for a multi-TeV linear collider [271]. Two separate SWFA schemes, two-beam acceleration (TBA) and collinear wakefield acceleration (CWA) are under consideration. This contribution will explore the application of the relatively mature SWFA schemes (both in the TBA and CWA implementations) as a possible upgrade path to the ILC. The ILC beam format (a train of 3.2 nC single-bunch with an O(MHz) micropulse repetition rate) is comparable to the 182-GHz CWA-based XFEL design that is being pursued at Argonne. The challenge for the CWA based linear collider would be to raise the overall efficiency due to its single pulse nature. Alternatively, the TBA technology currently under development at Argonne is a 26 GHz accelerator based on a high charge drive beam. Therefore, a TBA contribution to the ILC application would explore two avenues: either operating ILC with higher charge or raising the TBA operating frequency to operate at lower drive charge. Critical to both the TBA and CWA approaches would be continued development of the SWFA bunch control R&D program. This program develops the bunch shaping technology critical for the main and drive beams. For example, we will explore the possibility of shaping the ILC 3.2nC Gaussian bunch for the CWA scheme with a transformer ratio of 5 to produce a 5TeV LC in the ILC tunnel at high efficiency. Note that bunch control is critical to both beam-driven wakefield acceleration methods: SWFA and plasma wakefield acceleration (PWFA).

15.2 Physics Opportunities at Multi-TeV

[7 pages; corresponding editors: Zhen Liu (zliuphys@umn.edu), James Wells (jwells@umich.edu)]

(This section will review the program of BSM measurements laid out for CLIC [246] and new experiments in this energy region studied at Snowmass.)

15.3 Physics Opportunities at Multi-10 TeV

[5 pages; corresponding editors: Nathaniel Craig (ncraig@physics.ucsb.edu), Zhen Liu (zliuphys@umn.edu), Michael Peskin (mpeskin@slac.stanford.edu)]

(This section will review new work to be done for Snowmass on physics at very high energy e^+e^- and $\gamma\gamma$ colliders.)

Chapter 16

Conclusions

[3 pages; corresponding editor: Michael Peskin (mpeskin@slac.stanford.edu)]

This is the conclusion.

total page count: 186 pages + bibliography

ACKNOWLEDGEMENTS

We are grateful to ...

Bibliography

- [1] T. Behnke, J.E. Brau, B. Foster, J. Fuster, M. Harrison, J.M. Paterson et al., eds., *The International Linear Collider Technical Design Report - Volume 1: Executive Summary*, [1306.6327](#).
- [2] H. Baer et al., eds., *The International Linear Collider Technical Design Report - Volume 2: Physics*, [1306.6352](#).
- [3] C. Adolphsen et al., eds., *The International Linear Collider Technical Design Report - Volume 3.I: Accelerator \& in the Technical Design Phase*, [1306.6353](#).
- [4] C. Adolphsen et al., eds., *The International Linear Collider Technical Design Report - Volume 3.II: Accelerator Baseline Design*, [1306.6328](#).
- [5] H. Abramowicz et al., *The International Linear Collider Technical Design Report - Volume 4: Detectors*, [1306.6329](#).
- [6] P. Bambade et al., *The International Linear Collider: A Global Project*, [1903.01629](#).
- [7] LCC PHYSICS WORKING GROUP collaboration, *Tests of the Standard Model at the International Linear Collider*, [1908.11299](#).
- [8] K. Fujii et al., *ILC Study Questions for Snowmass 2021*, [2007.03650](#).
- [9] LINEAR COLLIDER COLLABORATION collaboration, *The International Linear Collider Machine Staging Report 2017*, [1711.00568](#).
- [10] M. Harrison, M. Ross and N. Walker, *Luminosity Upgrades for ILC*, [1308.3726](#).
- [11] CERN, “Environment report.” <http://cds.cern.ch/record/2737239>, 2020.
- [12] JAHEP SUBCOMMITTEE ON FUTURE PROJECTS OF HIGH ENERGY PHYSICS collaboration, S. Asai et al., “The final report of the subcommittee on future projects of high energy physics.” http://www.jahep.org/office/doc/201202_hecsubc_report.pdf, 2012.
- [13] Japan Association of High Energy Physicists (JAHEP), “A proposal for a phased execution of the international linear collider project.” http://www.jahep.org/office/doc/201210_ILC_staging_e.pdf, 2012.

- [14] T. Sanuki, “Overview of the topography and geology of the Kitakami site for the ILC.” Presentation at DESY, Feb. 14, 2017, 2017.
- [15] R.D. Heuer et al., “Parameters for the linear collider.” <https://icfa.fnal.gov/wp-content/uploads/para-Nov20-final.pdf>, 2006.
- [16] M. Dugan, G. and Harrison, B. List and N. Walker, “Implications of an energy-phased approach to the realization of the ILC.” <http://edmsdirect.desy.de/item/D00000001046475>, 2014.
- [17] G. White, “Change request ILC-CR-0002: Baseline optics to provide for a single L^* .” <http://edmsdirect.desy.de/item/D00000001119175>, 2014.
- [18] K. Buesser, “Change request ILC-CR-0003: Detector hall with vertical shaft access.” <http://edmsdirect.desy.de/item/D00000001084745>, 2014.
- [19] E. Paterson, V. Kuchler, N. Solyak and T. Sanami, “Change request ILC-CR-0012: Reduction of width of linac shield wall and tunnel cross-section.” <http://edmsdirect.desy.de/item/D00000001127835>, 2015.
- [20] K. Yokoya, B. List and E. Paterson, “Change request ILC-CR-0013: Update of the ILC beam dump specifications.” <http://edmsdirect.desy.de/item/D00000001145035>, 2016.
- [21] K. Yokoya, “Change request ILC-CR-0016: Luminosity improvement at 250 GeV.” <http://edmsdirect.desy.de/item/D00000001159725>, 2017.
- [22] Positron Working Group, “Report on the ILC positron source.” <http://edmsdirect.desy.de/item/D00000001165115>, 2018.
- [23] International Committee for Future Accelerators (ICFA), “ICFA statement on the ILC operating at 250 GeV as a Higgs boson factory.” <https://icfa.fnal.gov/wp-content/uploads/ICFA-Statement-Nov2017.pdf>, 2017.
- [24] “TESLA Technology Collaboration.” <http://tesla-new.desy.de/>.
- [25] S. Schreiber and B. Faatz, *The free-electron laser flash*, *High Power Laser Science and Engineering* **3** (2015) E20.
- [26] M. Vogt et al., *Status of the Superconducting Soft X-Ray Free-Electron Laser FLASH at DESY*, in *Proceedings, 9th International Particle Accelerator Conference (IPAC 2018), Vancouver, BC, Apr 29–May 4, 2018*, pp. 1481–1484 (TUPMF090), 2018, DOI.
- [27] “European XFEL.” <https://www.xfel.eu/>.
- [28] “LCLS-II: A world-class discovery machine.” <https://lcls.slac.stanford.edu/lcls-ii>.
- [29] Z. Zhao, D. Wang, Z.-H. Yang and L. Yin, *SCLF: An 8-GeV CW SCRF Linac-Based X-Ray FEL Facility in Shanghai*, in *Proceedings, 38th International Free Electron Laser Conference, FEL2017*, pp. 182–184 (MOP055), 2018, DOI.

- [30] N. Huang et al., *Features and futures of X-ray free-electron lasers*, *The innovation* **2** (2021) 100097.
- [31] C. Adolphsen, “Optimum ML cavity performance: gradient, Q_0 , and other ML parameters.” Presentation at 2011 Linear Collider Workshop of the Americas (ALCPG11), Eugene, OR, Mar 19–23, 2011, <https://agenda.linearcollider.org/event/4572/>, 2011.
- [32] W. Singer et al., *Production of superconducting 1.3 GHz cavities for the European X-ray Free Electron Laser*, *Phys. Rev. Accel. Beams* **19** (2016) 092001.
- [33] D. Reschke et al., *Performance in the vertical test of the 832 nine-cell 1.3 GHz cavities for the European X-ray Free Electron Laser*, *Phys. Rev. Accel. Beams* **20** (2017) 042004.
- [34] N.J. Walker and D. Kostin, “The European XFEL – experience and lessons learned.” Presentation, International Workshop on Future Linear Colliders (LCWS2017), Strasbourg, France, Oct 22–27, 2017, <https://agenda.linearcollider.org/event/7645/>, 2017.
- [35] W. Kaabi et al., *Power couplers for XFEL*, in *Proceedings, 4th International Particle Accelerator Conference (IPAC 2013), Shanghai, China, May 12-17, 2013*, pp. 2310–2312 (WEPWO001), 2013, <http://JACoW.org/IPAC2013/papers/wepwo001.pdf>.
- [36] S. Sierra et al., *Status and lesson learned from manufacturing of FPC couplers for the XFEL program*, in *Proceedings, 28th International Linear Accelerator Conference (LINAC16), East Lansing, MI, Sep 25-30, 2016*, pp. 572–574 (TUPLR048), 2017, DOI.
- [37] D. Reschke, W. Decking, N. Walker and H. Weise, *The commissioning of the European XFEL Linac and its performance*, in *Proceedings, 18th International Conference on RF Superconductivity (SRF2017): Lanzhou, China, Jul 17-21, 2017*, pp. 1–5 (MOXA02), 2018, DOI.
- [38] S. Berry and O. Napoly, *Assembly of XFEL cryomodules: lessons and results*, in *Proceedings, 28th International Linear Accelerator Conference (LINAC16): East Lansing, Michigan, September 25-30, 2016*, pp. 646–650 (WE1A02), 2017, DOI.
- [39] T.J. Peterson et al., *A Survey of Pressure Vessel Code Compliance for Superconducting RF Cryomodules*, *AIP Conf. Proc.* **1434** (2011) 1575 [1209.2405].
- [40] H. Weise, *How To Produce 100 Superconducting Modules for the European XFEL in Collaboration and with Industry*, in *Proceedings, 5th International Particle Accelerator Conference (IPAC 2014): Dresden, Germany, Jun 15-20, 2014*, pp. 1923–1928 (WEIB03), 2014, DOI.
- [41] D. Kostin, W.-D. Moeller, A. Goessel and K. Jensch, *Superconducting accelerating module tests at DESY*, in *Proceedings, 14th International Conference on RF Superconductivity (SRF2009), Berlin, Sep 20-25, 2009*, pp. 180–184 (TUPPO005), 2009, <http://accelconf.web.cern.ch/AccelConf/SRF2009/papers/TUPPO005.PDF>.
- [42] D. Broemmelsiek et al., *Record High-Gradient SRF Beam Acceleration at Fermilab*, *New J. Phys.* **20** (2018) 113018 [1808.03208].

- [43] Y. Yamamoto et al., *Achievement of Stable Pulsed Operation at 36 MV/m in STF-2 Cryomodule at KEK*, in *Proceedings, 18th International Conference on RF Superconductivity (SRF2017)*, Lanzhou, China, Jul 17–21, 2017, pp. 722–728 (THYA02), 2018, DOI.
- [44] K. Kasprzak et al., *Test Results of the European XFEL Serial-production Accelerator Modules*, in *Proceedings, 18th International Conference on RF Superconductivity (SRF2017)*, Lanzhou, China, July 17-21, 2017, pp. 312–316 (MOPB106), 2018, DOI.
- [45] S1Global collaboration, “S1Global report.”
<http://edmsdirect.desy.de/item/D00000001005135>, 2012.
- [46] M.A. Kemp et al., *Final design of the SLAC P2 Marx klystron modulator*, in *Proceedings, 18th IEEE International Pulsed Power Conference (PPC11)*, Chicago, IL, Jun 19-23, 2011, pp. 1582–1589, 2011, DOI.
- [47] M.P.J. Gaudreau, N. Silverman, B. Simpson and J. Casey, *ILC-class Marx modulator at KEK*, in *Proceedings, 5th International Particle Accelerator Conference (IPAC 2014)*, Dresden, Germany, Jun 15-20, 2014, pp. 562–563 (MOPME082), 2014,
<http://jacow.org/IPAC2014/papers/mopme082.pdf>.
- [48] I. Syratchev, “Introduction to the High Efficiency International Klystron Activity HEIKA.” Presentation, CLIC workshop 2015, Geneva, Switzerland, Jan 26–30, 2015,
<https://indico.cern.ch/event/336335/>, 2015.
- [49] F. Gerigk, *Status and future strategy for advanced high power microwave sources for accelerators*, in *Proceedings, 9th International Particle Accelerator Conference (IPAC 2018)*, Vancouver, BC, Canada, Apr 29–May 4, 2018, pp. 12–17 (MOYGB1), 2018, DOI.
- [50] I.A. Guzilov, *Bac method of increasing the efficiency in klystrons*, in *Proceedings, 10th International Vacuum Electron Sources Conference (IVESC)*, Jun 30–Jul 4, 2014, p. 6891996, 2013, DOI.
- [51] D. Constable et al., *High efficiency klystron development for particle accelerators*, in *Proceedings, 58th ICFA Advanced Beam Dynamics Workshop on High Luminosity Circular e^+e^- Colliders (eeFACT2016)*, Daresbury, UK, Oct 24–27, 2016, pp. 185–187 (WET3AH2), 2017, DOI.
- [52] A.Y. Baikov, C. Marrelli and I. Syratchev, *Toward high-power klystrons with RF power conversion efficiency on the order of 90 %*, *IEEE Trans. Electron. Dev.* **62** (2015) 3406.
- [53] E. Jensen, “Recent developments towards very high efficiency klystrons.” Presentation, 9th CW and high average RF power workshop, Grenoble, France, Jun 20–24, 2016,
<https://indico.cern.ch/event/472685/>, 2016.
- [54] H. Nakai, “Change request ILC-CR-0014: Cryogenic layout.”
<http://edmsdirect.desy.de/item/D00000001146525>, 2016.
- [55] R. Alley et al., *The Stanford Linear Accelerator polarized electron source*, *Nucl. Instrum. Meth.* **A365** (1995) 1.

- [56] G. Alexander et al., *Undulator-based production of polarized positrons*, *Nucl. Instrum. Meth.* **A610** (2009) 451 [0905.3066].
- [57] K. Moffeit et al., “Spin rotation schemes at the ILC for two interaction regions and positron polarization with both helicities.” SLAC-TN-05-045, 2005.
- [58] L.I. Malysheva et al., *Design of Pre-Dumping Ring Spin Rotator with a Possibility of Helicity Switching for Polarized Positrons at the ILC*, 1602.09050.
- [59] M.G. Billing et al., *Status of Low Emittance Tuning at CesrTA*, in *Proceedings, 24th Particle accelerator Conference (PAC’11), New York, NY, Mar 28–Apr 1, 2011*, pp. 1540–1542 (WEP022), 2011, <http://accelconf.web.cern.ch/AccelConf/PAC2011/papers/WEP022.PDF>.
- [60] J.V. Conway, Y. Li and M.A. Palmer, *The conceptual design of a vacuum system for the ilc damping rings incorporating electron cloud mitigation techniques*, in *Proceedings, 3rd International Conference on Particle accelerator (IPAC 2012), New Orleans, LA, May 2-25, 2012*, pp. 1960–1962 (TUPPR062), 2012, <http://accelconf.web.cern.ch/AccelConf/IPAC2012/papers/TUPPR062.PDF>.
- [61] T. Naito et al., *Multi-bunch beam extraction using strip-line kicker at KEK-ATF*, in *Proceedings, 1st International Particle Accelerator Conference (IPAC’10), Kyoto, Japan, May 23–28, 2010*, pp. 2386–2388 (WEOBMH02), 2010, <http://accelconf.web.cern.ch/AccelConf/IPAC10/papers/weobmh02.pdf>.
- [62] P. Emma, T. Raubenheimer and F. Zimmermann, *A bunch compressor for the next linear collider*, in *Proceedings, 16th Particle Accelerator Conference and International Conference on High-Energy Accelerators, (HEACC 1995), Dallas, TX, May 1-5, 1995*, pp. 704–706 (RPC03), 1996, <http://accelconf.web.cern.ch/AccelConf/p95/ARTICLES/RPC/RPC03.PDF>.
- [63] N. Walker, “Change request ILC-CR-0010: Proposal to include bunch compressor sections into main linac accelerator system.” <http://edmsdirect.desy.de/item/D00000001119175>, 2015.
- [64] P. Raimondi and A. Seryi, *A Novel final focus design for future linear colliders*, *Phys. Rev. Lett.* **86** (2001) 3779.
- [65] ATF2 collaboration, B.I. Grishanov et al., “ATF2 Proposal.” SLAC-R-771, CERN-AB-2005-035, DESY-05-148, KEK-REPORT-2005-2, 2005.
- [66] B.I. Grishanov et al., *ATF2 proposal, Vol. 2*, [physics/0606194](https://arxiv.org/abs/physics/0606194).
- [67] T. Okugi, *Achievement of small beam size at ATF2 beamline*, in *Proceedings, 28th International Linear Accelerator Conference (LINAC16), East Lansing, MI, Sep 25-30, 2016*, pp. 27–31 (MO3A02), 2017, DOI.
- [68] ATF2 collaboration, *Experimental validation of a novel compact focusing scheme for future energy-frontier linear lepton colliders*, *Phys. Rev. Lett.* **112** (2014) 034802.

- [69] R.J. Apsimon et al., *Design and operation of a prototype interaction point beam collision feedback system for the International Linear Collider*, *Phys. Rev. Accel. Beams* **21** (2018) 122802 [[1812.08432](#)].
- [70] R. Ramjiawan et al., *Development of a Low-Latency, High-Precision, Beam-Based Feedback System Based on Cavity BPMs at the KEK ATF2*, in *Proceedings, 9th International Particle Accelerator Conference (IPAC 2018): Vancouver, BC, Ap 29–May 4, 2018*, pp. 2212–2215 (WEPAL025), 2018, [DOI](#).
- [71] A. Latina and A. Faus-Golfe, “ATF2.” Input paper for European Strategy for Particle Physics Update, 2018.
- [72] D.R. Walz, L.R. Lucas, H.A. Weidner, R.J. Vetterlein and E.J. Seppi, *Beam Dumps, Energy Slits and Collimators at SLAC - - Their Final Versions and First Performance Data*, *IEEE Trans. Nucl. Sci.* **14** (1967) 923.
- [73] S. Boogert et al., *Polarimeters and Energy Spectrometers for the ILC Beam Delivery System*, *JINST* **4** (2009) P10015 [[0904.0122](#)].
- [74] B. Vormwald, J. List and A. Vauth, *A calibration system for Compton polarimetry at e^+e^- linear colliders*, *JINST* **11** (2016) P01014 [[1509.03178](#)].
- [75] ILC Strategy Council, “Announcement of the results of the ILC candidate site evaluation in Japan.” Press release 28.8.2014, <http://ilc-str.jp/topics/2013/08281826/>, 2014.
- [76] B. Warmbein, “The road to Kitakami.” ILC Newline Feb. 20, 2014, <http://newline.linearcollider.org/2014/02/20/the-road-to-kitakami/>, 2014.
- [77] T. Sanuki, “New developments at the Kitakami site.” Presentation at Linear Collider Workshop 2015 (LCWS15), Whistler, BC, Canada, Nov 1–7, 2015, <https://agenda.linearcollider.org/event/6662/>, 2015.
- [78] T. Sanuki and I. Sekine, “Seismic base isolation for detectors and accelerator.” Presentation at International Workshop on Future Linear Colliders, LCWS2018, Arlington, TX, Oct 22-26, 2018, <https://agenda.linearcollider.org/event/7889/>, 2018.
- [79] T. Sanuki, “Tunnel floor vibration issue.” Presentation at Asian Linear Collider Workshop (ALCW 2018), Fukuoka, Japan, May 28–Jun 2, 2018, <https://agenda.linearcollider.org/event/7826/>, 2018.
- [80] OECD, “Prices and purchasing power parities (PPP).” <http://www.oecd.org/sdd/prices-ppp/>, 2018.
- [81] Eurostat, *Eurostat-OECD methodological manual on Purchasing Power Parities*, Luxembourg: Publications Office of the European Union, 2012 ed. (2012).
- [82] ILC Advisory Panel, “Summary of the ILC advisory panel’s discussions to date after revision.” Report, Jul 4, 2018, http://www.mext.go.jp/component/b_menu/shingi/toushin/_icsFiles/afieldfile/2018/09/20/1409220_2_1.pdf, 2018.

- [83] P. Bambade, T. Barklow, T. Behnke, M. Berggren, J. Brau, P. Burrows et al., *The international linear collider: a global project*, arXiv preprint arXiv:1903.01629 (2019) .
- [84] K. Yokoya, K. Kubo and T. Okugi, *Operation of ilc250 at the z-pole*, arXiv preprint arXiv:1908.08212 (2019) .
- [85] S. Asai, J. Tanaka, Y. Ushiroda, M. Nakao, J. Tian, S. Kanemura et al., *Report by the committee on the scientific case of the ilc operating at 250 gev as a higgs factory*, arXiv preprint arXiv:1710.08639 (2017) .
- [86] A. Grassellino et al., *Accelerating fields up to 49 MV/m in TESLA-shape superconducting RF niobium cavities via 75C vacuum bake*, [1806.09824](#).
- [87] A. Grassellino et al., *Unprecedented quality factors at accelerating gradients up to 45 MV/m in niobium superconducting resonators via low temperature nitrogen infusion*, *Supercond. Sci. Technol.* **30** (2017) 094004 [[1701.06077](#)].
- [88] D. Gonnella, R. Eichhorn, F. Furuta, M. Ge, D. Hall, V. Ho et al., *Nitrogen-doped 9-cell cavity performance in a test cryomodule for lcls-ii*, *Journal of Applied Physics* **117** (2015) 023908.
- [89] M. Harrison, M. Ross and N. Walker, *Luminosity Upgrades for ILC*, in *Community Summer Study 2013: Snowmass on the Mississippi*, 8, 2013 [[1308.3726](#)].
- [90] T. Sanuki, “Tunnel floor vibration issues.” Presentation, Asian Linear Collider Workshop (ALCW2018), Fukuoka, Japan, May 28–Jun 2, 2018.
<https://agenda.linearcollider.org/event/7826/>, 2018.
- [91] K. Yokoya, *Beam-beam interaction in linear collider*, in *AIP Conference Proceedings*, vol. 592, pp. 185–204, American Institute of Physics, 2001.
- [92] L. Evans and S. Michizono, *The international linear collider machine staging report 2017*, arXiv preprint arXiv:1711.00568 (2017) .
- [93] A. Ushakov, G. Moortgat-Pick, S. Riemann, W. Liu and W. Gai, *Positron source simulations for ilc 1 tev upgrade*, arXiv preprint arXiv:1301.1222 (2013) .
- [94] J. Jones and D. Angal-Kalinin, *Beam delivery system dogleg design and integration for the international linear collider*, *EuCARD-CON-2010-032* (2010) .
- [95] A. Yamamoto in *ESPP Symposium 2019*, 2019.
- [96] M. Pekeler, *Superconducting RF Cavity System Production for Particle Accelerators in Scientific and Industrial Applications*, in *Proceedings of ICHEP 2016*, 2016.
- [97] W. Singer et al., *Development of large grain cavities*, *Phys. Rev. ST Accel. Beams* **16** (2013) [012003](#).
- [98] A. Grassellino, *N Doping: Progress in Development and Understanding*, in *17th International Conference on RF Superconductivity*, p. MOBA06, 2015, DOI.

- [99] A. Romanenko and C. Edwardson, *The effect of vacancies on the microwave surface resistance of niobium revealed by positron annihilation spectroscopy*, *Appl. Phys. Lett.* **102** (2013) 232601.
- [100] S. Posen, A. Romanenko, A. Grassellino, O. Melnychuk and D. Sergatskov, *Ultralow Surface Resistance via Vacuum Heat Treatment of Superconducting Radio-Frequency Cavities*, *Phys. Rev. Applied* **13** (2020) 014024 [1907.00147].
- [101] F. He et al., *Medium-temperature furnace bake of Superconducting Radio-Frequency cavities at IHEP*, 2012.04817.
- [102] P. Dhakal, *Nitrogen Doping and Infusion in SRF Cavities: A Review*, *Phys. Open* **5** (2020) 100034 [2005.03149].
- [103] K. Umemori, E. Kako, T. Konomi, S. Michizono, T. Okada, H. Sakai et al., *Study on Nitrogen Infusion using KEK New Furnace*, in *19th International Conference on RF Superconductivity (SRF 2019)*, p. MOP027, 2019, DOI.
- [104] M. Wenskat, C. Bate, A. Jeromin, T. Keller, J. Knobloch, F. Kramer et al., *Cavity Cut-out Studies of a 1.3 GHz Single-cell Cavity After a Failed Nitrogen Infusion Process*, in *19th International Conference on RF Superconductivity (SRF 2019)*, p. MOP025, 2019, DOI.
- [105] V. Shemelin and H. Padamsee, *The optimal shape of cells of a superconducting accelerating section*, .
- [106] V. Shemelin, H. Padamsee and R. Geng, *Optimal cells for TESLA accelerating structure*, *Nucl. Instrum. Meth. A* **496** (2003) 1.
- [107] J. Sekutowicz et al., *Low Loss Cavity for the 12 GeV CEBAF Upgrade*, .
- [108] K. Saito, *“Strategy for 50 MV/m*, .
- [109] Z. Li and C. Adolphsen, *A New SRF Cavity Shape with Minimized Surface Electric and Magnetic Fields for the ILC*, .
- [110] F. Furuta et al., *Experimental comparison at KEK of high gradient performance of different single cell superconducting cavity designs*, *Conf. Proc. C* **060626** (2006) 750.
- [111] G. Ereemeev, R. Geng, H. Padamsee and V. Shemelin, *High Gradient Studies for ILC with Single Cell Re entrant Shape and Elliptical Shape Cavities made of Fine grain and Large grain Niobium*, *Conf. Proc. C* **070625** (2007) 2337.
- [112] R. Geng, A. Seaman, V. Shemelin and H. Padamsee, *World record accelerating gradient achieved in a superconducting niobium RF cavity*, *Conf. Proc. C* **0505161** (2005) 653.
- [113] C.E. Reece and G. Ciovati, *Superconducting Radio-Frequency Technology R&D for Future Accelerator Applications*, *Rev. Accel. Sci. Tech.* **5** (2012) 285 [1208.1978].
- [114] R.L.e. Geng, *LSF Shape Cavity Development: Recent Results and Future Plan*, in *LCWS 2018*, 2018.

- [115] T. Peterson and J. Weisend II, *TESLA & ILC Cryomodules*, in *Cryostat Design*, pp. 117–145 (2016), [DOI](#).
- [116] A. Avrakhov, P. Kanareykin and N. Solyak, *Traveling wave accelerating structure for a superconducting accelerator*, *Conf. Proc. C* **0505161** (2005) 4296.
- [117] R. Kostin, P. Avrakhov, A. Kanareykin, N. Solyak, V. Yakovlev, S. Kazakov et al., *A high gradient test of a single-cell superconducting radio frequency cavity with a feedback waveguide*, *Supercond. Sci. Technol.* **28** (2015) 095007.
- [118] V. Shemelin *PRSTAB*, to be submitted (2021) .
- [119] S. Posen and D. Hall, *Nb₃Sn superconducting radiofrequency cavities: fabrication, results, properties, and prospects*, *Supercond. Sci. Technol.* **30** (2017) 033004.
- [120] S. Posen, J. Lee, O. Melnychuk, Y. Pischalnikov, D. Seidman, D. Sergatskov et al., *Nb₃Sn at Fermilab: Exploring Performance*, in *19th International Conference on RF Superconductivity (SRF 2019)*, p. THFUB1, 2019, [DOI](#).
- [121] S. Posen in *TTC2019*, 2019.
- [122] e. Godeke, *A. Supercond. Sci. Technol.* **19** (2006) R68.
- [123] e. Becker, *C. Appl. Phys. Lett.* **106** (2015) 082602.
- [124] I.L.C.I.A. Panel, *Summary of the ilc advisory panel's discussions to date after revision*, 2018.
- [125] S.C. of Japan, *Assessment of the revised plan of international linear collider project*, 2018.
- [126] I.I.D.T.W.G. 2, *Technical preparation and work packages during ilc pre-lab*, 2021. 10.5281/zenodo.4742018.
- [127] R. Hori.
- [128] F. Furuta, D. Bice, A.C. Crawford and T. Ring, *Fermilab EP Facility Improvement*, in *19th International Conference on RF Superconductivity (SRF 2019)*, pp. 453–455, 2019, [DOI](#).
- [129] Y. Pischalnikov, B. Hartman, J. Holzbauer, W. Schappert, S. Smith and J.-C. Yun, *Reliability of the LCLS II SRF Cavity Tuner*, in *17th International Conference on RF Superconductivity*, p. THPB065, 2015, [DOI](#).
- [130] V. Kashikhin, S. Cheban, J. DiMarco, E. Harms, A. Makarov, T. Strauss et al., *Superconducting Magnet Performance in LCLS-II Cryomodules*, in *9th International Particle Accelerator Conference*, p. WEPML009, 2018, [DOI](#).
- [131] M. Doleans, *Ignition and monitoring technique for plasma processing of multicell superconducting radio-frequency cavities*, *J. Appl. Phys.* **120** (2016) 243301.

- [132] P. Berrutti, B. Giaccone, M. Martinello, A. Grassellino, T. Khabiboulline, M. Doleans et al., *Plasma ignition and detection for in-situ cleaning of 1.3 GHz 9-cell cavities*, *J. Appl. Phys.* **126** (2019) 023302 [1902.03172].
- [133] S. Posen, J. Lee, D. Seidman, A. Romanenko, B. Tennis, O. Melnychuk et al., *Advances in Nb₃Sn superconducting radiofrequency cavities towards first practical accelerator applications*, 2008.00599.
- [134] J. Strube and M. Titov, *Detector Liaison Report v2021.2.2*, *Zenodo* (2021) .
- [135] M. Thomson, *Particle Flow Calorimetry and the PandoraPFA Algorithm*, *Nucl.Instrum.Meth.* **A611** (2009) 25 [0907.3577].
- [136] K. Fujii et al., *Physics Case for the 250 GeV Stage of the International Linear Collider*, 1710.07621.
- [137] J. Brau and *et.al.*, “The international linear collider: A global project.” http://ilchome.web.cern.ch/sites/ilchome.web.cern.ch/files/ILC_Global_Project_Final.pdf, 2018.
- [138] Strube, Jan and Titov, Maxim, “Linear Collider R&D liaison report.” <http://linearcollider.org/physics-detectors/working-group-detector-rd-liaison>, 2018.
- [139] L. Greiner, E. Anderssen, H. Matis, H. Ritter, J. Schambach et al., *A MAPS based vertex detector for the STAR experiment at RHIC*, *Nucl.Instrum.Meth.* **A650** (2011) 68.
- [140] DEPFET collaboration, *The ultralight DEPFET pixel detector of the Belle II experiment*, *Nucl. Instrum. Meth.* **A845** (2017) 118.
- [141] S. Murai, A. Ishikawa, T. Sanuki, A. Miyamoto, Y. Sugimoto, C. Constantino et al., *Recent status of FPCCD vertex detector R&D*, in *Proceedings, International Workshop on Future Linear Colliders (LCWS15): Whistler, B.C., Canada, November 02-06, 2015*, 2016 [1603.00009].
- [142] T.a.t.L..c. Frank Gaede, “Linear Collider Workshop 2018 in Arlington, USA.” <https://agenda.linearcollider.org/event/7889/>, 2018.
- [143] LCTPC collaboration, *Development of a TPC for an ILC Detector*, *Phys. Procedia* **37** (2012) 456 [1203.2074].
- [144] M. Hauschild, *Particle ID with dE/dx at the TESLA-TPC*, *AIP Conf. Proc.* **578** (2001) 878.
- [145] LCTPC collaboration, *A Time Projection Chamber with GEM-Based Readout*, *Nucl. Instrum. Meth.* **A856** (2017) 109 [1604.00935].
- [146] J. Bouchez et al., *Bulk micromegas detectors for large TPC applications*, *Nucl. Instrum. Meth.* **A574** (2007) 425.

- [147] F. Sefkow, A. White, K. Kawagoe, R. Poeschl and J. Repond, *Experimental Tests of Particle Flow Calorimetry*, *Rev. Mod. Phys.* **88** (2016) 015003 [[1507.05893](#)].
- [148] CALICE collaboration, *Technological Prototypes and Result Highlights of Highly Granular Calorimeters*, *PoS EPS-HEP2017* (2017) 497.
- [149] CALICE collaboration, *Beam Test Results with Highly Granular Hadron Calorimeters for the ILC*, *Conf. Proc.* **C0908171** (2009) 539 [[1002.1012](#)].
- [150] CALICE collaboration, *Construction of a technological semi-digital Hadronic calorimeter prototype for ILC*, in *Proceedings, 2010 IEEE Nuclear Science Symposium and Medical Imaging Conference (NSS/MIC 2010): Knoxville, Tennessee, October 30-November 6, 2010*, pp. 1800–1803, 2010, [DOI](#).
- [151] H. Abramowicz et al., *Forward Instrumentation for ILC Detectors*, *JINST* **5** (2010) P12002 [[1009.2433](#)].
- [152] I. Bozovic-Jelisavcic, S. Lukic, M. Pandurovic and I. Smiljanic, *Precision luminosity measurement at ILC*, in *International Workshop on Future Linear Colliders (LCWS13) Tokyo, Japan, November 11-15, 2013*, 2014 [[1403.7348](#)].
- [153] I. technical coordination, “ILD technical documentation.” <http://edmsdirect.desy.de/ildtdr>.
- [154] H. Abramowicz et al., *The International Linear Collider Technical Design Report - Volume 4: Detectors*, [1306.6329](#).
- [155] T. Barklow, J. Brau, K. Fujii, J. Gao, J. List, N. Walker et al., *ILC operating scenarios*, [1506.07830](#).
- [156] T.B. *et.al.*, “The ILD Design Report.” to be published.
- [157] N. Sinev, J. Brau, D. Strom, C. Baltay, W. Emmet and D. Rabinowitz, *Chronopixel project status*, *PoS VERTEX2015* (2015) 038.
- [158] J. Brau et al., *KPiX - A 1,024 Channel Readout ASIC for the ILC*, in *2012 IEEE Nuclear Science Symposium and Medical Imaging Conference and 19th Workshop on Room-Temperature Semiconductor X-ray and Gamma-ray Detectors*, pp. 1857–1860, 2012, [DOI](#).
- [159] A. Steinhebel and J. Brau, *Studies of the Response of the SiD Silicon-Tungsten ECal*, in *International Workshop on Future Linear Colliders*, 3, 2017 [[1703.08605](#)].
- [160] B. Parker, A. Mikhailichenko, K. Buesser, J. Hauptman, T. Tauchi, P. Burrows et al., *Functional Requirements on the Design of the Detectors and the Interaction Region of an e^+e^- Linear Collider with a Push-Pull Arrangement of Detectors*, in *Particle Accelerator Conference (PAC 09)*, p. WE6PFP078, 2010.
- [161] K. Buesser, *ILD Machine-Detector Interface and Experimental Hall Issues*, in *International Workshop on Future Linear Colliders (LCWS11)*, 1, 2012 [[1201.5807](#)].

- [162] M. Berggren, *SGV 3.0 - a fast detector simulation*, in *International Workshop on Future Linear Colliders (LCWS11) Granada, Spain, September 26-30, 2011*, 2012 [[1203.0217](#)].
- [163] J. Yan, S. Watanuki, K. Fujii, A. Ishikawa, D. Jeans, J. Strube et al., *Measurement of the Higgs boson mass and $e^+e^- \rightarrow ZH$ cross section using $Z \rightarrow \mu^+\mu^-$ and $Z \rightarrow e^+e^-$ at the ILC*, *Phys. Rev. D* **94** (2016) 113002 [[1604.07524](#)].
- [164] J. Tian, *A new method for measuring the Higgs mass at the ILC*, *ILD-PHYS-PUB-2019-001* (2020) .
- [165] G. Wilson, *Complementary Higgs mass measurements at ILC*, .
- [166] ILD CONCEPT GROUP collaboration, *International Large Detector: Interim Design Report*, [2003.01116](#).
- [167] H. Ono and A. Miyamoto, *A study of measurement precision of the Higgs boson branching ratios at the International Linear Collider*, *Eur. Phys. J. C* **73** (2013) 2343 [[1207.0300](#)].
- [168] S.-i. Kawada, K. Fujii, T. Suehara, T. Takahashi and T. Tanabe, *A study of the measurement precision of the Higgs boson decaying into tau pairs at the ILC*, *Eur. Phys. J. C* **75** (2015) 617 [[1509.01885](#)].
- [169] S.-i. Kawada, J. List and M. Berggren, *Prospects of measuring the branching fraction of the Higgs boson decaying into muon pairs at the International Linear Collider*, *Eur. Phys. J. C* **80** (2020) 1186 [[2009.04340](#)].
- [170] E. Antonov and A. Drutskoy, *Measurement of $\sigma(e^+e^- \rightarrow HZ) \times \text{Br}(H \rightarrow ZZ^*)$ at the 250 GeV ILC*, [2108.08867](#).
- [171] D. Jeans and G.W. Wilson, *Measuring the CP state of tau lepton pairs from Higgs decay at the ILC*, *Phys. Rev. D* **98** (2018) 013007 [[1804.01241](#)].
- [172] T. Ogawa, *Sensitivity to anomalous VVH couplings induced by dimension-6 operators at the ILC*, Ph.D. thesis, 2018.
- [173] D. Curtin et al., *Exotic decays of the 125 GeV Higgs boson*, *Phys. Rev.* **D90** (2014) 075004 [[1312.4992](#)].
- [174] Z. Liu, L.-T. Wang and H. Zhang, *Exotic decays of the 125 GeV Higgs boson at future e^+e^- lepton colliders*, *Chin. Phys.* **C41** (2017) 063102 [[1612.09284](#)].
- [175] LHC HIGGS CROSS SECTION WORKING GROUP collaboration, *Handbook of LHC Higgs Cross Sections: 4. Deciphering the Nature of the Higgs Sector*, [1610.07922](#).
- [176] J. Alwall, R. Frederix, S. Frixione, V. Hirschi, F. Maltoni et al., *The automated computation of tree-level and next-to-leading order differential cross sections, and their matching to parton shower simulations*, *JHEP* **1407** (2014) 079 [[arXiv:1405.0301](#)].
- [177] Q. Xiu, H. Zhu, X. Lou and T. Yue, *Study of beamstrahlung effects at CEPC*, *Chin. Phys.* **C40** (2016) 053001 [[1505.01270](#)].

- [178] M. Greco, T. Han and Z. Liu, *ISR effects for resonant Higgs production at future lepton colliders*, *Phys. Lett.* **B763** (2016) 409 [[1607.03210](#)].
- [179] M. Carena, Z. Liu and Y. Wang, *Electroweak phase transition with spontaneous Z_2 -breaking*, *JHEP* **08** (2020) 107 [[1911.10206](#)].
- [180] M.J. Ramsey-Musolf, *The electroweak phase transition: a collider target*, *JHEP* **09** (2020) 179 [[1912.07189](#)].
- [181] S. Alipour-Fard, N. Craig, S. Gori, S. Koren and D. Redigolo, *The second Higgs at the lifetime frontier*, *JHEP* **07** (2020) 029 [[1812.09315](#)].
- [182] Z. Chacko, P.J. Fox, R. Harnik and Z. Liu, *Neutrino Masses from Low Scale Partial Compositeness*, [2012.01443](#).
- [183] N. Craig, A. Katz, M. Strassler and R. Sundrum, *Naturalness in the Dark at the LHC*, *JHEP* **07** (2015) 105 [[1501.05310](#)].
- [184] D. Curtin and C.B. Verhaaren, *Discovering Uncolored Naturalness in Exotic Higgs Decays*, *JHEP* **12** (2015) 072 [[1506.06141](#)].
- [185] J. Liu, Z. Liu and L.-T. Wang, *Enhancing Long-Lived Particles Searches at the LHC with Precision Timing Information*, *Phys. Rev. Lett.* **122** (2019) 131801 [[1805.05957](#)].
- [186] J. Liu, Z. Liu, L.-T. Wang and X.-P. Wang, *Enhancing Sensitivities to Long-lived Particles with High Granularity Calorimeters at the LHC*, *JHEP* **11** (2020) 066 [[2005.10836](#)].
- [187] N. Arkani-Hamed, T. Cohen, R.T. D’Agnolo, A. Hook, H.D. Kim and D. Pinner, *Solving the Hierarchy Problem at Reheating with a Large Number of Degrees of Freedom*, *Phys. Rev. Lett.* **117** (2016) 251801 [[1607.06821](#)].
- [188] N. Arkani-Hamed, R. Tito D’agnolo and H.D. Kim, *The Weak Scale as a Trigger*, [2012.04652](#).
- [189] P. Meade and H. Ramani, *Unrestored Electroweak Symmetry*, *Phys. Rev. Lett.* **122** (2019) 041802 [[1807.07578](#)].
- [190] I. Baldes and G. Servant, *High scale electroweak phase transition: baryogenesis and symmetry non-restoration*, *JHEP* **10** (2018) 053 [[1807.08770](#)].
- [191] A. Glioti, R. Rattazzi and L. Vecchi, *Electroweak Baryogenesis above the Electroweak Scale*, *JHEP* **04** (2019) 027 [[1811.11740](#)].
- [192] O. Matsedonskyi and G. Servant, *High-Temperature Electroweak Symmetry Non-Restoration from New Fermions and Implications for Baryogenesis*, *JHEP* **09** (2020) 012 [[2002.05174](#)].
- [193] H. Chen, M.-X. Luo, I. Moulton, T.-Z. Yang, X. Zhang and H.X. Zhu, *Three point energy correlators in the collinear limit: symmetries, dualities and analytic results*, *JHEP* **08** (2020) 028 [[1912.11050](#)].

- [194] H. Chen, I. Moulton, X. Zhang and H.X. Zhu, *Rethinking jets with energy correlators: Tracks, resummation, and analytic continuation*, *Phys. Rev. D* **102** (2020) 054012 [2004.11381].
- [195] ALEPH, DELPHI, L3, OPAL, SLD, LEP ELECTROWEAK WORKING GROUP, SLD ELECTROWEAK GROUP, SLD HEAVY FLAVOUR GROUP collaboration, *Precision electroweak measurements on the Z resonance*, *Phys. Rept.* **427** (2006) 257 [hep-ex/0509008].
- [196] ALEPH, DELPHI, L3, OPAL, LEP ELECTROWEAK collaboration, *Electroweak Measurements in Electron-Positron Collisions at W-Boson-Pair Energies at LEP*, *Phys. Rept.* **532** (2013) 119 [1302.3415].
- [197] K. Yokoya, K. Kubo and T. Okugi, *Operation of ILC250 at the Z-pole*, 1908.08212.
- [198] A. Djouadi, G. Moreau and F. Richard, *Resolving the $A(FB)^{**}b$ puzzle in an extra dimensional model with an extended gauge structure*, *Nucl.Phys.* **B773** (2007) 43 [hep-ph/0610173].
- [199] G. Moortgat-Pick, T. Abe, G. Alexander, B. Ananthanarayan, A. Babich et al., *The Role of polarized positrons and electrons in revealing fundamental interactions at the linear collider*, *Phys.Rept.* **460** (2008) 131 [hep-ph/0507011].
- [200] C.R. Schmidt, *Top quark production and decay at next-to-leading order in e^+e^- annihilation*, *Phys.Rev.* **D54** (1996) 3250 [hep-ph/9504434].
- [201] A. Irlles, “Quark Pair Production at Lepton Colliders: Experimental challenges.”
- [202] S. Funatsu, H. Hatanaka, Y. Hosotani and Y. Orikasa, *Distinct signals of the gauge-Higgs unification in e^+e^- collider experiments*, *Phys. Lett.* **B775** (2017) 297 [1705.05282].
- [203] J. Yoon and M.E. Peskin, *Fermion Pair Production in $SO(5) \times U(1)$ Gauge-Higgs Unification Models*, 1811.07877.
- [204] S. Funatsu, H. Hatanaka, Y. Hosotani, Y. Orikasa and N. Yamatsu, *Fermion pair production at e^-e^+ linear collider experiments in GUT inspired gauge-Higgs unification*, *Phys. Rev. D* **102** (2020) 015029 [2006.02157].
- [205] Y. Deguchi, H. Yamashiro, T. Suehara, T. Yoshioka, K. Fujii and K. Kawagoe, *Study of fermion pair events at the 250 GeV ILC*, in *International Workshop on Future Linear Colliders*, 2, 2019 [1902.05245].
- [206] D. Jeans and K. Yumino, *ILD benchmark: a study of $e^-e^+ \rightarrow \tau^-\tau^+$ at 500 GeV*, 1912.08403.
- [207] The ATLAS Collaboration, *Measurement of the top quark mass in the $t\bar{t} \rightarrow$ lepton+jets channel from $\sqrt{s} = 8$ TeV ATLAS data and combination with previous results*, *Eur. Phys. J. C* **79** (2019) 290 [1810.01772].
- [208] ATLAS, CDF, CMS, D0 collaboration, *First combination of Tevatron and LHC measurements of the top-quark mass*, 1403.4427.

- [209] TEVATRON ELECTOWEAK WORKING GROUP (CDF AND D0 COLLABORATIONS) collaboration, *Combination of CDF and D0 results on the mass of the top quark using up 9.7 fb^{-1} at the Tevatron*, [1608.01881](#).
- [210] PARTICLE DATA GROUP collaboration, *Review of Particle Physics*, *PTEP* **2020** (2020) [083C01](#).
- [211] ATLAS collaboration, *Measurement of the top-quark mass in $t\bar{t} + 1$ -jet events collected with the ATLAS detector in pp collisions at $\sqrt{s} = 8 \text{ TeV}$* , *JHEP* **11** (2019) 150 [[1905.02302](#)].
- [212] A. G., B.A. I., B. O., F. P., L. M., R. L. et al., *High-Luminosity Large Hadron Collider (HL-LHC): Technical Design Report V. 0.1*, CERN Yellow Reports: Monographs, CERN, Geneva (2017), [10.23731/CYRM-2017-004](#).
- [213] P. Azzi et al., *Report from Working Group 1: Standard Model Physics at the HL-LHC and HE-LHC*, *CERN Yellow Rep. Monogr.* **7** (2019) 1 [[1902.04070](#)].
- [214] T. Ježo, J.M. Lindert, P. Nason, C. Oleari and S. Pozzorini, *An NLO+PS generator for $t\bar{t}$ and Wt production and decay including non-resonant and interference effects*, *Eur. Phys. J. C* **76** (2016) 691 [[1607.04538](#)].
- [215] S. Ferrario Ravasio, T. Ježo, P. Nason and C. Oleari, *A theoretical study of top-mass measurements at the LHC using NLO+PS generators of increasing accuracy*, *Eur. Phys. J. C* **78** (2018) 458 [[1906.09166](#)].
- [216] The ATLAS collaboration, *A precise interpretation for the top quark mass parameter in ATLAS Monte Carlo simulation*, *ATL-PHYS-PUB-2021-034* .
- [217] M. Butenschoen, B. Dehnadi, A.H. Hoang, V. Mateu, M. Preisser and I.W. Stewart, *Top Quark Mass Calibration for Monte Carlo Event Generators*, [1608.01318](#).
- [218] J. Kieseler, K. Lipka and S.-O. Moch, *Calibration of the Top-Quark Monte Carlo Mass*, *Phys. Rev. Lett.* **116** (2016) 162001 [[1511.00841](#)].
- [219] A.H. Hoang, *What is the Top Quark Mass?*, *Ann. Rev. Nucl. Part. Sci.* **70** (2020) 225 [[2004.12915](#)].
- [220] S. Gusken, J.H. Kuhn and P.M. Zerwas, *Threshold Behavior of Top Production in e^+e^- Annihilation*, *Phys. Lett.* **B155** (1985) 185.
- [221] M.J. Strassler and M.E. Peskin, *The Heavy top quark threshold: QCD and the Higgs*, *Phys. Rev. D* **43** (1991) 1500.
- [222] A.H. Hoang, A.V. Manohar, I.W. Stewart and T. Teubner, *The Threshold $t\bar{t}$ cross-section at NNLL order*, *Phys. Rev.* **D65** (2002) 014014 [[hep-ph/0107144](#)].
- [223] P. Marquard, A.V. Smirnov, V.A. Smirnov and M. Steinhauser, *Quark Mass Relations to Four-Loop Order in Perturbative QCD*, *Phys. Rev. Lett.* **114** (2015) 142002 [[1502.01030](#)].

- [224] CLICDP collaboration, *Top-Quark Physics at the CLIC Electron-Positron Linear Collider*, *JHEP* **11** (2019) 003 [[1807.02441](#)].
- [225] K. Seidel, F. Simon, M. Tesar and S.p. Poss, *Top quark mass measurements at and above threshold at CLIC*, *Eur. Phys. J. C* **73** (2013) 2530 [[1303.3758](#)].
- [226] T. Horiguchi, A. Ishikawa, T. Suehara, K. Fujii, Y. Sumino, Y. Kiyo et al., *Study of top quark pair production near threshold at the ILC*, [1310.0563](#).
- [227] M. Martinez and R. Miquel, *Multiparameter fits to the $t\bar{t}$ threshold observables at a future e^+e^- linear collider*, *Eur. Phys. J. C* **27** (2003) 49 [[hep-ph/0207315](#)].
- [228] F. Simon, *A First Look at the Impact of NNNLO Theory Uncertainties on Top Mass Measurements at the ILC*, in *International Workshop on Future Linear Colliders (LCWS15) Whistler, B.C., Canada, November 2-6, 2015*, 2016, <https://inspirehep.net/record/1427722/files/arXiv:1603.04764.pdf> [[1603.04764](#)].
- [229] M. Vos et al., *Top physics at high-energy lepton colliders*, [1604.08122](#).
- [230] K. Nowak and A.F. Zarnecki, *Optimising top-quark threshold scan at CLIC using genetic algorithm*, *JHEP* **07** (2021) 070 [[2103.00522](#)].
- [231] M. Boronat, E. Fullana, J. Fuster, P. Gomis, A. Hoang, V. Mateu et al., *Top quark mass measurement in radiative events at electron-positron colliders*, *Phys. Lett. B* **804** (2020) 135353 [[1912.01275](#)].
- [232] F. Richard, *Present and future constraints on top EW couplings*, [1403.2893](#).
- [233] V. Miralles, M.M. López, M.M. Llácer, A. Peñuelas, M. Perelló and M. Vos, *The top quark electro-weak couplings after LHC Run 2*, [2107.13917](#).
- [234] M.S. Amjad et al., *A precise characterisation of the top quark electroweak vertices at the ILC*, *Eur. Phys. J. C* **75** (2015) 512 [[1505.06020](#)].
- [235] M.S. Amjad, M. Boronat, T. Frisson, I. Garcia, R. Poschl, E. Ros et al., *A precise determination of top quark electroweak couplings at the ILC operating at $\sqrt{s} = 500$ GeV*, [1307.8102](#).
- [236] G. Durieux, M. Perelló, M. Vos and C. Zhang, *Global and optimal probes for the top-quark effective field theory at future lepton colliders*, *JHEP* **10** (2018) 168 [[1807.02121](#)].
- [237] W. Bernreuther, L. Chen, I. García, M. Perelló, R. Poeschl, F. Richard et al., *CP-violating top quark couplings at future linear e^+e^- colliders*, *Eur. Phys. J. C* **78** (2018) 155 [[1710.06737](#)].
- [238] G. Durieux, A. Irles, V. Miralles, A. Peñuelas, R. Pöschl, M. Perelló et al., *The electro-weak couplings of the top and bottom quarks – Global fit and future prospects*, *JHEP* **12** (2019) 98 [[1907.10619](#)].

- [239] M. Cepeda et al., *Report from Working Group 2: Higgs Physics at the HL-LHC and HE-LHC*, *CERN Yellow Rep. Monogr.* **7** (2019) 221 [[1902.00134](#)].
- [240] G. Durieux, J. Gu, E. Vryonidou and C. Zhang, *Probing top-quark couplings indirectly at Higgs factories*, *Chin. Phys. C* **42** (2018) 123107 [[1809.03520](#)].
- [241] S. Jung, J. Lee, M. Perelló, J. Tian and M. Vos, *Higgs, top and electro-weak precision measurements at future e^+e^- colliders; a combined effective field theory analysis with renormalization mixing*, [2006.14631](#).
- [242] The ATLAS collaboration, *Sensitivity of searches for the flavour-changing neutral current decay $t \rightarrow qZ$ using the upgraded ATLAS experiment at the High Luminosity LHC*, *ATL-PHYS-PUB-2019-001* .
- [243] ATLAS COLLABORATION collaboration, *Expected sensitivity of ATLAS to FCNC top quark decays $t \rightarrow Zu$ and $t \rightarrow Hq$ at the High Luminosity LHC*, *ATL-PHYS-PUB-2016-019* .
- [244] G. Durieux, F. Maltoni and C. Zhang, *Global approach to top-quark flavor-changing interactions*, *Phys. Rev. D* **91** (2015) 074017 [[1412.7166](#)].
- [245] L. Shi and C. Zhang, *Probing the top quark flavor-changing couplings at CEPC*, *Chin. Phys. C* **43** (2019) 113104 [[1906.04573](#)].
- [246] J. de Blas et al., *The CLIC Potential for New Physics*, [1812.02093](#).
- [247] C.F. Dürig, *Measuring the Higgs Self-coupling at the International Linear Collider*, Ph.D. thesis, Hamburg U., Hamburg, 2016. 10.3204/PUBDB-2016-04283.
- [248] R. Frederix, S. Frixione, V. Hirschi, F. Maltoni, O. Mattelaer, P. Torrielli et al., *Higgs pair production at the LHC with NLO and parton-shower effects*, *Phys. Lett. B* **732** (2014) 142 [[1401.7340](#)].
- [249] A. Freitas et al., *Theoretical uncertainties for electroweak and Higgs-boson precision measurements at FCC-ee*, [1906.05379](#).
- [250] S. Jadach and M. Skrzypek, *QED challenges at FCC-ee precision measurements*, *Eur. Phys. J. C* **79** (2019) 756 [[1903.09895](#)].
- [251] J. Ablinger, J. Blümlein, A. De Freitas and K. Schönwald, *Subleading Logarithmic QED Initial State Corrections to $e^+e^- \rightarrow \gamma^*/Z^{0*}$ to $O(\alpha^6 L^5)$* , *Nucl. Phys. B* **955** (2020) 115045 [[2004.04287](#)].
- [252] G. Degrandi, S. Di Vita, J. Elias-Miro, J.R. Espinosa, G.F. Giudice, G. Isidori et al., *Higgs mass and vacuum stability in the Standard Model at NNLO*, *JHEP* **08** (2012) 098 [[1205.6497](#)].
- [253] F.L. Bezrukov and M. Shaposhnikov, *The Standard Model Higgs boson as the inflaton*, *Phys. Lett. B* **659** (2008) 703 [[0710.3755](#)].

- [254] F. Bezrukov and M. Shaposhnikov, *Standard Model Higgs boson mass from inflation: Two loop analysis*, *JHEP* **07** (2009) 089 [[0904.1537](#)].
- [255] P. Huang, A.J. Long and L.-T. Wang, *Probing the Electroweak Phase Transition with Higgs Factories and Gravitational Waves*, *Phys. Rev. D* **94** (2016) 075008 [[1608.06619](#)].
- [256] A. Adams, N. Arkani-Hamed, S. Dubovsky, A. Nicolis and R. Rattazzi, *Causality, analyticity and an IR obstruction to UV completion*, *JHEP* **10** (2006) 014 [[hep-th/0602178](#)].
- [257] G.N. Remmen and N.L. Rodd, *Consistency of the Standard Model Effective Field Theory*, *JHEP* **12** (2019) 032 [[1908.09845](#)].
- [258] B. Bellazzini and F. Riva, *New phenomenological and theoretical perspective on anomalous ZZ and Z γ processes*, *Phys. Rev. D* **98** (2018) 095021 [[1806.09640](#)].
- [259] Q. Bi, C. Zhang and S.-Y. Zhou, *Positivity constraints on aQGC: carving out the physical parameter space*, *JHEP* **06** (2019) 137 [[1902.08977](#)].
- [260] B. Fuks, Y. Liu, C. Zhang and S.-Y. Zhou, *Positivity in electron-positron scattering: testing the axiomatic quantum field theory principles and probing the existence of UV states*, *Chin. Phys. C* **45** (2021) 023108 [[2009.02212](#)].
- [261] J. Gu, L.-T. Wang and C. Zhang, *An unambiguous test of positivity at lepton colliders*, [2011.03055](#).
- [262] T. Cohen, N. Craig, X. Lu and D. Sutherland, *Is SMEFT Enough?*, *JHEP* **03** (2021) 237 [[2008.08597](#)].
- [263] I. Low, J. Lykken and G. Shaughnessy, *Have We Observed the Higgs (Imposter)?*, *Phys. Rev. D* **86** (2012) 093012 [[1207.1093](#)].
- [264] .A.G.-I.W.G. Advanced Accelerator Association, *Green-ilc report*, .
- [265] *How ess will become sustainable*, .
- [266] M. Aicheler, P. Burrows, M. Draper, T. Garvey, P. Lebrun, K. Peach et al., *A Multi-TeV Linear Collider Based on CLIC Technology*, .
- [267] E. Esarey, C.B. Schroeder and W.P. Leemans, *Physics of laser-driven plasma-based electron accelerators*, *Rev. Mod. Phys.* **81** (2009) 1229.
- [268] C.B. Schroeder, E. Esarey, C.G.R. Geddes, C. Benedetti and W.P. Leemans, *Physics considerations for laser-plasma linear colliders*, *Phys. Rev. ST Accel. Beams* **13** (2010) 101301.
- [269] C.B. Schroeder, C. Benedetti, E. Esarey and W.P. Leemans, *Laser-plasma-based linear collider using hollow plasma channels*, *Nucl. Instrum. Meth. A* **829** (2016) 113.
- [270] W. Leemans, ed., *Report of the Workshop on Laser Technology for k-BELLA and Beyond*, .

- [271] W. Gai, J.G. Power and C. Jing, *Short-pulse dielectric two-beam acceleration*, *J. Plasma Phys.* **78** (2012) 339.