



# Forward Tracking Performance

Marcel Vos – IFIC Valencia



# Forward physics

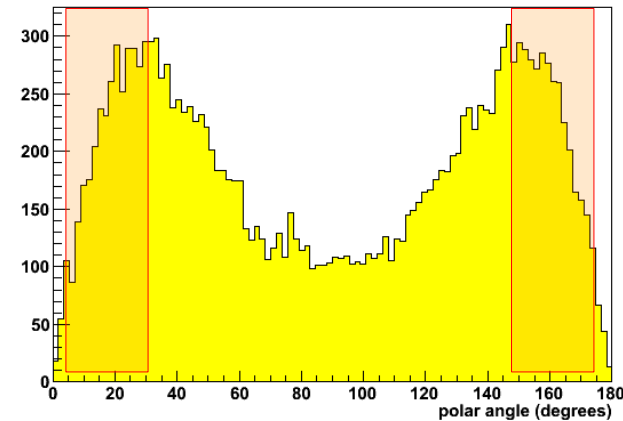
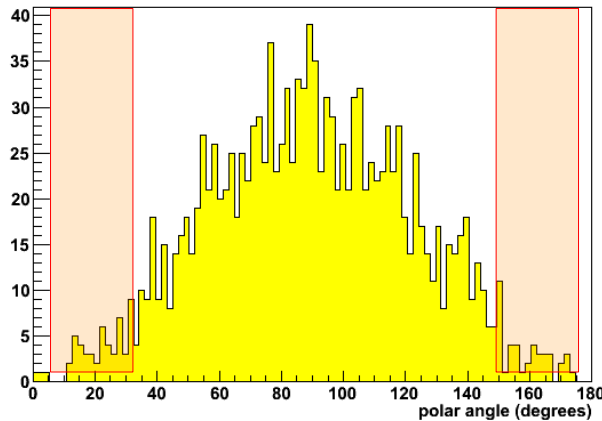
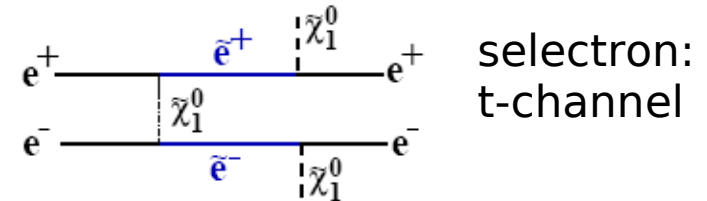
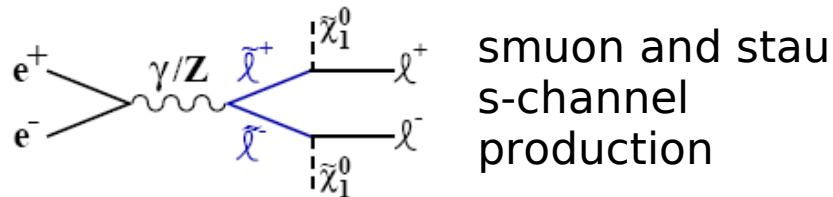

**Very forward physics:** selectron end-point reconstruction

see S. Gerbode et al., Snowmass 2005, H. Martyn, hep-ph/0408226, T. Barklow,

**Polar angle distribution:** For SPS1a t-channel selectron pair production @ 500 GeV (1 TeV), 24 % (50 %) of selectrons has  $\theta < 30^\circ$

## Very forward physics

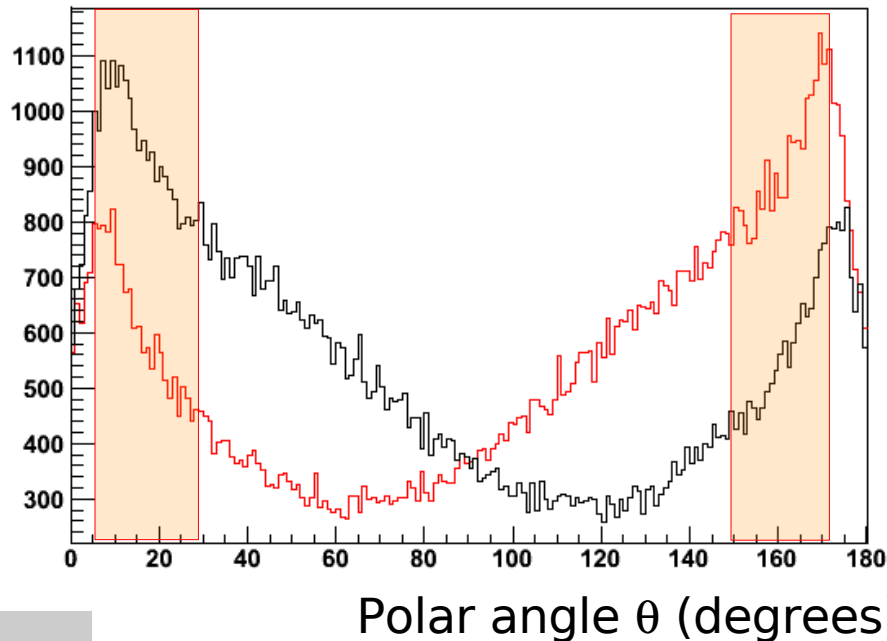

Standard Model charm  
quark and anti-quark  
production vs polar angle.

200.000 events.

### \* $A_{FB}$ in the cc system

see M. Battaglia, ILD meeting, Zeuthen.

\* **Sensitive probe of forward vertexing performance**

\* **Polar angle distribution:** most of the statistics is in the forward tracker  
(the sensitivity to new physics is not necessarily in this region, though)

# Forward tracking: interplay with central tracker

**(Very) forward tracker in a gaseous + silicon tracker concept is “all-silicon”**

For track polar angles below  $40^\circ$  reduced TPC coverage

Below  $\sim 30^\circ$  FTD starts to contribute

Below  $\sim 20^\circ$  FTD dominates the measurements

TPC/FTD hits vs. polar angle Large Detector Concept (Tesla layout of FTD)

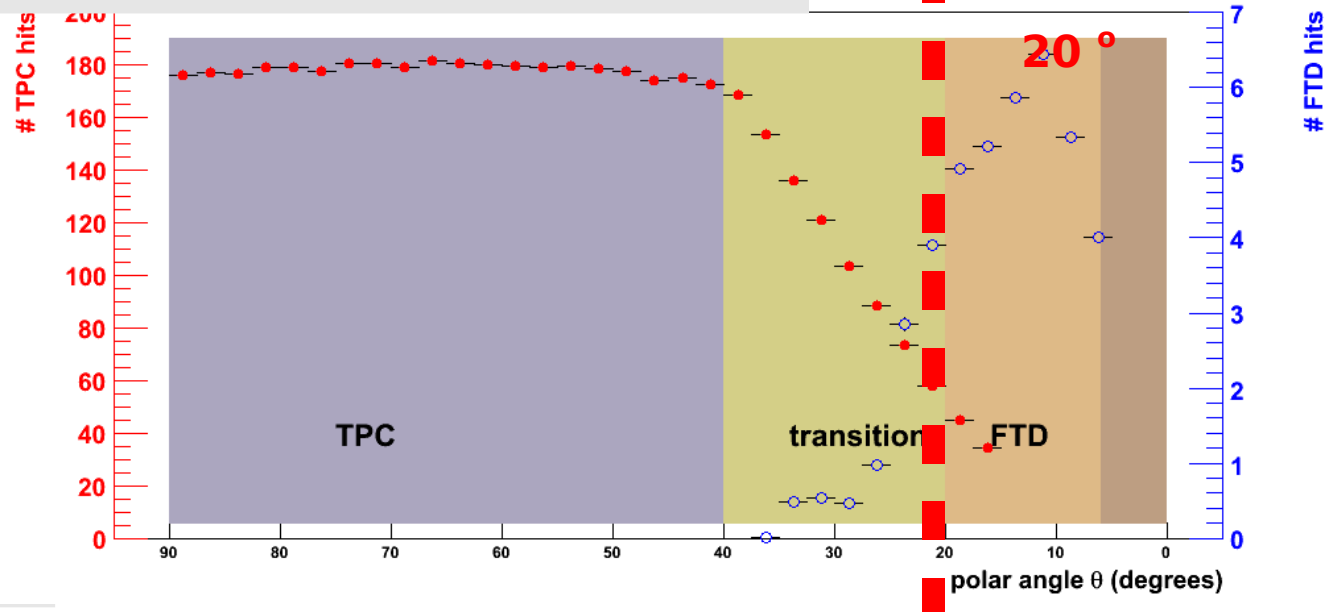
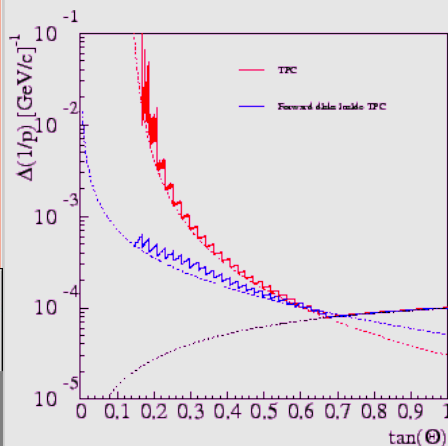

## Environment – machine bkg.

**Incoherent pair production off beamstrahlung photons yields very significant hit densities in forward tracker:**

**$1-2 \times 10^{-4}$  hits/mm<sup>2</sup>/BX**

in nominal conditions in the first three disks

- a large fraction (40-45%) of hits is indirect.
- strong dependence on machine parameters ( factor 2 ), and ILC energy (factor 2)
- distance to accumulation zone minimal for disk 2
- magnetic field yields factor  $\sim 2 / 0.5$  Tesla

Occupancy in inner ring of the disks is factor 5 larger than disk average.

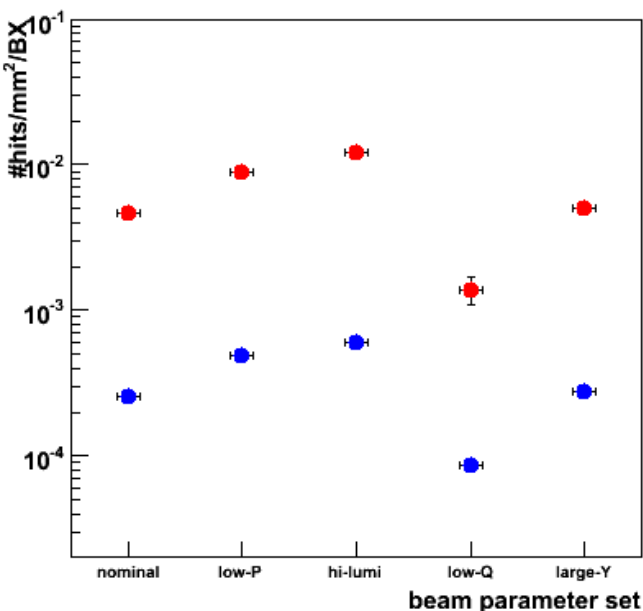

Hit density vs distance for three machine parameter sets.

Hit density in LDC FTD 2 for different FF parametersets.

**LDC forward tracker:**

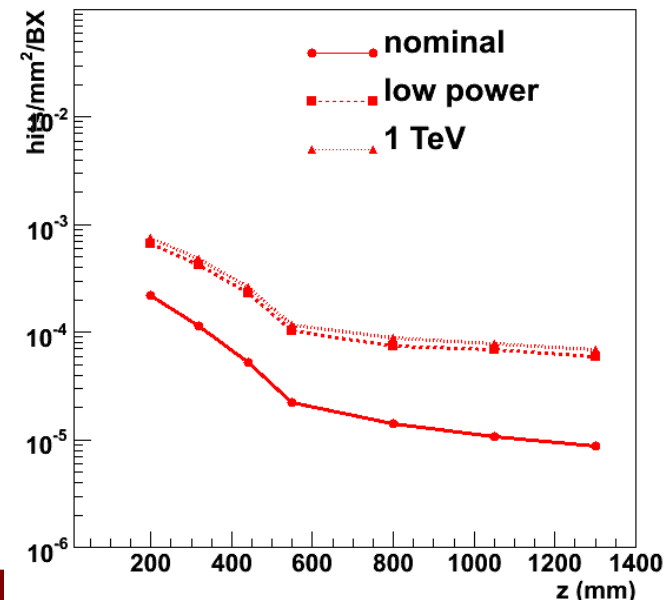

## Tools – track fitting

### CMS Kalman filter tool-kit.

The result of years of work by a lot of people. Validated in large-scale MC productions.

Extracted all relevant code in a series of libraries with limited external dependencies (CLHEP, ROOT).

Interfaced to toy geometries in standalone programme. Tested results for internal consistency and against existing fast-simulation packages.

Interfaced to MarlinReco (GEAR geometry, LCIO hits)

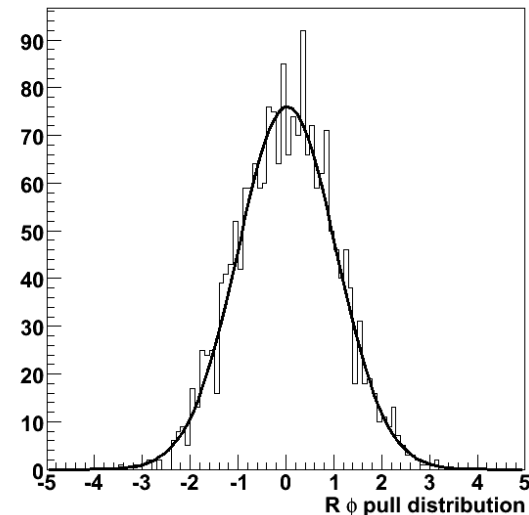

pull distribution  $R\phi$  coordinate at last measurement plane

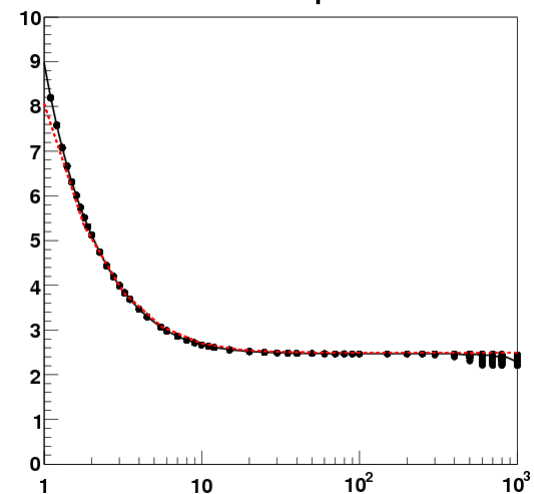

LCDTRK vs. KF: Transverse impact parameter resolution vs  $p_T$

# Momentum resolution II

$\Delta(1/p_T)$  @ 10 degrees :

**Reference (TESLA) set-up**

$$1.8 \times 10^{-3} \oplus 1.3 \times 10^{-2} / p_T$$

**Challenging setup**

(5  $\mu$  m R $\phi$  resolution, 1.2 ‰ X0/disk for FTD1-3, 4 ‰ X0/disk for FTD4-7)

$$\Delta(1/p_T) = 0.9 \times 10^{-3} \oplus 0.8 \times 10^{-2} / p_T$$

Detector	R $\phi$ ( $\mu$ m)	z/R ( $\mu$ m)	Material (% X <sub>0</sub> )
VXD	5	5	0.12/layer
FTD1-3	10	50	1.2/layer
FTD4-7	10	1000	0.8/layer
TPC	120	300	1 (field cage)

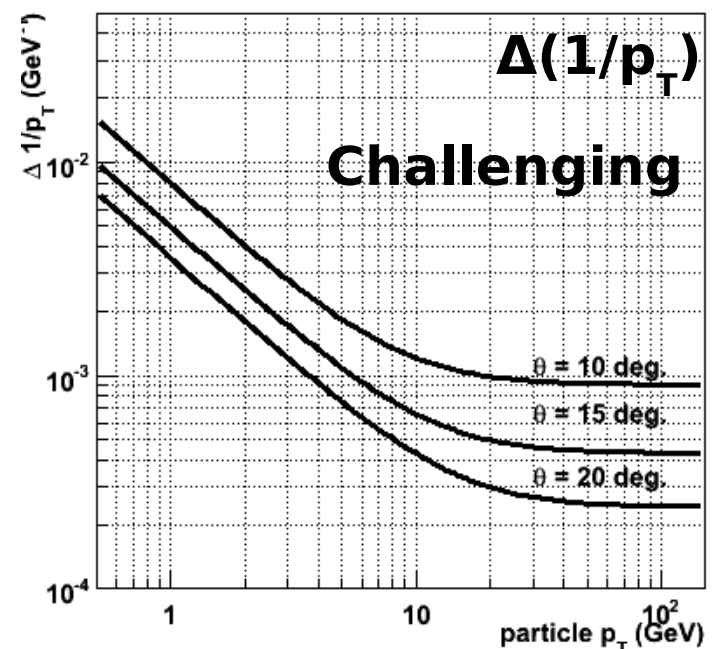
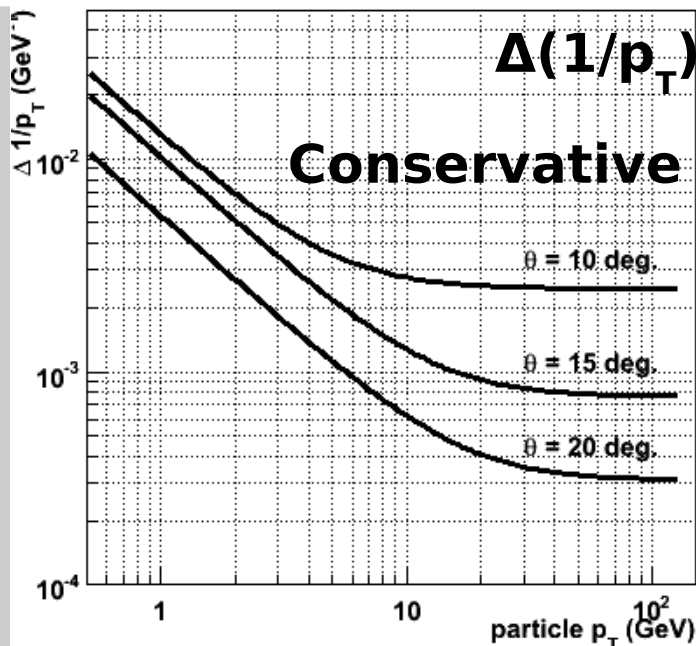

# Momentum resolution II

$\Delta(1/p_T)$  @ 10 degrees :

Reference (TESLA) set-up

$$1.8 \times 10^{-3} \oplus 1.3 \times 10^{-2} / p_T$$

Challenging setup

(5  $\mu$  m R $\phi$  resolution, 1.2 ‰ X0/disk for FTD1-3, 4 ‰ X0/disk for FTD4-7)

$$\Delta(1/p_T) = 0.9 \times 10^{-3} \oplus 0.8 \times 10^{-2} / p_T$$

Detector	R $\phi$ ( $\mu$ m)	z/R ( $\mu$ m)	Material (% X <sub>0</sub> )
VXD	5	5	0.12/layer
FTD1-3	10	50	1.2/layer
FTD4-7	10	1000	0.8/layer
TPC	120	300	1 (field cage)

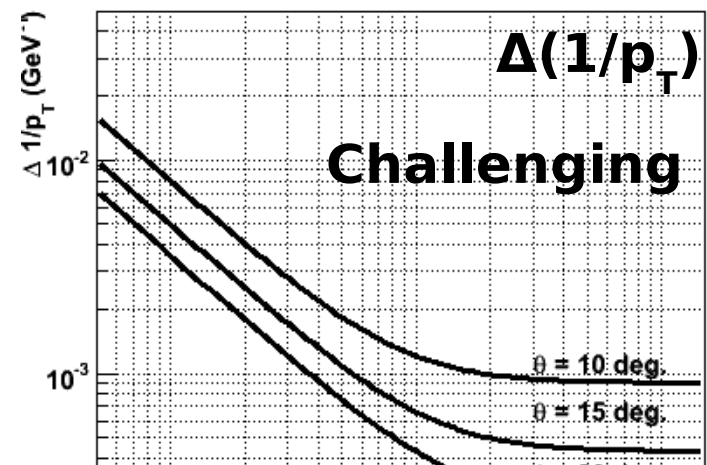
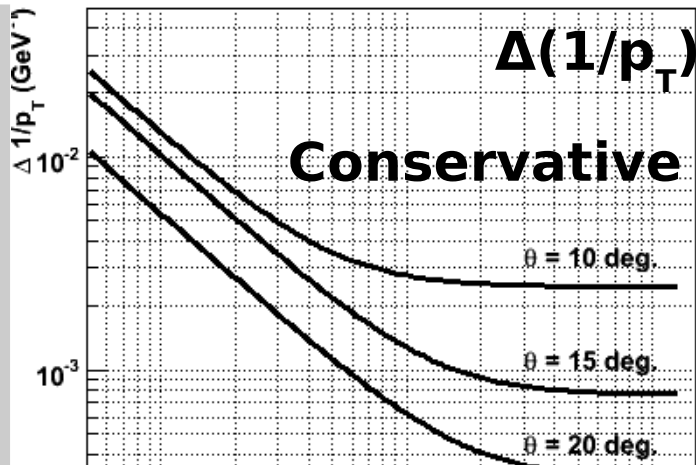

**Excellent R- $\phi$  space point resolution crucial for asymptotic momentum resolution**



# Momentum resolution III

<-- GLD FIT 203 mm -->

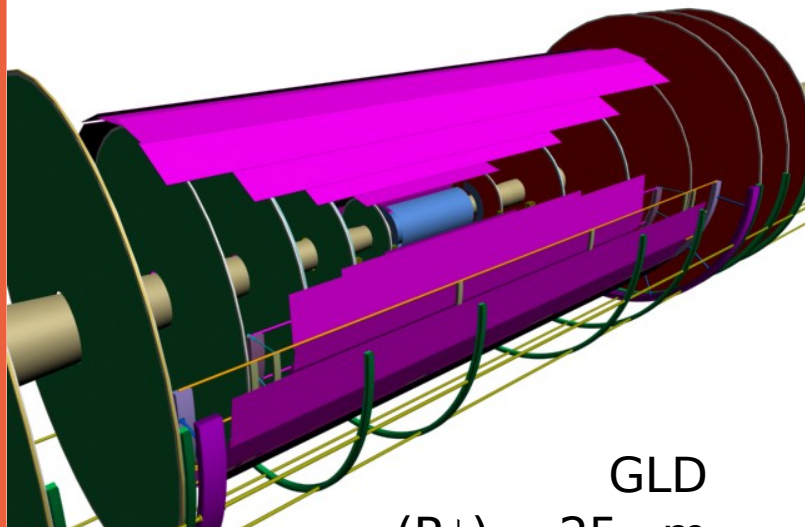

GLD  
 $\sigma(R\phi) = 25 \mu\text{m}$   
( $z=155\dots1015 \text{ mm}$ )  
Forward Inner Tracker

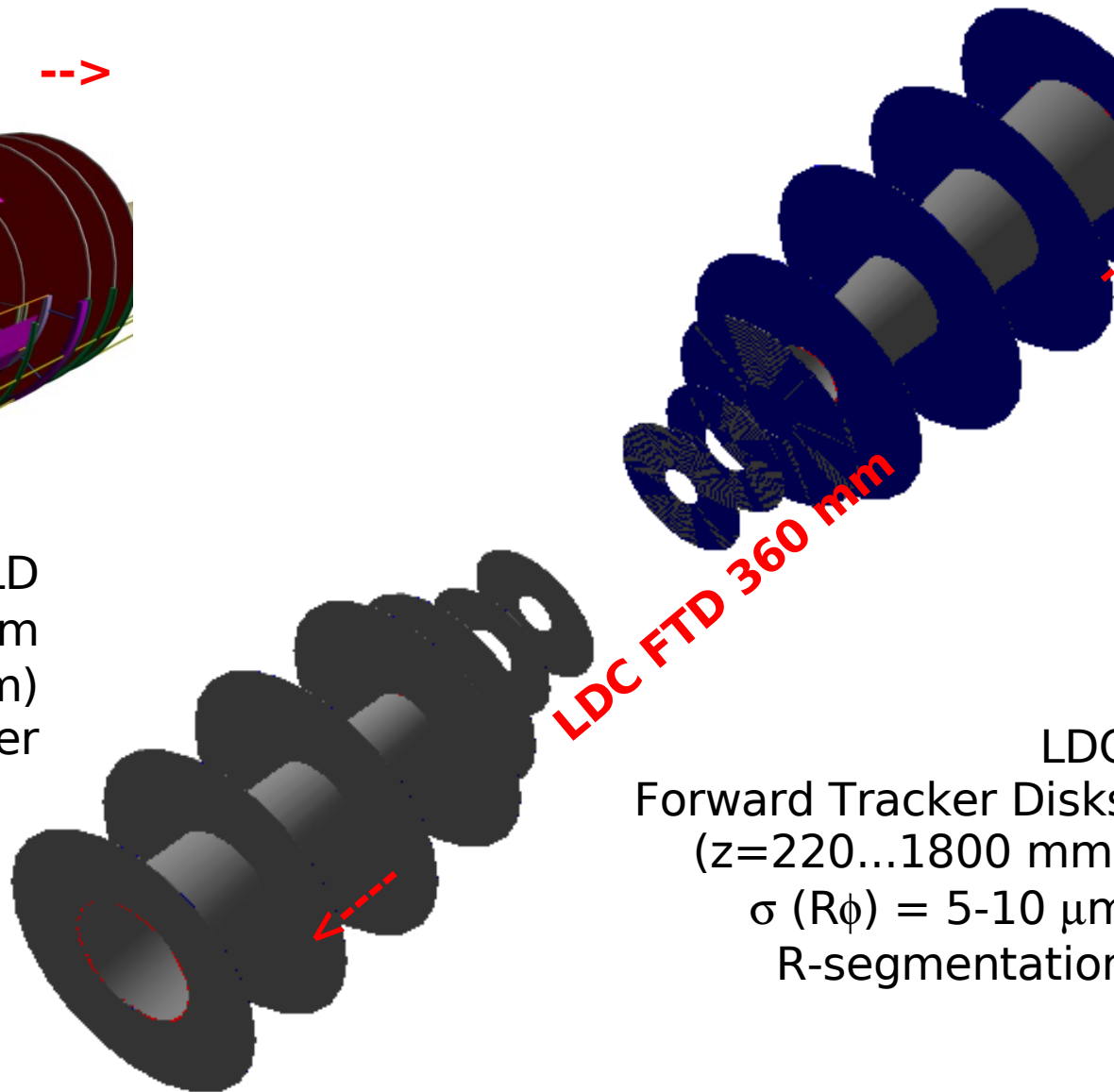

LDC FTD 360 mm

LDC  
Forward Tracker Disks  
( $z=220\dots1800 \text{ mm}$ )  
 $\sigma(R\phi) = 5-10 \mu\text{m}$   
R-segmentation

## Momentum resolution III

<-- GLD FIT 203 mm -->

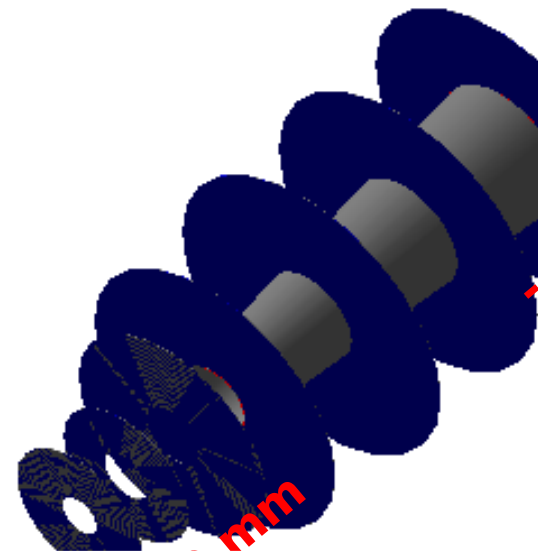
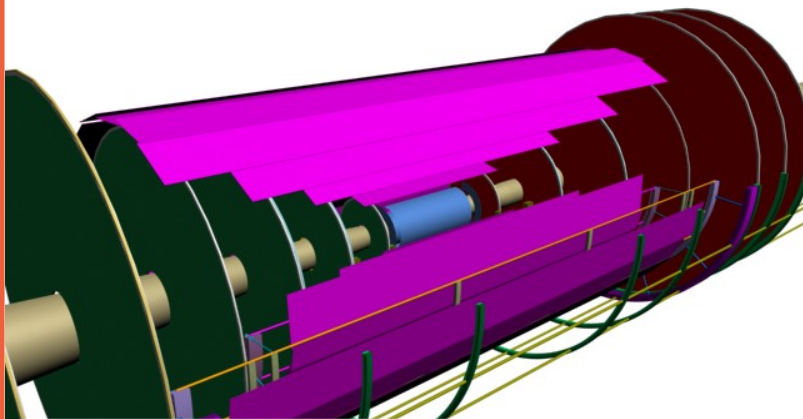

***Ultimate momentum resolution requires full lever arm,*** but pattern recognition favours small inter-disk distance... discussion within silicon tracker community

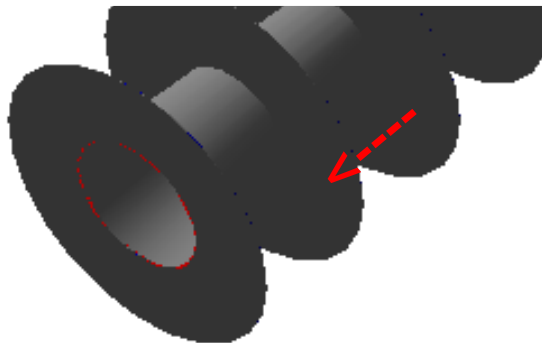

...DC  
Forward Tracker Disks  
( $z=220\dots1800$  mm)  
 $\sigma(R\phi) = 5-10 \mu\text{m}$   
R-segmentation

# Forward Tracking: interplay with VXD

Concept	Magnetic Field	Angular Coverage	
		5-point	3-point
SiD	5 T	12.5 (43 barrel)	9
LDC	4 T	26	19
GLD	3T	26 (6 points)	18 (4 barrel + 2 disk)

Long barrel layout (LDC, GLD) has limited coverage for angular region from  $7^\circ$  to  $25^\circ$

## (Very) forward tracking with a “Long barrel” vertex detector

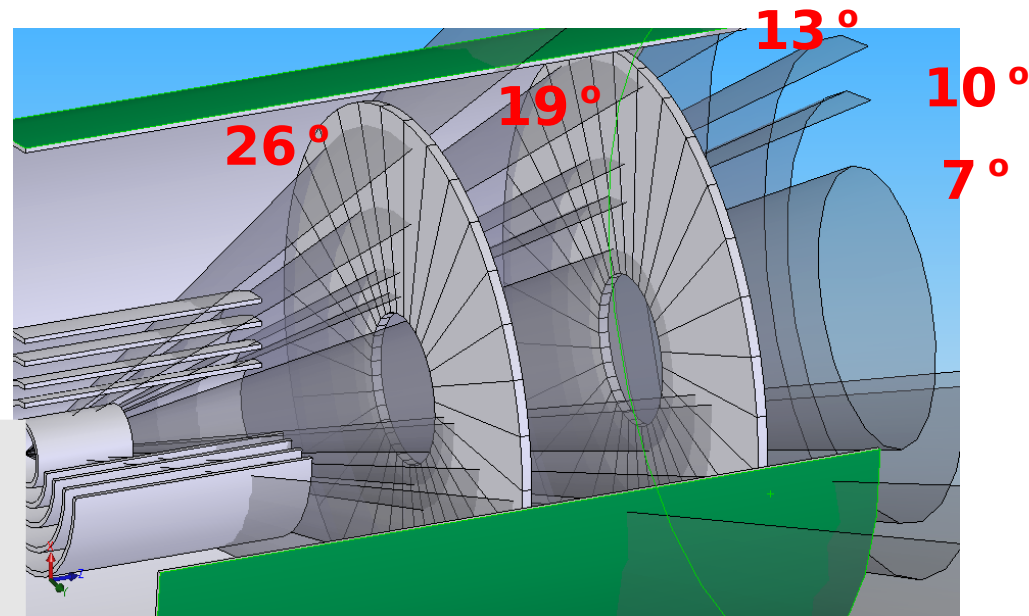
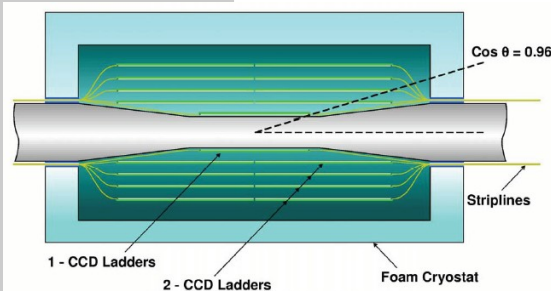

### LDC inner tracker layout:

- VXD (cylinders)
- SIT (green)
- FTD disk 1 and 2

# Vertexing with forward tracks

* I	35	$< \theta < 90$	5 VXD + SIT	* IV	12.5	$< \theta < 18.5$	VXD2 + FTD
* II	25.8	$< \theta < 35$	5 VXD + FTD1	* V	10	$< \theta < 12.5$	FTD1,...
* III	18.5	$< \theta < 25.8$	3 VXD + FTD1+2	* VI	6.5	$< \theta < 10.0$	FTD2,...

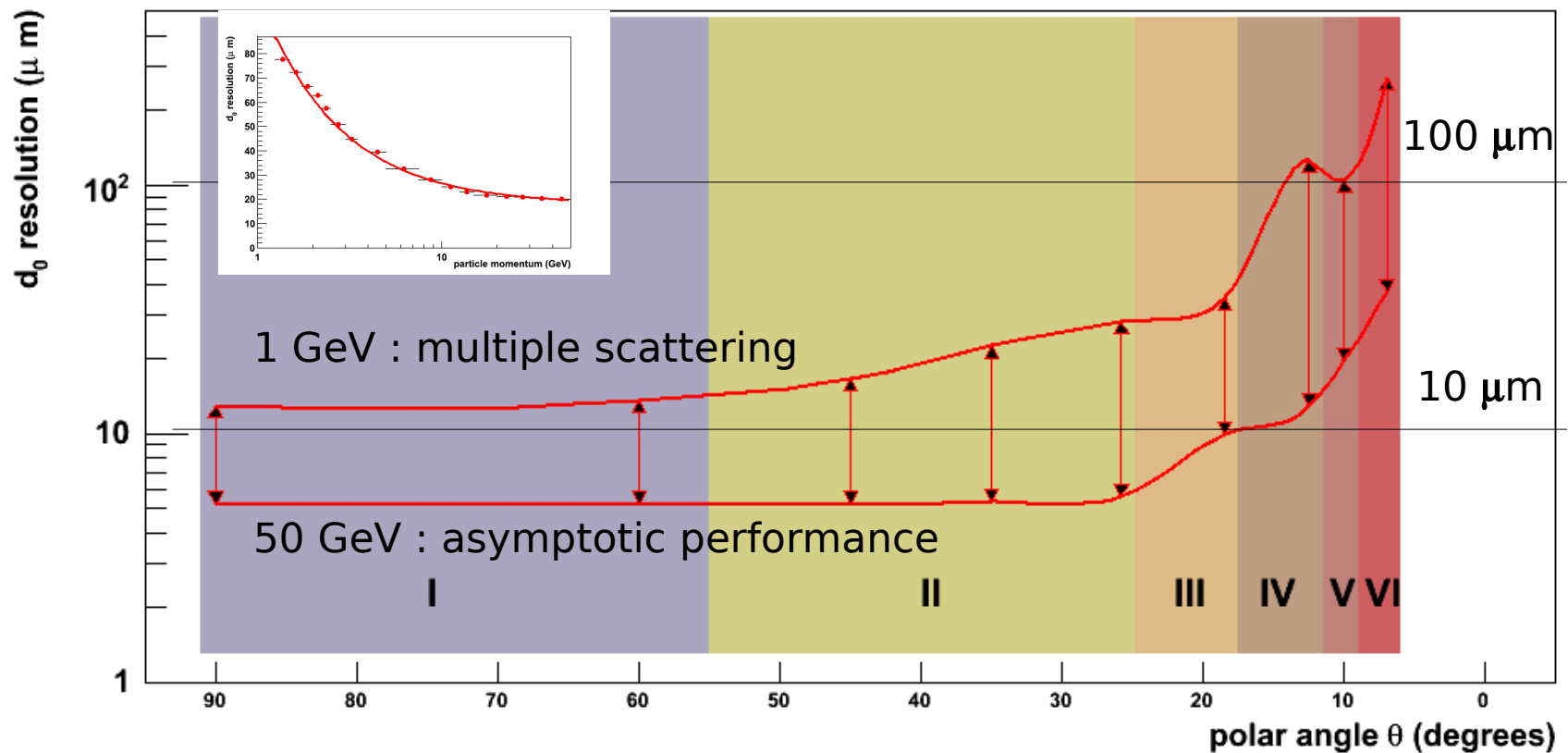

# Vertexing with forward tracks

* I	35	$< \theta < 90$	5 VXD + SIT	* IV	12.5	$< \theta < 18.5$	VXD2 + FTD
* II	25.8	$< \theta < 35$	5 VXD + FTD1	* V	10	$< \theta < 12.5$	FTD1,...
* III	18.5	$< \theta < 25.8$	3 VXD + FTD1+2	* VI	6.5	$< \theta < 10.0$	FTD2,...

$d_0$  resolution well below the  $c\tau$  of B-hadrons possible in a “long barrel” VXD layout, provided:

- very little material in/before first tracking disk,
- excellent  $R\phi$  resolution,
- smallest possible z-distance first disk.

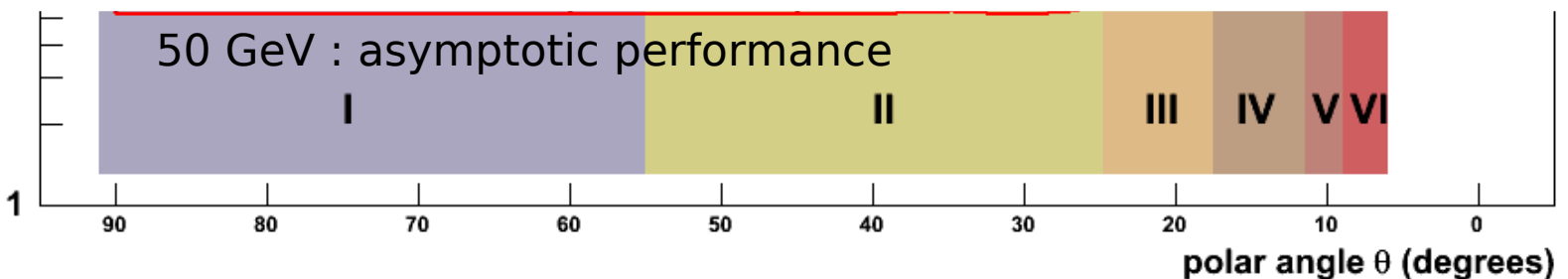

# ● Pattern recognition

For very forward tracks ( $\theta < 20^\circ$ ) **FTD has to be capable of stand-alone pattern recognition** with 7 space points over nearly 2 m, compared to:

central track in LDC: 5-6 VXD + 2-4 SIT + O(200) TPC

forward region in SiD: 4 VXD + 5  $\mu$ -strips.

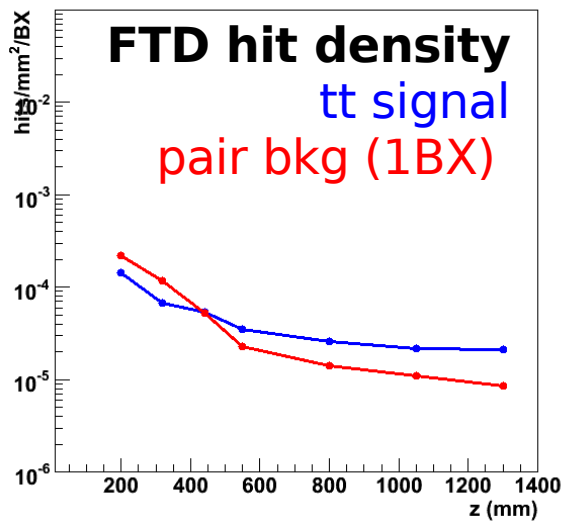

Moderate average occupancy, but...  
peak density much larger:  
Signal (jets):.....  
.....factor 100  
Bkg (inner ring):.....  
.....factor 5

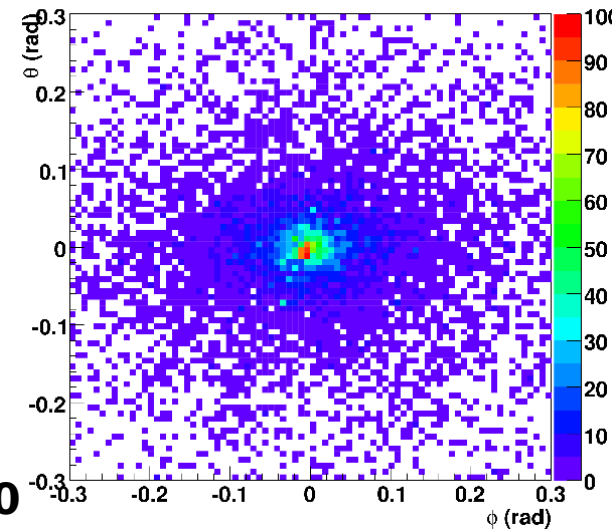

## ● Pattern recognition

For very forward tracks ( $\theta < 20^\circ$ ) **FTD has to be capable of stand-alone pattern recognition** with 7 space points over nearly 2 m, compared to:

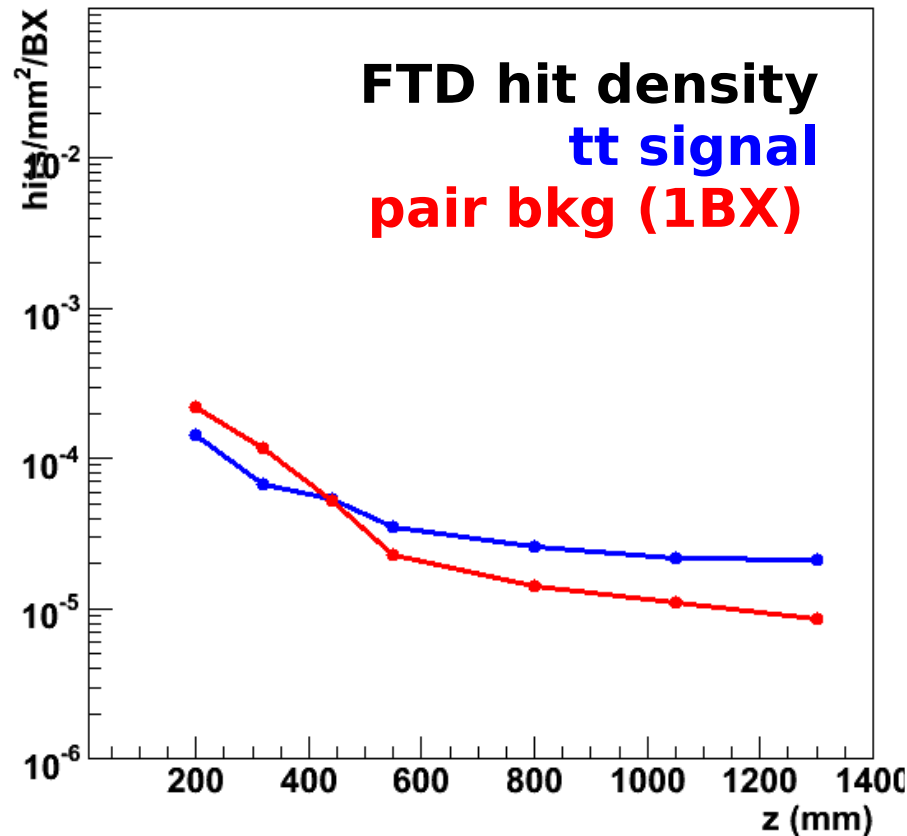

*Significant background:  
hit density due to a  
single BX comparable  
to that of a tt-event*

## ● Pattern recognition

For very forward tracks ( $\theta < 20^\circ$ ) **FTD has to be capable of stand-alone pattern recognition** with 7 space points over nearly 2 m, compared to:

*Moderate average occupancy, but... peak density much larger:*

Signal (jets):..... x 100

Bkg (inner ring):.... x 5

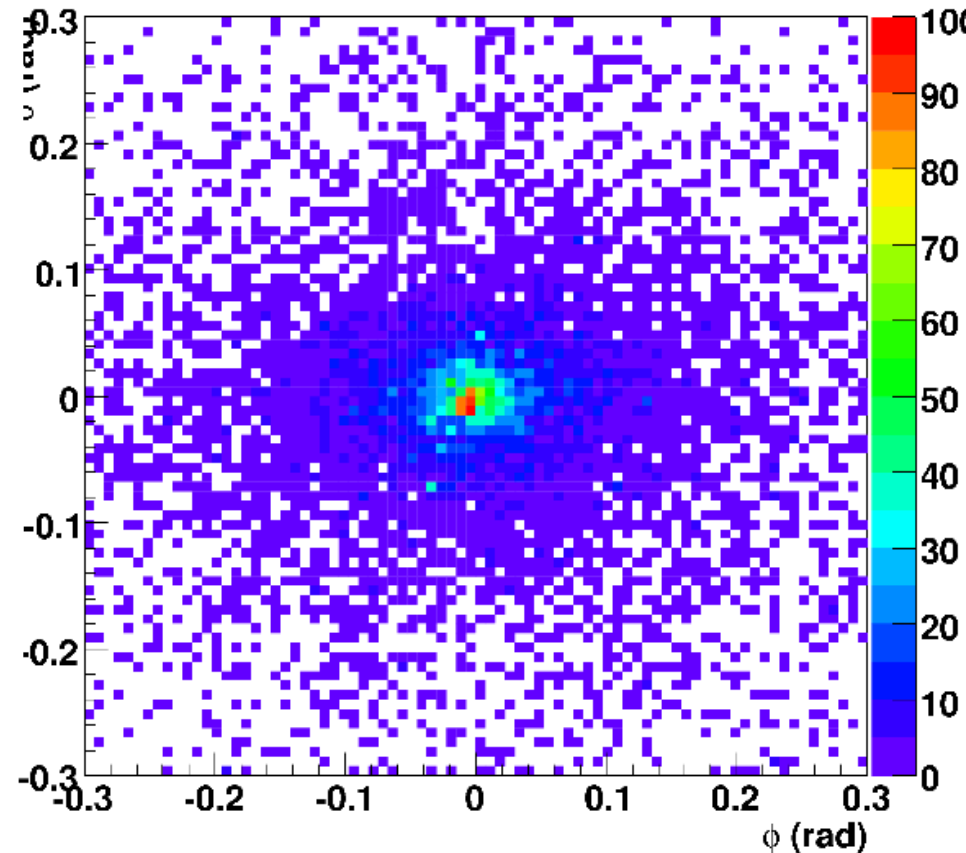



## ● Pattern recognition

### Integrating/Time slicing detector: Rolling Shutter read-out

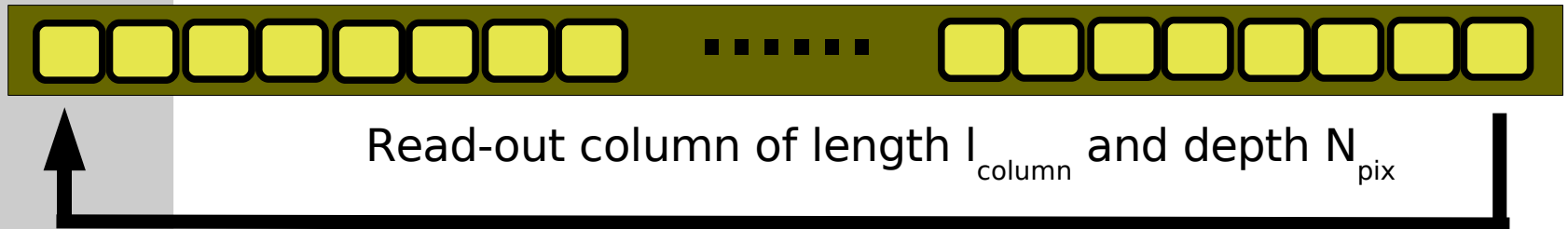

For pixel size (along the column direction)  $d$  and a read-out time per pixel  $t_{\text{pix}}$  the integration time to read a complete frame is given by:

$$t_{\text{frame}} = t_{\text{pix}} \times N = t_{\text{pix}} \times l_{\text{column}} / d$$

## ● Pattern recognition

### Integrating/Time slicing detector: Rolling Shutter read-out

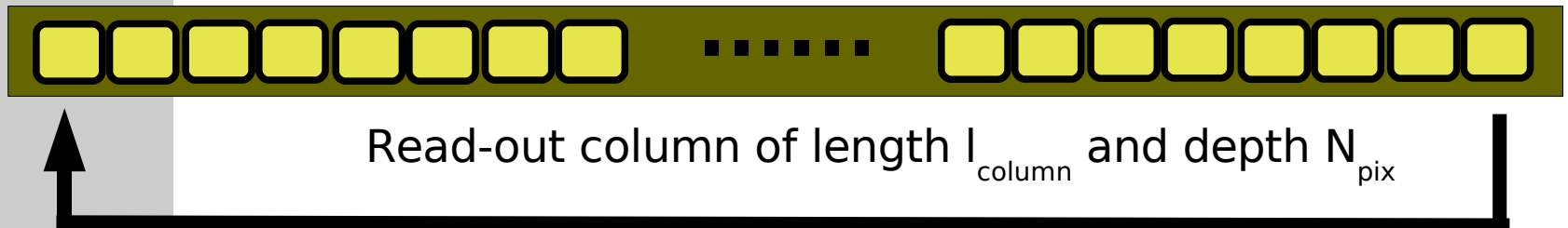

For pixel size (along the column direction)  $d$  and a read-out time per pixel  $t_{\text{pix}}$  the integration time to read a complete frame is given by:

$$t_{\text{frame}} = t_{\text{pix}} \times N = t_{\text{pix}} \times l_{\text{column}} / d$$

**Pixel read-out time constrained by technology**  
**R&D is the only way to bring it down**

## ● Pattern recognition

### Integrating/Time slicing detector: Rolling Shutter read-out

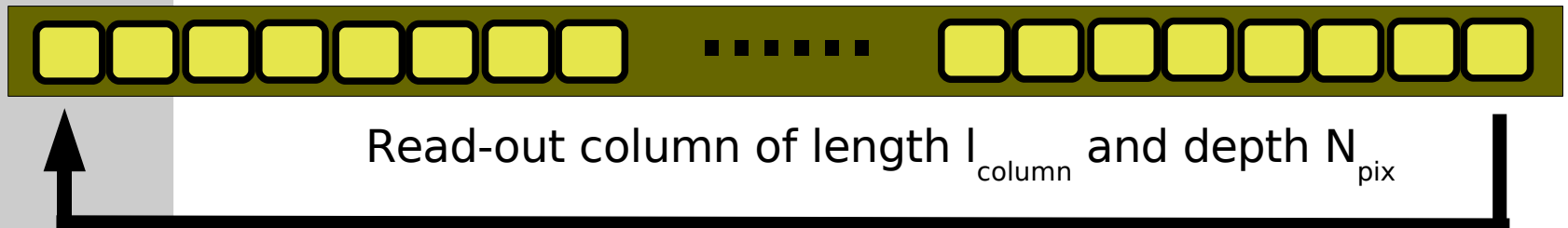

For pixel size (along the column direction)  $d$  and a read-out time per pixel  $t_{\text{pix}}$  the integration time to read a complete frame is given by:

$$t_{\text{frame}} = t_{\text{pix}} \times N = t_{\text{pix}} \times \frac{l_{\text{column}}}{d}$$

**Column length tightly linked to detector layout, keep the material and power consumption minimal**

## ● Pattern recognition

### Integrating/Time slicing detector: Rolling Shutter read-out

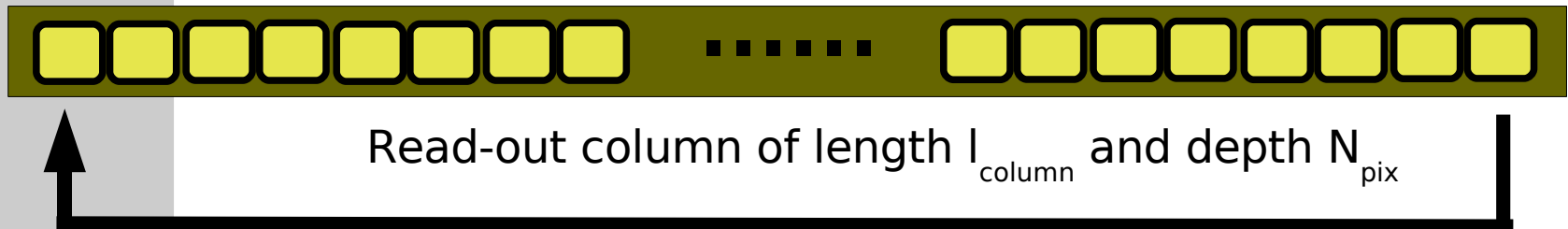

For pixel size (along the column direction)  $d$  and a read-out time per pixel  $t_{\text{pix}}$  the integration time to read a complete frame is given by:

$$t_{\text{frame}} = t_{\text{pix}} \times N = t_{\text{pix}} \times l_{\text{column}} / d$$

**Pixel size determines spatial resolution tightly constrained in VXD z- and R-resolution in tracker**

## ● Pattern recognition : connect the dots

### Under variations of the pixel size (with fixed column length and pixel read-out time):

- the (dominant) background occupancy is constant
- the number of hits (per area)  $\propto t_{\text{frame}}$ , i.e.  $1/d$

# 14 BX

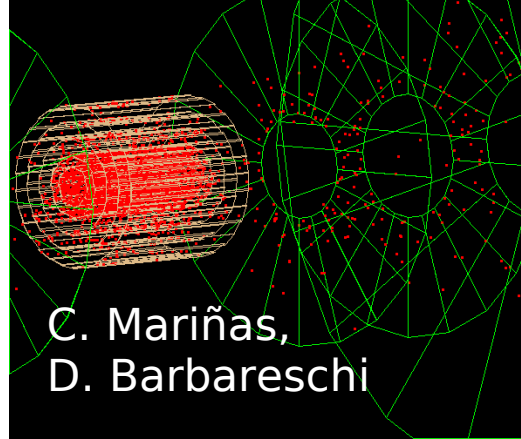

C. Mariñas,  
D. Barbareschi

# 140 BX

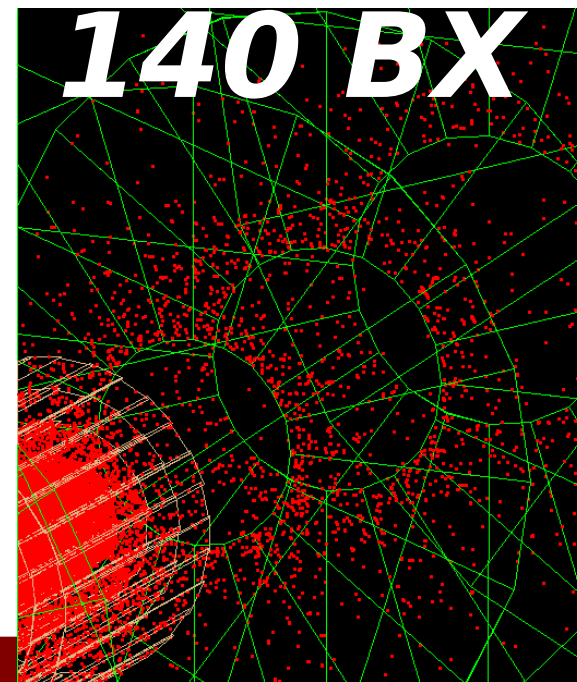

Technology	Cell area ( $\mu\text{m} \times \mu\text{m}$ )	Integration time	Peak occupancy
VXD	25 x 25	50 $\mu\text{s}$	$6 \times 10^{-6} + 1 \times 10^{-6}/\text{BX}$
Hybrid pixel	50 x 500	300 ns	$2 \times 10^{-4} + 4 \times 10^{-5}/\text{BX}$
$\mu$ -strip	$50 \times 10^5$	$50 \times 10^5$	5% + 1%/BX

Typical occupancies on first FTD disks (signal + bkg/BX)

## ● Pattern recognition: full simulation/reconstrucion

### **Combinatorial algorithm based on KF kit**

The baseline algorithm of the ATLAS (arXiv:0707:3071)  
and CMS (NIM A 559 143) experiments

### **Standalone FTD reconstruction implemented in MarlinReco processor**

### **Run on tt events with superposed pair background.**

Reference FTD (TESLA layout)

10  $\mu\text{m}$  R- $\phi$  resolution

1.2 %  $X_0/\text{disk}$  (1-3) and 0.8 %  $X_0/\text{disk}$  (4-7).

Several scenarios for R-resolution, from pixel to single-sided strip.



# ● Pattern recognition: quality markers

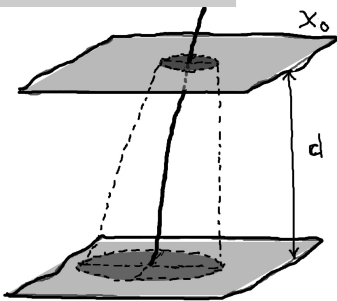

Compatibility of track stub and hit. Extrapolated window is a function of track parameter errors, material (multiple Coulomb scattering) and distance between disks.

## Extrapolation precision

### Innermost disks

R very precise (pixel detectors)  
R  $\phi$   $\rightarrow$  weakly constrained  $p_T$

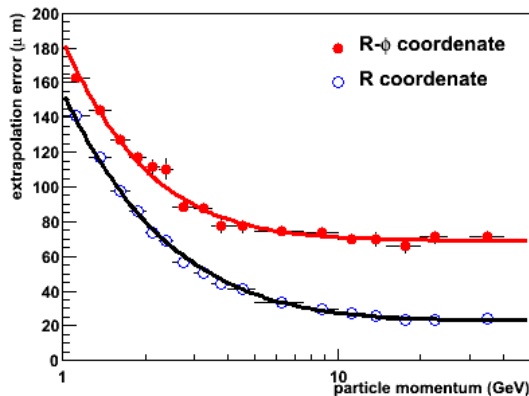

### Outermost disks

R degraded (single sided strips)  
R  $\phi$   $\rightarrow$  OK

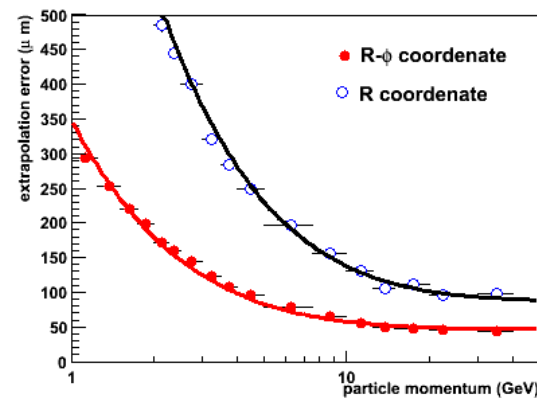

## ● Pattern recognition: quality markers

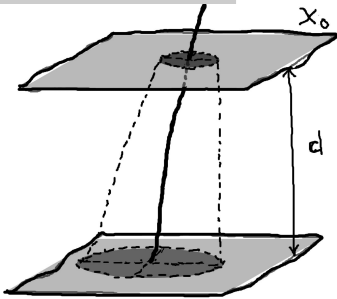

Compatibility of track stub and hit. Extrapolated window is a function of track parameter errors, material (multiple Coulomb scattering) and distance between disks.

***Large distance (10-30 cm) between Forward Tracking Disks, in combination with abundant low momentum tracks (loopers), lead to large extrapolation errors***

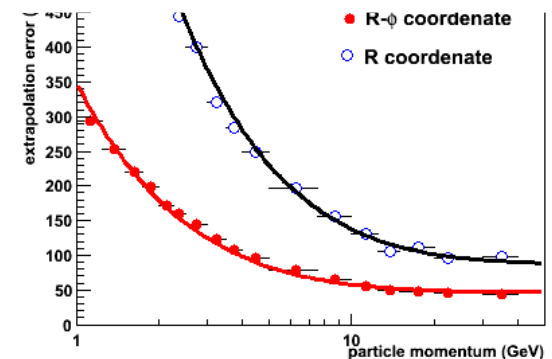
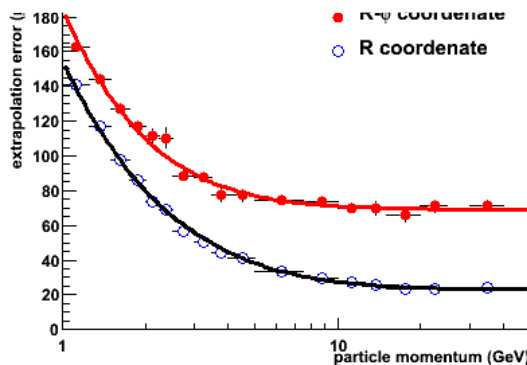



# ● Pattern recognition: quality markers

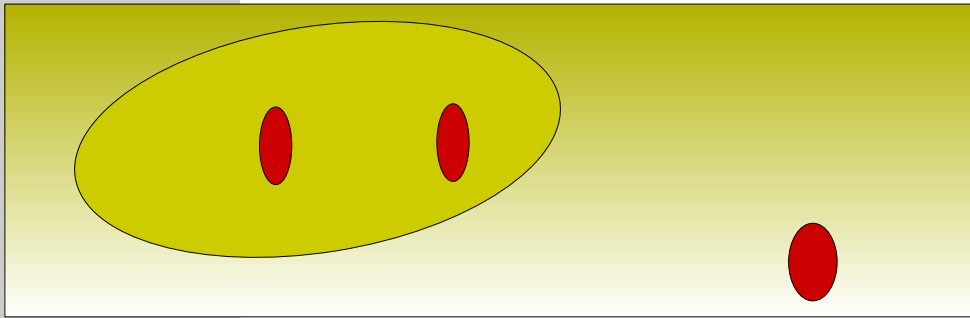

Confusion: the number of hits compatible with the extrapolated position

## Confusion

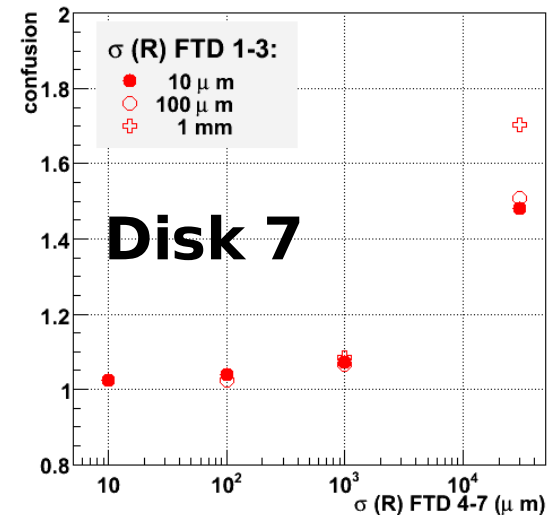
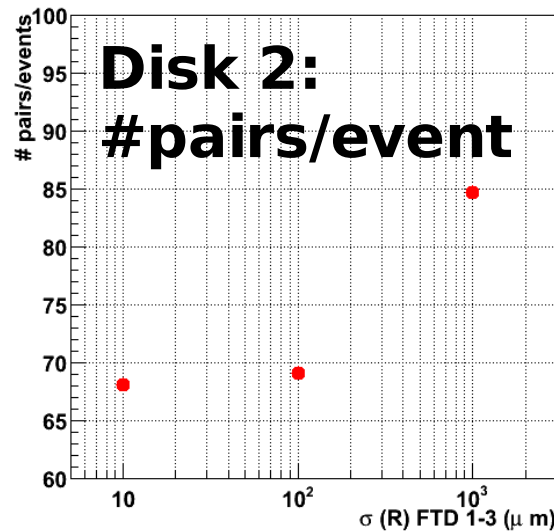

## ● Pattern recognition: quality markers

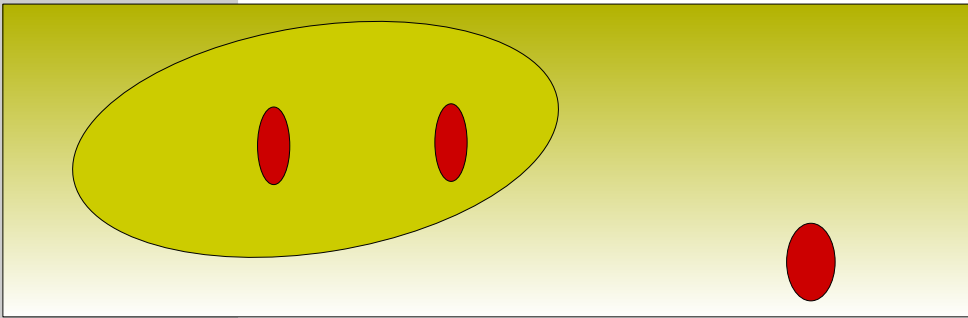

Confusion: the number of hits compatible with the extrapolated position

***Reduce frequent ambiguities in innermost tracking disks by fine segmentation  
Moderate (stereo-measurement) segmentation sufficient in outermost disks***

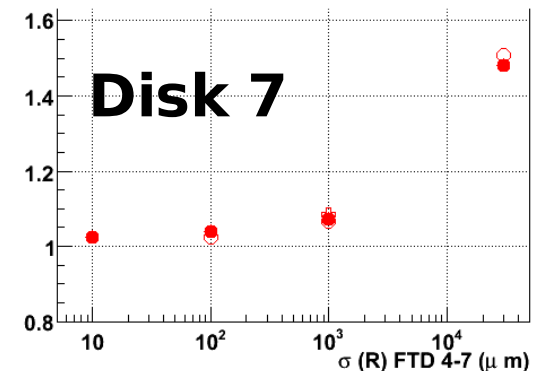
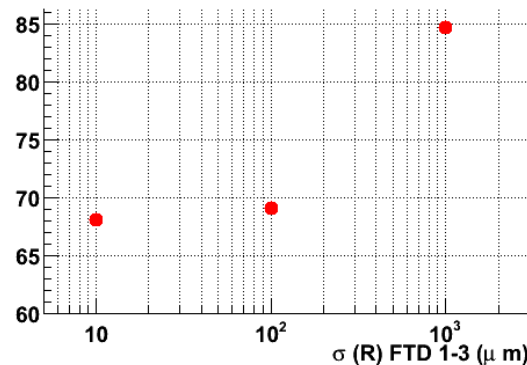

## ● Pattern recognition: detector parameter scan

**The stand-alone FTD is able to resolve patterns down to a  $p_T$  of 100 MeV, provided:**

**R-segmentation:** in innermost disks  $< 500 \mu\text{m}$ ,  
in outermost disks  $O(1\text{cm})$

**Read-out speed:** beyond  $O(10)$  bunch crossings  
the density of low momentum tracks prevents  
algorithm convergence

**Material:** an increase of the material beyond  
1%/disk has dramatic consequences on pattern  
recognition

# 14 BX

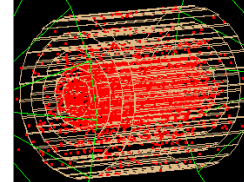

C. Mariñas,  
D. Barbareschi

# 140 BX

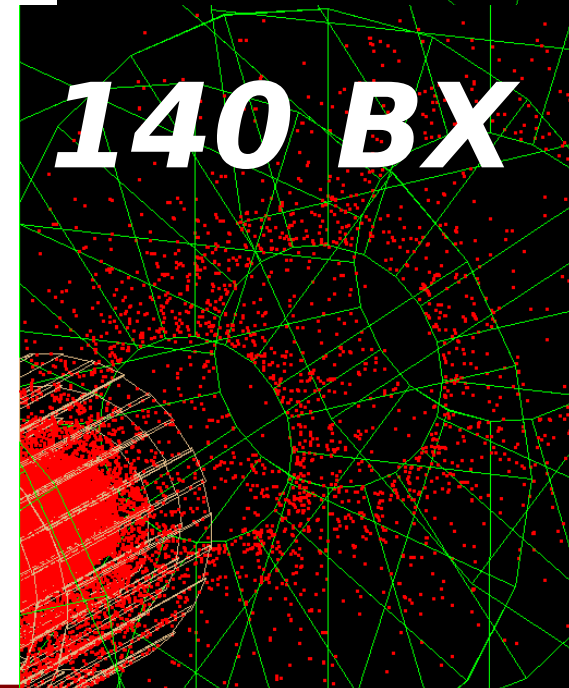

## ● Time-stamp

---

**Physics requirement: all tracks should be time-stamped.**

Therefore, stand-alone FTD should be able to provide a robust and redundant time-stamp.

Innermost disks: tracks are matched to a corner of the TPC. This combination yields a very precise time-stamp.

Outermost disks: FTD time-stamp requires single BX-readout.

## ● Forward tracking: challenges

**momentum resolution with unfavourable field orientation**  
lever arm, R-f resolution

**impact parameter measurement for very forward tracks**  
material and resolution disk0 + VXD services

**standalone pattern recognition in presence of background and low momentum tracks**  
R-segmentation, material, read-out speed

**minimal distortion of particles/global performance**  
material

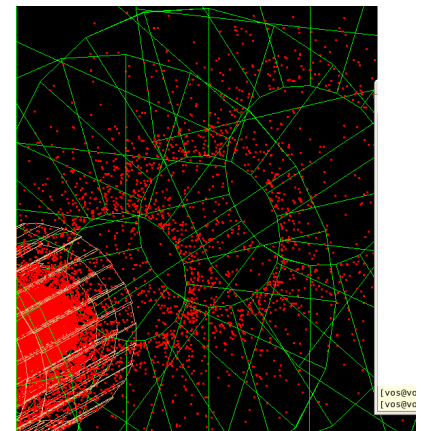
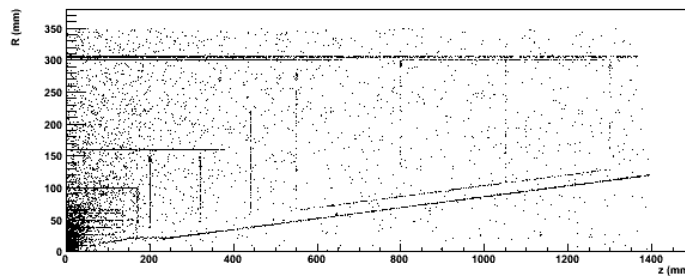

## ● Forward tracking requirements

**Challenges of ILC very Forward Tracker are being studied in detail . Write-up of results in progress**  
(see simulation session and <http://ific.uv.es/~vos/ilc/ilcFastForward>)

**The very forward region has a specific set of environmental constraints and requirements:**

- tight control of material budget  $\rightarrow$  0.2-0.5 %  $X_0$
- best achievable  $R \phi$  resolution  $\rightarrow$  5  $\mu\text{m}$
- moderate segmentation in  $R \rightarrow$  500  $\mu\text{m}$  – 1 cm
- moderate background level  $\rightarrow$   $1\text{-}2 \times 10^{-4}$  hits/ $\text{mm}^2/\text{BX}$
- fast read-out  $\rightarrow$   $< 10$  BX

**FTD 1-3: investigating VXD technologies (hybrid pixels as back-up solution)**

**FTD 4-7: double sided micro-strips**

## ● Coordinated ILC effort in Spain



## ● Coordinated ILC effort in Spain



***Several of these groups have expressed an interest in finding solutions for very forward tracking...***



## ● Very forward tracking: the forgotten problem?

### **A few extracts from the tracking review document (Beijing, February 2007)**

[...] it will be vital that the tracking system should for the first time perform as well in this [the forward] region as in the central region  
*executive summary, page 2*

It is clear that excellent tracking performance in the forward region is obligatory  
*introduction, page 5*

There is considerable uncertainty regarding the degradation in physics potential resulting from a given material budget, and this is a particularly serious issue in the forward region, where there tends to be an accumulation of material  
*introduction, page 5*

## ● Momentum resolution

**Physics requirement:** in the literature one finds: down to  
$$\Delta (1/p_T) = 10^{-5} \text{ GeV}^{-1}$$

the Higgs mass resolution in the recoil analysis is dominated by the tracker resolution.

**Caveat I:** Higgs-strahlung yields very central distribution

**Caveat II:**  $\Delta (1/p_T)$  is only constant if multiple scattering can be ignored.

But: for Higgs-strahlung at  $\sqrt{s} = 250 \text{ GeV}$  and very forward muons –  $\theta < 20$  degrees- the average  $p_T$  is reduced to a mere 13 GeV/c.

**Caveat III:** the very forward region – due to the less favourable orientation of the magnetic field – performs worse than the central tracker, even if it is equally well instrumented.

Must consider other benchmarks: sleptons, luminosity from  $e^+e^- \rightarrow \mu^+\mu^-$