

The ILD ECAL

Jan 28-30th 2010 ILDWS @ Paris

Satoru Uozumi (Kyungpook Natl. Univ.) *for the ILD ECAL group*

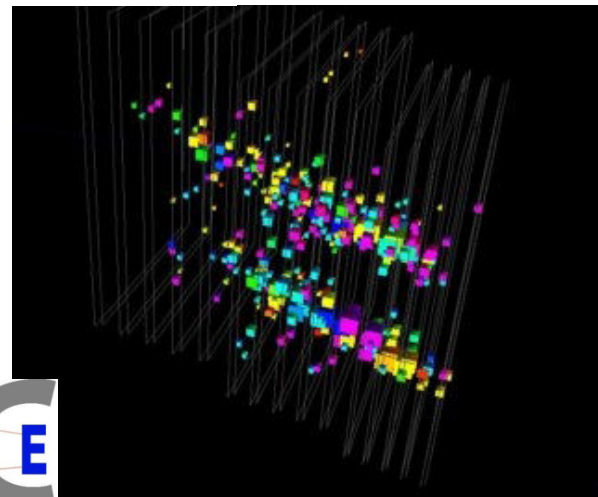
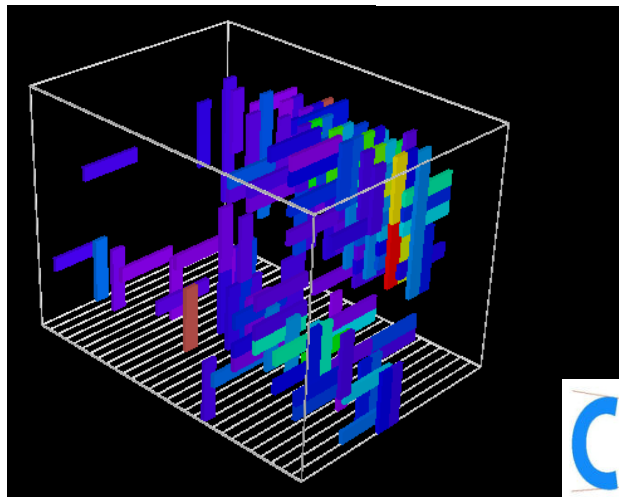
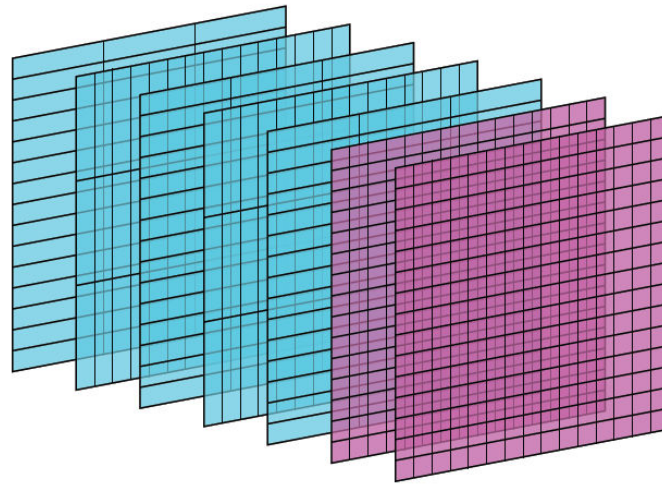

The ILD ECAL

- Finely granular PFA calorimeter with tungsten absorber
- Cell-size in baseline design $\sim 5 \times 5 \text{ mm}^2$, num. of cells $\sim 100\text{M}$ in total
- Necessary to achieve less dead space, low production cost

Barrel: 5 octagonal wheels

$R_{\min} = 1808 \text{ mm}$; $R_{\max} = 2220 \text{ mm}$

Width = 940 mm

End-caps: 4 quarters

$\varnothing_{\min} = 800 \text{ mm}$

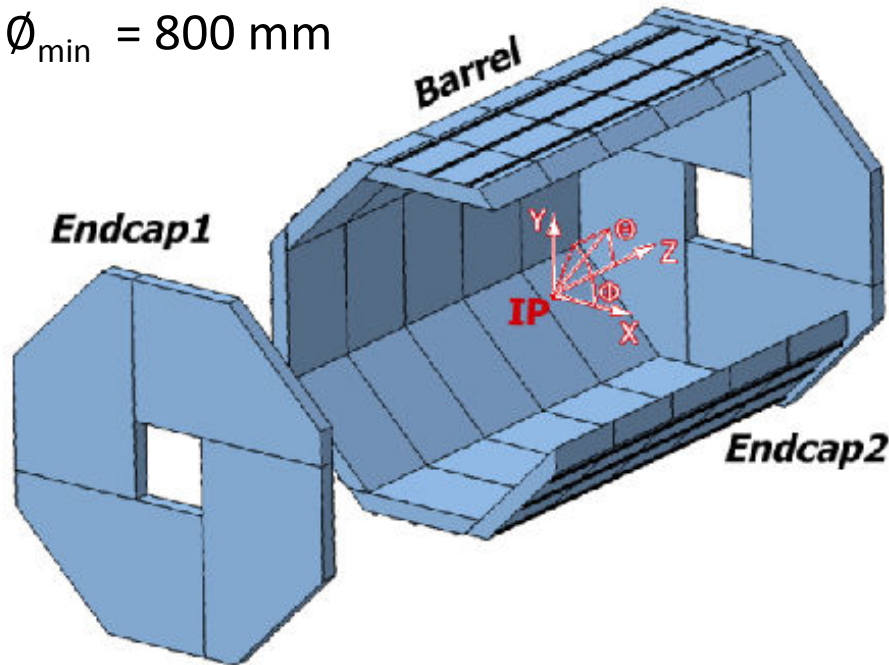

*Jet Energy Resolution
by M. Thomson*

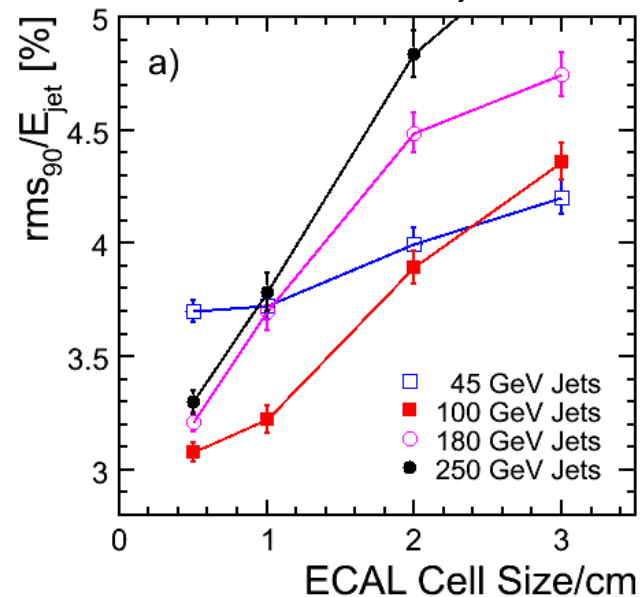

Candidate technologies :

- **Silicon-tungsten**
- **Scintillator-tungsten**
- **MAPS/DECAL**

Silicon-tungsten ECAL

- **ILD Structure**
 - 20 layers of 2.1 mm ($0.6X_0$) W
 - + 9 layers of 4.2mm ($1.2X_0$)W
 - 5×5 mm² granularity of Si
 - ~ 108 M cells in total
- **10x10 mm² physics prototype tested in beam**
 - Energy resolution measured in test beam $\sim 16.6\%/ \sqrt{E}(\text{GeV}) \oplus 1.1\%$ with S/N ratio of 7.5 for a mip signal
 - CERN (2006, 2007), FNAL (2008)
- **Remaining hardware R&D issues**
 - Power pulsing of FE electronics (common issue also for Sci ECAL)
 - Si sensor cost reduction ... need 2400 m², current price 10 euro/cm²

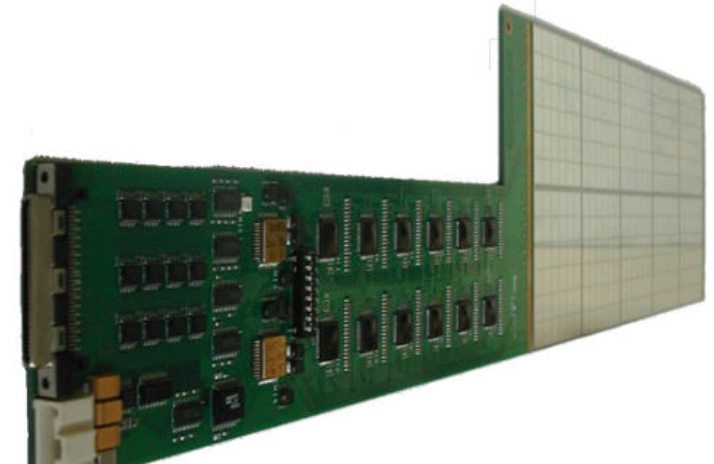
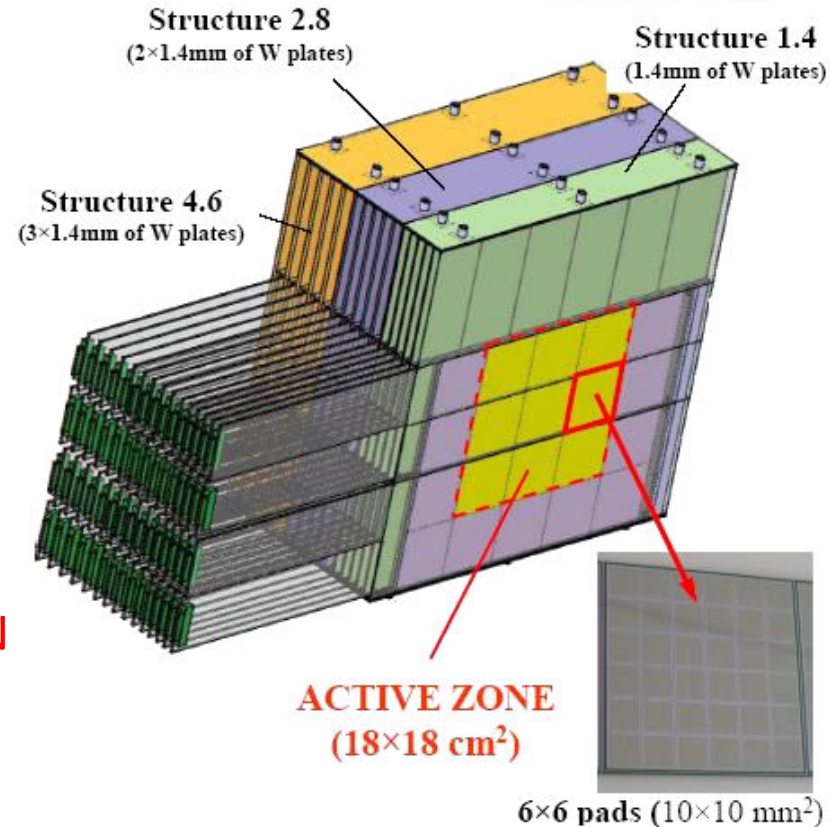

Scintillator-tungsten ECAL

- Cost-effective scintillator strip calorimeter aiming to have virtual cells by x-y strips crossing.
- Beam tests of the physics prototype have been performed to prove feasibility.
 - DESY 2007 (small prototype)
 - FNAL 2008, 2009 (test with AHCAL)
- ILD structure
 - Scintillator strips with 5 mm width
 - 2 mm thick without WLS fiber
 - 3 mm tungsten, $\sim 21 X_0$ in total
- Study of “strip-clustering” underway with realistic simulation
- Remaining Hardware R&D issues :
 - Study of 5 mm width scintillator-strip without WLS fiber
 - Dynamic range of photo-sensor
 - Establish design of the photo-sensor gain calibration system

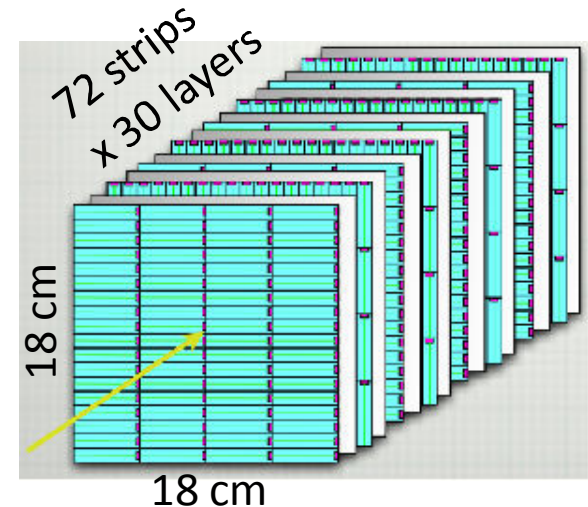
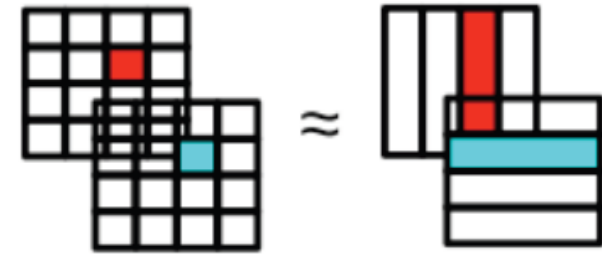

Scintillator strip (4.5 x 1 x 0.3 cm)

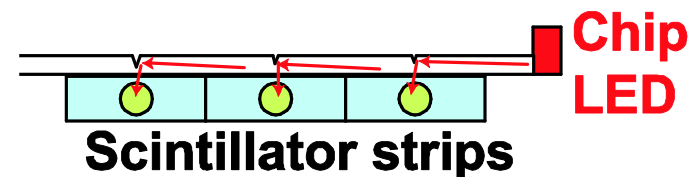

MAPS (DECAL) option

- Potential large cost reductions
 - Standard CMOS sensor
 - No proprietary processes
 - Electronics all on sensor, reduced fabrication/assembly costs
- Ultimate spatial resolution
 - 50x50 μm^2 pixels
 - “TERA Pixel” detector
- TPAC readout chip
v1.0-v1.2 = 168 x 168 pixels; 79.4 mm²
Expected resolution (pixel counting)
13%/VE(GeV) \oplus 1%
- Status:
 - successful CERN TB of 6 sensors summer 2009
 - New SPiDeR collaboration
 - Physics prototype planned for 2012☹
- Critical points
 - integration, Power consumption, services
 - Funding issue for further R&D

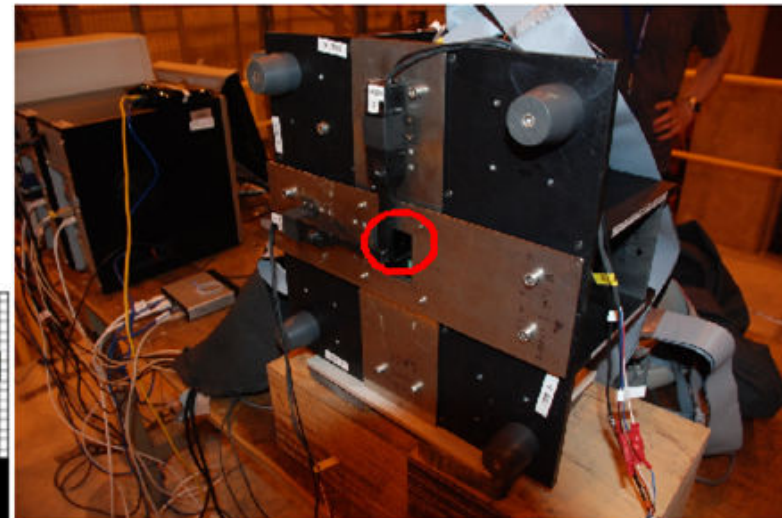
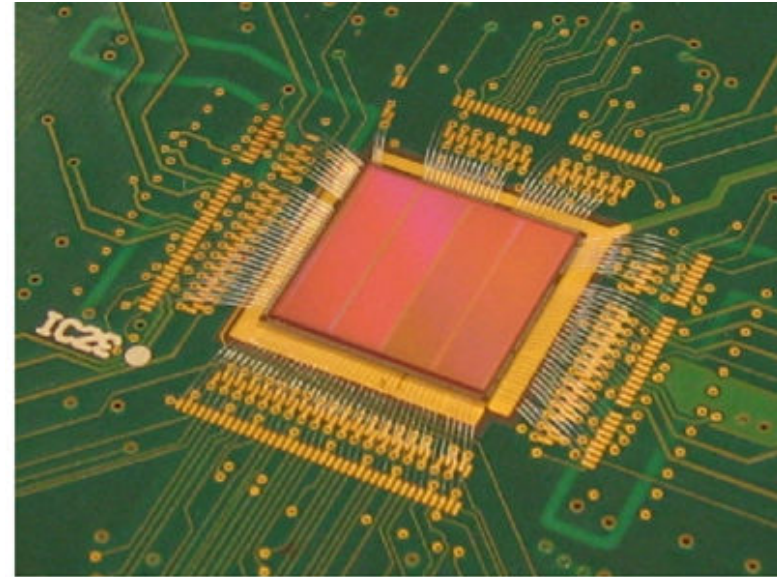

Question from IDAG

- **Each validated detector group will produce a detailed baseline design by 2012. To this end the following steps are planned.**
 1. Demonstrate proof principle on critical components.
 - When there are options, at least one option for each subsystem will reach a level of maturity which verifies feasibility.
 - 2. Define a feasible baseline design.**
 - **While a baseline will be specified, options may also be considered**
 3. Complete basic mechanical integration of the baseline design accounting for insensitive zones such as the beam holes, support structure, cables, gaps or inner detector material.
 4. Develop a realistic simulation model of the baseline design, including the identified faults and limitations.

Possible Idea for baseline design of the ILD ECAL

- A lot of discussion has been done to form the “Unified ILD ECAL” in this month.
- One possible idea is a “hybrid-type ECAL” with silicon pads and Scintillator-strips.
 - The silicon pads in pre-shower and shower-max region
 - The scintillator layers cover after the shower maximum
 - Another idea : Si layers interleaved in scintillator layers
 - Cost-effective
 - No two-fold ambiguity for the strip clustering with silicon sensors
 - Can use established the silicon and Scintillator ECAL technologies.
 - Need extensive simulation study to determine configuration of Silicon / Scintillator layers
 - Specific cell & strip combined clustering must be developed.
- Mokka simulation of the hybrid-type ECAL is under preparation.

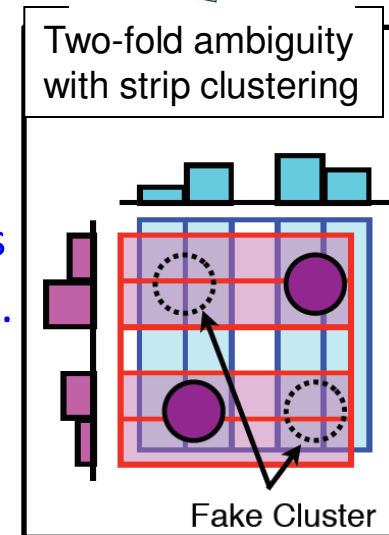
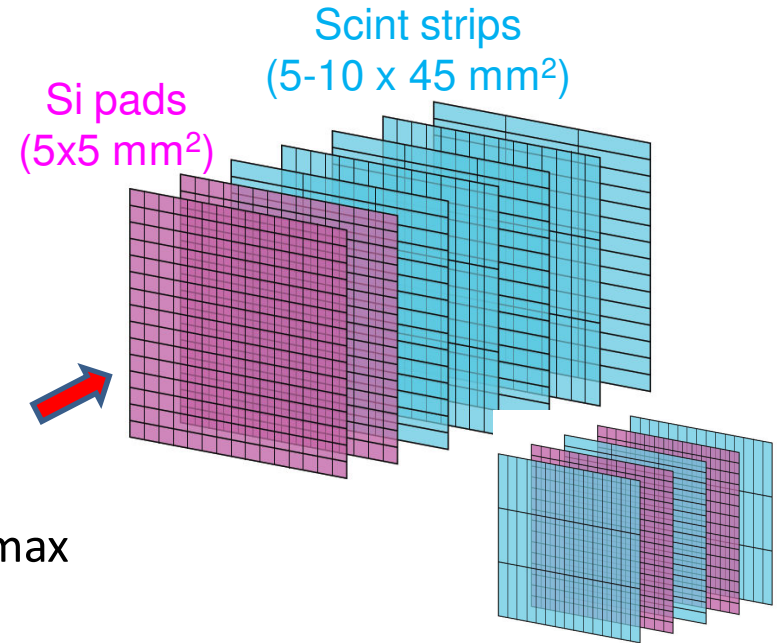

Question from IDAG

- **Each validated detector group will produce a detailed baseline design by 2012. To this end the following steps are planned.**
 1. Demonstrate proof principle on critical components.
 - When there are options, at least one option for each subsystem will reach a level of maturity which verifies feasibility.
 - 2. Define a feasible baseline design.**
 - **While a baseline will be specified, options may also be considered**

→ **The Silicon-Scintillator hybrid ECAL could be the possible candidate in case of problem with silicon cost or reconstruction problem of scintillator. This possibility is subject to study in next 2 years. MAPS pixels for digital ECAL under investigation as an option beyond the baseline.**
 3. Complete basic mechanical integration of the baseline design accounting for insensitive zones such as the beam holes, support structure, cables, gaps or inner detector material.
 4. Develop a realistic simulation model of the baseline design, including the identified faults and limitations.

Question from IDAG

- Each validated detector group will produce a detailed baseline design by 2012. To this end the following steps are planned.
 1. **Demonstrate proof principle on critical components.**
 - **When there are options, at least one option for each subsystem will reach a level of maturity which verifies feasibility.**
 2. Define a feasible baseline design.
 - While a baseline will be specified, options may also be considered
 3. **Complete basic mechanical integration of the baseline design accounting for insensitive zones such as the beam holes, support structure, cables, gaps or inner detector material.**
 4. **Develop a realistic simulation model of the baseline design, including the identified faults and limitations.**

Major Milestones to prove Si-Sci-W ECAL feasibility by end 2012

- **Technical points**

- Produce short detector slab for both Silicon and Scintillator layers (by mid 2011)
test it with cosmics and beams
- Produce long Silicon detector slab (over ~1.5m) to test signal integrity etc.
(by end 2011)
- Demonstrate power pulsing of FE chips
 - First with single chip, short slabs of Si / Sci layers (by mid 2011)
 - Then with long slab (by end 2011)
 - Test in the magnetic field (by mid 2012)
- Analysis of past test beam data, comparison with simulation (ongoing, ASAP)
- Establish 5 mm width scintillator strip (by ~ 2010/2011)
- Design and produce thin PCB for scintillator/MPPC layers (by mid 2011)

Major Milestones to prove Si-Sci-W ECAL feasibility by end 2012 (cont'd)

- **Simulation (all by mid 2010)**

- Implement dead zones of scintillator (photo-sensor, covering films)
- Implement non-uniformity of strip response
- Update ILD Si simulation to same level as CALICE SiW testbeam simulation
- Implementation of service inside gap between barrel and end-cap

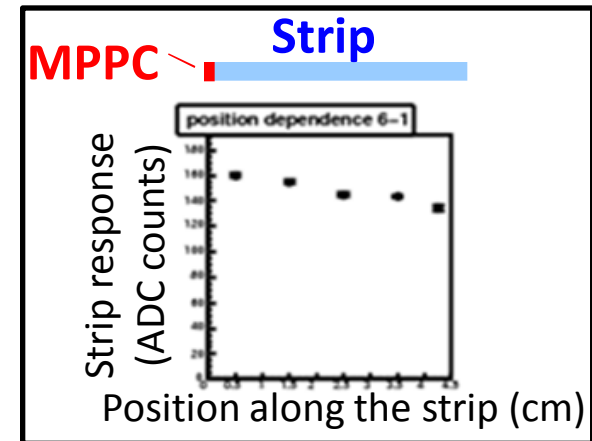

- **Reconstruction**

- Realistic digitization (end-of-slab instrumentation, MPPC saturation) (by end 2010)
- Clustering with strip and hybrid geometries (by mid 2011)
- Study of PFA performance in different configurations of Si-Sci hybrid ECAL (by end 2011)

- **Detector calibration**

- Define ILD ECAL calibration procedure (by end 2011)

Milestones to prove MAPS DECAL option feasibility by end 2012

- **Technical – individual sensor characterization**
 - Measure MIP efficiency from 2009/10 test beams for sensor variants – by end 2010
 - Including epitaxial layer dependence: deep P-well; high resistivity; layer thickness
 - Publish essential characterisation data – by end 2010
 - Pedestals; noise; response uniformity; trimming; calibration with ^{55}Fe ; diffusion time
 - Comparison of shower densities in data and simulation - DESY testbeam, March 2010
 - Electron response and core shower density
 - Results vs. particle energy and vs. material depth
 - Single most critical result for DECAL – by early 2011
 - Soft photon response downstream of absorber
- **Simulation**
 - Resolution of realistic DECAL to photons – by end 2010
 - Study dependence on pixel size; noise; deep P-well; charge diffusion; dead areas, etc.
 - Maintain compatibility with SiW analogue geometry/mechanics where appropriate, as expected for a high performance/lower cost *option*
- **Reconstruction**
 - Single particle and PFA tuned for DECAL in performance benchmark studies with most complete simulations – by end 2011

The EUDET prototype

Silicon module

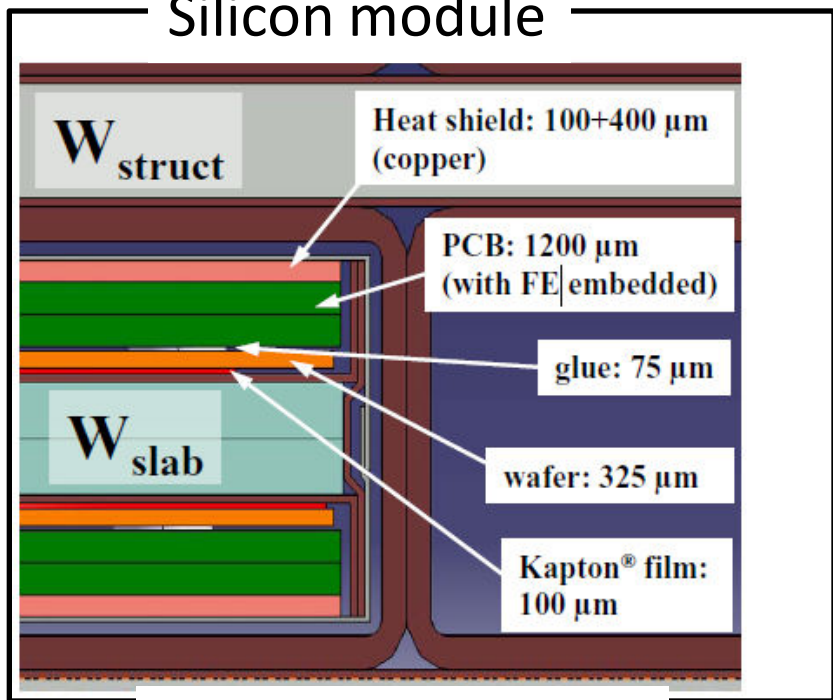

Scintillator module

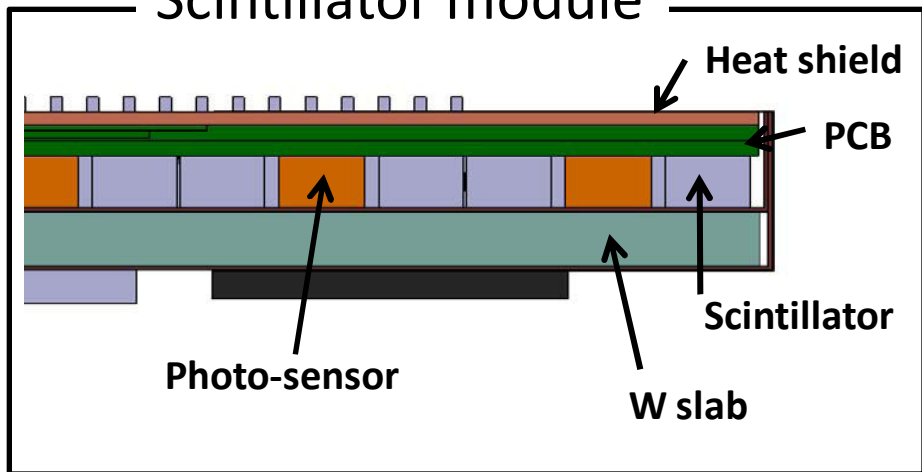

- The EUDET alveolar structure can accommodate both Si / Sci ECAL modules.
- Discussion underway to make the compatible structure.

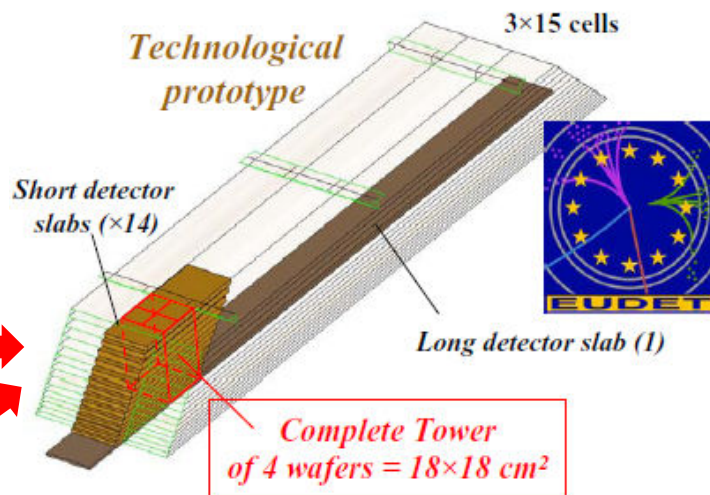

- Construction of the mechanical structure by end-2010.
- Implement detector modules ~ mid 2011.
- Future beam tests from ~ 2012
 - Si + Sci module test
 - Validate power pulsing
 - Test simulation with finer granularity

Summary

- Technologies and feasibility for the ILD ECAL is being established (in the CALICE collaboration).
 - Several beam test has been done with SiW and SciW ECAL prototypes during 2006-2009.
 - Realistic simulation study with PandoraPFA is ongoing.
- Now those technologies are being unified to an idea of the hybrid-ECAL with the silicon and scintillator layers.
 - It could be a possible candidate of the ILD ECAL baseline design.
 - Extensive simulation study will be done in next 2 years.
- MAPS pixels for digital ECAL under investigation as an option beyond the baseline design.
- Still a lot of works need be addressed to finish homework given by IDAG.
- EUDET technical prototype will be the next stage of the hardware R&D.
 - Several tests will be running from 2010 until the DBD.