

ILD Push-pull Strategy

T. Tauchi (KEK)

4th ILD Workshop, Couvent des cordeliers, Paris, France,
27-30 January, 2010

Major issues in the push-pull operation

I. Overall

Switchover time and frequency

II. Detector

(1) Stability during the movement, and the position reproducibility

(2) Connection to the outer world

- flexible lines as much as possible

(3) Detector services on the beam line and calibration

(4) Support of final quadrupole and its alignment

(5) Self-shielding (radiation) and stray field of detector magnet

III. Accelerator

(1) Optics with different L^* and beam tuning time

(2) Separation between QD0/SD0 and QF2/SF1

- optics verification and stability

(3) Alignment and BBA to resume the luminosity run

L* dependence

- The original plan was to study the L* dependence (in the range of 3.5-4.5m) before the Sendai meeting. This plan cannot be now completed.
- Thus, results below are based on a model as of early December 2007, which was not scrutinized and may have some flaws, and too optimistic assumptions.
- The information, even tentative, may still be useful for discussion of detector optimization.
- The case of doubling L* also shown.

Tentative dependence of luminosity on L*

- Reduced by ~10-20% for L* 3.5m => 4.5m
- Reduced ~factor of two for 3.5m=> 7.0m

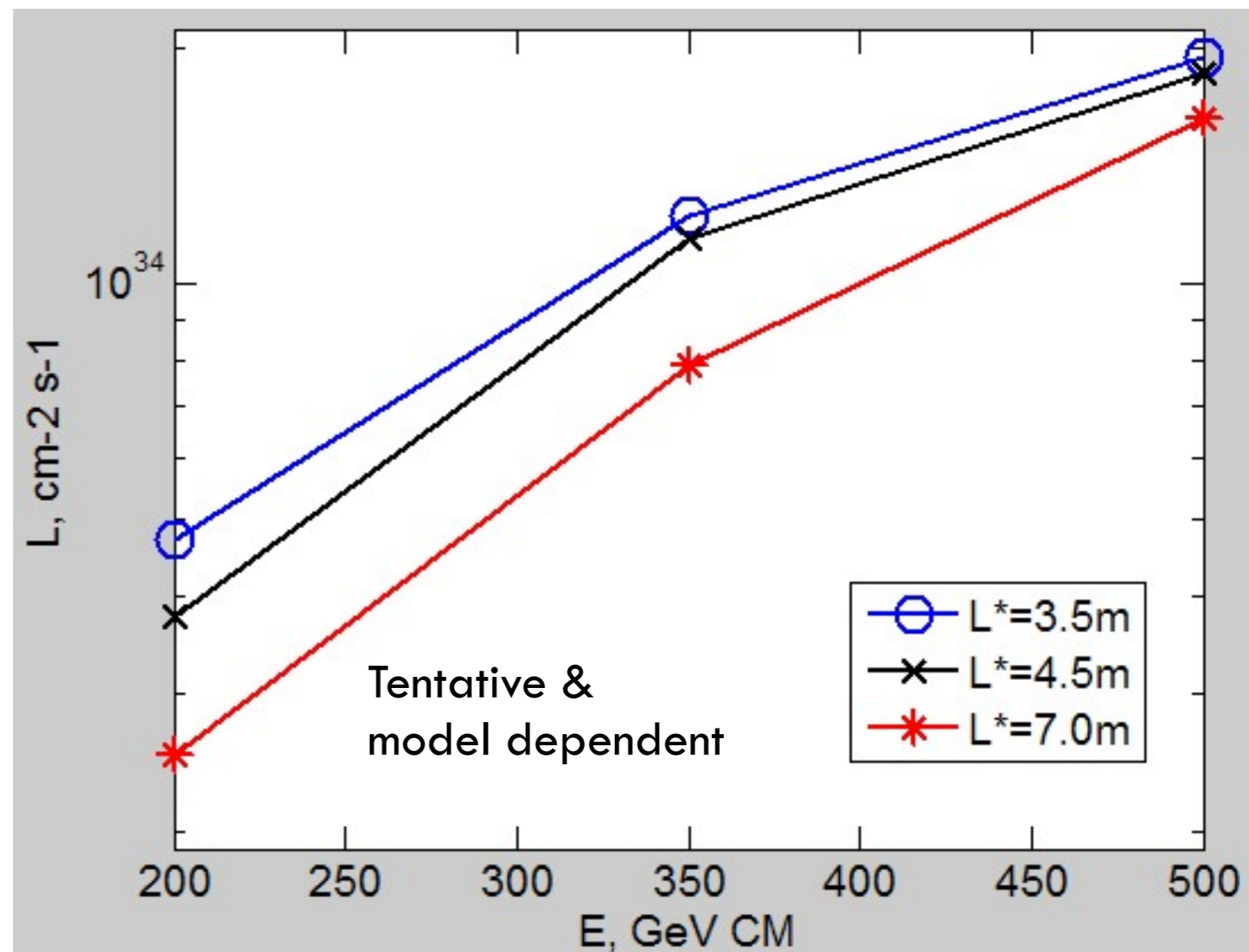

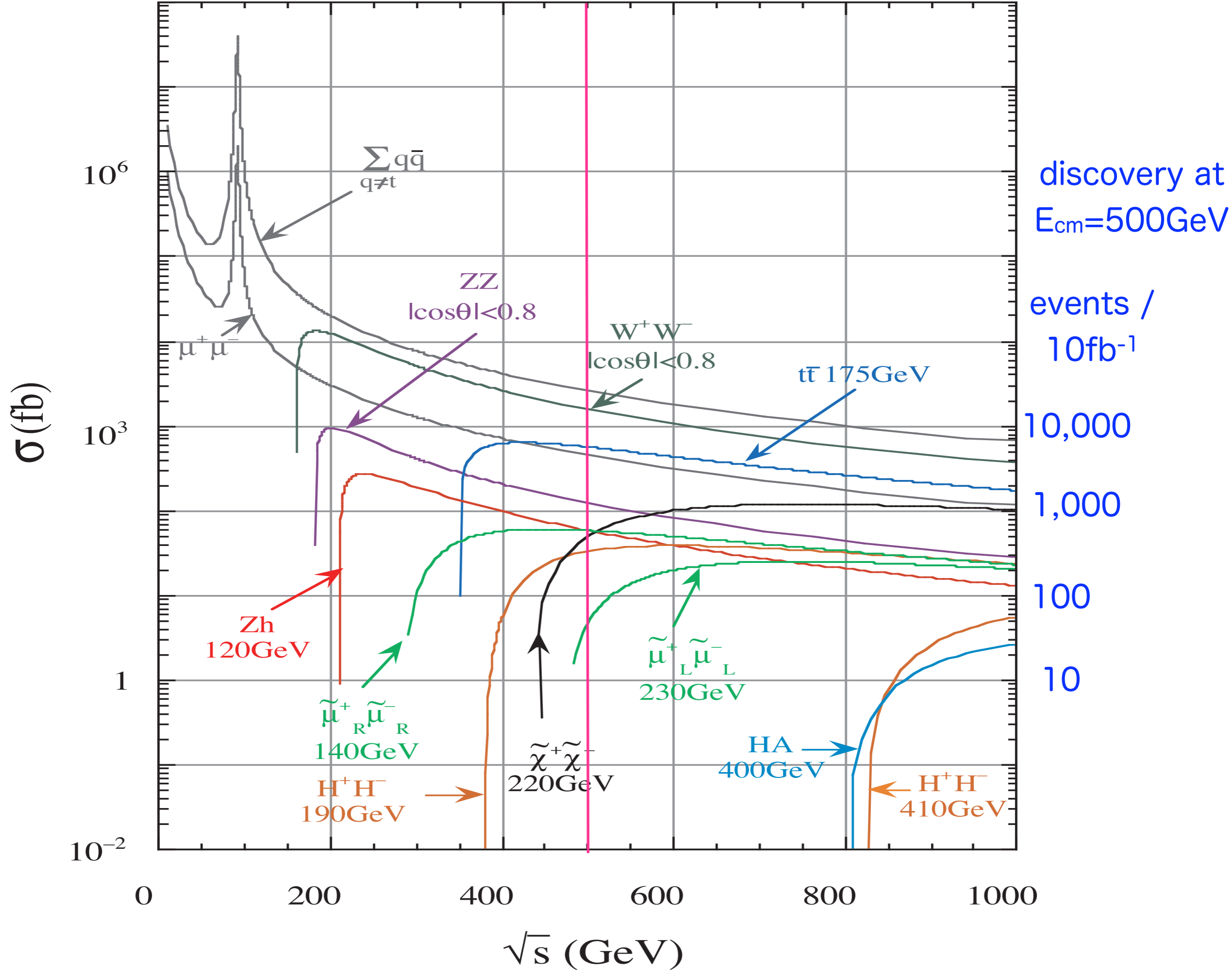

I. Overall - basic questions

(1) What is a maximum integrated luminosity for one experimental period/cycle, since "neither detector should be able to get a significant luminosity advantage in a single cycle" ?

Minimum integrated luminosity would be 4 fb^{-1} for Higgs "discovery" at the optimal CM energy which must be true with the LHC result. If not, 10 fb^{-1} would be needed at $E_{\text{cm}}=500\text{GeV}$. Slepton discovery has similar luminosity of 10 fb^{-1} . Therefore, the maximum one should be less than 10 fb^{-1} .

ILC is also energy frontier machine !

(2) What is a fraction for the switchover in order to satisfy the ILC physics scope?

"Parameters for the Linear Collider"

Update November 20, 2006

The Parameters Subcommittee of ILCSC

Asia: Sachio Komamiya, Dongchul Son

Europe : Rolf Heuer (chair), Francois Richard

North America: Paul Grannis, Mark Oreglia

For LC operation at less than maximum energy, we assume that the luminosity scales as $L \sim \sqrt{s}$.

Baseline machine

"Luminosity and reliability of the machine should allow the collection of approximately $L_{eq} = 500 \text{ fb}^{-1}$ in the first four years of running, not counting year zero which is assumed to mainly serve for machine commissioning and short pilot physics run(s). the full luminosity of $2 \times 10^{34} \text{ cm}^{-2}\text{s}^{-1}$ at 500 GeV...."

It is assumed here that the design luminosity and the efficiency/reliability of the machine will only be reached gradually within the first years of operation (10, 30 and 60% in years 1, 2 and 3, resp.) and that the design luminosity and reliability will be reached in year four (i.e. 100% in year 4) of physics running, not counting year 0.

The interaction region (IR) should allow for **two experiments**. Two experiments are desired to allow independent and complementary measurements of critical parameters and to provide better use of the beams thereby maximizing the physics output. **Switching between experiments should be accomplished with less than a few percent loss of integrated luminosity**. If necessary for design and cost considerations, the two experiments could share a common IR, **provided that the detector changeover can be accomplished in approximately 1 week**. In this “push-pull” scenario, it would be expected that detector changeovers would occur at **predetermined values of luminosity accumulated**.

I.) **A scenario** suggested by R.Settles and modified by T.Tauchi,

--Notation: BPL=best possible luminosity.

--Assumption: two detectors acquire BPL in 1.25×10^7 sec each year.

That is, 0.62×10^7 sec per detector.

--Assumption: 1.25×10^7 sec = 145 days = 20 weeks running at BPL.

That is, 10 weeks per detector per year.

--Assumption: Yearly long shutdown for yearend holidays and machine work/detector work = 12 weeks (week 51 to week 10).

--Scenario: -start week 11, det-1 on beam.

-det-1 BPL running 2 weeks + 1 week contingency
for machine study
and inefficiency

-push-pull+calib 1 week

-det-2 BPL running 2 weeks + 1 week contingency
for machine study
and inefficiency

-push-pull+calib 1 week

--Therefore 1 cycle = 8 weeks.

--Need 5 cycles so that each detector gets 10 weeks of BPL running.

--Total running time = 40 weeks, meaning from week 11 to week 50.

II.) Evolution of BPL from “Parameters for the Linear Collider”, November 2006:

- For 1.25×10^7 sec of running in a year and $L_{\text{goal}} = 2 \times 10^{34} \text{cm}^{-2} \text{sec}^{-1}$,
- Yr 0: commissioning of machine and detectors, i.e. no BPL running.
 - Yr 1: BPL = 10% of $L_{\text{goal}} = 25 \text{ fb}^{-1}$: 2.5 fb^{-1} /push-pull
 - Yr 2: BPL = 30% of $L_{\text{goal}} = 75 \text{ fb}^{-1}$: 7.5 fb^{-1} /push-pull
 - Yr 3: BPL = 60% of $L_{\text{goal}} = 150 \text{ fb}^{-1}$: 15 fb^{-1} /push-pull
 - Yr 4: BPL = 100% of $L_{\text{goal}} = 250 \text{ fb}^{-1}$: 25 fb^{-1} /push-pull
-

total = 500 fb^{-1} (250 fb^{-1} each for two detectors)

This model involves 10 push-pulls per year while for precision-physics measurements, we may need fewer push-pulls.

Do we need Gentleman's agreement between the two detectors for common publication of experimental results ?

“Discovery papers” with all members of two collaborations plus accelerator physicists as authors

Physics Scope at ILC

Work Plan

Responsibility

Status

date

Integrated luminosity to optimize the machine parameters

statistical and theoretical accuracies

the accuracies required by physics (channels and observable)

Running scenario

generic one in the ILC physics scope : 500fb^{-1} for 4years

T.Tauchi, R.Settles done

Sep.09

specific one with specific physics scenario

Currently projected LHC timeline

Questions to be answered by ILC

Energy	Year	LHC	Physics
8 TeV	2010	3 pb ⁻¹	min bias, QCD
	2011	300 pb ⁻¹	\tilde{q} at 600 GeV, MET at 2 σ , l+l+ at 3 σ Z' at 1.5 TeV stable \tilde{l} at 200 GeV
14 TeV	2012	1 fb ⁻¹	\tilde{q}, \tilde{g} at 1 TeV, MET, ll, ll at 5 σ Higgs at 300 GeV in ZZ
	2013	10 fb ⁻¹	Higgs at 140 GeV in ZZ*
	2014	30 fb ⁻¹	Higgs at 120 GeV in $\gamma\gamma$ t \bar{t} resonance at 3 TeV
	2015	100 fb ⁻¹	strong WW scattering unexpected Q at 2 TeV
	2016	200 fb ⁻¹	strong ZZ scattering unexpected Q at 3 TeV

SUSY or new spectroscopy ?

Z' models?

Higgs : SM ?
precision physics

The specific phenomena found at the LHC urgently require new measurements that can only be made at an e+e-collider and are possible at 500 GeV. (M.Peskin)

Push-Pull with Platform

The ILD detector will be placed on a concrete platform to avoid possible damages due to non-synchronized movements or from vibrations during push-pull and also to ease internal alignment challenges

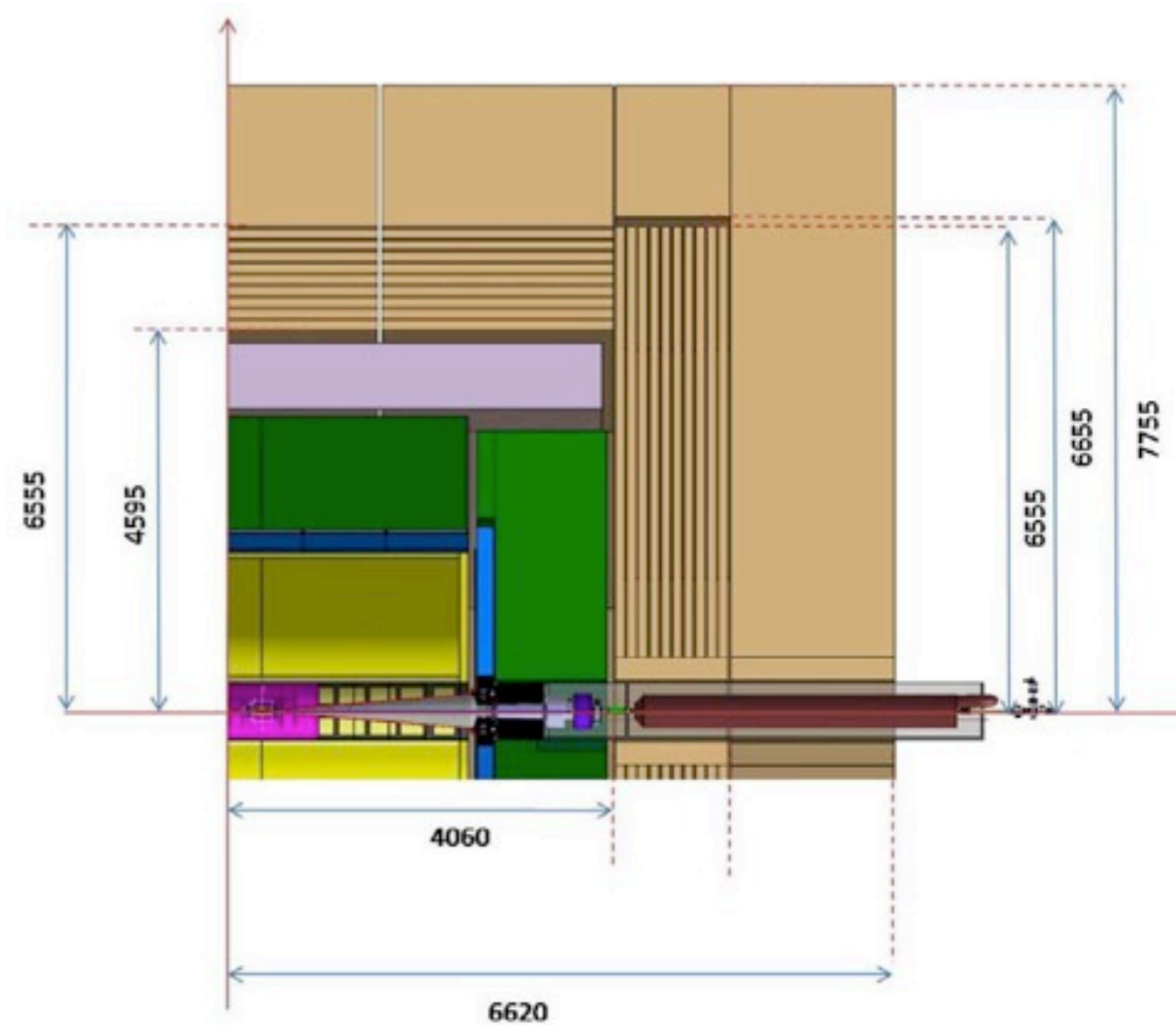
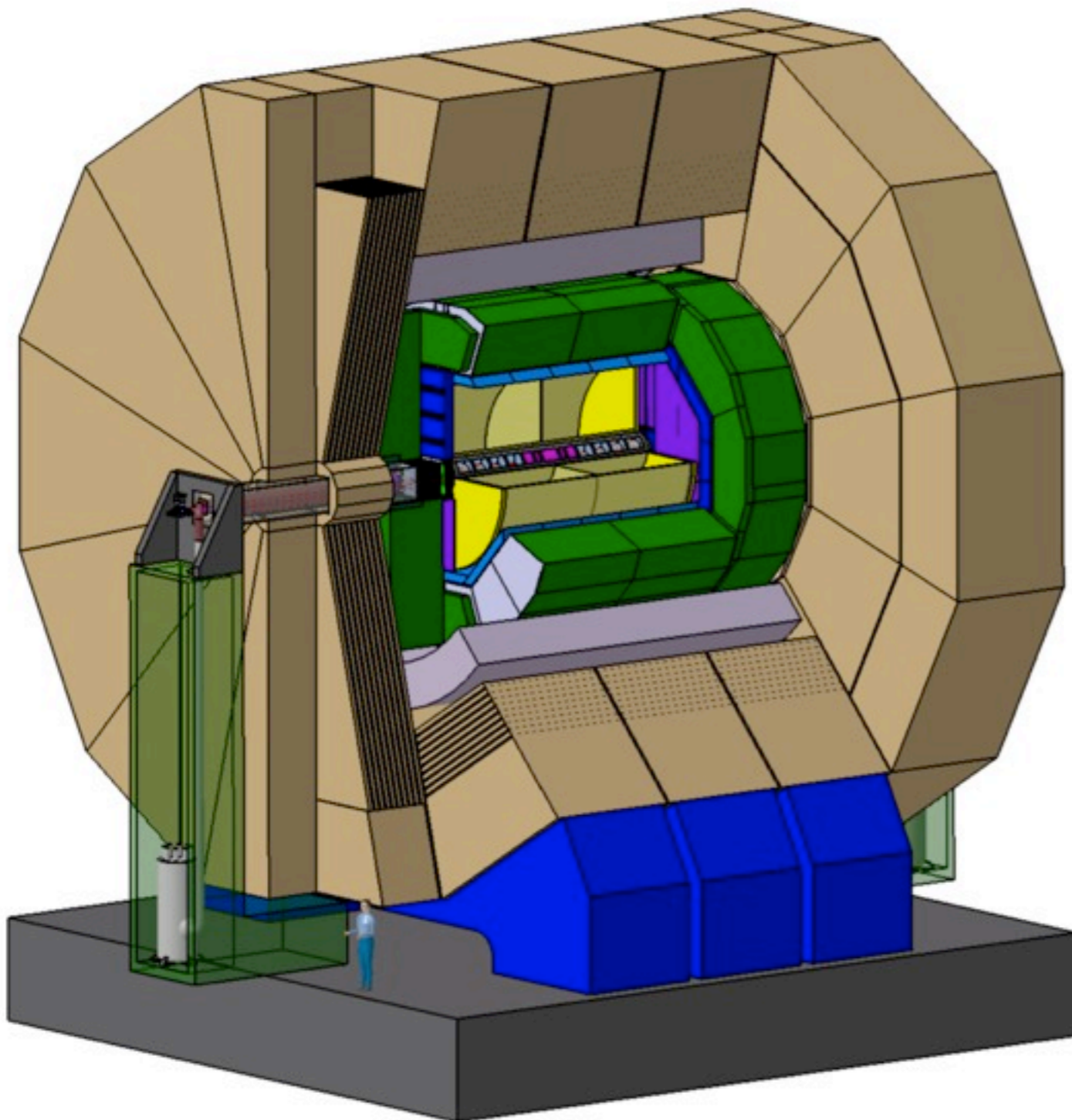

~12kton

From this....

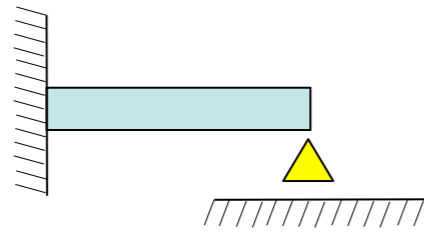

.....to this

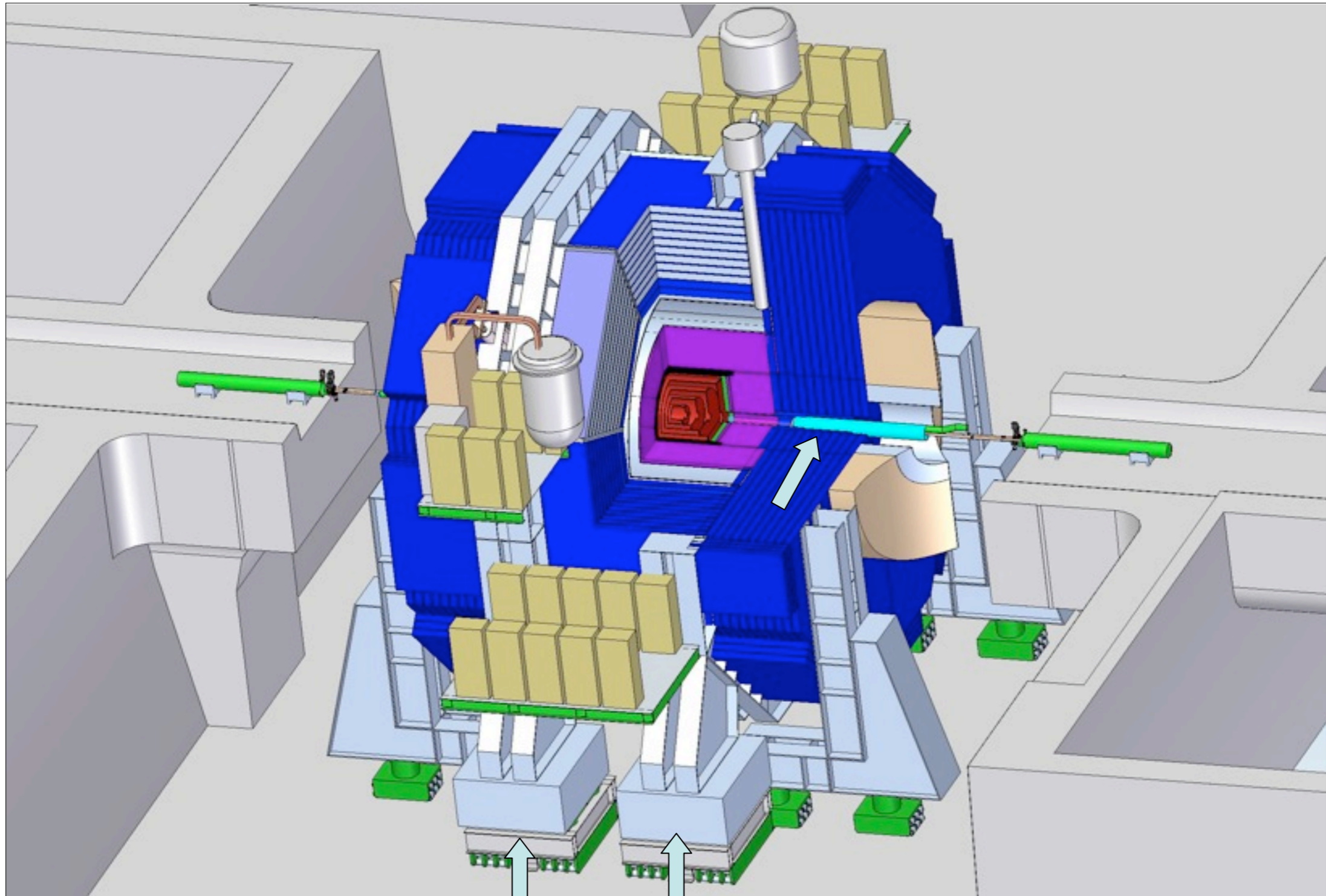
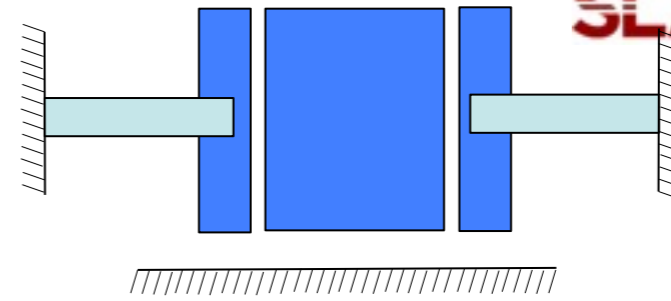

Ground motion through the feet

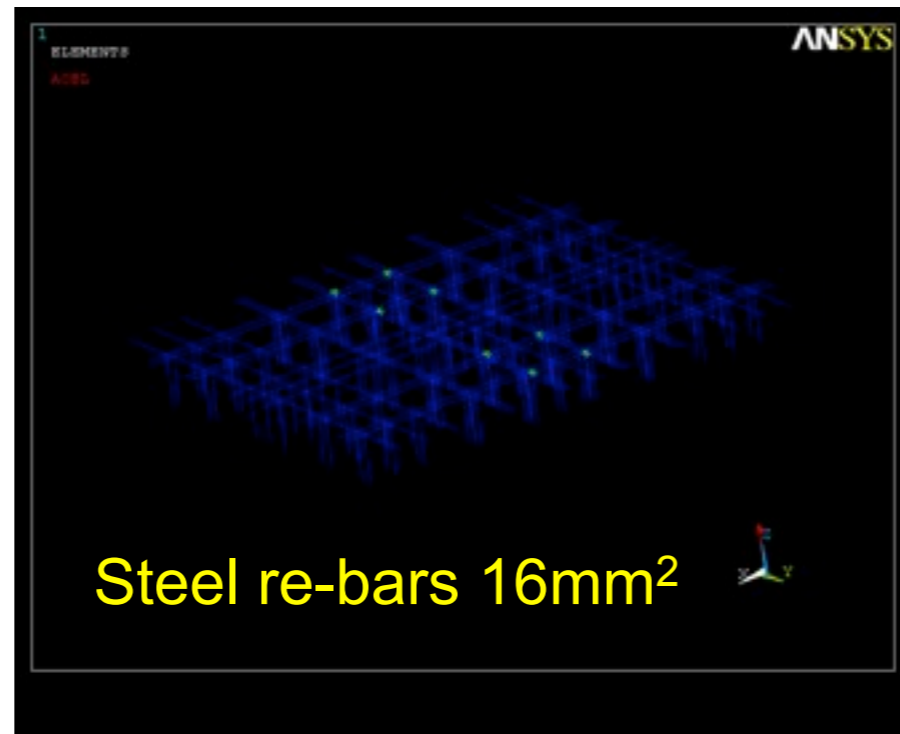
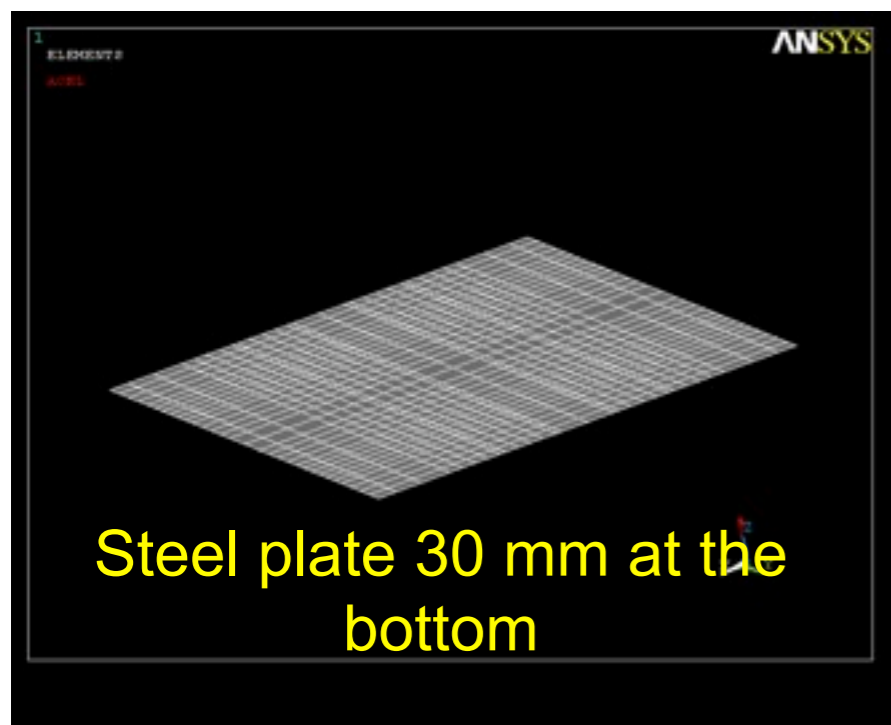
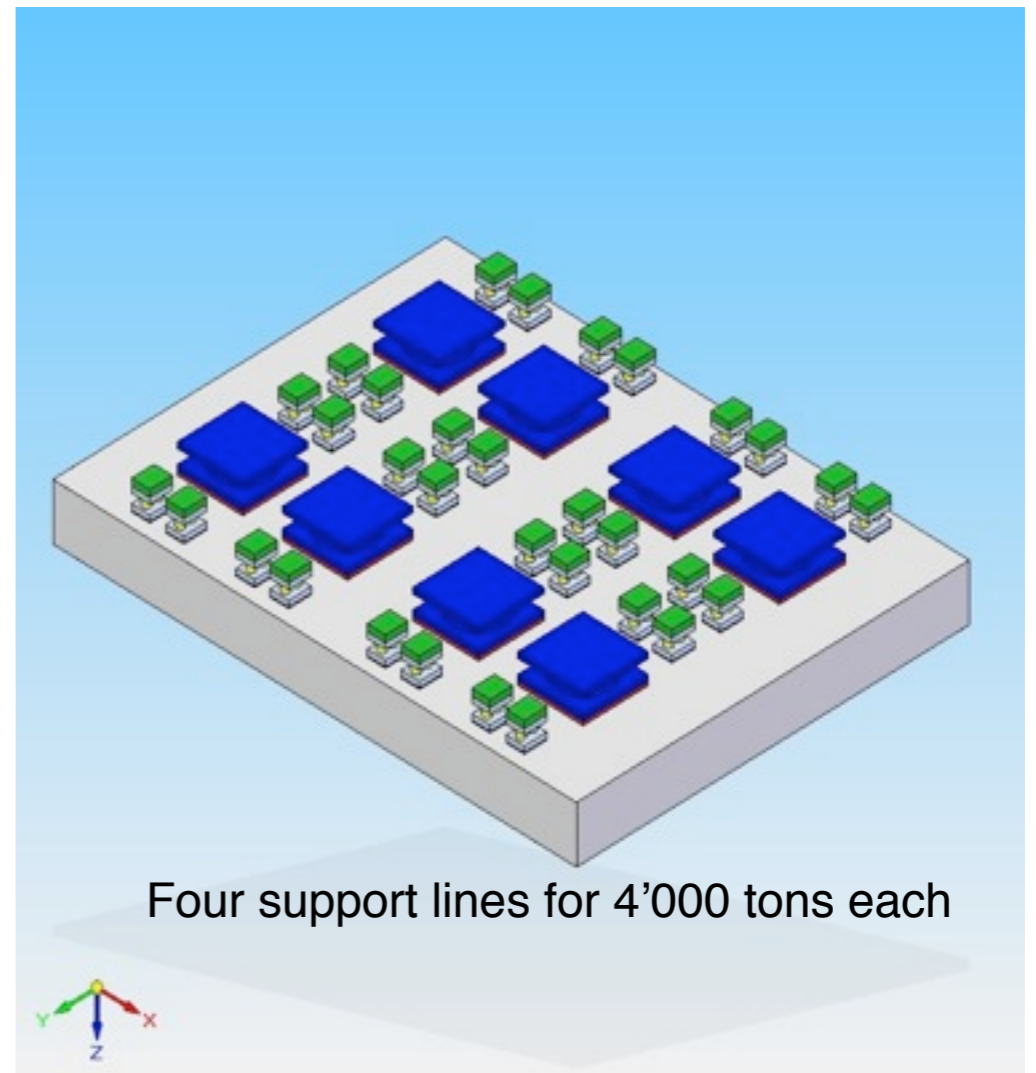
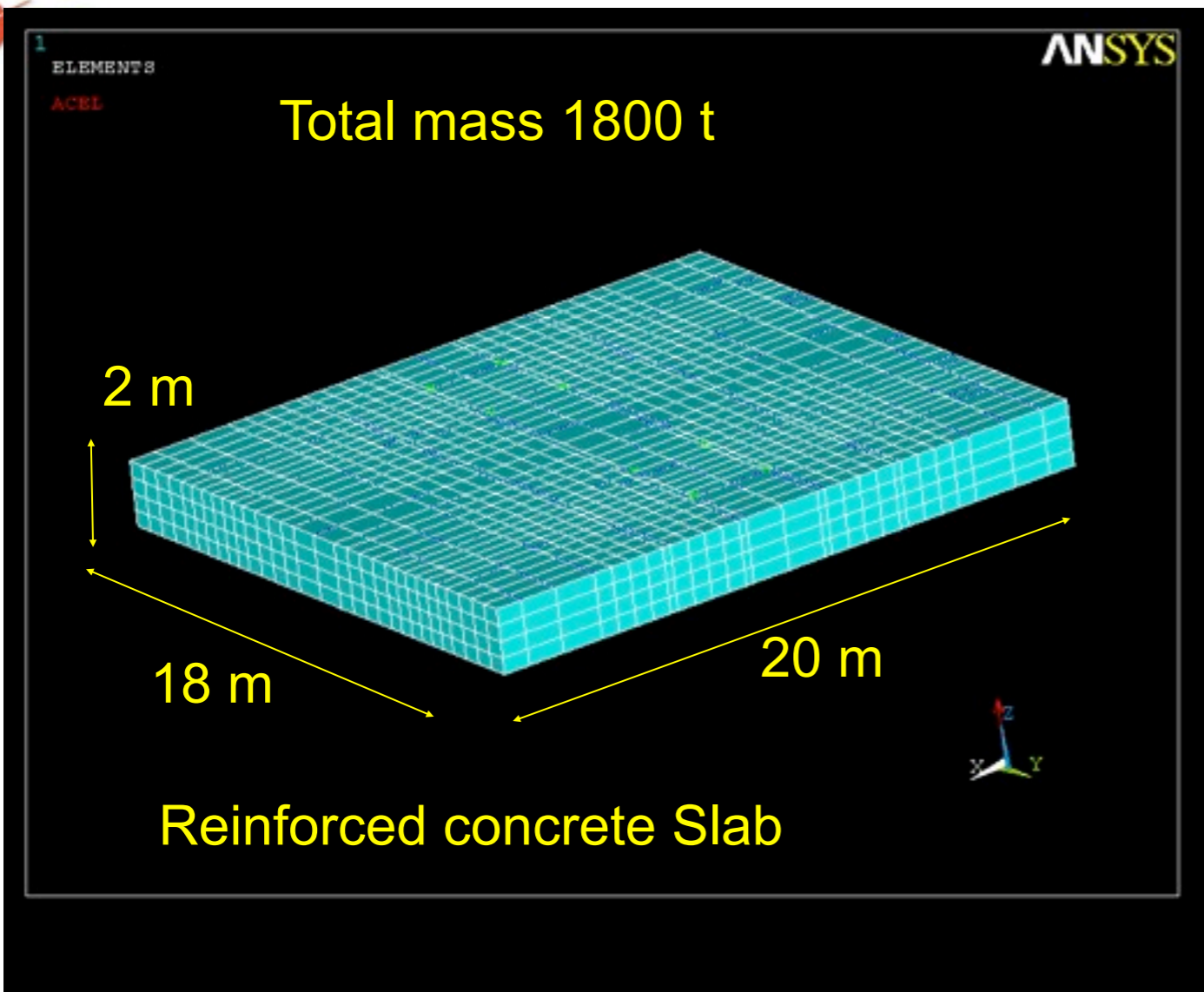



Total Mass ~1200 tons

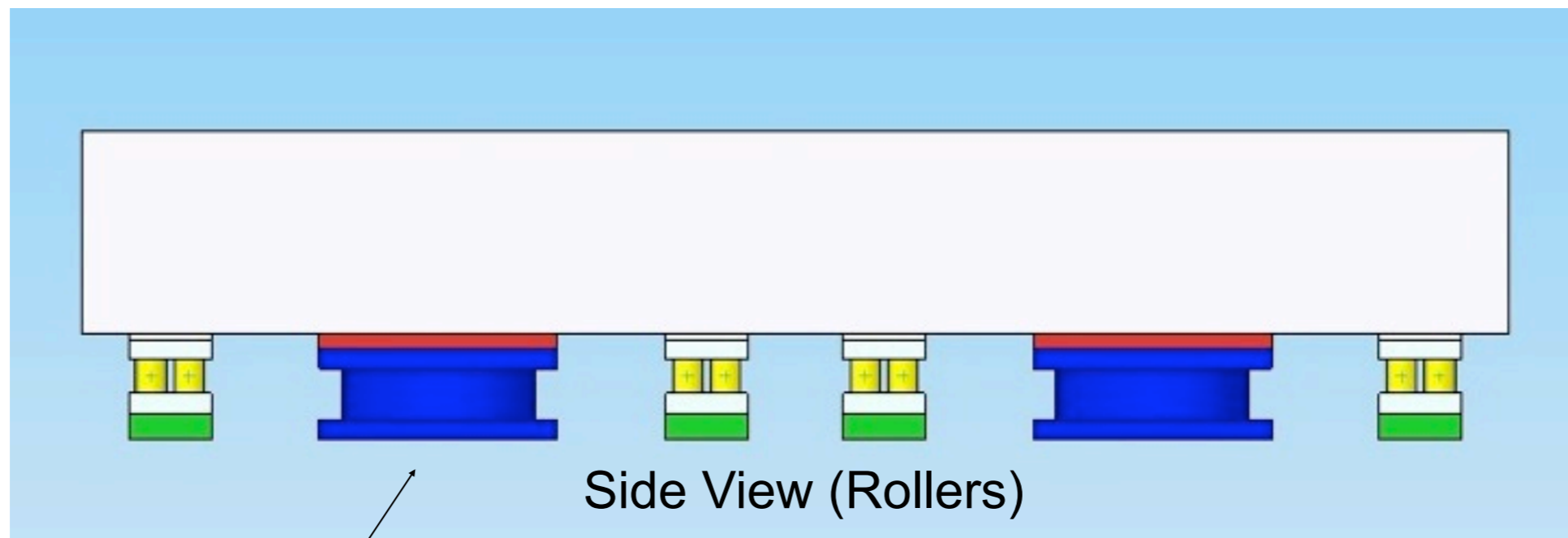
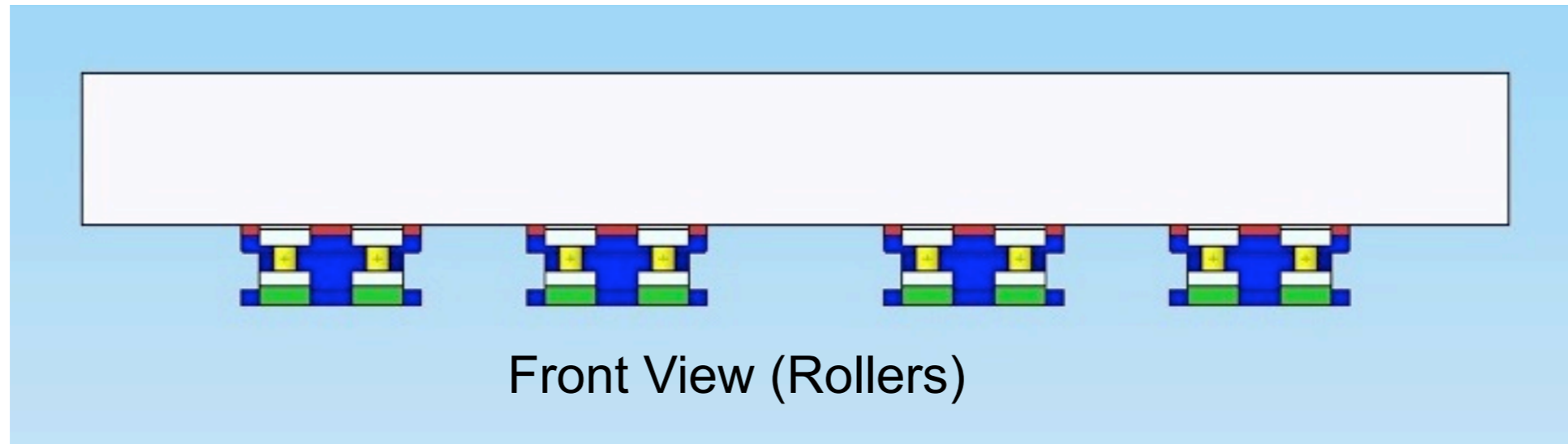

Anti-seismic Supports

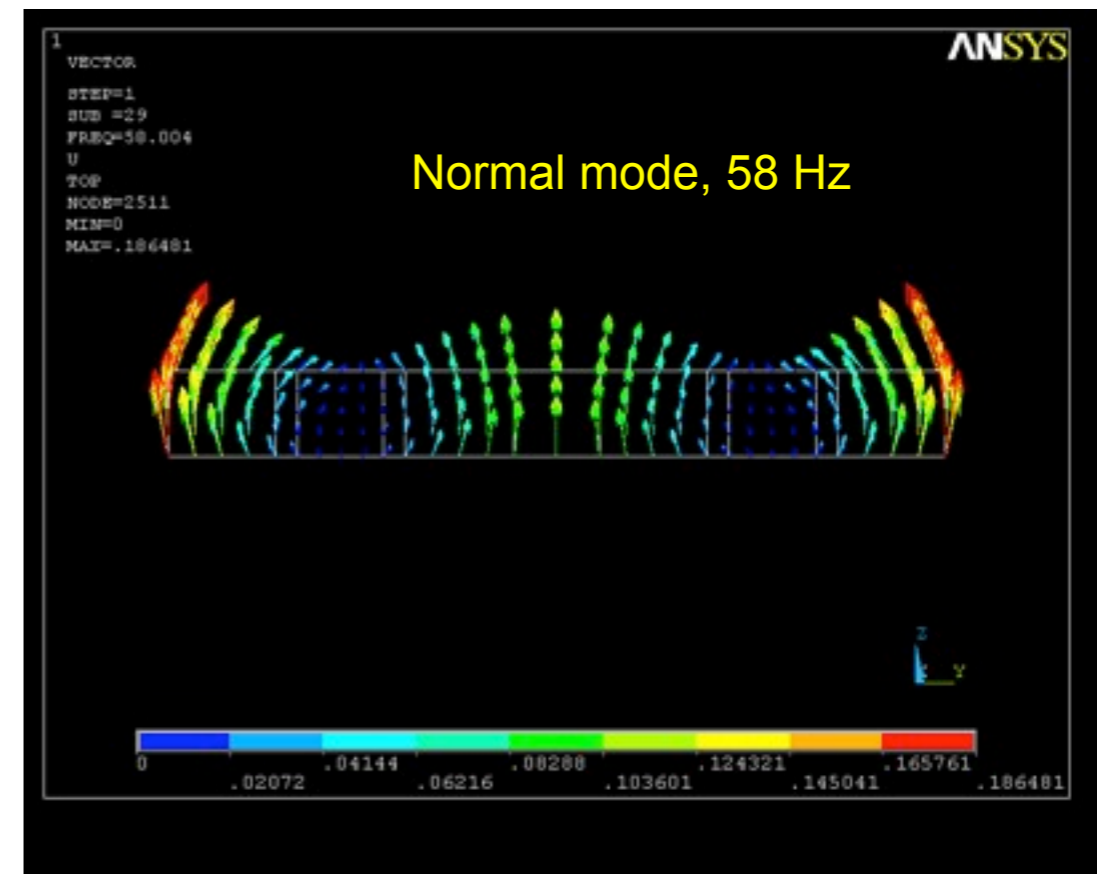
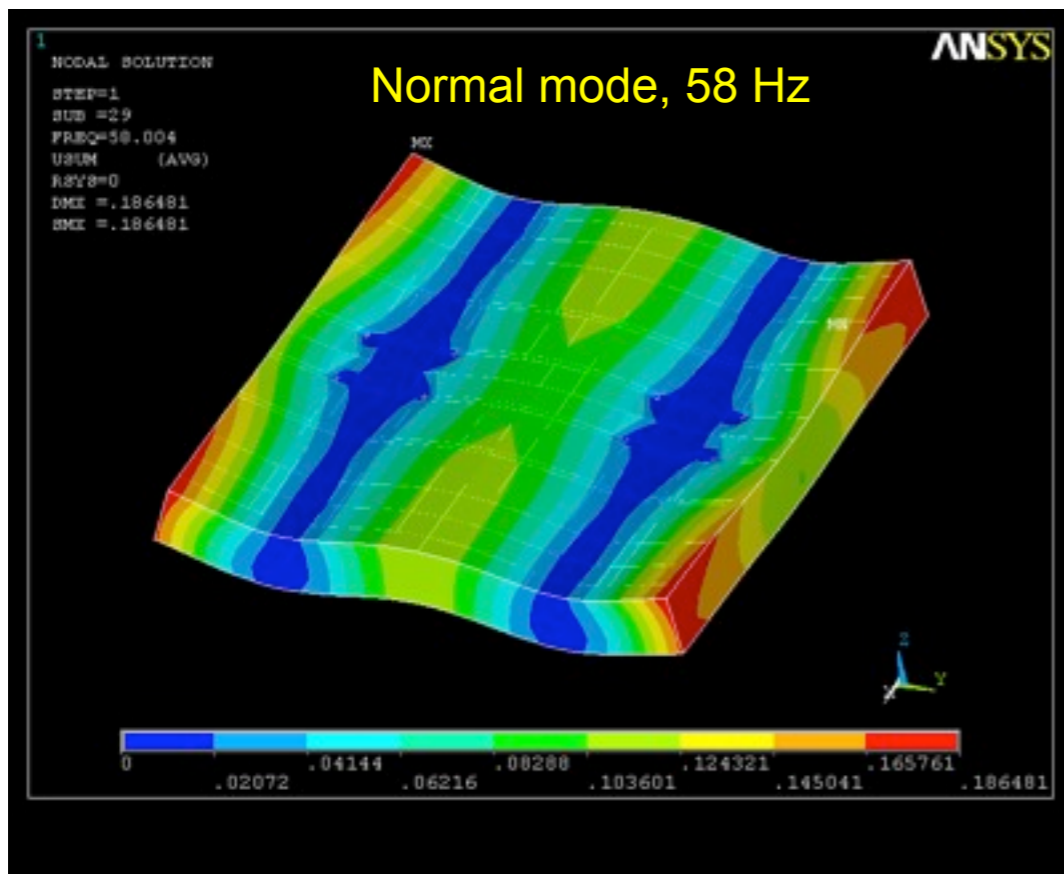
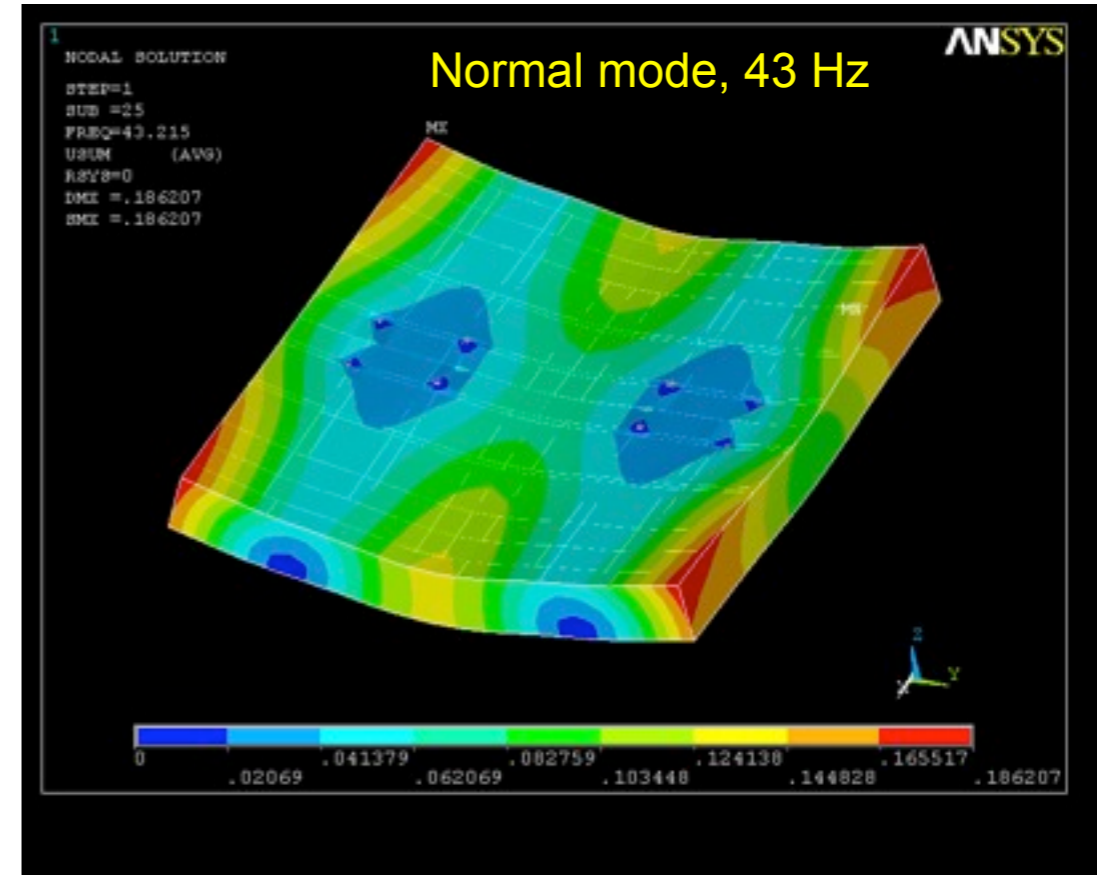
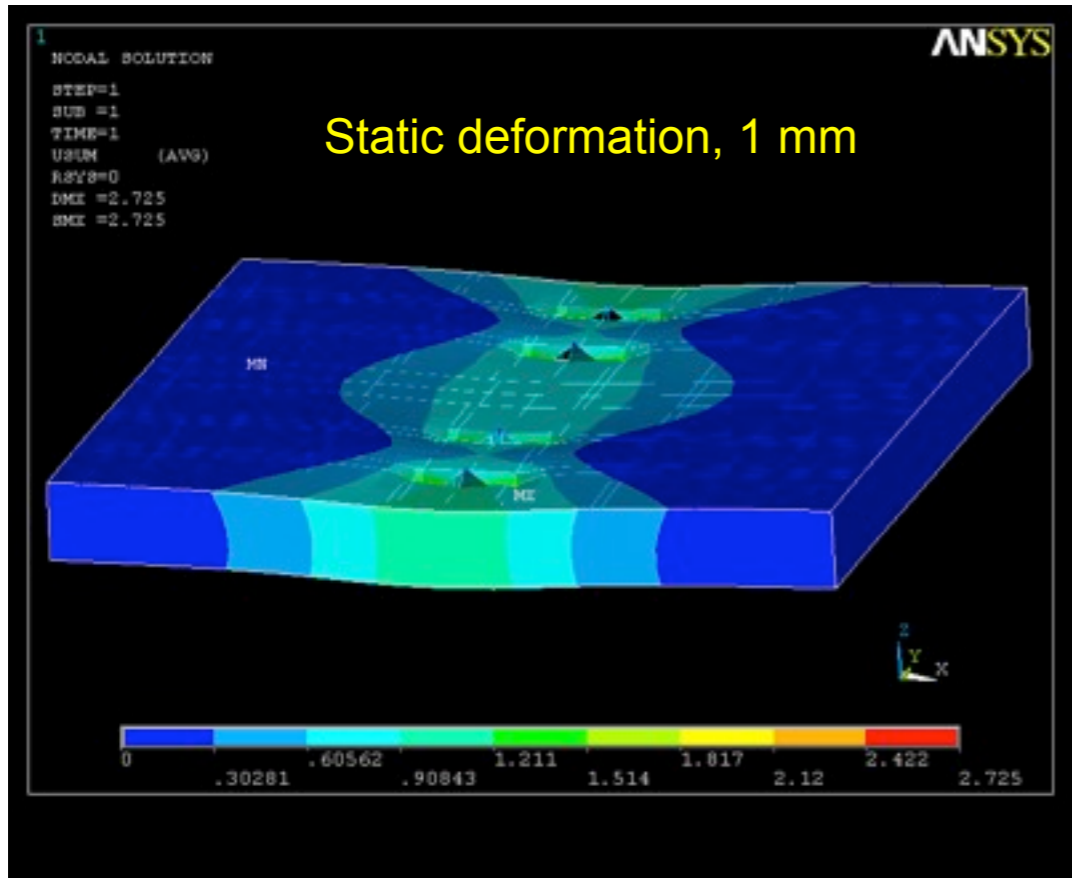

Need these studies for ILD !

Random vibrations

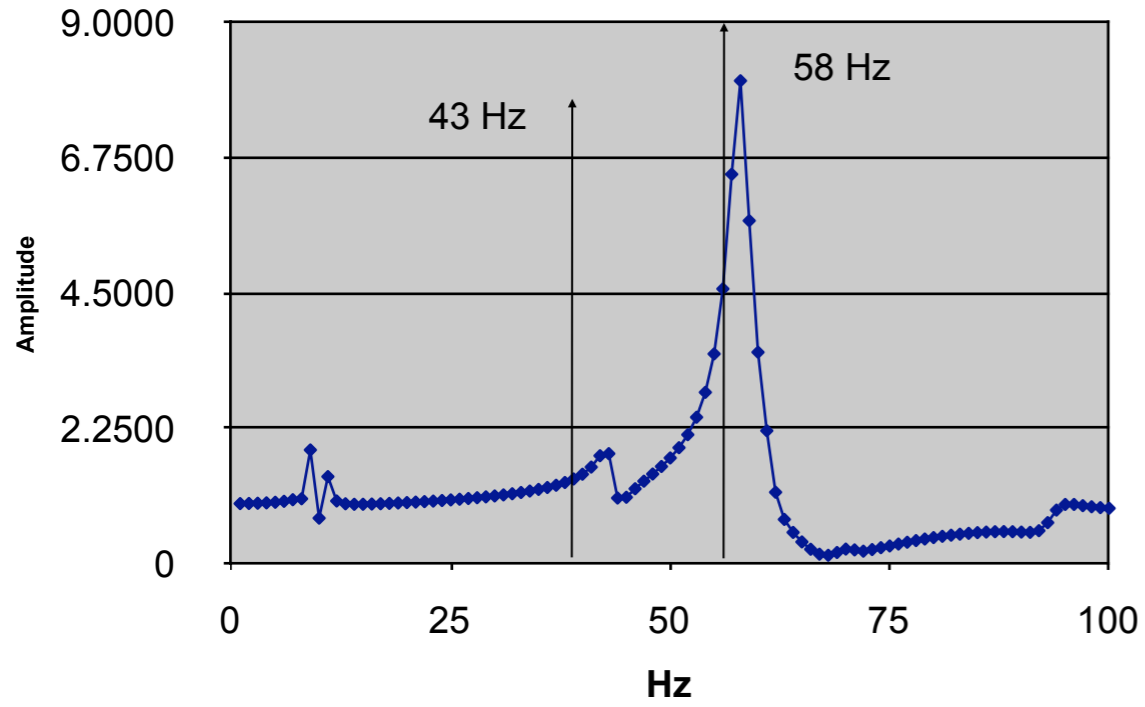

Frequency Response Platform

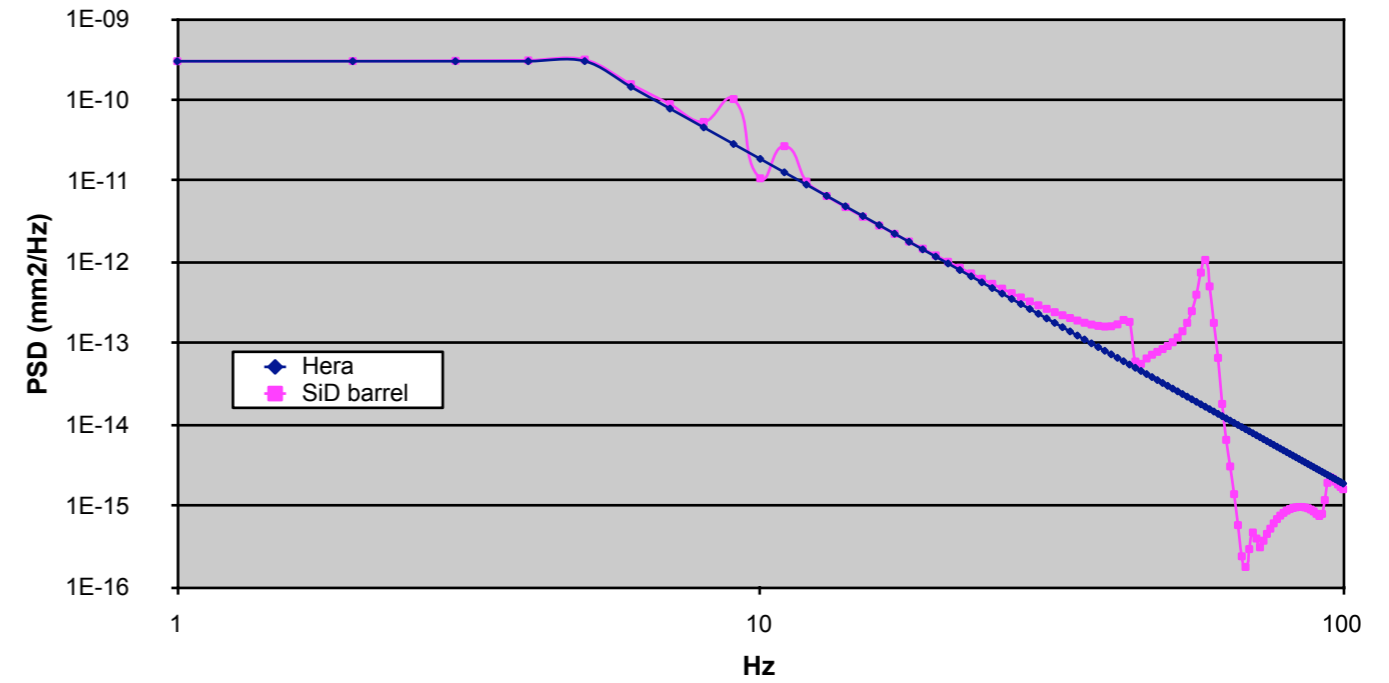

PSD response Platform

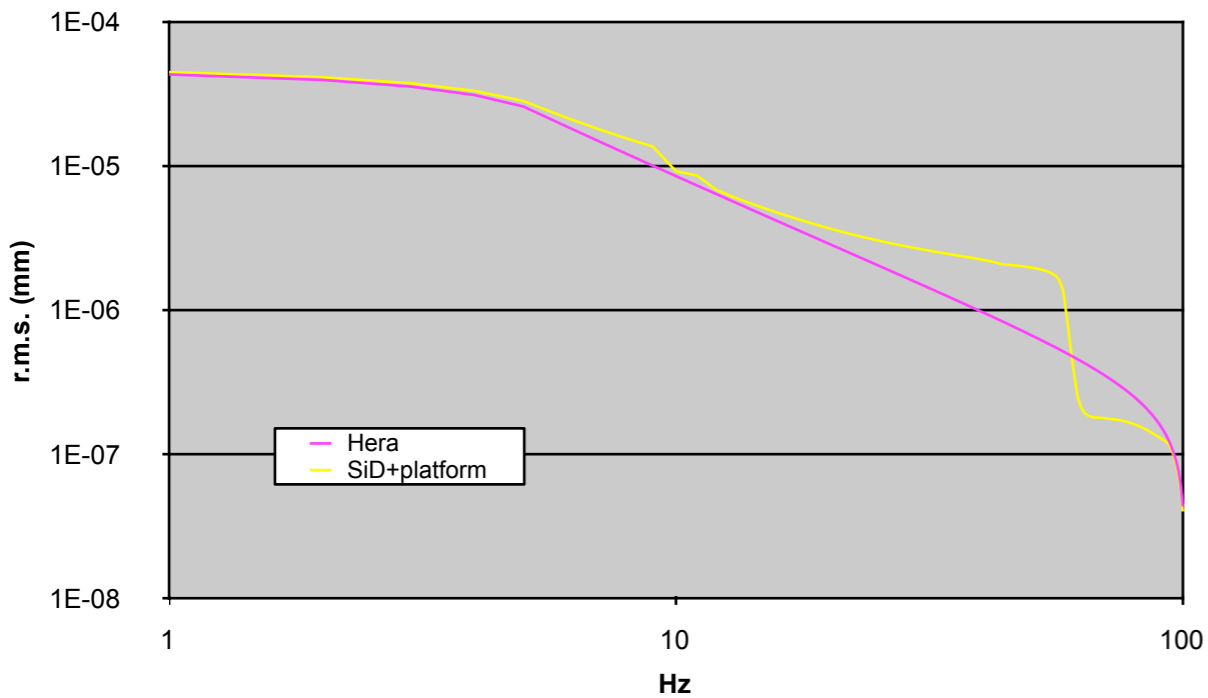

Integrated r.m.s. (mm)

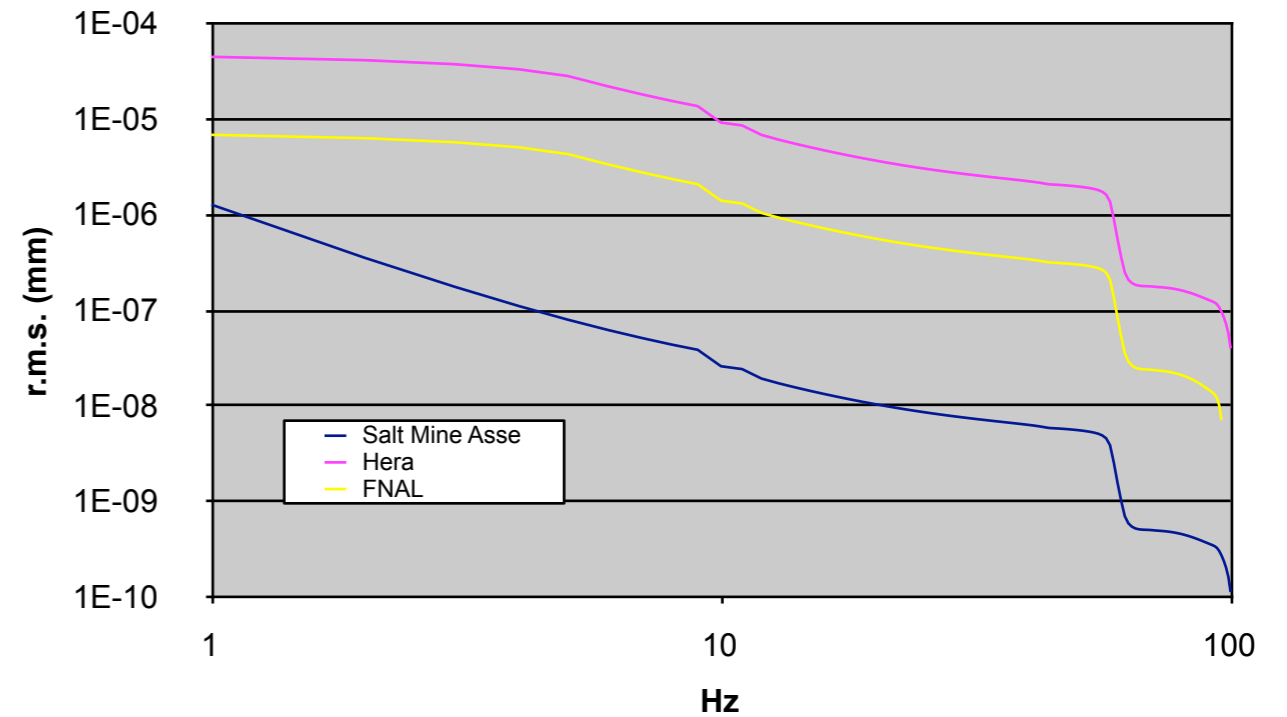

Integrated r.m.s. (mm)

Cable-chains and power bus-bars

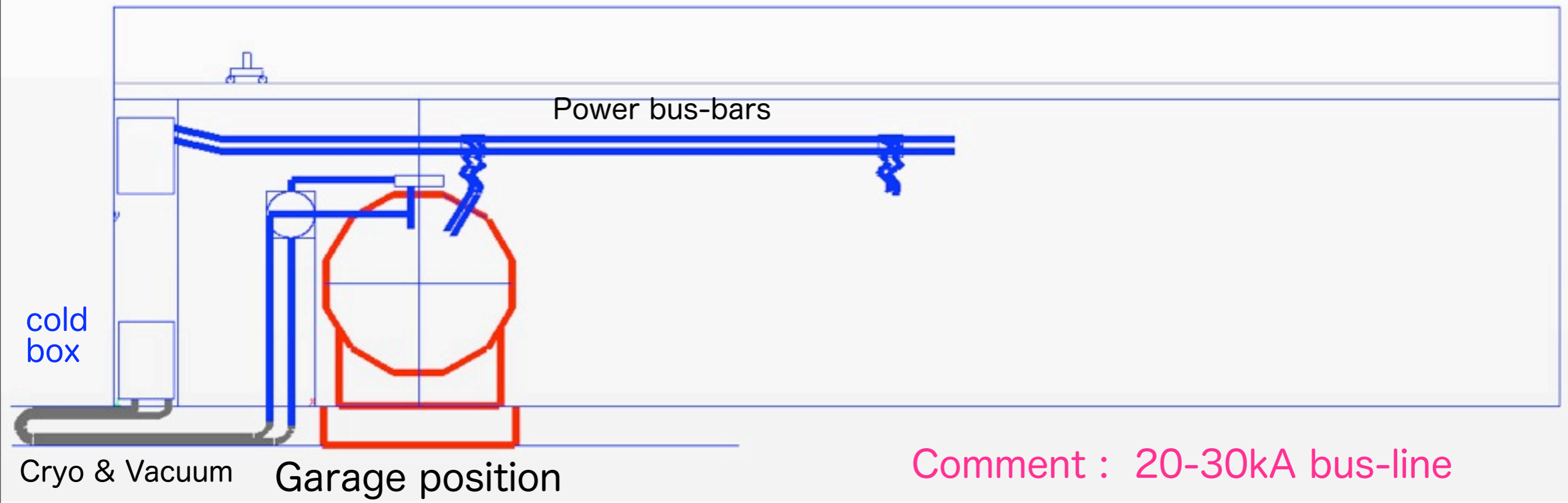

Comment : 20-30kA bus-line work is a nontrivial task !

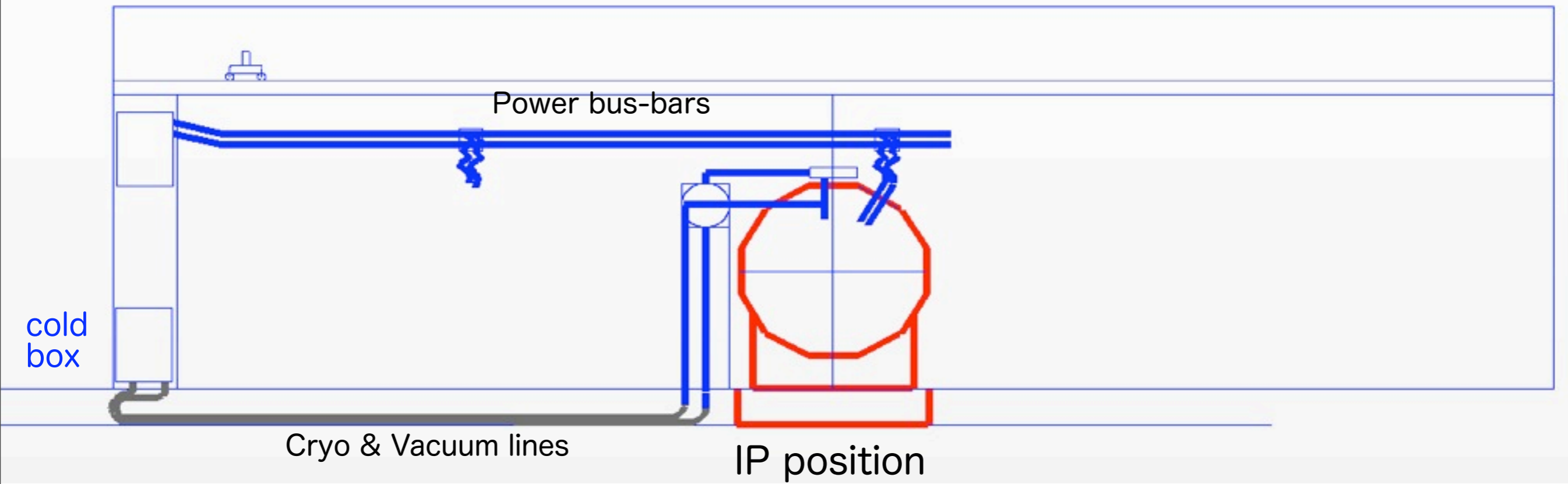

Detector Switchover Time Estimation : Goal

Procedures - about 2 days for the full push-pull operations after procedures have been optimized based on experiences	time in hours
Securing beams	1
Powering down of the detector solenoid (2GJ and 18.2kA to zero)	3
Stability work for pressure and temperature in the cryogenics system	3
Removing the radiation shield between detector and hall	2
Disconnecting all local supplies (in principle only the main bus-bar)	3
Disconnecting the beam pipe between the QD0 and the QF1 magnets	2
Moving the detector out towards its garage position (2.1mm/s in 15m)	2
Connecting back the main bus-bar in the garage position	3
Reversed procedure for the incoming detector	19
Pressure in the beam pipe: filled with inert gas and pumping to 10^{-5} Pa	several
Alignment and calibration of the detector system in the beam line	several

Comment : Stability due to movement of about 12kton detector - a site study

Summary of Push-pull Issues

1. Switchover Time for Roll-out and Roll-in

2 day without disconnection of all cables and pipes

or, 1 week with disconnection of high pressure line
and the cold box on the platform

2. Re-commission the ILC at the nominal luminosity

It should take short time, a few days at least.

3. Alignment of sub-detectors

Their relative positions should be kept,..... on the platform.

At least, they should be monitors.

4. Calibration of sub-detectors

We should identify specific calibrations in each sub-detectors.

5. The full push-pull operations would be about 2 days;

after procedures have been optimized based on experiences.