



Laboratoire d'Annecy-le-Vieux
de Physique des Particules



LCWS12 International Workshop on
Future Linear Colliders University of Texas at Arlington, USA
22-26 October 2012

Vibration Stabilization Experimental Results

CLIC Main Beam and Final Focus Magnet Stabilization

A.Jeremie

LAPP: A.Jeremie, S.Vilalte, J.Allibe, G.Balik, L.Brunetti, G.Deleglise, J.P.Baud

CERN: K.Artoos, M.Esposito, P.Fernando Carmona, M.Guichard, C.Hauviller,
A.Kuzmin, R.Leuxe, R.Moron Ballester

SYMME: B.Caron, A.Badel, R.LeBreton

ULB: C.Collette

Nikhef: S.Jansens



In2p3

Outline

- Introduction
- Final Focus quadrupole stabilization
- Main Beam Linac quadrupole stabilization
- Global performance
- Conclusion and identification of limiting factors

Introduction

- Although the two systems shown have different demonstration objectives, the final MDI stabilisation system will probably take the best of both...
- Or something completely different...

Why do we need stabilization?

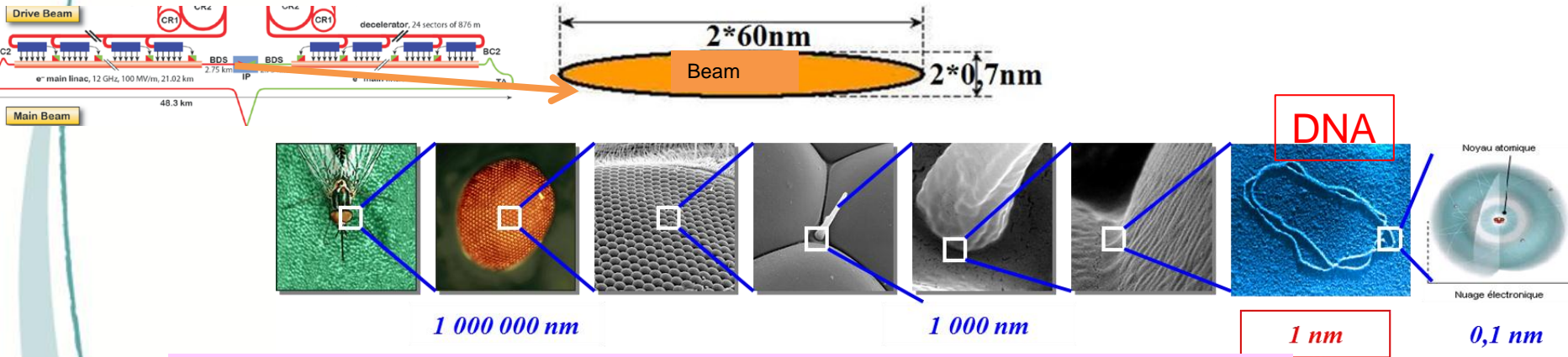

But Vibration Sources can amount to 100s of nm:

Ground motion, Traffic, Lifts, cooling water, ventilation, pumps, machinery, acoustic pressure

Transmitted:

- from the ground through the magnet support,
- directly to the magnet via beam pipe, cooling pipes, cables...

We cannot rely only on the quietness of the site
Stabilization techniques have to be developed

What we are aiming at

- Ground motion has an impact on luminosity
=> especially when beam guiding quadrupole magnets vibrate

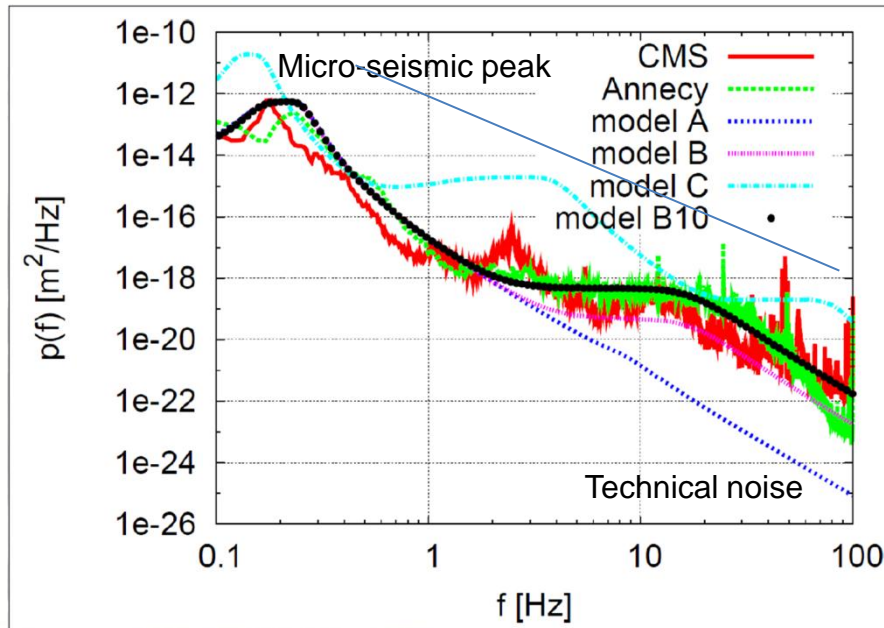

	FF	MBQ
Vert.	0.2 nm > 4Hz	1.5 nm > 1 Hz
Lat.	5 nm > 4 Hz	5 nm >1 Hz

- At the IP (mechanical + beam feedback), we aim at 0,1nm at 0,1Hz

	<1Hz	1Hz<f<100Hz	100Hz<f
Beam-based feedback		Mechanical stabilisation	Low Ground motion

Active Stabilization techniques have been chosen

What is needed?

Active Stabilisation means :

measure

=>

decide action

=>

act

sensor



- measure sub-nanometre
- low frequency
- Large band width (0.5-100Hz)
- Low noise
- Smallest delay for real-time
- Small and light
- => **Seismic sensors**

feedback/-forward

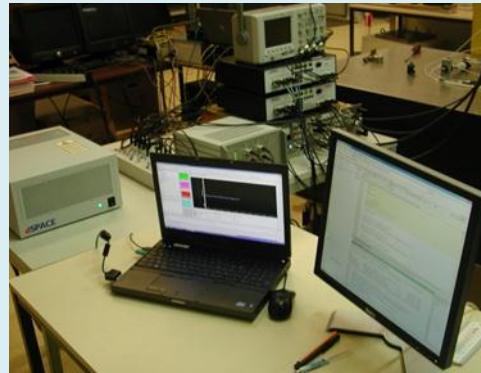

- real-time feedback
- Multi-channel
- simulation possibilities
- Fast electronics
- Large dynamics(>16bits)

actuator



- Nanometre displacement
- Displace heavy weight
- Compact
- Real-time response
- => **Piezoelectric actuator**

Accelerator environment

=> Magnetic field resistant and radiation hard

2 « similar » active solutions

Main Beam Linac quadrupole demonstration (« CERN »)

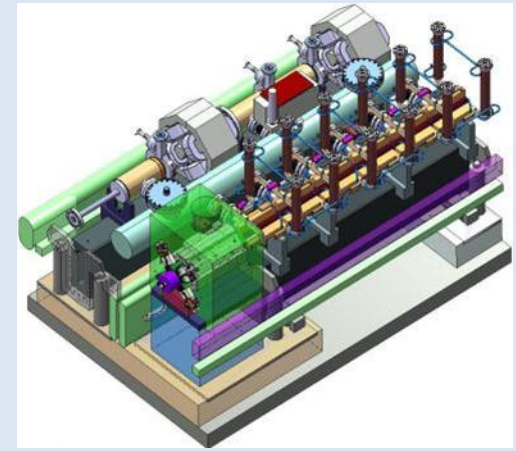
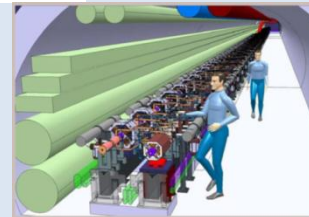
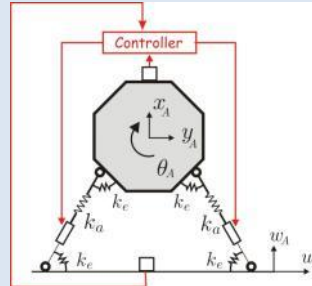
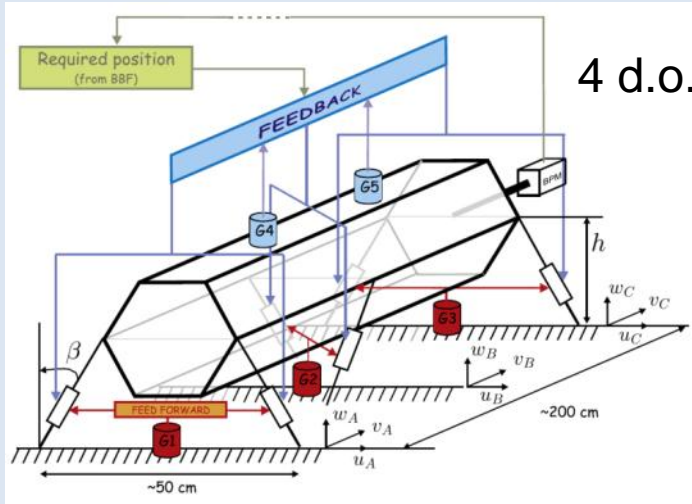

Final Focus quadrupole demonstration (« Annecy »)

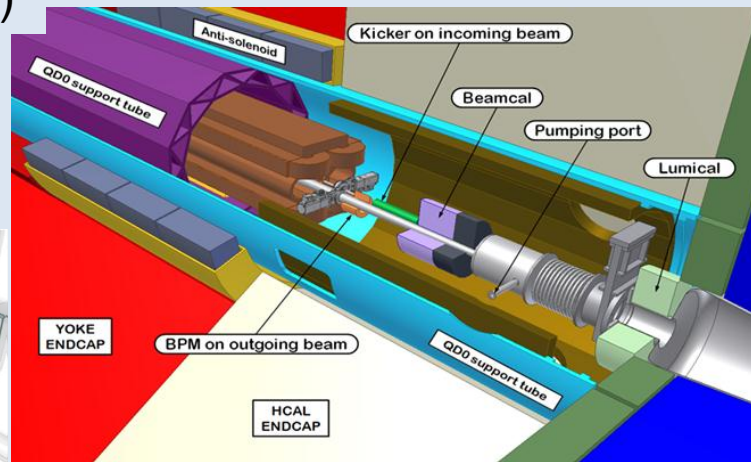
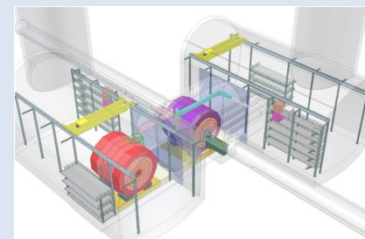
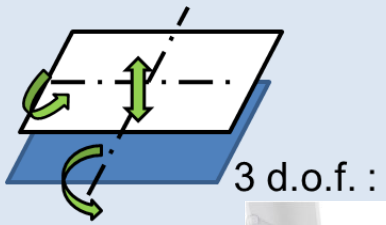
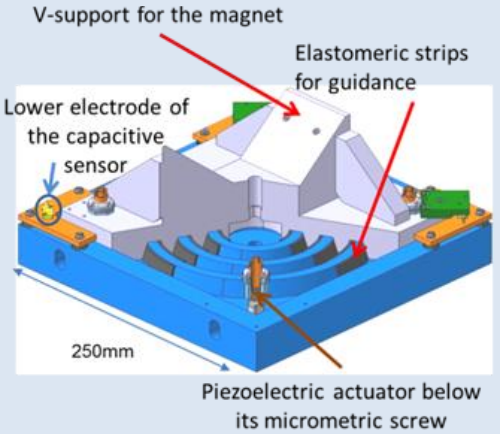

Magnets to be stabilised

Main Beam quadrupoles

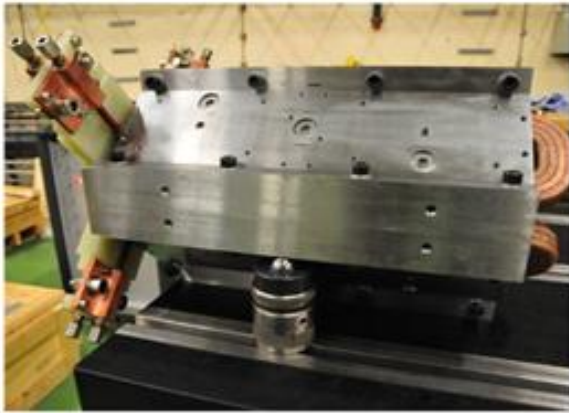

Type 1
500mm
100kg



Type 4
2000mm
450kg

Final focus quadrupole prototype

Permanent magnet (Nd₂Fe₁₄B) + coils



Final Focus Stabilization

- Mechanics
- Instrumentation
- Electronics and acquisition
- Results

Final Focus quadrupole: Passive and active solution

A. Gaddi et al.

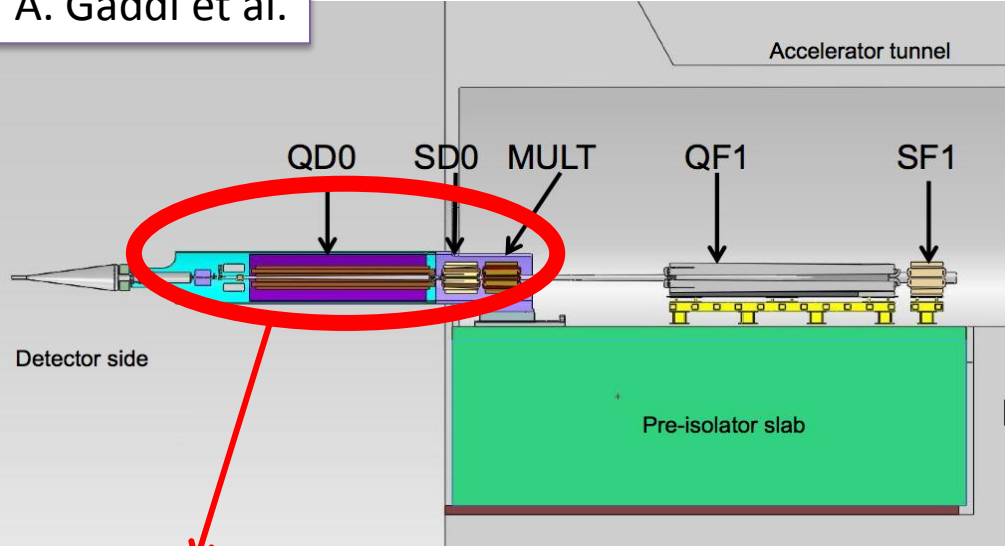

Add coherence between QD0 and QF1 and reduce band-width on which active stabilisation has to act

V-support for the magnet

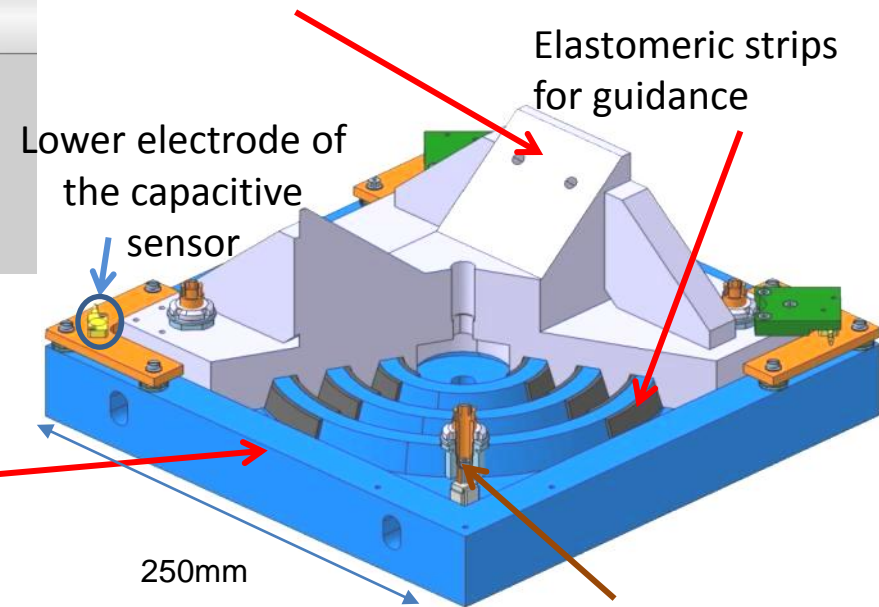

Additional passive stage directly under active system is also envisaged

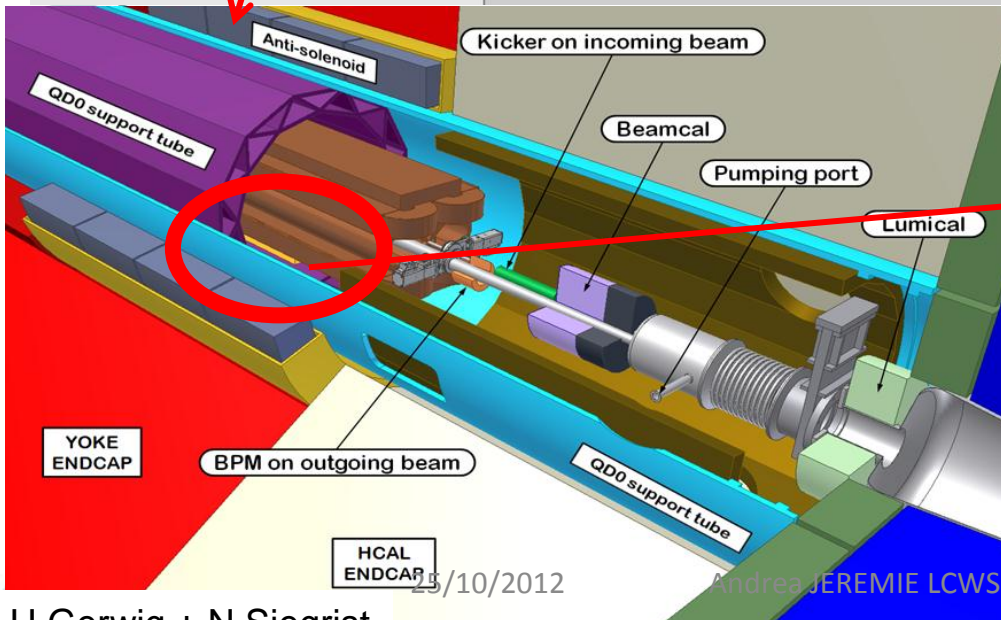

29/10/2012

Andrea JEREMIE LCWS2012 Arlington, Texas

10

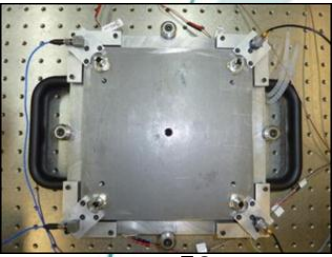

Mechanical characteristics

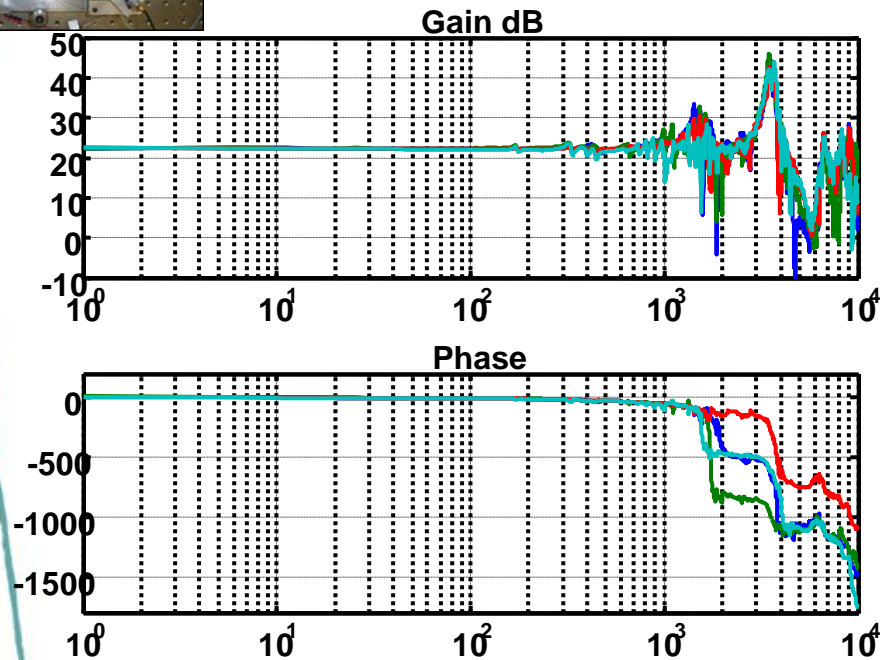

Intrinsic resonances if change of phase by 90° : other peaks just from boundary conditions
=> 2 resonance peaks just below 2kHz and near 4kHz.

First intrinsic resonance frequency near 2kHz : experimental and theoretical values agree.

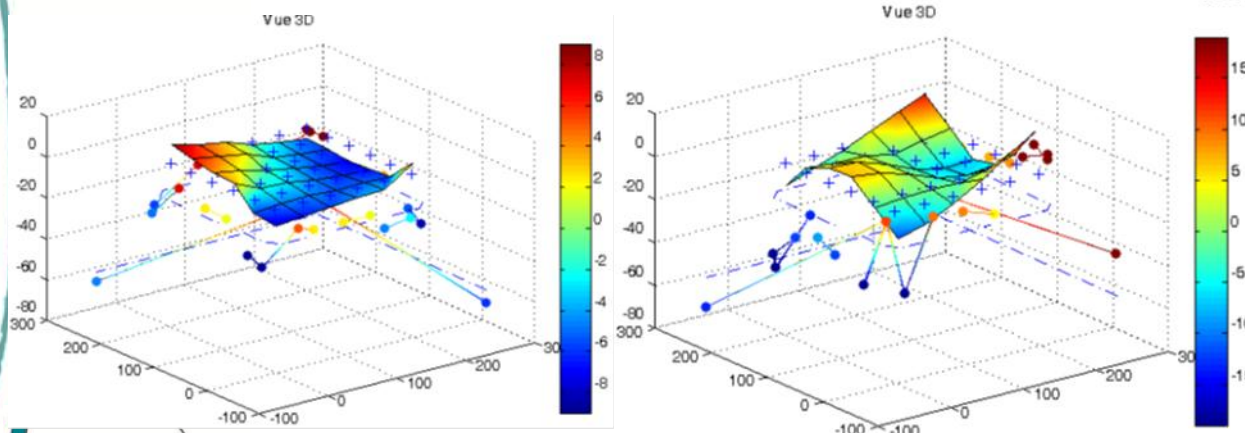

Sensors and actuators

Sensor type	Electromagnetic Geophone		Piezoelectric Accelerometer		Electrochemical Geophone	Capacitive
Model	GURALP CMG-40T	GURALP CMG-6T	ENDEVCO 86	WILCOXON 731A	SP500	D-015.00
Company	Geosig	Geosig	Brüel & Kjaer	Meggitt	EENTEC	Physik Instrumente
Output signal	Velocity (X,Y,Z)		Z acceleration		Velocity	Distance
Sensitivity	1600 V/m/s	2400 V/m/s	10 V/g	10 V/g	2000 V/m/s	0.67 V/ μ m
Bandwidth [Hz]	[0.033-50]	[0.033-100]	[0.01-100]	[0.05-500]	[0.0167-75]	[0-3000]
Mass [g]	7500	2600	771	555	750	<10
Zeros	[999, 0, 0, 0]	[0, 0, 0]		Real part < 0		

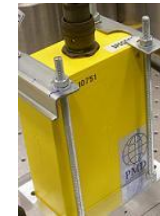

PPA10M piezoelectric actuators

Resolution	Resonance	Response time	Max Force	Max displacement
0.08nm	65kHz	0.01ms	400N	8 μ m

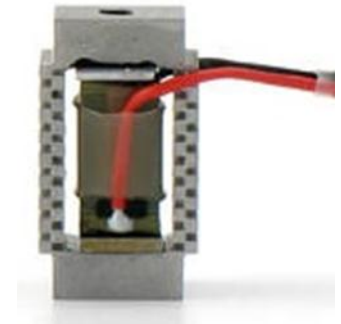

Experimental set-up

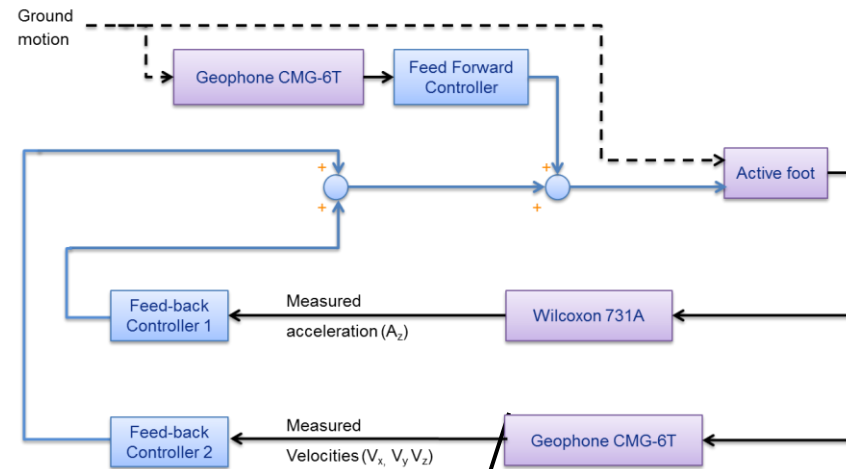

Amplifiers, filters,
inputs/outputs, signal
conditioning

Matlab and dSPACE
ControlDesk

Active system with
sensors

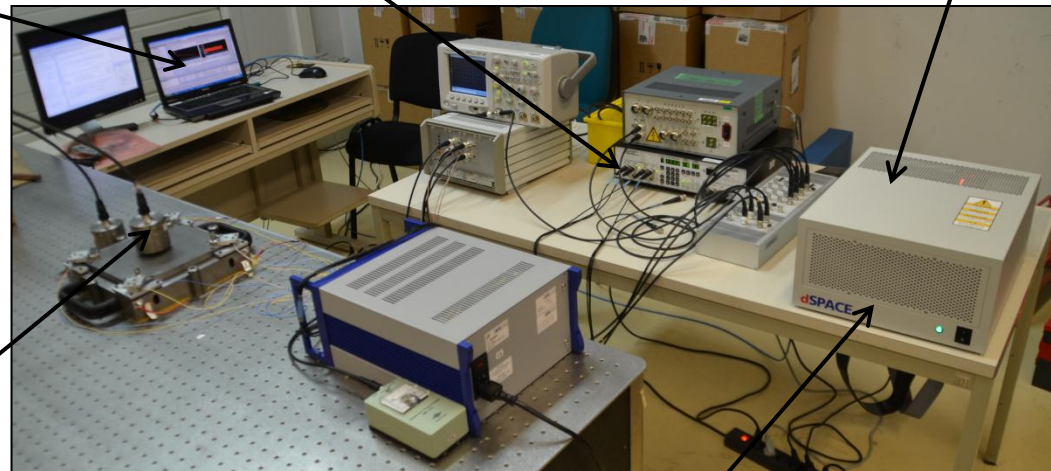

dSPACE real-time system dedicated to rapid
prototyping and simulation with 16bits ADC

FF stabilization results

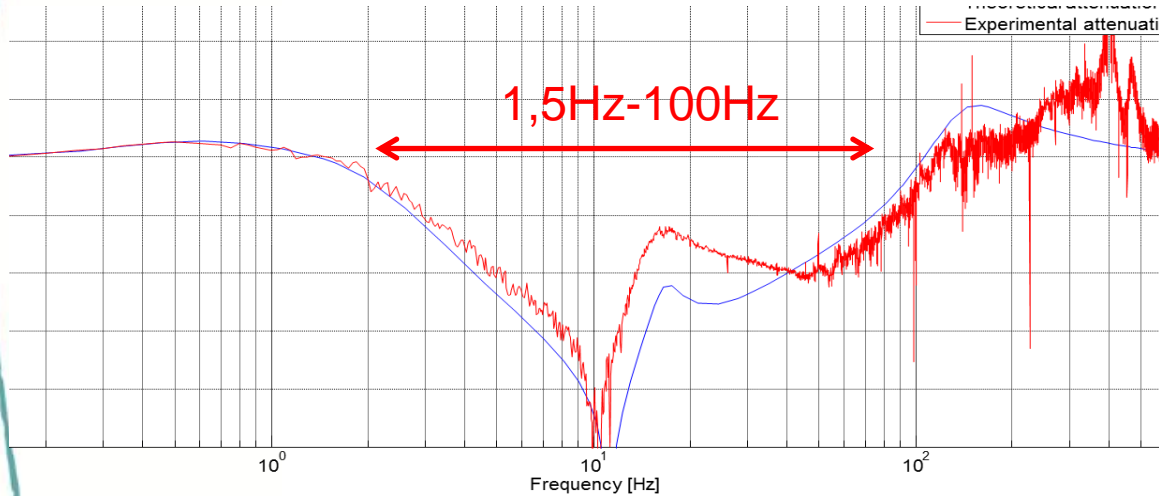

Attenuation up to 50dB
between 1,5-100Hz

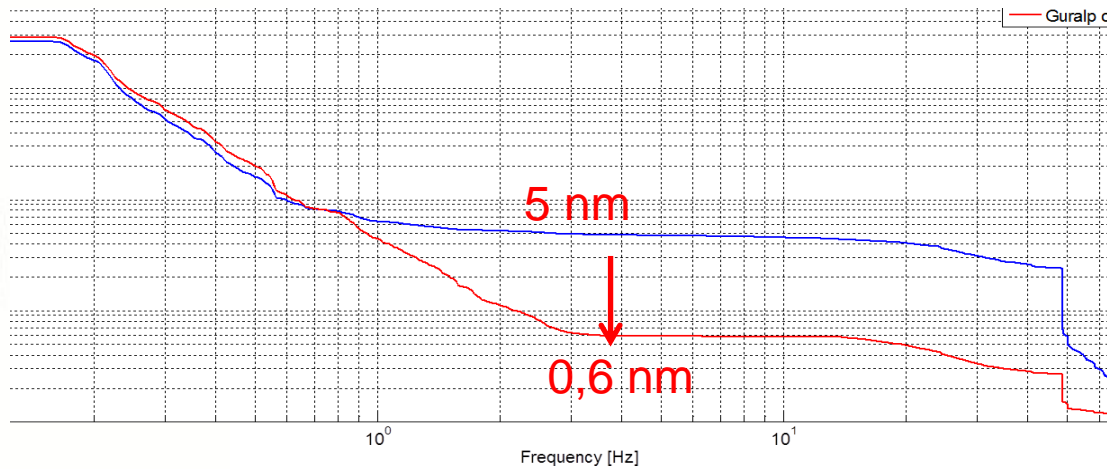
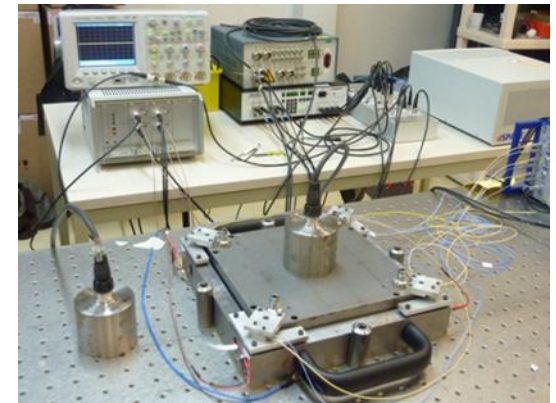
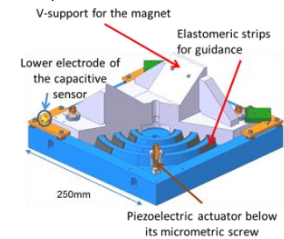

RMS ground at 4 Hz: 5 nm
RMS on foot at 4Hz: 0,6nm
RMS ratio: 8,3

Main Beam Linac Stabilization

- Mechanics
- Electronics and acquisition
- Results

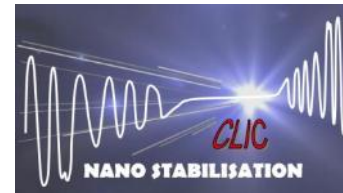

CLIC and CLIC modules

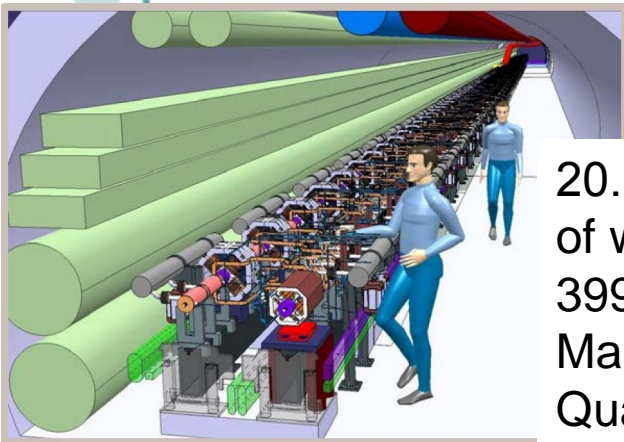
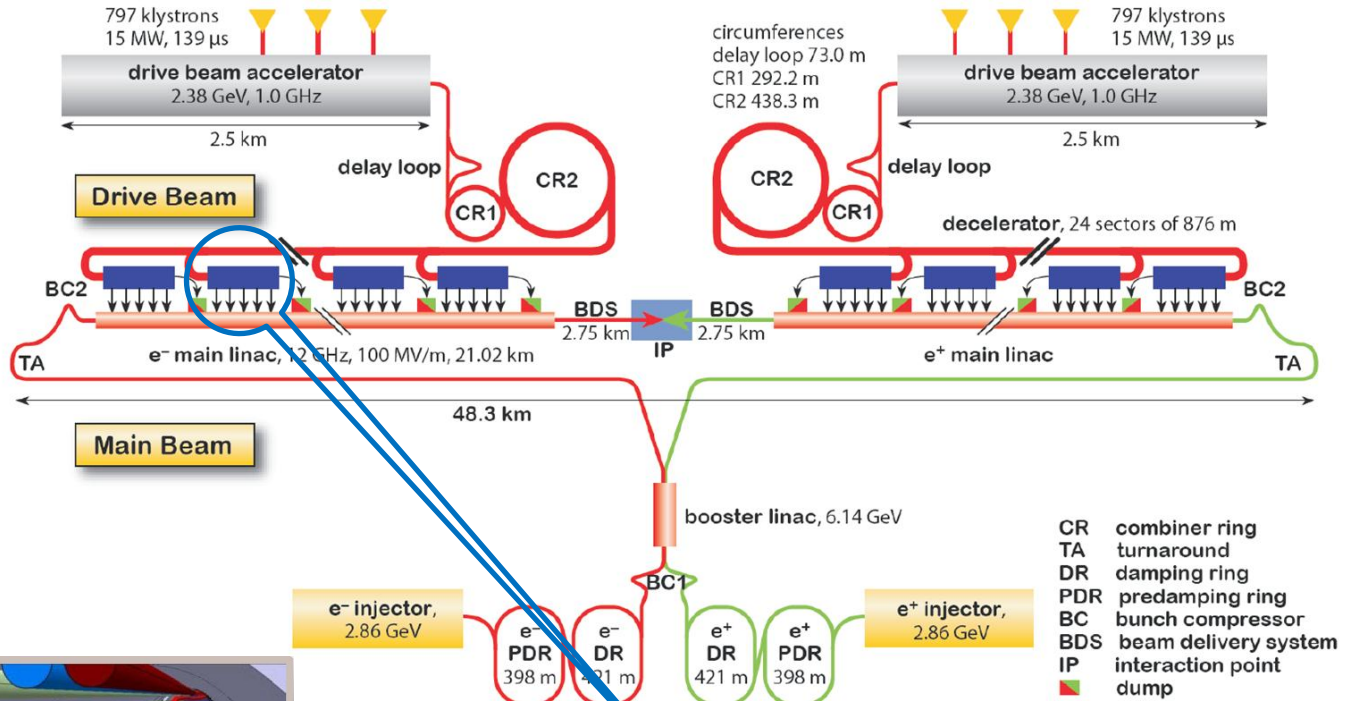

20.926 "Modules"
of which there are
3992 with CLIC
Main Beam
Quadrupoles

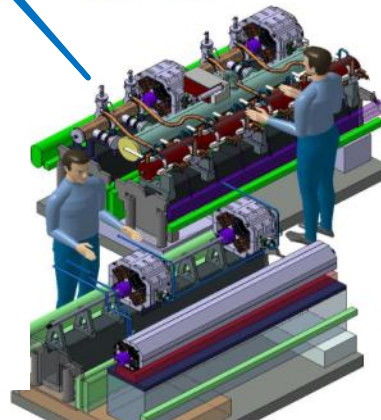

Type 0: No Main Beam Quad

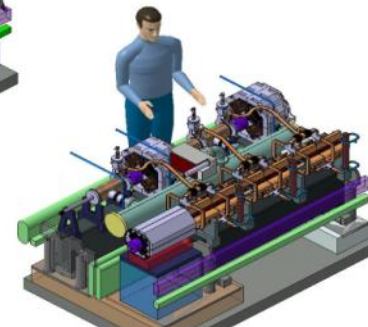

Type 1: 0.5 m, 100 kg

Main Linac Module with Type 1 quadrupole

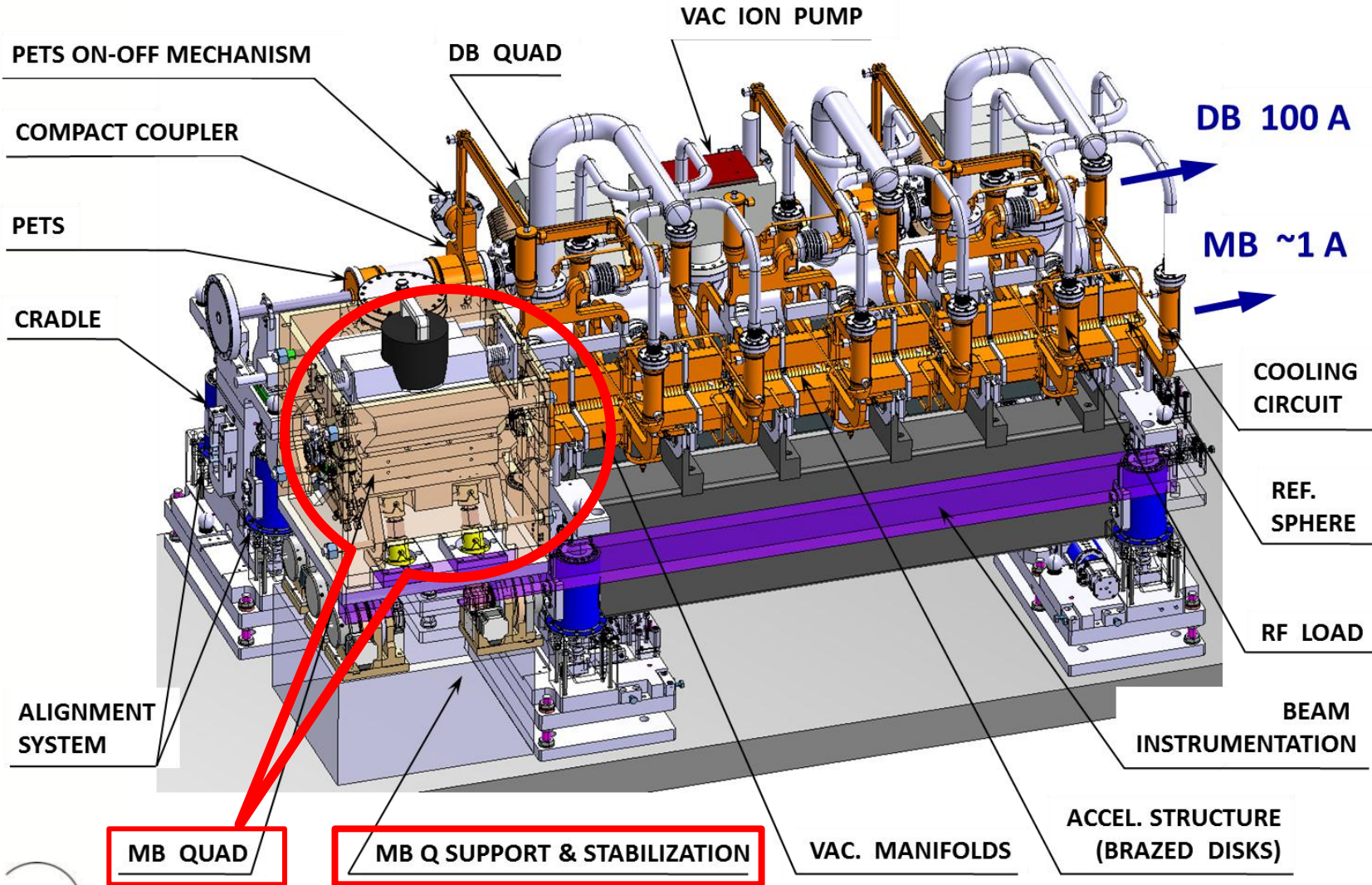

Design constraints

- Inputs:
 - ▣ Resolution 2 μV
 - ▣ Dynamic range 60 dB
 - ▣ Bandwidth 0.1-100 Hz
- Output:
 - ▣ Dynamic range 140 dB
- Resistance to radiation
 - ▣ Shielding, location, design
- Cost (~ 4000 magnets to be stabilized)
- Power restrictions (cooling)

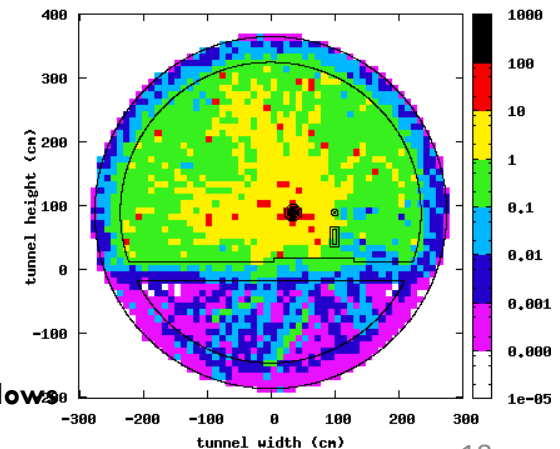
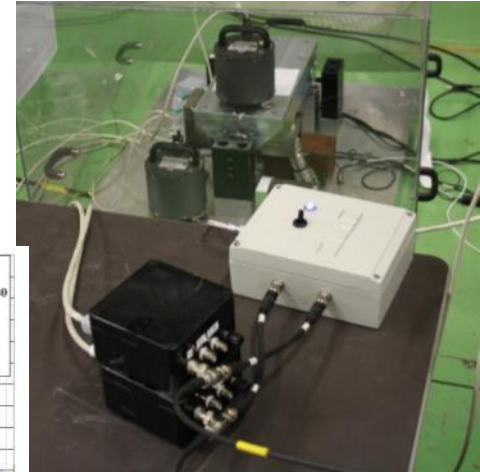
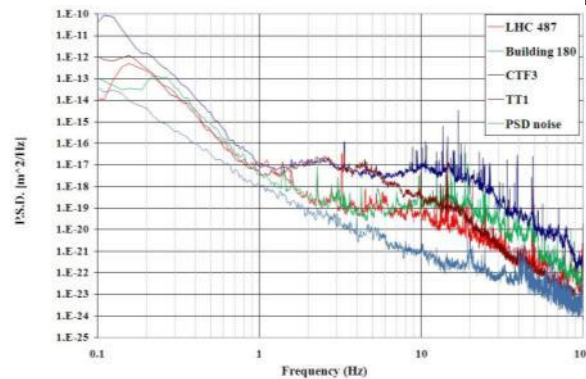

MB 9 GeV
Courtesy S. Mallozzi



Actuator support

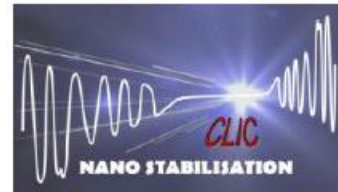

stabilisation support section made of
 Inclined stiff piezo actuator pairs with
 flexural hinges (vertical + lateral motion)
 (each magnet will have 2 or 3 sections depending on its length)



PI Piezoelectric Actuator
 High stiffness ($480\text{N}/\mu\text{m}$)
 Sufficient travel ($15\ \mu\text{m}$)
 Good resolution ($0.15\ \text{nm}$)

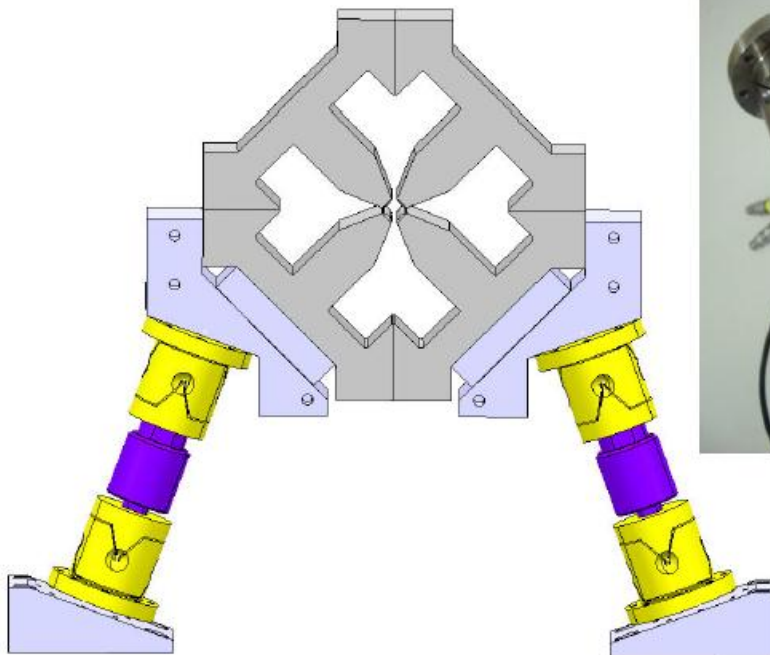

Universal Flexural Joint
 2 rotation axes in the
 same plane
 rotational stiffness
 $(k_e = 220\text{Nm}/\text{rad})$
 Axial stiffness
 $(k_{aj} = 300\text{N}/\mu\text{m})$

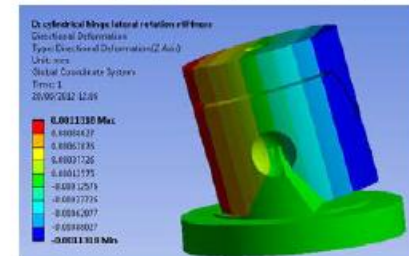
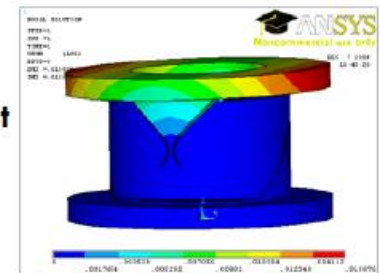



Analytical & FE results

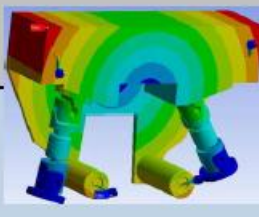
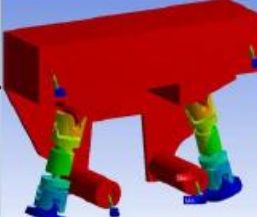
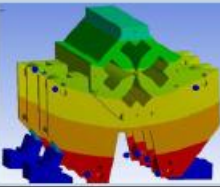
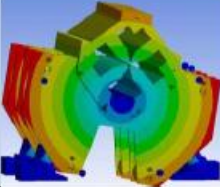
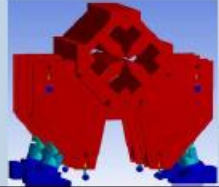

14

		Hz k_h [N/ μ m]	Vt k_v [N/ μ m]	4-bar mode		θ mode		Vertical mode	
				f [Hz]	shape	f [Hz]	shape	f [Hz]	shape
Without xy guide	Analytical	0.21	203	9.2		255		319	
	Ansys classic	0.21	204	9.2		255		319	
	Ansys WB	0.21	203	8.3		245		312	
With xy guide	Analytical	35	229	153		310		339	
	Ansys classic	44	225	125		275		327	
	Ansys WB	38	220	145		303		336	
Type 1 MBQ with xy guide	$k_h=69$ [N/ μ m]	$k_v=227$ [N/ μ m]	119 [Hz]		303 [Hz]		319 [Hz]		

Longitudinal stiffness

Without xy guide 0.03 N/ μ m	With xy guide (pins totally fixed on 1 end) 278N/ μ m	With xy guide (pins fixed to steel plates) 48 N/ μ m
-------------------------------------	---	--

Longitudinal mode

Without xy guide 3.4 Hz	With xy guide (pins totally fixed on 1 end) 280 Hz	With xy guide (pins fixed to steel plates) 65 Hz
----------------------------	--	--

Control

Component	Delay
ADC	8 μ s
Electro-optic transducer	100 ns
Optic fiber transmission	5 μs/Km
Opto-electric transducer	120 ns
DAC	3 μ s
Actuator (20nm single step)	1 μ s

Typical catalog delay values for the components

The farther away the control hardware, the less effective the stabilisation system => Need for a local controller

Control loop delay	Stabilization performance
43 μ s	100%
80 μ s	90%
90 μ s	80%
100 μ s	60%
130 μ s	30%

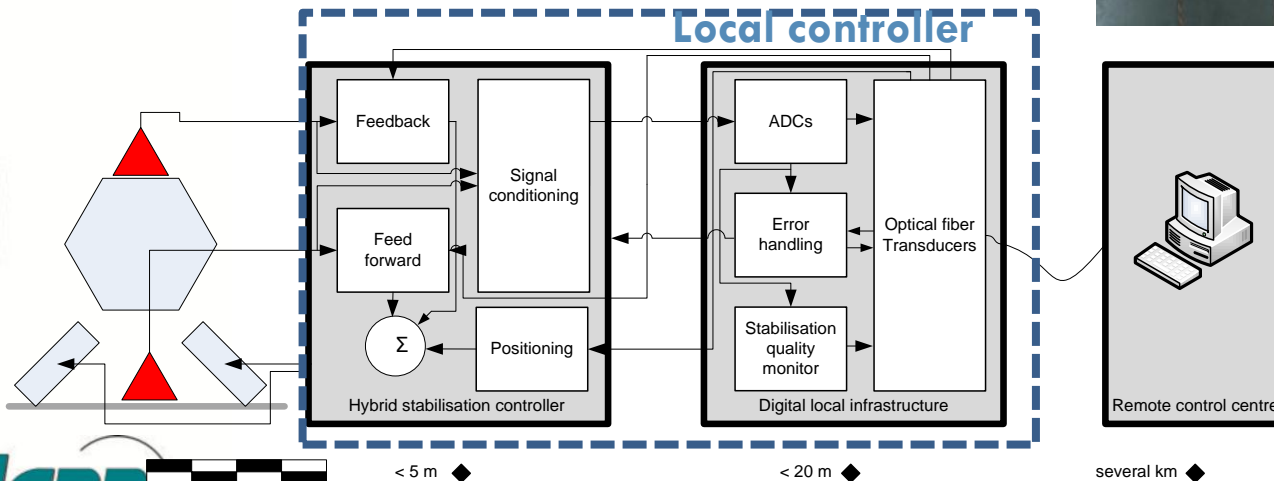

Digital and analog hybrid controller :

- Digital: flexibility
- Analog: less latency and higher radiation hardness

Stabilization on Type 1 MBQ

- Water cooling 4 l/min
- With magnetic field on
- With hybrid circuit

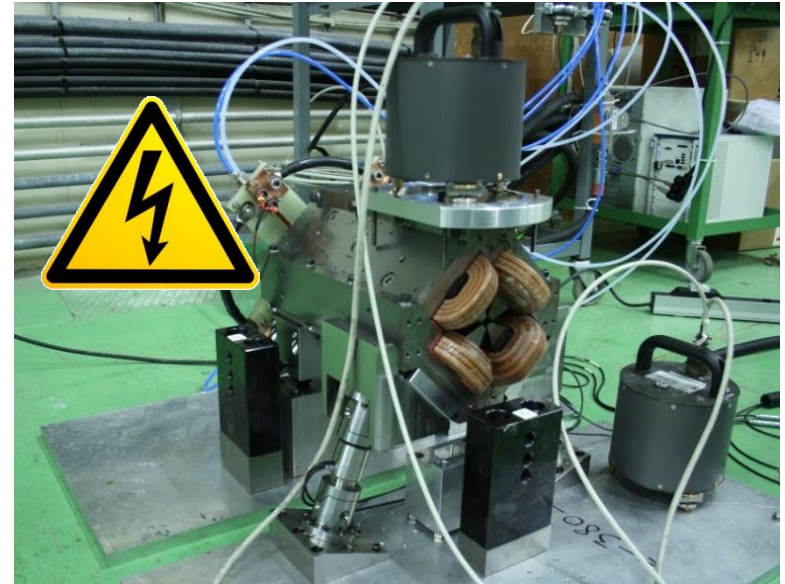
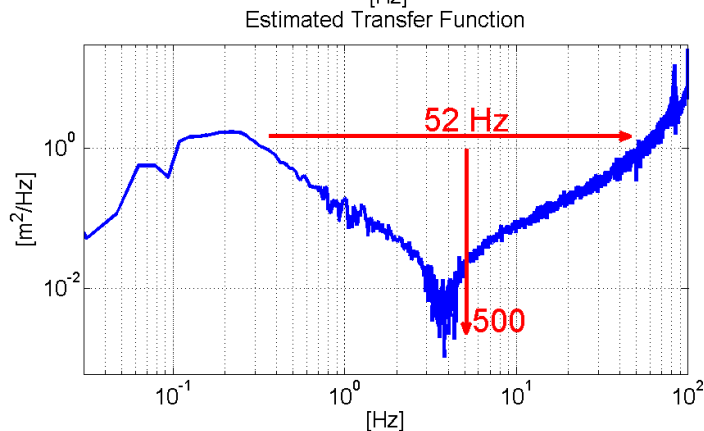
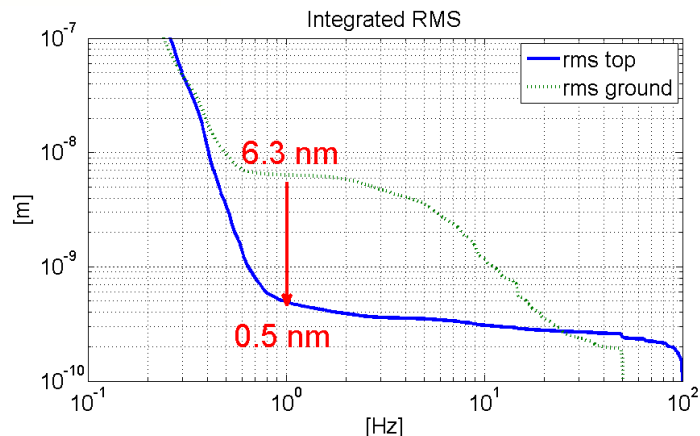

Figure

Value

R.m.s @ 1Hz magnet

0.5 nm

R.m.s @ 1Hz ground

6.3 nm

R.m.s. attenuation ratio

~13

R.m.s @ 1Hz objective

1.5 nm

Improved mechanics prototype x-y guide

- X-y guide « blocks » roll + longitudinal direction
- Increases lateral stiffness by factor 500, increases band width without resonances to ~ 100 Hz
- Introduces a stiff support for nano metrology
- cross check with interferometer

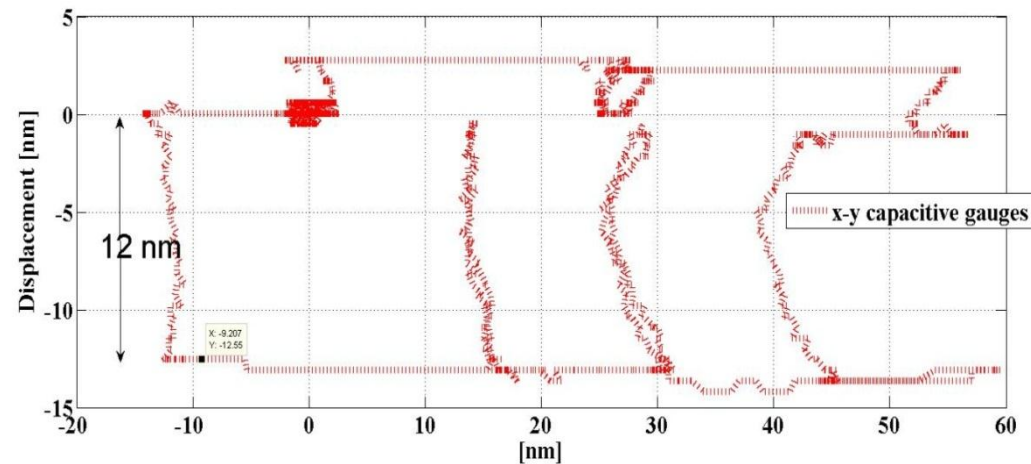
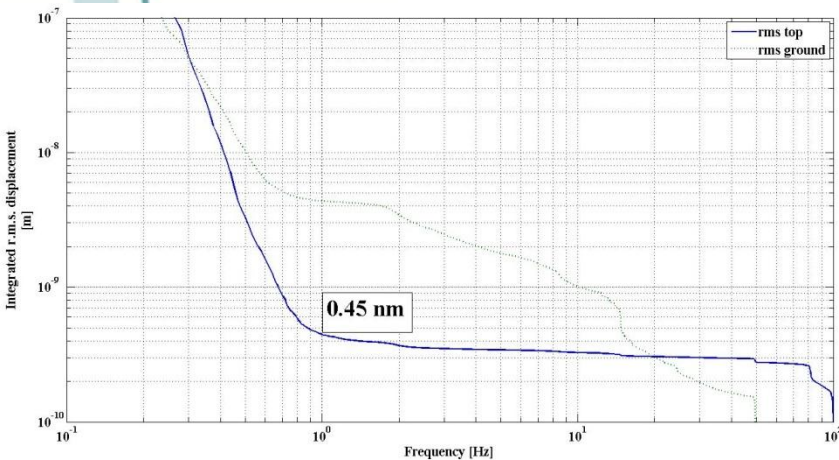
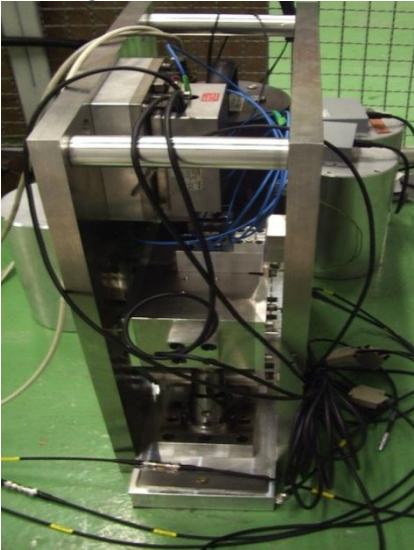
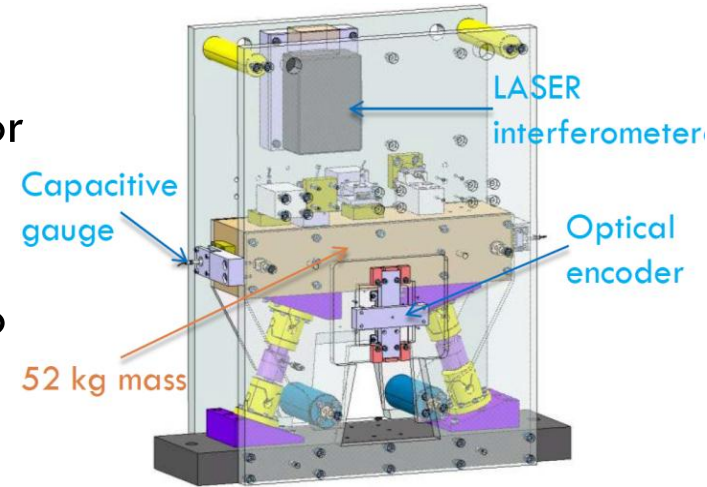

Conclusion for Stabilization

- Different domains needed:
 - Mechanics (supports, guides, mechanical resonators, ...)
 - Instrumentation (sensors, compatibility with active control, ...)
 - Electronics (acquisition & control, band-width, resolution,...)
 - Automatics (control, real time simulation ...)
 - Accelerator physics (beam simulations, luminosity at Interaction Point...).
- Sub-nanometre stabilisation performed validating CLIC stabilisation feasibility: limiting factor are the « noisy » sensors (especially limiting in the 0.8-6Hz range)
- Integrated luminosity simulations show sub-nanometre beam size at IP and less than 6% luminosity loss (see LCWS 2011 Jeremie and Collette)
- Next step: tests in accelerator environment