



# **ATF2 Technical Review**

## **Beam Size Measurement using IPBSM**

### **Performance Evaluation**

Apr 3 -4 2013

KEK, Japan

**Jacqueline Yan, M.Oroku, S. Komamiya**

(The University of Tokyo, Graduate School of Science)

Y. Kamiya, (The University of Tokyo, ICEPP)

T. Okugi, T. Terunuma, T. Tauchi, T. Naito,

K. Kubo, S. Kuroda, S. Araki, J. Urakawa (KEK)

# Introduction

**Measurement Scheme**  
**Expected Performance**  
**Role in Beam Tuning**

# Role of IPBSM (Shintake Monitor) at ATF2

**ATF2:** Linear Collider FFS test facility@KEK

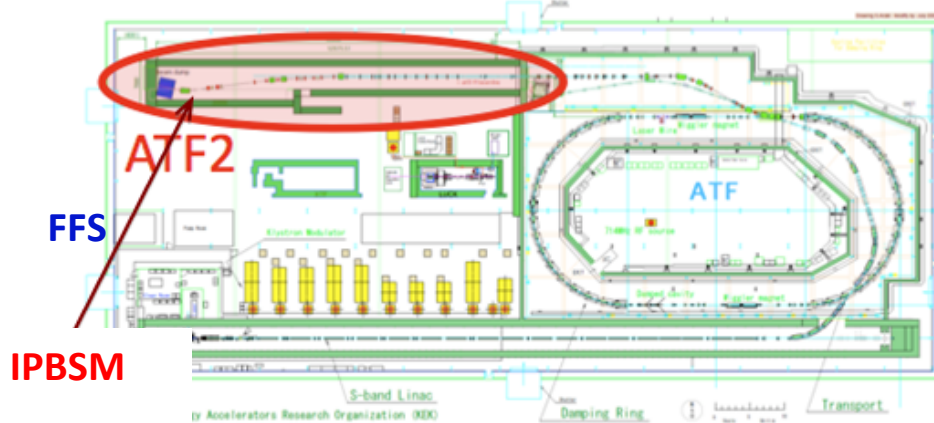

$$L = \frac{n_b N^2 f_{rep}}{4\pi\sigma_x \sigma_y} H_D$$

**Ultra-focused vertical beam size at IP !!**  
Crucial for **high luminosity**

**IPBSM is crucial for achieving ATF2 's Goal 1 !!**

focus  $\sigma_y$  to design 37 nm

→ verify Local Chromaticity Correction

## Outline

Introduction

Beam Time Status

- Dec 2012
- Jan– Mar, 2013

- IPBSM Performance
- Error studies
- Hardware Upgrades

Summary & Goals and Plans

# Measurement Scheme

- use **laser interference fringes** as target for e- beam  
**Only device able to measure  $\sigma_y < 100$  nm !!**
- Crucial for ATF2 beam tuning and realization of ILC

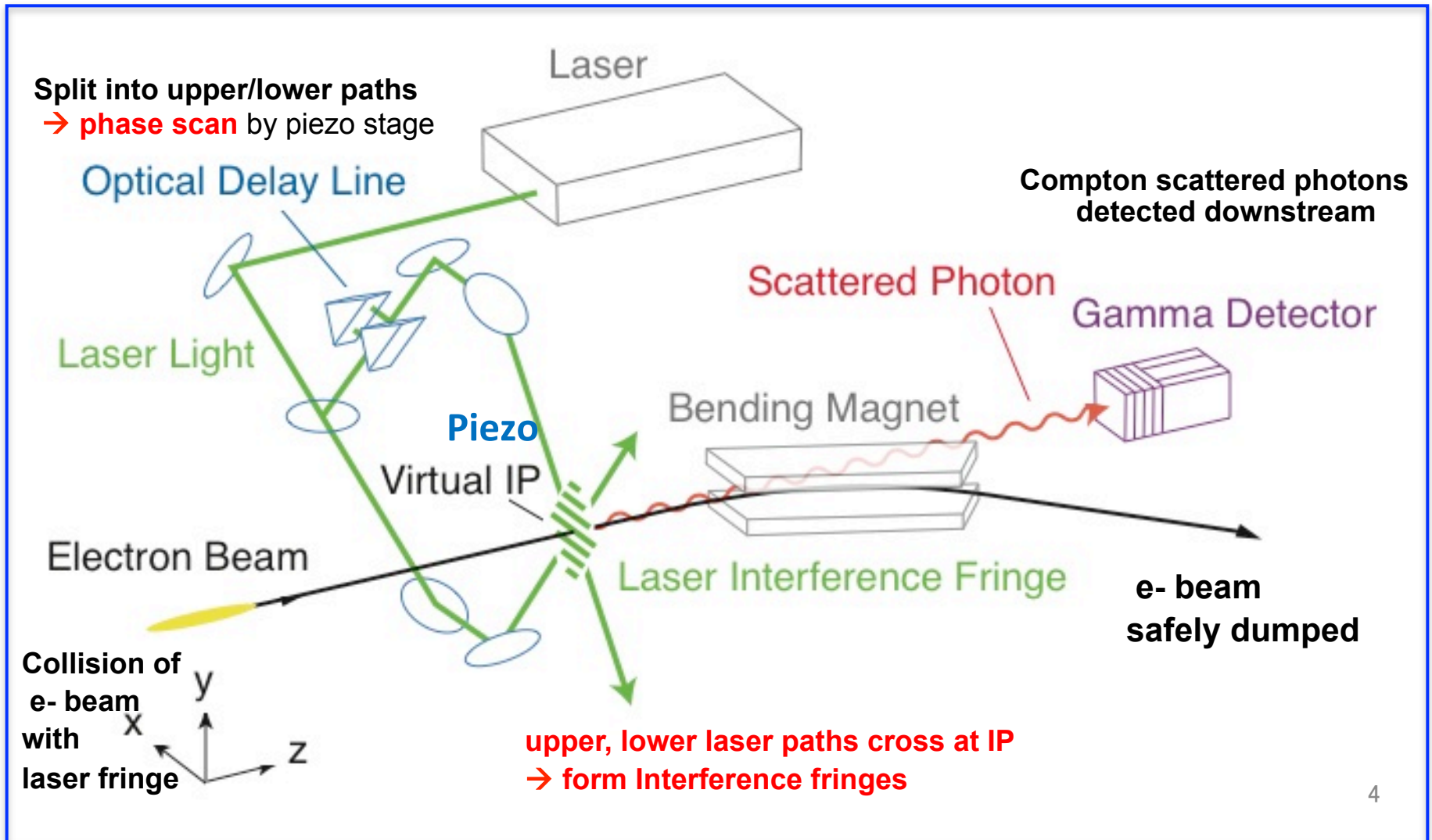



Detector measures  
signal **Modulation Depth "M"**

$$M = \frac{N_+ - N_-}{N_+ + N_-} = \left| \cos(\theta) \exp(-2(k_y \sigma_y)^2) \right|$$

$$\Rightarrow \sigma_y = \frac{d}{2\pi} \sqrt{2 \ln \left( \frac{|\cos(\theta)|}{M} \right)}$$

measurable range  
determined by **fringe pitch**

$$d = \frac{\pi}{k_y} = \frac{\lambda}{2 \sin(\theta/2)}$$

depend on  
**crossing angle  $\theta$**  (and  $\lambda$ )

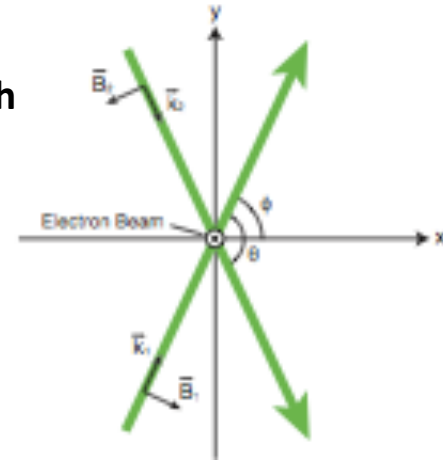

Laser Interfere Fringe

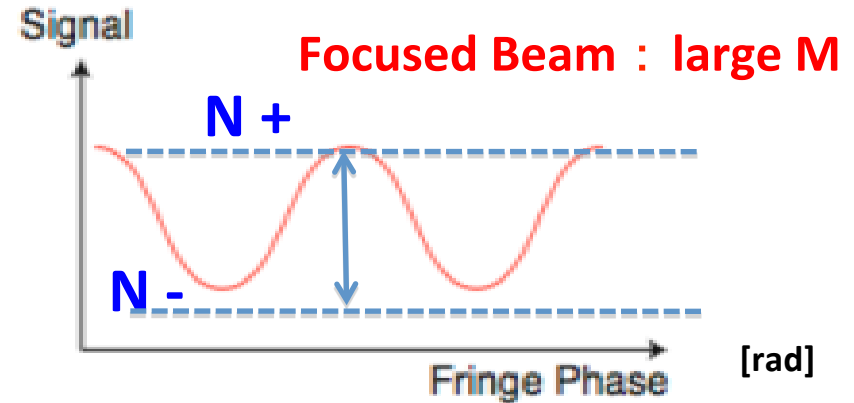
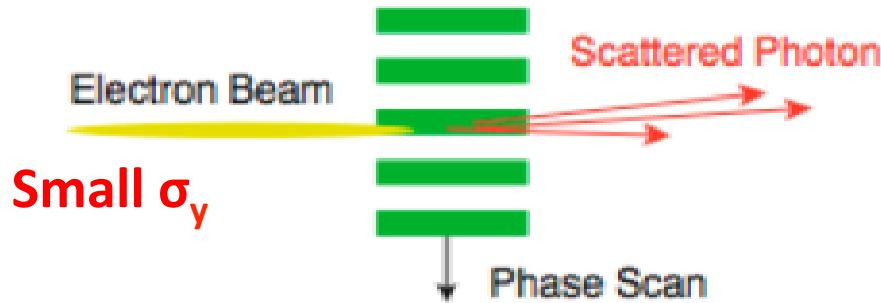

**N: no. of Compton photons**  
Convolution between e- beam profile and fringe intensity

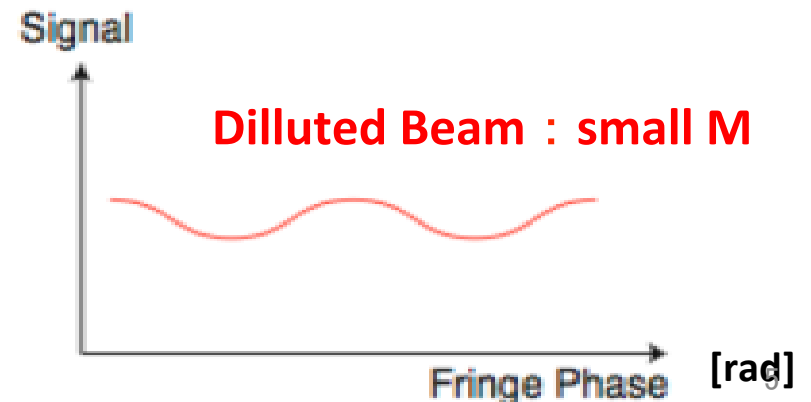
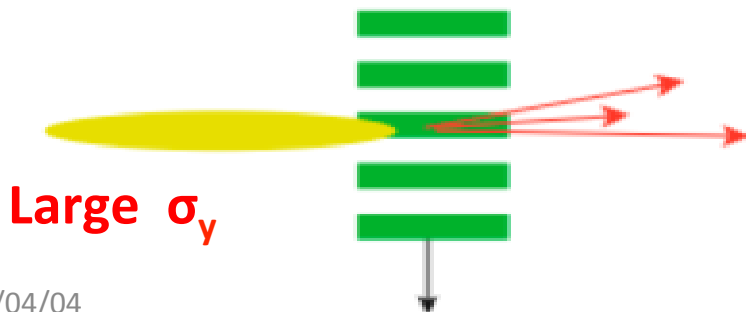

Crossing angle $\theta$	174°	30°	8°	2°
Fringe pitch $d = \frac{\pi}{k_y} = \frac{\lambda}{2 \sin(\theta/2)}$	266 nm	1.03 $\mu\text{m}$	3.81 $\mu\text{m}$	15.2 $\mu\text{m}$
Lower limit	20 nm	80 nm	350 nm	1.2 $\mu\text{m}$
Upper limit	110 nm	400 nm	1.4 $\mu\text{m}$	6 $\mu\text{m}$

## Expected Performance

Measures

$\sigma_y^* = 20 \text{ nm} \sim \text{few } \mu\text{m}$   
with < 10% resolution

$$\sigma_y = \frac{d}{2\pi} \sqrt{2 \ln \left( \frac{|\cos(\theta)|}{M} \right)}$$

$\sigma_y$  and  $M$   
for each  $\theta$  mode

select appropriate mode  
according to beam focusing

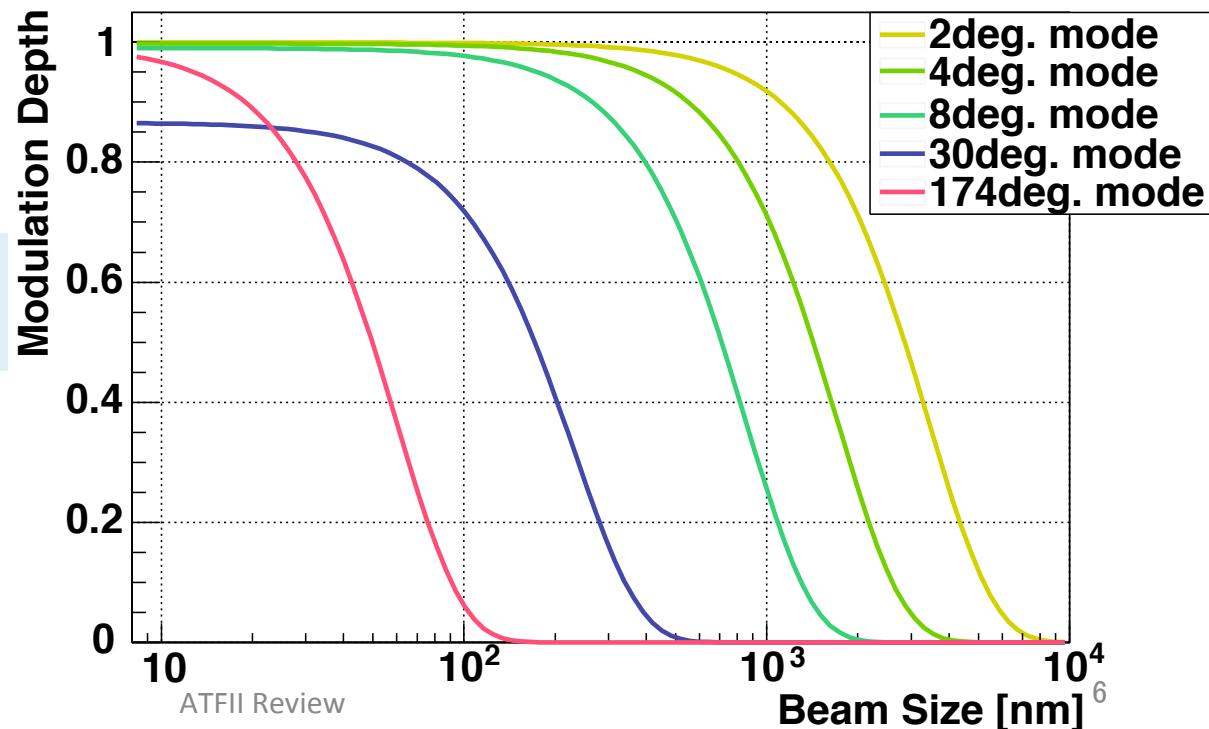

174 deg.

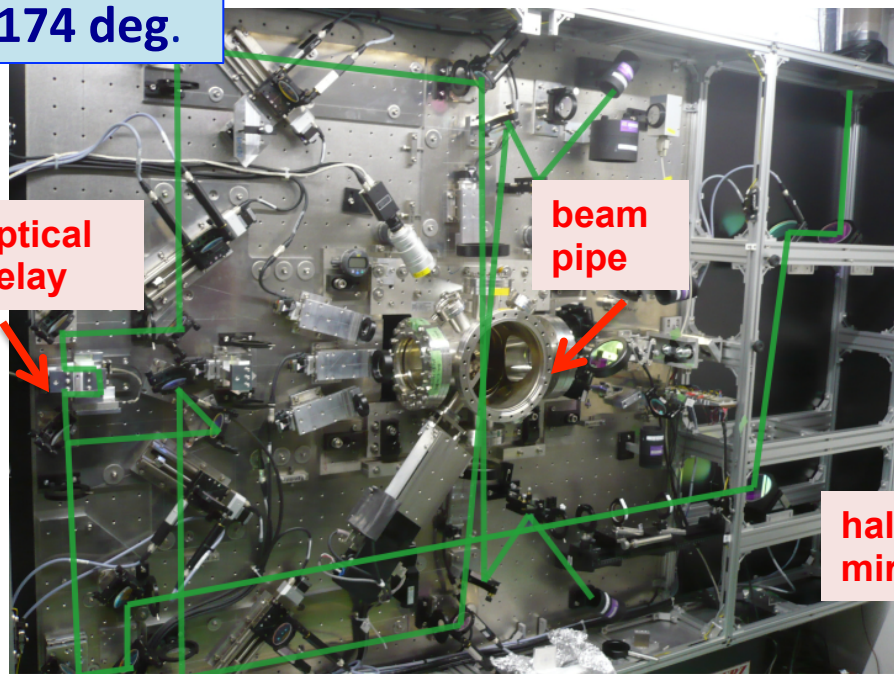

30 deg.

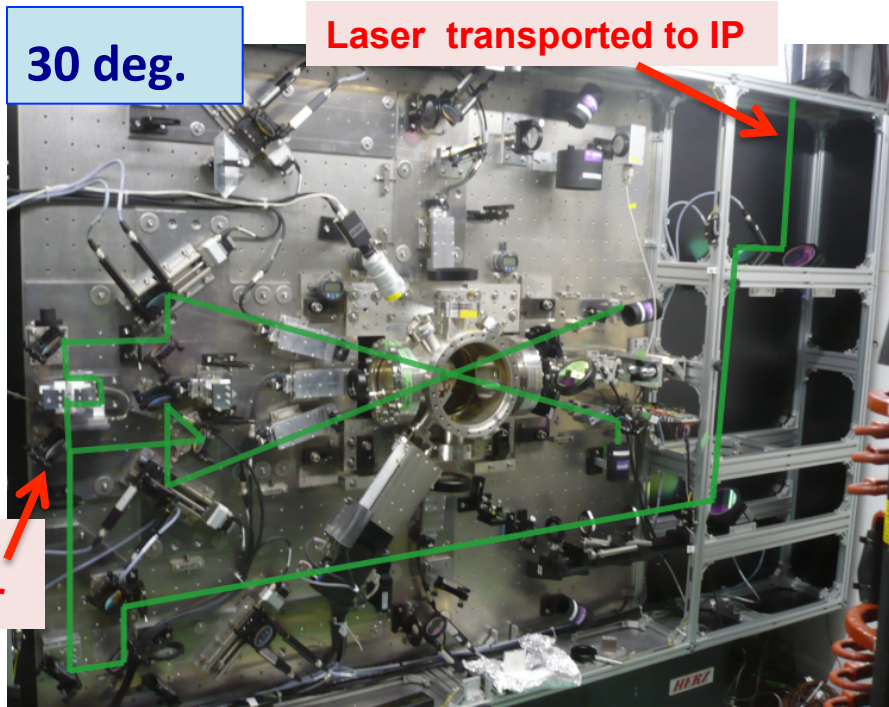

2 - 8 deg

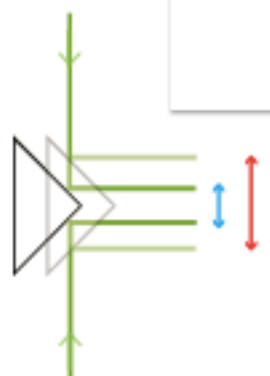
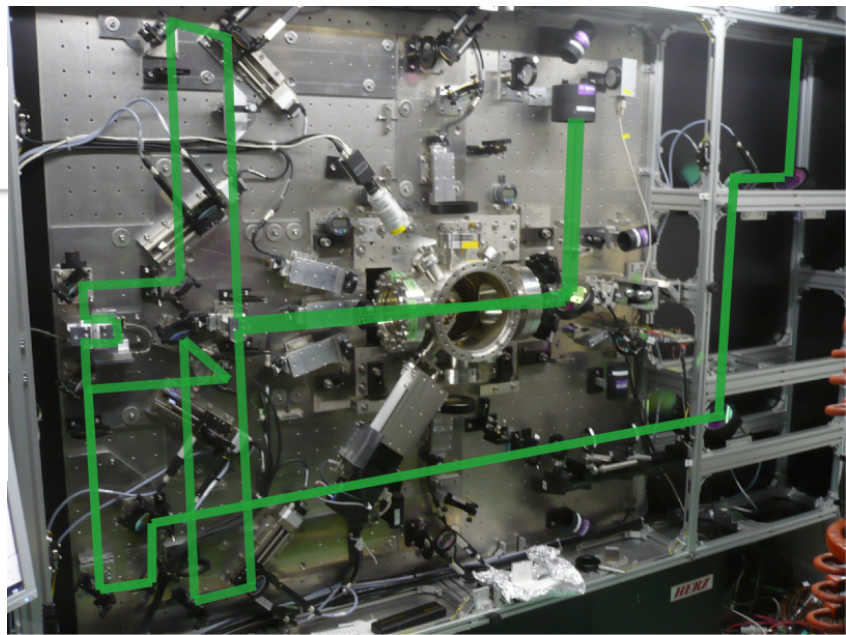

Crossing angle continuously adjustable by prism

13/04/04

## Vertical table

1.7 (H) x 1.6 (V) m

- Interferometer
- Phase control (piezo stage)

**path for each  $\theta$  mode**  
(auto-stages + mirror actuators)

# Role of IPBSM in Beam Tuning

beforehand ....  
Construct & confirm laser paths, timing alignment

precise position alignment by remote control

transverse : laser wire scan

Longitudinal : z scan

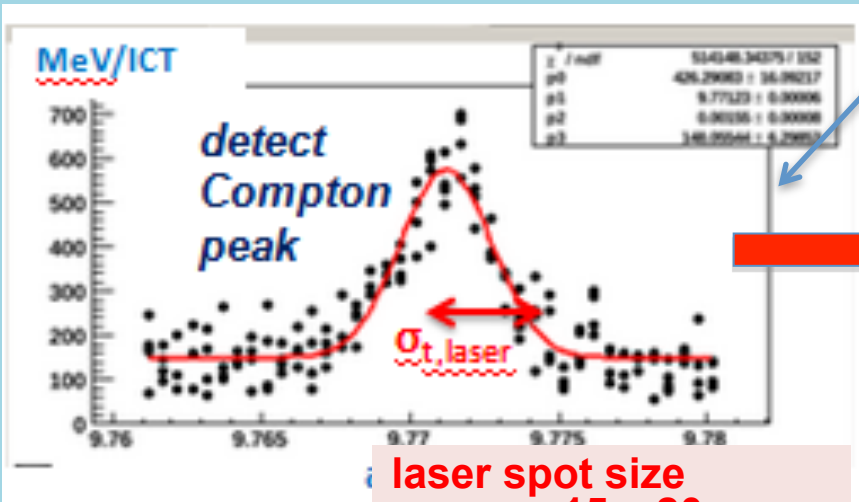

laser spot size  
 $\sigma_{t,laser} = 15 - 20 \mu\text{m}$

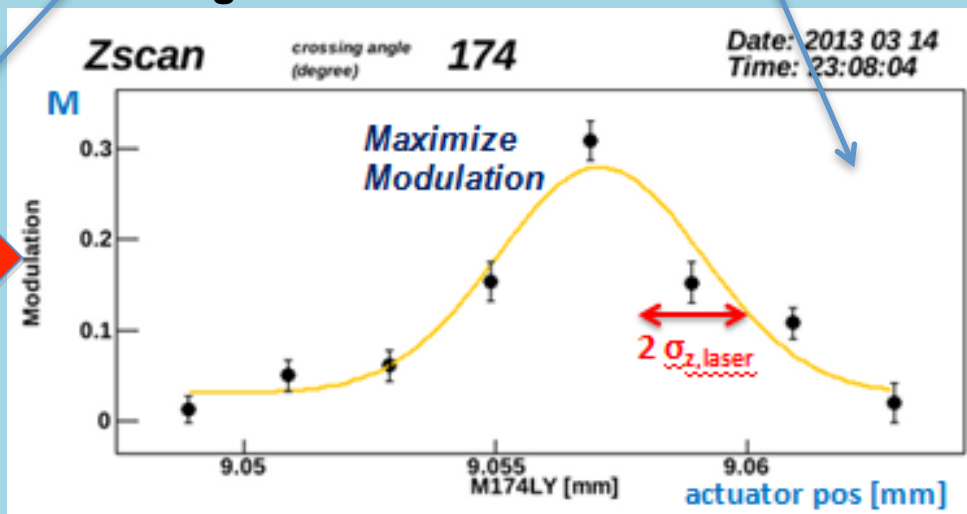

## Fringe Scan 30 degrees

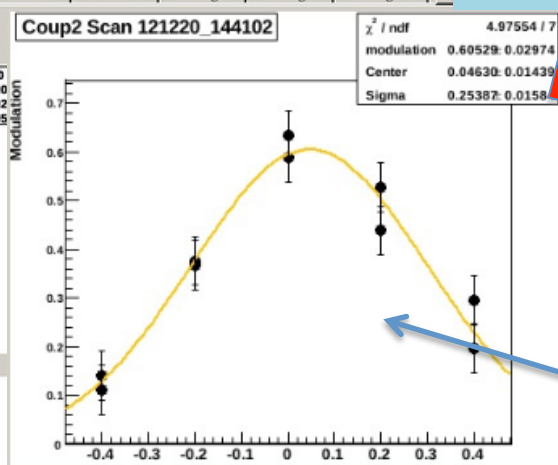
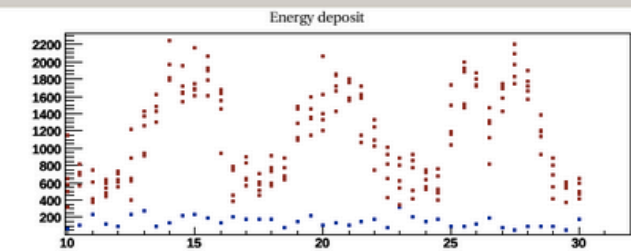
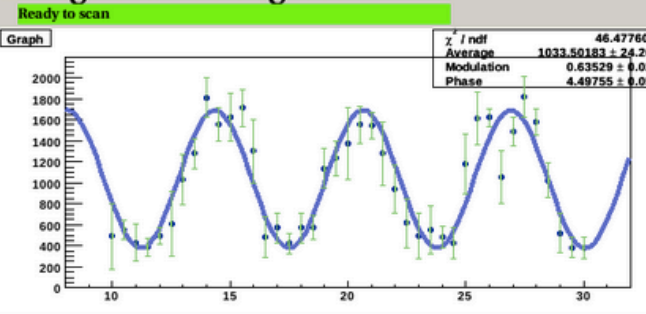

Modulation	0.635	+/-	0.028
Beam Size	128.8	+/-	6.8 nm
Average	1033.502	+/-	24.206
Phase	4.498	+/-	0.056

After all preparations .....

continuously measure  $\sigma_y$  using fringe scans

→ Feed back to multi-knob tuning

# Beam Time Status



# Beam time status in 2012

## Spring run

Feb; 30 deg mode commissioned  
(1<sup>st</sup> M detection on 2/17)

stable measurements of  $M \sim 0.55$

- 2 - 8 ° mode: clear contrast ( $M_{\text{meas}} \sim 0.9$ )
- Prepare 174 deg mode commissioning

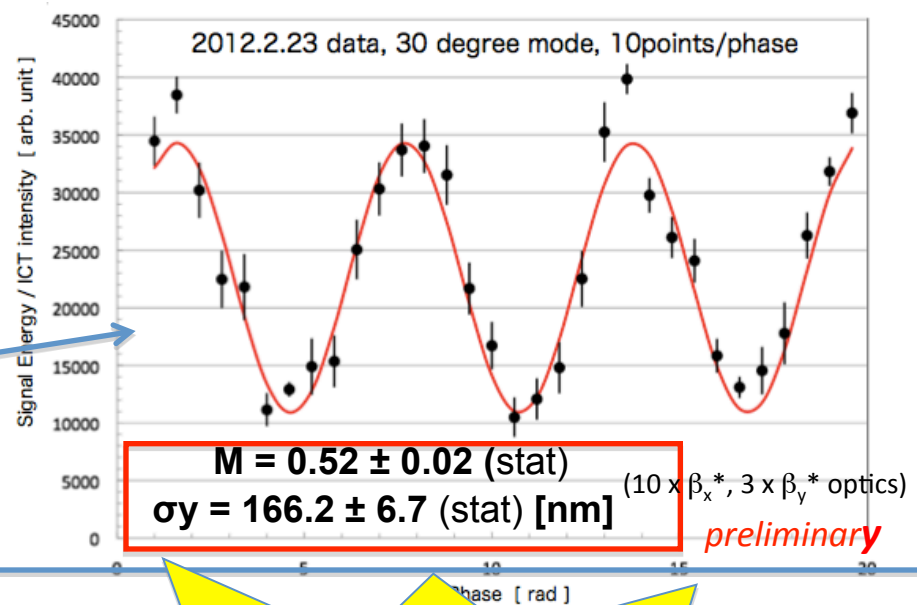

## Major optics reform of 2012 summer

*By IPBSM group@KEK*

- Suppress systematic errors
- Higher laser path stability / reliability

## Winter run

- High M measured at 30 ° mode
- Contribute with **stable operation** to ATF2 continuous run (beam focusing / tuning study)

12/20 :

**1<sup>st</sup> success in M detection at 174 deg mode**

$10 \times \beta_x^*$  ,  $1 \times \beta_y^*$

Last 2 days in Dec run

**Measured many times  $M = 0.15 - 0.25$**   
(correspond to  $\sigma_y \sim 70 - 82$  nm) *preliminary*

\* IPBSM systematic errors uncorrected

\*\* under low e beam intensity ( $\sim 1E9$  e / bunch)

***Large step towards achieving ATF2 's goal !!***  
error studies ongoing aimed at deriving "true beamsize"

# Beam time status in 2013 Spring

Stable IPBSM performance  
→ play major role in beam tuning

174 ° mode M reconfirmed & stably measured over long periods of continuous reiteration of linear / nonlinear tuning knobs

also:

➤ dedicated data acquired for error studies → detailed analysis ongoing  
Reform of laser profile & alignment methods

174 ° mode "consistency scan"

Best record

$M \sim 0.306 \pm 0.043$  (RMS)  
correspond to  $\sigma_y \sim 65$  nm

towards goal of  $\sigma_y = 37$  nm :  
aim at still higher precision and stability for remaining of current run

Fringe scan crossing angle (degree) 174

Date: 2013 03 08  
Time: 22:27:15

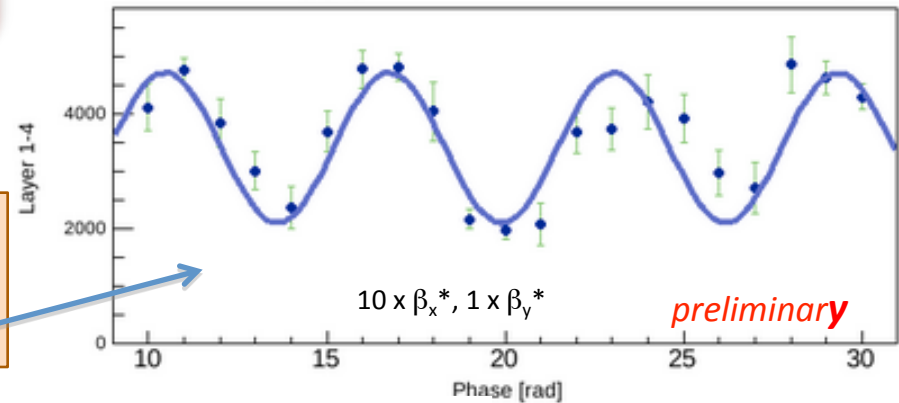

Fit results:  $A_v(1.0 + M \cos(x + Ph))$

Modulation:  $0.385 \pm 0.025$

Beam Size:  $58.4 + 2.0$   
 $-1.9$

Modulation 174 deg

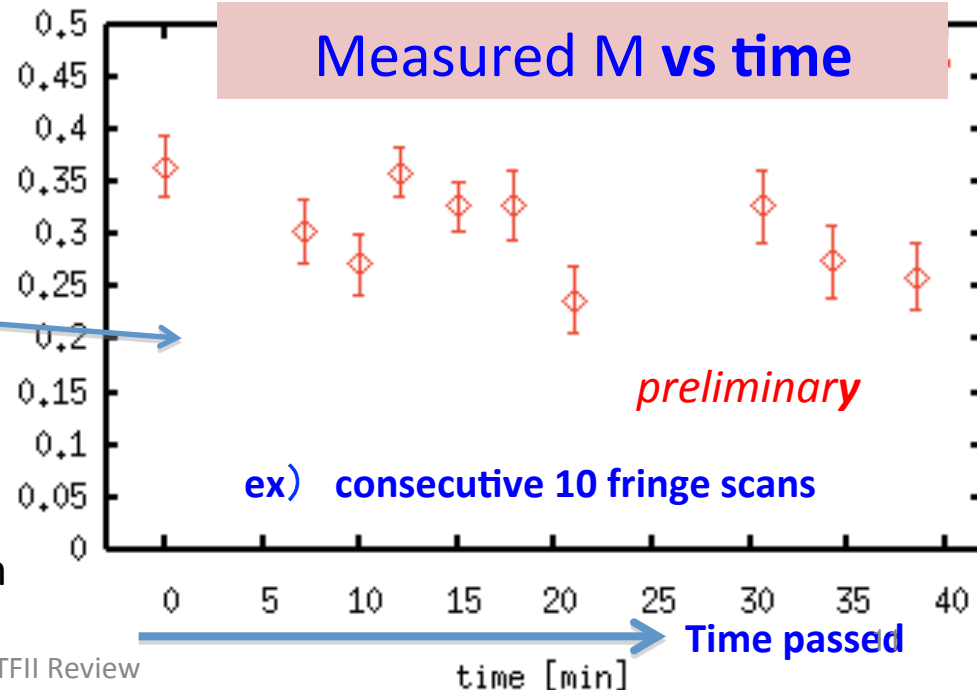

# Optics reform of 2012 summer

By IPBSM group@KEK

## Aim:

Proved greatly effective in 2012 winter run

- Suppress systematic error sources
- Higher alignment precision & reproducibility

improvements	details
<b>alignment precision</b> <ul style="list-style-type: none"><li>✓ match focal point to IP</li><li>✓ Injection position / angle into lens</li><li>✓ Re-optimize expander / reducer</li></ul>	<ul style="list-style-type: none"><li>• focal point scan for all modes</li><li>• CW laser + redefined ref. lines on new base plates</li><li>• <b>new IP target</b> (screen monitor)</li><li>• <b><math>\theta</math> mode switching tech. :</b> {small linear stage + mirror actuators } now: independent for each mode (before: shared rotating stages)</li></ul>
<b>consistency , reproducibility</b> before / after mode switching	
<b>balanced profiles</b>	suppress difference in path length & focal point

## Tuning of main laser

by Spectra Physics

ex: spring 2012 :  
Adjust curvature of laser cavity mirrors

*Aim for a more Gaussian profile*

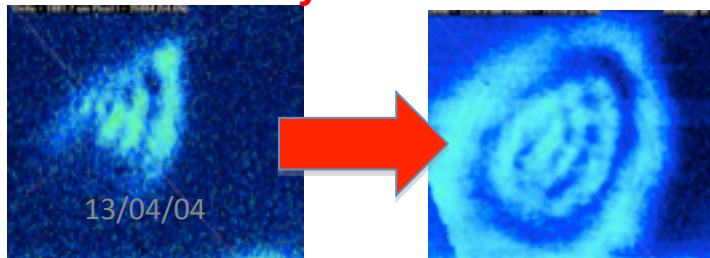

- ❖ Reform laser profile and spatial coherence (adjust YAG rod & cavity mirrors)
- ❖ Exchange flash lamp
- ❖ seeding laser tuning (→ oscillation stability)



Small linear stage + mirror actuator

Firm lens holders

check positioning of lens, mirror, prism

prism

just after injection onto vertical table

Confirm fine alignment using CW laser and transparent IP target

inside IP chamber  
→ laser waist & crossing point

CW laser spot

# **Performance Evaluation #1: Stability**

**Signal jitter sources  
phase drift / jitter  
Laser timing & power**



# Phase Drift

Observed in consecutive fringe scans

drift  $< 70$  mrad / min  
( $\rightarrow$  negligible)

Fringe scan crossing angle (degree) **174**

Date: 2013 03 08  
Time: 18:40:56

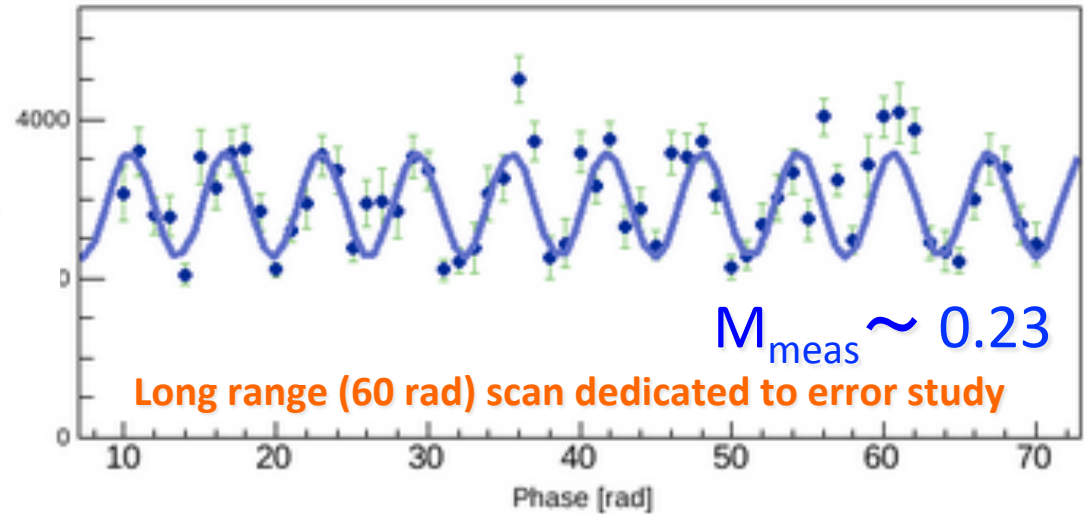

initial phase [rad]

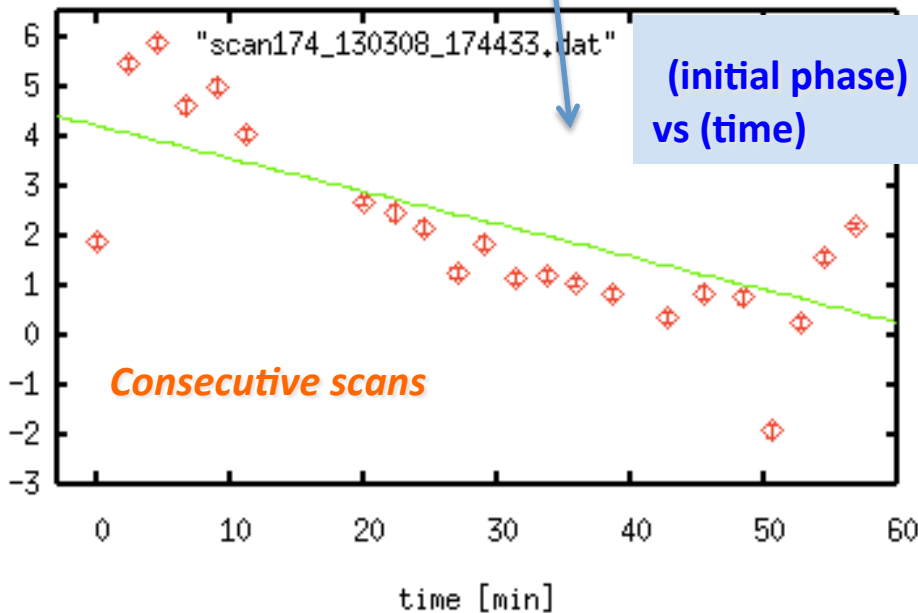

initial phase [rad]

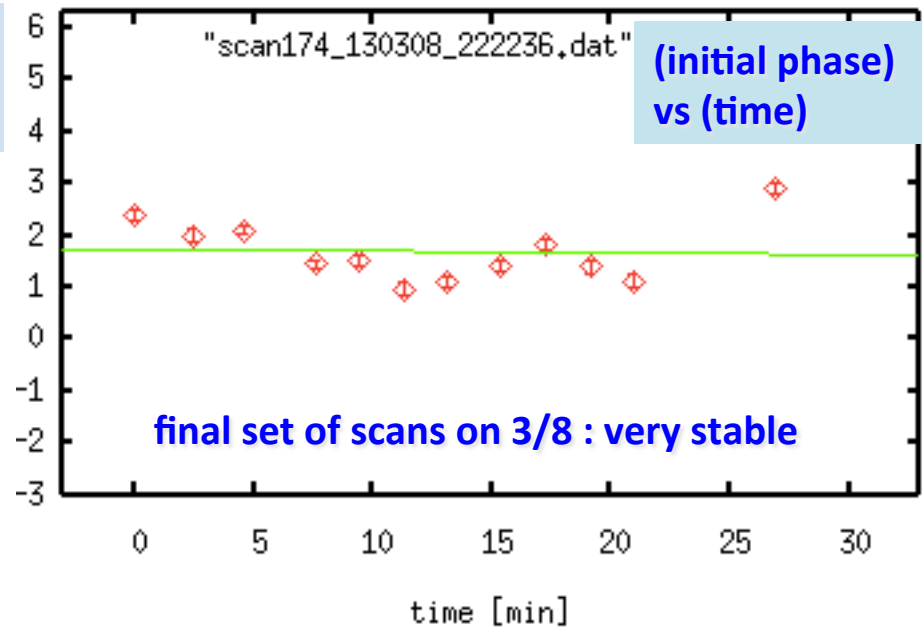

## Demonstration of stability in IPBSM operation : signal Jitter

long term stable performance is maintained under various scan conditions → considered as “standard”

Long range scans dedicated to error studies compared to (20 rad) scans immediately before / after  
 → jitter is not increased for longer range scans or finer scans, just as stable  
 (beam & IPBSM conditions, analysis method kept consistent)

**Comp Sig. jitter is quite consistent at generally 20 – 25 % (@peak of fringe scans)**

data	range	Comp sig jitter (@peak of fringe scans)	
130314_155758	20 rad Nav = 10	21.1 %	Long scans from other periods show similar stability
130314_165737	20 rad Nav = 10	25.2 %	
130314_163420	20 rad <b>Nav = 20</b>	24.3%	<b>Fine scan</b> Nav = 20 events at each phase step
130314_163952	<b>60 rad</b> Nav = 10	25.4 %	<b>Long range scans</b> 60 rad
130314_164840	<b>60 rad</b> Nav = 10	26.3 %	(usually 20 rad)

**Fringe scan** crossing angle (degree) **174**

Date: 2013 03 14  
Time: 16:39:52

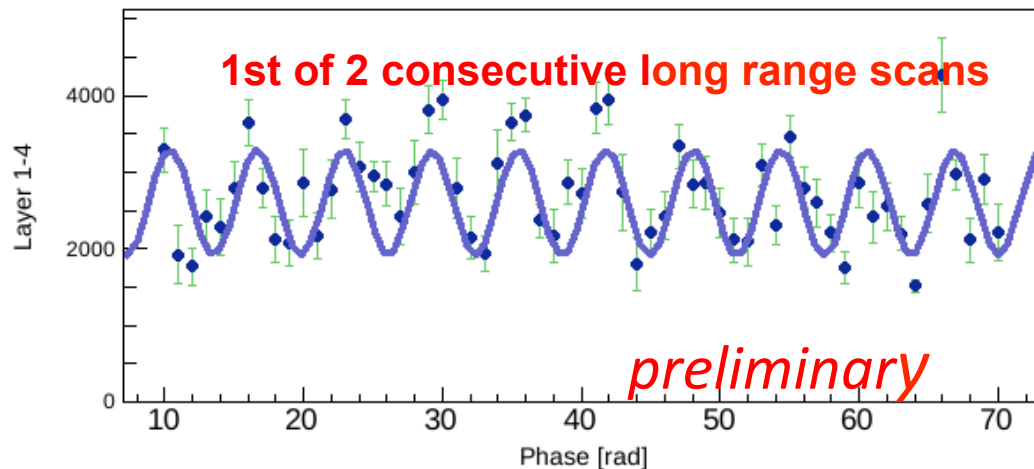

Stability is maintained for long range scans as well

Other fluctuation sources also as stable as typical (BG, timing, power, ect...)

**Signal jitter: 24.3 %**  
(at fringe scan peaks)  
S/N = 5.8

Fit results:  $Av*(1.0+M*cos(x+Ph))$

Modulation:  $0.265 +/- 0.017$

Beam Size:  $69.0 + 1.7 nm$   
 $-1.7$

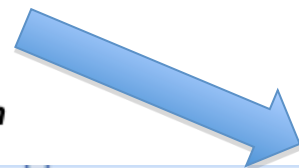

**Fringe scan** crossing angle (degree) **174**

Date: 2013 03 14  
Time: 16:48:40

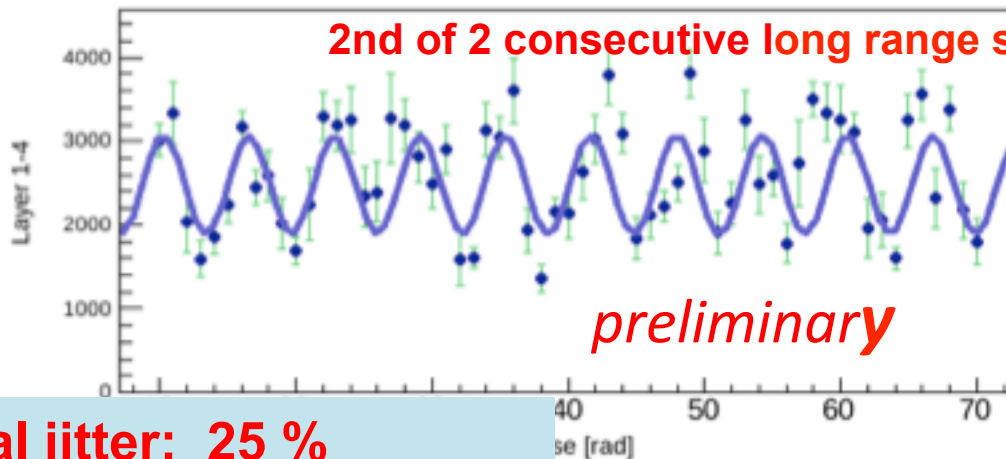

**Signal jitter: 25 %**  
(at fringe scan peaks)  
S/N = 5.8

Fit results:  $Av*(1.0+M*cos(x+Ph))$

Modulation:  $0.237 +/- 0.017$

Beam Size:  $71.8 + 1.9 nm$   
 $-1.8$

# Signal Fluctuation Sources

2013, 174 deg mode

Fluctuation sources	Contribution to $\Delta S_{stat}$
Laser timing	~ 7 %
Laser power	0.5 %
Relative beam –laser position	unknown, <i>under investigation</i>
BG fluc	3 -8 % *scaled by S/N
detector energy resolution	0.4 % * Intrinsic CsI detector energy resolution GEANT4 sim. (not including Comp Signal angular jitter)
Comp $\gamma$ stat.	3 %
ICT monitor accuracy	< 5 %

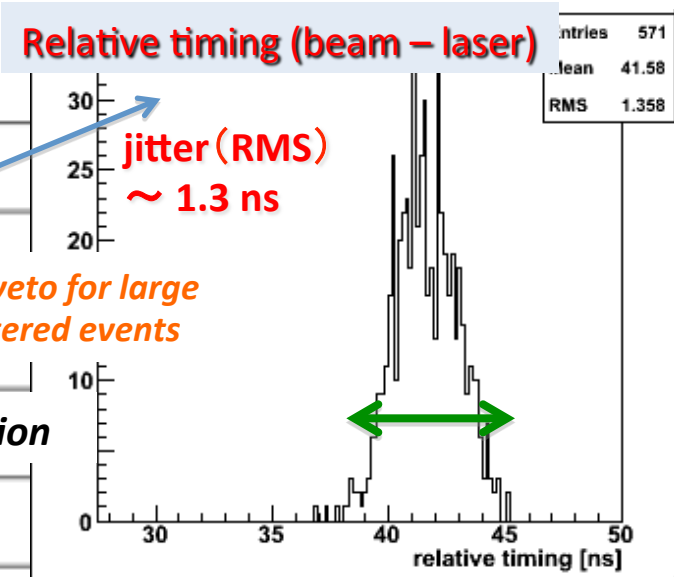

*Prepared offline veto for large timing, power jittered events*

*measured Comp sig energy normalized by beam intensity*

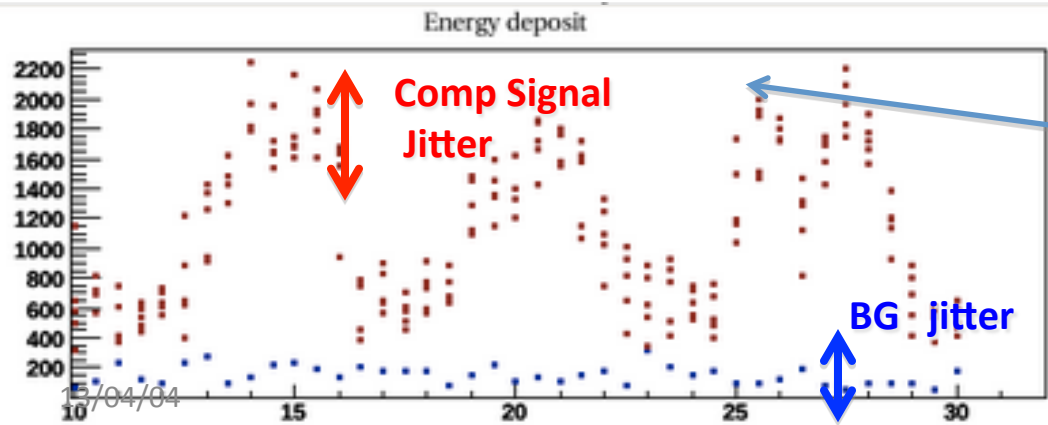

signal jitter derived directly from actual fringe scans (peaks) : 20 – 25%

15/04/04

# Phase Jitter / Relative Position Jitter

Could be dominant fluctuation source

Currently testing new evaluation method

**Compare signal jitter between fringe scan peak & mid & bottom points**  
*affected differently by rel. pos. jitter*

*aim to derive M reduction*

$$y \rightarrow y + \Delta y$$

if  $\Delta y < 0.3 * \sigma y$

$$\sigma_y^2 \rightarrow \sigma_y^2 + (\Delta y)^2$$

$C\delta y > 90\%$  for  $\sigma y = 65\text{ nm}$

$$C_{\Delta y} = \exp\left(-2(k_y \Delta y)^2\right) \quad k_y = \frac{2\pi}{\lambda} \sin\left(\frac{\theta}{2}\right)$$

## Plans:

- improve analysis precision with **more statistics** (longer range & finer step s) → **April beam time**
- Consider alternative methods
- Anticipate O(nm) res. measurement of beam position jitter at IP by **IPBPMs** (under commissioning)

13/04/04

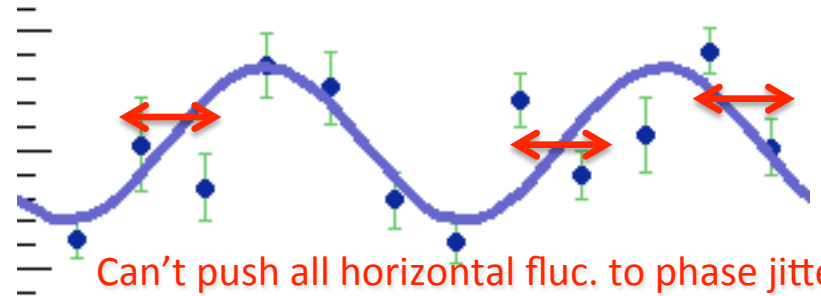
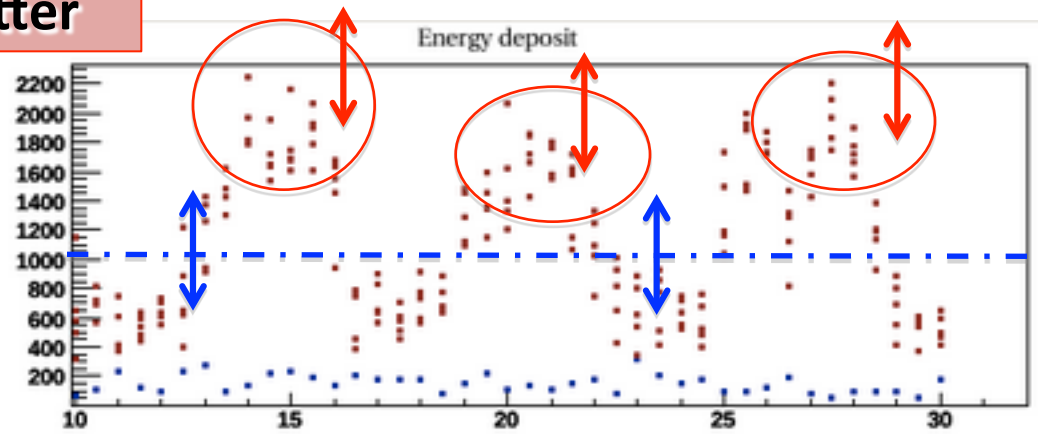

Can't push all horizontal fluc. to phase jitter

- Issues:**
- hard to separate beam position jitter from other fluctuation sources (laser pointing jitters, drifts, ect....)
  - jitters can vary greatly over time

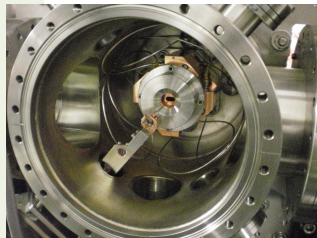



# **Performance Evaluation #2: Study of Modulation Reduction Factors**

**Modulation Reduction Factor**

$$M_{meas} = C_1 C_2 \dots M_{ideal} = \left( \prod_i C_i \right) M_{ideal}$$

$$\sigma_{y,ideal}^2 + \frac{1}{2k_y^2} \left| \sum \ln C_i \right|$$

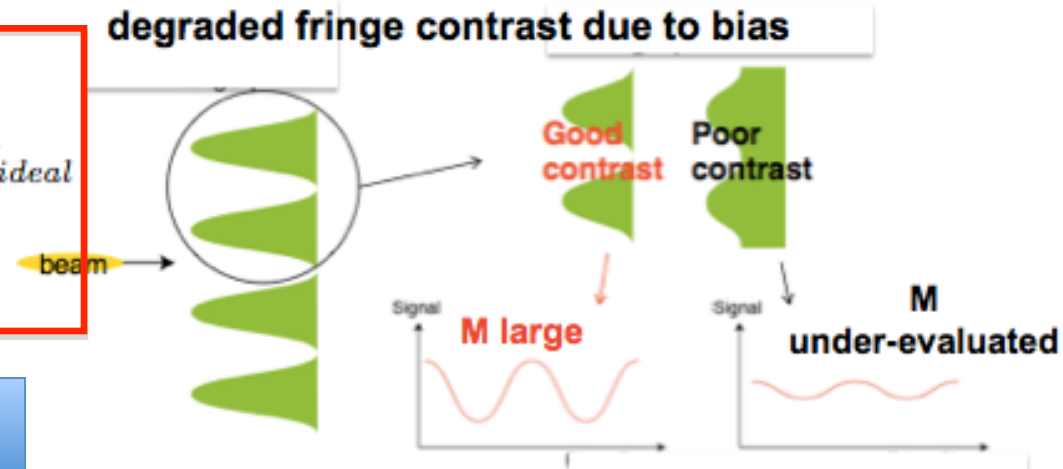
**How to evaluate M reduction?****(1) "Direct Method"**

consecutive mode switching, under same beam condition (e.g.:  $2^\circ \rightarrow 7^\circ \rightarrow 30^\circ$ )  
 use a  $\sigma_y$  that yields very high M at low  $\theta$  mode  $\rightarrow$  observe upper limit on  $M_{meas}$

Note) apply to a particular dedicated data sample

**(2) "Indirect Method"**

Evaluate each individual factor offline and "sum up"

Note) represents the typical conditions of a particular period  
 however ..... hard to derive overall M reduction

(e.g. factors vary over time, lack quantitative evaluation, only can get "worst limit", ect ..... )

Error source	M reduction factor
<b>Fringe tilt (z, t)</b> Limited by alignment precision	During beamtime: final optimization by <b>“tilt scan”</b> Major bias if unattended to
<b>profile imbalance</b>	Uncertain for now <b>Adjustment of transport pipe</b> → aim for improvement and precise evaluation of profile balance <i>projected laser profile (spot size) of laserwire scan not strictly Gaussian</i>
<b>power imbalance</b>	Cpow > 99.1 % Measured directly for each path
<b>polarization</b>	Optimized to <b>S polarization state</b> using $\lambda / 2$ plate Measured laser polarization and half mirror reflective properties
<b>Phase drift</b>	Not a major issue for now Drift : < 70 mrad / min during consecutive fringe scans
<b>Laser path alignment</b>	Ct,pos : ~ 99 %, Cz,pos : > 98 % Resolution of mirror actuators aligning laser to beam

Still uncertain for quantitative evaluation:

- relative position jitter (phase jitter)
- Spatial coherence

Could be major bias

# evaluation of Fringe Tilt

Mismatch in axis between fringe and beam

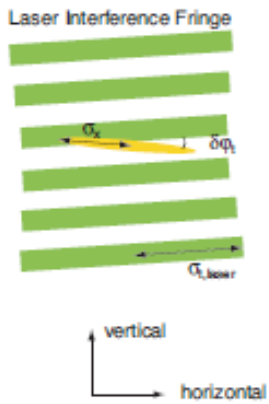

transverse

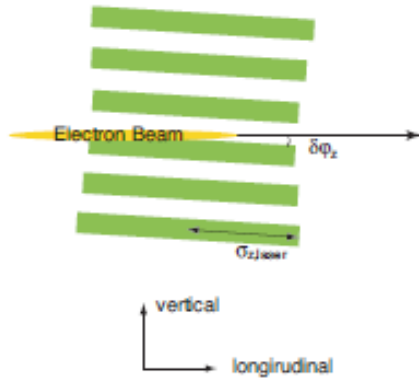

longitudinal

## past method:

observe laser paths

### Problems:

- Precision limit  
 $\Delta = 0.5 \text{ mm} \leftrightarrow \text{few mrad}$
- Position may have drifted by the time of fringe scans
- For transverse tilt:  
 beam may also be rotated

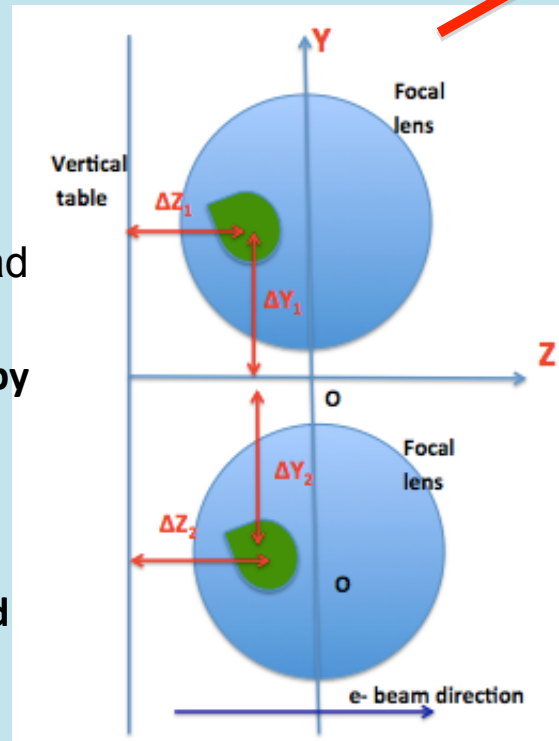

*what is reference for tilt adjustment??*

13/04/04

## Current method :

a more practical beamtime "tilt scan"

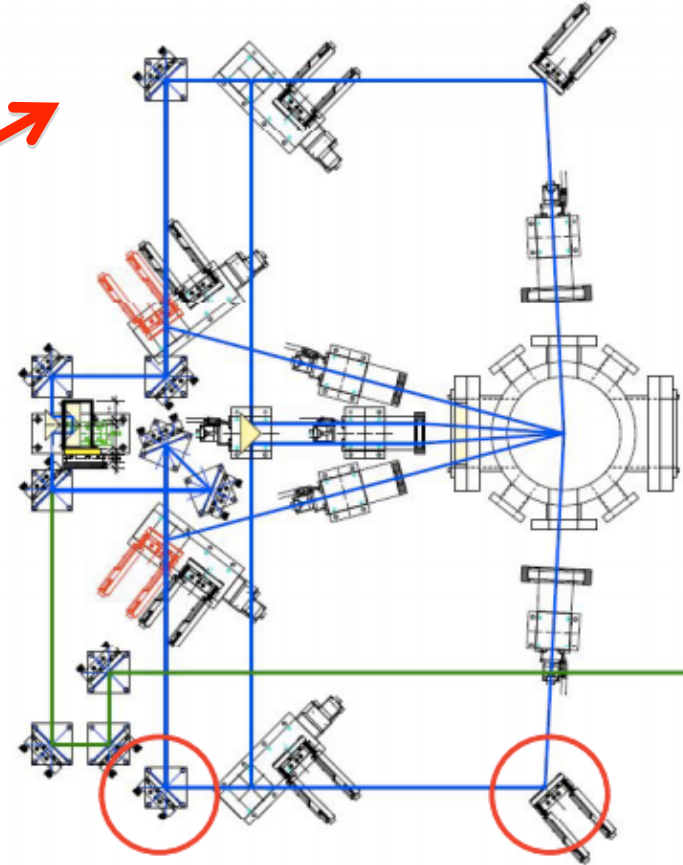

change M174L and injection mirrors

→ Maximize M

(details on next page)

# Fringe Tilt : practical application of "tilt scan"

Can observe M reduction Ctilt (70 - 80% if left uncorrected )  
 directly from change in M wrt e beam  
 (regardless of beam tilt)

Ex#1 3/8 : fringe pitch adjustment:

changed M174L Y (8.9 mm → 9.014 mm )  
 Max. M increased as 0.07 → 0.32

*important adjustment in aim of eliminating M reduction*

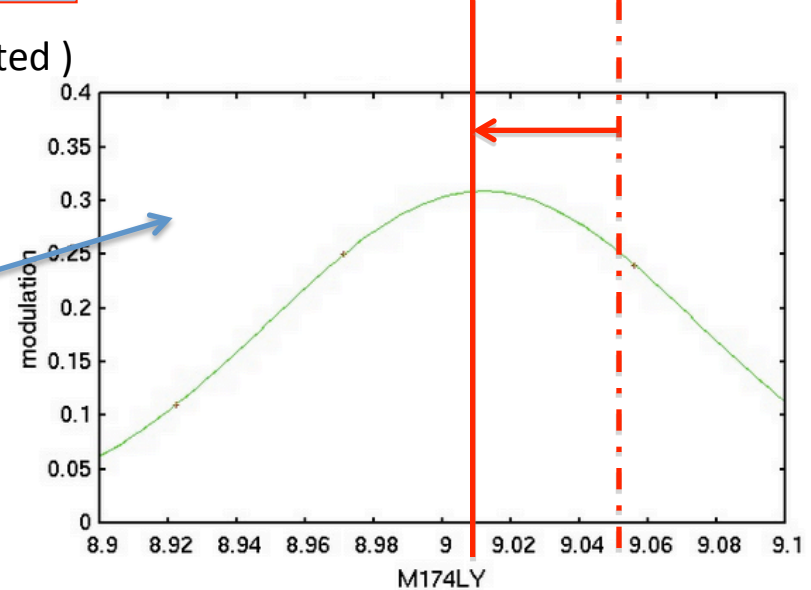

(study of fringe tilt by Okugi-san)

EX#2: 3/14 : fringe roll adjustment :

(M174XL changed > 0.1 mm)  
 Max M increased as 0.1 → 0.14

Each time change mirror,  
 accessed to IP to align path

→ make necessary mirrors remote controllable

M174LX scan

Date: 2013 03 14  
 Time: 13:14:34

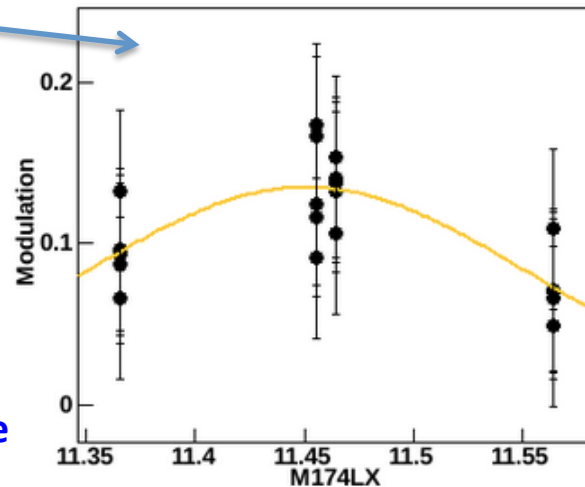

Fit results:  $A \cdot \exp(-(x-B)/C)^{2/2}$   
 Modulation: 0.135 +/- 0.016  
 Center: 11.451 +/- 0.020  
 Sigma: 0.102 +/- 0.024  
 Chi2/ndf: 4.1677e+00 / 17

Compare before  
 and after  
 optimization by  
 "tilt scan"



## Plan for assessment of M reduction factors

### priorities

1<sup>st</sup> : suppress M reduction → aim for  $C_{total} \sim 1$

2<sup>nd</sup>: precisely evaluate any residual errors → aim to derive the “true beam size”

For “uncertain” individual factors: (e.g. Relative position jitter, spatial coherence, ect .....) )

Do we really have large bias ? how much ? → *how to find out ??*

### test using “direct method”

At a low  $\theta$  mode : measure a large M (near resolution limit) using a sufficiently small  $\sigma_y$   
compare results with higher  $\theta$  modes

### example:

if we measure M corresponding to  $\sigma_y = 350$  nm at 7 deg mode

then expect **M = 0.98 at 2.75 deg mode** (*try to keep within 2-8 deg*)

**what if we get only 0.95 ???** (averaged over many scans) →  **$C_{total} \sim 0.97$**

this means **no individual bias factor worse than 0.97** (at least not for this particular period)

### Note:

- conditions may vary greatly over time → confirm with repeated measurements
- need prove whether these factors depend on  $\Theta$  mode ??

## Summary

# Shintake Monitor (IPBSM):

beamsize monitor using laser interference

- ❖ Only existing device capable of measuring  $\sigma_y < 100$  nm
- ❖ Indispensable for achieving ATF2 goals and realizing ILC

### < Status >

- ❖ **contribute with stable operation to continuous beam size tuning**
- ❖ **Consistent measurement of  $M > 0.3$**  (174 ° mode) *at low beam intensity*  
correspond to  $\sigma_y \sim 65$  nm (assuming no M reduction)
- ❖ Application of various linear / non-linear multi- knobs
- ❖ dedicated studies of e beam and IPBSM errors

### < towards performance improvement >

**Performance significantly improved by laser optics reforms**

suppressed error sources, improved laser path reliability & reproducibility

## Goals

***Towards confirming  $\sigma_y = 37$  nm***

- ◆ **Maintain / improve beamtime performance** :e.g. stability, precision
- ◆ **Assessment of residual systematic errors** → derive the “true beam size”
- ◆ **stable measurements of  $\sigma_y^* < 50$  nm within this run** ATFII Review

# Backup

# Expected Performance

$$37 \pm 2 \text{ (stat.) } {}_{-4}^0 \text{ (syst.) nm}$$

must select appropriate mode according to beam focusing

Resolution for each  $\theta$  mode

Measures  $\sigma y^* = 25 \text{ nm} \sim \text{few } \mu\text{m}$  with  $< 10\%$  resolution

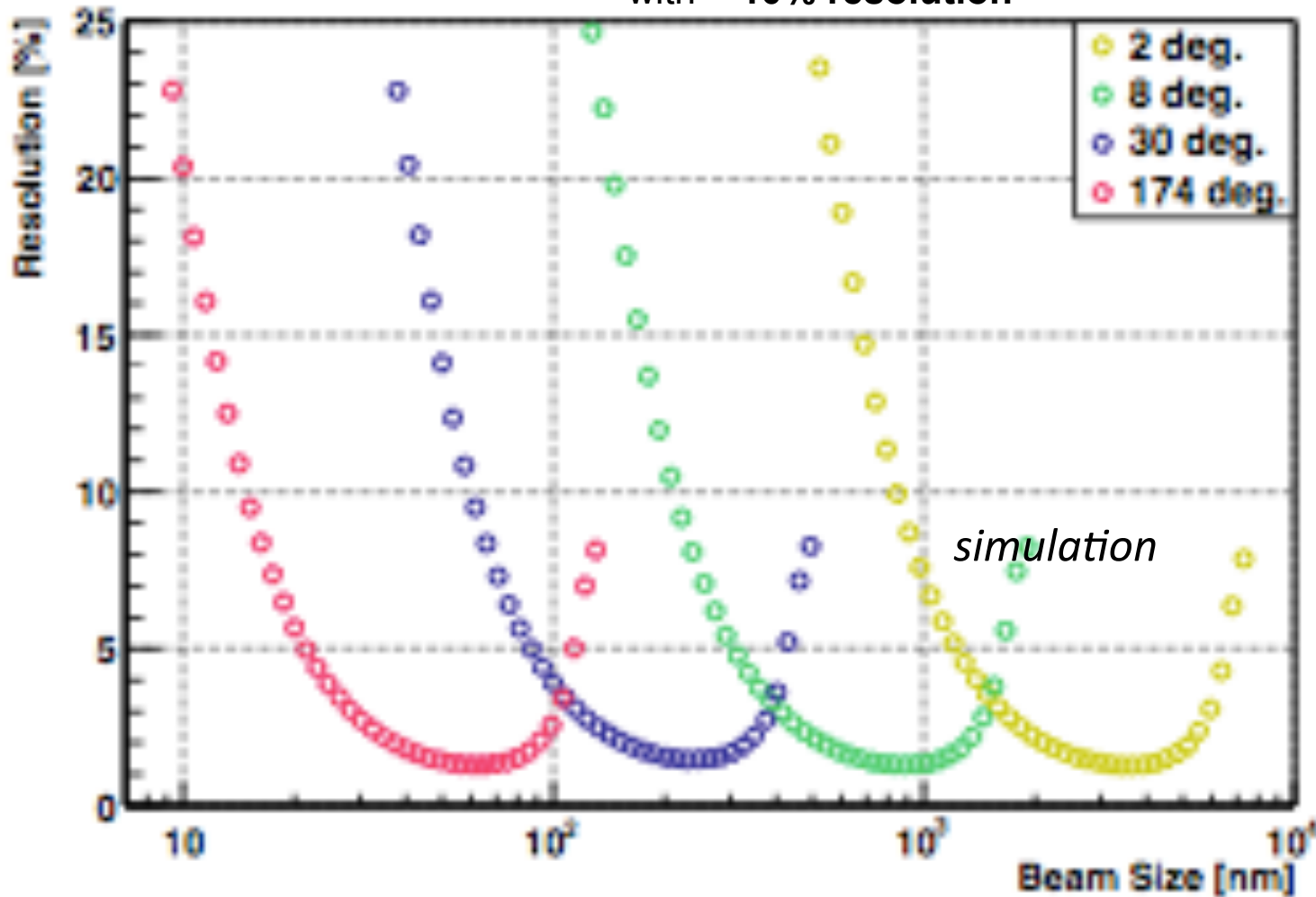

# Laser Optics

## Laser table

Source , SHG  
Diagnostic devices

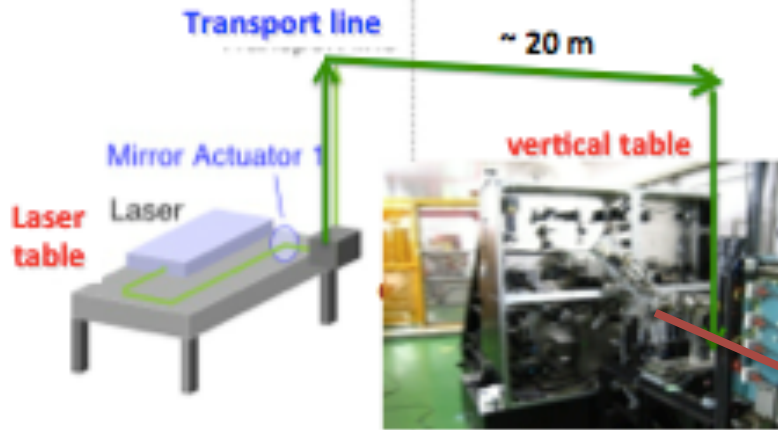
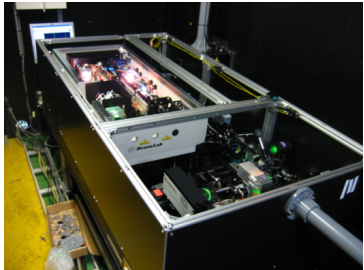

## Vertical table

Interferometer  
Phase control (piezo stage)  
• path for each  $\theta$  mode  
(auto-stages + mirror actuators )

e beam

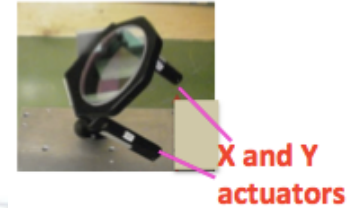

Layout of Vertical table (ex: 30 deg mode path)

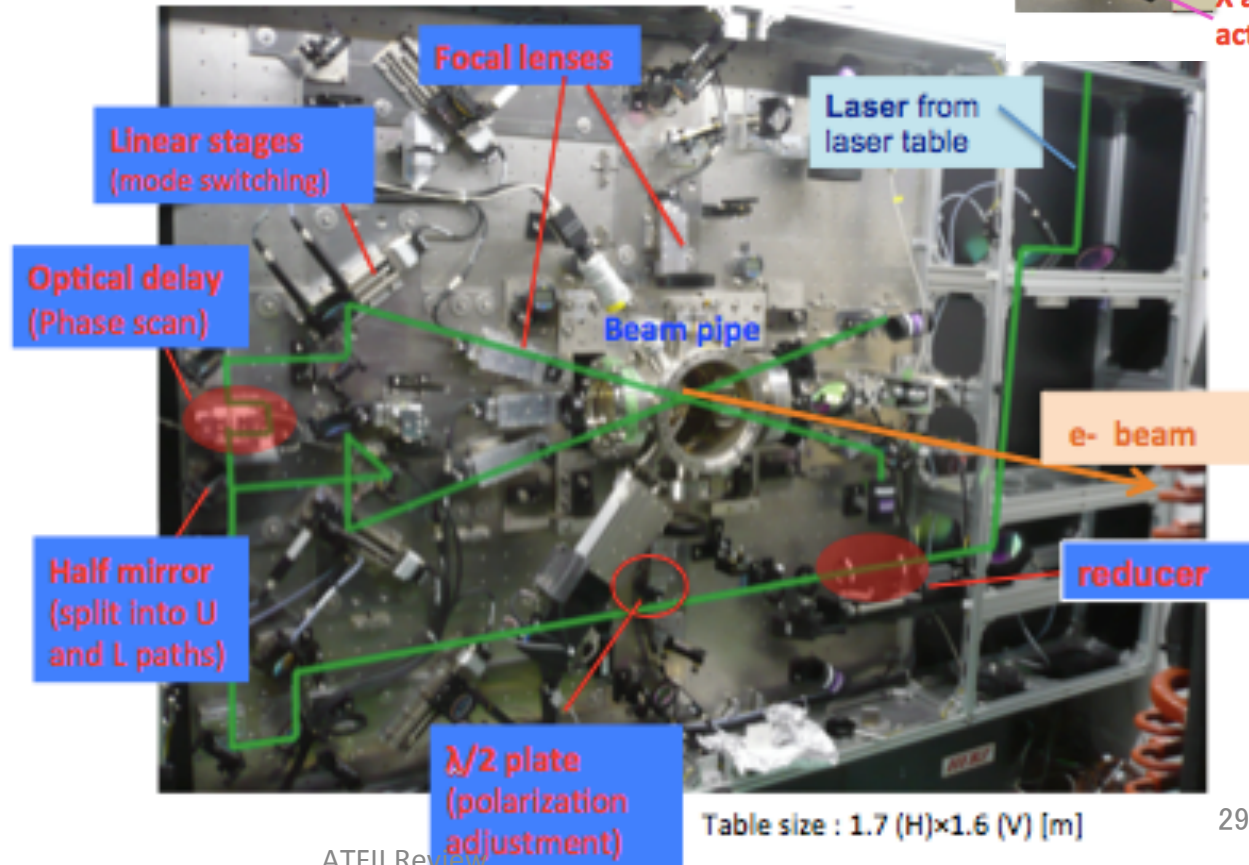

Table size : 1.7 (H)×1.6 (V) [m]

## Nd :YAG Q-Switch laser

PRO350 Spectra Physics

Wavelength	532 nm (SHG)
Pulse Energy	1.4 J
Peak power	164 MW
Pulse Width	8 ns (FWHM)
$f_{rep}$	6.25 Hz
Line Width	$< 0.003 \text{ cm}^{-1}$
Timing Stability	$< 0.5 \text{ ns}$
Energy Stability	$\pm 3\%$



# Laser interference scheme

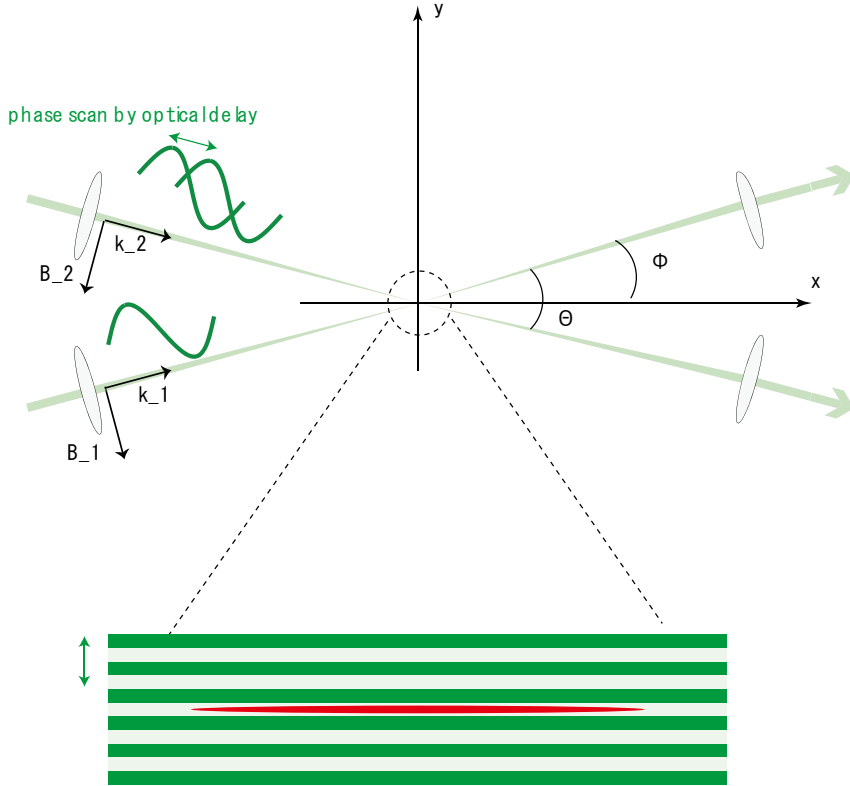

Wave number vector of two laser paths

$$\vec{k}_1 = (k \cos \phi, k \sin \phi, 0) \equiv (k_x, k_y, 0)$$

$$\vec{k}_2 = (k \cos \phi, -k \sin \phi, 0)$$

S-polarized laser

$$\vec{B}_1 = B(\sin \phi, -\cos \phi, 0) \cos(\omega t - \vec{k}_1 \cdot \vec{x} - \frac{\alpha}{2})$$

$$\vec{B}_2 = B(-\sin \phi, -\cos \phi, 0) \cos(\omega t - \vec{k}_2 \cdot \vec{x} + \frac{\alpha}{2})$$

$$\vec{B} = \vec{B}_1 + \vec{B}_2$$

$$= 2B \begin{pmatrix} \sin \phi \sin(\omega t - k_x x) \sin(k_y y + \frac{\alpha}{2}) \\ -\cos \phi \cos(\omega t - k_x x) \cos(k_y y + \frac{\alpha}{2}) \\ 0 \end{pmatrix}$$

Time averages magnetic field causes inverse Compton scattering

$$\langle B_x^2 + B_y^2 \rangle = B^2(1 + \cos \theta \cos(2k_y y + \alpha))$$

- phase shift at IP  $\leftrightarrow \alpha$
- wave number component along y-axis  $2k_y = 2k \sin \phi$
- modulation depends on  $\cos \theta$

Fringe pitch

$$\Rightarrow d = \frac{\pi}{k_y} = \frac{\lambda}{2 \sin \phi^{30}}$$

# Calculation of beam size

Total signal energy measured by  $\gamma$ -detector

Convolution of  $\left\{ \begin{array}{l} \text{Laser magnetic field : Sine curve} \\ \text{Electron beam profile : Gaussian} \end{array} \right.$

Laser magnetic field      Electron Beam profile with beam size  $\sigma_y$  along y-direction

$$S \propto \int dy' \left\langle B_x^2 + B_y^2 \right\rangle \frac{1}{\sqrt{2\pi\sigma_y^2}} \exp\left(\frac{-y'^2}{2\sigma_y^2}\right)$$

$$= \int dy' B^2(1 + \cos\theta \cos(2k_y y + \alpha)) \frac{1}{\sqrt{2\pi\sigma_y^2}} \exp\left(\frac{-y'^2}{2\sigma_y^2}\right)$$

$$S = S_{ave}(1 + \cos((2k_y y) + \alpha) \cos\theta \exp(-2(k_y\sigma_y)^2))$$

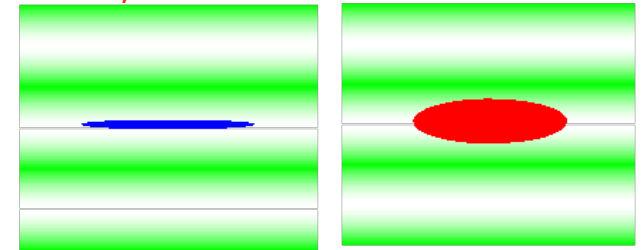

Small beam size      Large beam size

$S_{\pm}$  : Max / Min of Signal energy

$$S_+ = S_{ave}(1 + |\cos\theta| \exp(-2(k_y\sigma_y)^2))$$

$$S_- = S_{ave}(1 - |\cos\theta| \exp(-2(k_y\sigma_y)^2))$$

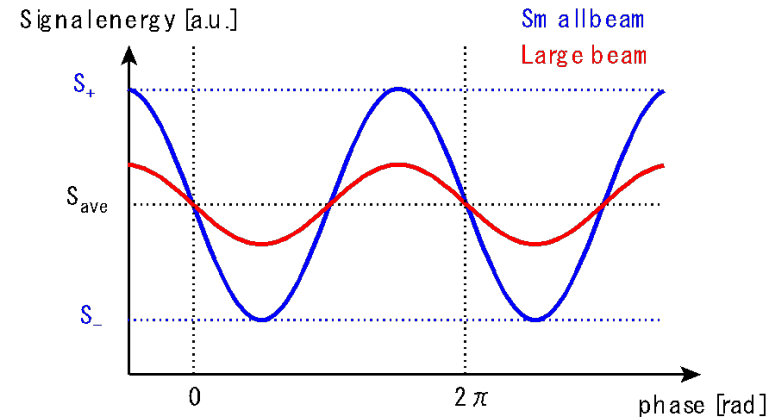

M : Modulation depth

$$M = \frac{S_+ - S_-}{S_+ + S_-} = |\cos\theta| \exp(-2(k_y\sigma_y)^2) \Rightarrow \sigma_y = \frac{1}{2k_y} \sqrt{2 \ln\left(\frac{|\cos\theta|}{M^{31}}\right)}$$

# Laser timing stability

- beam time: “**timing scans**”
- relative timing matched by TD2s to optimize collision
  - beam : BPM signal → TDC
  - laser : PIN-PD signal → TDC
- **PIN-PD waveform jitter** (due to external trigger?)
  - (peak-to-peak) ~ few ns ( on oscilloscope)
  - (rms) ~ 1.3 ns
- ➔ contribute a few % to **Comp. signal jitters**

$$\Delta S_{\text{timing}} \approx \frac{1}{2} \left( \frac{\Delta t}{\sigma_{t, \text{laser}}} \right)^2$$

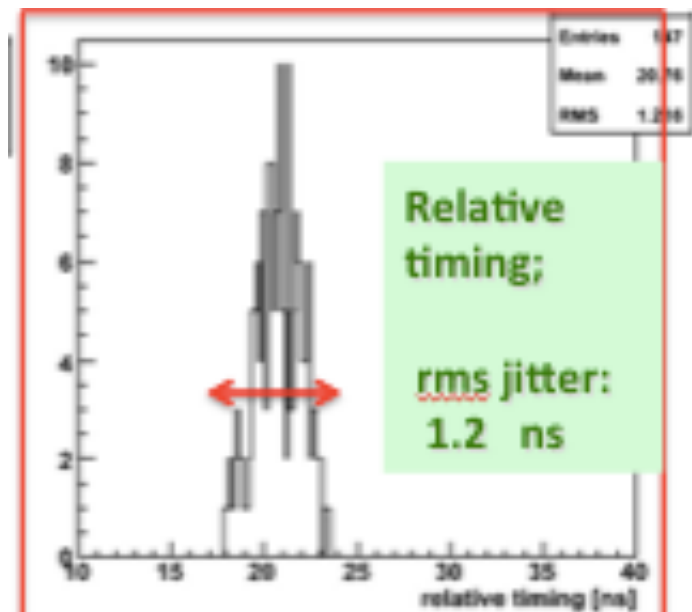
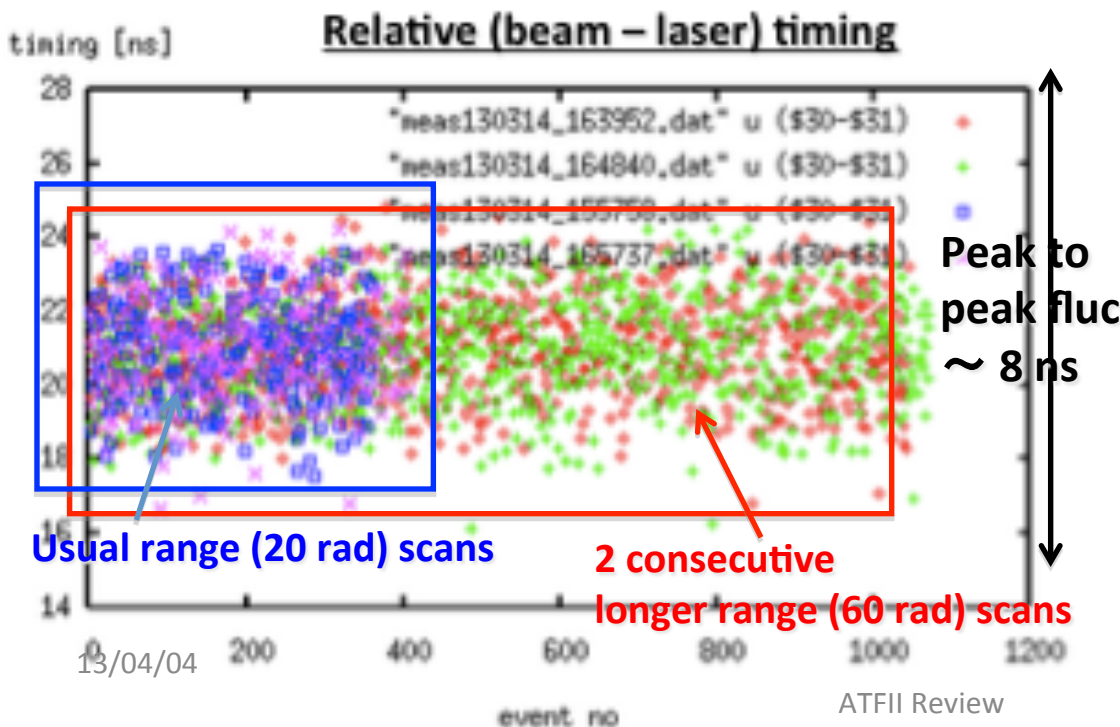

Sample:  
Long range fringe scan  
(2013. 3/14)

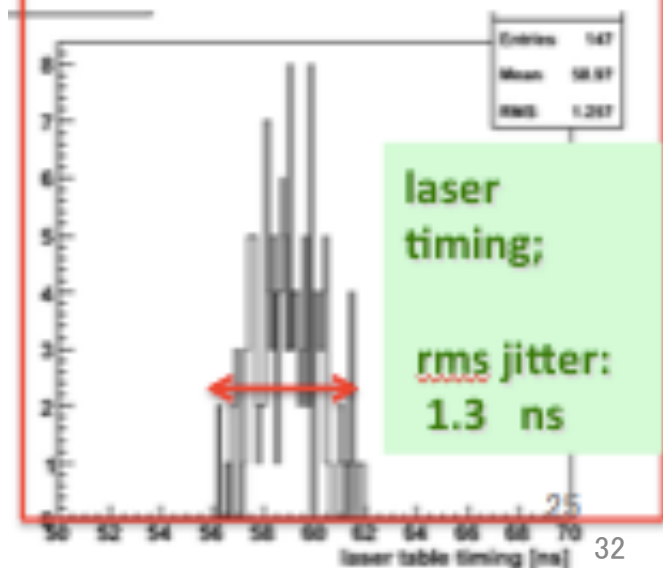

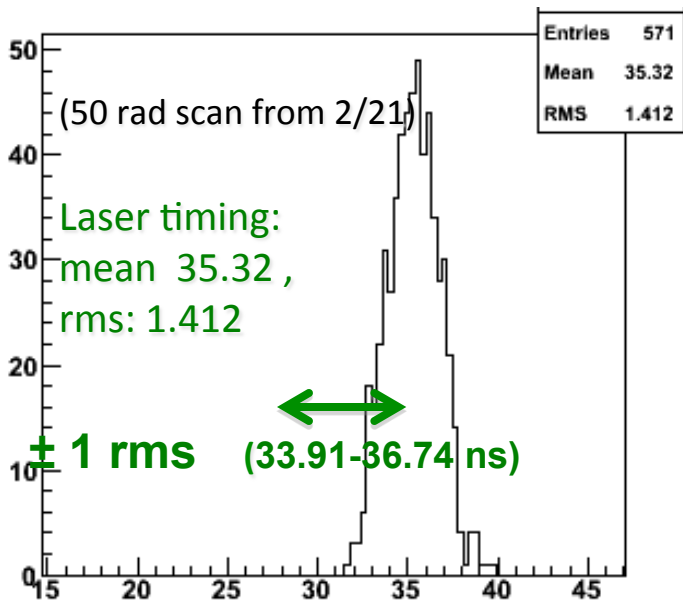

## Offline laser timing cut

Try different cut ranges: small improvement in Signal Jitter

❖ cut:  $\pm 1$  rms : Sig jitter : 18.8 %

❖ No cut: Sig jitter : 21.4 %

- significant improvement is not always observed  
timing not seriously jittered in the first place //

Plan: keep veto method in practice

apply when necessary to larger timing jittered scans

Also tried relative (beam – laser) timing cut

*Beware of accuracy of measured timing of low current beam*

## Laser power stability

Usual range (20 rad) scans

2 consecutive  
longer range  
(60 rad) scans

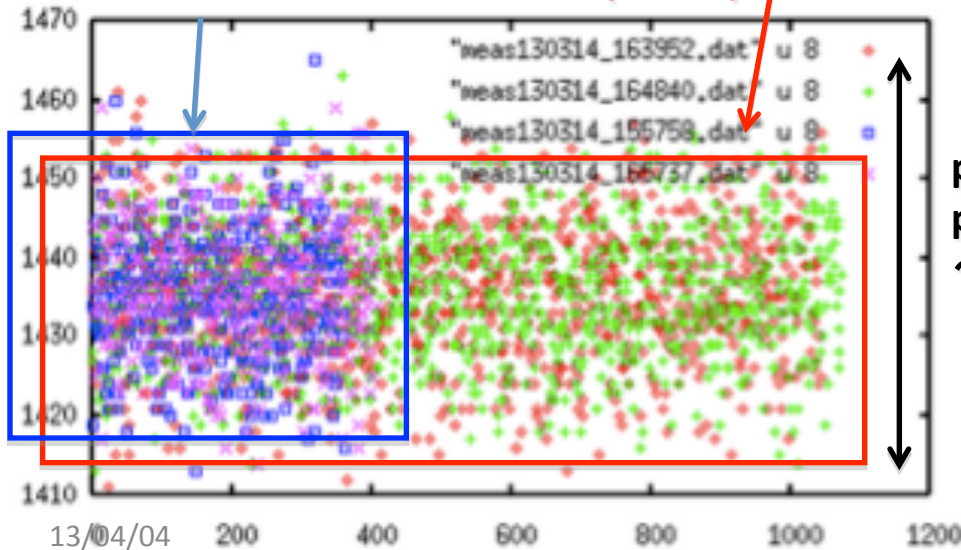

peak to  
peak fluc.  
 $\sim 1.5\%$

- Laser power constantly very stable

- monitored by photodiode (on laser table)

not much drift nor jitters, regardless of scan range

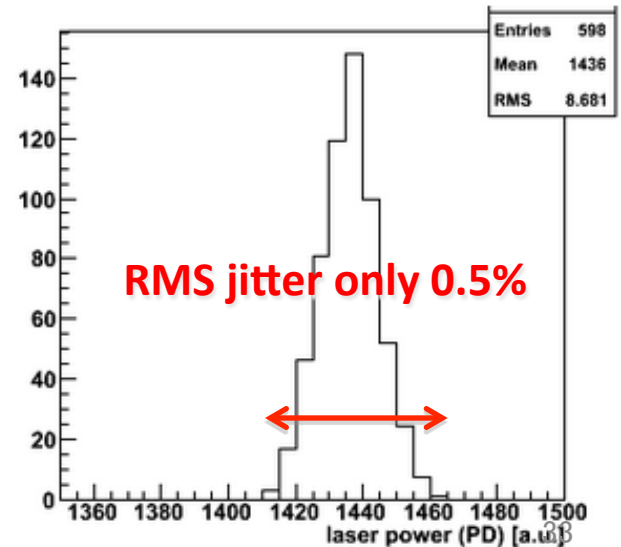

RMS jitter only 0.5%

# Beam timing status

Example: 3/14

beam timing : seem like teher is half clock jump, about 1.4 ns (not 1 clock 2.8 ns)

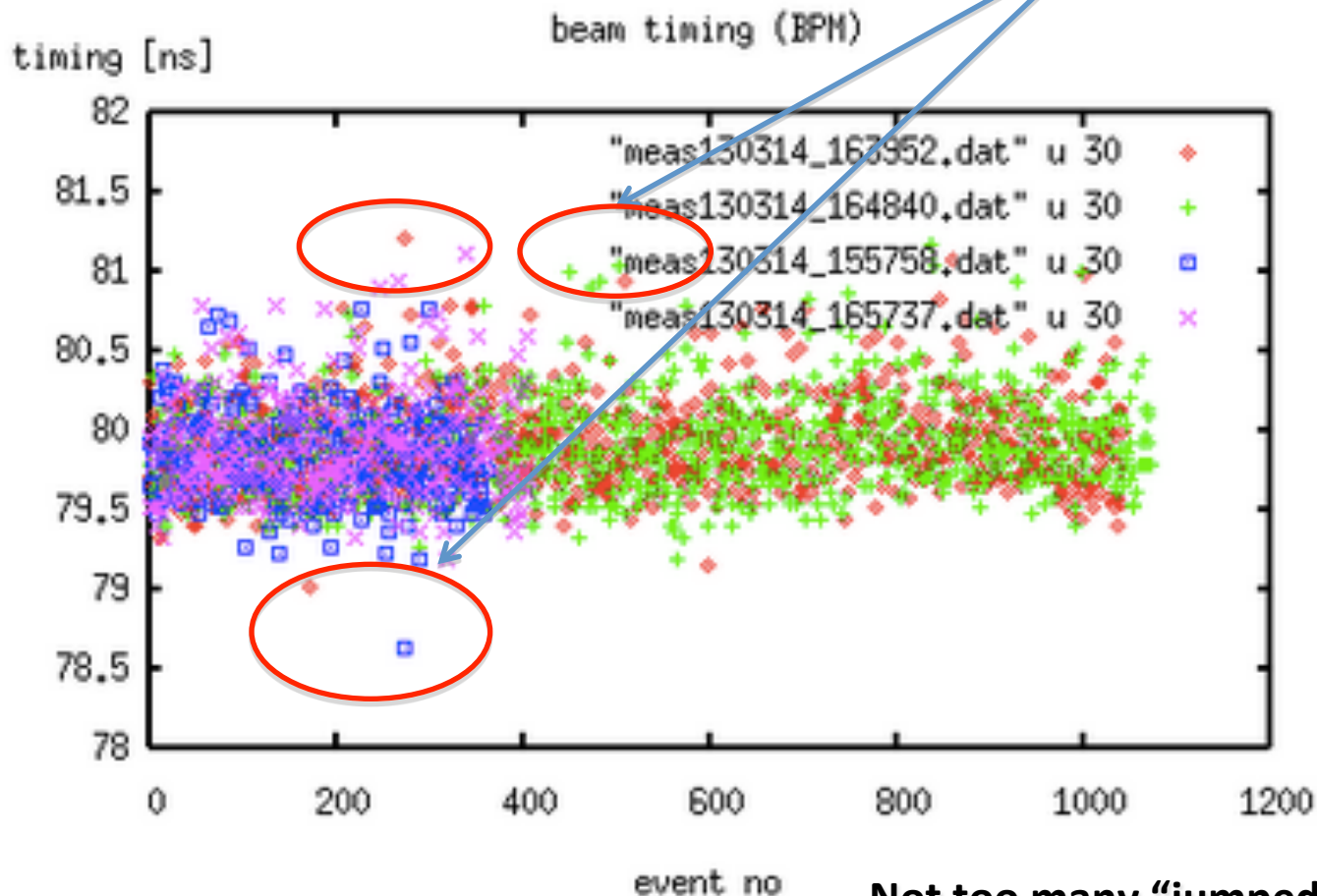

**Not too many "jumped" events currently ,  
will keep watch**



# offline TDC cut → then compare signal jitter / phase jitter

- apply to TDC cut selection on panel
- first look at TDC raw value in data to decide cut range

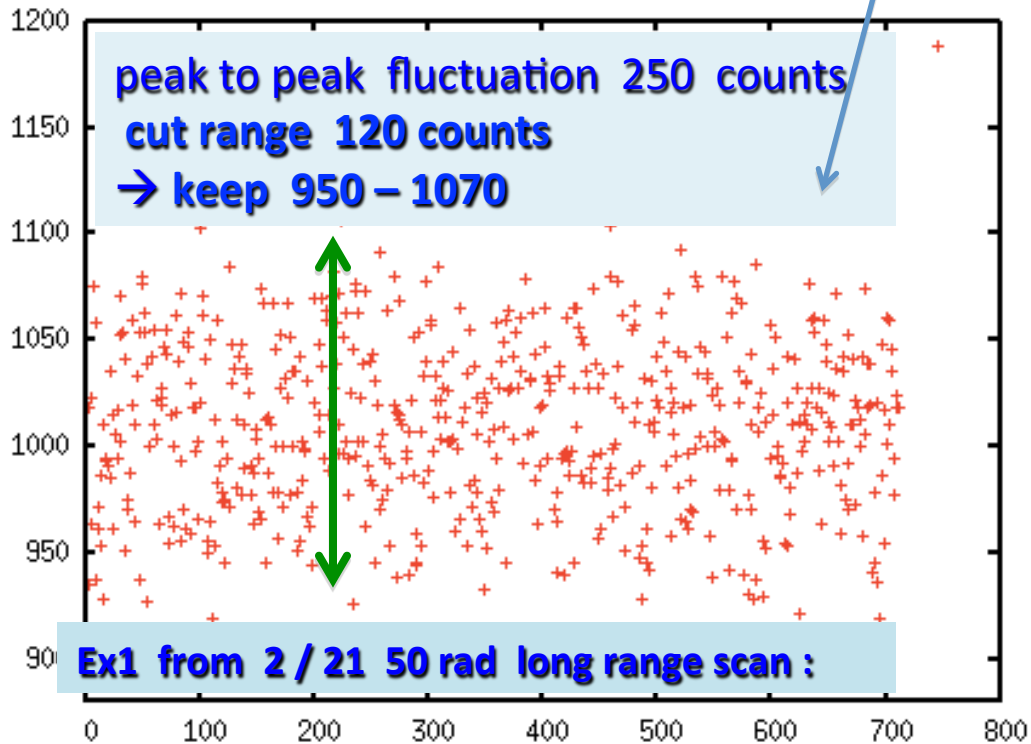

- no significant improvement seen yet
- may be effective for offline / online use when timing jitter is more serious

Change in fitted M

Before :  $M=0.219 \pm 0.013$

After:  $M=0.233 \pm 0.012$

change in  $\chi^2$

(→ small improvement ?)

Before : kai:  $3.00E2/98$

After: kai:  $2.73E2/98$

## Demonstration of stability in IPBSM operation : signal Jitter

long term stable performance is maintained under various scan conditions → considered as “standard”

Long range scans dedicated to error studies compared to (20 rad) scans immediately before / after  
 → jitter is not increased for longer range scans or finer scans, just as stable  
 (beam & IPBSM conditions, analysis method kept consistent)

Comp Sig. jitter is quite consistent at generally 20 – 25 % (@peak of fringe scans)

data	range	Comp sig jitter (@peak of fringe scans)	S/N	BG jitter (scaled by S/N)	
130314_155758	20 rad Nav = 10	21.1 %	6.4	4.5 %	Long scans from other periods show similar stability
130314_165737	20 rad Nav = 10	25.2 %	6.2	2.7 %	
130314_163420	20 rad <b>Nav = 20</b>	24.3%	5.8	4.0 %	Fine scan Nav = 20 events at each phase step
130314_163952	<b>60 rad</b> Nav = 10	25.4 %	5.8	4.1 %	Long range scans 60 rad (usually 20 rad)
130314_164840	<b>60 rad</b> Nav = 10	26.3 %	5.3	6.0 %	

Error source	M reduction factor	
<b>Fringe tilt (z, t)</b> <b>Major bias</b> <b>Limited by alignment precision</b>	$C_{t,tilt} \cdot C_{z,tilt} > 0.85\%$	tilt $\sim$ few mrad ??    not sure since e beam may be rotated in transv plane
<b>profile imbalance</b> <b>U path vs L path</b>	Maybe 5 : 6 ( $\leftarrow \rightarrow C_{t,pro} \sim 98\%$ )	However: projected laser profile (spot size) of laserwire scan not strictly Gaussian
<b>power imbalance</b>	$C_{pow} > 98.5\%$	<b>Measured directly for each path</b>
<b>polarization</b>	$C_{pol} = 96.5 \pm 1.3\%$ (after optimization of $\lambda/2$ plate)	<b>Measured laser polarization and half mirror reflective properties</b>
<b>Phase drift</b>	$C_{phase} > 99.6\%$ <b>Drift : <math>&lt; 70</math> mrad / min</b> during consecutive fringe scans	
<b>Laser path alignment</b>	$C_{t,pos} : \sim 99\%$ $C_{z,pos} : > 98\%$	<b>Resolution of mirror actuators aligning laser to beam</b>

Still uncertain for quantitative evaluation:

- **relative position jitter (phase jitter)**
- **Spatial coherence**

Could be major bias

# evaluation of Fringe Tilt

## practical application of beamtime “tilt scan”

Can observe M reduction Ctilt (70 - 80% if left uncorrected)  
directly from change in M wrt e beam (regardless of beam tilt)

Ex#1 3/8 : fringe pitch adjustment:

(M174LY changed 9.056 mm  $\rightarrow$  9.014 mm)

Max. M changed as 0.25  $\rightarrow$  0.32

M reduction before optimization bt “tilt scan”

Cz,tilt= 0.78  $\leftrightarrow$  longitudinal tilt  $\sim$  1.5 mrad

(assume  $\sigma_{z\text{-laser}}$  = 20 micron)

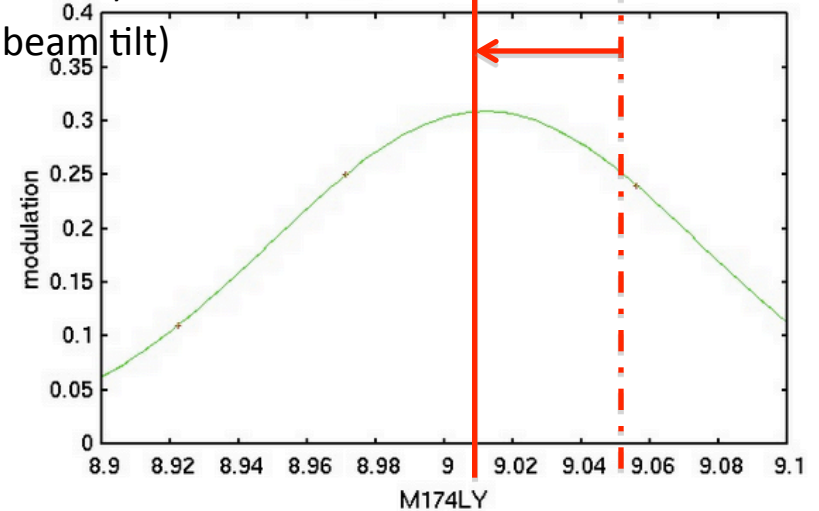

(study of fringe tilt by Okugi-san)

EX#2: 3/14 : fringe roll adjustment :

(M174XL changed 11.35 mm  $\rightarrow$  11.45 mm)

Max M changed as 0.1  $\rightarrow$  0.14

M reduction before optimization bt “tilt scan”

Ct,tilt = 0.71  $\leftrightarrow$  transv tilt  $\sim$  4.4 mrad

(assume  $\sigma_x$  = 8 micron)

Each time change mirror, access to IP to align path  
 $\rightarrow$  Will make necessary mirrors remote controllable

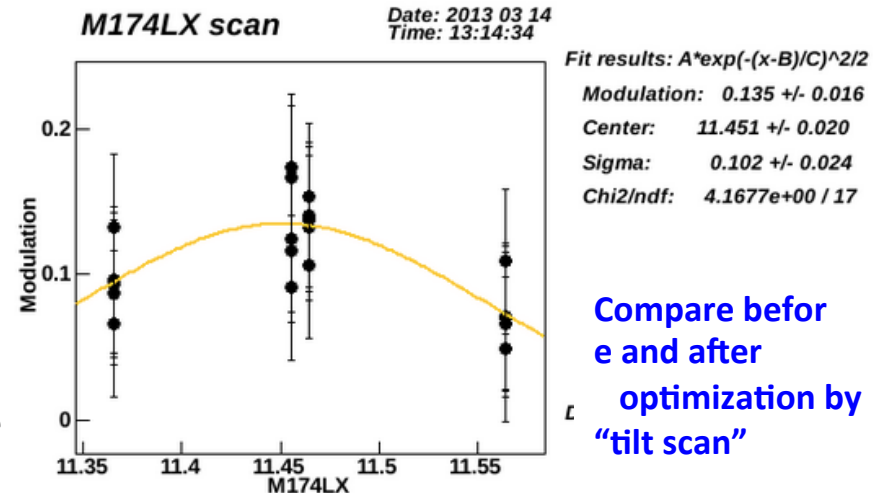

# Gamma detector

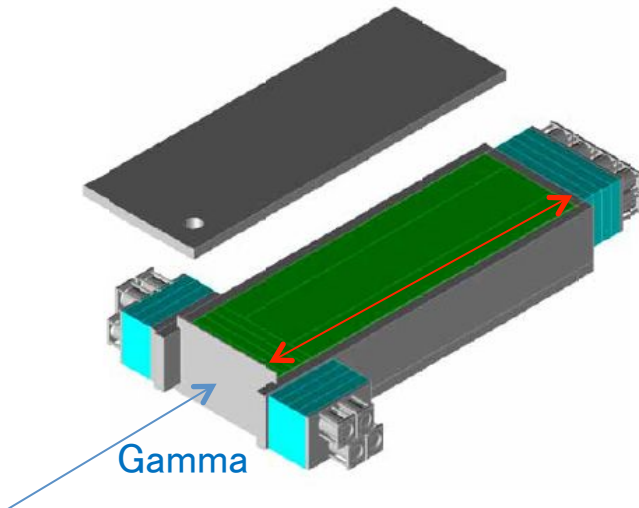
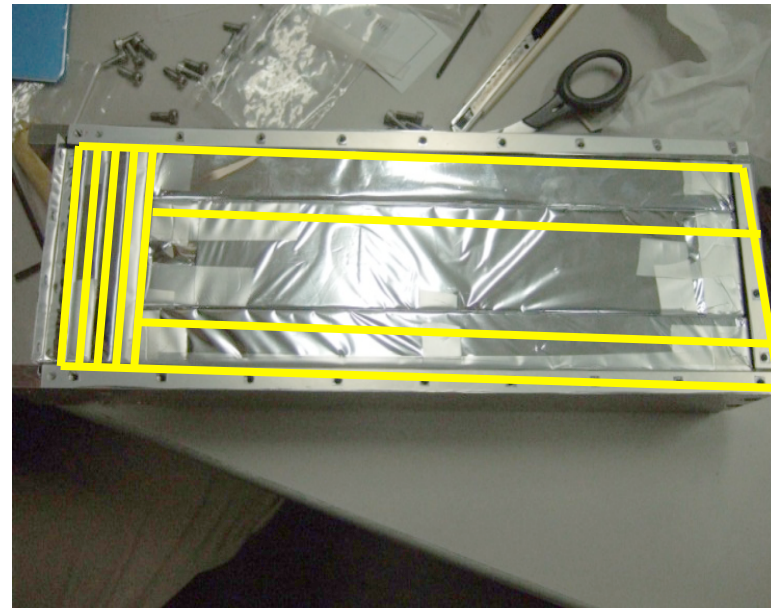
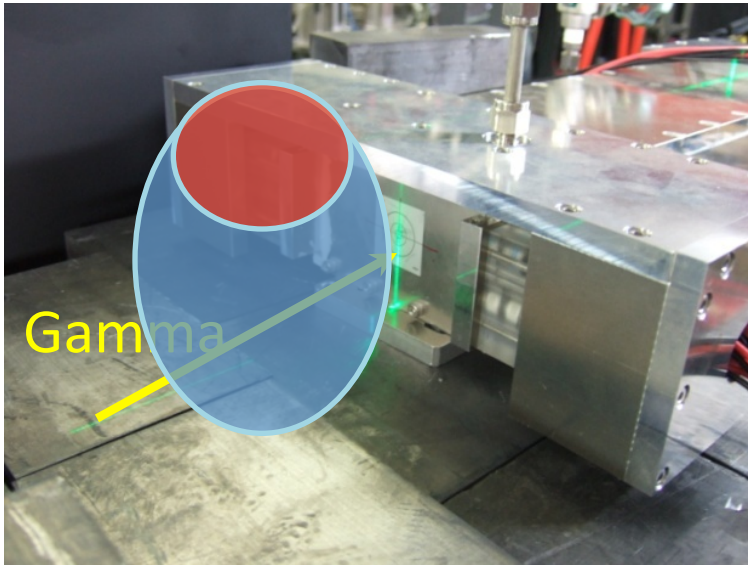

Calorimeter like gamma detector

- Multi layered CsI(Tl) scintillator
- PMT R7400U (Hamamatsu Photonics)

Beam longitudinal direction:  
33cm (17.7 radiation length)

Width : 10 cm  
Height : 5 cm



# Phase control by optical delay line

Optical delay line (~10 cm)  
Controlled by piezo stage

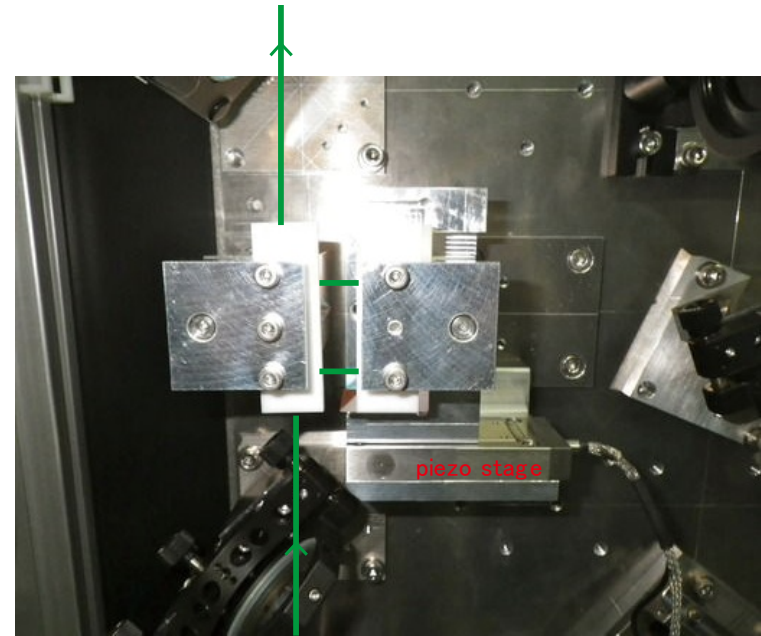
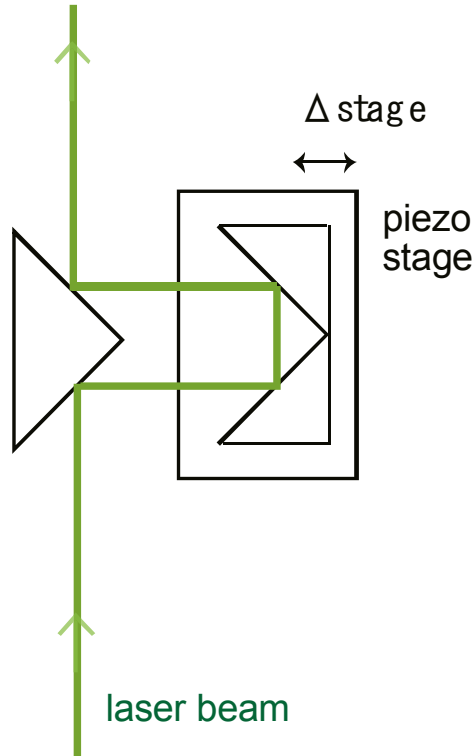

Movement by piezo stage :  $\Delta_{stage}$

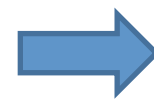

Phase shift

$$\Delta\alpha = 2\pi \frac{\Delta_{stage}}{\lambda}$$

# measurement scheme

wire scanner, laser wire

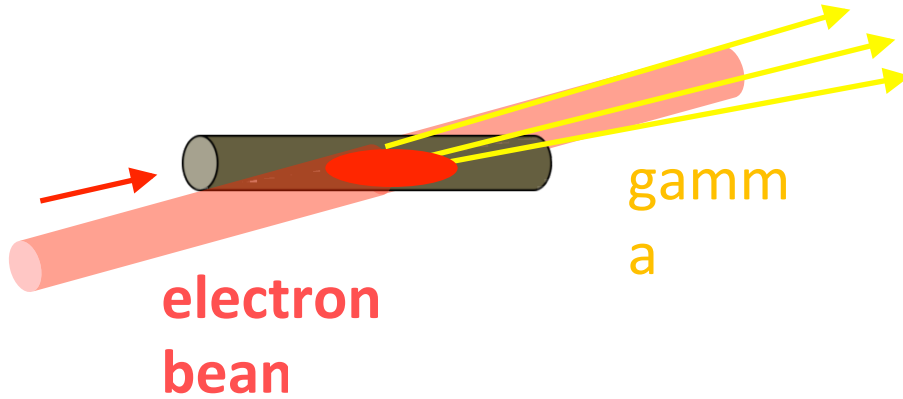

Total energy of gamma ray

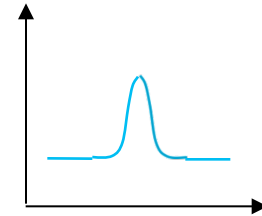

Calculate beam size from Gaussian sigma

wire position

measurable beamsize  $\sim 1\mu\text{m}$

Shintake monitor

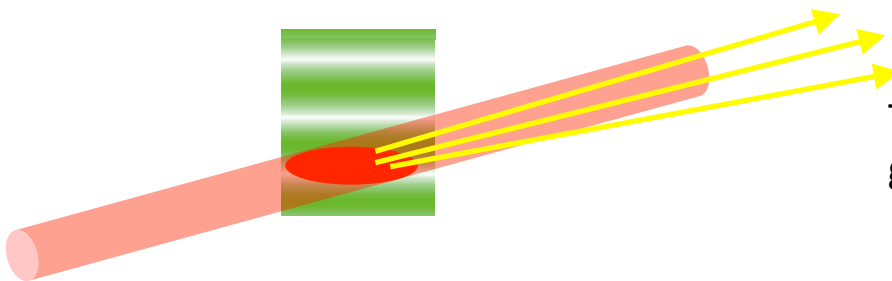

Total energy of gamma ray

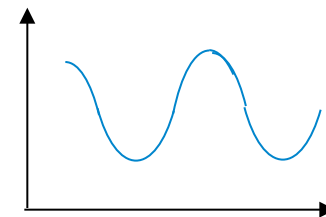

Calculate beam size from contrast of sine curve

Phase of laser fringe

measurable beamsize  $< 100\text{nm}$

mode	D [mm]	L [mm]	f [mm]	$2\frac{L}{D}$
2 to 8 deg	61.9	900	250	29.0
30 deg	61.9	400	300	12.9
174 deg	61.9	350	250	11.3

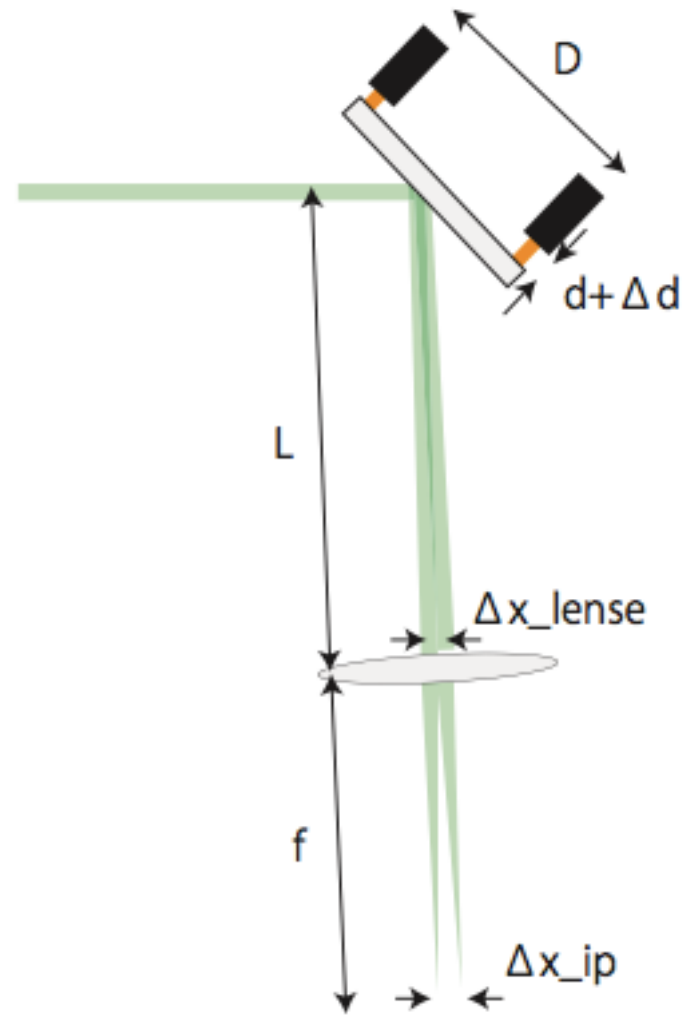
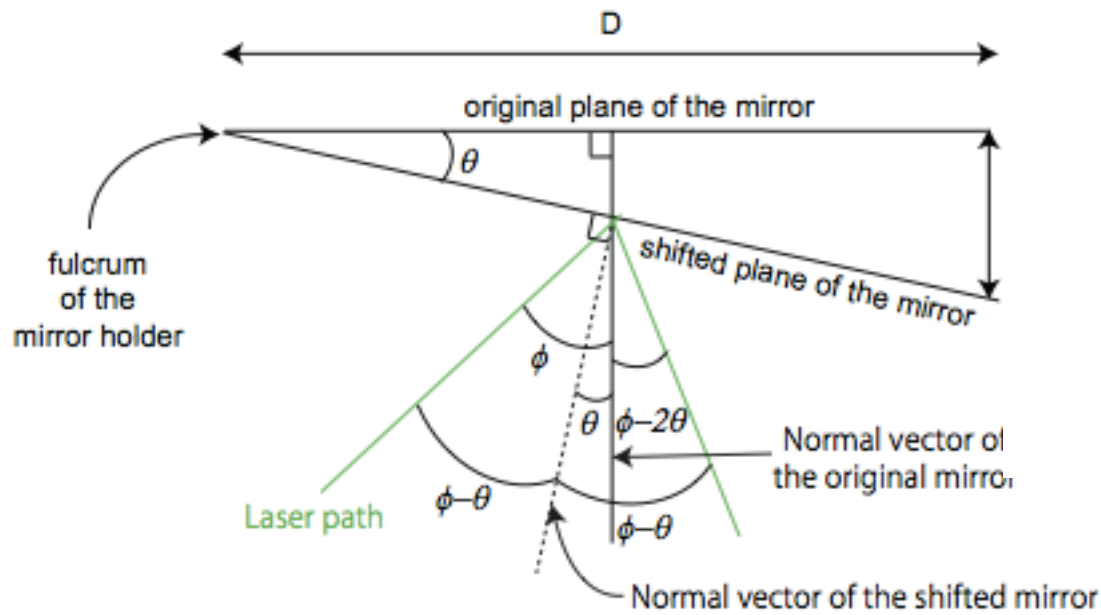

$$\Delta x_{IP} = 2f \tan \frac{\Delta d}{D}$$

$$\approx 2\frac{f}{D} \Delta d$$

# M reduction Factor method#1

How large M can we measure at low  $\theta$  mode ?  
 Observe consistency with higher modes

Note) this is a demonstration of “method #1” using a particular data sample  
 Conditions vary over time  
 error bars simply taken from fitting panel  $\rightarrow$  very preliminary values

Data from  
 2012 / 12/5

M (measured) M (expected from higher modes) reduction

$\theta$ [deg]	$M_{\text{meas}}$	$M_{\text{ideal}}$ expected from 7 deg	$M_{\text{ideal}}$ expected from 30 deg	$C_{\text{total}} = M_{\text{meas}} / M_{\text{ideal}}$
2.75	$0.944^{+0.056}_{-0.066}$	$0.981 \pm 0.013$	$0.987 \pm 0.002$	$0.962^{+0.038}_{-0.059}$
7	$0.882 \pm 0.071$	-----	$0.917 \pm 0.01$	$0.962^{+0.038}_{-0.078}$
30	$0.214 \pm 0.040$ $M_{\text{max}}$	-----	-----	

mode switching

Similar results for 2-8 ° mode (within error bar range)

Data from  
 2012 / 12/20

M (measured) M (expected from higher modes) reduction

$\theta$ [deg]	$M_{\text{meas}}$	$M_{\text{ideal}}$ expected from 174 deg	$C_{\text{total}}$
30	$0.732 \pm 0.034$ $M_{\text{max}}$	$0.790 \pm 0.006$	$0.926 \pm 0.044$
174	$0.246 \pm 0.027$	-----	-----

mode switching

There is some M reduction here

## Inconsistency in $\sigma_{y, meas}$ : IPBSM systematics vs e beam factors

### ◆ Apparent discrepantcy when switching to higher deg modes

Ex1: measured  $\sigma_{y+}$  about 70 nm at 174 deg mode

if this is “real” → expect  $M = 0.79$  at 30 deg, however stable  $M_{max} = 0.65$  ↔ 125 nm

Ex2: sometimes consistent : 2-8 → 30 deg mode → *under what circumstances ??*

Dec 5:  $M = 0.94$  measured at 7 deg consistent with  $M = 0.3$  at 30 deg

*However not always so*

### ◆ show inconsistency, larger M than expected when go to higher $\theta$ → Kubo-san’s studies

Ex 3 2/6 Swing shift

- 6.9 deg  $M_{max}$  about 0.8 --> 460 nm
- after switch to 30 deg mode:  $M = 0.3$  --> 240 nm

### ◆ seem to do better when switching between 2-8 deg modes (???)

Ex 4: 2/5 Swing:

- 4.12 deg mode :  $M = 0.8$  --> 782 nm
- go to 6.87 deg mode :  $M = 0.55$  --> 768 nm consistent

- *When good consistency (e.g. 12/5 7 deg → 30 deg) :*

*is it due to very little IPBSM errors, or something changed in e beam condition??*



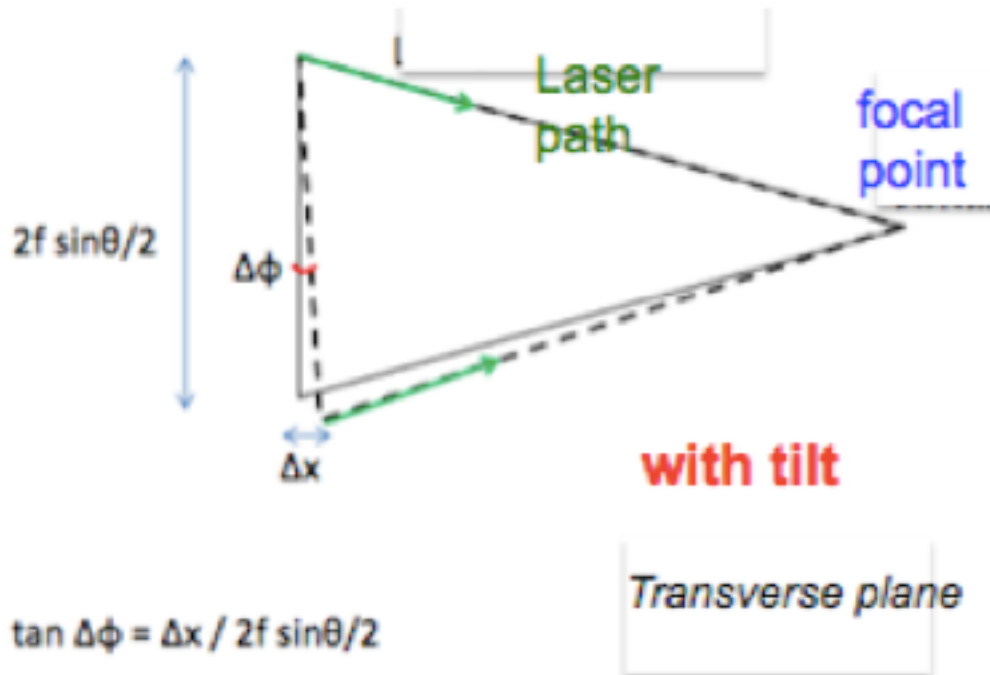
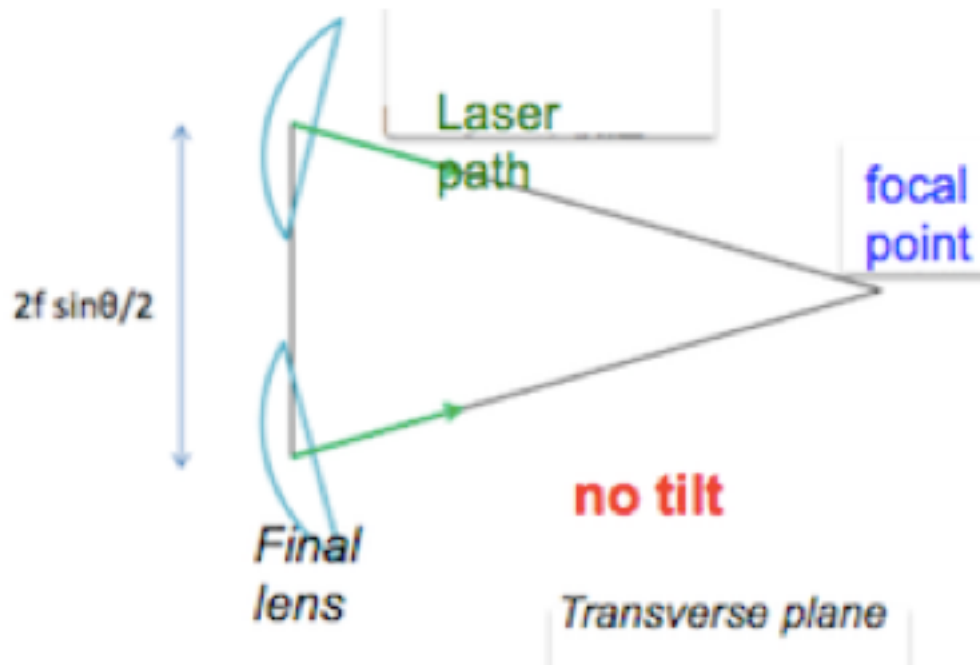

# Fringe Tilt

↔ Laser fringes not completely perpendicular to beam axis  
10 - 20 m rad

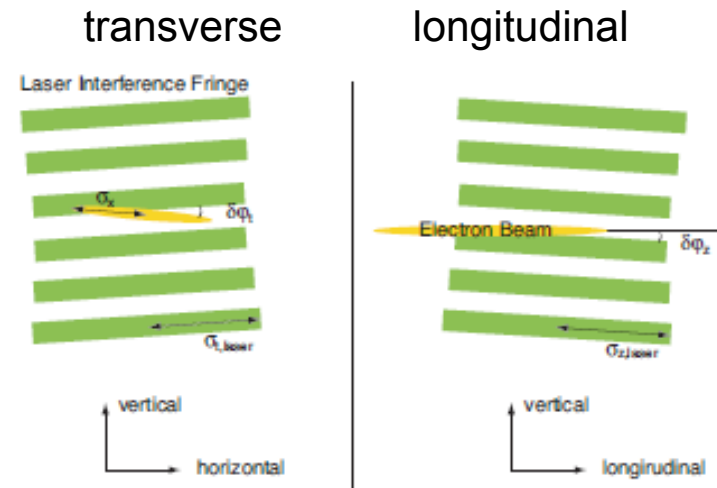

$$C_{z,tilt} = \exp(-2k_y^2 \sigma_{z,laser}^2 \delta\varphi_z^2)$$

$$\sigma_y^2 \rightarrow \frac{\sigma_y^2}{\cos^2 \delta\varphi_z} + \sigma_{z,laser}^2 \sin^2 \delta\varphi_z \simeq \sigma_y^2 + \sigma_{z,laser}^2 \delta\varphi_z^2$$

$$C_{t,tilt} = \exp\left(-2k_y^2 \frac{\sigma_x^2 \delta\varphi_t^2}{1 + (\sigma_x/\sigma_{t,laser})^2 \sin^2 \phi}\right) \simeq \exp(-2k_y^2 \sigma_x^2 \delta\varphi_t^2)$$

causes  $\sigma_y^*$  to be over-evaluated as :

$$\sigma_y^2 \rightarrow \sigma_y^2 \cos^2 \delta\varphi_t + \frac{\sigma_x^2 \sin^2 \delta\varphi_t}{1 + (\sigma_x/\sigma_{t,laser})^2 \sin^2 \phi} \simeq \sigma_y^2 + \sigma_x^2 \delta\varphi_t^2$$

# Assessment of Polarization related systematic errors

## Motives:

### Quantitative evaluation of polarization / power related systematic errors

- **Confirm validity of  $\lambda/2$  plate setting** during past / present beam time
  - **why M changed so much ????** (0.5 --> 0.93 @ 7 deg) with  $\lambda/2$  plate
  - **Find out power balance U vs L path** for Dec 's measurements
- Measure high power at usual place Immediately in front of 30 deg lenses

Polarization  
measurement

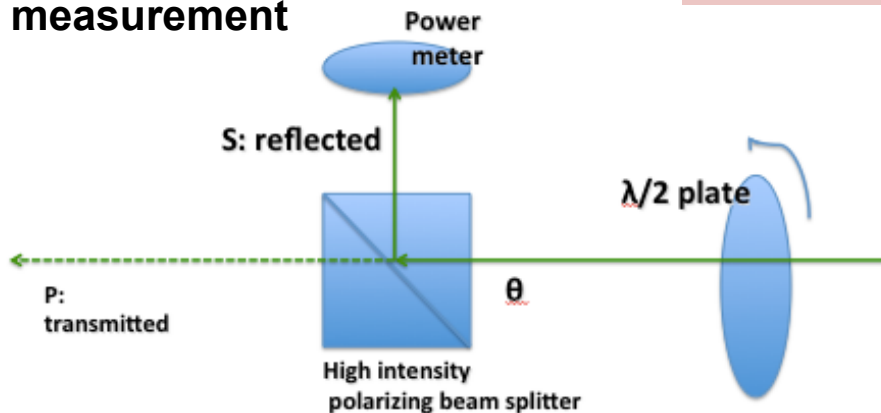

setup

Power  
measurement

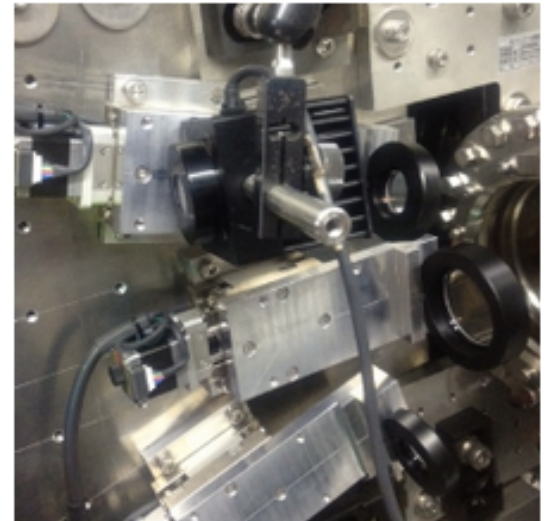

half Lamda Scan e130130\_21205

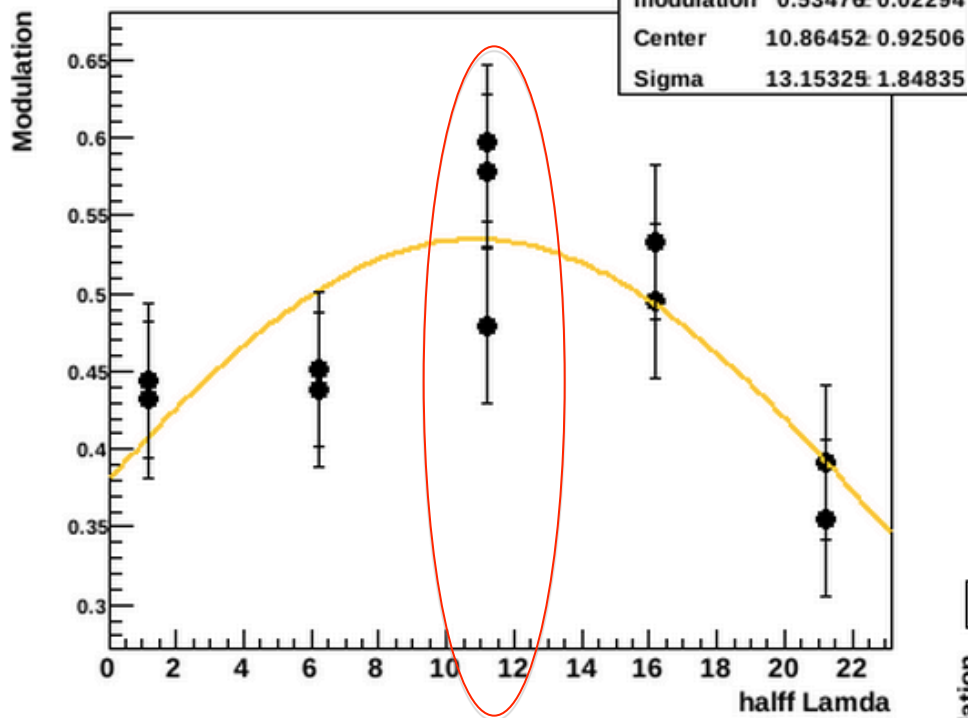

**Polarization measurement results confirmed during actual beamtime**

**Half lambda plate 11.2 deg for pure S → highest M**

HarfLambda Scan e130206\_19104

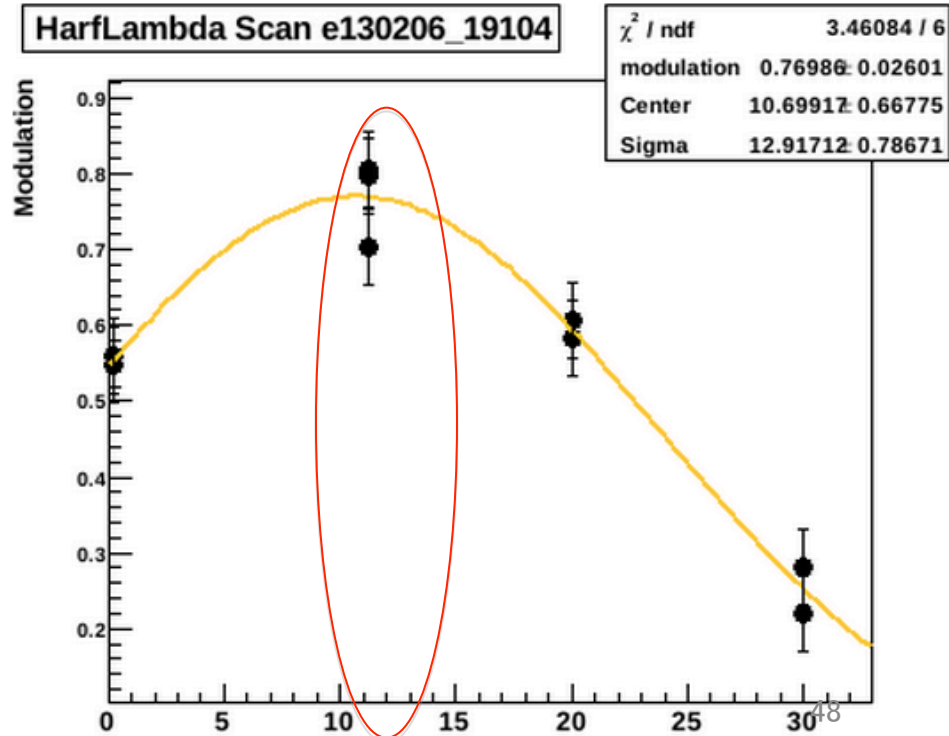

# laser path misalignment

precision of alignment by mirror actuator

- $\Delta z$ , about 15-20% of  $\sigma_{z,laser}$  (from zscan)
- $\Delta t$  about 5-10% of  $\sigma_{t,laser}^*$  (from laserwire scan)

$\sigma_{z,laser}$  about half of  $\sigma_{t,laser}$

longitudinal  $C_{z,pos} > 98.9\%$   
 transverse  $C_{t,pos} \sim 99.9\%$

longitudinal : 
$$C_{z,pos} = \exp\left(-\frac{z_0^2}{2\sigma_{z,laser}^2}\right)$$

transverse : 
$$C_{t,pos} = \frac{1}{\cosh\left(-\frac{l_1^2}{4\sigma_{t,laser}^2}\right)}$$

## longitudinal

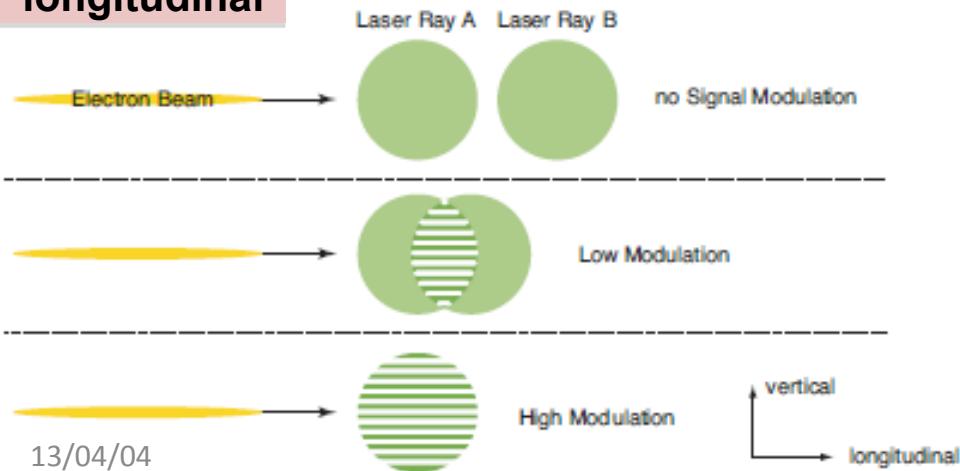

## transverse

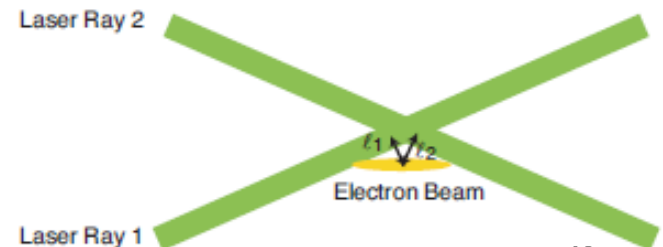

# Not certain#2: Phase (relative position) jitter

From beam: if  $\Delta y \sim 0.3 \sigma_y$

$C \sim 88.4\%$  for 70 nm @ 174 deg

$C \sim 96.2\%$  for 150 nm @ 30 deg mode

$C \sim 97.7\%$  for 500 nm @ 7 deg mode

phase jitter observed from fringe scan: about 200 mrad ??

→  $C \sim 98\%$  (????)

$$C_{phase} = \exp\left(-\frac{(\Delta\alpha)^2}{2}\right) \iff C_{\Delta y} = \exp\left(-2(k_y \Delta y)^2\right) \quad \left(k_y = \frac{2\pi}{\lambda} \sin\left(\frac{\theta}{2}\right)\right)$$

$$\implies \Delta y = \frac{\Delta\alpha}{2k_y} = \frac{\lambda \Delta\alpha}{4\pi \sin(\theta/2)}$$

Beam Position Jitter



vertical

longitudinal



Fringe Position Jitter





$$\alpha \rightarrow \alpha + \Delta\alpha$$

$$y \rightarrow y + \Delta y$$

$$\sigma_y^2 \rightarrow \sigma_y^2 + (\Delta y)^2$$

## Phase jitter

## beam pos jitter

## beam size

$$C_{phase} = \exp\left(-\frac{(\Delta\alpha)^2}{2}\right)$$

$$\Leftrightarrow C_{\Delta y} = \exp\left(-2(k_y \Delta y)^2\right)$$

$$k_y = \frac{2\pi}{\lambda} \sin\left(\frac{\theta}{2}\right)$$

$$\Delta y \Leftrightarrow \frac{\Delta\alpha}{2k_y} = \frac{\lambda \Delta\alpha}{4\pi \sin(\theta/2)}$$

$\Delta\alpha$ [mrad]	$C_{phase}$	$\Delta y$ [nm] @2°	$\Delta y$ [nm] @8°	$\Delta y$ [nm] @30°	$\Delta y$ [nm] @174°
200	0.98	485	121	33	8.5
300	0.96	728	182	49	13
400	0.92	970	243	65	17
500	0.88	1212	303	82	21

## Correlation between phase jitter and beam pos jitter

**Typical requirement  $\Delta y < 0.3 \sigma_y^*$**

	2 deg	8 deg	30 deg	174 deg
Beam pos. jitter ( $\Delta y \sim 0.3 \sigma_y$ )	0.3 x 1 $\mu\text{m}$ = 300 nm	0.3 x 500 nm = 150 nm	0.3 x 100 nm = 30 nm	0.3 x 40 nm = 12 nm
IPBPM res. ( $< 1/3 * \Delta y$ )	< 100 nm	< 50 nm	< 10 nm	< 4 nm

# Syst. Errors specific to very small $\sigma_y^*$ (174 deg mode)

## Spherical wavefronts

Offset of ultra-focused e-beam vs laser waist

→ distorted fringes

$C_{sphere} > 99.7\%$

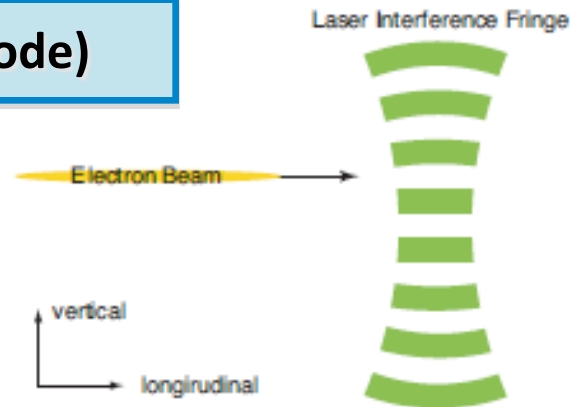

Solution is **focal point scan**

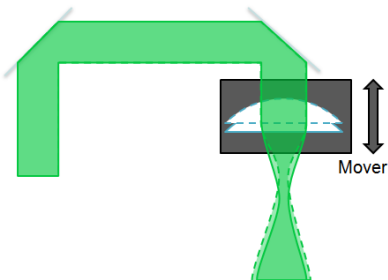

attach mover to lens  
→ align focal point to IP  
**within < 100  $\mu\text{m}$**   
( $\sim 0.1 \cdot \text{Rayleigh length } Z_R$ )

## Change of $\sigma_y^*$ within fringes

fringe pattern

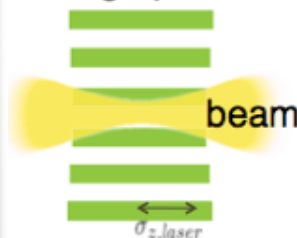

due to strong focusing,

$C_{growth} \sim 99.7\%$

Tiny  $\sigma_y^*$  is very sensitive to  
**relative position jitter !!**

**IPBPM** (O(nm) design resolution)  
under commissioning

- beam pos. monitoring
- feedback correction

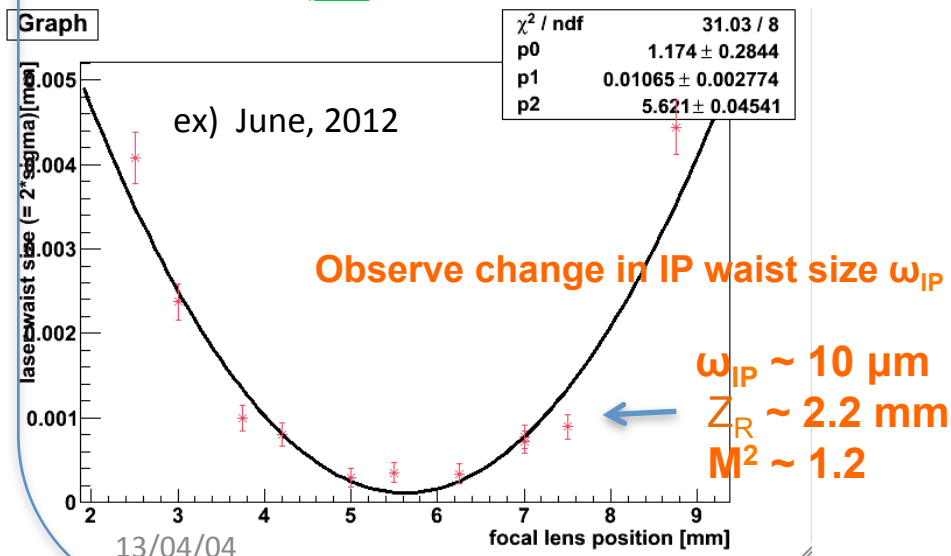
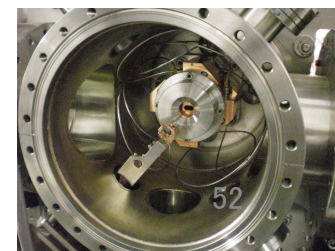

$$S(y) = S_{avg} (1 + M \cos(2k_y y + \alpha))$$

if  $y \rightarrow y + \Delta y$

relative position jitter  $\Delta y$

$$S(y + \Delta y) = S_{avg} (1 + M \cos(2k_y (y + \Delta y) + \alpha))$$

$$\begin{aligned} \Delta S &= |S(y + \Delta y) - S(y)| \\ &= S_{avg} M |\cos(2k_y (y + \Delta y) + \alpha) - \cos(2k_y y + \alpha)| \end{aligned}$$

Corresponding  
signal jitter (%)

**estimate relative position jitter**

from the amount of signal jitter it caused (inferred from fringe scans)

$S$ : measured Compt signal energy

$y$ : relative position

$2k_y y$ : fringe scan phase

$\alpha$ : initial phase

is  $(2k_y \Delta y)$  small enough to use approximation ??

depend on  $\theta$  mode

**174 deg mode is most sensitive !!**

for 30 deg mode

$$\left( k_y = \frac{\pi}{1028 \text{ nm}} \right) 2k_y \Delta y \ll 1$$

$$\therefore \frac{\Delta S}{S} = \frac{S_{avg} M \sin(2k_y y + \alpha) \cdot (2k_y \Delta y)}{S_{avg} (1 + M \cos(2k_y y + \alpha))}$$

**can use approximation for 30 deg mode ??**

at fringe scan mid point:  $\cos(2k_y y + \alpha) = 0$  ( $S \approx S_{av}$ )

$$\therefore \frac{\Delta S}{S} = M \cdot (2k_y \Delta y)$$

$$\Delta y = \frac{(\Delta S / S) [\%]}{2M \left( \frac{\pi}{1028 \text{ [nm]}} \right)}$$

Sig jitter due to rel pos jitter was observed at mid point

13/04/04

if  $\Delta y$  is about  $O(10 \text{ nm})$

$(2k_y \Delta y)$  is not small for 174 deg mode  $\left(k_y = \frac{\pi}{266 \text{ nm}}\right)$

if  $y \rightarrow y + \Delta y$

$$\sigma_y^2 \rightarrow \sigma_y^2 + \Delta y^2$$

$$\therefore \frac{\Delta S}{S} = \frac{S_{avg} M |\cos(2k_y(y + \Delta y) + \alpha) - \cos(2k_y y + \alpha)|}{S_{avg} (1 + M \cos(2k_y y + \alpha))}$$

Corresponding  
signal jitter (%)

[1] at fringe scan peak:  $\cos(2k_y y + \alpha) = 1$  ( $2k_y y = 2m\pi$   $m=1,2,\dots$ )

$$\therefore \left. \frac{\Delta S}{S} \right|_{peak} = \frac{M(1 - \cos(2k_y \Delta y))}{1 + M}$$

$$\Delta y = \frac{\cos^{-1}\left(1 - \frac{(\Delta S/S)[\%](1+M)}{M}\right)}{\left(\frac{2\pi}{266 \text{ [nm]}}\right)}$$

$\Delta S / S = 0$  from relative  
pos jitter is not zero at  
peak

[2] at fringe scan mid point:  $\cos(2k_y y + \alpha) = 0$  ( $S \approx S_{av}$ )

$$\therefore \left. \frac{\Delta S}{S} \right|_{mid} = M \cdot \sin(2k_y \Delta y)$$

$$\Delta y = \frac{\sin^{-1}\left(\frac{(\Delta S/S)[\%]}{M}\right)}{\left(\frac{2\pi}{266 \text{ [nm]}}\right)}$$

Sig jitter due to rel pos jitter  
was observed at mid point

depend on  $\theta$  mode

**174 deg mode is most sensitive !!**

(pitch  $d = \pi/k_y$  is most narrow)

# Optics reform in autumn: Change in Profile after Adjustment by Spectra Physics

## Re-optimize expander / reducer : Nov 21

Goal: Push intensity “hot spots” to center of profile

→ (maybe) resolve “two peak” structure in laserwire scan profile

•exchanged rear mirror to curvature is now 2 levels tighter

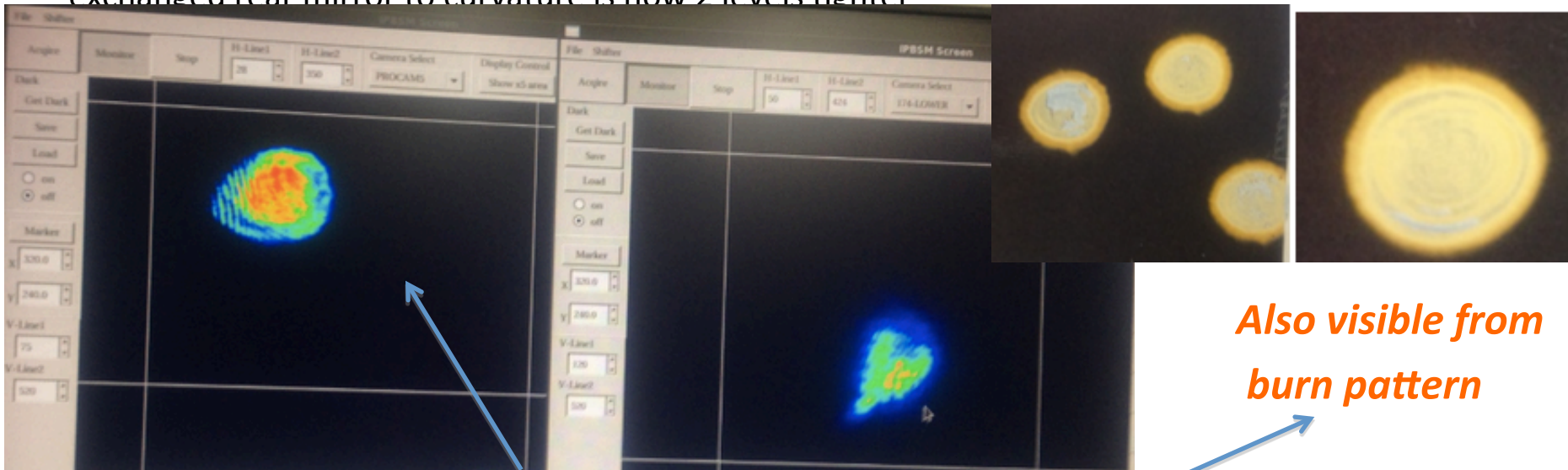

Results : **hot spots clearly pushed towards profile center**

•laserwire scan profile seem improved for 2-8 deg, 30 deg mode (not totally consistent)

Not much change overall in laser energy / power (1J peak energy , 6.3 W)

# Studies at 30 deg mode operation

Dec 20

13 consistent scans at 30 deg

Under optimized conditions

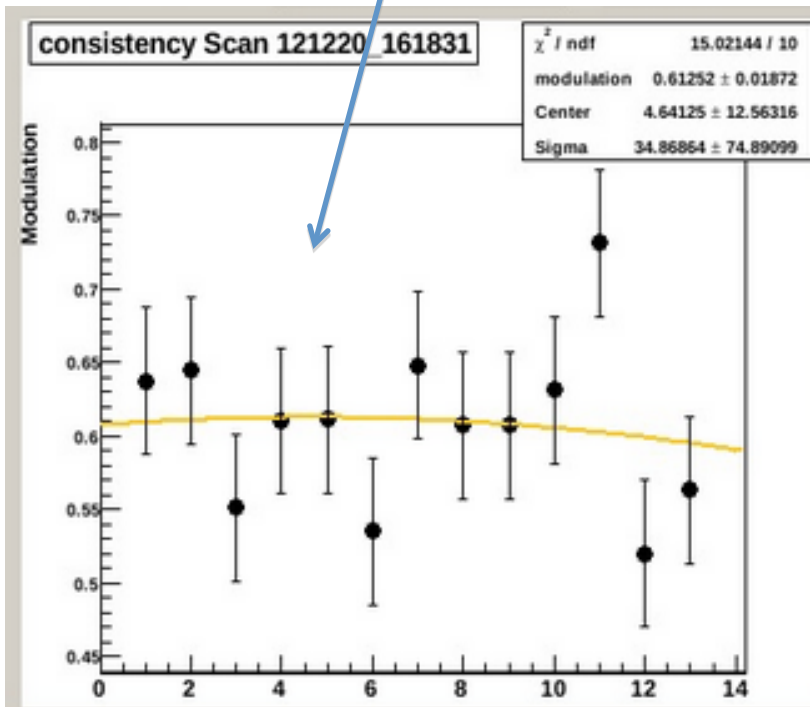

wakefield and beam intensity studies

Checking of linear / nonlinear knobs

Tests of effects of IPBSM systematic error sources

intensity scan

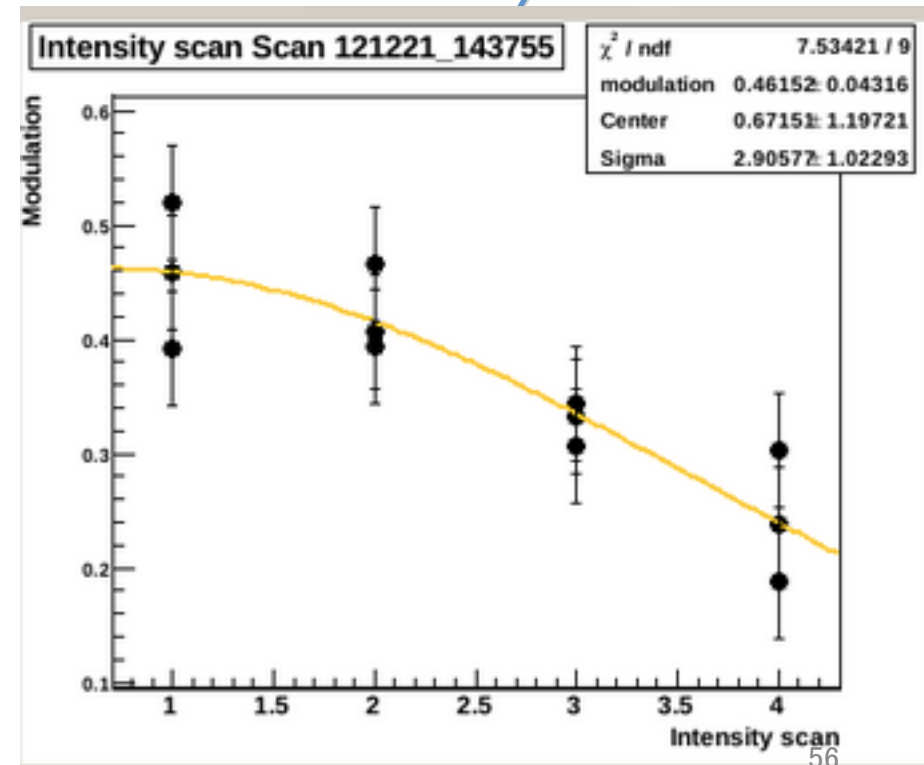

$\sigma_{y^*} = 137.3 \pm 18.4 \text{ nm}$

$M = 0.607 \pm 0.056$

13/04/04



Intensity cut at first set to  $3 \times 10^9$ , then later **lowered to  $1 \times 10^9$**  (as in Dec)

### intensity scans in 2013

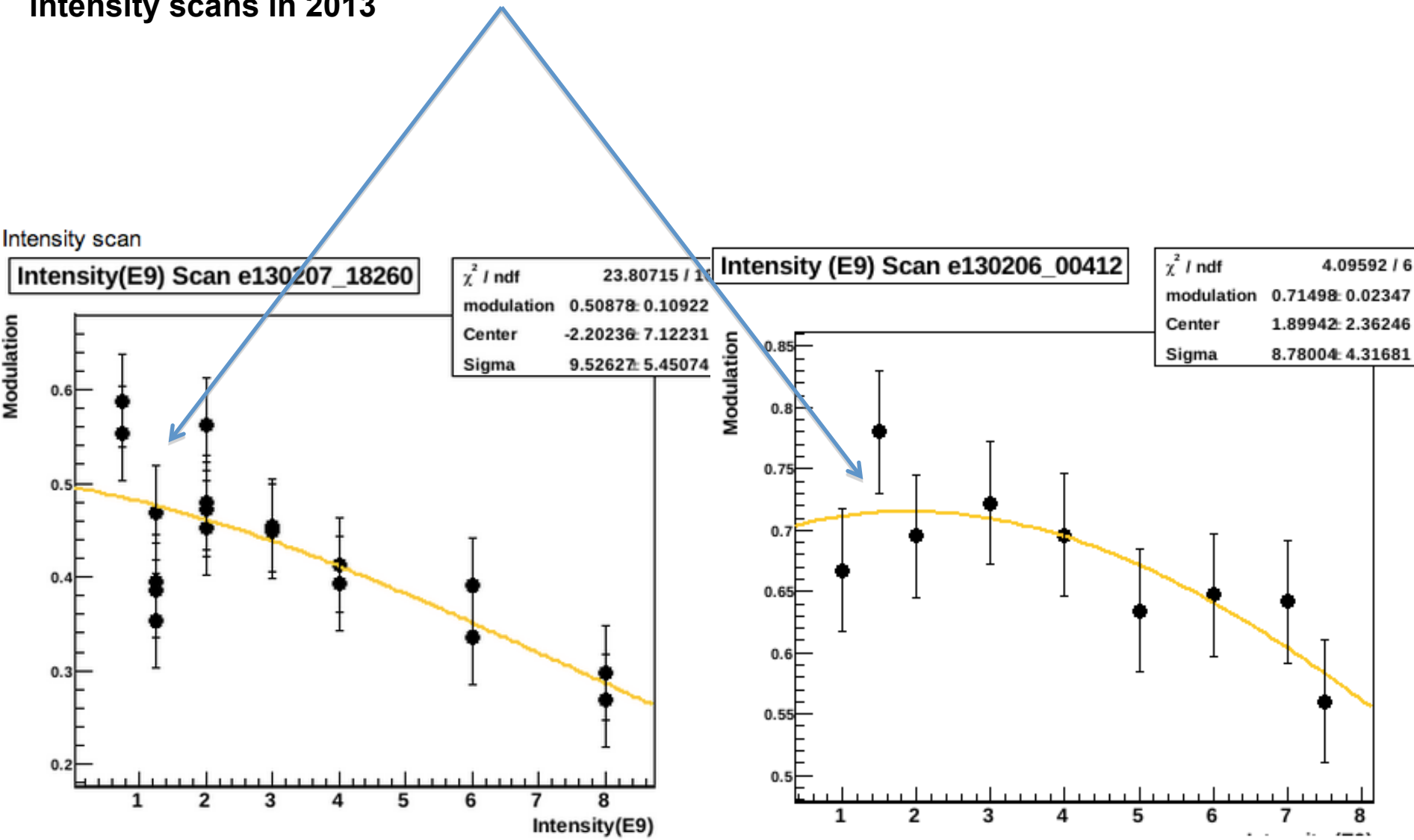

# Detection of M at 174 deg mode still limited by intensity

## ex: Dec 2012

high intensity cannot see significant M

