

# **New Results in Kicker Studies and Instrumentation**

**Junji Urakawa at GDE Meeting  
in Bangalore, KEK**

1. Fast Kicker R&D at ATF
2. Instrumentation at ATF
3. Prospect of ATF and ATF2

# 1. Fast Kicker R&D at ATF

**Purpose :** To show the technology on fast pulse PS does not give limitation within present our thoughts if we reduce the length of strip-line kicker about 30cm except for the problem of small coherent oscillation of neighboring bunches in the ring and other instability problem in the ring.

1. We should evaluate the emittance growth due to the about 0.5% coherent oscillation by fast kicker.
2. We should select the reliable hardware system according to **easy tuning, reliable operation**, simplicity of construction/beam commissioning and total cost reduction.

# Outline of Fast Kicker R&D



- The problem
- The specs.
- Present Technology on Pulse PS , ATF  
experimental Results and Future Plan
- Other Current ideas

# The problem

## Linac beam (like TESLA TDR):

- 2820 bunches(5640 bunches), 300nsec(150nsec) spacing (~ **300** km)
- Cool an entire pulse in the damping rings before main linac injection

## ILC damping ring beam:

- 2820 bunches(5640 bunches), closely spaced
- Eject every  $n^{th}$  bunch into linac (**leave adjacent bunches undisturbed?**)
- Minimum damping ring circumference depends on minimum realistic bunch spacing (kicker speed and **instability issues**)

# What an interesting problem!

There are physicists from ANL, CERN, Cornell, Daresbury, DESY, Fermilab, Frascati, Harvard, Illinois, KEK, LBNL, Minnesota, SLAC, and so on.

1. Reliability of fast kicker system.
2. Impedance of fast kicker system.
3. Effect of small coherent oscillation due to tail field of fast kicker.
4. Technology of feed-forward to stabilize the beam orbit of extracted beam.

# What we have to work with.

## Extraction:

- damping is finished, bunches are small (several microns (rms) in diameter) ; Need the demonstration of the experiment with fast kicker, high quality electron beam and precise emittance/orbit measurement at extraction line.
- kicker must preserve beam emittance for still-orbiting bunches as well as the kicked bunch.  
Need the measurement in the ring also.

# The specs.

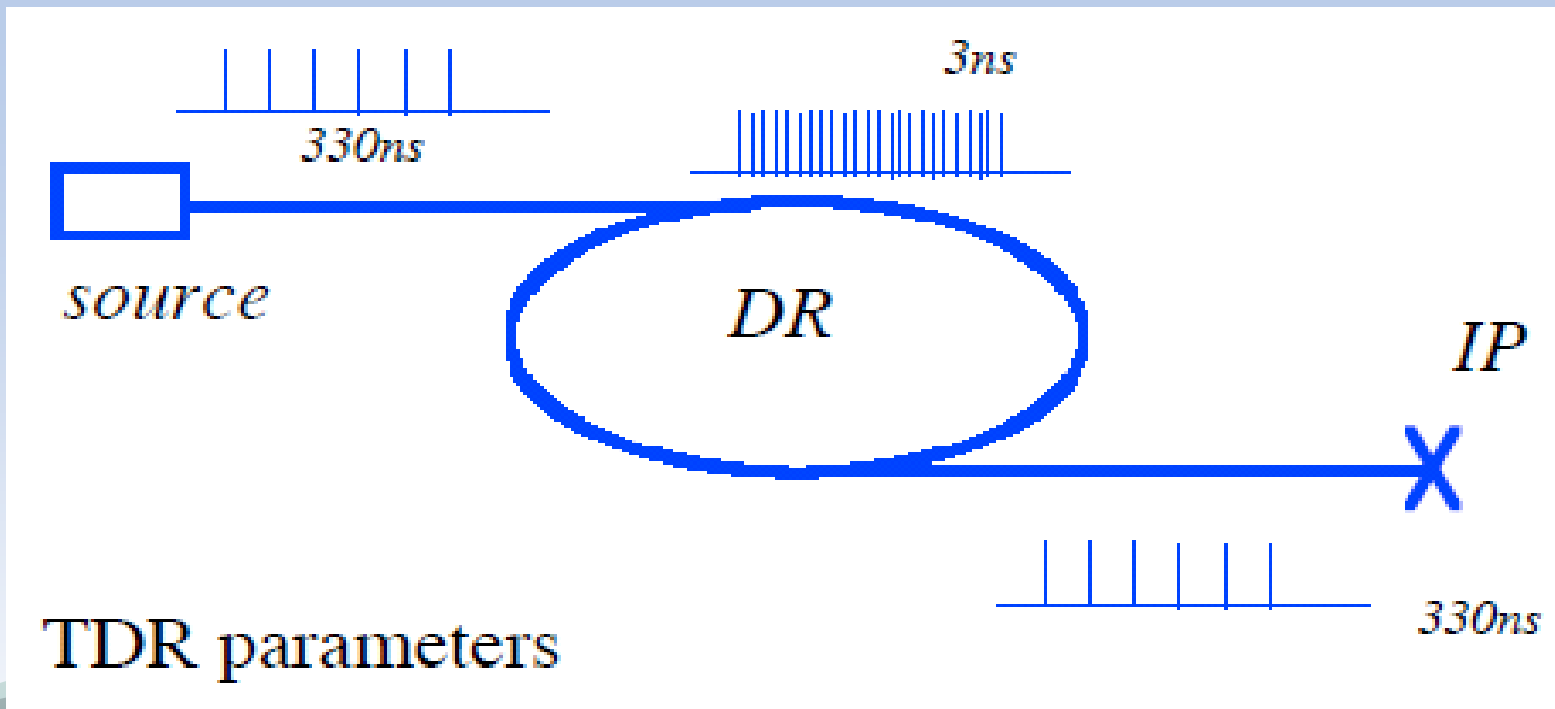

impulse: **100 G-m (3 MeV/c)  $\pm$  0.07 G-m (2 keV/c) @5GeV**

**At  $\beta \sim 50m$ , 0.6mrad kick**

residual (off) impulse: **0  $\pm$  0.07 G-m (2 keV/c)**

Rep. Rate in burst mode: **3MHz (or 6MHz)**

rise/fall time: **<3.077ns**

Rise and fall times should be symmetric due to the positron source scheme of the undulator.

leading edge < 3.1ns, **trailing edge < 3.1ns**

## Pulse generator

*FID Technology has very fast and high repetition rate pulse generators. The specification meets our requirements for the high voltage pulse source. We tested the kicker performance by using the pulse PS.*

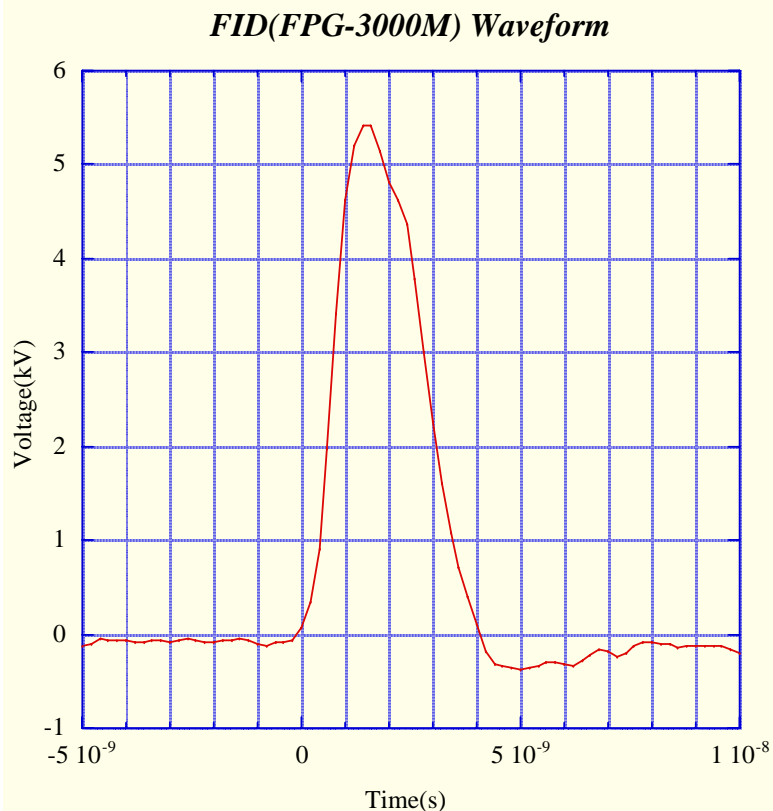

### Specifications

Amplitude at 50 ohm : 5 kV

Rise time : 1-1.4 ns

Pulse width at 50% of amplitude :  
2-3 ns

Maximum Pulse Repetition Frequency  
in burst mode : 3 MHz



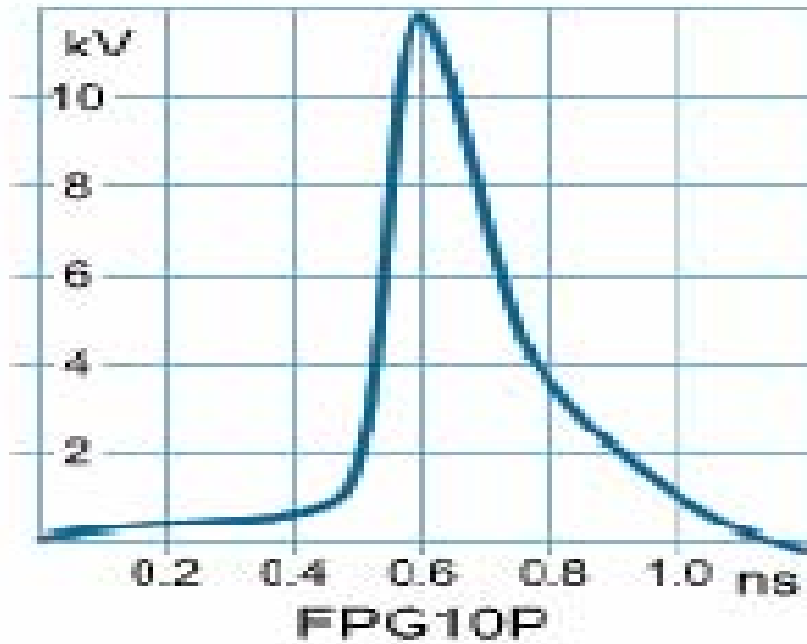

FPG10 & FPG 20

Horizontal : 2 nsec/div,  
 Vertical : 624 V/div  
 10kV, 20kV : possible but  
 3MHz PS is not available at  
 present.  
 The technology of fast pulse  
 PS will be upgraded soon.

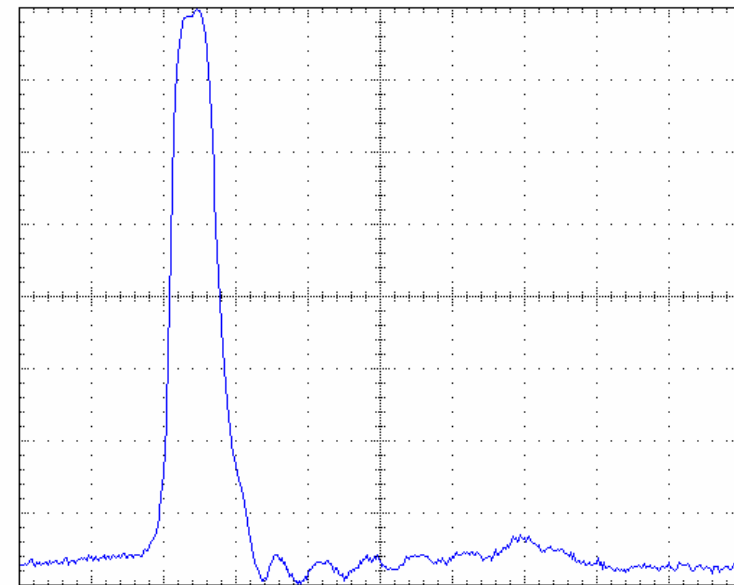

Copy of CH 1  
 Trace 2

2 ns/div 861 mV/div

04.10.2004  
 23:22:33

# Beam kick experiment at ATF DR

*The kicker pulse is applied to the strip-line electrode when the beam goes through the electrode.*

*The beam kick is observed by a turn-by-turn BPM as the amplitude of the oscillation of the betatron frequency component.*

*The kick effect is measured by scanning the pulse timing precisely.*

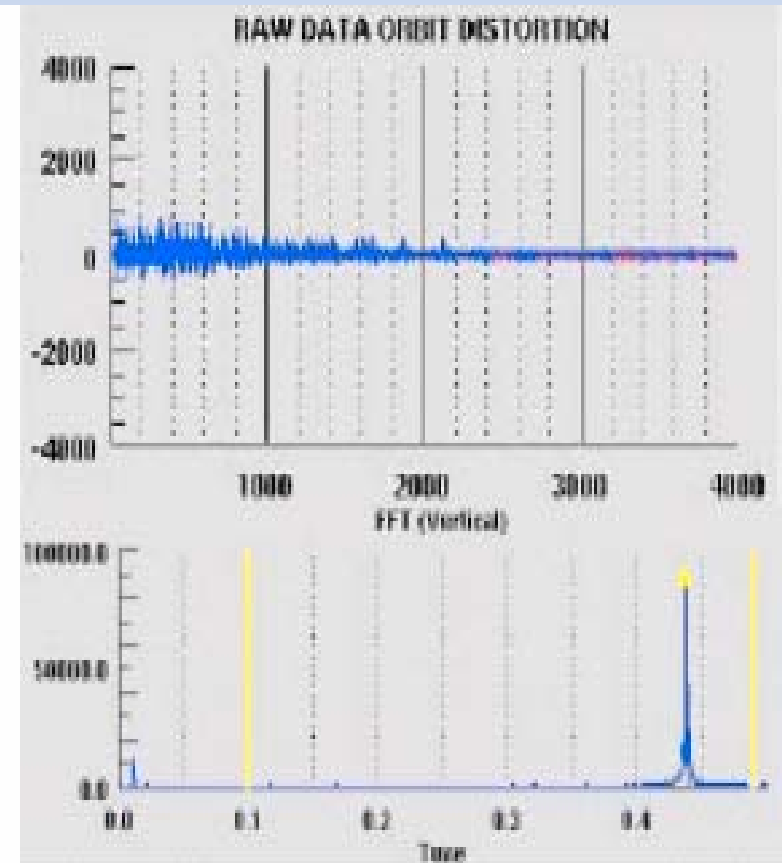
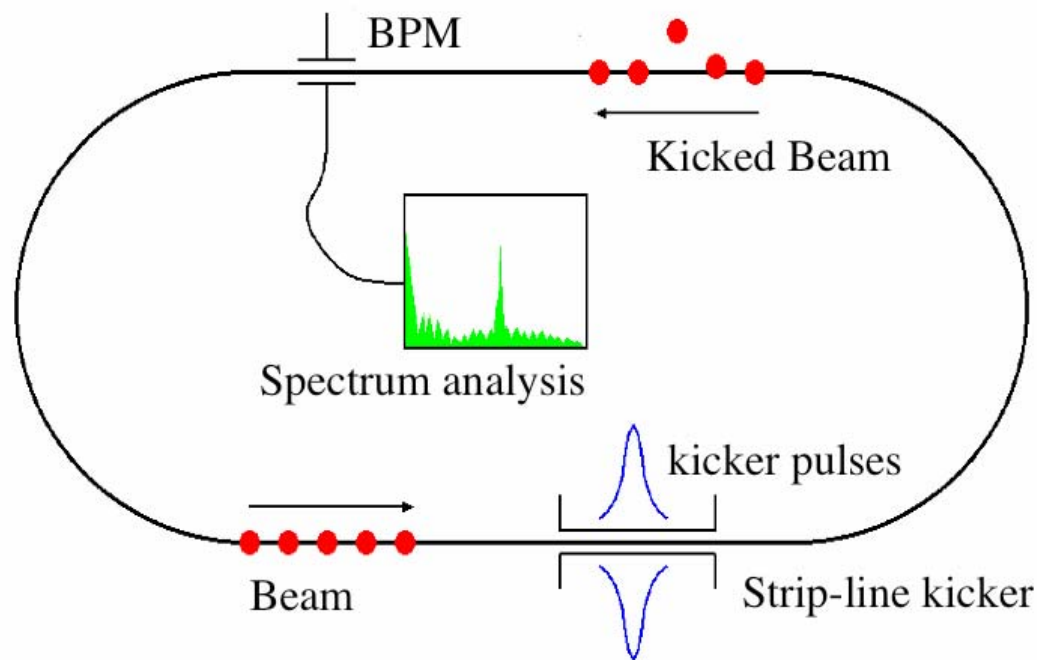

# Beam kick test at ATF

Location of the strip-line electrode  
in the damping ring

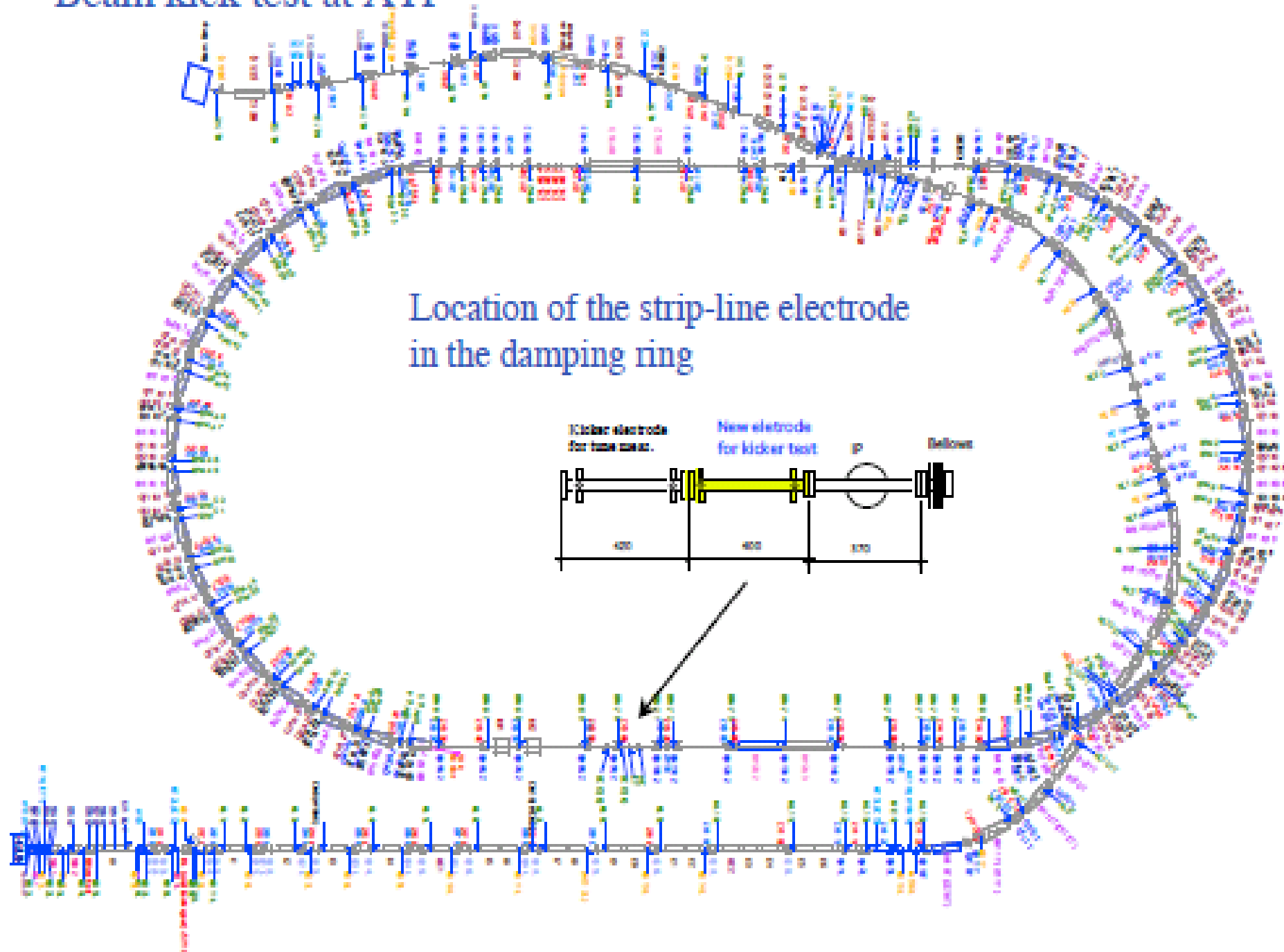

# ATF Kicker chamber for beam excitation

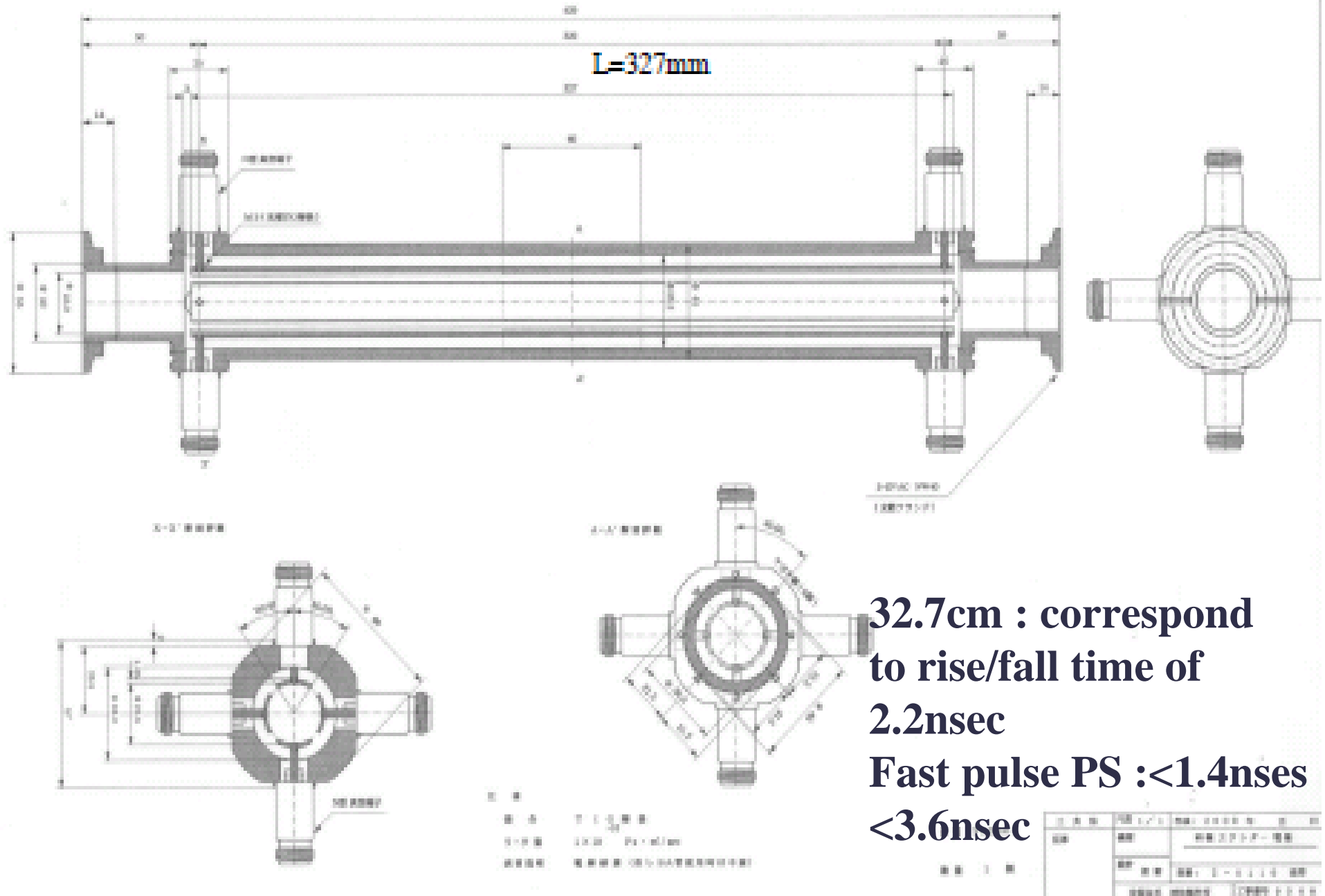

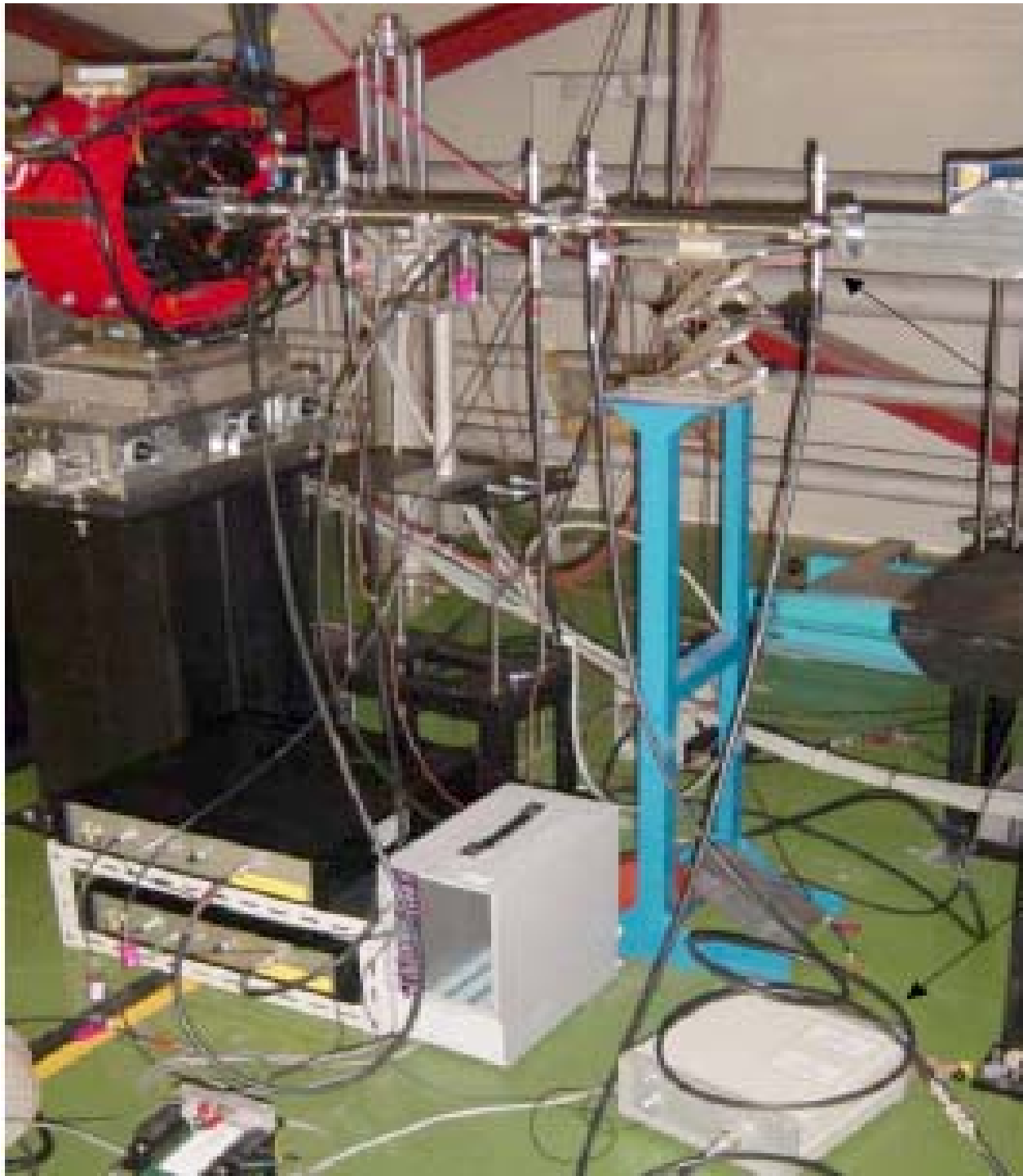

Strip-line  
Electrode

Pulse Power supply

We tested three kinds of fast pulse PS's.

1.FID (FPG5 – 3000M)

5kV peak, rise time  $\sim 1.4\text{ns}$ , timing jitter less than 30ps

2.DESY Behlke HTS-80-UF

2.5kV peak, rise time  $\sim 3\text{ns}$ , timing jitter less than 30ps

3.LLNL pulse PS

$\pm 3.1\text{kV}$  peak, rise time  $\sim 5\text{ns}$

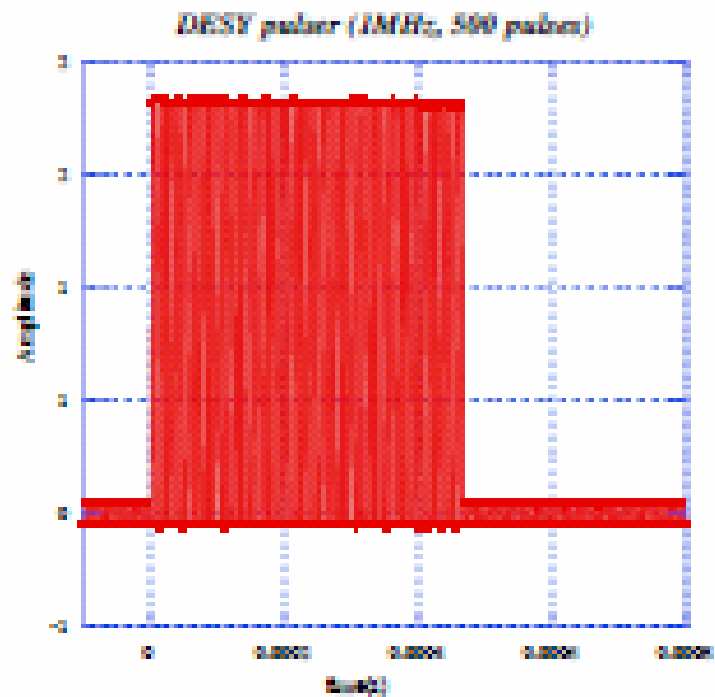
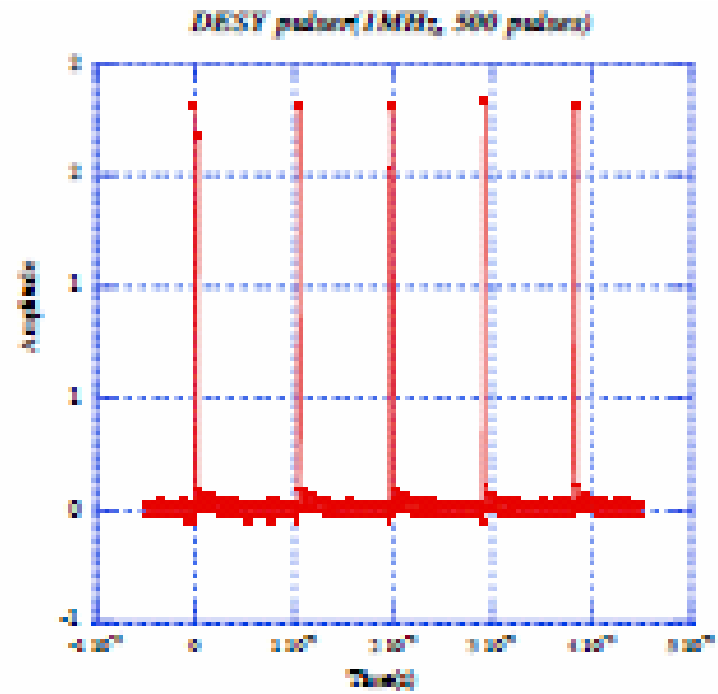
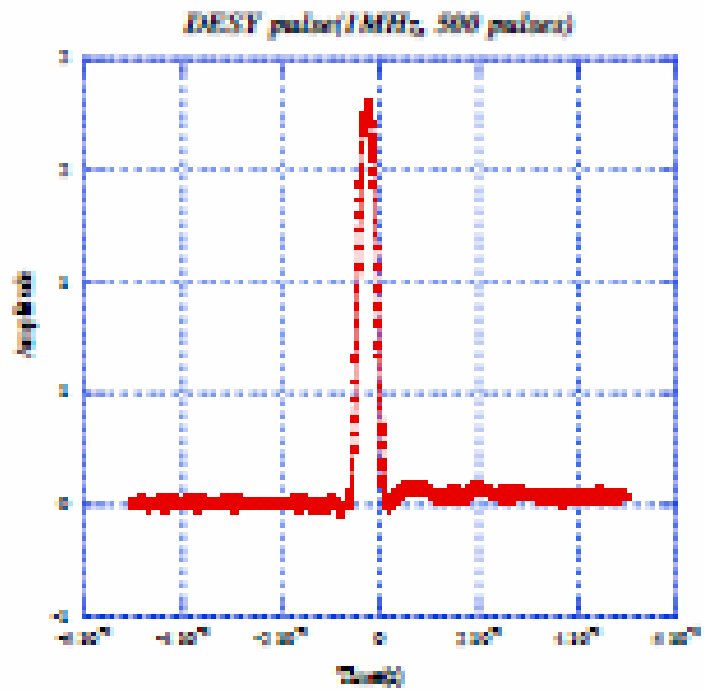

## Behlke HTS-80-UF

The droop of the 500pulses is  $5 \times 10^{-3}$ .

# Measurement result of FPG5-3000M

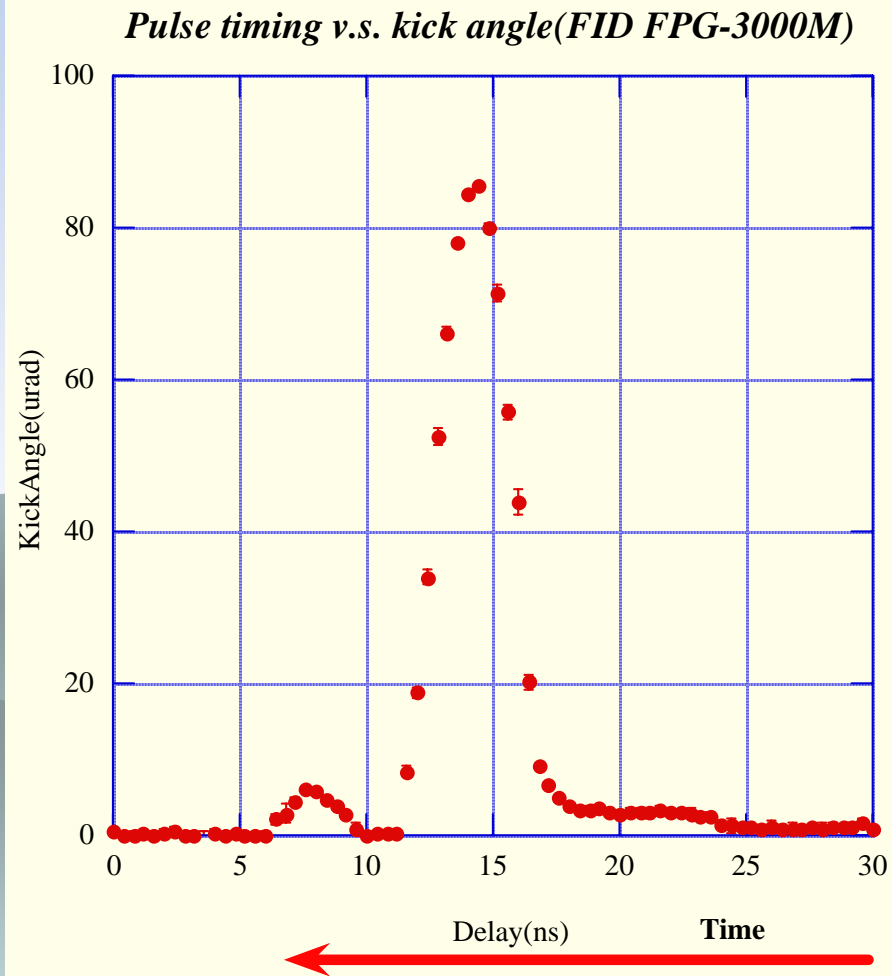

Rise time~3.2ns  
Kick angle ~85 $\mu$ rad  
(calc. 94.7 $\mu$ rad)

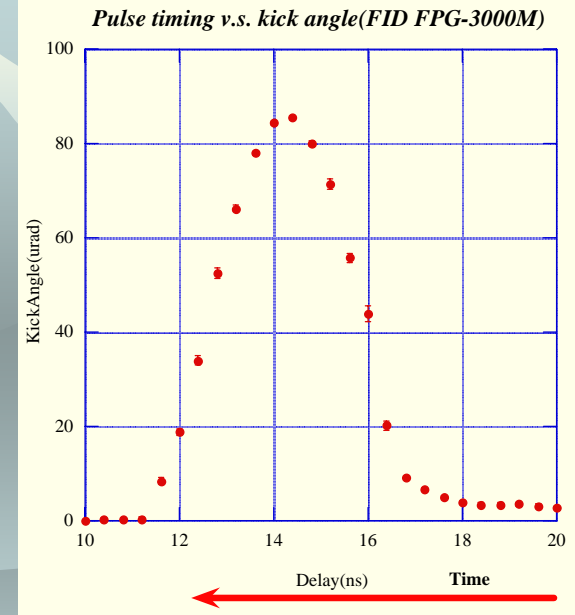

Expanded horizontal scale



# Rise Time improvement by using bipolar pulse

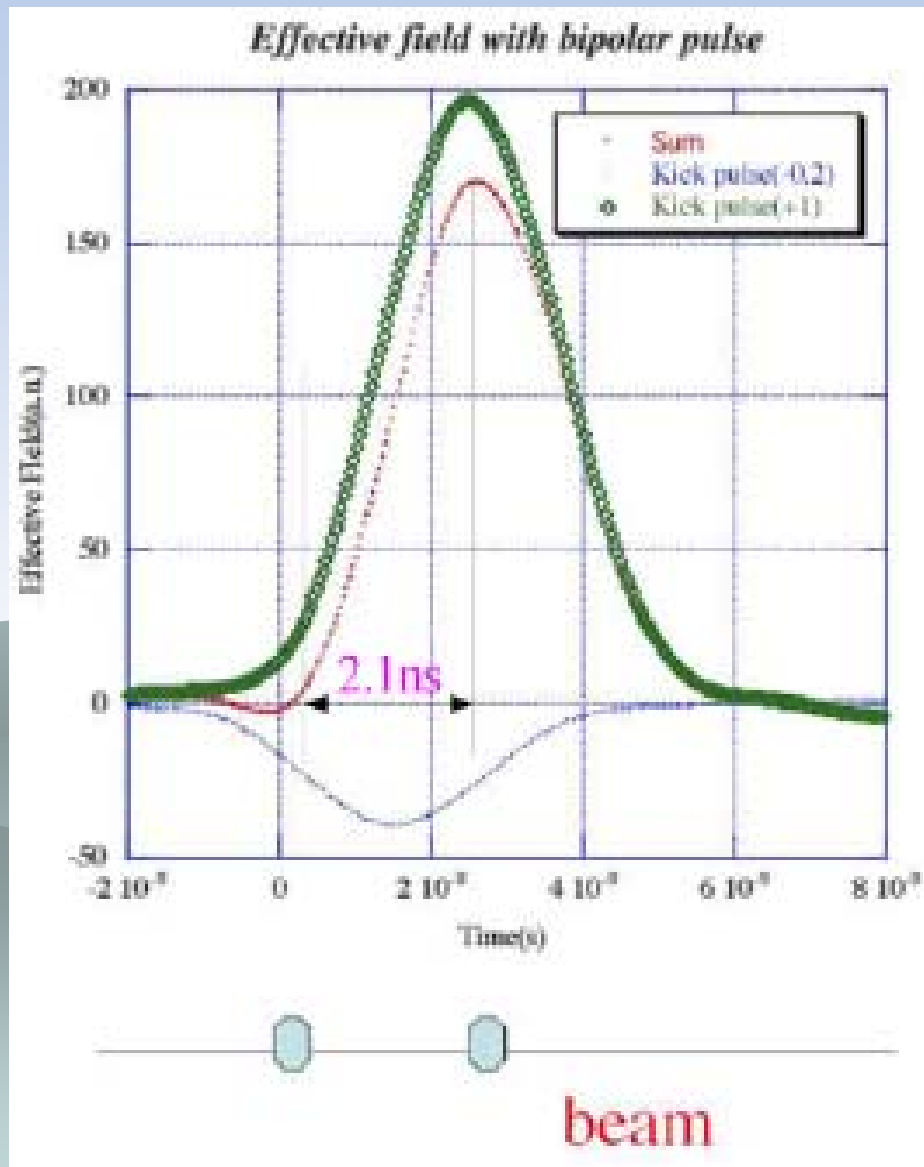

The figure shows the positive pulse(+1), the negative pulse(-0.2) and the sum of the pulses. The rise time of the sum signal is improved for the positive pulse from 3.2ns to 2.1ns. The most significant result of this idea is that the method will be able to make the zero cross field at any timing, for example, the previous beam timing.

# Rise time improvement

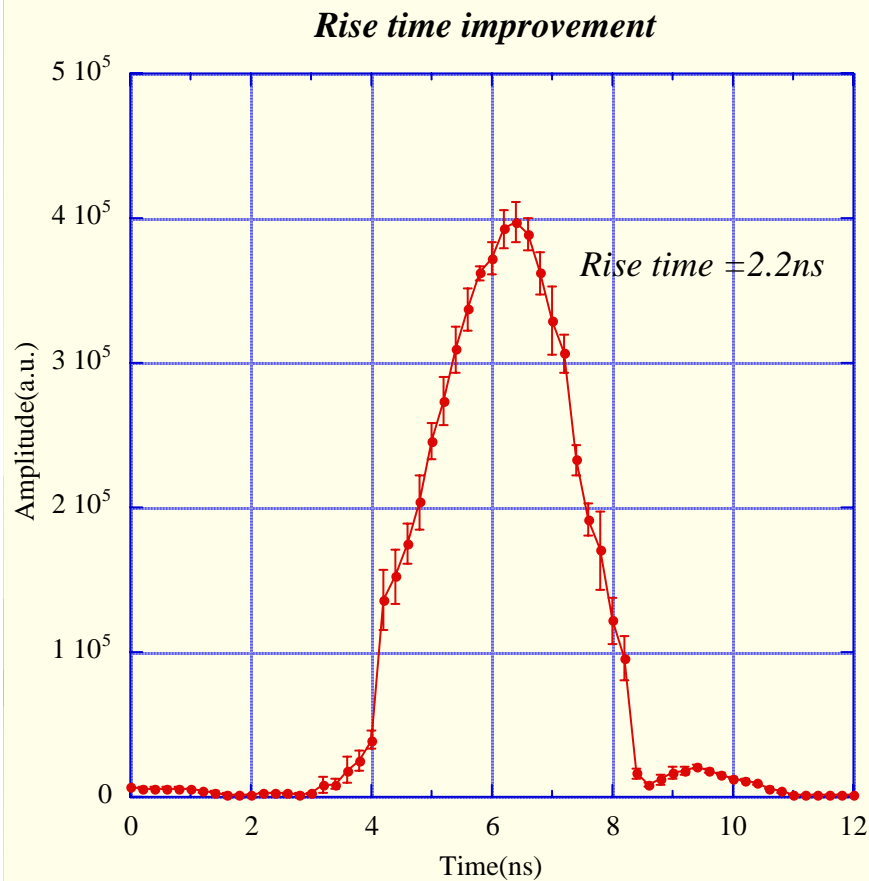

*The rise time improvement was observed by applying the two pulses which has opposite polarity, different amplitude and shifted timing.*

*The graph shows the timing scan result at the combination of the 100% positive pulse and the 8% of negative pulse. The rise time, at the right side slope, improved from 3.2ns to 2.2ns. The small amplitude at right side of the main pulse is the negative kick.*



# Plan of ATF fast beam extraction bunch-by-bunch.

Beam extraction test with strip-line kicker

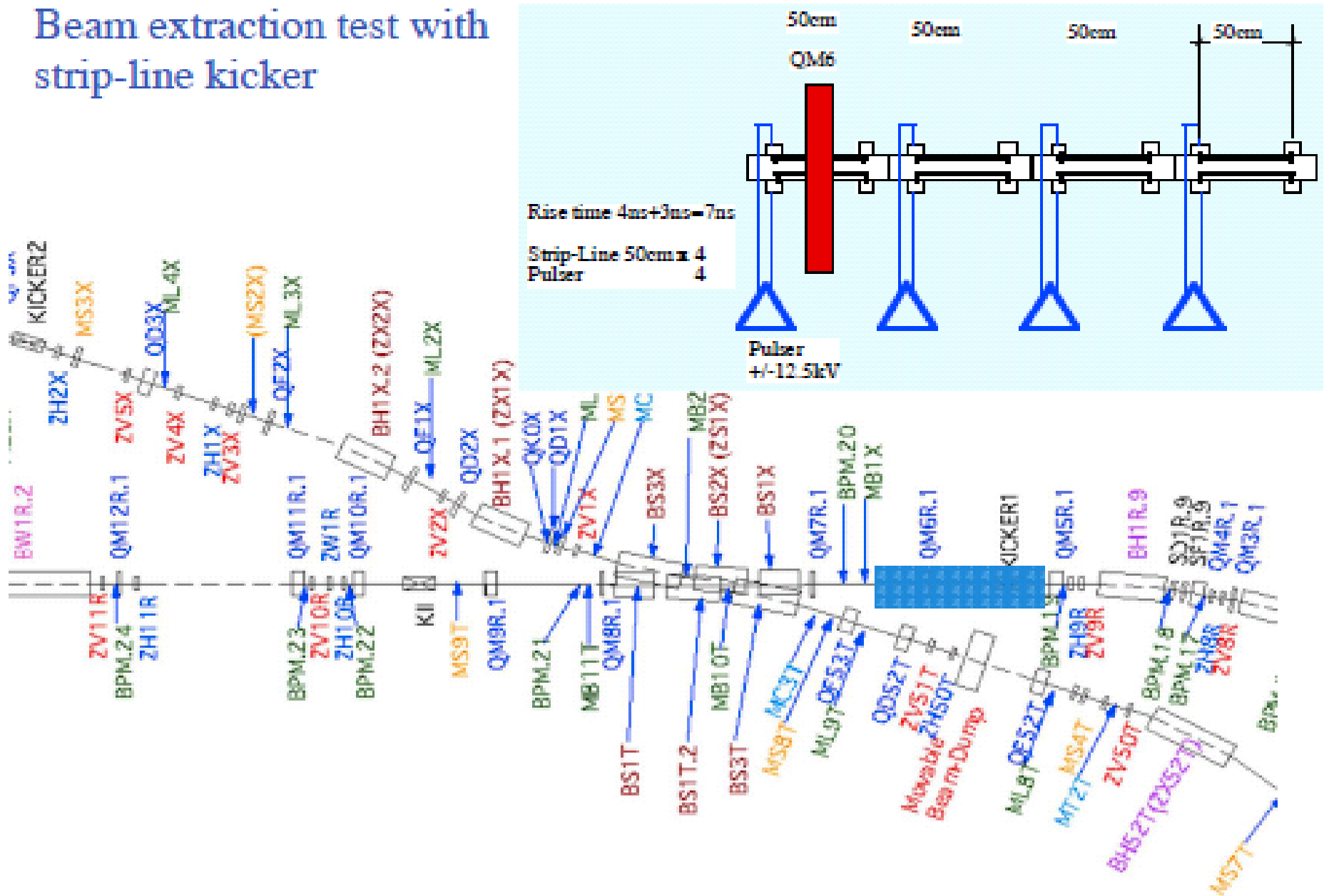

# Other Current ideas

Separate the beam so that it travels along multiple paths.

Demands on kicker are less severe: it only sees every 4th bunch.

The system needs to be studied in detail: how to do it, what happens when it is installed in a damping ring.

Cornell, Frascati and KEK are thinking along these lines.

## FS (Fourier Series) Kicker, RF Kicker

longitudinal RF followed by dispersive section

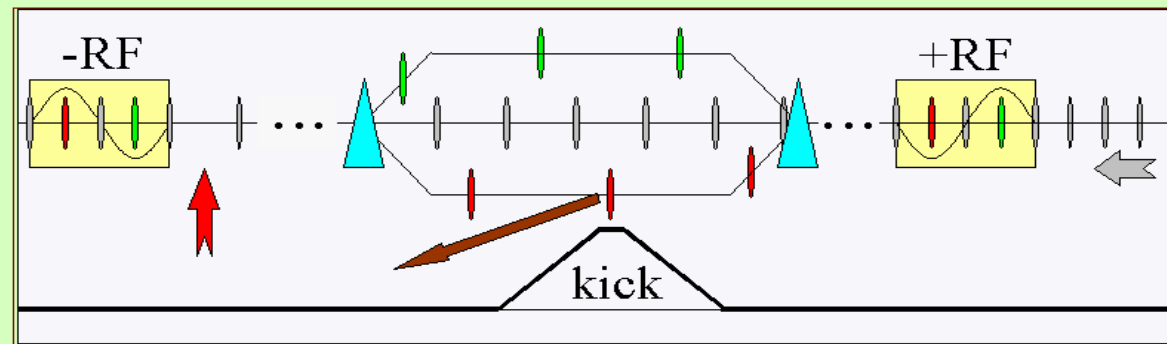

- kicker rise, fall times can be  $4\times$  bunch spacing
- could be combined with #1 to accommodate longer fall-time kicker



# ATF

## Accelerator Test Facility

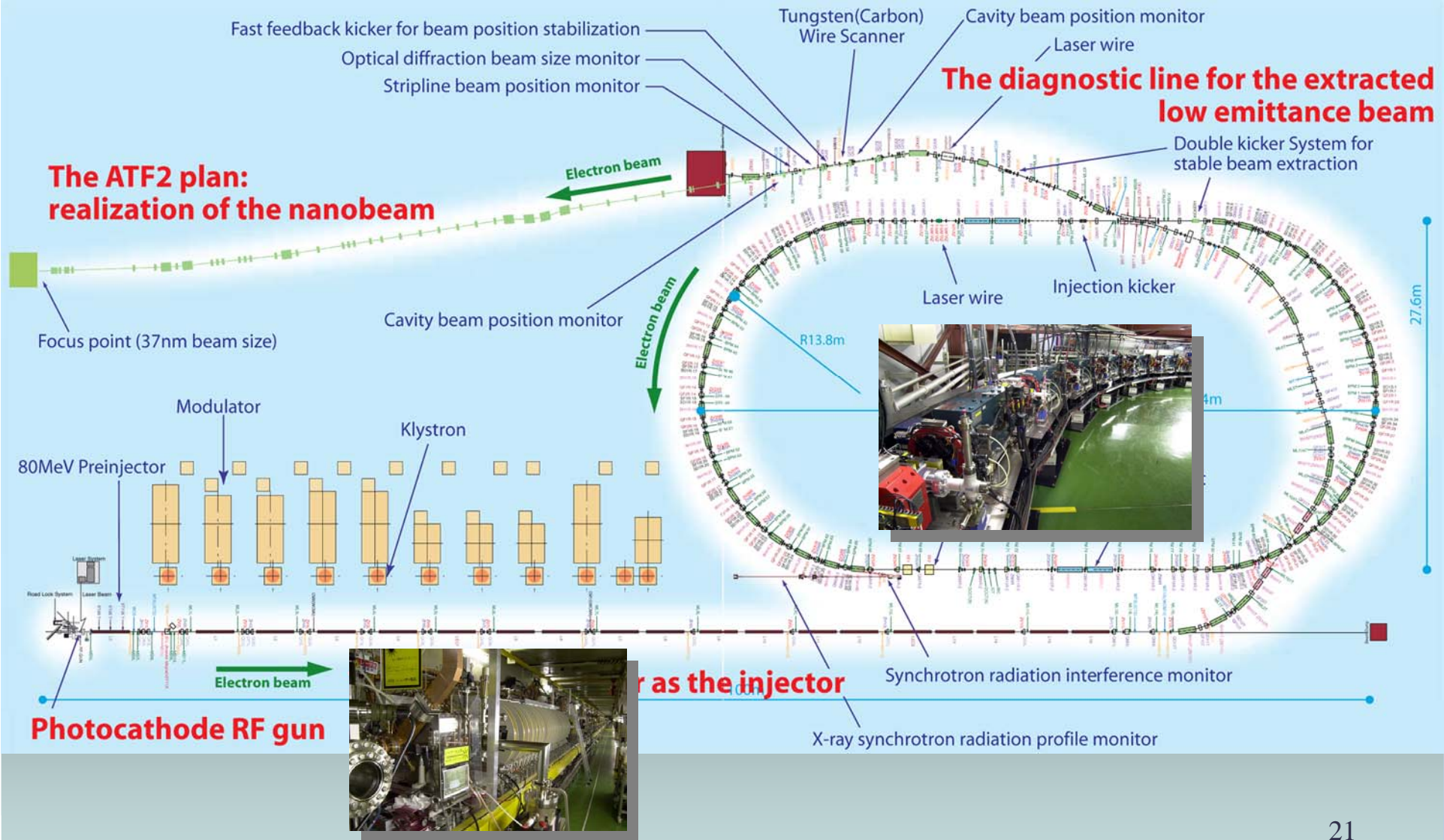

# Mission of ATF/ATF2

- **ATF, to establish the technologies associated with producing the electron beams with the quality required for ILC and provide such beams to ATF2 in a stable and reliable manner.**
- **ATF2, to use the beams extracted from ATF at a test final focus beam-line which is similar to what is envisaged at ILC. The goal is to demonstrate the beam focusing technologies that are consistent with ILC requirements. For this purpose, ATF2 aims to focus the beam down to a few tens of nm (rms) with a beam centroid stability within a few nm for a prolonged period of time.**
- **Both the ATF and ATF2, to serve the mission of providing the young scientists and engineers with training opportunities of participating in R&D programs for advanced accelerator technologies.**



# R&D items in ATF

- 1. kicker study for extraction of ILC-like bunch spacing.**  
*Multi-pole component of kicker and septum is under study.*
- 2. Fast rise/fall strip-line kicker study for ILC Damping Ring.**  
*<3ns rise/fall is under study.*
- 3. High resolution Ring-BPM for more small vertical emittance.**  
*application of digital signal process is under study.*
- 4. Coherent Synchrotron Radiation(CSR) study.**  
*development of CSR detection is underway.*
- 5. Cavity BPMs.**  
*nm resolution BPMs, PAL-BPM at ATF2, IP-BPM at ATF2.*
- 6. Laser Wire beam size monitor.**  
*Fast sweep LW at EXT-line, Shintake-monitor at ATF2.*
- 7. Fast orbit feedback for ILC collision point.**  
*digital feedback method is under development.*
- 8. And many other instrumentation(ODR, XSR, LW@DR)**
- 9. and S-band RF-gun study for stable injection into ATF-DR.**
- 10. Pol. positron generation R&D based on Compton scattering.**
- 11. Fast Ion Instability Measurement**
- 12. Multi-bunch Instability Study**

# ILC like beam extraction at ATF (1)

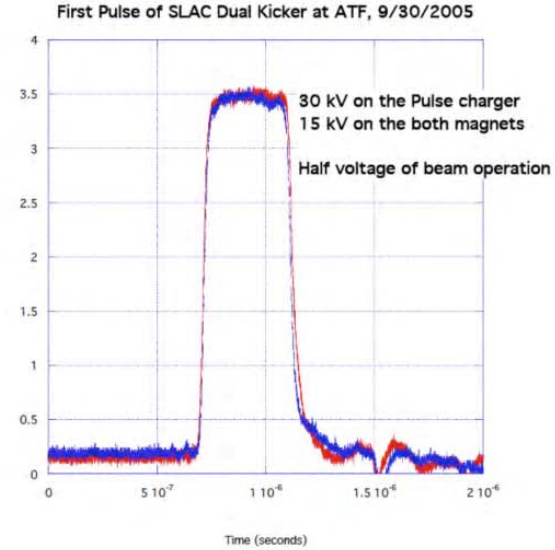
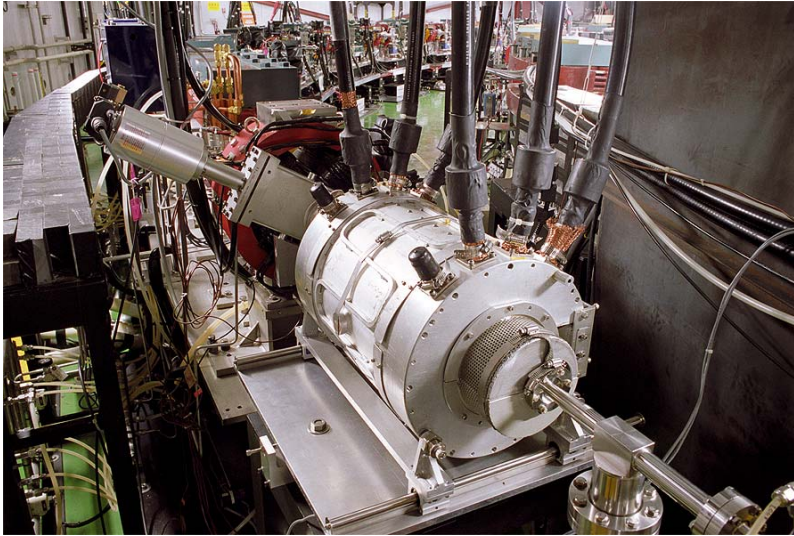

Store 3 bunches in DR by 3 injections  
Injection kicker 60ns(rise/fall/flat-top)

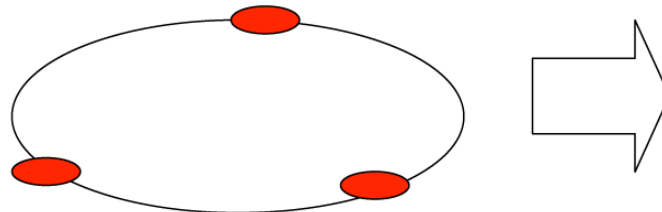

ILC like beam bunches  
for EXT line and ATF2

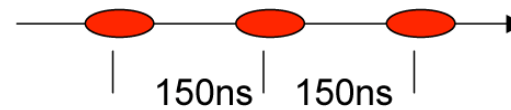



## ILC like beam extraction at ATF (2)

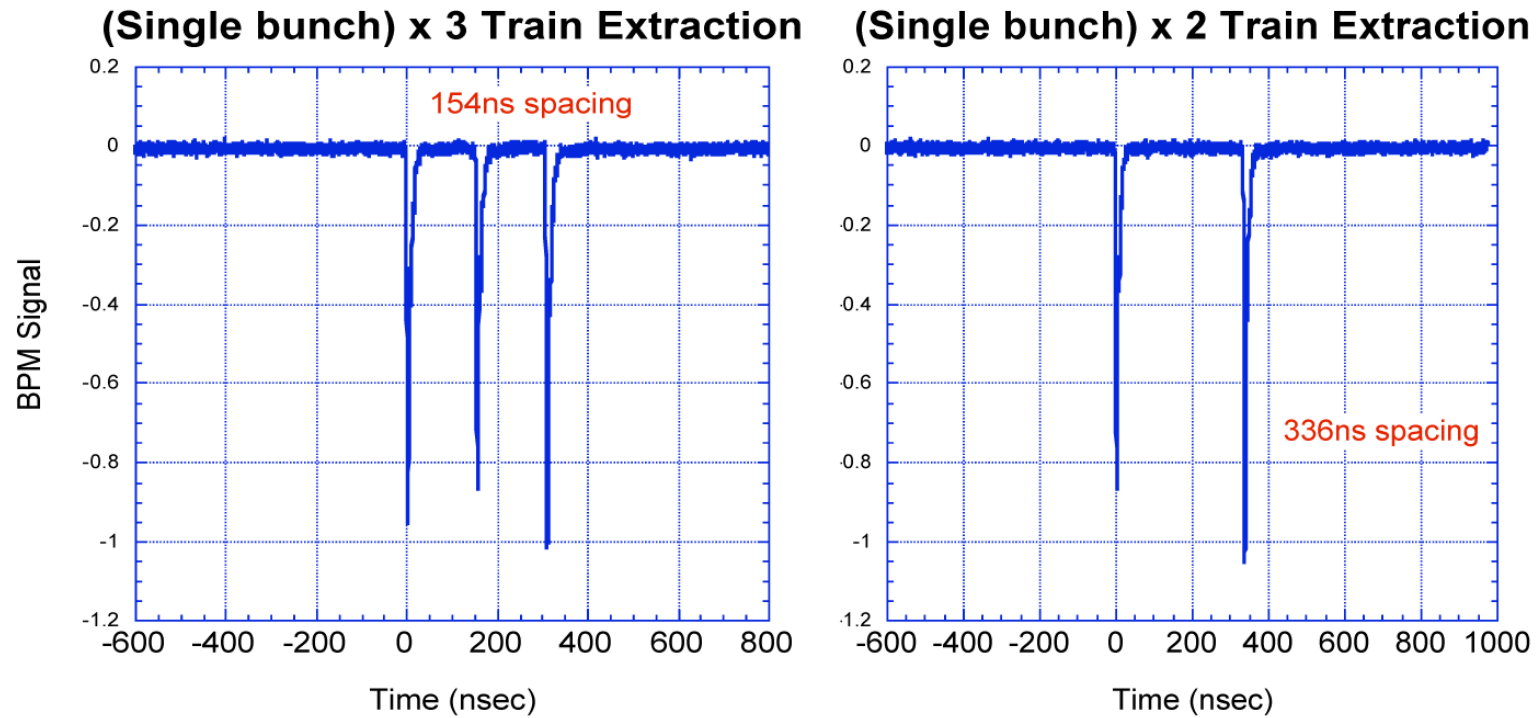

New beam mode at EXT-line and ATF2.

# *ATF Ring BPM R&D*

M. Ross (SLAC)

- Develop ILC ring BPM system towards 1~2 pm emittance as required in BCD with:
  - Adequate resolution
  - Low systematic errors and related drifts
  - Simple, fast(er) calibration
- Replace existing ATF ring system (4 um resolution at nominal current, large systematic errors ~ several hundred microns)
- Ultra-low emittance tuning, stabilization for ATF2 and ILC DR development.

# Cavities at ATF

3 KEK BPMs on flexure piezo movers 3 BINP BPMs in SLAC/LLNL frame

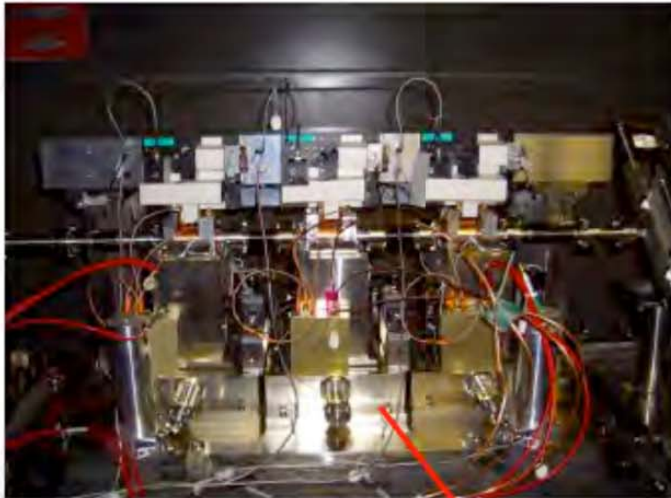

KEK

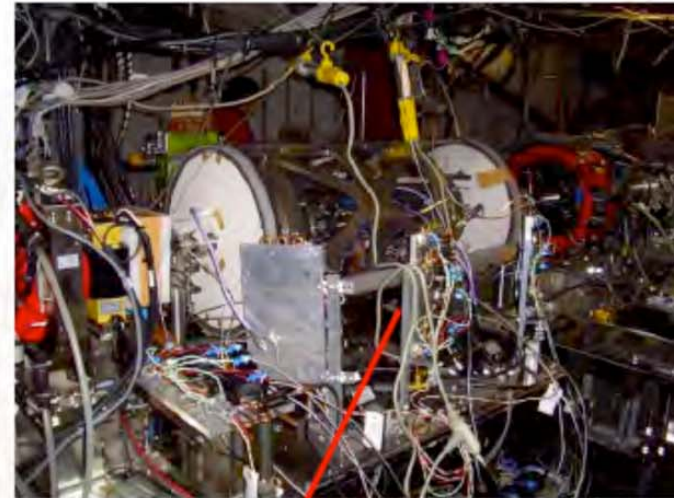

SLAC/LLNL

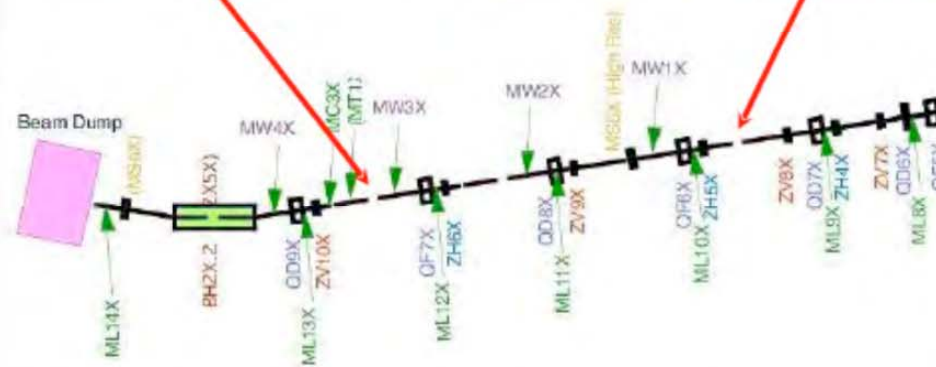

Aiming for world smallest nm-resolution technology

# Calibration

- ◆ Move one BPM at a time with movers
- ◆ Extract BPM phase, scale, offset as well as beam motion by linear regression of BPM reading against mover + all other BPM readings.

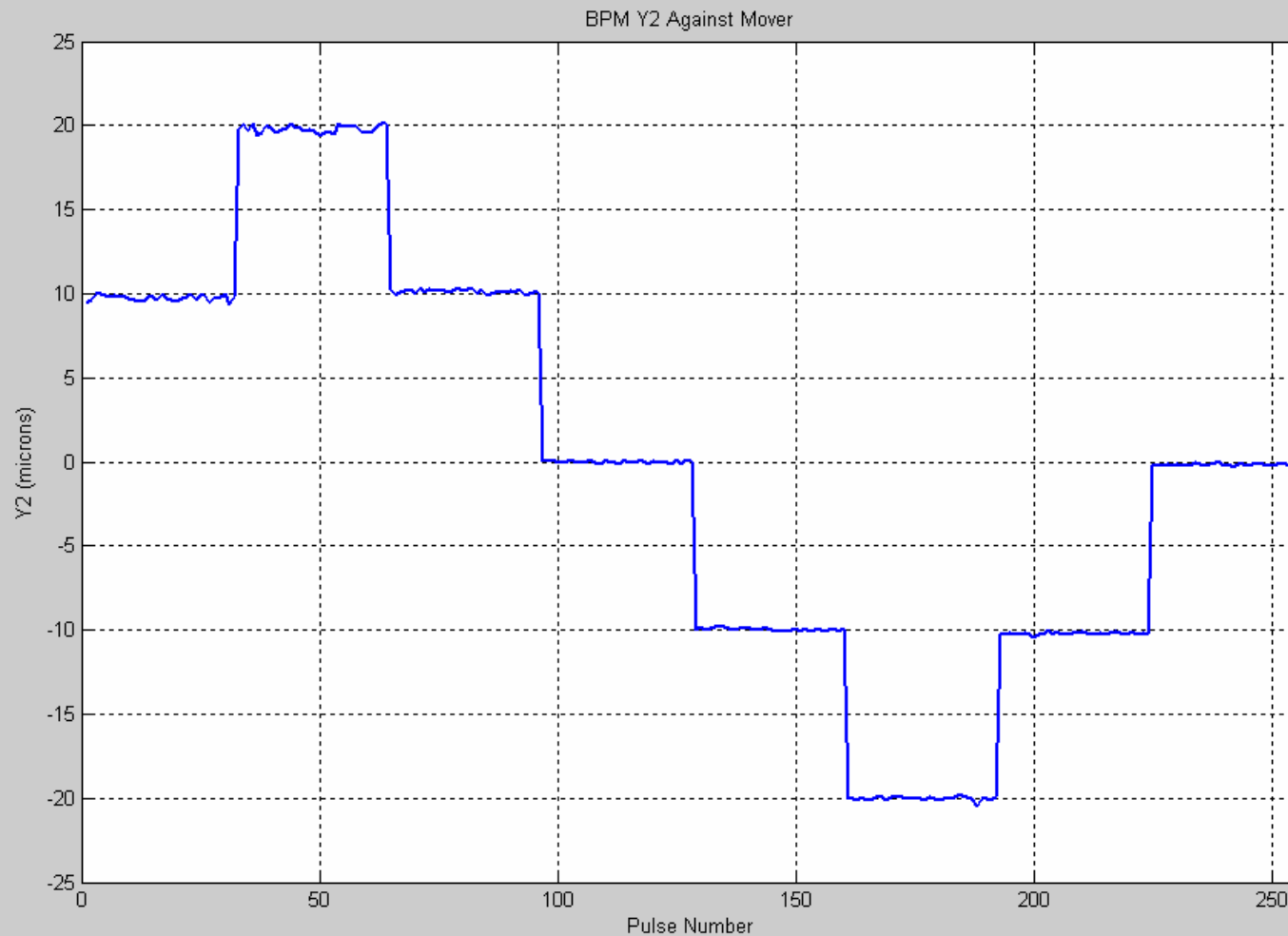

# Cavity BPM

Resolution tests (600 pulses)

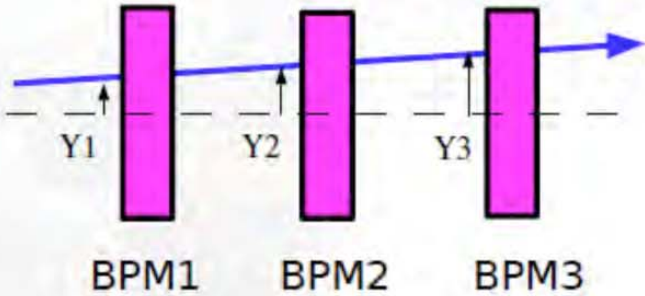

Residual vs. Pulse # (~1min)

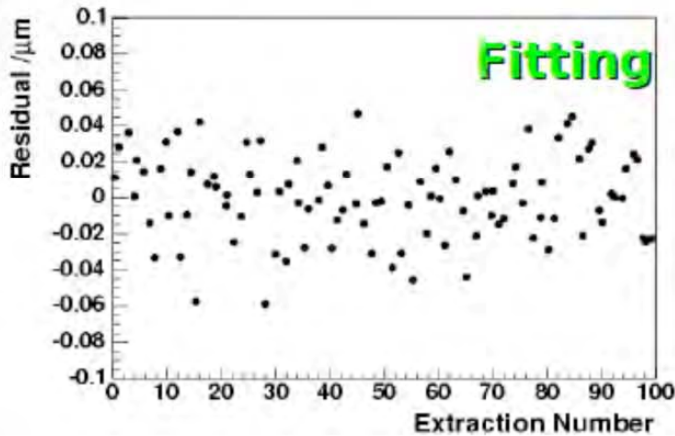

BPM resolution → 17 nm

Long term stability (for 1 hour)

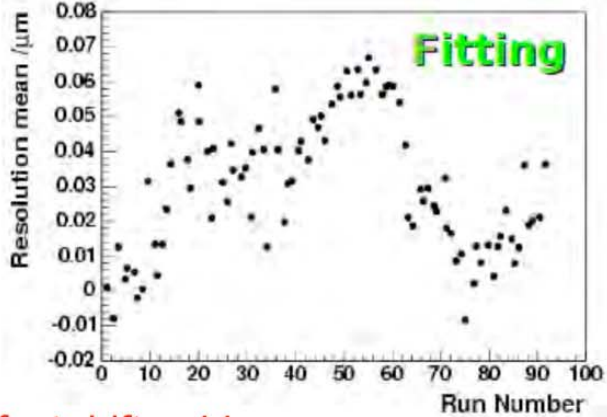

rms offset drift = 44 nm.

Minimize the thermal effects

- New metrology frame was installed in January 2006.
- (Carbon fiber frame+レーザー変位計)

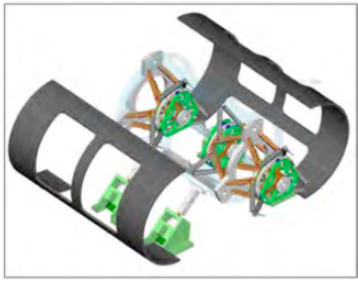
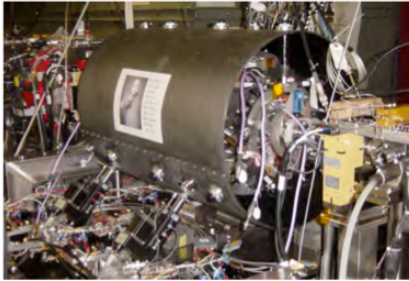



# Q-BPM for ATF2 by PAL

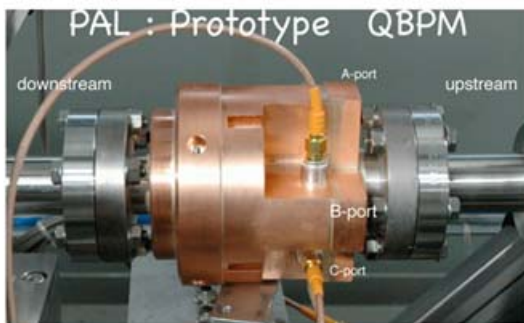

by Y.Honda

installed at  
the extraction  
line, ATF.  
(the dent mode)

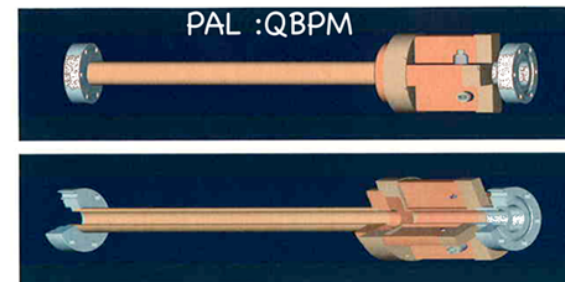

by Y.Honda

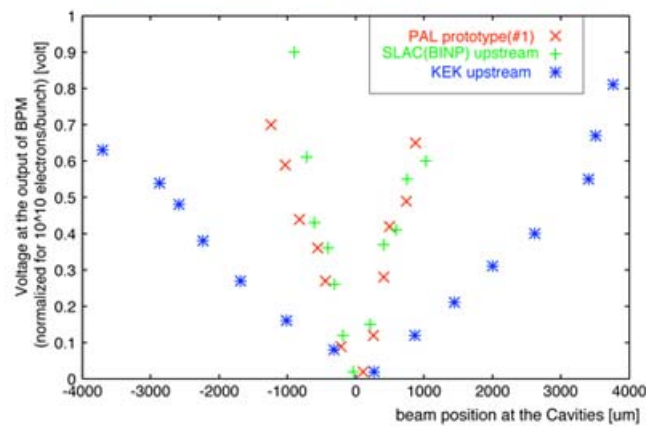

Single port  
measurement

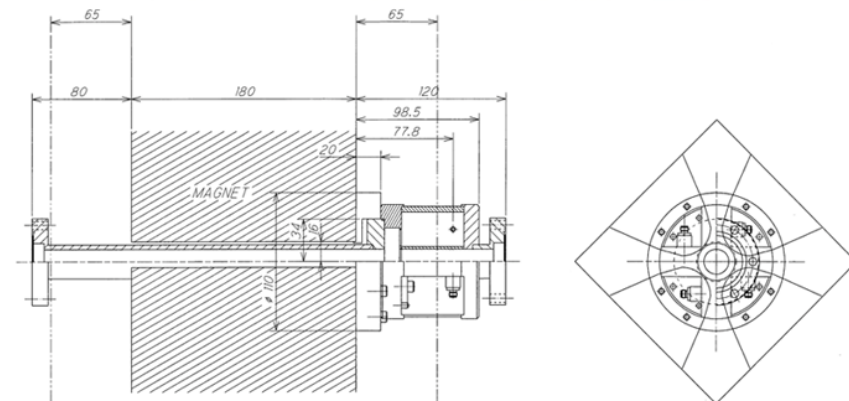

Beam signal test : OK

QBPM with Cu-beam chamber  
Are under fabrication by PAL.

# Design of ATF2 IP-BPM

- Combined the cavity part and the wave guide part (different from Q-BPM case)
- Stack two cavities in a block
  - precision in assembly is 20  $\mu\text{m}$
  - there is a straight line to connect centers of the two cavities
    - angle of the straight line 200  $\mu\text{rad}$ , 2 nm contamination (static)
  - If 3 cavities were stacked,
    - no straight line to agree all three's center
    - calibration will be difficult with an unstable beam
  - cross talk between the cavities: to be tested in cold model

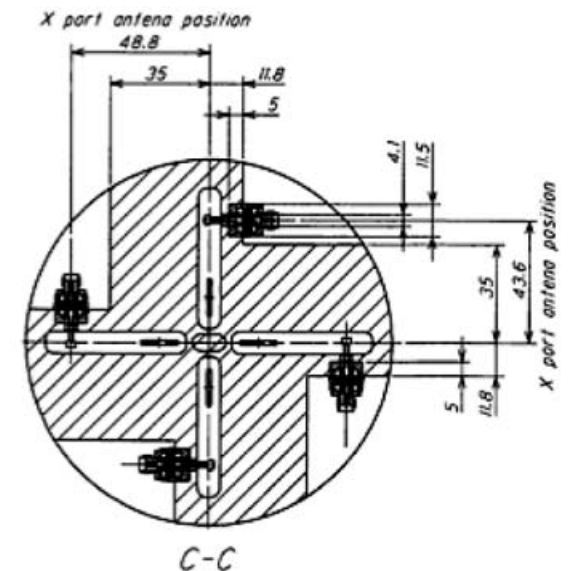
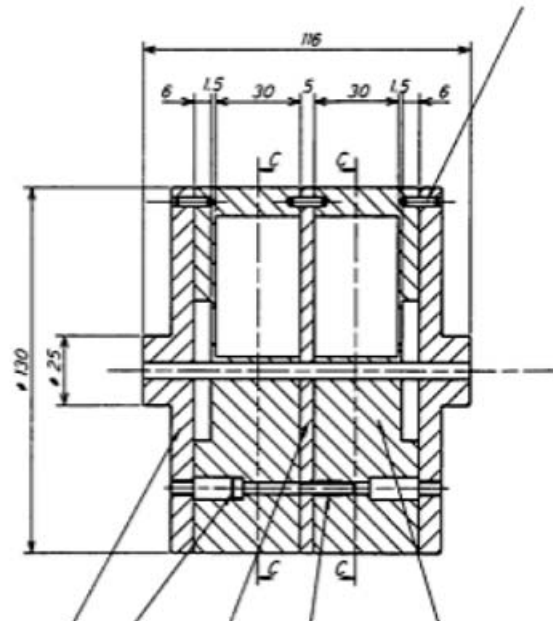
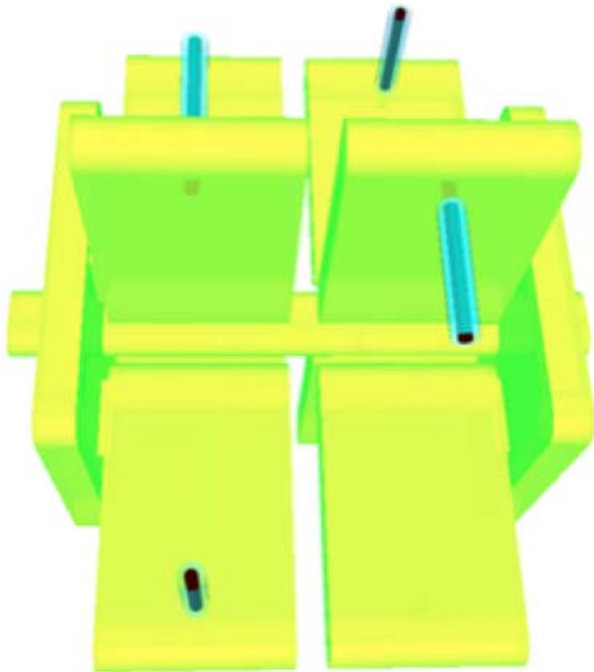
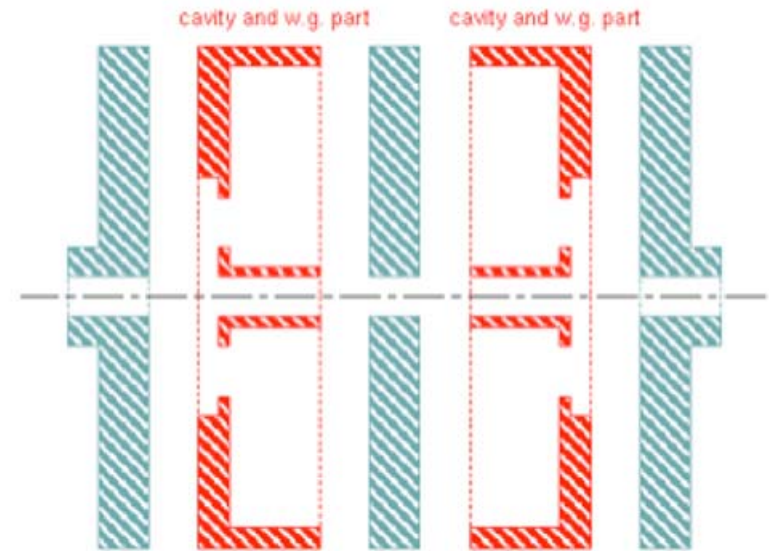

# Pulsed Laser Wire at EXT

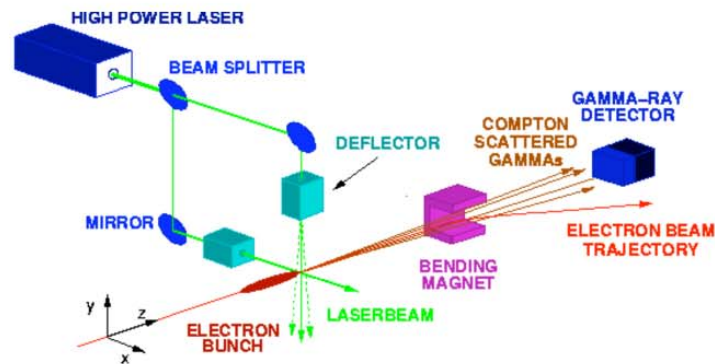

- *University of Oxford*
- *Royal Holloway University London*
- *University College London*
- *SLAC*
- *KEK*

Installation was done in 2005.  
Collision experiment in March 2006.

Will be used as ATF2 beam size monitor.

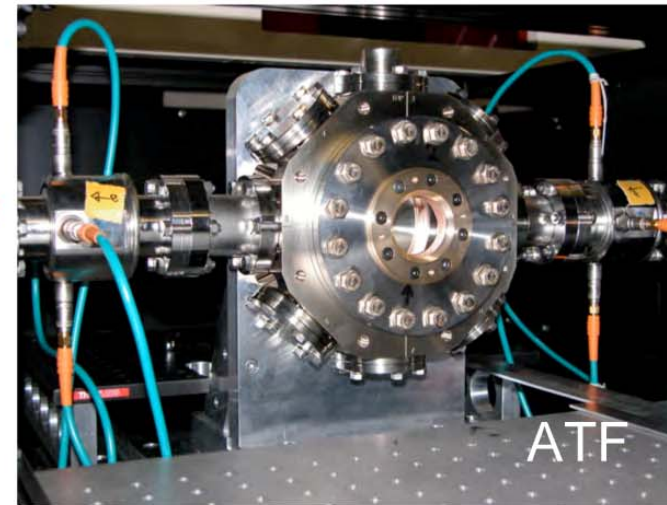

- Measure the electron beam profile with  $\sim 1 \mu\text{m}$  laser (waist).

G. Blair



# Intra-train Beam Feedback at ATF-EXT

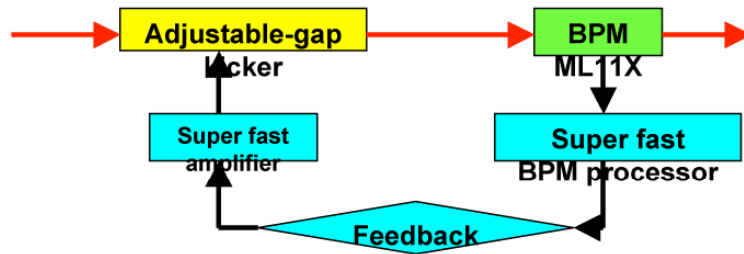

**FONT3: Averaged results**  
(HIGH gain, nominal delay settings)

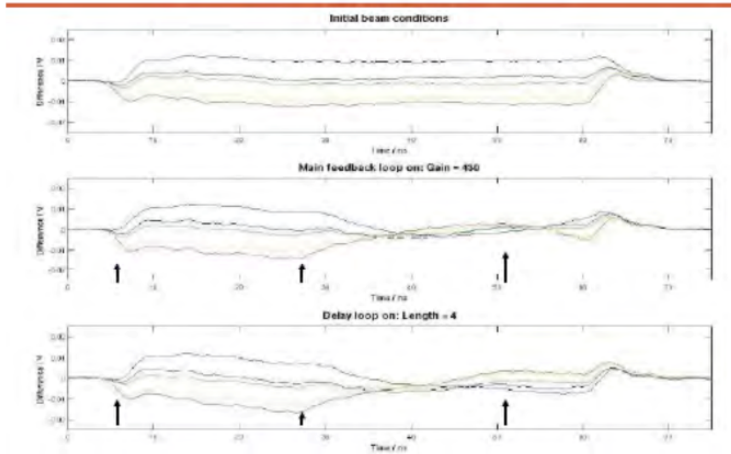

Vital component of ATF2 beam stabilisation systems

P.Burrows<sub>22</sub>

## FONT (Feedback On Nanosecond Timescales)

- Queen Mary Univ.
- Daresbury Lab.
- Oxford Univ.
- SLAC
- KEK

FONT1/2 (2002-2004) ... FFTB  
latency 54 ns

**FONT3 (2004-2005) ... ATF**  
**latency 23 ns**

FONT4 (2005-2006) ... ATF

- Digital FB system
- Latency 100 ns

# FONT plans for ATF/ATF2

- **1. FONT4 prototype ILC digital FB system**
  - **Dec 05:** modified analogue BPM processor tests
  - **Mar 06:** test of digital FB board
  - **Jun 06:** closed-loop FB system test with 3-bunch train
- **2. Ring -> extraction-line feed-forward**
  - **Dec 05:** jitter correlations + transfer matrix studies
  - **2006:** design + tests of feed-forward system
- **3. FONT5 prototype ILC digital FB system**
  - **2007:** algorithm development + tests w. 20-bunch train

# Feedforward to Extraction Line

FONT project (UK Institutes)

**Planned**

## Layout of KEK-ATF Extraction Line

*nm Fast Feedback*



**$\mu\text{m}$  Feedforward ( DR BPM -> EXT Line  
new strip line kicker)**

# ATF2

## Layout

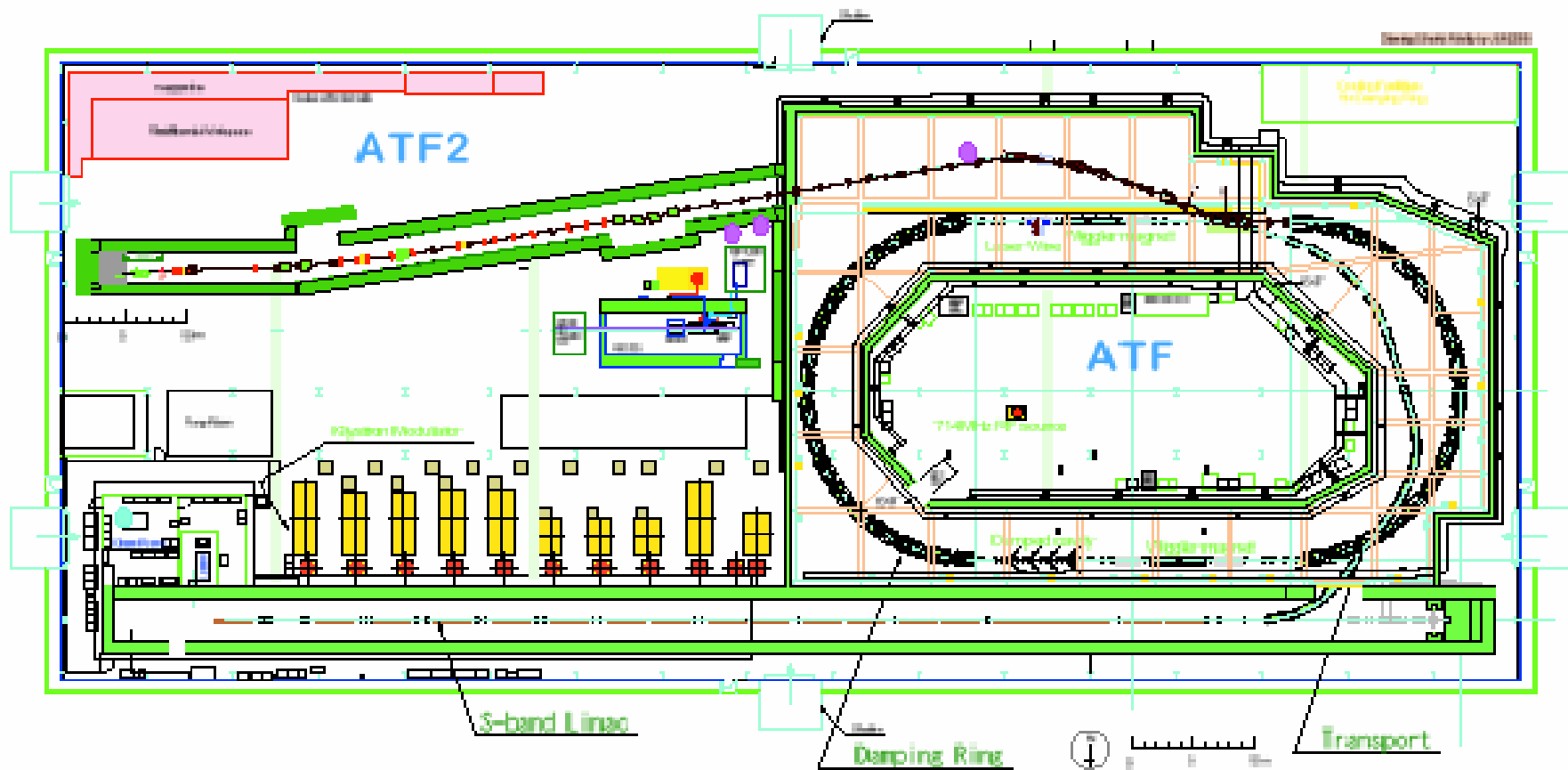

- So-called optimal layout: Total length of FFS  $\approx 36\text{m}$
- Plus diagnostics section and beam-dump

# ATF2

## Goals of ATF2

(**A**) Achievement of beam size  $\sim 37\text{nm}$

(**A1**) Demonstration of a compact final focus system based on local chromaticity correction scheme

(**A2**) Maintenance of the small beam size

(**B**) Control of beam position

(**B1**) Demonstration of beam orbit stabilization with nano-meter precision at IP.

(**B2**) Establishment of beam jitter controlling technique at nano-meter level with ILC-like beam

# Prospect of ATF and ATF2

- ◆ ATF International R&D will generate necessary results for ILC, especially how to control high quality beam, develop many kinds of advanced instrumentation, educate young accelerator physicists and engineers.
- ◆ ILC like beam which means 20 bunches with bunch spacing about 300nsec.
- ◆ Realization of about 35nm beam for long period.