

(No) Systematic studies on SKIROC2

Benoit Mahault - 2 months internship
(Thibault Frisson)

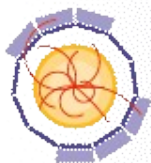

AIDA

Advanced European Infrastructures
for Detectors at Accelerators

AGENCE NATIONALE DE LA RECHERCHE
ANR

SKIROC2 Analog Core

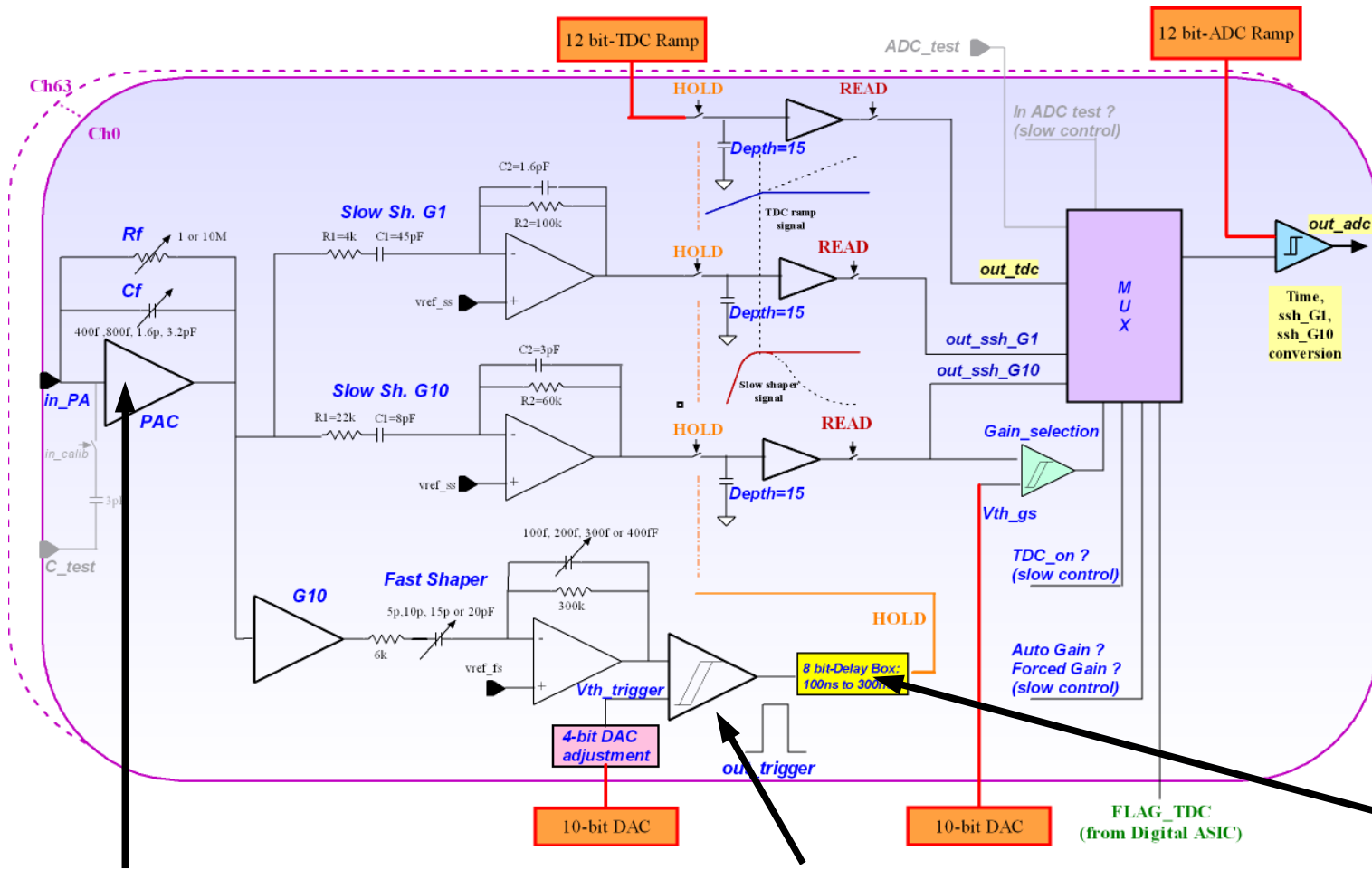

Preamplifier
(adjustable gain)

Internal trigger
(self-triggering capability)

Trigger delay

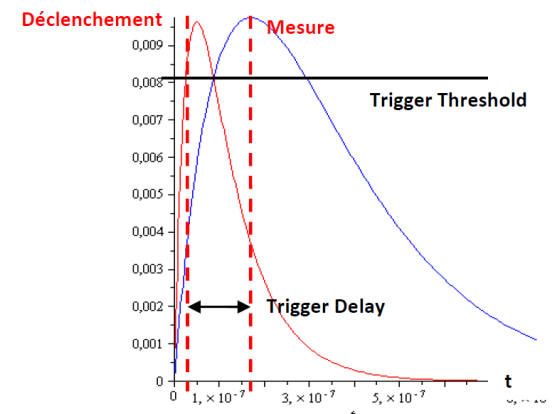

Setup

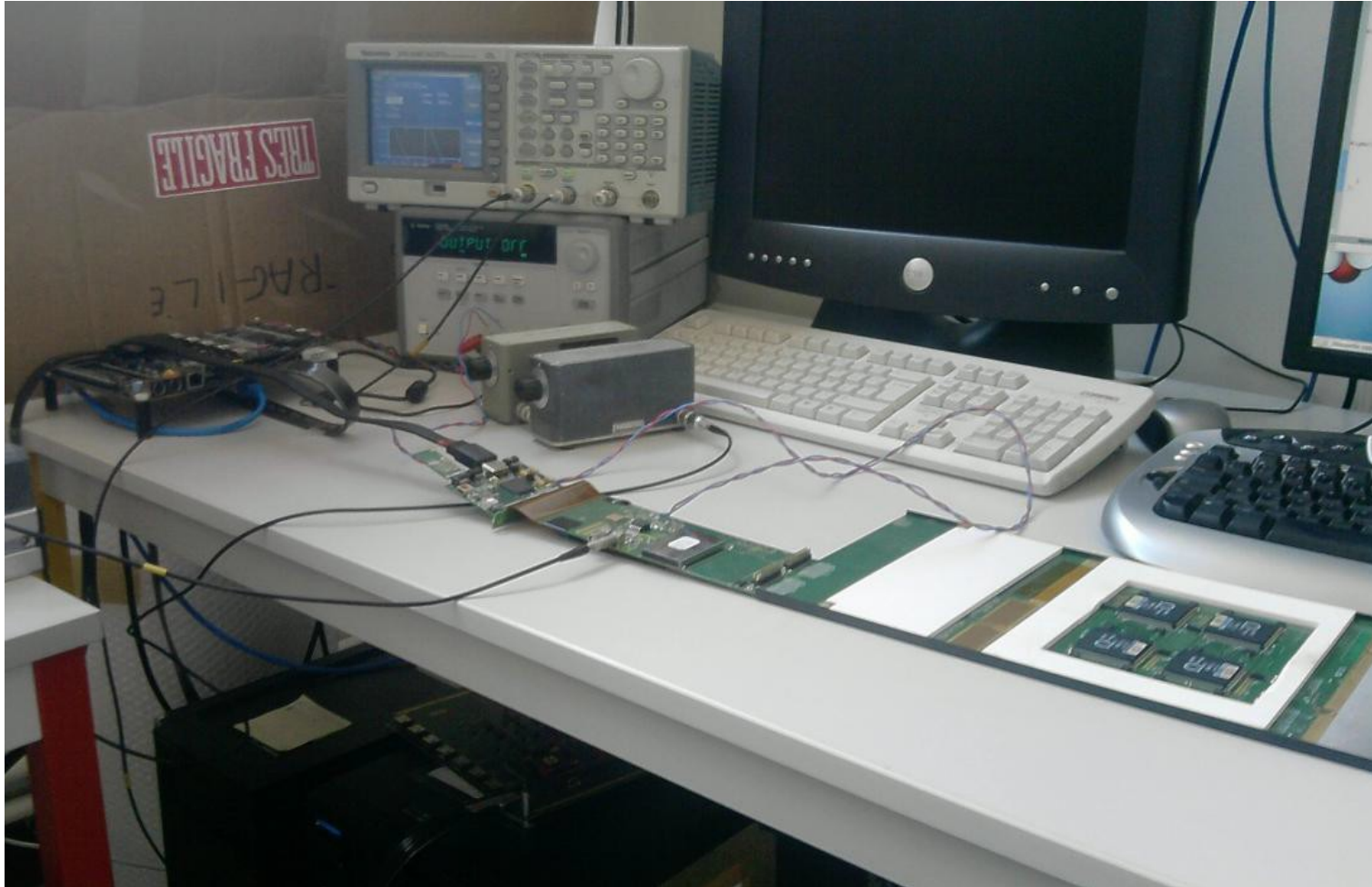

- LDA often crashes when Slow Control is reloaded → need arduino module to automatically reset LDA
 - We don't have this module ==> Manual reset of the LDA
 - Tedious work to explore parameter space
 - No systematic studies
- Old DAQ soft

Trigger threshold calibration: S-Curves

Whatever the method used (full S-Curves, automatic procedure...), the idea is the same.

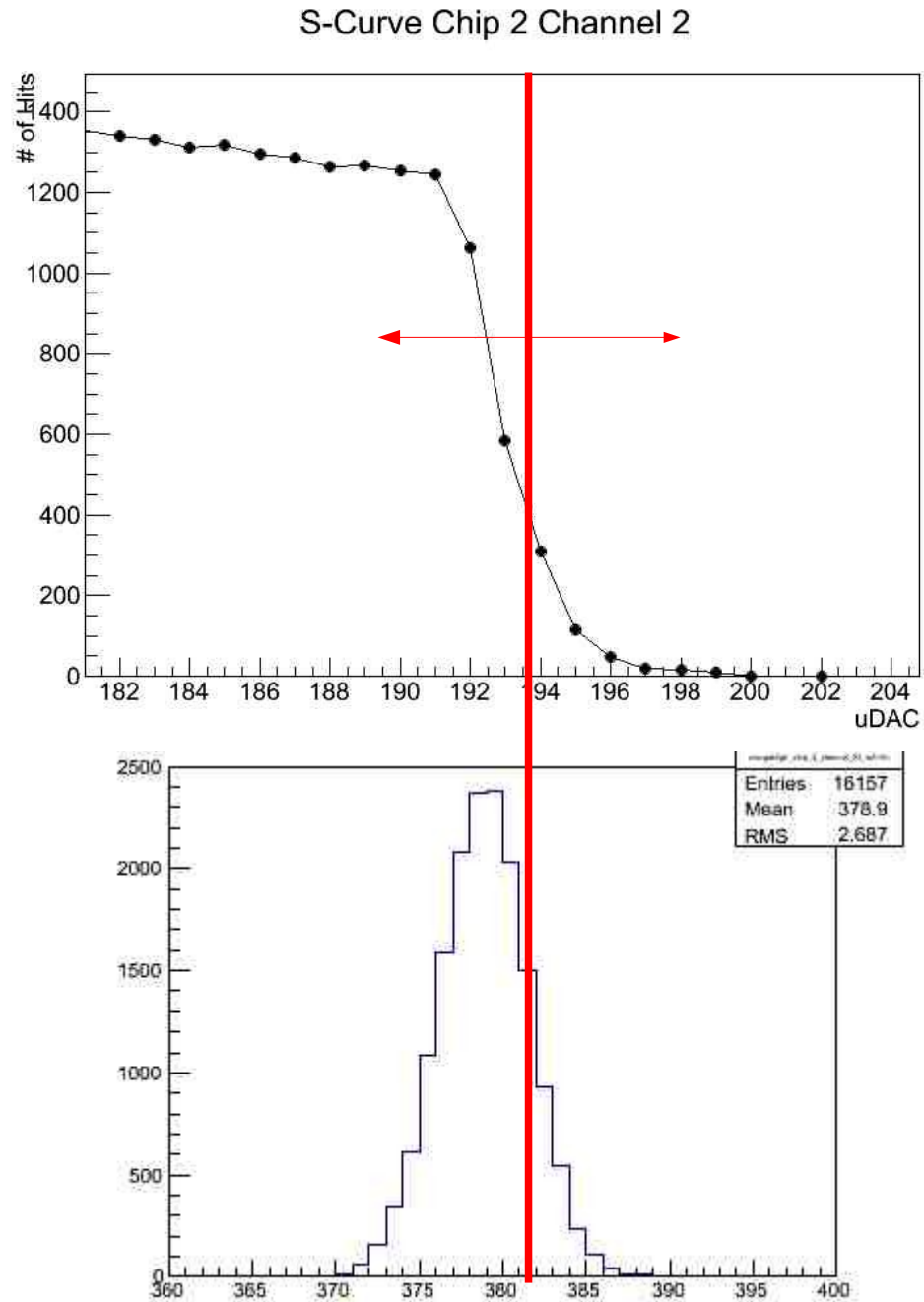

Calibration of all channels at the same time

Motivation → Time (64 times faster)

S-Curve Chip 2 Channel 2

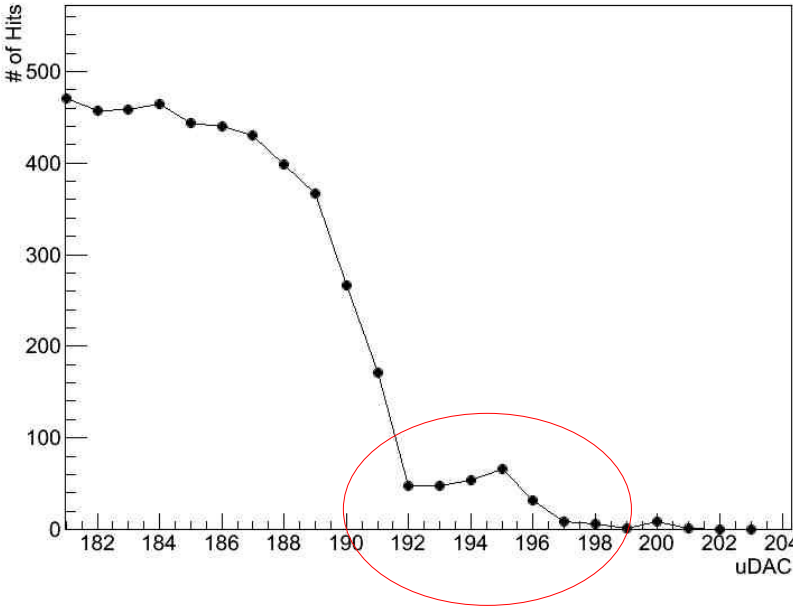

S-Curve Chip 2 Channel 35

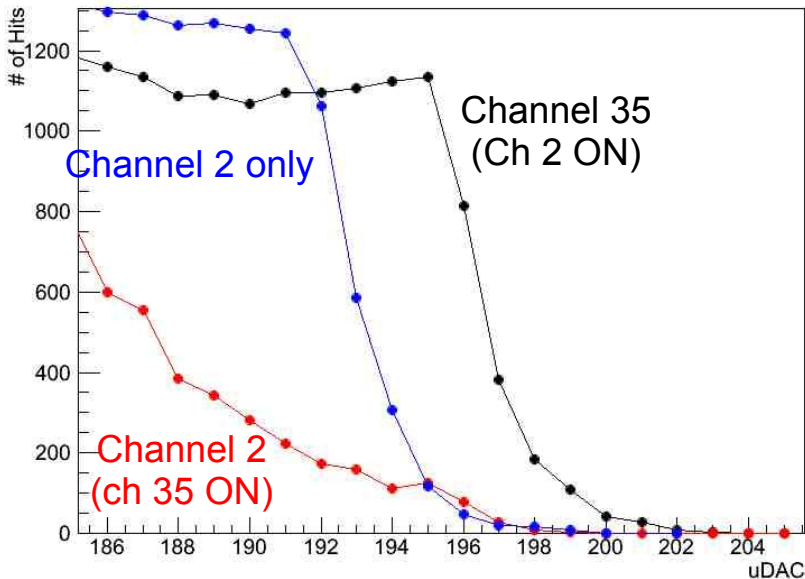
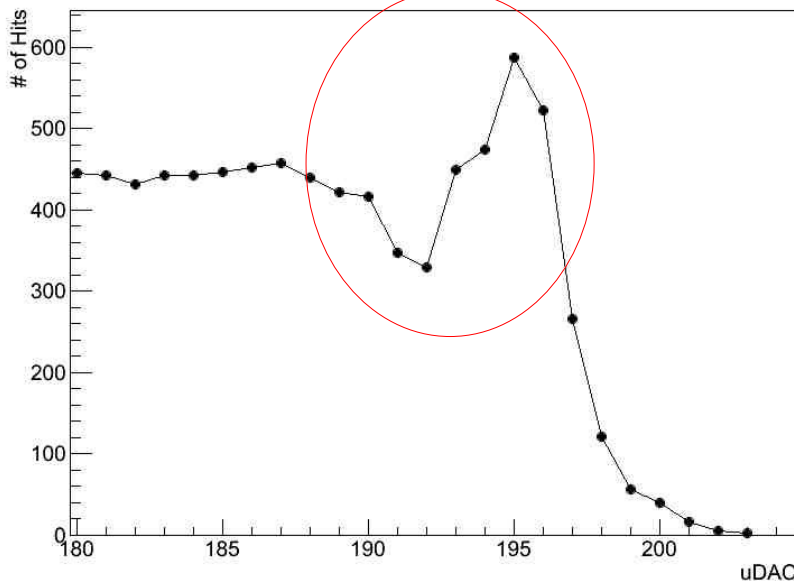

Channel by channel calibration mandatory?

Trigger threshold calibration 2

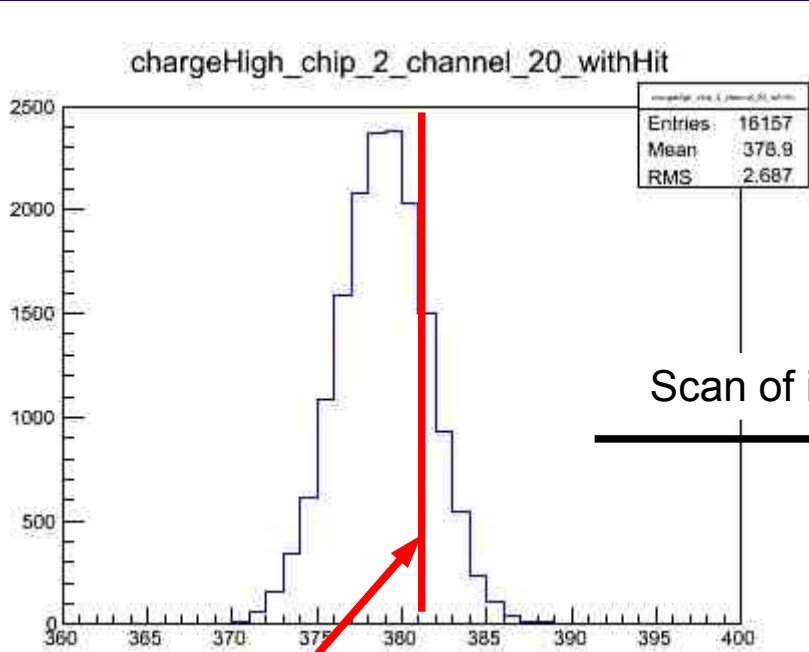

Fixed threshold

Conversion ADC-DAC

Scan of injected signal

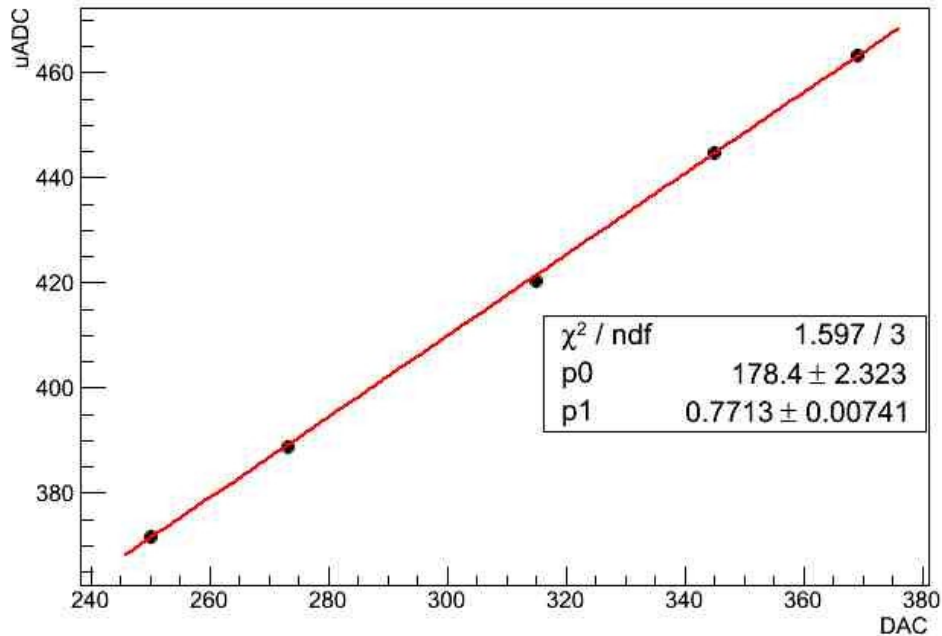
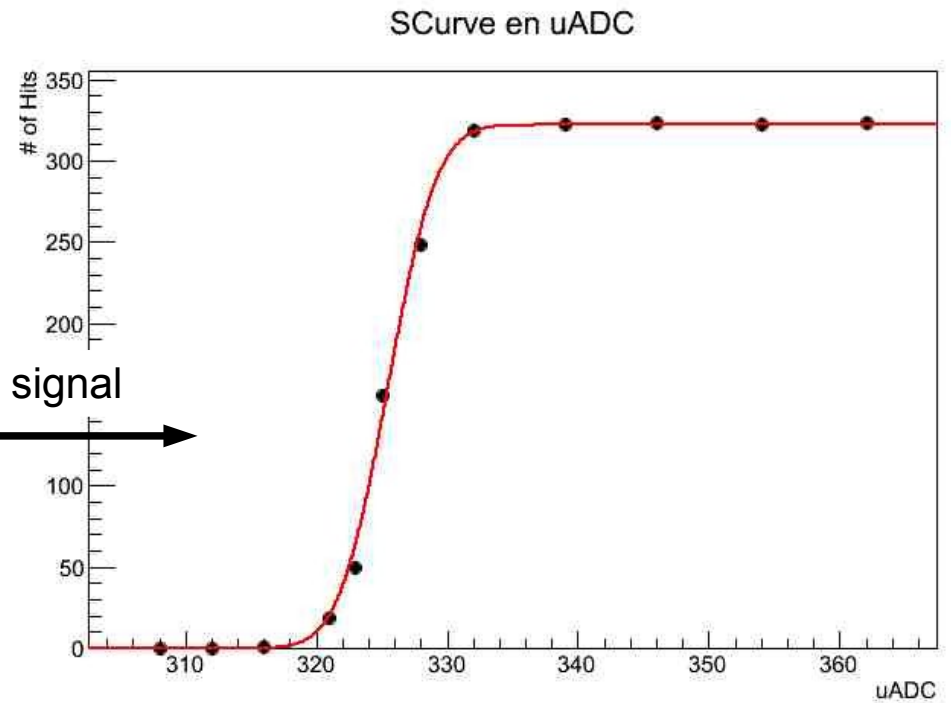

1/ mean value of the distribution <--> DAC
To Compare with standard calibration, we have to take into account the width of the distribution

2/ Same measures with channel 35 give a slope $p1=0,67$

No full DAQ, no systematic studies....

Individual channel adjustments

Measured range of the individual channel adjustment too small

→ Additional resistor to increase the current in the 4-bit DAQ channel adjustment

But...

S-Curve Chip 2 Channel 20

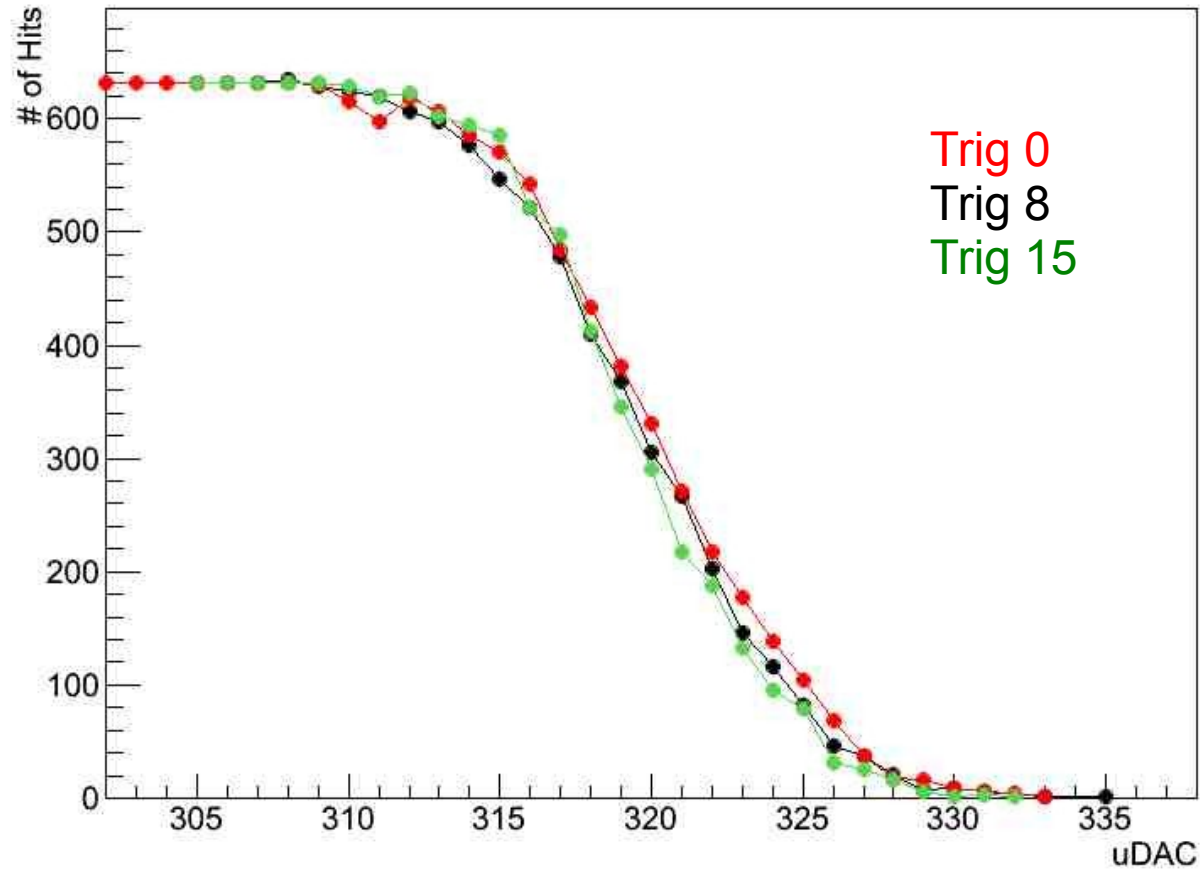

But... no full DAQ, no systematic studies....

Trigger delay calibration

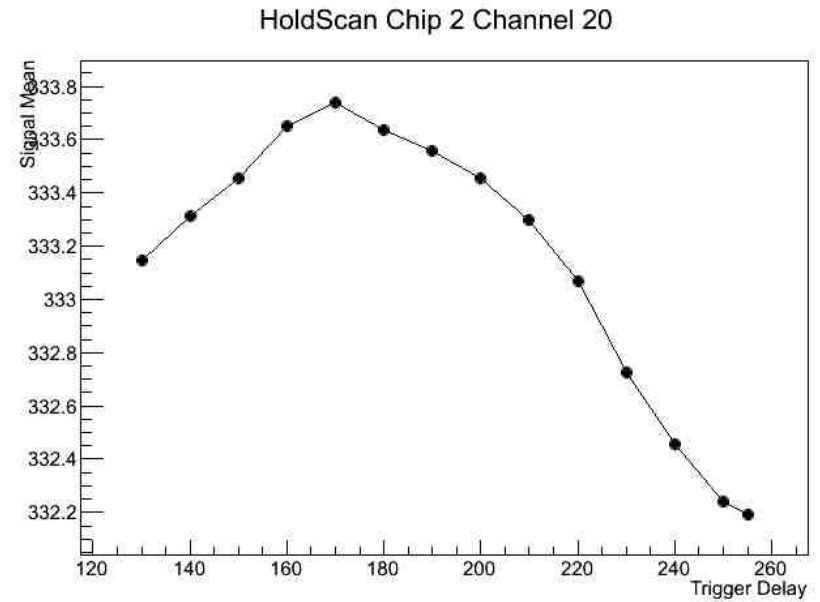
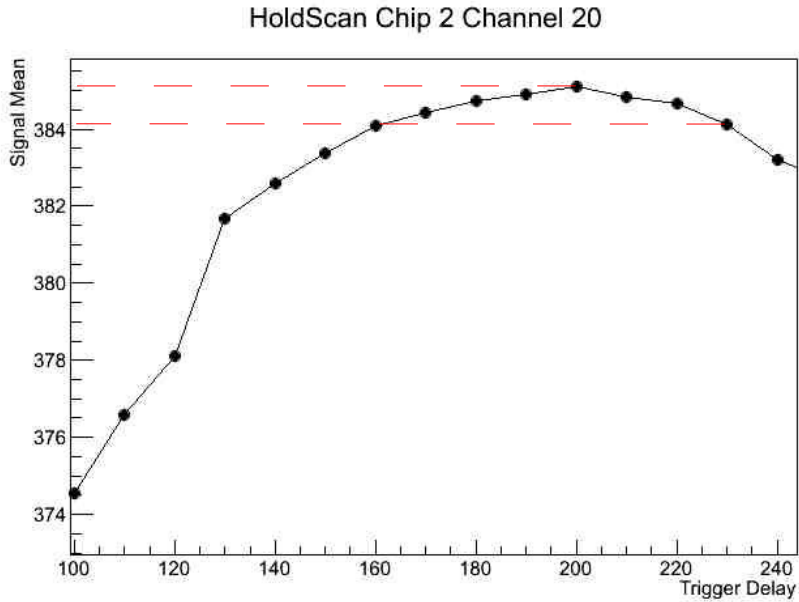

TB 2012:
Delay @ ~130 with MIPs

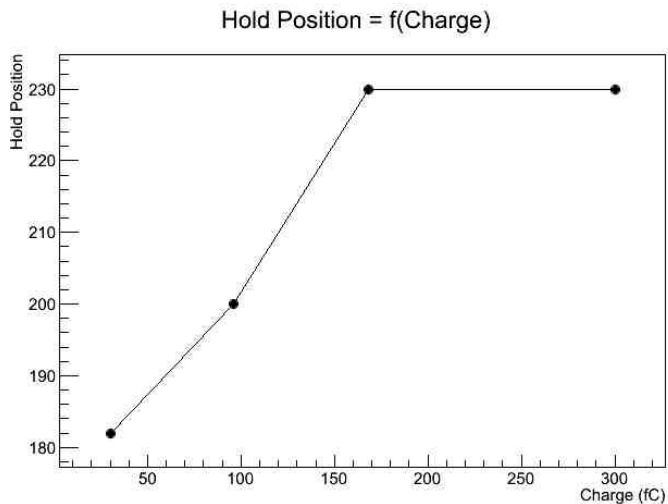

40 fC = 10 MIPs

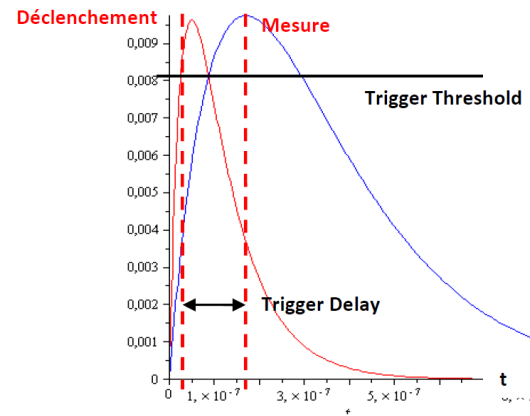

Delay calibration depends on the measured charge...
... but the variation amplitude is small ~1 uADC

Conclusion

Study of SKIROC2 calibration methods...

...but no full DAQ = no systematic studies.

Further work needed to investigate individual channel trigger threshold adjustment

Need systematic study of technological prototype calibrations

→ with control plots (S-Curves...)

Trigger delay calibration - crosscheck

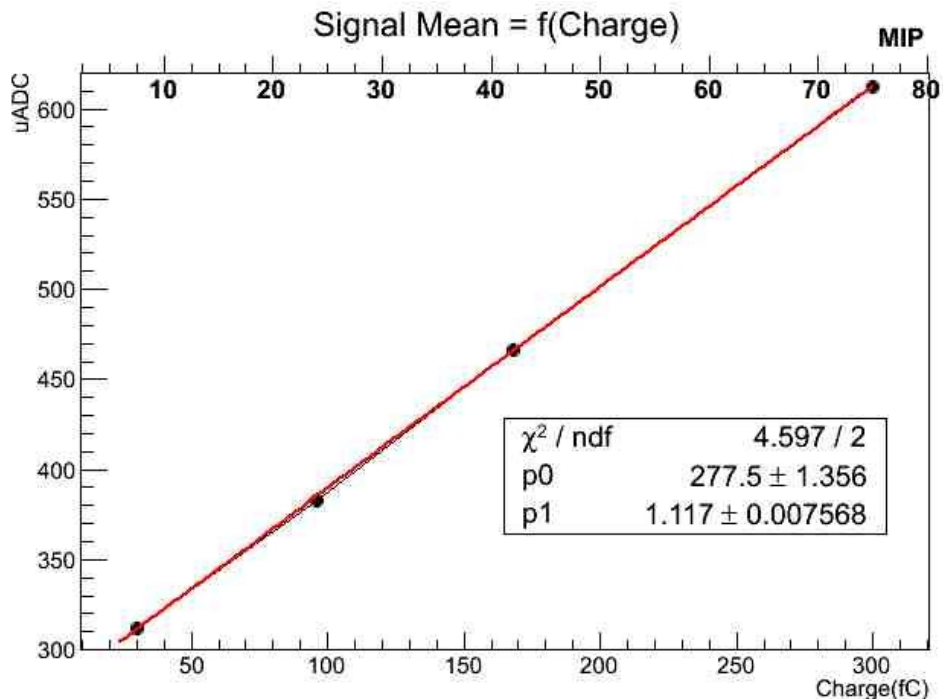

Linear response

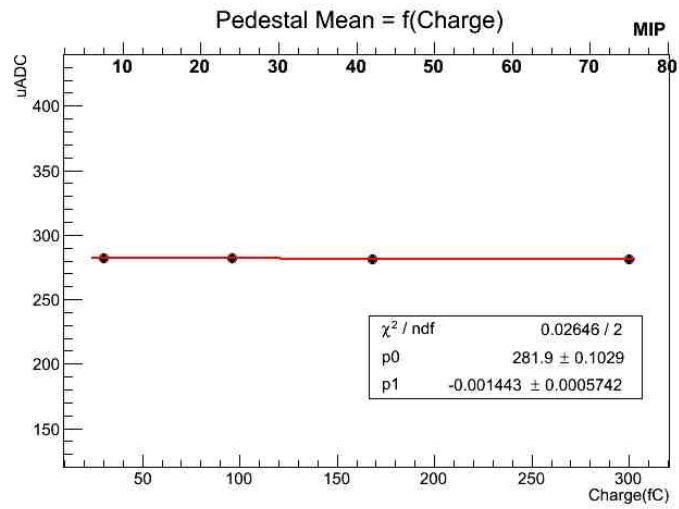

Stable pedestal