

# *FPCCD radiation damage test*

2013 12/17 annual meeting@KEK .

Ito Shuhei(Tohoku Univ.)

D.Abhinav ,C.Constantino, H.Ikeda, A.Ishikawa E.Kato, A.Miyamoto,  
T.Mori, N.Shinoda, H.Sato, T.Suehara, Y.Sugimoto, H.Yamamoto, Y.Yasu,  
S.Yamaguti, I.Ushiki

# contents

1. Purpose of Vertex Detector
2. FPCCD Vertex Detector
3. R&D status
4. Damage from neutron
5. Characteristics of FPCCD
6. Read out modules
7. Characteristics before irradiation
  - Hot pixel
  - CTI
  - Dark current
8. Neutron Irradiation
  - set up
  - flux of neutron
9. Result of irradiation
  - hot pixel
  - CTI
10. Summary & plan

# Purpose of Vertex Detector

## Major targets of ILC are...

- precise measurement of Higgs
- precise measurement of Top quark
- Search for beyond the standard model

Higgs particles dominantly tend to decay  $bb$ ,  $cc$ ,  $gg$ .

To measure those BR, we need to identify  $b$   $c$   $g$  precisely

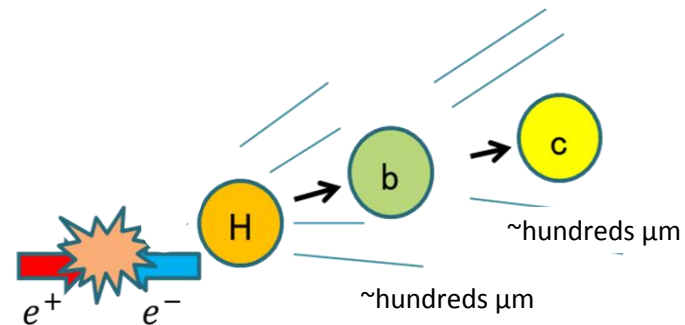
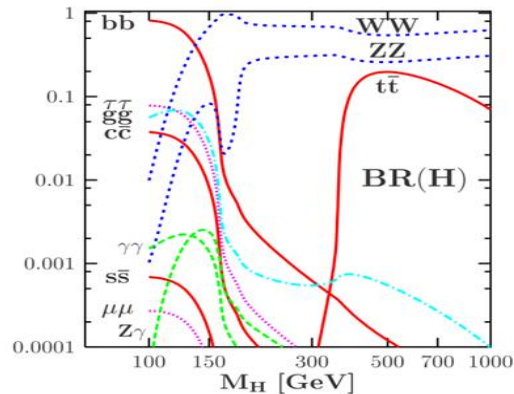

To tag  $b$ ,  $c$  and  $g$  from vertex position, we require less than  $3\mu\text{m}$  resolution for vertex detector

# FPCCD Vertex Detector

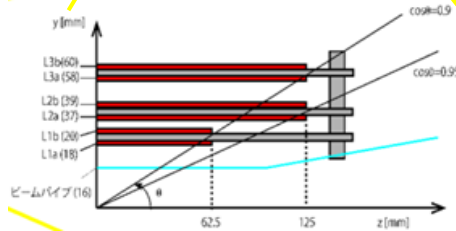
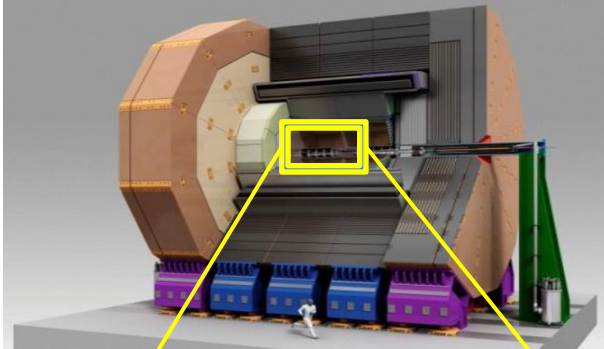

FPCCD : Fine Pixel Charge Coupled Device

Vertex detector

- Most inner layer located 16mm from the IP
  - to achieve high impact parameter resolution
- Thin sensor and support structure
  - to reduce multiple scattering ,
- Three doublet-layer structure
  - Better pattern recognition not to associate BG hits

## Merit of FPCCD

- ☺ Position resolution is very good ( $\sim 1\mu\text{m}$ )
- ☺ Pixel occupancy is low
  - so many pixels
- ☺ signal is less affected by electromagnetic interference
  - inter-train read-out
- ☺ smaller gain fluctuation
  - amplify each signal after transferring

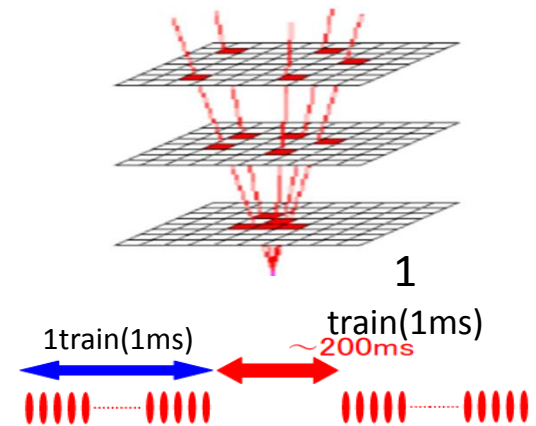

# Bulk damage

High energy electron and Heavy particles like neutron sometimes make lattice defect in FPCCD. Charge signals are often trapped by lattice defect then signal will reduce...

Lattice defect

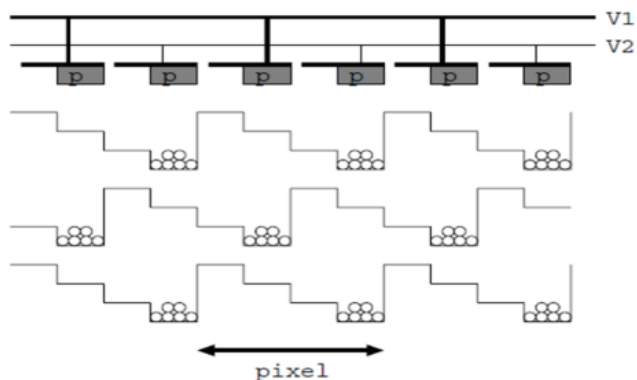
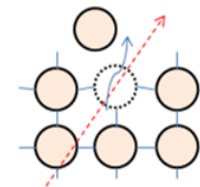

CCD transfers charge signal like bucket-brigade.

- FPCCD has so many pixels  
then few lattice defect can effect on transfer  
neutron equivalent flux of  $O(10^{10})$  neutrons/cm<sup>2</sup>  
incident upon the vertex detector may degrade  
its performance

According to simulation result, neutron  
come from mainly beam dump.  
And neutron fluence was determined to be  
 $1.85 \times 10^9$ neutron/cm<sup>2</sup>/year.

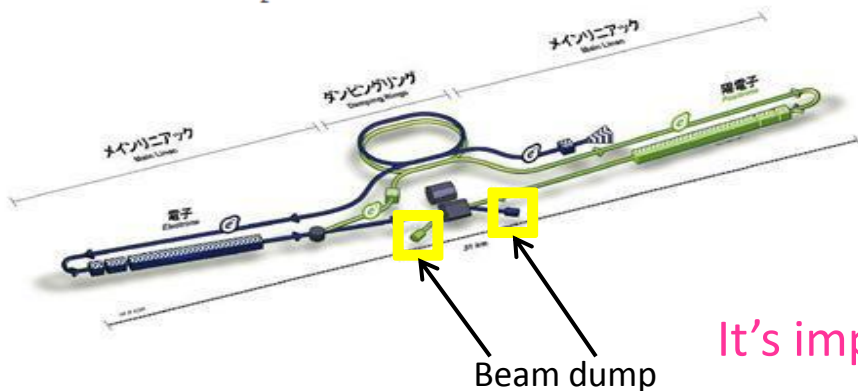

It's important to measure tolerance of detector!

# Characteristics of FPCCD

## i) CTI(Charge Transfer Inefficiency)

Inefficiency in transferring charge to neighboring pixel  
we test CTI using X-ray from Fe55.

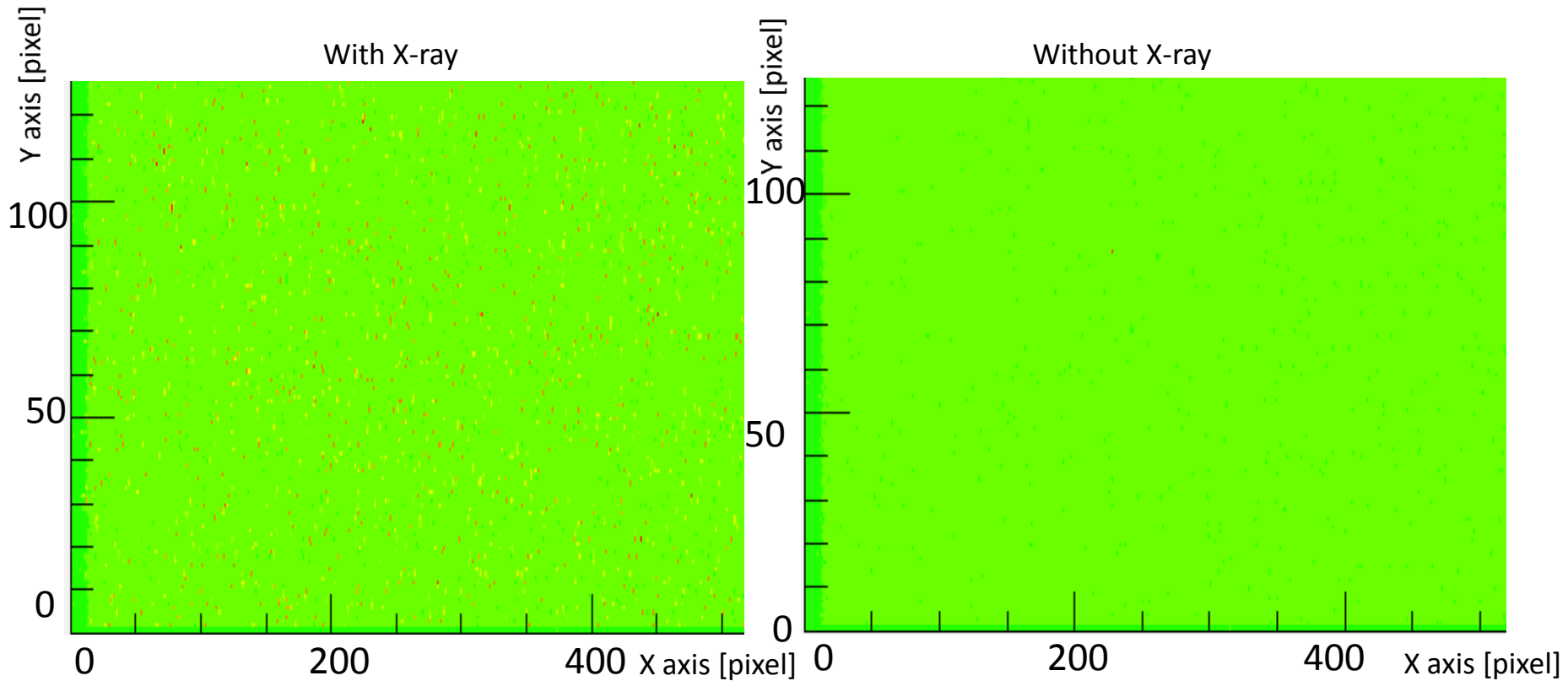

# Characteristics of FPCCD

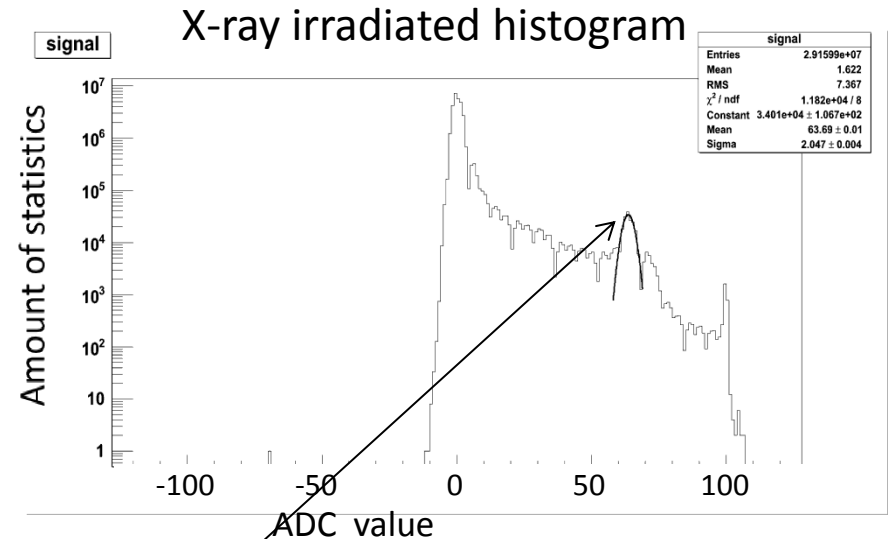
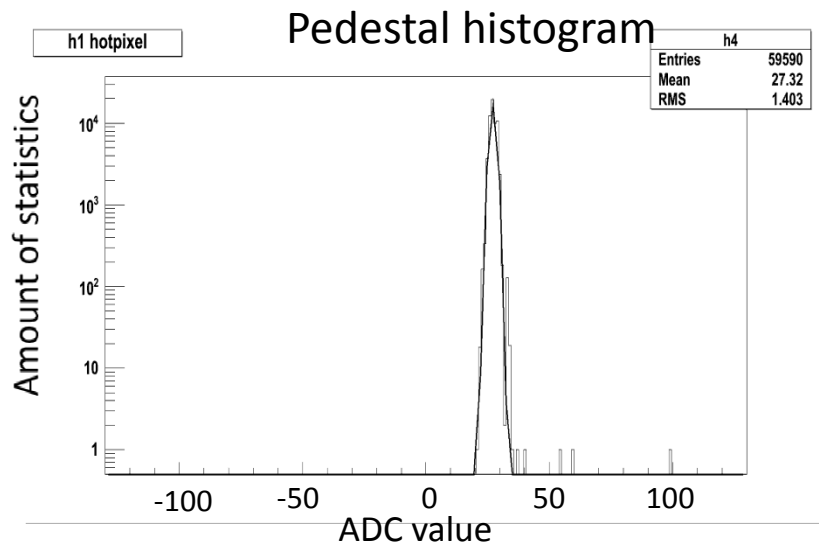

Fe55 peak (pedestal & average drift subtracted)

These figures show ADC value vs amount of statistics

Single pixel hit

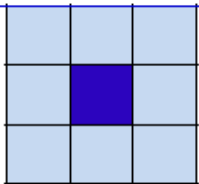

Single isolated pixel hit with ADC value consistent with X ray from Fe55.

We selected single pixel hit event to measure CTI. CTI can be measured by comparing peak positions of x-ray from Fe55 .

- if CCD can transfer charge signal all, CTI will be 0

# Characteristics of FPCCD

ii) **Hot pixels**: pixels emitting large dark current.

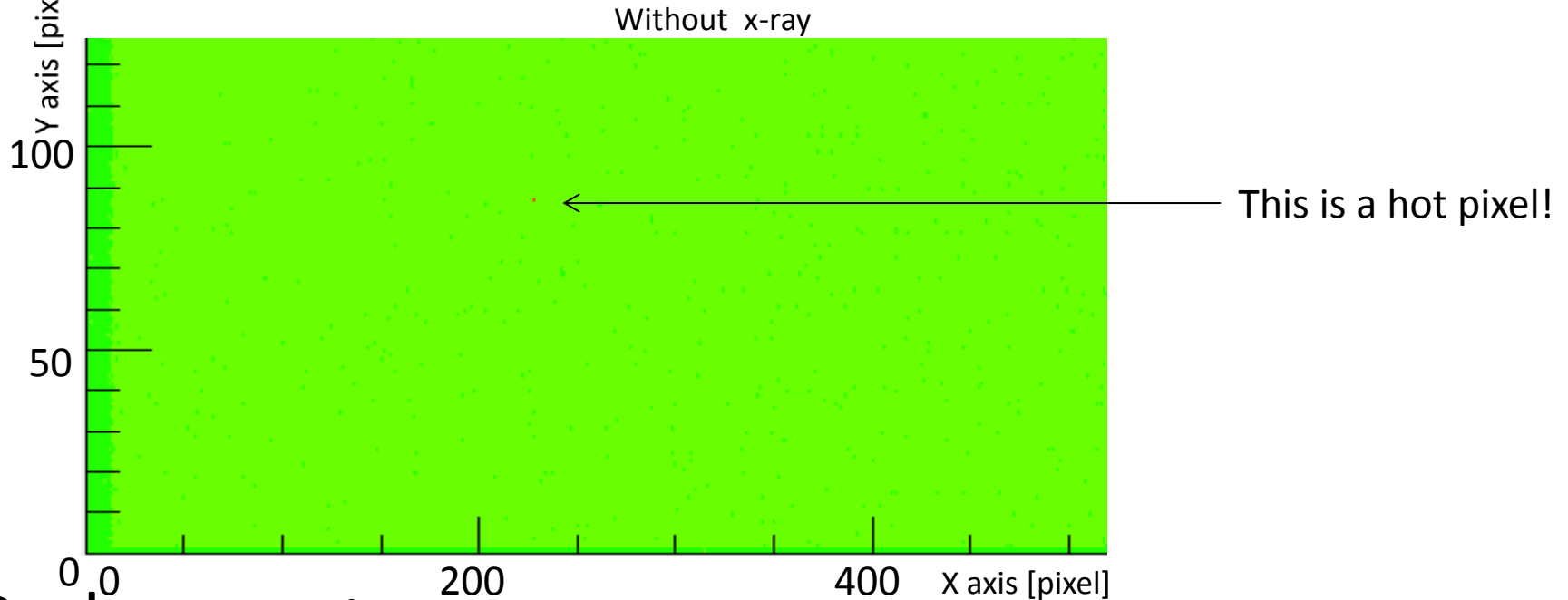

iii) **Dark current**: average of signal without x-ray.

At this irradiation test, we measured these 3 characteristics



# Read out modules

Stream of signal is ...

CCD --> ASIC--> FPGA --> SiTCP --> PC

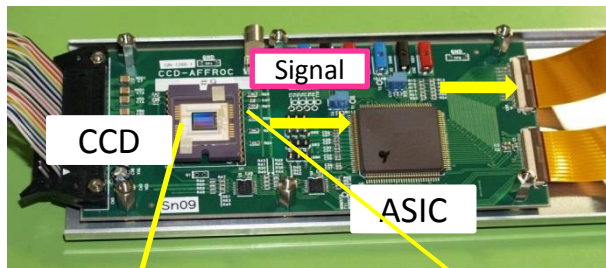

ASIC out put signal

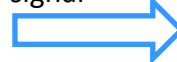

ASIC drive signal

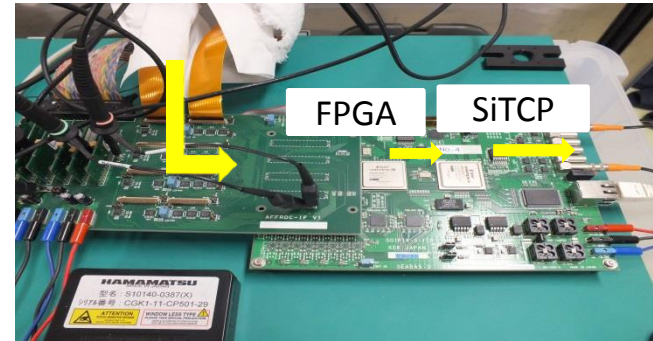

Ethernet connection



CCD spec

Sensitive thickness :  $15 \mu m$

Pixel size : CCD has 4 read-out channels. Pixel sizes are ...

$6 \times 6 \mu m^2$ ,  $8 \times 8 \mu m^2$ ,  $9.6 \times 9.6 \mu m^2$ ,  $12 \times 12 \mu m^2$

We only measured  $8 \times 8 \mu m^2$ ,  $12 \times 12 \mu m^2$



PC

# Read-out modules

To test temperature dependence of CTI, dark current, hot pixels, CCD and read out circuit were put into thermal box

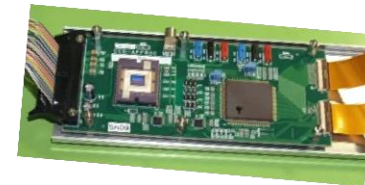
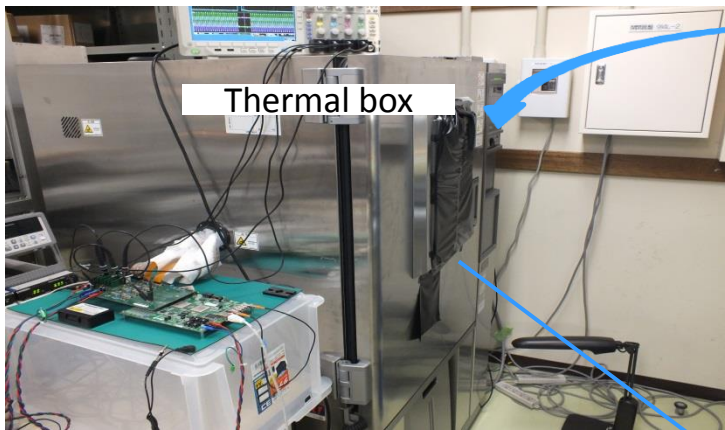

Before irradiation, we measured at  
 $-40^{\circ}\text{C}$ ,  $-20^{\circ}\text{C}$ ,  $0^{\circ}\text{C}$ ,  $+20^{\circ}\text{C}$   
 After irradiation, we measured at  
 $-40^{\circ}\text{C}$ ,  $-30^{\circ}\text{C}$ ,  $-20^{\circ}\text{C}$ ,  $-10^{\circ}\text{C}$ ,  $0^{\circ}\text{C}$ ,  $+10^{\circ}\text{C}$ ,  $+20^{\circ}\text{C}$

At each temperature, dark frame run and signal run are taken with Fe55 by turning on/off the shutter

shutter	open	close	close	close	close	close
Read out cycle(sec)	10	10	20	30	40	60

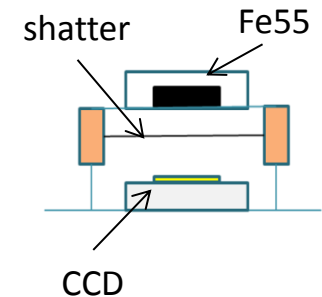
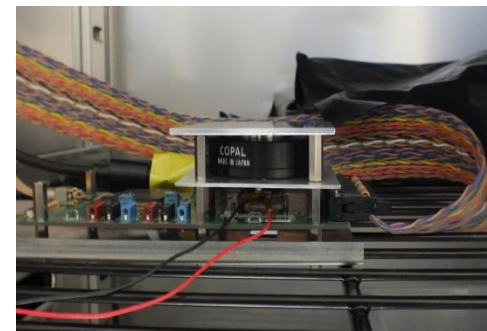

# Characteristics before irradiation

## i) CTI

I measured CTI of a channel of  $12\mu\text{m}$  (512 x 128) pixels at  $-40^\circ\text{C}$

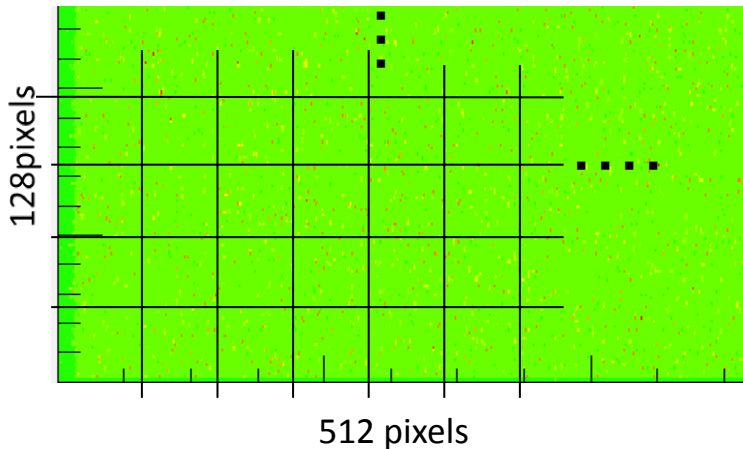

I divided 1 channel to  $31 \times 8$  regions

1 region has  $16 \times 16$  pixels

- measured ADC values for each region and fitted to extract CTI.

I fitted this histogram with function

$$\text{Function} = [p0] \times [P1]^x \times [p2]^y$$

[p0] : constant number

[p1] : Horizontal CTE (x direction)  
(CTE : Charge Transfer Efficiency)

[p2] : Vertical CTE (y direction)

x : region number (x direction)

y : region number (y direction)

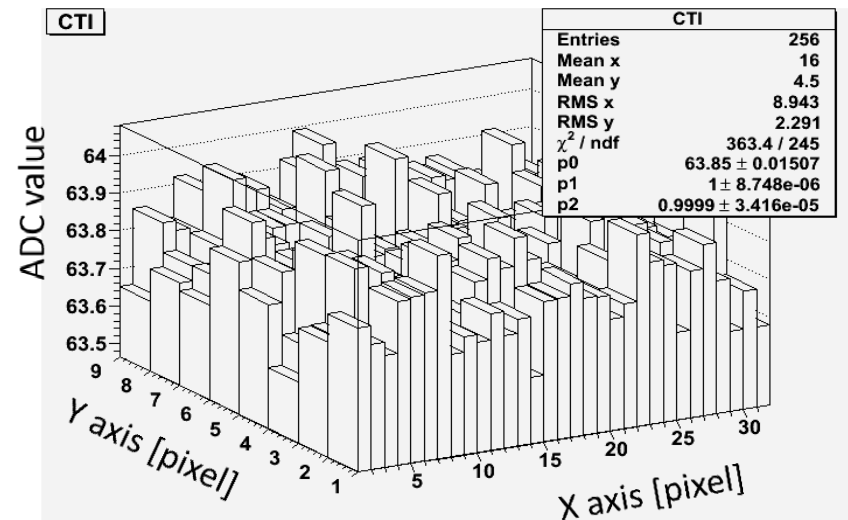

# Characteristics before irradiation

Before irradiation result

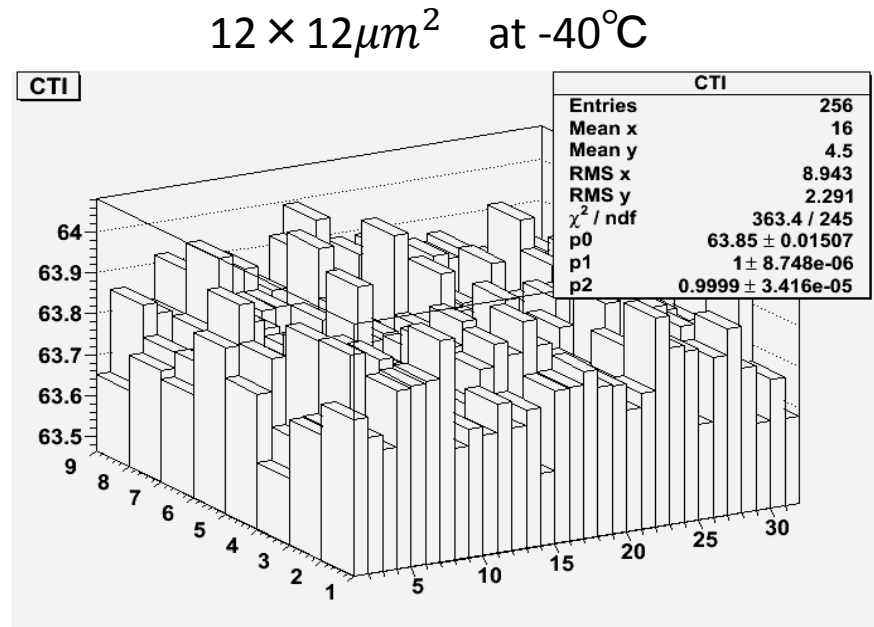

$$\text{CTI} = 1 - \text{CTE}$$

We got CTE from fitting function. Then we can calculate CTI/pixel

$$\begin{aligned} \text{horizontal} &: (1.844 \pm 0.547) \times 10^{-6} \\ \text{vertical} &: (4.660 \pm 2.135) \times 10^{-6} \end{aligned}$$

# Characteristics before irradiation

## ii) Hot pixels

Number of hot pixels increase depending on temperature. These figures show temperature dependence of hot pixel for 12 $\mu$ m pixels channels

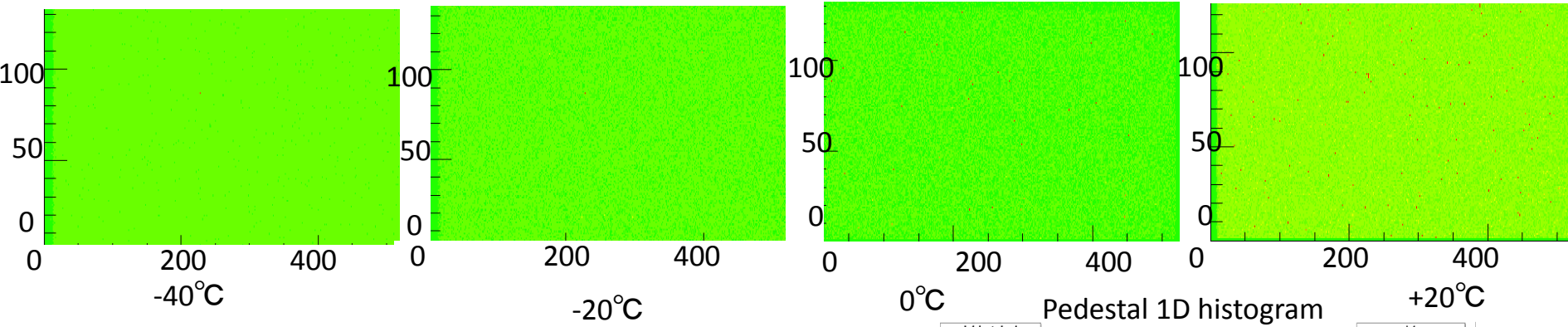

I set threshold level at ADC value of 40 and signals larger than threshold, I considered these are hot pixels.

Cut at 40 level

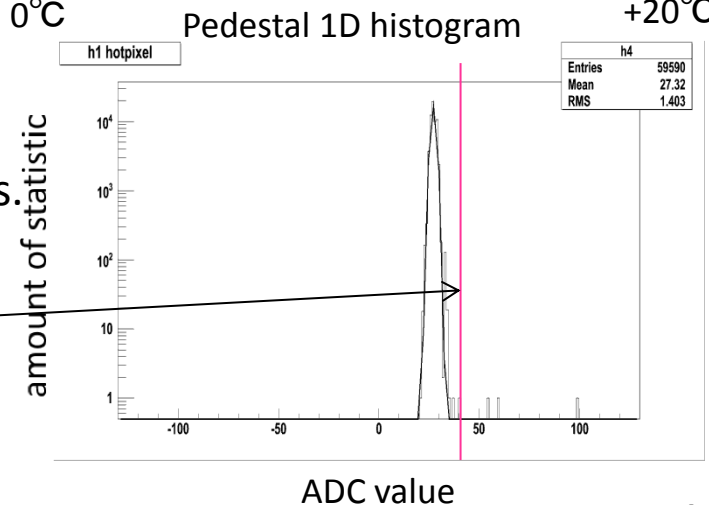

# Characteristics before irradiation

Data was taken for 10sec by 10 frames for hot pixel measurements.

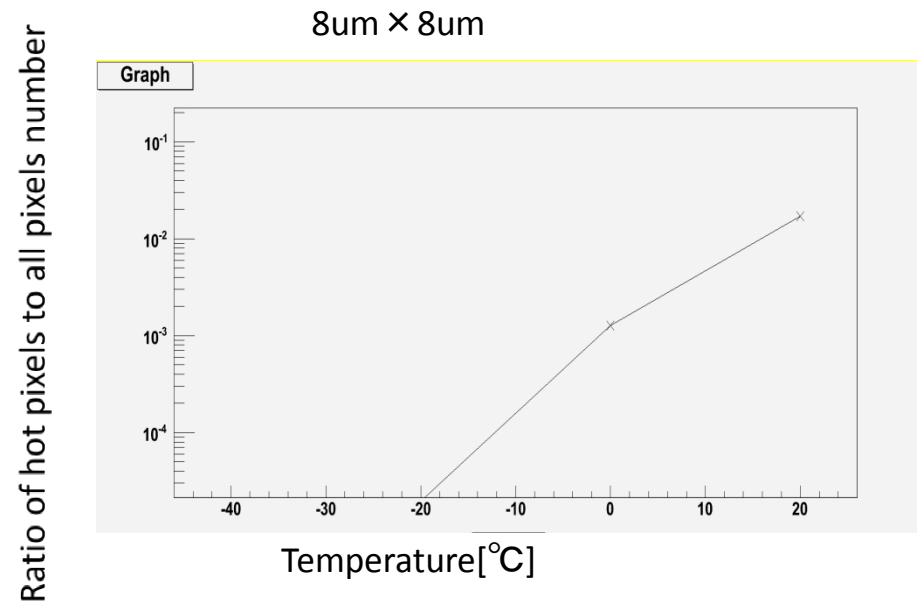
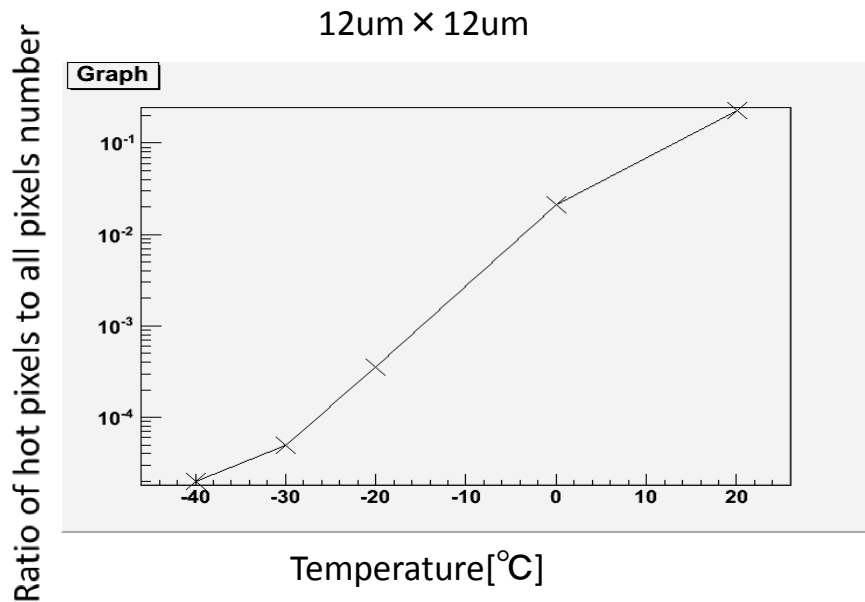

Ratio of hot pixels got larger as the temperature was raised.

- at -40°C, ratio of hot pixels  $\cong 0$

# Characteristics before irradiation

## iii) Dark current

Dark current is proportional to read out time.

We measured dark current 10sec, 20sec, 30sec, 40sec, 60sec.

ADC peak vs time(sec) 12um x 12um

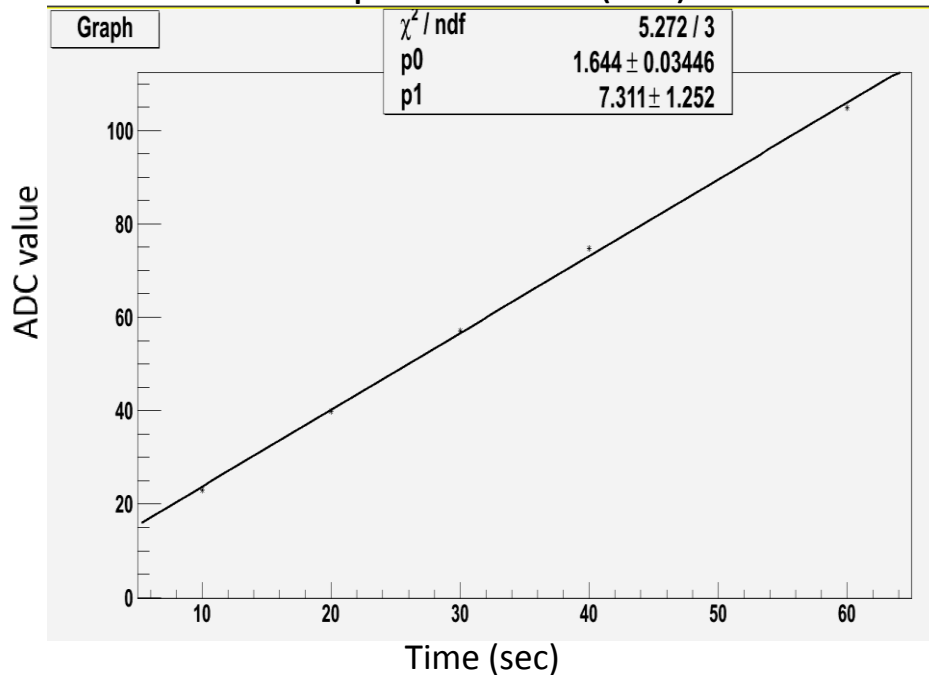

Fit with linear function

$$f = ax + b$$

Then we can derive pedestal level per 1 sec

- gradient means pedestal level per 1 sec

Before irradiation at +20°C

# Neutron Irradiation

## - Set up

We did neutron beam irradiation at 16,17 Oct at Tohoku University CYRIC. We made neutron beam by irradiating  $1\mu\text{A}$  proton beam to 7-8mm thickness Li target.

Irradiated time was

30 minutes 19 sec.

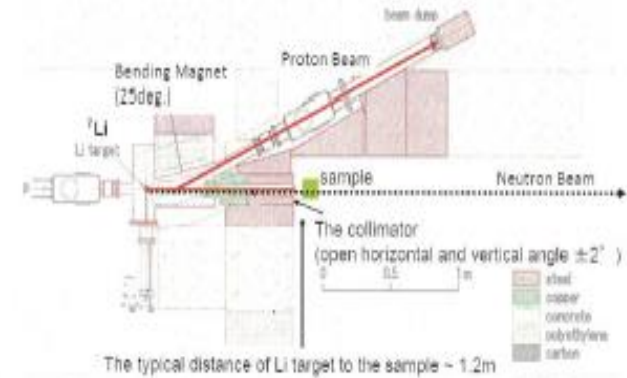

Plastic scintillator

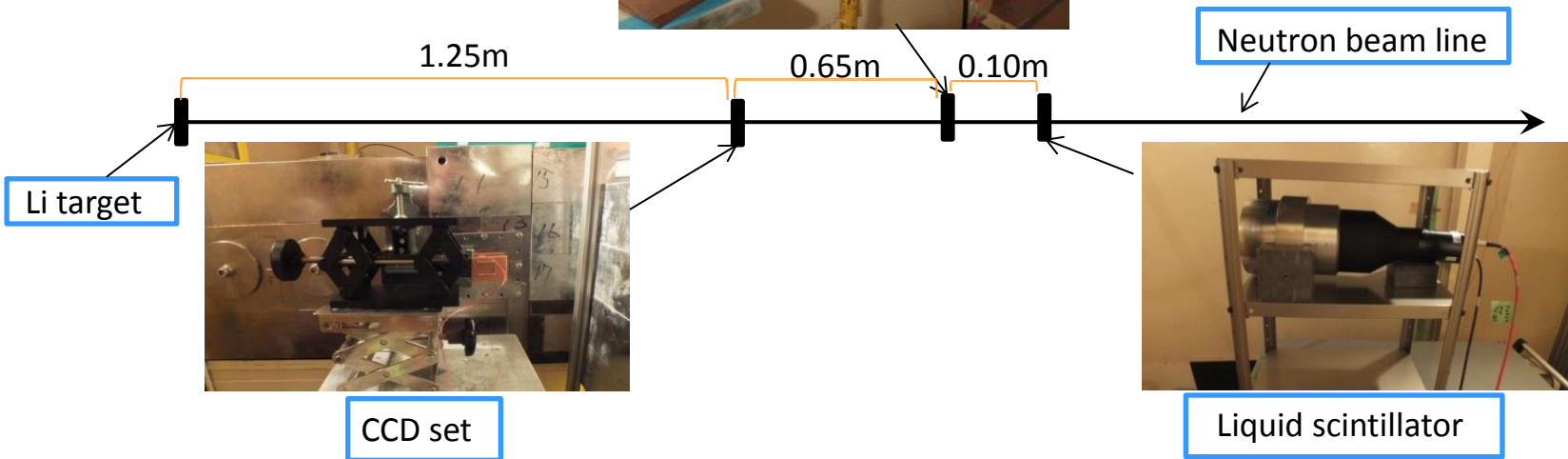



# Neutron Irradiation

## - Flux of neutron

To measure flux of neutron, we used plastic scintillator and liquid scintillator

- i ) First, we used liquid scintillator to measure total number of neutrons after collimator.

$$8.29 \times 10^6 \text{neutron/sec}$$

- ii ) Second, we measured beam size by plastic scintillator. And measured beam size at 6 point each 5cm from beam line.

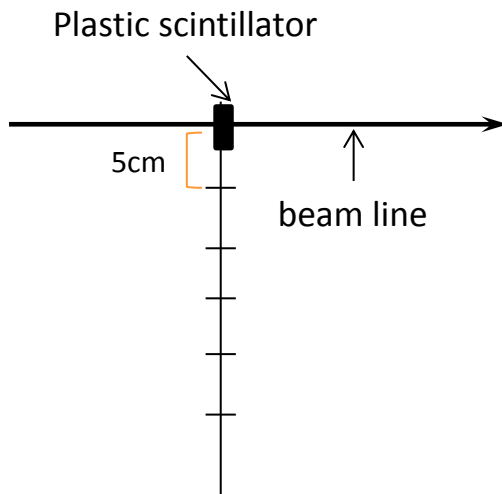

- beam size was **14.7cm** at 1.9m from Li target

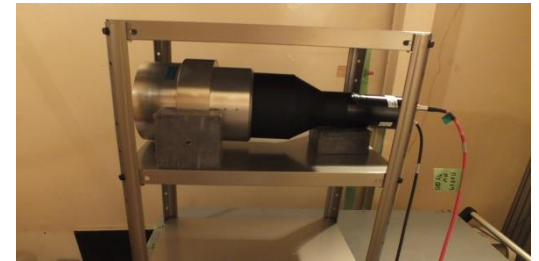

We assumed neutron flux reduces linearly with respect to the distance from beam line

CCD set at 1.25m from Li target was irradiated  **$9.4 \times 10^8$ neutron**

# Result

## - CTI

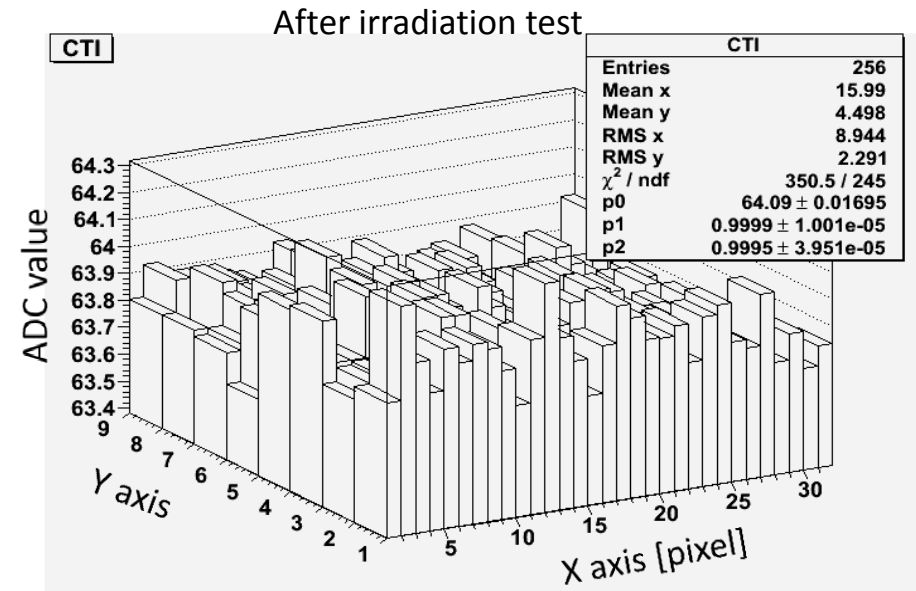
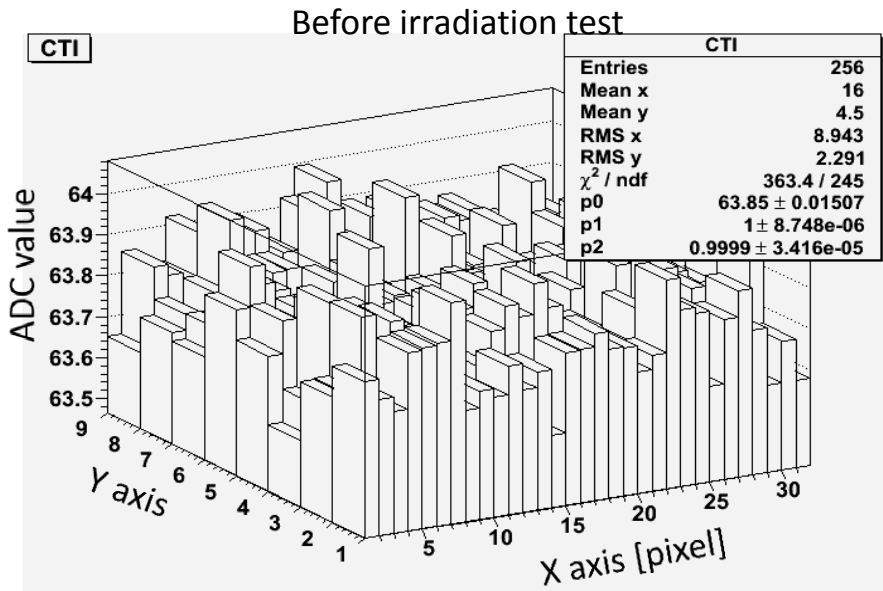

CTI / pixel was ...

horizontal :  $(1.844 \pm 0.547) \times 10^{-6}$   
vertical :  $(4.660 \pm 2.135) \times 10^{-6}$

horizontal :  $(6.392 \pm 0.626) \times 10^{-6}$   
vertical :  $(2.834 \pm 0.247) \times 10^{-5}$

# Result

## - Hot pixels

After irradiation, we saw many hot pixels.

Before irradiation

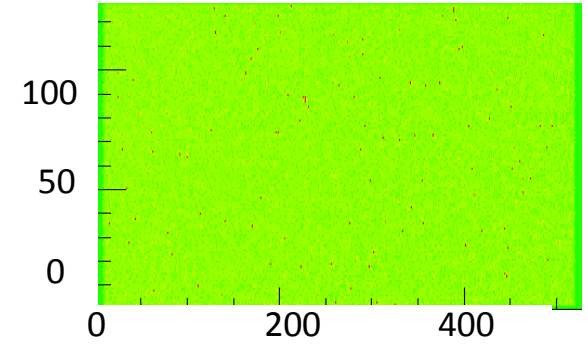
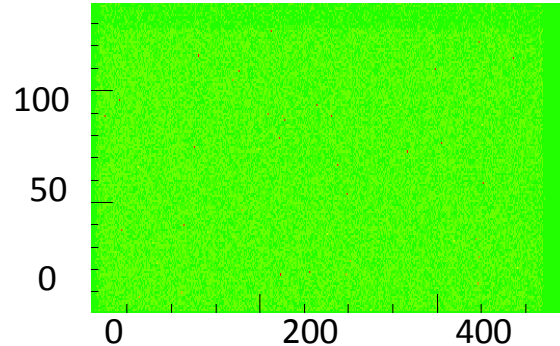
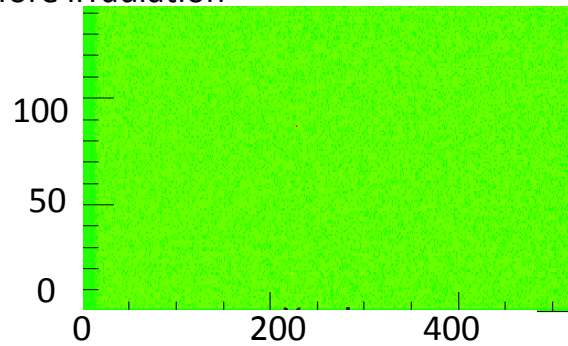

After irradiation (less than one hour after irradiation )

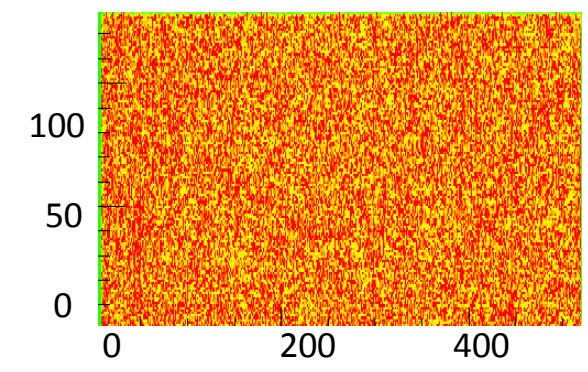
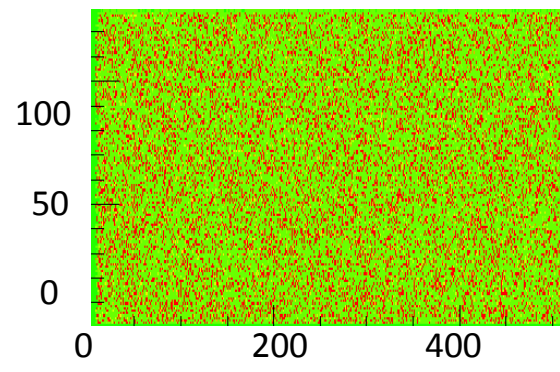
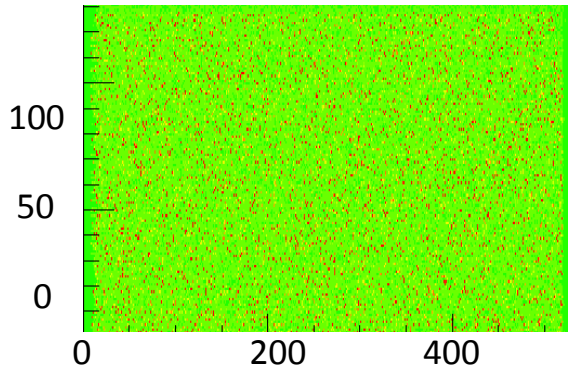

-20°C

0°C

+20°C

# Result

12um × 12um

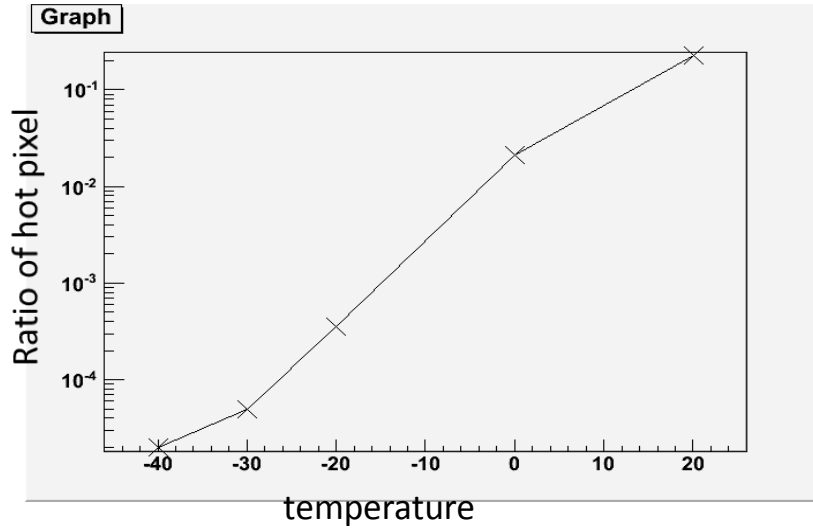

8um × 8um

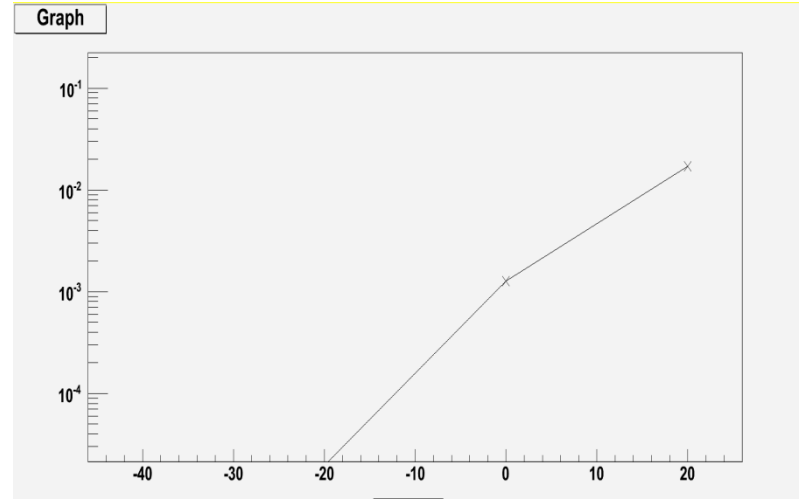

After Irradiation test

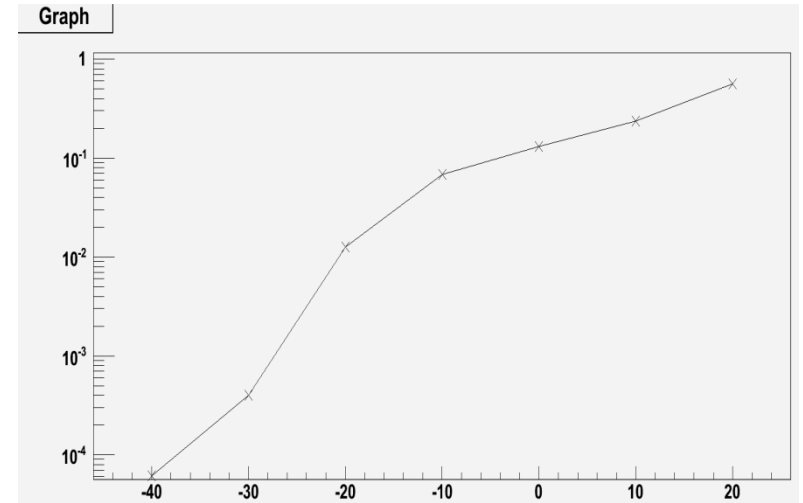
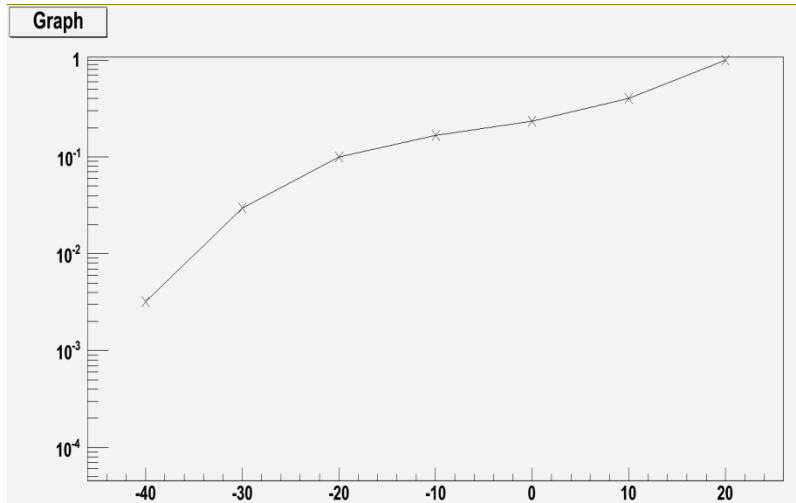

# Summary & Plan

- FPCCD is one of the candidate of vertex detector.
- We performed neutron irradiation and measured CTI, dark current and hot pixels.
- After irradiation test, we saw many hot pixels.

## Plans

- To measure CTI and dark current at various temperatures.
- To measure dependence of CTI on various parameters such as clock frequency and voltage.

# Back Up

