



RF Waveguide Distribution



RF Power Waveguide Distribution (1)

- Distribution of klystron output power to the superconducting cavities
- Protection of the klystron from reflected power
- Control of phase and Q_{ext}



RF Power Waveguide Distribution (2)

Distribution of RF power is done by:

- Waveguides: high power possible, low loss up to certain frequencies
Other devices which are not used:
- Coaxial lines: power loss is high, heating of the inner conductor or the dielectric material
- Parallel wires: radiation into the environment
- Striplines: breakdown limit at high power is low, in use for low power applications e.g. integrated circuits

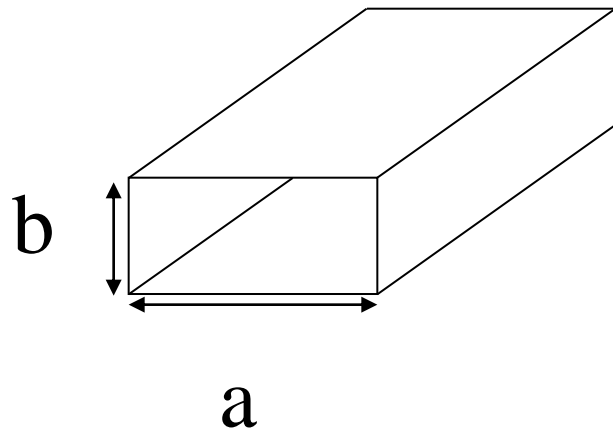

Which electromagnetic waves (frequencies, modes) can propagate?

- Start with Maxwell Equation
- Solve wave equation with boundary conditions:

Two types of solutions:

- TE (H-Wave): $E_z=0$ $H_z \neq 0$
- TM (E-Wave): $E_z \neq 0$ $H_z=0$
- The TE and TM waves can be classified due to the number of field maxima in the x and y direction:
 TE_{nm} (H_{nm}) and TM_{nm} (E_{nm})

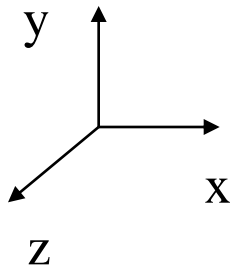

- In a rectangular waveguide only nm- modes below (above) a certain wavelength λ_{cnm} (frequency ν_{cnm}) can propagate.

$$\lambda_{cnm} = \frac{2}{\sqrt{\left(\frac{n}{a}\right)^2 + \left(\frac{m}{b}\right)^2}}$$

$$\nu_{cnm} = c \frac{\sqrt{\left(\frac{n}{a}\right)^2 + \left(\frac{m}{b}\right)^2}}{2}$$

Rectangular Waveguides

- The mode with lowest frequency propagating in the waveguide is the TE_{10} (H_{10}) mode.

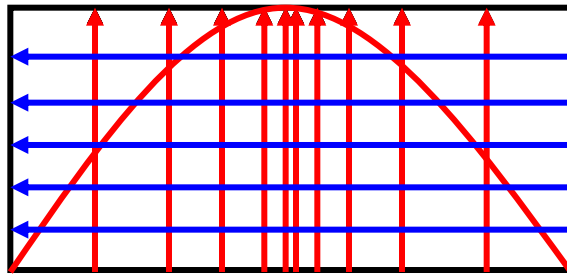

Cutoff Frequency:
 $n_{c10} = c/2a$

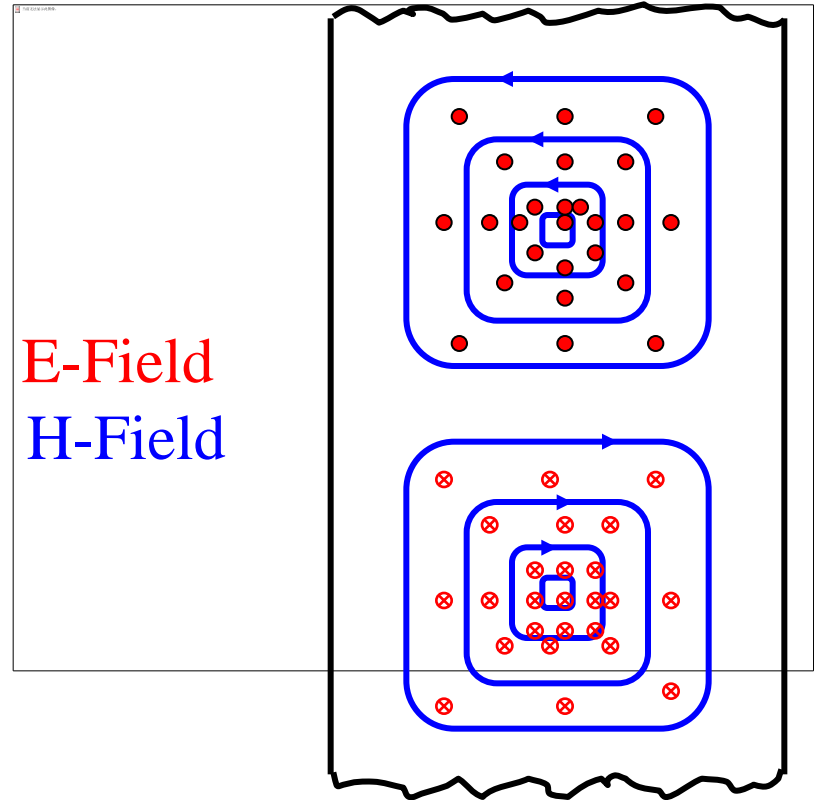



Waveguide Size for 1.3GHz

- Most common are 2:1 waveguides $a=2b$, for 1.3GHz the following waveguides would be appropriate
- WR650 (proposed for ILC) $a=6.5\text{inch}$ $b=3.25\text{inch}$ $n_{c10}=908\text{MHz}$
- WR770 $a=7.7\text{inch}$ $b=3.85\text{inch}$
 $n_{c10}=767\text{MHz}$



Attenuation of TE_{10}

- Due to losses in the walls of the waveguides the wave is attenuated.
- The attenuation constant is:

$$\alpha [dB / m] = 0.2026 k_1 \frac{1}{b [cm] \sqrt{\lambda [cm]}} \frac{\frac{1}{2} + \frac{b}{a} \left(\frac{\lambda}{2a} \right)^2}{\sqrt{1 - \left(\frac{\lambda}{2a} \right)^2}}$$

$k_1 = 1.00$ Ag, 1.03 Cu, 1.17 Au, 1.37 Al, 2.2 Brass



Phase constant and Impedance of TE_{10}

$$\beta_g = \sqrt{k^2 - (\pi/a)^2} \quad \text{with} \quad k = 2\pi/\lambda$$

- β_g phase constant of the waveguide wave and k phase constant in free space

$$\lambda_g = 2\pi / \beta_g$$

- λ_g is the distance between two equal phase planes along the waveguide and is longer than λ
- The impedance Z of the waveguide is

$$Z = \frac{377 \Omega}{\sqrt{1 - \left(\frac{\lambda}{\lambda_{c10}}\right)^2}}$$

Power in TE_{10}

$$P_{RF} = 6.63 \times 10^{-4} a[cm]b[cm] \left[\frac{\lambda}{\lambda_g} \right] E[V/cm]^2$$

- The maximum power which can be transmitted theoretically in a waveguide of certain size a, b and wavelength λ is determined by the breakdown limit E_{\max} .
- In air it is $E_{\max} = 32 \text{ kV/cm}$ and in SF6 it is $E_{\max} = 89 \text{ kV/cm}$ (1 bar, 20°C). Problem with SF6 is that although it is chemically very stable (1) it is a green house gas and (2) if cracked in sparks products can form HF which is a very aggressive acid.
- The practical power limit is lower, typically 5-10 times lower, because of surface effects (roughness, steps at flanges etc.), dust in waveguides, humidity, reflections (VSWR) or because of higher order modes TE_{nm}/TM_{nm} . These HOMs are also generated by the power source. If these modes are not damped, they can be excited resonantly and reach very high field strength above the breakdown limit.

Straight Waveguide (1)



TE₁₀

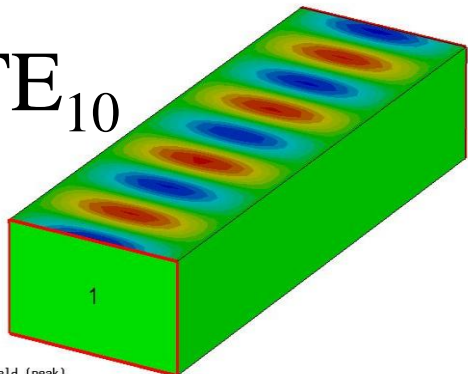

Type = E-Field (peak)
 Monitor = e-Field (f=2.6) [1(1)]
 Component = Normal
 Maximum-3d = 243.164 V/m at 5.50333 / 58.9643 / 388.889
 Frequency = 2.6
 Phase = 180 degrees



TE₂₀

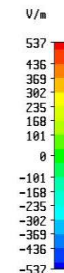
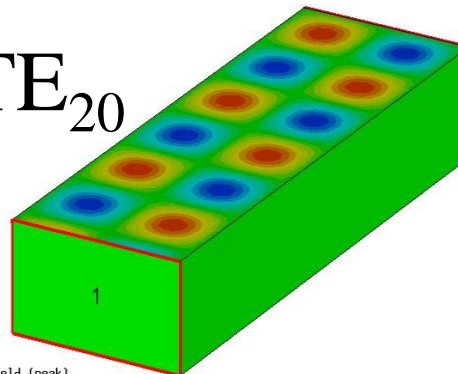

Type = E-Field (peak)
 Monitor = e-Field (f=2.6) [1(3)]
 Component = Normal
 Maximum-3d = 553.051 V/m at -38.5233 / 35.3786 / 200
 Frequency = 2.6
 Phase = 112.5 degrees



TE₀₁

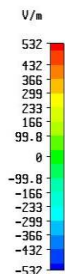
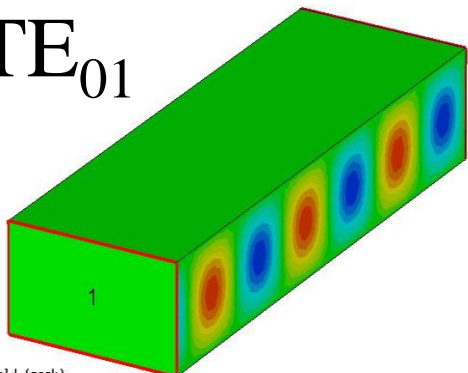

Type = E-Field (peak)
 Monitor = e-Field (f=2.6) [1(2)]
 Component = Normal
 Maximum-3d = 541.928 V/m at 49.53 / 47.1714 / 200
 Frequency = 2.6
 Phase = 112.5 degrees



TE₁₁

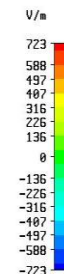
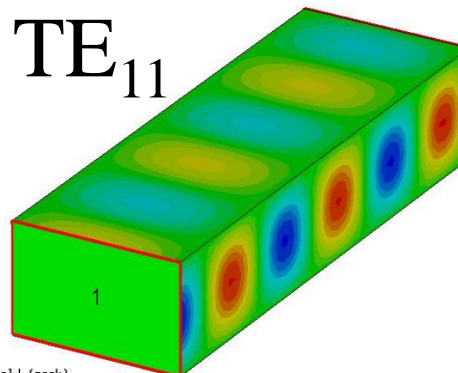

Type = E-Field (peak)
 Monitor = e-Field (f=2.6) [1(4)]
 Component = Normal
 Maximum-3d = 727.573 V/m at 71.5433 / 47.1714 / 322.222
 Frequency = 2.6
 Phase = 337.5 degrees

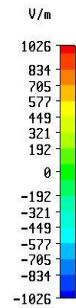
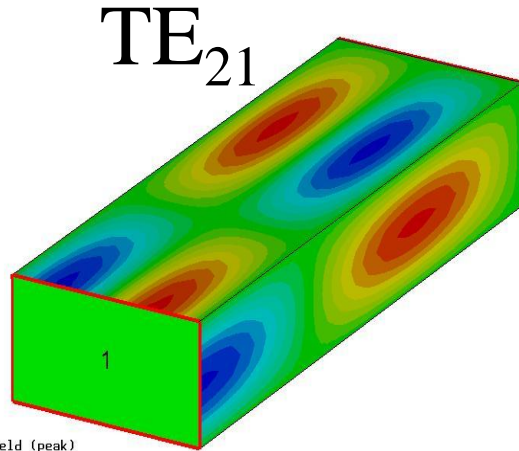

Type = E-Field (peak)
 Monitor = e-field (f=2.6) [1(6)]
 Component = Normal
 Maximum-3d = 1033.08 V/m at -38.5233 / 70.7571 / 166.667
 Frequency = 2.6
 Phase = 0 degrees

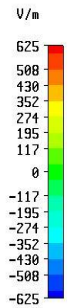
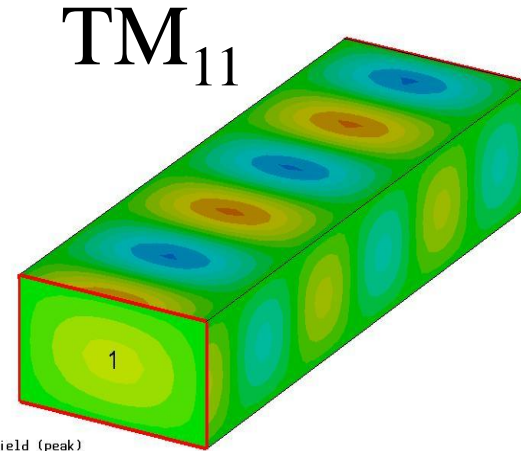

Type = E-Field (peak)
 Monitor = e-field (f=2.6) [1(5)]
 Component = Normal
 Maximum-3d = 637.948 V/m at 5.50333 / 35.3786 / 177.778
 Frequency = 2.6
 Phase = 337.5 degrees



E-Field

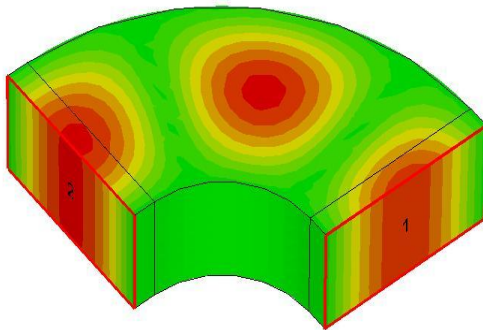

Type = E-Field (peak)
 Monitor = e-field (f=1.3) [11]
 Component = Abs
 Maximum-3d = 282.118 V/m at -55.9724 / 82.55 / 98.9501
 Frequency = 1.3
 Phase = 157.5 degrees

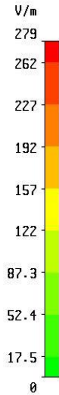

H-Field

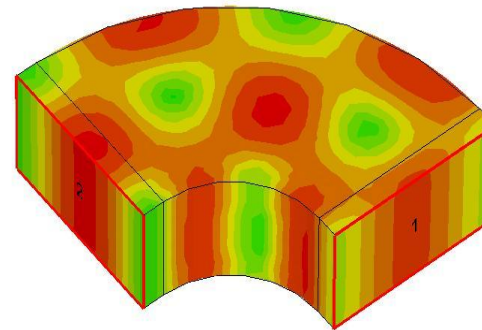

Type = H-Field (peak)
 Monitor = h-field (f=1.3) [11]
 Component = Abs
 Maximum-3d = 0.552589 A/m at 66 / 61.9125 / 77
 Frequency = 1.3
 Phase = 157.5 degrees

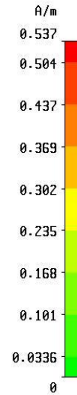



E-Field

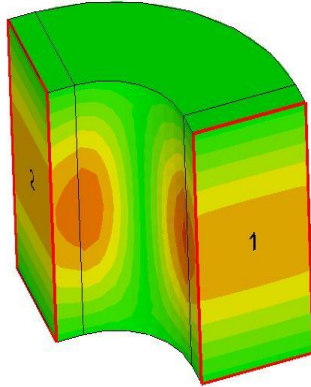

Type = E-Field (peak)
 Monitor = e-field (f=1.3) [1]
 Component = Abs
 Maximum-3d = 386.366 V/m at 8.42857 / 82.55 / 25.2857
 Frequency = 1.3
 Phase = 202.5 degrees

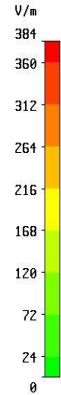

H-Field

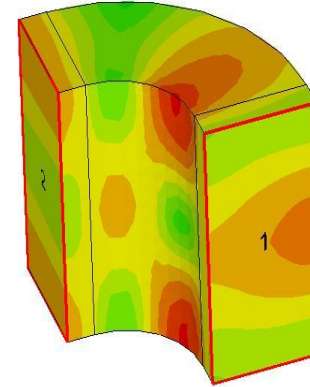

Type = H-Field (peak)
 Monitor = h-field (f=1.3) [1]
 Component = Abs
 Maximum-3d = 0.74572 A/m at 8.42857 / 148.59 / 33.7143
 Frequency = 1.3
 Phase = 157.5 degrees

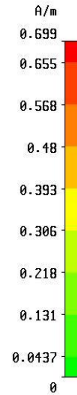

- Power Coupler are used to couple out a certain amount of power from a main waveguide arm
- Hybrids, Magic Tees, Shunt Tees, Series Tees might be used

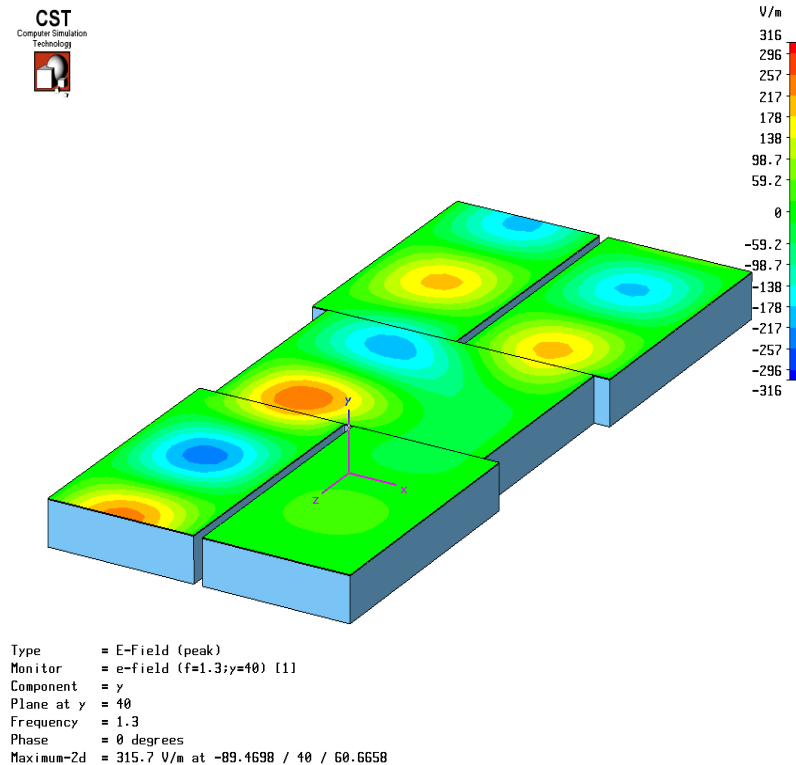



Circulator (1)

- A circulator is a device, which has an input port (1), output port (2) and load port (3). If power is entering (1) it is transferred to port (2), but if power is entering (2) it is transferred to (3) and then absorbed in a load.
- The circulator protects the RF source from reflected power.
- Circulators make use of ferrite material in the waveguide which is pre-magnetized by an external magnetic field.
- The interaction of the H-vector of the RF field with the permanent magnets of the ferrites are responsible for the directive properties of a circulator.
- The height in a circulator is reduced due to the ferrite plates. Therefore the breakdown limit and thus the power capability is reduced. In a WR650 waveguide and air it is ~500kW.

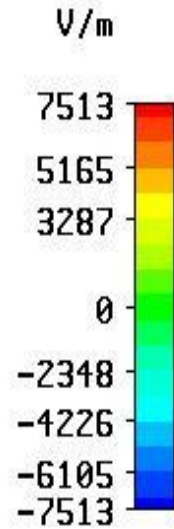
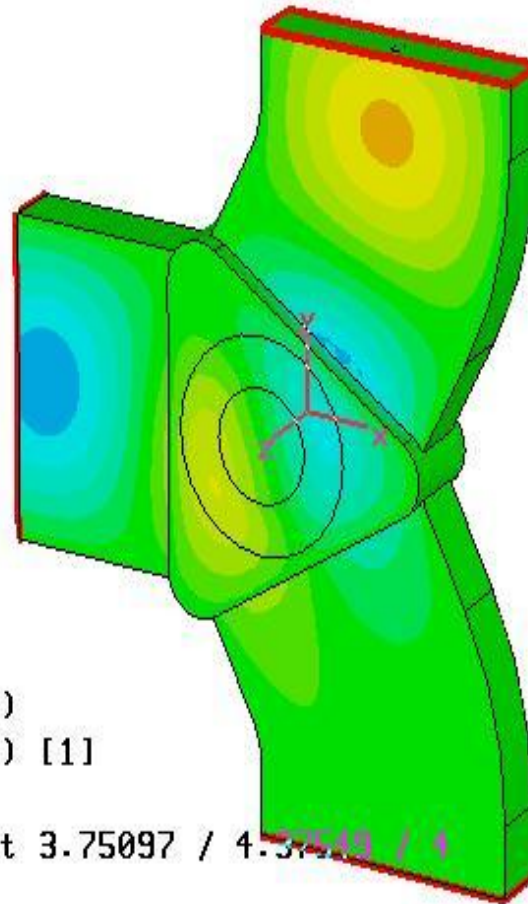

Type = E-Field (peak)
 Monitor = e-field (f=15) [1]
 Component = Normal
 Maximum-3d = 8943.51 V/m at 3.75097 / 4.37513 / 1
 Frequency = 15
 Phase = 202.5 degrees

- Loads absorb the power generated by an RF source
- Absorbing material can be ferrite, SiC or water.
- The amount of power reflected by a load is described by the VSWR defined as

$$VSWR = \frac{|E_f| + |E_r|}{|E_f| - |E_r|} = \frac{1 + \rho}{1 - \rho} \quad \text{and}$$

$$\rho = \frac{Z_L - Z}{Z_L + Z}$$

With Z waveguide impedance of the waveguide and Z_L load impedance

- By adjusting the dimensions of the waveguide e.g. the width a changes and therefore the phase constant changes.

$$\beta_g = \sqrt{k^2 - (\pi / a)^2}$$

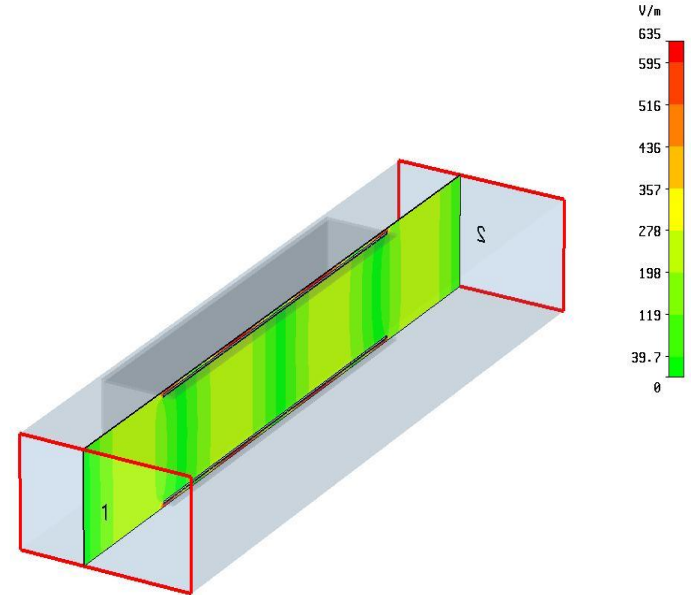

Type = E-Field (peak)
 Monitor = e-field (f=1.3;x=b) [1]
 Component = Abs
 Plane at x = -21.15
 Frequency = 1.3
 Phase = 90 degrees
 Maximum-2d = 634.757 V/m at -21.15 / 0 / 64.6887

Adjustment of Q_{ext} (1)

- The RF power required for a certain gradient of a superconducting cavity depends on the beam current and coupling between the cavity and waveguide.
- The coupling with the cavity may be changed by variation of Q_{ext} .
- The Q_L seen by the cavity is determined by the $Q_{unloaded}$ and Q_{ext} .
 Q_{ext} is given by the load impedance Z_0 plus variable coupling to this load.
- The Q_{ext} can be adjusted by tuners like stub tuners, iris tuners, E-H tuners etc.

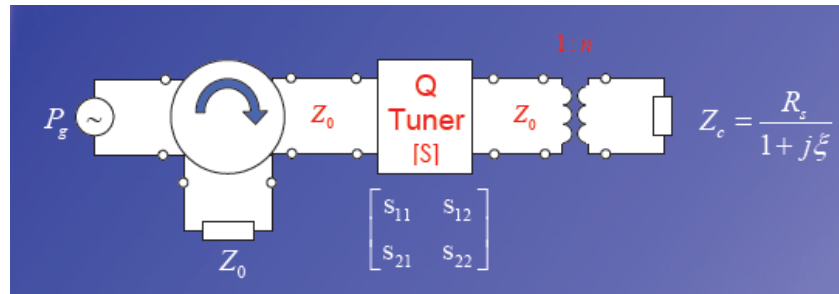

Adjustment of Q_{ext} (2)

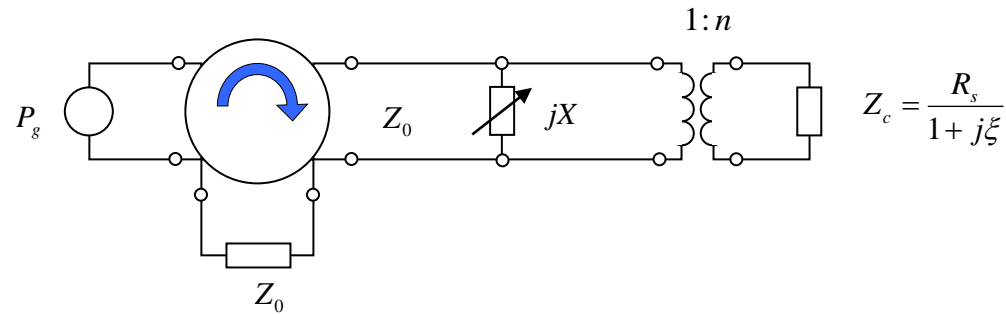

Figure 1: *Equivalent circuit of cavity powered through a circulator with the variable obstacle (no moving along waveguide)*

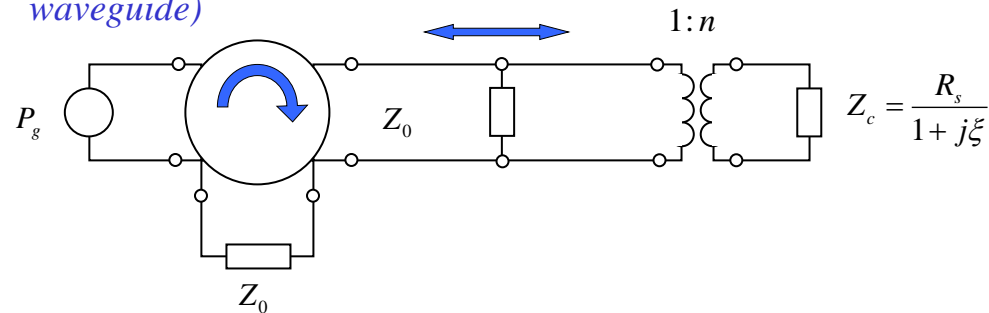

Figure 2: *Equivalent circuit of cavity powered through a circulator with the fixed obstacle moving along waveguide*



Linear Distribution System (1)

- For TESLA a linear distribution system has been proposed
- Equal amounts of power are branched off from the main RF power waveguide
- Circulators in each branch protect the klystron from reflected power
- Stub tuners allow adjustment of phase and Q_{ext} , for the XFEL inductive iris tuners are proposed
- Alternative schemes have been proposed



Linear Distribution System (2)

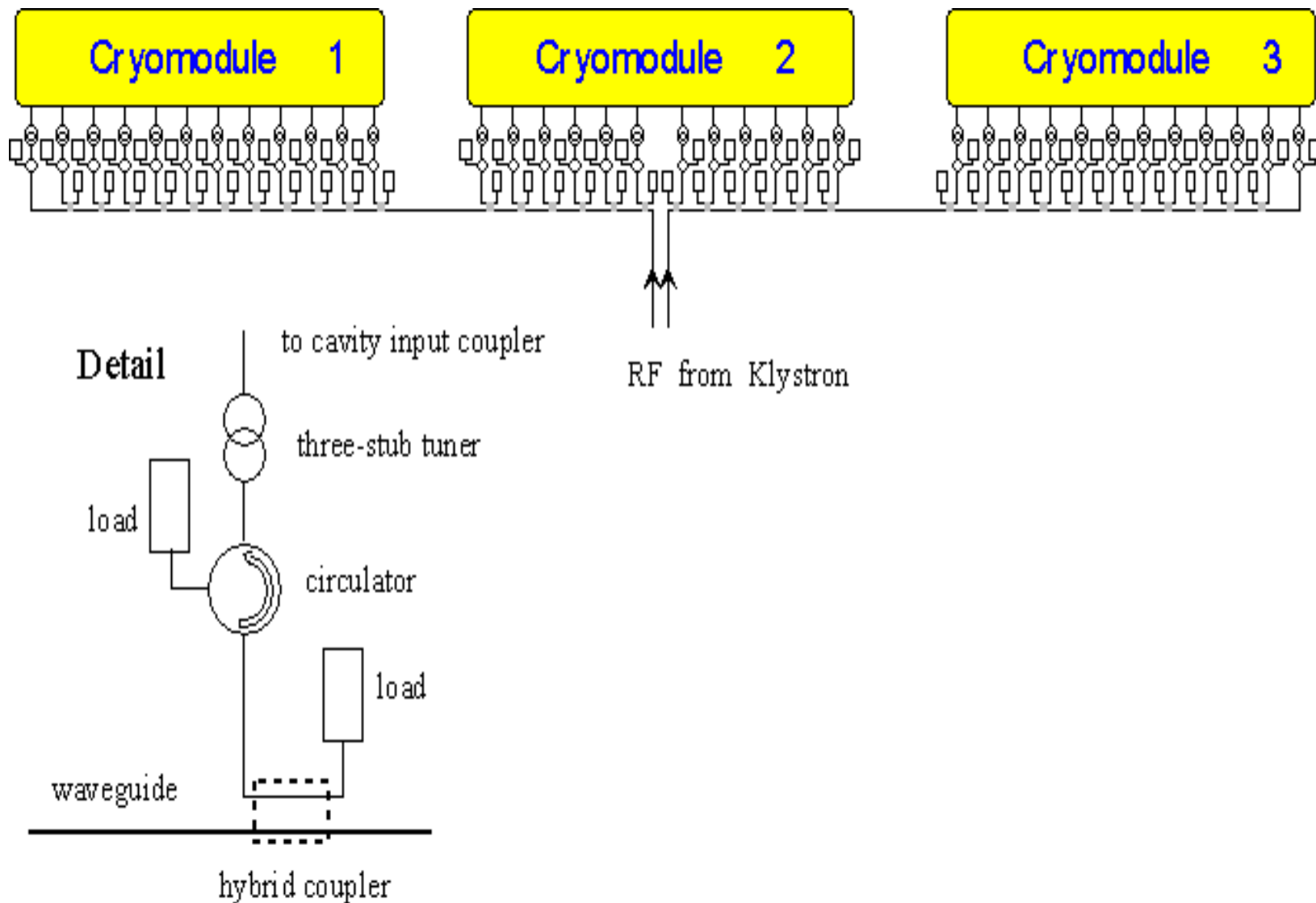



Alternative waveguide distribution schemes

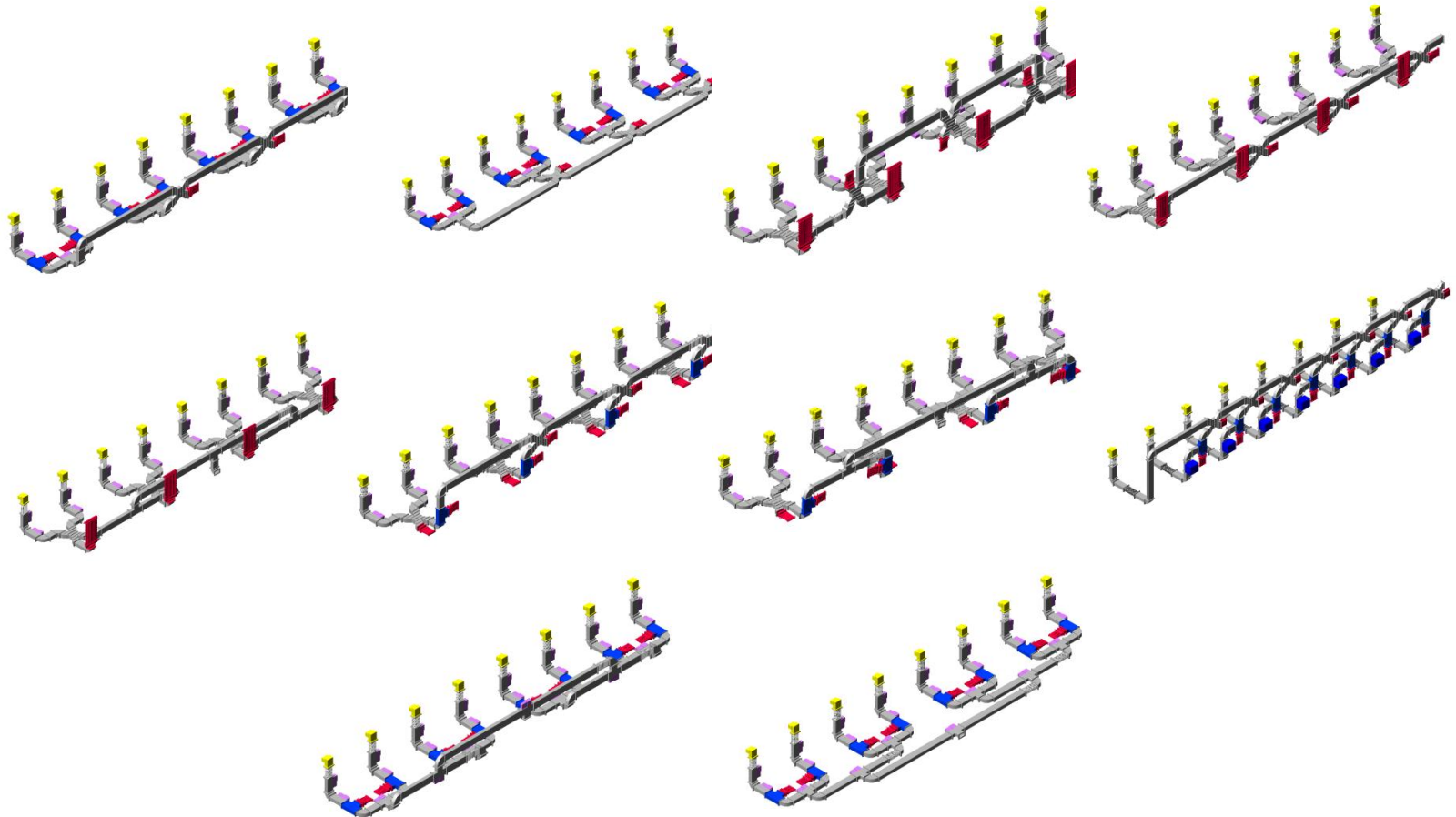



RF Waveguide Components

3 Stub Tuner (IHEP, Beijing, China)



Changing phase, degree
Impedance matching range
Max power, MW

± 60
 $1/3Z_w \text{ @ } 3Z_w$
2

* Z_w – waveguide impedance

E and H Bends (Spinner)



Circulator (Ferrite)



Type	WFHI 3-4
Peak input power, MW	0.4
Average power, kW	8
Min isolation at 1.3 GHz, dB	>30
Max insertion loss at 1.3 GHz, dB	≤ 0.08
Input SWR at 1.3 GHz (for full reflection)	1.1

Hybrid Coupler (RFT, Spinner)



Directivity, dB	± 30
Return loss, dB	± 35
Coupling factor, dB	12.5; 12.0; 11.4;
(due to tolerance overlapping only 13 different coupling factors instead 18 are necessary)	10.7; 10.1; 9.6;
	9.1; 8.5; 7.8;
	7.0; 6.0; 4.8; 3.0
Accuracy of coupling factor, dB	± 0.2

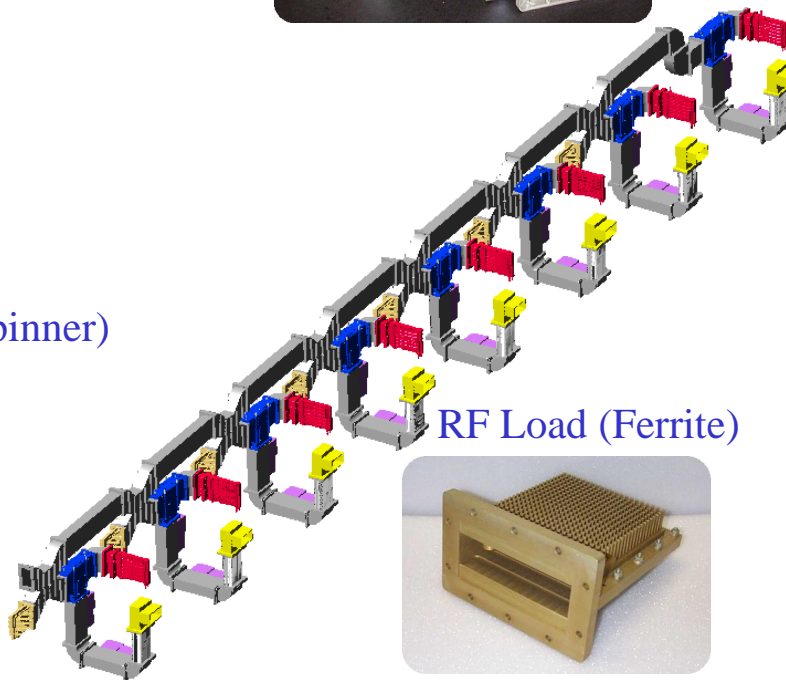

RF Load (Ferrite)



Type	WFHLL 3-1
Peak input power, MW	1.0
Average power, kW	0.2
Min return loss at 1.3GHz, dB	32 @ 40
Max VSWR at 1.3 GHz	≤ 1.05
Max surface temperature, $\text{°T } \text{°C}$ (for full average power)	50
Physical length, mm	230

RF Load (Ferrite)

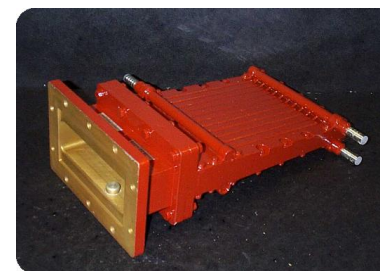

Type	WFHL 3-1	WFHL 3-5
Peak input power, MW	2.0	5.0
Average power, kW	10	100
Min return loss at 1.3 GHz, dB	32±40	32±40
Max VSWR at 1.3 GHz	<1.05	<1.05
Max surface temperature, $\Delta T \text{ °C}$ (for full average power)	20	30
Physical length, mm	385	850



RF Waveguide Distribution Status

- New high power waveguide components for 1.3GHz have been developed in cooperation with industry or are standard of the shelves components
- Operation experience of 10 years from TTF
- Development of integrated components has been started (e.g. circulator with integrated load) to allow faster and more reliable installation